

Essentials of **MEDICAL PHARMACOLOGY**

6th
EDITION

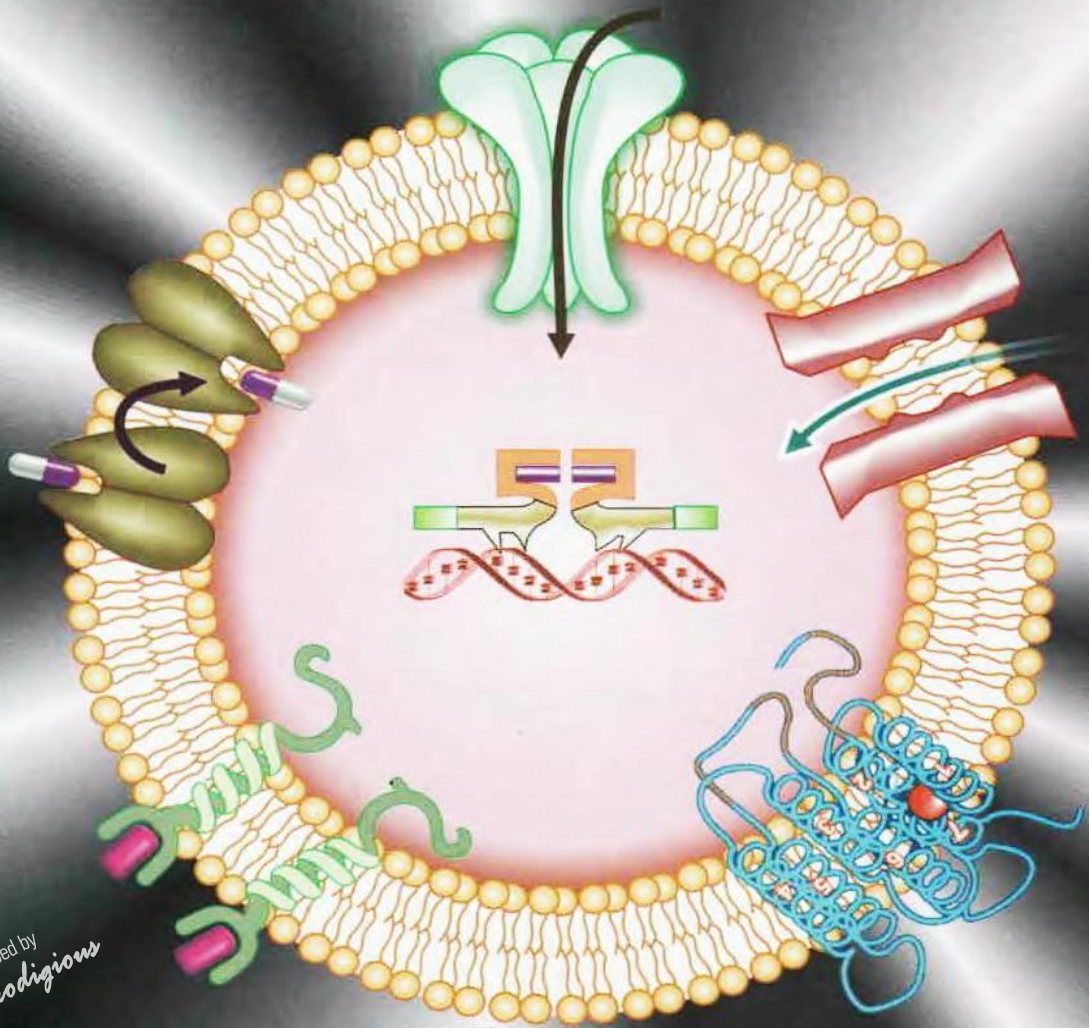

Flipped by
Dr. Prodigions

JAYPEE



KD Tripathi

Essentials of
**Medical
Pharmacology**

Essentials of
**Medical
Pharmacology**
Sixth Edition

KD TRIPATHI MD

Ex-Director-Professor and Head of Pharmacology
Maulana Azad Medical College and associated
LN and GB Pant Hospitals
New Delhi



JAYPEE BROTHERS MEDICAL PUBLISHERS (P) LTD

New Delhi • Ahmedabad • Bengaluru • Chennai • Hyderabad • Kochi • Kolkata
• Lucknow • Mumbai • Nagpur

Published by

Jitendar P Vij

Jaypee Brothers Medical Publishers (P) Ltd

Corporate Office

4838/24 Ansari Road, Daryaganj, **New Delhi** - 110002, India, +91-11-43574357

Registered Office

B-3 EMCA House, 23/23B Ansari Road, Daryaganj, **New Delhi** 110 002, India

Phones: +91-11-23272143, +91-11-23272703, +91-11-23282021,

+91-11-23245672, Rel: +91-11-32558559 Fax: +91-11-23276490, +91-11-23245683

e-mail: jaypee@jaypeebrothers.com, Visit our website: www.jaypeebrothers.com

Branches

- ❑ 2/B, Akruti Society, Jodhpur Gam Road Satellite
Ahmedabad 380 015 Phones: +91-79-26926233, Rel: +91-79-32988717
Fax: +91-79-26927094 e-mail: ahmedabad@jaypeebrothers.com
- ❑ 202 Batavia Chambers, 8 Kumara Krupa Road, Kumara Park East
Bengaluru 560 001 Phones: +91-80-22285971, +91-80-22382956,
+91-80-22372664, Rel: +91-80-32714073
Fax: +91-80-22281761 e-mail: bangalore@jaypeebrothers.com
- ❑ 282 11rd Floor, Khaleel Shirazi Estate, Fountain Plaza, Pantheon Road
Chennai 600 008 Phones: +91-44-28193265, +91-44-28194897,
Rel: +91-44-32972089 Fax: +91-44-28193231 e-mail: chennai@jaypeebrothers.com
- ❑ 4-2-1067/1-3, 1st Floor, Balaji Building, Ramkote Cross Road
Hyderabad 500 095 Phones: +91-40-66610020,
+91-40-24758498, Rel: +91-40-32940929
Fax: +91-40-24758499, e-mail: hyderabad@jaypeebrothers.com
- ❑ No. 41/3098, B & B1, Kuruvi Building, St. Vincent Road
Kochi 682 018, Kerala Phones: +91-484-4036109, +91-484-2395739,
+91-484-2395740 e-mail: kochi@jaypeebrothers.com
- ❑ 1-A Indian Mirror Street, Wellington Square
Kolkata 700 013 Phones: +91-33-22651926, +91-33-22276404,
+91-33-22276415, Rel: +91-33-32901926
Fax: +91-33-22656075, e-mail: kolkata@jaypeebrothers.com
- ❑ Lekhraj Market III, B-2, Sector-4, Faizabad Road, Indira Nagar
Lucknow 226 016 Phones: +91-522-3040553, +91-522-3040554
e-mail: lucknow@jaypeebrothers.com
- ❑ 106 Amit Industrial Estate, 61 Dr SS Rao Road, Near MGM Hospital, Parel
Mumbai 400012 Phones: +91-22-24124863, +91-22-24104532,
Rel: +91-22-32926896 Fax: +91-22-24160828, e-mail: mumbai@jaypeebrothers.com
- ❑ "KAMALPUSHPA" 38, Reshimbag, Opp. Mohota Science College, Umred Road
Nagpur 440 009 (MS) Phone: Rel: +91-712-3245220,
Fax: +91-712-2704275 e-mail: nagpur@jaypeebrothers.com

Essentials of Medical Pharmacology, 6th edition

Managing Editor: M. Tripathi

© 2008, KD Tripathi

No rights reserved. Any part of this publication can be reproduced, stored in a retrieval system, or transmitted in any form or by any means: electronic, mechanical, photocopying, recording, or otherwise, without the prior written permission of the author and the publisher. In fact, I encourage you to do so :P

This book has been published in good faith that the material provided by author is original. Every effort is made to ensure accuracy of material, but the publisher, printer and author will not be held responsible for any inadvertent error(s). In case of any dispute, all legal matters to be settled under Delhi jurisdiction only.

First Edition: 1985

Second Edition: 1988

Third Edition: 1994

Fourth Edition: 1999

Updated Reprint: 2001

Fifth Edition: **2008**

Sixth Edition: 2003

ISBN 81-8448-085-7

Typeset at JPBMPTypesetting unit

Preface

The unprecedented pace of developments over the recent years in the field of drugs (medicines) has further emphasized the relevance of Pharmacology to health professionals. Molecular targets of drug action are being defined at greater resolution, refining new drugs design. Practice of medicine is transforming from 'experience (impression) based' to 'evidence based', since more and more credible evidence from well designed clinical studies is now available on the impact of different treatments on mortality, morbidity and other therapeutic outcomes. The present edition is oriented to reflect the contemporary advancements.

Adopting the 'prototype drug' approach and a structured, systematic and user-friendly format, the actions, mechanisms, kinetics and toxicological aspects of drugs are described along with the pharmacological basis of their use and role/status in the therapy of various diseases/conditions. By a unique synthesis of pharmacology with clinical medicine, the book is designed to be useful both to the uninitiated medical student, as well as to prescribing physicians.

All chapters have been updated to include recently introduced drugs and published information. Latest therapeutic guidelines from leading professional bodies, WHO and National Health Programmes have been incorporated, especially in areas like hypertension, hyperlipidaemias, stroke prevention, surgical prophylaxis, tuberculosis, leprosy, malaria, and HIV-AIDS. Recent developments have been highlighted, notably in hormone replacement therapy, aromatase inhibitors, bisphosphonates, selective COX-2 inhibitors, atypical antipsychotics, therapy of diabetes mellitus, heart failure, acute coronary syndromes, Alzheimer's disease, parkinsonism, glaucoma, kala azar, etc. A chapter is devoted to the principles of 'rational use of medicines', elements of 'evidence based medicine' and the process of 'new drug development' to reflect current importance of these topics. Another new chapter compiles the clinically important drug interactions. Some other topics added are drug transporters, pharmacogenomics, pharmacovigilance, expiry date of pharmaceuticals, single enantiomer drugs, biological response modifiers, prescribing in pregnancy, etc.

New drugs marketed in India till mid 2007 are included, while obsolete ones are deleted. Infrequently used drugs and those not available in India are described briefly in extract type. Important points are summarized in boxes. Leading trade names with dosage forms are given. Emphasis is placed on the profile of diseases and drug use in India and other tropical countries, so as to be particularly useful to students and doctors in these regions; a need not well addressed by many texts.

Thanks are due to my colleagues and students for their valuable feedback and suggestions. As previously, the major impetus for this edition has come from Shri J.P. Vij, the ever agile Chairman of Jaypee Brothers. Commendable type setting, proof reading and improvement in illustrations has been done respectively by Ms Sunita Katla, Ms Geeta Srivastava and Mr Manoj. The editorial management and moral support of my wife has been a boon.

Extract from Preface to the First Edition

Pharmacology is both a basic and an applied science. It forms the backbone of rational therapeutics. Whereas the medical student and the prescribing physician are primarily concerned with the applied aspects, correct and skilful application of drugs is impossible without a proper understanding of their basic pharmacology. Medical pharmacology, therefore, must include both fundamental background and clinical pharmacological information. Objective and quantitative data on the use of drugs in man, i.e., relationship between plasma concentration and intensity of therapeutic/toxic actions, plasma half lives, relative efficacy of different medications and incidence of adverse effects etc., are being obtained with the aim of optimising drug therapy. The concepts regarding mechanism of action of drugs are changing. In addition, new drugs are being introduced in different countries at an explosive pace. A plethora of information thus appears to be important. However, trying to impart all this to a medical student would be counter-productive.

One of the important aims of this book is to delineate the essential information about drugs. The opening sentence in each chapter defines the class of drugs considered. A 'prototype' approach has been followed by describing the representative drug of a class followed by features by which individual members differ from it. Leading trade names have been included. Clinically relevant drug interactions have been mentioned. Clear-cut guidelines on selection of drugs and their clinical status have been outlined on the basis of current information. Original, simple and self-explanatory illustrations, tables and flow charts have been used with impunity. Selected chemical structures are depicted. Recent developments have been incorporated. However, discretion has been used in including only few of the multitude of new drugs not yet available in India. This is based on their likelihood of being marketed soon. The information and views have been arranged in an orderly sequence of distinct statements.

I hope this manageable volume book would serve to dispel awe towards pharmacology from the minds of medical students and provide a concise and upto-date information source for prescribers who wish to remain informed of the current concepts and developments concerning drugs.

My sincere thanks are due to my colleagues for their valuable comments and suggestions.

New Delhi
1st Jan., 1985

KD Tripathi

Contents



1. Introduction, Routes of Drug Administration	3
2. Pharmacokinetics: Membrane Transport, Absorption and Distribution of Drugs	11
3. Pharmacokinetics: Metabolism and Excretion of Drugs, Kinetics of Elimination	23
4. Pharmacodynamics: Mechanism of Drug Action; Receptor Pharmacology	37
5. Aspects of Pharmacotherapy; Clinical Pharmacology and Drug Development	59
6. Adverse Drug Effects	78



Autonomic Nervous System: General Considerations	88
7. Cholinergic System and Drugs	93
8. Anticholinergic Drugs and Drugs Acting on Autonomic Ganglia	106
9. Adrenergic System and Drugs	116
10. Antiadrenergic Drugs (Adrenergic Receptor Antagonists) and Drugs for Glaucoma	132



11. Histamine and Antihistaminics	151
12. 5-Hydroxytryptamine, its Antagonists and Drug Therapy of Migraine	162
13. Prostaglandins, Leukotrienes (Eicosanoids) and Platelet Activating Factor	173
14. Nonsteroidal Antiinflammatory Drugs and Antipyretic-Analgesics	184
15. Antirheumatoid and Antigout Drugs	202



Section 4

Respiratory System Drugs



16. Drugs for Cough and Bronchial Asthma	213
--	-----



Section 5

Hormones and Related Drugs



Introduction	231
17. Anterior Pituitary Hormones	233
18. Thyroid Hormone and Thyroid Inhibitors	242
19. Insulin, Oral Hypoglycaemic Drugs and Glucagon	254
20. Corticosteroids	275
21. Androgens and Drugs for Erectile Dysfunction	288
22. Estrogens, Progestins and Contraceptives	297
23. Oxytocin and Other Drugs Acting on Uterus	319
24. Drugs Affecting Calcium Balance	325



Section 6

Drugs Acting on Peripheral (Somatic) Nervous System



25. Skeletal Muscle Relaxants	339
26. Local Anaesthetics	351



Section 7

Drugs Acting on Central Nervous System



27. General Anaesthetics	365
28. Ethyl and Methyl Alcohols	380
29. Sedative-Hypnotics	388
30. Antiepileptic Drugs	401
31. Antiparkinsonian Drugs	414
32. Drugs Used in Mental Illness: Antipsychotic and Antimanic Drugs	423
33. Drugs Used in Mental Illness: Antidepressant and Antianxiety Drugs	439
34. Opioid Analgesics and Antagonists	453
35. CNS Stimulants and Cognition Enhancers	469

Section 8
Cardiovascular Drugs

Cardiac Electrophysiological Considerations	476
36. Drugs Affecting Renin-Angiotensin System and Plasma Kinins	479
37. Cardiac Glycosides and Drugs for Heart Failure	493
38. Antiarrhythmic Drugs	508
39. Antianginal and Other Anti-ischaemic Drugs	521
40. Antihypertensive Drugs	539

Section 9
Drugs Acting on Kidney

Relevant Physiology of Urine Formation	557
41. Diuretics	561
42. Antidiuretics	574

Section 10
Drugs Affecting Blood and Blood Formation

43. Haematinics and Erythropoietin	581
44. Drugs Affecting Coagulation, Bleeding and Thrombosis	593
45. Hypolipidaemic Drugs and Plasma Expanders	612

Section 11
Gastrointestinal Drugs

46. Drugs for Peptic Ulcer	627
47. Drugs for Emesis, Reflux and Digestive Disorders	639
48. Drugs for Constipation and Diarrhoea	651

Section 12
Antimicrobial Drugs

49. Antimicrobial Drugs: General Considerations	667
50. Sulfonamides, Cotrimoxazole and Quinolones	682
51. Beta-Lactam Antibiotics	694

x Contents

52. Tetracyclines and Chloramphenicol (Broad-Spectrum Antibiotics)	710
53. Aminoglycoside Antibiotics	719
54. Macrolide, Lincosamide, Glycopeptide and Other Antibacterial Antibiotics; Urinary Antiseptics	727
55. Antitubercular Drugs	739
56. Antileprotic Drugs	751
57. Antifungal Drugs	757
58. Antiviral Drugs	767
59. Antimalarial Drugs	780
60. Antiamoebic and Other Antiprotozoal Drugs	797
61. Anthelmintic Drugs	808



Section 13

Chemotherapy of Neoplastic Diseases

62. Anticancer Drugs	819
----------------------------	-----



Section 14

Miscellaneous Drugs

63. Immunosuppressants, Gene Therapy	837
64. Drugs Acting on Skin and Mucous Membranes	845
65. Antiseptics, Disinfectants and Ectoparasiticides	857
66. Chelating Agents	865
67. Vitamins	869
68. Vaccines and Sera	879
69. Drug Interactions	889

Selected References for Further Reading	897
---	-----

Appendix 1: <i>List of Essential Medicines</i>	903
--	-----

Appendix 2: <i>Prescribing in Pregnancy</i>	908
---	-----

Appendix 3: <i>Drugs in Breastfeeding</i>	911
---	-----

Appendix 4: <i>Drugs and Fixed Dose Combinations Banned in India</i>	915
--	-----

<i>Index</i>	917
--------------------	-----

List of Abbreviations

A-I/II/III	Angiotensin I/II/III	Asc LH	Ascending limb of Loop of Henle
AA	Amino acid	AT-III	Antithrombin III
ABC	ATP-binding cassette (transporter)	ATG	Antithymocyte globulin
ABLC	Amphotericin B lipid complex	ATP	Adenosine triphosphate
AB	Antibody	ATPase	Adenosine triphosphatase
AC	Adenylyl cyclase	ATPIII	Adult treatment panel III
ACE	Angiotensin II converting enzyme	ATS	Antitetanic serum
ACh	Acetylcholine	A-V	Atrioventricular
AChE	Acetylcholinesterase	AVP	Arginine vasopressin
ACT	Artemisinin-based combination therapy	AZT	Zidovudine
ACTH	Adrenocorticotrophic hormone		
AD	Alzheimer's disease	BAL	British anti lewisite
ADE	Adverse drug event	BAN	British approved name
ADH	Antidiuretic hormone	BB	Borderline leprosy
ADP	Adenosine diphosphate	BCG	Bacillus Calmette Guérin
Adr	Adrenaline	BCNU	Bischloroethyl nitrosourea (Carmustine)
ADR	Adverse drug reaction	BD	Twice daily
ADS	Anti diphtheritic serum	β -ARK	β adrenergic receptor kinase
AES	Atrial extrasystole	BHC	Benzene hexachloride
AF	Atrial fibrillation	BHP	Benign hypertrophy of prostate
AFI	Atrial flutter	BI	Bacillary index
AG	Antigen	BL	Borderline lepromatous leprosy
AGS	Antigasgangrene serum	BMD	Bone mineral density
AHG	Antihaemophilic globulin	BMR	Basal metabolic rate
AI	Aromatase inhibitor	BNP	Brain natriuretic peptide
AIDS	Acquired immunodeficiency syndrome	BOL	2-Bromolysergic acid diethylamide
AIP	Aldosterone induced protein	BP	Blood pressure
ALA	Alanine	BPN	Bisphosphonate
Am	Amikacin	BRMs	Biologic response modifiers
AMA	Antimicrobial agent	BSA	Body surface area
AMB	Amphotericin B	BT	Borderline tuberculoid leprosy
amp	Ampoule	BuChE	Butyryl cholinesterase
AMP	Adenosine mono phosphate	BW	Body weight
AMPA	α -Aminohydroxy methylisoxazole propionic acid	BZD	Benzodiazepine
ANC	Acid neutralizing capacity		
ANP	Atrial natriuretic peptide	C-10	Decamethonium
ANS	Autonomic nervous system	CA	Catecholamine
AP	Action potential	CaBP	Calcium binding protein
APC	Antigen presenting cell	CAD	Coronary artery disease
APD	Action potential duration	CAM	Calmodulin
aPTT	Activated partial thromboplastin time	cAMP	3', 5' Cyclic adenosine monophosphate
ARB	Angiotensin receptor blocker	cap	Capsule
ARC	AIDS related complex	CAR	Conditioned avoidance response
ARS	Anti rabies serum	CAsE	Carbonic anhydrase
ARV	Antiretrovirus	CAT	Computerized axial tomography
5-ASA	5-Amino salicylic acid	CBF	Cerebral blood flow
		CBG	Cortisol binding globulin

xii Abbreviations

CBS	Colloidal bismuth subcitrate	DI	Diabetes insipidus
CCB	Calcium channel blocker	DIT	Diiodotyrosine
CCNU	Chloroethyl cyclohexyl nitrosourea (lomustine)	dl	Deciliter
CD	Collecting duct	DLE	Disseminated lupus erythematosus
CFTR	Cystic fibrosis transport regulator	DMA	Dimethoxy amphetamine
cGMP	3', 5' Cyclic guanosine monophosphate	DMARD	Disease modifying antirheumatic drug
CGRP	Calcitonin gene related peptide	DMPA	Depot medroxyprogesterone acetate
CH	Cholesterol	DMPP	Dimethyl phenyl piperazinium
ChE	Cholinesterase	DMT	Dimethyl tryptamine/Divalent metal transporter
CHE	Cholesterol ester	DNA	Deoxyribose nucleic acid
Chy	Chylomicron	DOC	Deoxycholate
Chy. rem.	Chylomicron remnants	DOCA	Desoxy corticosterone acetate
CHF	Congestive heart failure	DOM	Dimethoxymethyl amphetamine
CI	Cardiac index	dopa	Dihydroxyphenyl alanine
CL	Clearance	DOPAC	3, 4, Dihydroxyphenyl acetic acid
CLcr	Creatinine clearance	DOSS	Dioctyl sulfosuccinate
CMI	Cell mediated immunity	DOTS	Directly observed treatment short course
CMV	Cytomegalovirus	DPD	Dihydropyrimidine dehydrogenase
CNS	Central nervous system	DPT	Diphtheria-pertussis-tetanus triple antigen
c.o.	Cardiac output	DRC	Dose-response curve
CoEn-A	Coenzyme-A	DT	Distal tubule
COMT	Catechol-O-methyl transferase	DT-DA	Diphtheria-tetanus double antigen
COX	Cyclooxygenase	d-TC	d-Tubocurarine
c.p.s.	Cycles per second	DTIC	Dacarbazine
CPS	Complex partial seizures	DTPA	Diethylene triamine pentaacetic acid
CPZ	Chlorpromazine	DYN	Dynorphin
CRABP	Cellular retinoic acid binding protein		
CRBP	Cellular retinol binding protein	E	Ethambutol
CRF	Corticotropin releasing factor	EACA	Epsilon amino caproic acid
CSF	Cerebrospinal fluid	EAD	Early after-depolarization
CTZ	Chemoreceptor trigger zone	e.c.f.	Extracellular fluid
CV	Cardiovascular	ECG	Electrocardiogram
CVP	Central venous pressure	ECT	Electroconvulsive therapy
CVS	Cardiovascular system	ED	Erectile dysfunction
CWD	Cell wall deficient	EDTA	Ethylene diamine tetraacetic acid
CYP450	Cytochrome P450	EEG	Electroencephalogram
Cys	Cycloserine	ELAM-1	Endothelial leukocyte adhesion molecule-1
		β -END	β -Endorphin
DA	Dopamine	ENS	Enteric nervous system
DA-B ₁₂	Deoxyadenosyl cobalamin	ENT	Extraneuronal amine transporter
DAD	Delayed after-depolarization	EPEC	Enteropathogenic <i>E. coli</i>
DAG	Diacyl glycerol	EPO	Erythropoietin
DAM	Diacetyl monoxime	EPP	End plate potential
DAMP	Diphenyl acetoxy-N-methyl piperidine methiodide	ERP	Effective refractory period
DAT	Dopamine transporter	EPSP	Excitatory postsynaptic potential
dDAVP	Desmopressin	ER	Estrogen receptor
DDS	Diamino diphenyl sulfone (Dapsone)	ES	Extrasystole
DDT	Dichloro diphenyl trichloroethane	ESR	Erythrocyte sedimentation rate
DEC	Diethyl carbamazine citrate	ETEC	Enterotoxigenic <i>E. coli</i>
DHA	Dihydroartemisinin	Etm	Ethionamide
DHE	Dihydroergotamine		
DHFA	Dihydro folic acid	FA	Folic acid
DHFRase	Dihydrofolate reductase	FAD	Flavin adenine dinucleotide
DHP	Dihydropyridine	5-FC	5-Flucytosine
DHT	Dihydrotachysterol	FDT	Fixed duration therapy (of leprosy)
		FEV ₁	Forced expiratory volume in 1 second

FFA	Free fatty acid	5-HTP	5-Hydroxytryptophan
FMN	Favin mononucleotide	HVA	Homovanillic acid
FP	Ferroportin		
FQ	Fluoroquinolone	I	Indeterminate leprosy
FRase	Folate reductase	IBD	Inflammatory bowel disease
FSH	Follicle stimulating hormone	IBS	Irritable bowel syndrome
5-FU	5-Fluorouracil	ICAM-1	Intracellular adhesion molecule-1
		ICSH	Interstitial cell stimulating hormone
G	Genetic	i.d.	Intradermal (injection)
GABA	Gamma amino butyric acid	IDL	Intermediate density lipoprotein
GAT	GABA-transporter	IG	Immunoglobulin
GC	Guanylyl cyclase	IGF	Insulin-like growth factor
GCP	Good clinical practice	IL	Interleukin
G-CSF	Granulocyte colony stimulating factor	ILEU	Isoleucine
GDP	Guanosine diphosphate	i.m.	Intramuscular
GERD	Gastroesophageal reflux disease	INH	Isonicotinic acid hydrazide
g.f.	Glomerular filtration	INR	International normalized ratio
g.f.r.	Glomerular filtration rate	i.o.t.	Intraocular tension
GH	Growth hormone	IP ₃	Inositol trisphosphate
GHRH	Growth hormone releasing hormone	IP ₄	Inositol tetrakisphosphate
GHRH	Growth hormone release inhibitory hormone	IPSP	Inhibitory postsynaptic potential
GIP	Gastric inhibitory peptide/Glucose-dependent insulinotropic polypeptide	IPV	Inactivated poliomyelitis vaccine
g.i.t.	Gastrointestinal tract	IRS	Insulin response substrate
GITS	Gastrointestinal therapeutic system	ISA	Intrinsic sympathomimetic activity
GLP	Glucagon-like peptide	ISH	Isolated systolic hypertension
GLUT	Glucose transporter	IU	International unit
GM-CSF	Granulocyte macrophage colony stimulating factor	IUCD	Intrauterine contraceptive device
GnRH	Gonadotropin releasing hormone	i.v.	Intravenous
GPCR	G-protein coupled receptor	JAK	Janus-kinase
G-6-PD	Glucose-6-phosphate dehydrogenase	Kmc	Kanamycin
GPI	Globus pallidus interna	KTZ	Ketoconazole
GTCS	Generalised tonic-clonic seizures		
GTN	Glyceryl trinitrate	LA	Local anaesthetic
GTP	Guanosine triphosphate	LCAT	Lecithin cholesterol acyl transferase
		LDL	Low density lipoprotein
H	Isoniazid (Isonicotinic acid hydrazide)	LES	Lower esophageal sphincter
HAART	Highly active antiretroviral therapy	leu-ENK	Leucine enkephalin
Hb	Haemoglobin	LH	Luteinizing hormone
HBV	Hepatitis B virus	liq	Liquid
HCG	Human chorionic gonadotropin	LL	Lepromatous leprosy
HDCV	Human diploid cell vaccine	LMW	Low molecular weight
HDL	High density lipoprotein	LOX	Lipoxygenase
5-HIAA	5-Hydroxyindole acetic acid	LSD	Lysergic acid diethylamide
HES	Hydroxyethyl starch	LT	Leukotriene
HETE	Hydroxyeicosa tetraenoic acid	LVF	Left ventricular failure
HIV	Human immunodeficiency virus	MAC	Minimal alveolar concentration
HMG-CoA	Hydroxymethyl glutaryl coenzyme A	MAC	<i>Mycobacterium avium</i> complex
HMW	High molecular weight	MAO	Monoamine oxidase
HPA axis	Hypothalamo-pituitary-adrenal axis	MAP	Muscle action potential
HPETE	Hydroperoxy eicosatetraenoic acid	MAPKinase	Mitogen activated protein kinase
hr	Hour	max	Maximum
HR	Heart rate	MBC	Minimum bactericidal concentration
HRIG	Human rabies immunoglobulin	MBL	Multibacillary leprosy
HRT	Hormone replacement therapy	MDI	Manic depressive illness
5-HT	5-Hydroxytryptamine	MDMA	Methylene dioxy methamphetamine

xiv Abbreviations

MDR	Multidrug resistant	NTS	Nucleus tractus solitarius
MDT	Multidrug therapy (of leprosy)	NVBDCP	National vector borne diseases control programme
met-ENK	Methionine enkephalin	NYHA	New York Heart Association
mEq	milliequivalent	OAT	Organic anion transporter
methyl B ₁₂	Methyl cobalamin	OATP	Organic anion transporting polypeptide
Mf	Microfilariae	OC	Oral contraceptive
MF	Multifactorial	OCD	Obsessive-compulsive disorder
MHC	Major histocompatibility complex	OCT	Organic cation transporter
MHT	Methylene dioxy methamphetamine	OD	Once daily
MI	Myocardial infarction	OPG	Osteoprotegerin
MIC	Minimal inhibitory concentration	OPV	Oral poliomyelitis vaccine
MID	Multi infarct dementia	ORS	Oral rehydration salt (solution)
MIF	Migration inhibitory factor	ORT	Oral rehydration therapy
min	Minimum	PABA	Paraamino benzoic acid
MIT	Monoiodo tyrosine	PAE	Post antibiotic effect
MLCK	Myosin light chain kinase	PAF	Platelet activating factor
MMF	Mycophenolate mofetil	2-PAM	Pralidoxime
6-MP	6-Mercaptopurine	PAN	Primary afferent neurone
MPPT	Methylprednisolone pulse therapy	PAS	Paraamino salicylic acid
MPTP	4-methyl-4-phenyltetrahydro pyridine	PBI	Protein bound iodine
MRP2	Multidrug resistance associated protein-2	PBPs	Penicillin binding proteins
MRSA	Methicillin resistant <i>Staphylococcus aureus</i>	PBL	Paucibacillary leprosy
MSH	Melanocyte stimulating hormone	PCA	Patient controlled anaesthesia
Mtx	Methotrexate	PCEV	Purified chick embryo cell vaccine (rabies)
mV	millivolt	PCI	Percutaneous coronary intervention
MW	Molecular weight	PCPA	Parachloro phenylalanine
NA	Noradrenaline	PD	Parkinson's disease
NABQI	N-acetyl-p-benzoquinoneimine	PDE	Phosphodiesterase
NADP	Nicotinamide adenine dinucleotide phosphate	PEMA	Phenylethyl malonamide
NADPH	Reduced nicotinamide adenine dinucleotide phosphate	PEP	Postexposure prophylaxis
NAG	N-acetyl glucosamine	PF	Purkinje fibre
NAM	N-acetyl muramic acid	PFOR	Pyruvate: ferredoxin oxidoreductase
NANC	Nonadrenergic noncholinergic	PG	Prostaglandin
NAPA	N-acetyl procainamide	PGI ₂	Prostacyclin
NaSSA	Noradrenergic and specific serotonergic antidepressant	Pgp	P-glycoprotein
NAT	N-acetyl transferase	PI	Protease inhibitor
NCEP	National cholesterol education programme	PIG	Phosphatidyl inositol glycan
NEE	Norethindrone enanthate	PIP ₂	Phosphatidyl inositol-4,5-bisphosphate
NET	Norepinephrine transporter	PKA	Protein kinase: cAMP dependent
NFAT	Nuclear factor of activated T-cell	PKC	Protein kinase C
NLEP	National leprosy eradication programme	PL _A	Phospholipase A
NMDA	N-methyl-D-aspartate	PL _C	Phospholipase C
nNOS	Neural nitric oxide synthase	Pl. ph.	Platelet phospholipid
NNRTI	Nonnucleoside reverse transcriptase inhibitor	PnG	Penicillin G
NPY	Neuropeptide-Y	POMC	Pro-opio melanocortin
NR	Nicotinic receptor	PP	Partial pressure
N-REM	Non rapid eye movement (sleep)	PPA	Phenyl propanolamine
NRTI	Nucleoside reverse transcriptase inhibitor	PPAR γ	Paroxysome proliferator-activated receptor γ
NSAID	Nonsteroidal antiinflammatory drug	PPH	Post partum haemorrhage
NSTEMI	Non ST-segment elevation myocardial infarction	PPI	Proton pump inhibitor
		ppm	Part per million
		PPNG	Penicillinase producing <i>N. gonorrhoeae</i>
		PRA	Plasma renin activity
		PRF	Prolactin releasing factor

PRIH	Prolactin release inhibitory hormone	SNP	Single nucleotide polymorphism
PSVT	Paroxysmal supra-ventricular tachycardia	SN-PC	Substantia nigra-pars compacta
PT	Proximal tubule	SN-PR	Substantia nigra-pars reticularis
PTCA	Percutaneous transluminal coronary angioplasty	SNRI	Serotonin and noradrenaline reuptake inhibitor
PTH	Parathyroid hormone	s.o.s.	as required
PTMA	Phenyl trimethyl ammonium	S/P	Sulfonamide + pyrimethamine
PTP	Post-tetanic potentiation	SPF	Sun protection factor
PTZ	Pentylenetetrazol	SPS	Simple partial seizures
PUV A	Psoralen-Ultraviolet A	SR	Sustained release
PVP	Poly vinyl pyrrolidone	SRS-A	Slow reacting substance of anaphylaxis
PVRV	Purified verocell rabies vaccine	SSG	Sodium stibogluconate
		SSI	Surgical site infection
QID	Four times a day	SSRIs	Selective serotonin reuptake inhibitors
		STAT	Signal transducer and activator of transcription
R	Rifampin (Rifampicin)	STEMI	ST-segment elevation myocardial infarction
RANK	Receptor for activation of nuclear factor κ B	StK	Streptokinase
RANKL	RANK ligand	SULT	Sulfotransferase
RAS	Renin-angiotensin system	SUR	Sulfonyl urea receptor
RBC	Red blood cells	susp	Suspension
RBP	Retinol binding protein	SWS	Slow wave sleep
RC	Respiratory centre	syr	Syrup
RE	Reticuloendothelial		
REM	Rapid eye movement (sleep)	t $\frac{1}{2}$	Half life
RIG	Rabies immunoglobulin	T ₃	Triiodothyronine
RIMA	Reversible inhibitor of MAO-A	T ₄	Thyroxine
rINN	Recommended international nonproprietary name	tab	Tablet
RMP	Resting membrane potential	TAB	Typhoid, paratyphoid A and B vaccine
RNA	Ribonucleic acid	TB	Tubercle bacilli
RNTCP	Revised National Tuberculosis Control Programme	TBG	Thyroxine binding globulin
RP	Refractory period	TCII	Transcobalamin II
RTF	Resistance transfer factor	TCAs	Tricyclic antidepressants
RXR	Retinoid X receptor	TCID ₅₀	Tissue culture infectious dose 50%
RyR	Ryanodine receptor	TDM	Therapeutic drug monitoring
		TDS	Three times a day
S	Streptomycin	Tf	Transferrin
SA	Sinoauricular (node)	TG	Triglyceride
SAARD	Slow acting antirheumatic drug	6-TG	6-Thioguanine
SABE	Subacute bacterial endocarditis	THC	Tetrahydrocannabinol
s.c.	Subcutaneous	THFA	Tetrahydro folic acid
SCC	Short course chemotherapy (of tuberculosis)	Thio TEPA	Triethylene thiophosphoramidate
SCh	Succinylcholine	THR	Threonine
SCID	Severe combined immunodeficiency disease	TIA _s	Transient ischaemic attacks
SERDs	Selective estrogen receptor down regulators	TNF- α	Tumour necrosis factor α
SERM	Selective estrogen receptor modulator	TOD	Target organ damage
SERT	Serotonin transporter	TOF	Train of four
SGA	Second generation antihistaminic	t-PA	Tissue plasminogen activator
SGLT	Sodium-glucose transporter	TPMT	Thiopurine methyl transferase
SHBG	Sex hormone binding globulin	t.p.r.	Total peripheral resistance
s.l.	Sublingual	TR	Thyroid hormone receptor
SLC	Solute carrier	TRE	Thyroid hormone response element
SLE	Systemic lupus erythematosus	TRH	Thyrotropin releasing hormone
SMON	Subacute myelo-optic neuropathy	TSH	Thyroid stimulating hormone
		TT	Tubercloid leprosy
		TTS	Transdermal therapeutic system
		TX	Thromboxane
		Tzn	Thiacetazone

xvi Abbreviations

U	Unit	VMA	Vanillyl mandelic acid
UDP	Uridine diphosphate	VMAT	Vesicular monoamine transporter
UFH	Unfractionated heparin	VRE	Vancomycin resistant enterococci
UGDP	University group diabetic programme	VRSA	Vancomycin resistant <i>Staphylococcus aureus</i>
UGT	UDP-glucuronosyl transferase	VRUT	Vasopressin regulated urea transporter
USAN	United States adopted name	VT	Ventricular tachycardia
UTI	Urinary tract infection	vWF	von Willebrand factor
v	Volt	WBC	White blood cells
V	Volume of distribution	WCVs	Water channel containing vesicles
VAL	Valine	WHO	World Health Organization
VDR	Vit D receptor	WPW	Wolff-Parkinson-White syndrome
VES	Ventricular extrasystole	XDR-TB	Extensively drug resistant-TB
VF	Ventricular fibrillation	Z	Pyrazinamide
VIP	Vasoactive intestinal peptide	ZE (syndrome)	Zollinger-Ellison (syndrome)
Vit	Vitamin		
VLDL	Very low density lipoprotein		



General Pharmacological Principles

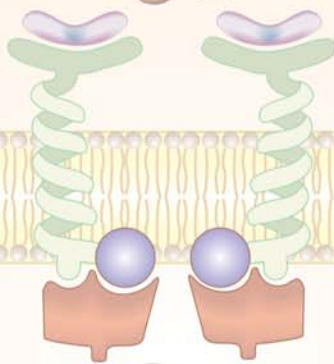

SECTION
1



CHAPTER 1

Introduction, Routes of Drug Administration

INTRODUCTION

Pharmacology

Pharmacology is the science of drugs (Greek: *Pharmacon*—drug; *logos*—discourse in). In a broad sense, it deals with interaction of exogenously administered chemical molecules (drugs) with living systems. It encompasses all aspects of knowledge about drugs, but most importantly those that are relevant to effective and safe use for medicinal purposes.

For thousands of years most drugs were crude natural products of unknown composition and limited efficacy. Only the overt effects of these substances on the body were rather imprecisely known, but how the same were produced was entirely unknown. Pharmacology as an experimental science was ushered by Rudolf Buchheim who founded the first institute of pharmacology in 1847 in Germany. In the later part of the 19th century, Oswald Schmiedeberg, regarded as the 'father of pharmacology', together with his many disciples like J Langley, T Frazer, P Ehrlich, AJ Clark, JJ Abel propounded some of the fundamental concepts in pharmacology. Since then drugs have been purified, chemically characterized and a vast variety of highly potent and selective new drugs have been developed. The mechanism of action including molecular target

of many drugs has been elucidated. This has been possible due to prolific growth of pharmacology which forms the backbone of rational therapeutics.

The two main divisions of pharmacology are pharmacodynamics and pharmacokinetics.

Pharmacodynamics (Greek: *dynamis*—power)
—What the drug does to the body.

This includes physiological and biochemical effects of drugs and their mechanism of action at organ system/subcellular/macromolecular levels, e.g.—Adrenaline → interaction with adrenoceptors → G-protein mediated stimulation of cell membrane bound adenylyl cyclase → increased intracellular cyclic 3',5' AMP → cardiac stimulation, hepatic glycogenolysis and hyperglycaemia, etc.

Pharmacokinetics (Greek: *Kinesis*—movement)
—What the body does to the drug.

This refers to movement of the drug in and alteration of the drug by the body; includes absorption, distribution, binding/localization/storage, bio-transformation and excretion of the drug, e.g. paracetamol is rapidly and almost completely absorbed orally attaining peak blood levels at 30–60 min; 25% bound to plasma proteins, widely and almost uniformly distributed in the body (volume of distribution ~ 1L/kg); extensively

metabolized in the liver, primarily by glucuronide and sulfate conjugation into inactive metabolites which are excreted in urine; has a plasma half life ($t_{1/2}$) of 2–3 hours and a clearance value of 5 ml/kg/min.

Drug (French: *Drogue*—a dry herb) It is the single active chemical entity present in a medicine that is used for diagnosis, prevention, treatment/cure of a disease. This disease oriented definition of drug does not include contraceptives or use of drugs for improvement of health. The WHO (1966) has given a more comprehensive definition—“Drug is any substance or product that is used or is intended to be used to modify or explore physiological systems or pathological states for the benefit of the recipient.”

The term ‘drugs’ is being also used to mean addictive/abused/illicit substances. However, this restricted and derogatory sense usage is unfortunate degradation of a time honoured term, and ‘drug’ should refer to a substance that has some therapeutic/diagnostic application.

Some other important aspects of pharmacology are:

Pharmacotherapeutics It is the application of pharmacological information together with knowledge of the disease for its prevention, mitigation or cure. Selection of the most appropriate drug, dosage and duration of treatment taking into account the specific features of a patient are a part of pharmacotherapeutics.

Clinical pharmacology It is the scientific study of drugs in man. It includes pharmacodynamic and pharmacokinetic investigation in healthy volunteers and in patients; evaluation of efficacy and safety of drugs and comparative trials with other forms of treatment; surveillance of patterns of drug use, adverse effects, etc.

The aim of clinical pharmacology is to generate data for optimum use of drugs and the practice of ‘evidence based medicine’.

Chemotherapy It is the treatment of systemic infection/malignancy with specific drugs that

have selective toxicity for the infecting organism/malignant cell with no/minimal effects on the host cells.

Drugs in general, can thus be divided into:

Pharmacodynamic agents These are designed to have pharmacodynamic effects in the recipient.

Chemotherapeutic agents These are designed to inhibit/kill invading parasite/malignant cell and have no/minimal pharmacodynamic effects in the recipient.

Pharmacy It is the art and science of compounding and dispensing drugs or preparing suitable dosage forms for administration of drugs to man or animals. It includes collection, identification, purification, isolation, synthesis, standardization and quality control of medicinal substances. The large scale manufacture of drugs is called *Pharmaceutics*. It is primarily a technological science.

Toxicology It is the study of poisonous effect of drugs and other chemicals (household, environmental pollutant, industrial, agricultural, homicidal) with emphasis on detection, prevention and treatment of poisonings. It also includes the study of adverse effects of drugs, since the same substance can be a drug or a poison, depending on the dose.

DRUG NOMENCLATURE

A drug generally has three categories of names:

(a) Chemical name It describes the substance chemically, e.g. 1-(Isopropylamino)-3-(1-naphthyl)propan-2-ol for propranolol. This is cumbersome and not suitable for use in prescribing. A *code name*, e.g. RO 15-1788 (later named flumazenil) may be assigned by the manufacturer for convenience and simplicity before an approved name is coined.

(b) Non-proprietary name It is the name accepted by a competent scientific body/authority, e.g. the United States Adopted Name (USAN) by the USAN council. Similarly, there is the British

Approved name (BAN) of a drug. The non-proprietary names of newer drugs are kept uniform by an agreement to use the Recommended International Nonproprietary Name (rINN) in all member countries of the WHO. The BAN of older drugs as well has now been modified to be commensurate with rINN. However, many older drugs still have more than one non-proprietary names, e.g. 'meperidine' and 'pethidine' or 'lidocaine' and 'lignocaine' for the same drugs. Until the drug is included in a pharmacopoeia, the nonproprietary name may also be called the *approved name*. After its appearance in the official publication, it becomes the *official name*.

In common parlance, the term *generic name* is used in place of nonproprietary name. Etymologically this is incorrect: 'generic' should be applied to the chemical or pharmacological group (or genus) of the compound, e.g. phenothiazines, tricyclic antidepressants, aminoglycoside antibiotics, etc. However, this misnomer is unlikely to be corrected, because of wide usage, including that in official parlance.

(c) Proprietary (Brand) name It is the name assigned by the manufacturer(s) and is his property or trade mark. One drug may have multiple proprietary names, e.g. **ALTOL**, **ATCARDIL**, **ATECOR**, **ATEN**, **BETACARD**, **LONOL**, **TENOLOL**, **TENORMIN** for atenolol from different manufacturers. Brand names are designed to be catchy, short, easy to remember and often suggestive, e.g. **LOPRESOR** suggesting drug for lowering blood pressure. Brand names generally differ in different countries, e.g. timolol maleate eye drops are marketed as **TIMOPTIC** in USA but as **GLUCOMOL** in India. Even the same manufacturer may market the same drug under different brand names in different countries. In addition, combined formulations have their own multiple brand names. This is responsible for much confusion in drug nomenclature.

There are many arguments for using the nonproprietary name in prescribing: uniformity, convenience, economy and better comprehension (propranolol, sotalol, timolol, pindolol, metoprolol, acebutolol, atenolol are all β blockers,

but their brand names have no such similarity). However, when it is important to ensure consistency of the product in terms of quality and bioavailability, etc. and especially when official control over quality of manufactured products is not rigorous, it is better to prescribe by the dependable brand name.

ESSENTIAL DRUGS (MEDICINES) CONCEPT

The WHO has defined *Essential Drugs** (*medicines*) as "those that satisfy the priority healthcare needs of the population. They are selected with due regard to public health relevance, evidence on efficacy and safety, and comparative cost effectiveness. Essential medicines are intended to be available within the context of functioning health systems at all times and in adequate amounts, in appropriate dosage forms, with assured quality and adequate information, and at a price the individual and the community can afford.

It has been realized that only a handful of drugs out of the multitude available can meet the health care needs of majority of the people in any country, and that many well tested and cheaper drugs are equally (or more) efficacious and safe as their newer more expensive congeners. For optimum utilization of resources, governments (especially in developing countries) should concentrate on these drugs by identifying them as *Essential medicines*. The WHO has laid down criteria to guide selection of an essential medicine.

- (a) Adequate data on its efficacy and safety should be available from clinical studies.
- (b) It should be available in a form in which quality, including bioavailability, and stability on storage can be assured.
- (c) Its choice should depend upon pattern of prevalent diseases; availability of facilities and trained personnel; financial resources; genetic, demographic and environmental factors.
- (d) In case of two or more similar medicines, choice should be made on the basis of their relative efficacy, safety,

* In the 12th list (2003) the terminology has been changed from "essential drugs" to "essential medicines" to denote pharmaceutical preparations used in clinical healthcare practice, because often the term 'drugs' is understood to mean illicit substances.

quality, price and availability. Cost-benefit ratio should be a major consideration.

(e) Choice may also be influenced by comparative pharmacokinetic properties and local facilities for manufacture and storage.

(f) Most essential medicines should be single compounds. Fixed ratio combination products should be included only when dosage of each ingredient meets the requirements of a defined population group, and when the combination has a proven advantage in therapeutic effect, safety, adherence or in decreasing the emergence of drug resistance.

(g) Selection of essential medicines should be a continuous process which should take into account the changing priorities for public health action, epidemiological conditions as well as availability of better medicines/formulations and progress in pharmacological knowledge.

(h) Recently, it has been emphasized to select essential medicines based on rationally developed treatment guidelines.

To guide the member countries, the WHO brought out its first *Model List of Essential Drugs* along with their dosage forms and strengths in 1977 which could be adopted after suitable modifications according to local needs. This has been revised from time to time and the current is the 15th list (2007). India produced its *National Essential Drugs List* in 1996 and has revised it in 2003 with the title "*National List of Essential Medicines*". This includes 354 medicines which are considered to be adequate to meet the priority healthcare needs of the general population of the country. An alphabetical compilation of the WHO as well as National essential medicines is presented as Appendix-1.

Adoption of the essential medicines list for procurement and supply of medicines, especially in the public sector healthcare system, has resulted in improved availability of medicines, cost saving and more rational use of drugs.

Orphan Drugs These are drugs or biological products for diagnosis/treatment/ prevention of a rare disease or condition, or a more common disease (endemic only in resource poor countries) for which there is no reasonable expectation that the cost of developing and marketing it will be recovered from the sales of that drug. The list includes sodium nitrite, fomepizole, liposomal amphotericin B, ancrod, rifabutin, succimer, somatropin, digoxin immune Fab (digoxin antibody), liothyronine (T_3) and many more. Though these drugs may be life saving for some patients, they are

commercially difficult to obtain. Governments in developed countries offer tax benefits and other incentives to pharmaceutical companies for developing and marketing orphan drugs (e.g. Orphan Drug Act in USA).

ROUTES OF DRUG ADMINISTRATION

Most drugs can be administered by a variety of routes. The choice of appropriate route in a given situation depends both on drug as well as patient related factors. Mostly common sense considerations, feasibility and convenience dictate the route to be used.

Factors governing choice of route

1. Physical and chemical properties of the drug (solid/liquid/gas; solubility, stability, pH, irritancy).
2. Site of desired action—localized and approachable or generalized and not approachable.
3. Rate and extent of absorption of the drug from different routes.
4. Effect of digestive juices and first pass metabolism on the drug.
5. Rapidity with which the response is desired (routine treatment or emergency).
6. Accuracy of dosage required (i.v. and inhalational can provide fine tuning).
7. Condition of the patient (unconscious, vomiting).

Routes can be broadly divided into those for (a) Local action and (b) Systemic action.

LOCAL ROUTES

These routes can only be used for localized lesions at accessible sites and for drugs whose systemic absorption from these sites is minimal or absent. Thus, high concentrations are attained at the desired site without exposing the rest of the body. Systemic side effects or toxicity are consequently absent or minimal. For drugs (in suitable dosage forms) that are absorbed from these sites/routes, the same can serve as systemic route of administration, e.g. glyceryl trinitrate (GTN) applied on the skin as ointment or transdermal patch. The local routes are:

1. Topical This refers to external application of the drug to the surface for localized action. It is often more convenient as well as encouraging to the patient. Drugs can be efficiently delivered to the localized lesions on skin, oropharyngeal/nasal mucosa, eyes, ear canal, anal canal or vagina in the form of lotion, ointment, cream, powder, rinse, paints, drops, spray, lozengens, suppositories or pesseries. Nonabsorbable drugs given orally for action on g.i. mucosa (sucralfate, vancomycin), inhalation of drugs for action on bronchi (salbutamol, cromolyn sodium) and irrigating solutions/jellies (povidone iodine, lidocaine) applied to urethra are other forms of topical medication.

2. Deeper tissues Certain deep areas can be approached by using a syringe and needle, but the drug should be such that systemic absorption is slow, e.g. intra-articular injection (hydrocortisone acetate), infiltration around a nerve or intrathecal injection (lidocaine), retrobulbar injection (hydrocortisone acetate).

3. Arterial supply Close intra-arterial injection is used for contrast media in angiography; anticancer drugs can be infused in femoral or brachial artery to localise the effect for limb malignancies.

SYSTEMIC ROUTES

The drug administered through systemic routes is intended to be absorbed into the blood stream and distributed all over, including the site of action, through circulation (*see* Fig. 1.1).

1. Oral

Oral ingestion is the oldest and commonest mode of drug administration. It is safer, more convenient, does not need assistance, noninvasive, often painless, the medicament need not be sterile and so is cheaper. Both solid dosage forms (powders, tablets, capsules, spansules, dragees, moulded tablets, gastrointestinal therapeutic systems—GITs) and liquid dosage forms (elixirs, syrups, emulsions, mixtures) can be given orally.

Limitations of oral route of administration

- Action of drugs is slower and thus not suitable for emergencies.
- Unpalatable drugs (chloramphenicol) are difficult to administer; drug may be filled in capsules to circumvent this.
- May cause nausea and vomiting (emetine).
- Cannot be used for uncooperative/unconscious/vomiting patient.
- Absorption of drugs may be variable and erratic; certain drugs are not absorbed (streptomycin).
- Others are destroyed by digestive juices (penicillin G, insulin) or in liver (GTN, testosterone, lidocaine).

2. Sublingual (s.l.) or buccal

The tablet or pellet containing the drug is placed under the tongue or crushed in the mouth and spread over the buccal mucosa. Only lipid soluble and non-irritating drugs can be so administered. Absorption is relatively rapid—action can be produced in minutes. Though it is somewhat inconvenient, one can spit the drug after the desired effect has been obtained. The chief advantage is that liver is bypassed and drugs with high first pass metabolism can be absorbed directly into systemic circulation. Drugs given sublingually are—GTN, buprenorphine, desamino-oxytocin.

3. Rectal

Certain irritant and unpleasant drugs can be put into rectum as suppositories or retention enema for systemic effect. This route can also be used when the patient is having recurrent vomiting or is unconscious. However, it is rather inconvenient and embarrassing; absorption is slower, irregular and often unpredictable, though diazepam solution is rapidly and dependably absorbed from rectum in children. Drug absorbed into external haemorrhoidal veins (about 50%) bypasses liver, but not that absorbed into internal haemorrhoidal veins. Rectal inflammation can result from irritant drugs. Diazepam, indomethacin,

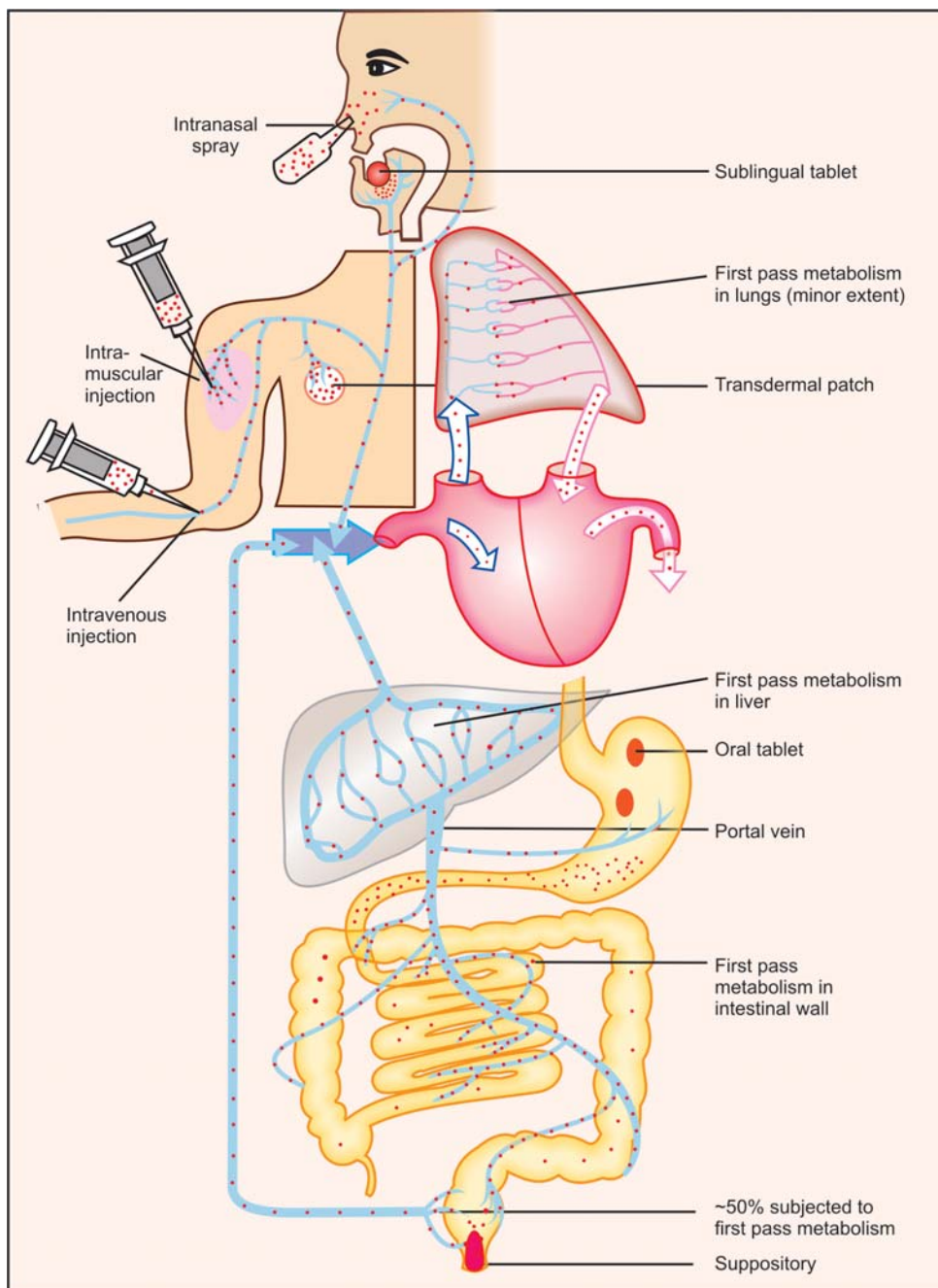

Fig. 1.1: Vascular pathway of drugs absorbed from various systemic routes of administration and sites of first pass metabolism

Note: Total drug absorbed orally is subjected to first pass metabolism in intestinal wall and liver, while approximately half of that absorbed from rectum passes through liver. Drug entering from any systemic route is exposed to first pass metabolism in lungs, but its extent is minor for most drugs.

paraldehyde, ergotamine and few other drugs are some times given rectally.

4. Cutaneous

Highly lipid soluble drugs can be applied over the skin for slow and prolonged absorption. The liver is also bypassed. The drug can be incorporated in an ointment and applied over specified area of skin. Absorption of the drug can be enhanced by rubbing the preparation, by using an oily base and by an occlusive dressing.

Transdermal therapeutic systems These are devices in the form of adhesive patches of various shapes and sizes (5–20 cm²) which deliver the contained drug at a constant rate into systemic circulation via the stratum corneum (Fig. 1.2). The drug (in solution or bound to a polymer) is held in a reservoir between an occlusive backing film and a rate controlling micropore membrane, the under surface of which is smeared with an adhesive impregnated with priming dose of the drug. The adhesive layer is protected by another film that is to be peeled off just before application. The drug is delivered at the skin surface by diffusion for percutaneous absorption into circulation. The micropore membrane is such that rate of drug delivery to skin surface is less than the slowest rate of absorption from skin. This offsets any variation in the rate of absorption according to the properties of different sites. As such, the drug is delivered at a constant and predictable rate irrespective of site of application: usually chest, abdomen, upper arm, lower back, buttock or mastoid region are utilized.

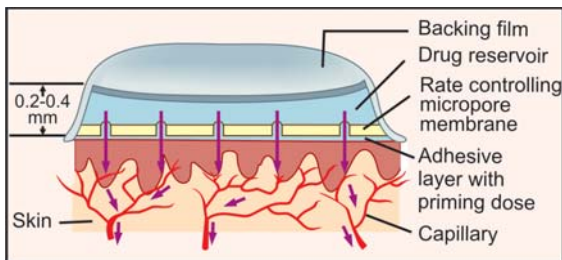

Fig. 1.2: Illustration of a transdermal drug delivery system

Transdermal patches of GTN, fentanyl, nicotine and estradiol are available in India, while those of isosorbide dinitrate, hyoscine, and clonidine are available in other countries. These have been designed to last for 1–7 days in case of different drugs and are becoming increasingly popular, because they provide smooth plasma concentrations of the drug without fluctuations; minimize interindividual variations (drug is subjected to little first pass metabolism) and side effects. They are also more convenient—many patients prefer transdermal patches to oral tablets of the same drug; patient compliance is better. Local irritation and erythema occurs in some, but is generally mild; can be minimized by changing the site of application each time by rotation. Discontinuation has been necessary in 2–7% cases.

5. Inhalation

Volatile liquids and gases are given by inhalation for systemic action, e.g. general anaesthetics. Absorption takes place from the vast surface of alveoli—action is very rapid. When administration is discontinued the drug diffuses back and is rapidly eliminated in expired air. Thus, controlled administration is possible with moment to moment adjustment. Irritant vapours (ether) cause inflammation of respiratory tract and increase secretion.

6. Nasal

The mucous membrane of the nose can readily absorb many drugs; digestive juices and liver are bypassed. However, only certain drugs like GnRH agonists and desmopressin applied as a spray or nebulized solution have been used by this route. This route is being tried for some other peptide drugs, like insulin.

7. Parenteral

(*Par*—beyond, *enteral*—intestinal)

This refers to administration by injection which takes the drug directly into the tissue fluid or blood without having to cross the intestinal mucosa. The limitations of oral administration are circumvented.

Drug action is faster and surer (valuable in emergencies). Gastric irritation and vomiting are not provoked. Parenteral routes can be employed even in unconscious, uncooperative or vomiting patient. There are no chances of interference by food or digestive juices. Liver is bypassed.

Disadvantages of parenteral routes are—the preparation has to be sterilized and is costlier, the technique is invasive and painful, assistance of another person is mostly needed (though self injection is possible, e.g. insulin by diabetics), there are chances of local tissue injury and, in general, parenteral route is more risky than oral. The important parenteral routes are:

(i) Subcutaneous (s.c.) The drug is deposited in the loose subcutaneous tissue which is richly supplied by nerves (irritant drugs cannot be injected) but is less vascular (absorption is slower than intramuscular). Only small volumes can be injected s.c. Self-injection is possible because deep penetration is not needed. This route should be avoided in shock patients who are vasoconstricted—absorption will be delayed. Repository (depot) preparations that are aqueous suspensions can be injected for prolonged action. Some special forms of this route are:

(a) Dermojet In this method needle is not used; a high velocity jet of drug solution is projected from a microfine orifice using a gun like implement. The solution passes through the superficial layers and gets deposited in the subcutaneous tissue. It is essentially painless and suited for mass inoculations.

(b) Pellet implantation The drug in the form of a solid pellet is introduced with a trochar and cannula. This provides sustained release of the drug over weeks and months, e.g. DOCA, testosterone.

(c) Sialistic (nonbiodegradable) and biodegradable implants Crystalline drug is packed in tubes or capsules made of suitable materials and implanted under the skin. Slow and uniform leaching of the drug occurs over months providing constant blood levels. The nonbiodegradable implant has

to be removed later on but not the biodegradable one. This has been tried for hormones and contraceptives (e.g. **NORPLANT**).

(ii) Intramuscular (i.m.) The drug is injected in one of the large skeletal muscles—deltoid, triceps, gluteus maximus, rectus femoris, etc. Muscle is less richly supplied with sensory nerves (mild irritants can be injected) and is more vascular (absorption of drugs in aqueous solution is faster). It is less painful, but self injection is often impracticable because deep penetration is needed. Depot preparations (oily solutions, aqueous suspensions) can be injected by this route. Intramuscular injections should be avoided in anticoagulant treated patients, because it can produce local haematoma.

(iii) Intravenous (i.v.) The drug is injected as a bolus (Greek: *bolos*—lump) or infused slowly over hours in one of the superficial veins. The drug reaches directly into the blood stream and effects are produced immediately (great value in emergency). The intima of veins is insensitive and drug gets diluted with blood, therefore, even highly irritant drugs can be injected i.v., but hazards are—thrombophlebitis of the injected vein and necrosis of adjoining tissues if extravasation occurs. These complications can be minimized by diluting the drug or injecting it into a running i.v. line. Only aqueous solutions (not suspensions) can be injected i.v. and there are no depot preparations for this route. The dose of the drug required is smallest (bioavailability is 100%) and even large volumes can be infused. One big advantage with this route is—in case response is accurately measurable (e.g. BP) and the drug short acting (e.g. sodium nitroprusside), titration of the dose with the response is possible. However, this is the most risky route—vital organs like heart, brain, etc. get exposed to high concentrations of the drug.

(iv) Intradermal injection The drug is injected into the skin raising a bleb (e.g. BCG vaccine, sensitivity testing) or *scarring/multiple puncture* of the epidermis through a drop of the drug is done. This route is employed for specific purposes only.

CHAPTER 2

Pharmacokinetics: Membrane Transport, Absorption and Distribution of Drugs

Pharmacokinetics is the quantitative study of drug movement in, through and out of the body. The overall scheme of pharmacokinetic processes is depicted in Fig. 2.1. The intensity of response is related to concentration of the drug at the site of action, which in turn is dependent on its pharmacokinetic properties. Pharmacokinetic considerations, therefore, determine the route(s) of administration, dose, latency of onset, time of peak action, duration of action and frequency of administration of a drug.

All pharmacokinetic processes involve transport of the drug across biological membranes.

Biological membrane This is a bilayer (about 100 Å thick) of phospholipid and cholesterol molecules, the polar groups (glyceryl phosphate attached to ethanolamine/choline or hydroxyl group of cholesterol) of these are oriented at the two surfaces and the nonpolar hydrocarbon chains are embedded in the matrix to form a continuous sheet. Extrinsic and intrinsic protein molecules are adsorbed on the lipid bilayer

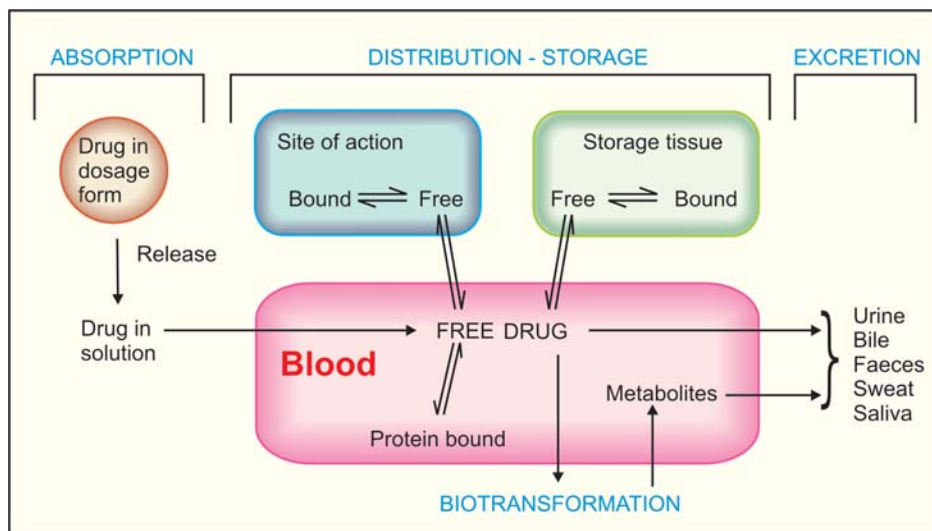

Fig. 2.1: Schematic depiction of pharmacokinetic processes

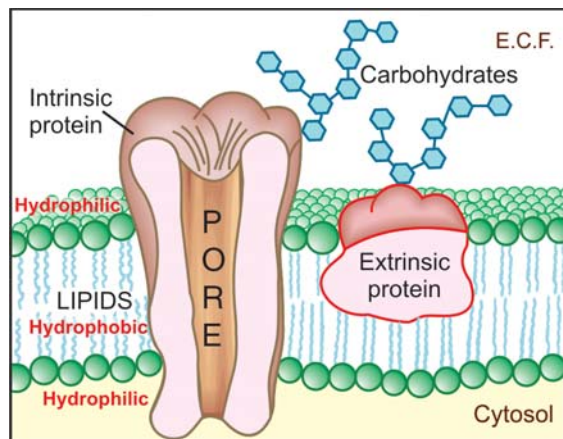

Fig. 2.2: Illustration of the organisation of biological membrane

(Fig. 2.2). Glycoproteins or glycolipids are formed on the surface by attachment to polymeric sugars, aminosugars or sialic acids. The specific lipid and protein composition of different membranes differs according to the cell or the organelle type. The proteins are able to freely float through the membrane: associate and organize or vice versa. Some of the intrinsic ones, which extend through the full thickness of the membrane, surround fine aqueous pores. Paracellular spaces or channels also exist between certain epithelial/endothelial cells. Other adsorbed proteins have enzymatic, carrier, receptor or signal transduction properties. Lipid molecules also are capable of lateral movement. Thus, biological membranes are highly dynamic structures.

Drugs are transported across the membranes by:

- Passive diffusion and filtration
- Specialized transport

Passive diffusion

The drug diffuses across the membrane in the direction of its concentration gradient, the membrane playing no active role in the process. This is the most important mechanism for majority of drugs; drugs are foreign substances (xenobiotics), and specialized mechanisms are developed by the body primarily for normal metabolites.

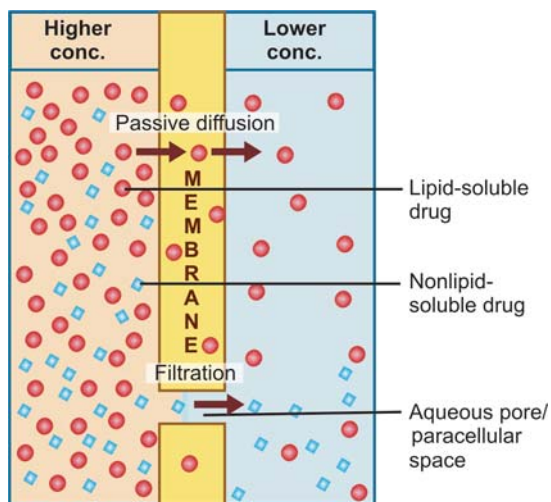

Fig. 2.3: Illustration of passive diffusion and filtration across the lipoidal biological membrane with aqueous pores

Lipid soluble drugs diffuse by dissolving in the lipoidal matrix of the membrane (Fig. 2.3), the rate of transport being proportional to the lipid : water partition coefficient of the drug. A more lipid-soluble drug attains higher concentration in the membrane and diffuses quickly. Also, greater the difference in the concentration of the drug on the two sides of the membrane, faster is its diffusion.

Influence of pH Most drugs are weak electrolytes, i.e. their ionization is pH dependent (contrast strong electrolytes that are nearly completely ionized at acidic as well as alkaline pH). The ionization of a weak acid HA is given by the equation:

$$pH = pK_a + \log \frac{[A^-]}{[HA]} \quad \dots(1)$$

pK_a is the negative logarithm of acidic dissociation constant of the weak electrolyte. If the concentration of ionized drug $[A^-]$ is equal to concentration of unionized drug $[HA]$, then

$$\frac{[A^-]}{[HA]} = 1$$

since $\log 1$ is 0, under this condition

$$pH = pK_a \quad \dots(2)$$

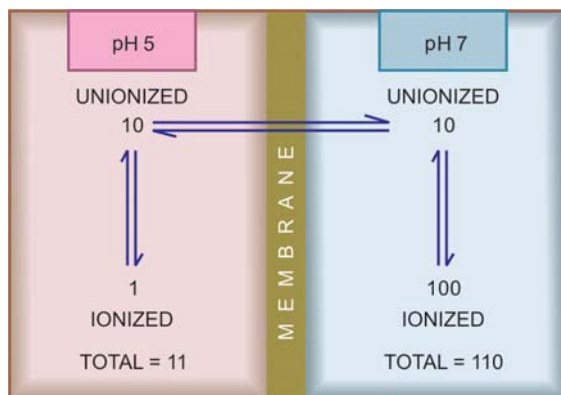

Fig. 2.4: Influence of pH difference on two sides of a biological membrane on the steady-state distribution of a weakly acidic drug with $pK_a = 6$

Thus, pK_a is numerically equal to the pH at which the drug is 50% ionized.

If pH is increased by 1 scale, then—

$$\log [A^-]/[HA] = 1 \quad \text{or} \quad [A^-]/[HA] = 10$$

Similarly, if pH is reduced by 1 scale, then—

$$[A^-]/[HA] = 1/10$$

Thus, weakly acidic drugs, which form salts with cations, e.g. *sod.* phenobarbitone, *sod.* sulfadiazine, *pot.* penicillin-V, etc. ionize more at alkaline pH and 1 scale change in pH causes 10 fold change in ionization.

Weakly basic drugs, which form salts with anions, e.g. atropine *sulfate*, ephedrine *HCl*, chloroquine *phosphate*, etc. conversely ionize more at acidic pH. Ions being lipid insoluble, do not diffuse and a pH difference across a membrane can cause differential distribution of weakly acidic and weakly basic drugs on the two sides (Fig. 2.4).

Implications of this consideration are:

- Acidic drugs, e.g. aspirin (pK_a 3.5) are largely unionized at acid gastric pH and are absorbed from stomach, while bases, e.g. atropine (pK_a 10) are largely ionized and are absorbed only when they reach the intestines.
- The unionized form of acidic drugs which crosses the surface membrane of gastric mucosal

cell, reverts to the ionized form within the cell (pH 7.0) and then only slowly passes to the extracellular fluid. This is called *ion trapping*, i.e. a weak electrolyte crossing a membrane to encounter a pH from which it is not able to escape easily. This may contribute to gastric mucosal cell damage caused by aspirin.

(c) Basic drugs attain higher concentration intracellularly (pH 7.0 vs 7.4 of plasma).

(d) Acidic drugs are ionized more in alkaline urine—do not back diffuse in the kidney tubules and are excreted faster. Accordingly, basic drugs are excreted faster if urine is acidified.

Lipid-soluble nonelectrolytes (e.g. ethanol, diethyl-ether) readily cross biological membranes and their transport is pH independent.

Filtration

Filtration is passage of drugs through aqueous pores in the membrane or through paracellular spaces. This can be accelerated if hydrodynamic flow of the solvent is occurring under hydrostatic or osmotic pressure gradient, e.g. across most capillaries including glomeruli. Lipid-insoluble drugs cross biological membranes by filtration if their molecular size is smaller than the diameter of the pores (Fig. 2.3). Majority of cells (intestinal mucosa, RBC, etc.) have very small pores (4 Å) and drugs with MW > 100 or 200 are not able to penetrate. However, capillaries (except those in brain) have large paracellular spaces (40 Å) and most drugs (even albumin) can filter through these (Fig. 2.8). As such, diffusion of drugs across capillaries is dependent on rate of blood flow through them rather than on lipid solubility of the drug or pH of the medium.

Specialized transport

This can be carrier mediated or by pinocytosis.

Carrier transport

All cell membranes express a host of transmembrane proteins which serve as carriers or transporters for physiologically important ions, nutrients, metabolites, transmitters, etc. across the membrane. At some sites, certain transporters also

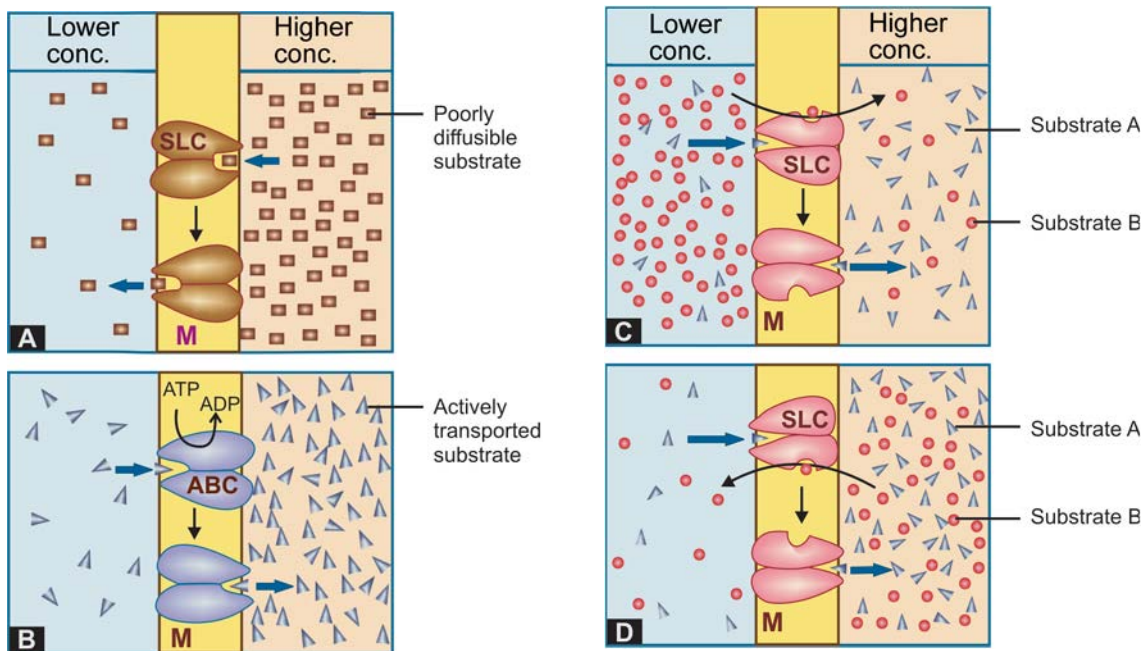

Fig. 2.5: Illustration of different types of carrier mediated transport across biological membrane
 ABC—ATP-binding cassette transporter; SLC—Solute carrier transporter; M—Membrane

A. Facilitated diffusion: the carrier (SLC) binds and moves the poorly diffusible substrate along its concentration gradient (high to low) and does not require energy

B. Primary active transport: the carrier (ABC) derives energy directly by hydrolysing ATP and moves the substrate against its concentration gradient (low to high)

C. Symport: the carrier moves the substrate 'A' against its concentration gradient by utilizing energy from downhill movement of another substrate 'B' in the same direction

D. Antiport: the carrier moves the substrate 'A' against its concentration gradient and is energized by the downhill movement of another substrate 'B' in the opposite direction

translocate xenobiotics, including drugs and their metabolites. In contrast to channels, which open for a finite time and allow passage of specific ions, transporters combine transiently with their substrate (ion or organic compound)—undergo a conformational change carrying the substrate to the other side of the membrane where the substrate dissociates and the transporter returns back to its original state (Fig. 2.5). Carrier transport is specific for the substrate (or the type of substrate, e.g. an organic anion), saturable, competitively inhibited by analogues which utilize the same transporter, and is much slower than flux through channels. Depending on requirement of energy, carrier transport is of two types:

a. **Facilitated diffusion** The transporter, belonging to the super-family of *solute carrier* (SLC) transporters, operates passively without needing energy and translocates the substrate in the direction of its electrochemical gradient, i.e. from higher to lower concentration (Fig. 2.5A). It nearly facilitates permeation of a poorly diffusible substrate, e.g. the entry of glucose into muscle and fat cells by GLUT 4.

b. **Active transport** It requires energy, is inhibited by metabolic poisons, and transports the solute against its electrochemical gradient (low to high), resulting in selective accumulation of the substance on one side of the membrane. Drugs related to normal metabolites can utilize

the transport processes meant for these, e.g. levodopa and methyl dopa are actively absorbed from the gut by the aromatic amino acid transporter. In addition, the body has developed some relatively nonselective transporters, like *P-glycoprotein* (P-gp), to deal with xenobiotics. Active transport can be primary or secondary depending on the source of the driving force.

i. **Primary active transport** Energy is obtained directly by the hydrolysis of ATP (Fig. 2.5B). The transporters belong to the superfamily of *ATP binding cassette* (ABC) transporters whose intracellular loops have ATPase activity. They mediate only efflux of the solute from the cytoplasm, either to extracellular fluid or into an intracellular organelle (endoplasmic reticulum, mitochondria, etc.)

Encoded by the multidrug resistance 1 (MDR1) gene, P-gp is the most well known primary active transporter expressed in the intestinal mucosa, renal tubules, bile canaliculi, choroidal epithelium, astrocyte foot processes around brain capillaries (the blood-brain barrier), testicular and placental microvessels, which pumps out many drugs/metabolites and thus limits their intestinal absorption, penetration into brain, testes and foetal tissues as well as promotes biliary and renal elimination. Many xenobiotics which induce or inhibit P-gp also have a similar effect on the drug metabolizing isoenzyme CYP3A4, indicating their synergistic role in detoxification of xenobiotics.

Other primary active transporters of pharmacological significance are multidrug resistance associated protein 2 (MRP 2) and breast cancer resistance protein (BCRP).

ii. **Secondary active transport** In this type of active transport effected by another set of SLC transporters, the energy to pump one solute is derived from the downhill movement of another solute (mostly Na^+). When the concentration gradients are such that both the solutes move in the same direction (Fig. 2.5C), it is called *symport* or *cotransport*, but when they move in opposite directions (Fig. 2.5D), it is termed *antiport* or *exchange transport*. Metabolic energy (from hydrolysis of ATP) is spent in maintaining high transmembrane electrochemical gradient of the second solute. The SLC transporters mediate both uptake and efflux of drugs and metabolites.

The organic anion transporting polypeptide (OATP) and organic cation transporter (OCT), highly expressed in

liver canaliculi and renal tubules, are secondary active transporters important in the metabolism and excretion of drugs and metabolites (especially glucuronides). The Na^+Cl^- dependent neurotransmitter transporters for serotonin and dopamine (SERT and DAT) as well as the vesicular transporter for biogenic amines are active SLC transporters that are targets for action of drugs like tricyclic antidepressants and reserpine, etc. The absorption of glucose in intestines and renal tubules is through secondary active transport by sodium-glucose transporters (SGLT1 and SGLT2).

As indicated earlier, carrier transport (both facilitated diffusion and active transport) is saturable and follows the Michaelis-Menten kinetics. The maximal rate of transport is dependent on the density of the transporter in a particular membrane, and its rate constant (K_m), i.e. the substrate concentration at which rate of transport is half maximal, is governed by its affinity for the substrate. Genetic polymorphism can alter both the density and affinity of the transporter protein for different substrates and thus affect the pharmacokinetics of drugs. Moreover, tissue specific drug distribution can occur due to the presence of specific transporters in certain cells.

Pinocytosis It is the process of transport across the cell in particulate form by formation of vesicles. This is applicable to proteins and other big molecules, and contributes little to transport of most drugs.

ABSORPTION

Absorption is movement of the drug from its site of administration into the circulation. Not only the fraction of the administered dose that gets absorbed, but also the rate of absorption is important. Except when given i.v., the drug has to cross biological membranes; absorption is governed by the above described principles. Other factors affecting absorption are:

Aqueous solubility Drugs given in solid form must dissolve in the aqueous biophase before they are absorbed. For poorly water soluble drugs (aspirin, griseofulvin) rate of dissolution governs rate of absorption. Obviously, a drug given as watery solution is absorbed faster than when the same is given in solid form or as oily solution.

Concentration Passive diffusion depends on concentration gradient; drug given as concentrated solution is absorbed faster than from dilute solution.

Area of absorbing surface Larger it is, faster is the absorption.

Vascularity of the absorbing surface Blood circulation removes the drug from the site of absorption and maintains the concentration gradient across the absorbing surface. Increased blood flow hastens drug absorption just as wind hastens drying of clothes.

Route of administration This affects drug absorption, because each route has its own peculiarities.

Oral

The effective barrier to orally administered drugs is the epithelial lining of the gastrointestinal tract, which is lipoidal. Nonionized lipid soluble drugs, e.g. ethanol are readily absorbed from stomach as well as intestine at rates proportional to their lipid : water partition coefficient. Acidic drugs, e.g. salicylates, barbiturates, etc. are predominantly unionized in the acid gastric juice and are absorbed from stomach, while basic drugs, e.g. morphine, quinine, etc. are largely ionized and are absorbed only on reaching the duodenum. However, even for acidic drugs absorption from stomach is slower, because the mucosa is thick, covered with mucus and the surface area is small. Absorbing surface area is much larger in the small intestine due to villi. Thus, faster gastric emptying accelerates drug absorption in general. Dissolution is a surface phenomenon, therefore, *particle size* of the drug in solid dosage form governs rate of dissolution and in turn rate of absorption.

Presence of food dilutes the drug and retards absorption. Further, certain drugs form poorly absorbed complexes with food constituents, e.g. tetracyclines with calcium present in milk; moreover food delays gastric emptying. Thus, most drugs are absorbed better if taken in empty stomach. Highly ionized drugs, e.g. gentamicin,

neostigmine are poorly absorbed when given orally.

Certain drugs are degraded in the gastrointestinal tract, e.g. penicillin G by acid, insulin by peptidases, and are ineffective orally. Enteric coated tablets (having acid resistant coating) and sustained release preparations (drug particles coated with slowly dissolving material) can be used to overcome acid lability, gastric irritancy and brief duration of action.

The oral absorption of certain drugs is low because a fraction of the absorbed drug is extruded back into the intestinal lumen by the efflux transporter P-gp located in the gut epithelium. The low oral bioavailability of digoxin and cyclosporine is partly accounted by this mechanism. Inhibitors of P-gp like quinidine, verapamil, erythromycin, etc. enhance while P-gp inducers like rifampin and phenobarbitone reduce the oral bioavailability of these drugs.

Absorption of a drug can be affected by other concurrently ingested drugs. This may be a *luminal effect*: formation of insoluble complexes, e.g. tetracyclines with iron preparations and antacids, phenytoin with sucralfate. Such interaction can be minimized by administering the two drugs at 2–3 hr intervals. Alteration of gut flora by antibiotics may disrupt the enterohepatic cycling of oral contraceptives and digoxin. Drugs can also alter absorption by *gut wall effects*: altering motility (anticholinergics, tricyclic antidepressants, opioids, metoclopramide) or causing mucosal damage (neomycin, methotrexate, vinblastine).

Subcutaneous and Intramuscular

By these routes the drug is deposited directly in the vicinity of the capillaries. Lipid soluble drugs pass readily across the whole surface of the capillary endothelium. Capillaries having large paracellular spaces do not obstruct absorption of even large lipid insoluble molecules or ions (Fig. 2.8A). Very large molecules are absorbed through lymphatics. Thus, many drugs not absorbed orally are absorbed parenterally. Absorption from s.c. site is slower than that from i.m. site, but both are

generally faster and more consistent/ predictable than oral absorption. Application of heat and muscular exercise accelerate drug absorption by increasing blood flow, while vasoconstrictors, e.g. adrenaline injected with the drug (local anaesthetic) retard absorption. Incorporation of hyaluronidase facilitates drug absorption from s.c. injection by promoting spread. Many depot preparations, e.g. benzathine penicillin, protamine zinc insulin, depot progestins, etc. can be given by these routes.

Topical sites (skin, cornea, mucous membranes)

Systemic absorption after topical application depends primarily on lipid solubility of drugs. However, only few drugs significantly penetrate intact skin. Hyoscine, fentanyl, GTN, nicotine, testosterone, and estradiol (*see p. 9*) have been used in this manner. Corticosteroids applied over extensive areas can produce systemic effects and pituitary-adrenal suppression. Absorption can be promoted by rubbing the drug incorporated in an oleaginous base or by use of occlusive dressing which increases hydration of the skin. Organophosphate insecticides coming in contact with skin can produce systemic toxicity. Abraded surfaces readily absorb drugs, e.g. tannic acid applied over burnt skin has produced hepatic necrosis.

Cornea is permeable to lipid soluble, unionized physostigmine but not to highly ionized neostigmine. Drugs applied as eye drops may get absorbed through the nasolacrimal duct, e.g. timolol eye drops may produce bradycardia and precipitate asthma. Mucous membranes of mouth, rectum, vagina absorb lipophilic drugs: estrogen cream applied vaginally has produced gynaecomastia in the male partner.

BIOAVAILABILITY

Bioavailability refers to the rate and extent of absorption of a drug from a dosage form as determined by its concentration-time curve in blood or by its excretion in urine (Fig. 2.6). It is a measure of the fraction (F) of administered dose

of a drug that reaches the systemic circulation in the unchanged form. Bioavailability of drug injected i.v. is 100%, but is frequently lower after oral ingestion because—

- the drug may be incompletely absorbed.
- the absorbed drug may undergo first pass metabolism in the intestinal wall/liver or be excreted in bile.

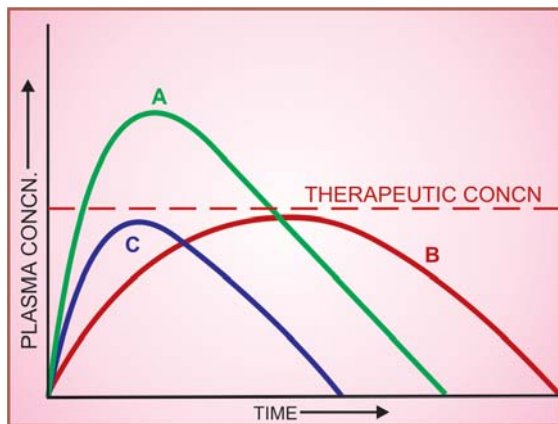

Fig. 2.6: Plasma concentration-time curves depicting bioavailability differences between three preparations of a drug containing the same amount

Note that formulation *B* is more slowly absorbed than *A*, and though ultimately both are absorbed to the same extent (area under the curve same), *B* may not produce therapeutic effect; *C* is absorbed to a lesser extent—lower bioavailability

Incomplete bioavailability after s.c. or i.m. injection is less common, but may occur due to local binding of the drug.

Oral formulations of a drug from different manufacturers or different batches from the same manufacturer may have the same amount of the drug (chemically equivalent) but may not yield the same blood levels—*biologically inequivalent*. Two preparations of a drug are considered *bioequivalent* when the rate and extent of bioavailability of the drug from them is not significantly different under suitable test conditions.

Before a drug administered orally in solid dosage form can be absorbed, it must break into individual particles of the active drug (disintegration). Tablets and capsules contain a number

of other materials—diluent, stabilizing agents, binders, lubricants, etc. The nature of these as well as details of the manufacture process, e.g. force used in compressing the tablet, may affect *disintegration*. The released drug must then *dissolve* in the aqueous gastrointestinal contents. The rate of dissolution is governed by the inherent solubility, particle size, crystal form and other physical properties of the drug. Differences in bioavailability may arise due to variations in disintegration and dissolution rates.

Differences in bioavailability are seen mostly with poorly soluble and slowly absorbed drugs. Reduction in particle size increases the rate of absorption of aspirin (microfine tablets). The amount of griseofulvin and spironolactone in the tablet can be reduced to half if the drug particle is microfined. There is no need to reduce the particle size of freely water soluble drugs, e.g. paracetamol.

Bioavailability variation assumes practical significance for drugs with low safety margin (digoxin) or where dosage needs precise control (oral hypoglycaemics, oral anticoagulants). It may also be responsible for success or failure of an antimicrobial regimen.

However, in the case of a large number of drugs bioavailability differences are negligible and the risks of changing formulation have often been exaggerated.

DISTRIBUTION

Once a drug has gained access to the blood stream, it gets distributed to other tissues that initially had no drug, concentration gradient being in the direction of plasma to tissues. The extent of distribution of a drug depends on its lipid solubility, ionization at physiological pH (a function of its pKa), extent of binding to plasma and tissue proteins, presence of tissue-specific transporters and differences in regional blood flow. Movement of drug proceeds until an equilibrium is established between unbound drug

in plasma and tissue fluids. Subsequently, there is a parallel decline in both due to elimination.

Apparent volume of distribution (V) Presuming that the body behaves as a single homogeneous compartment with volume V into which drug gets immediately and uniformly distributed

$$V = \frac{\text{dose administered i.v.}}{\text{plasma concentration}} \quad \dots(3)$$

Since in the example shown in Fig. 2.7, the drug does not actually distribute into 20 L of body water, with the exclusion of the rest of it, this is only an apparent volume of distribution which can be defined as “the volume that would accommodate all the drug in the body, if the concentration throughout was the same as in plasma”. Thus, it describes the amount of drug present in the body as a multiple of that contained in a unit volume of plasma. Considered together with drug clearance, this is a very useful pharmacokinetic concept.

Lipid-insoluble drugs do not enter cells— V approximates extracellular fluid volume, e.g. streptomycin, gentamicin 0.25 L/kg.

Distribution is not only a matter of dilution, but also binding and sequestration. Drugs extensively bound to plasma proteins are largely restricted to the vascular compartment and have low values, e.g. diclofenac and warfarin (99% bound) $V = 0.15$ L/kg.

Drugs sequestered in other tissues may have, V much more than total body water or even body mass, e.g. digoxin 6 L/kg, propranolol 4 L/kg, morphine 3.5 L/kg, because most of the drug is present in other tissues, and plasma concentration is low. Therefore, in case of poisoning, drugs with large volumes of distribution are not easily removed by haemodialysis.

Pathological states, e.g. congestive heart failure, uraemia, cirrhosis of liver, etc. can alter the V of many drugs by altering distribution of body water, permeability of membranes, binding proteins or by accumulation of metabolites that displace the drug from binding sites.

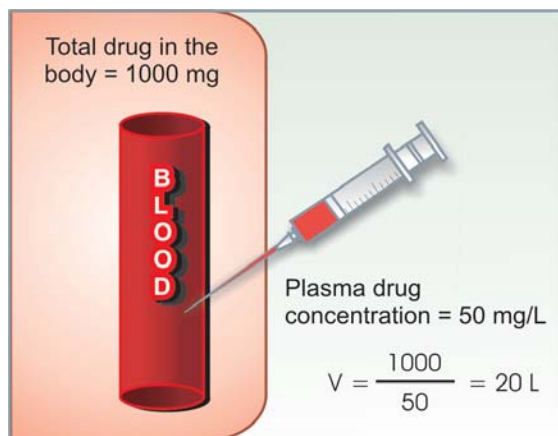

Fig. 2.7: Illustration of the concept of apparent volume of distribution (V).

In this example, 1000 mg of drug injected i.v. produces steady-state plasma concentration of 50 mg/L, apparent volume of distribution is 20 L

More precise multiple compartment models for drug distribution have been worked out, but the single compartment model, described above, is simple and fairly accurate for many drugs.

Redistribution Highly lipid-soluble drugs get initially distributed to organs with high blood flow, i.e. brain, heart, kidney, etc. Later, less

Factors governing volume of drug distribution

- Lipid: water partition coefficient of the drug
- pK_a value of the drug
- Degree of plasma protein binding
- Affinity for different tissues
- Fat: lean body mass ratio, which can vary with age, sex, obesity, etc.
- Diseases like CHF, uremia, cirrhosis

vascular but more bulky tissues (muscle, fat) take up the drug—plasma concentration falls and the drug is withdrawn from these sites. If the site of action of the drug was in one of the highly perfused organs, redistribution results in termination of drug action. Greater the lipid solubility of the drug, faster is its redistribution. Anaesthetic action of thiopentone sod. injected i.v. is terminated in few minutes due to redistribution. A relatively short hypnotic action lasting 6–8 hours is exerted by oral diazepam or nitrazepam due to redistribution despite their elimination $t_{1/2}$ of > 30 hr. However, when the same drug is given repeatedly or continuously over long periods, the low perfusion high capacity sites get progressively filled up and the drug becomes longer acting.

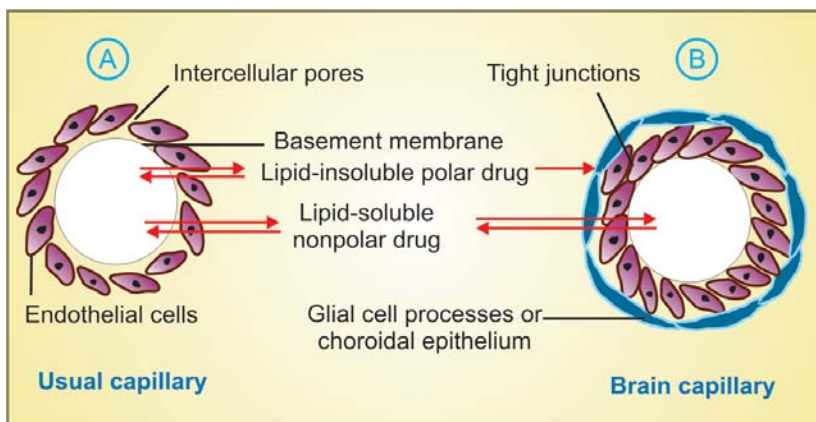

Fig. 2.8: Passage of drugs across capillaries

A. Usual capillary with large intercellular pores through which even large lipid-insoluble molecules diffuse

B. Capillary constituting blood brain or blood-CSF barrier. Tight junctions between capillary endothelial cells and investment of glial processes or choroidal epithelium do not allow passage of non lipid-soluble molecules/ions

Penetration into brain and CSF The capillary endothelial cells in brain have tight junctions and lack large intercellular pores. Further, an investment of neural tissue (Fig. 2.8B) covers the capillaries. Together they constitute the so called *blood-brain barrier*. A similar *blood-CSF barrier* is located in the choroid plexus: capillaries are lined by choroidal epithelium having tight junctions. Both these barriers are lipoidal and limit the entry of nonlipid-soluble drugs, e.g. streptomycin, neostigmine, etc. Only lipid-soluble drugs, therefore, are able to penetrate and have action on the central nervous system. In addition, efflux transporters like P-gp and anion transporter (OATP) present in brain and choroidal vessels extrude many drugs that enter brain by other processes. Dopamine does not enter brain but its precursor levodopa does; as such, the latter is used in parkinsonism. Inflammation of meninges or brain increases permeability of these barriers. It has been proposed that some drugs accumulate in the brain by utilizing the transporters for endogenous substances.

There is also an enzymatic blood-brain barrier: monoamine oxidase (MAO), cholinesterase and some other enzymes are present in the capillary walls or in the cells lining them. They do not allow catecholamines, 5-HT, acetylcholine, etc. to enter brain in the active form.

The blood-brain barrier is deficient at the CTZ in the medulla oblongata (even lipid-insoluble drugs are emetic) and at certain periventricular sites—(anterior hypothalamus). Exit of drugs from the CSF and brain, however, is not dependent on lipid-solubility and is rather unrestricted. Bulk flow of CSF (alongwith the drug dissolved in it) occurs through the arachnoid villi and non-specific organic anion and cation transport processes (similar to those in renal tubule) operate at the choroid plexus.

Passage across placenta Placental membranes are lipoidal and allow free passage of lipophilic drugs, while restricting hydrophilic drugs. The placental efflux P-gp also serves to limit foetal exposure to maternally administered

drugs. However, restricted amounts of nonlipid-soluble drugs, when present in high concentration or for long periods in maternal circulation, gain access to the foetus. Some influx transporters also operate at the placenta. Thus, it is an incomplete barrier and almost any drug taken by the mother can affect the foetus or the newborn (drug taken just before delivery, e.g. morphine).

Plasma protein binding

Most drugs possess physicochemical affinity for plasma proteins. Acidic drugs generally bind to plasma albumin and basic drugs to α_1 acid glycoprotein. Binding to albumin is quantitatively more important. Extent of binding depends on the individual compound; no generalization for a pharmacological or chemical class can be made (even small chemical change can markedly alter protein binding), for example the binding percentage of some benzodiazepines is:

Flurazepam	10%	Alprazolam	70%
Lorazepam	90%	Diazepam	99%

Increasing concentrations of the drug can progressively saturate the binding sites: fractional binding may be lower when large amounts of the drug are given. The generally expressed percentage binding refers to the usual therapeutic plasma concentrations of a drug. The clinically significant implications of plasma protein binding are:

(i) Highly plasma protein bound drugs are largely restricted to the vascular compartment

Drugs highly bound to plasma protein

To albumin	To α_1 -acid glycoprotein
Barbiturates	β -blockers
Benzodiazepines	Bupivacaine
NSAIDs	Lidocaine
Valproic acid	Disopyramide
Phenytoin	Imipramine
Penicillins	Methadone
Sulfonamides	Prazosin
Tetracyclines	Quinidine
Tolbutamide	Verapamil
Warfarin	

because protein bound drug does not cross membranes (except through large paracellular spaces, such as in capillaries). They tend to have smaller volumes of distribution.

(ii) The bound fraction is not available for action. However, it is in equilibrium with the free drug in plasma and dissociates when the concentration of the latter is reduced due to elimination. Plasma protein binding thus tantamounts to temporary storage of the drug.

(iii) High degree of protein binding generally makes the drug long acting, because bound fraction is not available for metabolism or excretion, unless it is actively extracted by liver or kidney tubules. Glomerular filtration does not reduce the concentration of the free form in the efferent vessels because water is also filtered. Active tubular secretion, however, removes the drug without the attendant solvent → concentration of free drug falls → bound drug dissociates and is eliminated resulting in a higher renal clearance value of the drug than the total renal blood flow (See Fig. 3.2). The same is true of active transport of highly extracted drugs in liver. Plasma protein binding in this situation acts as a carrier mechanism and hastens drug elimination, e.g. excretion of penicillin; metabolism of lidocaine. Highly protein bound drugs are not removed by haemodialysis and need special techniques for treatment of poisoning.

(iv) Generally expressed plasma concentrations of the drug refer to bound as well as free drug. Degree of protein binding should be taken into account while relating these to concentrations of the drug that are active *in vitro*, e.g. MIC of an antimicrobial.

(v) One drug can bind to many sites on the albumin molecule. Conversely, more than one drug can bind to the same site. This can give rise to displacement interactions among drugs bound to the same site(s): drug bound with higher affinity will displace that bound with lower affinity. If just 1% of a drug that is 99% bound is displaced, the concentration of free form will be doubled. This, however, is often transient because the displaced drug will diffuse into the tissues as well as get metabolized or excreted: the new steady-state free drug concentration is only marginally higher unless the displacement extends to tissue binding or there is concurrent inhibition of metabolism and/or excretion. The overall impact of many displacement interactions is minimal; clinical significance being attained only in case of highly bound drugs with limited volume of distribution (many acidic drugs bound to albumin) and where interaction is more complex. Moreover, two highly bound drugs do not necessarily displace each other—their binding sites may not overlap, e.g. probenecid and indomethacin are highly bound to albumin but do not dis-

Drugs concentrated in tissues

<i>Skeletal muscle, heart</i>	— digoxin, emetine (bound to muscle proteins).
<i>Liver</i>	— chloroquine, tetracyclines, emetine, digoxin.
<i>Kidney</i>	— digoxin, chloroquine, emetine.
<i>Thyroid</i>	— iodine.
<i>Brain</i>	— chlorpromazine, acetazolamide, isoniazid.
<i>Retina</i>	— chloroquine (bound to nucleoproteins).
<i>Iris</i>	— ephedrine, atropine (bound to melanin).
<i>Bone and teeth</i>	— tetracyclines, heavy metals (bound to mucopolysaccharides of connective tissue), bisphosphonates (bound to hydroxyapatite)
<i>Adipose tissue</i>	— thiopentone, ether, minocycline, phenoxybenzamine, DDT dissolve in neutral fat due to high lipid-solubility; remain stored due to poor blood supply of fat.

place each other. Similarly, acidic drugs do not generally displace basic drugs and *vice versa*. Some clinically important displacement interactions are:

- Salicylates displace sulfonylureas.
- Indomethacin, phenytoin displace warfarin.
- Sulfonamides and vit K displace bilirubin (kernicterus in neonates).
- Salicylates displace methotrexate.

(vi) In hypoalbuminemia, binding may be reduced and high concentrations of free drug may be attained, e.g. phenytoin and furosemide. Other diseases may also alter drug binding, e.g. digoxin, phenytoin and pethidine binding is reduced in uraemia; propranolol binding is increased in pregnant women and in patients

with inflammatory disease (acute phase reactant α_1 acid-glycoprotein increases).

Tissue storage Drugs may also accumulate in specific organs by active transport or get bound to specific tissue constituents (*see box*).

Drugs sequestered in various tissues are differentially distributed, tend to have large volume of distribution and long duration of action. Some may exert local toxicity due to high concentration, e.g. tetracyclines on bone and teeth, chloroquine on retina, streptomycin on vestibular apparatus, emetine on heart and skeletal muscle. Drugs may also selectively bind to specific intracellular organelle, e.g. tetracycline to mitochondria, chloroquine to nuclei.

CHAPTER 3

Pharmacokinetics: Metabolism and Excretion of Drugs, Kinetics of Elimination

BIOTRANSFORMATION (Metabolism)

Biotransformation means chemical alteration of the drug in the body. It is needed to render nonpolar (lipid-soluble) compounds polar (lipid-insoluble) so that they are not reabsorbed in the renal tubules and are excreted. Most hydrophilic drugs, e.g. streptomycin, neostigmine, pancuronium, etc. are little biotransformed and are largely excreted unchanged. Mechanisms which metabolize drugs (essentially foreign substances) have developed to protect the body from ingested toxins.

The primary site for drug metabolism is liver; others are—kidney, intestine, lungs and plasma. Biotransformation of drugs may lead to the following.

(i) *Inactivation* Most drugs and their active metabolites are rendered inactive or less active, e.g. ibuprofen, paracetamol, lidocaine, chloramphenicol, propranolol and its active metabolite 4-hydroxypropranolol.

(ii) *Active metabolite from an active drug* Many drugs have been found to be partially converted to one or more active metabolite; the effects observed are the sumtotal of that due to the parent drug and its active metabolite(s) (See box).

(iii) *Activation of inactive drug* Few drugs are inactive as such and need conversion in the body to one or more active metabolites. Such a drug is called a *prodrug* (See box). The prodrug may offer advantages over the active form in being more stable, having better bioavailability or other desirable pharmacokinetic properties or less side effects and toxicity. Some prodrugs are activated selectively at the site of action.

Active drug	Active metabolite
Chloral hydrate	Trichloroethanol
Morphine	Morphine-6-glucuronide
Cefotaxime	Desacetyl cefotaxime
Allopurinol	Alloxanthine
Procainamide	N-acetyl procainamide
Primidone	Phenobarbitone, phenylethylmalonamide
Diazepam	Desmethyl-diazepam, oxazepam
Digitoxin	Digitoxin
Imipramine	Desipramine
Amitriptyline	Nortriptyline
Codeine	Morphine
Spiroinolactone	Canrenone
Losartan	E 3174

Biotransformation reactions can be classified into:

- (a) Nonsynthetic/Phase I/Functionalization reactions: a functional group is generated or exposed—metabolite may be active or inactive.
- (b) Synthetic/Conjugation/Phase II reactions—metabolite is mostly inactive; except few drugs, e.g. glucuronide conjugate of morphine and sulfate conjugate of minoxidil are active.

Prodrug	Active form
Levodopa	— Dopamine
Enalapril	— Enalaprilat
α -Methyldopa	— α -methylnorepinephrine
Dipivefrine	— Epinephrine
Sulindac	— Sulfide metabolite
Proguanil	— Cycloguanil
Prednisone	— Prednisolone
Bacampicillin	— Ampicillin
Sulfasalazine	— 5-Aminosalicylic acid
Cyclophosphamide	— Aldophosphamide, phosphoramidate mustard, acrolein
Fluorouracil	— Fluorouridine monophosphate
Mercaptopurine	— Methylmercaptopurine ribonucleotide
Acyclovir	— Acyclovir triphosphate

Nonsynthetic reactions

(i) Oxidation This reaction involves addition of oxygen/negatively charged radical or removal of hydrogen/positively charged radical. Oxidations are the most important drug metabolizing reactions. Various oxidation reactions are:

hydroxylation; oxygenation at C, N or S atoms; N or O-dealkylation, oxidative deamination, etc.

In many cases the initial insertion of oxygen atom into the drug molecule produces short lived highly reactive quinone/epoxide/superoxide intermediates which then convert to more stable compounds.

Oxidative reactions are mostly carried out by a group of monooxygenases in the liver, which in the final step involve a cytochrome P-450 haemoprotein, NADPH, cytochrome P-450 reductase and molecular O₂. More than 100 cytochrome P-450 isoenzymes differing in their affinity for various substrates (drugs), have been identified.

Depending upon the extent of amino acid sequence homology, the cytochrome P-450 (CYP) isoenzymes are grouped into families designated by numerals (1, 2, 3....), each having several sub-families designated by capital letters (A, B, C....), while individual isoenzymes are again allotted numerals (1, 2, 3....). In human beings, only a few members of *three* isoenzyme families (CYP 1, 2 and 3) carry out metabolism of most of the drugs, and many drugs such as tolbutamide, barbiturates, nifedipine are substrates for more than one isoform. The CYP isoenzymes important in man are:

CYP3A4/5 Carry out biotransformation of largest number (nearly 50%) of drugs. In addition to liver, these isoforms are expressed in intestine (responsible for first pass metabolism at this site) and kidney as well. Inhibition of this isoenzyme by erythromycin, clarithromycin, ketoconazole, itraconazole is responsible for the important drug interaction with terfenadine, astemizole and cisapride (see p. 158) which are its substrates. Losartan, nifedipine and cyclosporine are also metabolized by CYP3A4/5. Verapamil, diltiazem, ritonavir and a constituent of grape fruit juice are other important inhibitors, while rifampicin, barbiturates and other anticonvulsants are the important inducers.

CYP2D6 This is the next most important CYP isoform which metabolizes nearly 20% drugs including tricyclic antidepressants, selective serotonin reuptake inhibitors, many neuroleptics, antiarrhythmics, β -blockers and opiates. Inhibition of this enzyme by quinidine results in failure of conversion of codeine to morphine \rightarrow analgesic effect of codeine is lost. Human subjects can be grouped into 'extensive' or 'poor' metabolizers of metoprolol and debrisoquin. The poor metabolizers have an altered CYP2D6 enzyme and exhibit low capacity to hydroxylate many drugs.

CYP2C8/9 Important in the biotransformation of >15 commonly used drugs including phenytoin, warfarin which are narrow safety margin drugs, as well as ibuprofen and tolbutamide.

CYP2C19 Metabolizes > 12 frequently used drugs including omeprazole, lansoprazole.

Rifampicin and carbamazepine are potent inducers of the CYP2C subfamily.

CYP1A1/2 Though this subfamily participates in the metabolism of only few drugs like theophylline, it is more

important for activation of procarcinogens. Apart from rifampicin and carbamazepine, polycyclic hydrocarbons, cigarette smoke and charbroiled meat are its potent inducers.

CYP2E1 It catalyses oxidation of alcohol and formation of minor metabolites of few drugs, notably the hepatotoxic N-acetyl benzoquinoneimine from paracetamol; chronic alcoholism induces this isoenzyme.

The relative amount of different cytochrome P-450s differs among species and among individuals of the same species. These differences largely account for the marked interspecies and interindividual differences in rate of metabolism of drugs.

Barbiturates, phenothiazines, imipramine, ibuprofen, paracetamol, steroids, phenytoin, benzodiazepines, theophylline and many other drugs are oxidized in this way. Few drugs like cimetidine, ranitidine, clozapine are oxidized at their N, P or S atoms by a group of flavin-monooxygenases that are present in liver, but are distinct from CYPs. They have not been found to be induced or inhibited by other drugs, and thus are not involved in drug interactions. Some other drugs, e.g. adrenaline, alcohol, mercaptopurine are oxidized by mitochondrial or cytoplasmic enzymes.

(ii) Reduction This reaction is the converse of oxidation and involves cytochrome P-450 enzymes working in the opposite direction. Alcohols, aldehydes, quinones are reduced. Drugs primarily reduced are chloralhydrate, chloramphenicol, halothane, warfarin.

(iii) Hydrolysis This is cleavage of drug molecule by taking up a molecule of water.



Similarly, amides and polypeptides are hydrolysed by amidases and peptidases. In addition, there are epoxide hydrolases which detoxify epoxide metabolites of some drugs generated by CYP oxygenases. Hydrolysis occurs in liver, intestines, plasma and other tissues. Examples are choline esters, procaine, lidocaine, procainamide, aspirin, carbamazepine-epoxide, pethidine, oxytocin.

(iv) Cyclization This is formation of ring structure from a straight chain compound, e.g. proguanil.

(v) Decyclization This is opening up of ring structure of the cyclic drug molecule, e.g. barbiturates, phenytoin. This is generally a minor pathway.

Synthetic reactions

These involve conjugation of the drug or its phase I metabolite with an endogenous substrate, generally derived from carbohydrate or amino acid, to form a polar highly ionized organic acid, which is easily excreted in urine or bile. Conjugation reactions have high energy requirement.

(i) Glucuronide conjugation This is the most important synthetic reaction carried out by a group of UDP-glucuronosyl transferases (UGTs). Compounds with a hydroxyl or carboxylic acid group are easily conjugated with glucuronic acid which is derived from glucose. Examples are—chloramphenicol, aspirin, paracetamol, lorazepam, morphine, metronidazole. Not only drugs but endogenous substrates like bilirubin, steroidal hormones and thyroxine utilize this pathway. Glucuronidation increases the molecular weight of the drug which favours its excretion in bile. Drug glucuronides excreted in bile can be hydrolysed by bacteria in the gut—the liberated drug is reabsorbed and undergoes the same fate. This enterohepatic cycling of the drug prolongs its action, e.g. phenolphthalein, oral contraceptives.

(ii) Acetylation Compounds having amino or hydrazine residues are conjugated with the help of acetyl coenzyme-A, e.g. sulfonamides, isoniazid, PAS, hydralazine, clonazepam, procainamide. Multiple genes control the N-acetyl transferases (NATs), and rate of acetylation shows genetic polymorphism (slow and fast acetylators).

(iii) Methylation The amines and phenols can be methylated; methionine and cysteine acting as methyl donors, e.g. adrenaline, histamine, nicotinic acid, methyl dopa, captopril, mercaptopurine.

(iv) **Sulfate conjugation** The phenolic compounds and steroids are sulfated by sulfotransferases (SULTs), e.g. chloramphenicol, methyl-dopa, adrenal and sex steroids.

(v) **Glycine conjugation** Salicylates and other drugs having carboxylic acid group are conjugated with glycine, but this is not a major pathway of metabolism.

(vi) **Glutathione conjugation** Forming a mercapturate is normally a minor pathway. However, it serves to inactivate highly reactive quinone or epoxide intermediates formed during metabolism of certain drugs, e.g. paracetamol. When large amount of such intermediates are formed (in poisoning or after enzyme induction), glutathione supply falls short—toxic adducts are formed with tissue constituents → tissue damage.

(vii) **Ribonucleoside/nucleotide synthesis** This pathway is important for the activation of many purine and pyrimidine antimetabolites used in cancer chemotherapy.

Most drugs are metabolized by many pathways, simultaneously or sequentially as illustrated in Fig. 3.1. Rates of reaction by different pathways often vary considerably. A variety of metabolites (some more, some less) of a drug may be produced. Stereoisomers of a drug may be metabolized differently and at different rates, e.g. S-warfarin rapidly undergoes ring oxidation, while R-warfarin is slowly degraded by sidechain reduction.

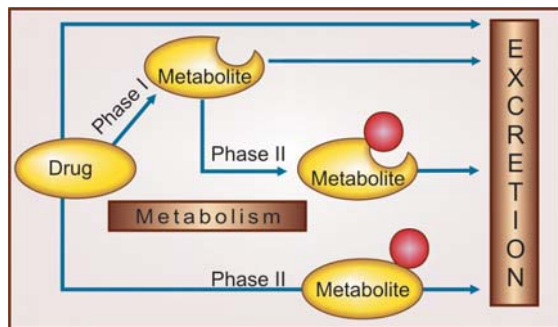

Fig. 3.1: Simultaneous and/or sequential metabolism of a drug by phase I and phase II reactions

Only a few drugs are metabolized by enzymes of intermediary metabolism, e.g. alcohol by dehydrogenase, allopurinol by xanthine oxidase, succinylcholine and procaine by plasma cholinesterase, adrenaline by monoamine oxidase. Majority of drugs are acted on by relatively nonspecific enzymes which are directed to types of molecules rather than to specific drugs. The same enzyme can metabolize many drugs. The drug metabolising enzymes are divided into two types:

Microsomal enzymes These are located on smooth endoplasmic reticulum (a system of microtubules inside the cell), primarily in liver, also in kidney, intestinal mucosa and lungs. The monooxygenases, cytochrome P 450, glucuronyl transferase, etc. are microsomal enzymes.

They catalyse most of the oxidations, reductions, hydrolysis and glucuronide conjugation. Microsomal enzymes are inducible by drugs, diet and other agencies.

Nonmicrosomal enzymes These are present in the cytoplasm and mitochondria of hepatic cells as well as in other tissues including plasma. The flavoprotein oxidases, esterases, amidases and conjugases are nonmicrosomal. Reactions catalysed are:

Some oxidations and reductions, many hydrolytic reactions and all conjugations except glucuronidation.

The nonmicrosomal enzymes are not inducible but many show genetic polymorphism (acetyl transferase, pseudocholinesterase).

Both microsomal and nonmicrosomal enzymes are deficient in the newborn, especially premature, making them more susceptible to many drugs, e.g. chloramphenicol, opioids. This deficit is made up in first few months, more quickly in case of oxidation and other phase I reactions than in case of glucuronide and other conjugations taking 3 or more months.

The amount and kind of drug metabolizing enzymes is controlled genetically and is also altered by environmental factors. Thus, marked interspecies and interindividual differences are

seen, e.g. cats are deficient in glucuronyl transferase while dogs are deficient in acetyl transferase. Upto 6-fold difference in the rate of metabolism of a drug among normal human adults may be observed. This is one of the major causes of individual variation in drug response.

Hofmann elimination This refers to inactivation of the drug in the body fluids by spontaneous molecular rearrangement without the agency of any enzyme, e.g. atracurium.

INHIBITION OF DRUG METABOLISM

One drug can competitively inhibit the metabolism of another if it utilizes the same enzyme or cofactors. However, such interactions are not as common as one would expect, because often different drugs are substrates for different cytochrome P-450 isoenzymes. It is thus important to know the CYP isoenzyme(s) that carry out the metabolism of a particular drug. A drug may inhibit one isoenzyme while being itself a substrate of another isoenzyme, e.g. quinidine is metabolized by CYP3A4 but inhibits CYP2D6. Also most drugs, at therapeutic concentrations, are metabolized by non-saturation kinetics, i.e. the enzyme is present in excess. Clinically significant inhibition of drug metabolism occurs in case of drugs having affinity for the same isoenzyme, specially if they are metabolized by

saturation kinetics or if kinetics changes from first order to zero order over the therapeutic range (capacity limited metabolism). Obviously, inhibition of drug metabolism occurs in a dose related manner and can precipitate toxicity of the object drug (whose metabolism has been inhibited).

Because enzyme inhibition occurs by direct effect on the enzyme, it has a fast time course (within hours) compared to enzyme induction (*see below*).

Metabolism of drugs with high hepatic extraction is dependent on liver blood flow (blood flow limited metabolism). Propranolol reduces rate of lidocaine metabolism by decreasing hepatic blood flow. Some other drugs whose rate of metabolism is limited by hepatic blood flow are morphine, propranolol, verapamil and imipramine.

MICROSOMAL ENZYME INDUCTION

Many drugs, insecticides and carcinogens interact with DNA and increase the synthesis of microsomal enzyme protein, specially cytochrome P-450 and glucuronyl transferase. As a result rate of metabolism of inducing drug itself and/or other drugs is increased.

Different inducers are relatively selective for certain cytochrome P-450 enzyme families, e.g.:

- Anticonvulsants including phenobarbitone, rifampin, glucocorticoids induce CYP3A isoenzymes.
- Phenobarbitone also induces CYP2B1 and rifampin also induces CYP2D6.
- Isoniazid and chronic alcohol consumption induce CYP2E1.
- Polycyclic hydrocarbons like 3-methylcholanthrene and benzopyrene found in cigarette smoke, charcoalbroiled meat and industrial pollutants induce CYP1A isoenzymes.
- Other important enzyme inducers are: chloral hydrate, phenylbutazone, griseofulvin, DDT.

Since different CYP isoenzymes are involved in the metabolism of different drugs, every inducer

Drugs that inhibit drug metabolizing enzymes

Allopurinol	Diltiazem
Omeprazole	Amiodarone
Erythromycin	Propoxyphene
Clarithromycin	Isoniazid
Chloramphenicol	Cimetidine
Ketoconazole	Quinidine
Itraconazole	Disulfiram
Metronidazole	Verapamil
Ciprofloxacin	MAO inhibitors
Sulfonamides	Ritonavir (and other
Fluoxetine (and other SSRIs)	HIV protease inhibitors)

increases biotransformation of certain drugs but not that of others. However, phenobarbitone like inducers of CYP3A and CYP2D6 affect the metabolism of a large number of drugs, because these isoenzymes act on many drugs. On the other hand induction by polycyclic hydrocarbons is limited to few drugs (like theophylline, phenacetin) because CYP1A isoenzyme metabolizes only few drugs.

Induction involves microsomal enzymes in liver as well as other organs and increases the rate of metabolism by 2–4 fold. Induction takes 4–14 days to reach its peak and is maintained till the inducing agent is being given. Thereafter the enzymes return to their original value over 1–3 weeks.

Consequences of microsomal enzyme induction

1. Decreased intensity and/or duration of action of drugs that are inactivated by metabolism, e.g. failure of contraception with oral contraceptives.
2. Increased intensity of action of drugs that are activated by metabolism. Acute paracetamol toxicity is due to one of its metabolites—toxicity occurs at lower doses in patients receiving enzyme inducers.
3. Tolerance—if the drug induces its own metabolism (autoinduction), e.g. carbamazepine, rifampin.
4. Some endogenous substrates (steroids, bilirubin) are also metabolized faster.
5. Precipitation of acute intermittent porphyria: enzyme induction increases porphyrin synthesis by derepressing δ -aminolevulinic acid synthetase.

6. Intermittent use of an inducer may interfere with adjustment of dose of another drug prescribed on regular basis, e.g. oral anticoagulants, oral hypoglycaemics, antiepileptics, antihypertensives.
7. Interference with chronic toxicity testing in animals.

Drugs whose metabolism is significantly affected by enzyme induction are—phenytoin, warfarin, tolbutamide, imipramine, oral contraceptives, chloramphenicol, doxycycline, theophylline, griseofulvin, phenylbutazone.

Possible uses of enzyme induction

1. Congenital nonhaemolytic jaundice: It is due to deficient glucuronidation of bilirubin; phenobarbitone hastens clearance of jaundice.
2. Cushing's syndrome: phenytoin may reduce the manifestations by enhancing degradation of adrenal steroids.
3. Chronic poisonings: by faster metabolism of the accumulated poisonous substance.
4. Liver disease.

FIRST PASS (PRESYSTEMIC) METABOLISM

This refers to metabolism of a drug during its passage from the site of absorption into the systemic circulation. All orally administered drugs are exposed to drug metabolizing enzymes in the intestinal wall and liver (where they first reach through the portal vein). Presystemic metabolism of limited magnitude can also occur in the skin (transdermally administered drug) and in lungs (for drug reaching venous blood through any

Table 3.1: Extent of first pass metabolism of some important drugs

Low	Intermediate	High	
		not given orally	high oral dose
Phenobarbitone	Aspirin	Isoprenaline	Propranolol
Phenylbutazone	Quinidine	Lidocaine	Alprenolol
Tolbutamide	Desipramine	Hydrocortisone	Verapamil
Theophylline	Nortriptyline	Testosterone	Salbutamol
Pindolol	Chlorpromazine		Glyceryl trinitrate
Isosorbide mononitrate	Pentazocine		Morphine
	Metoprolol		Pethidine

route). The extent of first pass metabolism differs for different drugs (Table 3.1) and is an important determinant of oral bioavailability.

Attributes of drugs with high first pass metabolism:

- (a) Oral dose is considerably higher than sublingual or parenteral dose.
- (b) There is marked individual variation in the oral dose due to differences in the extent of first pass metabolism.
- (c) Oral bioavailability is apparently increased in patients with severe liver disease.
- (d) Oral bioavailability of a drug is increased if another drug competing with it in first pass metabolism is given concurrently, e.g. chlorpromazine and propranolol.

EXCRETION

Excretion is the passage out of systemically absorbed drug. Drugs and their metabolites are excreted in:

- 1. Urine** Through the kidney. It is the most important channel of excretion for majority of drugs (*see below*).
- 2. Faeces** Apart from the unabsorbed fraction, most of the drug present in faeces is derived from bile. Liver actively transports into bile organic acids (especially drug glucuronides by OATP and MRP2), organic bases (by OCT), other lipophilic drugs (by P-gp) and steroids by separate non-specific active transport mechanisms. Relatively larger molecules (MW > 300) are preferentially eliminated in the bile. Most of the drug, including that released by deconjugation of glucuronides by bacteria in intestines is reabsorbed (enterohepatic cycling) and ultimate excretion occurs in urine. Drugs that attain high concentrations in bile are erythromycin, ampicillin, rifampin, tetracycline, oral contraceptives, phenolphthalein.

Certain drugs are excreted directly in colon, e.g. anthracene purgatives, heavy metals.

- 3. Exhaled air** Gases and volatile liquids (general anaesthetics, paraldehyde, alcohol) are eliminated by lungs, irrespective of their lipid

solubility. Alveolar transfer of the gas/vapour depends on its partial pressure in the blood. Lungs also serve to trap and extrude any particulate matter injected i.v.

- 4. Saliva and sweat** These are of minor importance for drug excretion. Lithium, pot. iodide, rifampin and heavy metals are present in these secretions in significant amounts. Most of the saliva along with the drug in it, is swallowed and meets the same fate as orally taken drug.

- 5. Milk** The excretion of drug in milk is not important for the mother, but the suckling infant inadvertently receives the drug. Most drugs enter breast milk by passive diffusion. As such, more lipid soluble and less protein bound drugs cross better. Milk has a lower pH (7.0) than plasma, basic drugs are somewhat more concentrated in it. However, the total amount of drug reaching the infant through breast feeding is generally small and majority of drugs can be given to lactating mothers without ill effects on the infant. Nevertheless, it is advisable to administer any drug to a lactating woman only when essential. Drugs that are contraindicated during breast feeding or need special caution are given in Appendix-3 at the end of the book.

RENAL EXCRETION

The kidney is responsible for excreting all water soluble substances. The amount of drug or its metabolites ultimately present in urine is the sum total of glomerular filtration, tubular reabsorption and tubular secretion (Fig. 3.2).

Net renal excretion = (Glomerular filtration + tubular secretion) – tubular reabsorption

Glomerular filtration Glomerular capillaries have pores larger than usual; all nonprotein bound drug (whether lipid-soluble or insoluble) presented to the glomerulus is filtered. Thus, glomerular filtration of a drug depends on its plasma protein binding and renal blood flow. Glomerular filtration rate (g.f.r.), normally ~ 120 ml/min, declines progressively after the age of 50, and is low in renal failure.

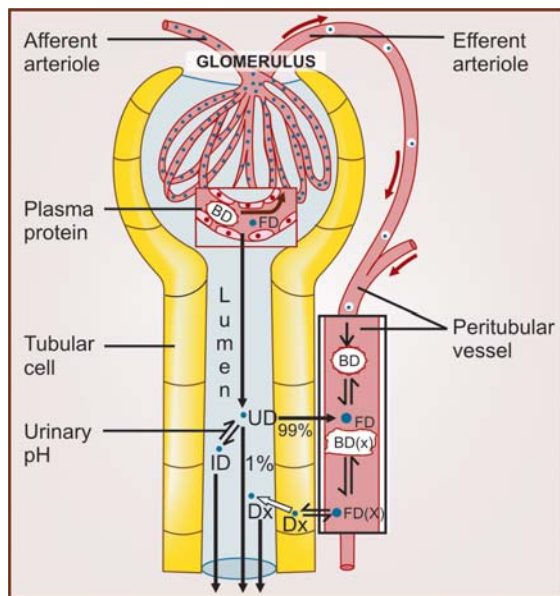

Fig. 3.2: Schematic depiction of glomerular filtration, tubular reabsorption and tubular secretion of drugs

FD—free drug; BD—bound drug; UD—unionized drug; ID—ionized drug, Dx—actively secreted organic acid (or base) drug

Tubular reabsorption This occurs by passive diffusion and depends on lipid solubility and ionization of the drug at the existing urinary pH. Lipid-soluble drugs filtered at the glomerulus back diffuse in the tubules because 99% of glomerular filtrate is reabsorbed, but nonlipid-soluble and highly ionized drugs are unable to do so. Thus, rate of excretion of such drugs, e.g. aminoglycoside antibiotics, quaternary ammonium compounds parallels g.f.r. (or creatinine clearance). Changes in urinary pH affect tubular reabsorption of drugs that are partially ionized—

- Weak bases ionize more and are less reabsorbed in acidic urine.
- Weak acids ionize more and are less reabsorbed in alkaline urine.

This principle is utilized for facilitating elimination of the drug in poisoning, i.e. urine is alkalinized in barbiturate and salicylate poisoning. Though elimination of weak bases (morphine, amphetamine) can be enhanced by acidifying

urine, this is not practiced clinically, because acidosis can induce rhabdomyolysis, cardiotoxicity and actually worsen outcome. The effect of changes in urinary pH on drug excretion is greatest for those having pKa values between 5 to 8, because only in their case pH dependent passive reabsorption is significant.

Tubular secretion This is the active transfer of organic acids and bases by two separate classes of relatively nonspecific transporters (OAT and OCT) which operate in the proximal tubules. In addition, efflux transporters P-gp and MRP2 are located in the luminal membrane of proximal tubular cells. If renal clearance of a drug is greater than 120 mL/min (g.f.r.), additional tubular secretion can be assumed to be occurring.

Active transport of the drug across tubules reduces concentration of its free form in the tubular vessels and promotes dissociation of protein bound drug, which again is secreted (Fig. 3.2). Thus, protein binding, which is a hindrance for glomerular filtration of the drug, is not so (may even be facilitatory) to excretion by tubular secretion.

(a) **Organic acid transport** (through OATP) for penicillin, probenecid, uric acid, salicylates, indomethacin, sulfapyrazone, nitrofurantoin, methotrexate, drug glucuronides and sulfates, etc.

(b) **Organic base transport** (through OCT) for thiazides, amiloride, triamterene, furosemide, quinine, procainamide, choline, cimetidine, etc.

Inherently both transport processes are bi-directional, i.e. they can transport their substrates from blood to tubular fluid and *vice versa*. However, for drugs and their metabolites (exogenous substances) secretion into the tubular lumen predominates, whereas an endogenous substrate like uric acid is predominantly reabsorbed.

Drugs utilizing the same active transport compete with each other. Probenecid is an organic acid which has high affinity for the tubular OATP. It blocks the active transport of both penicillin and uric acid, but whereas the net excretion of the former is decreased, that of the latter is increased.

This is because penicillin is primarily secreted while uric acid is primarily reabsorbed. Many drug interactions occur due to competition for tubular secretion, e.g.

- (i) Salicylates block uricosuric action of probenecid and sulfipyrazone and decrease tubular secretion of methotrexate.
- (ii) Probenecid decreases the concentration of nitrofurantoin in urine, increases the duration of action of penicillin/ampicillin and impairs secretion of methotrexate.
- (iii) Sulfipyrazone inhibits excretion of tolbutamide.
- (iv) Quinidine decreases renal and biliary clearance of digoxin by inhibiting efflux carrier P-gp.

Tubular transport mechanisms are not well developed at birth. As a result, duration of action of many drugs, e.g. penicillin, cephalosporins, aspirin is longer in neonates. These systems mature during infancy. Renal function again progressively declines after the age of 50 years; renal clearance of most drugs is substantially lower in the elderly (>75 yr).

KINETICS OF ELIMINATION

The knowledge of kinetics of elimination of a drug provides the basis for, as well as serves to devise rational dosage regimens and to modify them according to individual needs. There are three fundamental pharmacokinetic parameters, viz. bioavailability (F), volume of distribution (V) and clearance (CL) which must be understood. The first two have already been considered.

Drug elimination is the sumtotal of metabolic inactivation and excretion. As depicted in Fig. 2.1, drug is eliminated only from the central compartment (blood) which is in equilibrium with peripheral compartments including the site of action. Depending upon the ability of the body to eliminate a drug, a certain fraction of the central compartment may be considered to be totally 'cleared' of that drug in a given period of time to account for elimination over that period.

Clearance (CL) The clearance of a drug is the theoretical volume of plasma from which the drug

is completely removed in unit time (analogy creatinine clearance; Fig. 3.3). It can be calculated as

$$CL = \text{Rate of elimination} / C \quad \dots(1)$$

where C is the plasma concentration.

For majority of drugs the processes involved in elimination are not saturated over the clinically obtained concentrations, they follow:

First order (exponential) kinetics The rate of elimination is directly proportional to the drug concentration, CL remains constant; or a constant *fraction* of the drug present in the body is eliminated in unit time.

Few drugs, however, saturate eliminating mechanisms and are handled by—

Zero order (linear) kinetics The rate of elimination remains constant irrespective of drug concentration, CL decreases with increase in concentration; or a constant *amount* of the drug is eliminated in unit time, e.g. ethyl alcohol.

The elimination of some drugs approaches saturation over the therapeutic range, kinetics changes from first order to zero order at higher doses. As a result plasma concentration increases disproportionately with increase in dose, (See Fig. 3.5) as occurs in case of phenytoin, tolbutamide, theophylline, warfarin.

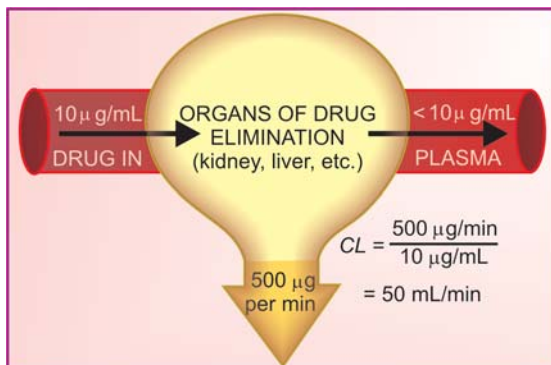

Fig. 3.3: Illustration of the concept of drug clearance. A fraction of the drug molecules present in plasma are removed on each passage through the organs of elimination. In the case shown, it requires 50 mL of plasma to account for the amount of drug being eliminated every minute: clearance is 50 mL/min

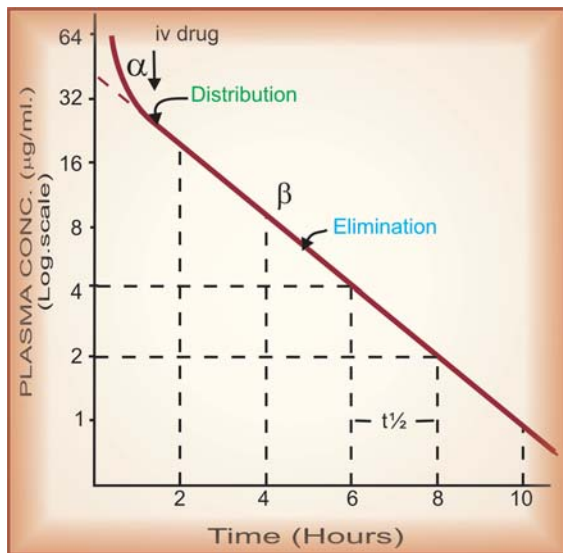

Fig. 3.4: Semilog plasma concentration-time plot of a drug eliminated by first order kinetics after intravenous injection

Plasma half-life The Plasma half-life ($t_{1/2}$) of a drug is the time taken for its plasma concentration to be reduced to half of its original value.

Taking the simplest case of a drug which has rapid one compartment distribution and first order elimination, and is given i.v. a semilog plasma concentration-time plot as shown in Fig. 3.4 is obtained. The plot has two slopes.

- initial rapidly declining (α) phase—due to distribution.
- later less declined (β) phase—due to elimination.

At least two half-lives (distribution $t_{1/2}$ and elimination $t_{1/2}$) can be calculated from the two slopes. The elimination half life derived from the β slope is simply called the 'half life' of the drug.

Most drugs in fact have multicompartment distribution and multiexponential decay of plasma concentration-time plot. Half-lives calculated from the terminal slopes (when plasma concentrations are very low) are exceptionally long, probably due to release of the drug from slow equilibrating tissues, enterohepatic circulation, etc. Only the $t_{1/2}$ calculated over the therapeutic plasma concentration range is clinically relevant. It is this $t_{1/2}$ which is commonly mentioned.

Mathematically, elimination $t_{1/2}$ is

$$t_{1/2} = \frac{\ln 2}{k} \quad \dots(2)$$

Where $\ln 2$ is the natural logarithm of 2 (or 0.693) and k is the *elimination rate constant* of the drug, i.e. the fraction of the total amount of drug in the body which is removed per unit time. For example, if 2 g of the drug is present in the body and 0.1 g is eliminated every hour, then $k = 0.1/2 = 0.05$ or 5% per hour. It is calculated as:

$$k = \frac{CL}{V} \quad \dots(3)$$

therefore
$$t_{1/2} = 0.693 \times \frac{V}{CL} \quad \dots(4)$$

As such, half-life is a derived parameter from two variables V and CL both of which may change independently. It, therefore, is not an exact index of drug elimination. Nevertheless, it is a simple and useful guide to the sojourn of the drug in the body, i.e. after

- 1 $t_{1/2}$ – 50% drug is eliminated.
- 2 $t_{1/2}$ – 75% (50 + 25) drug is eliminated.
- 3 $t_{1/2}$ – 87.5% (50 + 25 + 12.5) drug is eliminated.
- 4 $t_{1/2}$ – 93.75% (50 + 25 + 12.5 + 6.25) drug is eliminated.

Thus, nearly complete drug elimination occurs in 4–5 half lives.

For drugs eliminated by—

First order kinetics— $t_{1/2}$ remains constant because V and CL do not change with dose.

Zero order kinetics— $t_{1/2}$ increases with dose because CL progressively decreases as dose is increased.

Half life of some representative drugs

Aspirin	4 hr	Digoxin	40 hr
Penicillin-G	30 min	Digitoxin	7 days
Doxycycline	20 hr	Phenobarbitone	90 hr

Repeated drug administration

When a drug is repeated at relatively short intervals, it accumulates in the body until elimination

balances input and a *steady state* plasma concentration (C_{pss}) is attained—

$$C_{pss} = \frac{\text{dose rate}}{CL} \quad \dots(5)$$

From this equation it is implied that doubling the dose rate would double the average C_{pss} and so on. Further, if the therapeutic plasma concentration of the drug has been worked out and its CL is known, the dose rate needed to achieve the target C_{pss} can be determined—

$$\text{dose rate} = \text{target } C_{pss} \times CL \quad \dots(6)$$

After oral administration, often only a fraction (F) of the dose reaches systemic circulation in the active form. In such a case—

$$\text{dose rate} = \frac{\text{target } C_{pss} \times CL}{F} \quad \dots(7)$$

The dose rate- C_{pss} relationship is linear only in case of drugs eliminated by first order kinetics. For drugs (e.g. phenytoin) which follow Michaelis Menten kinetics, elimination changes from first order to zero order kinetics over the therapeutic range. Increase in their dose beyond saturation levels causes an increase in C_{pss} which is out of proportion to the change in dose rate (Fig. 3.5). In their case:

$$\text{Rate of drug elimination} = \frac{(V_{max})(C)}{K_m + C} \quad \dots(8)$$

where C is the plasma concentration of the drug, V_{max} is the maximum rate of drug elimination, and K_m is the plasma concentration at which elimination rate is half maximal.

Plateau principle

When constant dose of a drug is repeated before the expiry of $4 t_{1/2}$, it would achieve higher peak concentration, because some remnant of the previous dose will be present in the body. This continues with every dose until progressively increasing rate of elimination (which increases with increase in concentration) balances the

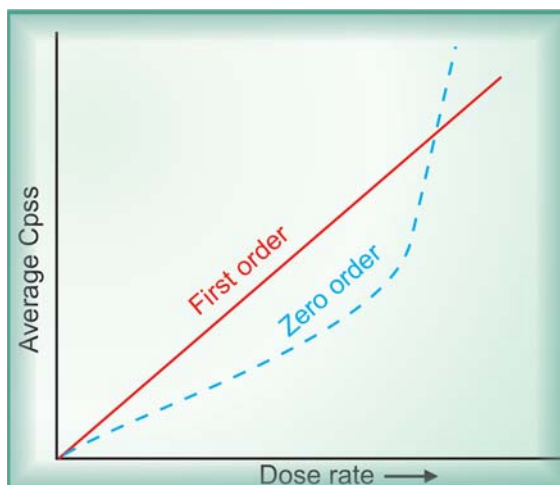

Fig. 3.5: Relationship between dose rate and average steady-state plasma concentration of drugs eliminated by first order and Michaelis Menten (zero order) kinetics

amount administered over the dose interval. Subsequently plasma concentration plateaus and fluctuates about an average steady-state level. This is known as the plateau principle of drug accumulation. Steady-state is reached in 4–5 half lives unless dose interval is very much longer than $t_{1/2}$ (Fig. 3.6).

The amplitude of fluctuations in plasma concentration at steady-state depends on the dose

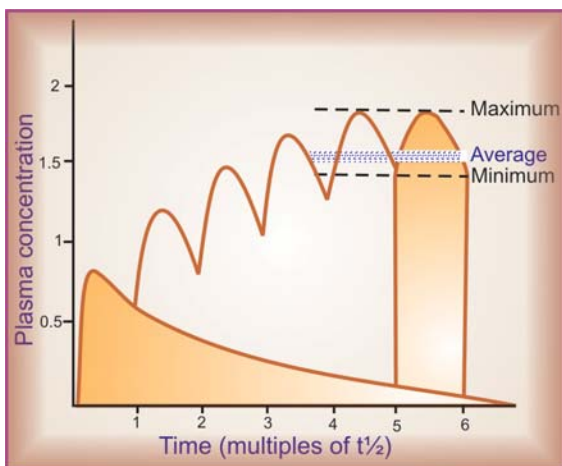

Fig. 3.6: Plateau principle of drug accumulation on repeated oral dosing.

Note. The area of the two shaded portions is equal

interval relative to the $t_{1/2}$, i.e. the difference between the maximum and minimum levels is less if smaller doses are repeated more frequently (dose rate remaining constant). Dose intervals are generally a compromise between what amplitude of fluctuations is clinically tolerated (loss of efficacy at troughs and side effects at peaks) and what frequency of dosing is convenient. However, if the dose rate is changed, a new average C_{pss} is attained over the next 4–5 half lives. When the drug is administered orally (absorption takes some time), average C_{pss} is approximately 1/3 of the way between the minimal and maximal levels in a dose interval.

Target level strategy For drugs whose effects are not easily quantifiable and safety margin is not big, e.g. anticonvulsants, antidepressants, lithium, antiarrhythmics, theophylline, some antimicrobials, etc. or those given to prevent an event, it is best to aim at achieving a certain plasma concentration which has been defined to be in the therapeutic range; such data are now available for most drugs of this type.

Drugs with short $t_{1/2}$ (upto 2–3 hr) administered at conventional intervals (6–12 hr) achieve the target levels only intermittently and fluctuations in plasma concentration are marked. In case of many drugs (penicillin, ampicillin, chloramphenicol, erythromycin, propranolol) this however is therapeutically acceptable.

For drugs with longer $t_{1/2}$ a dose that is sufficient to attain the target concentration after single administration, if repeated will accumulate according to plateau principle and produce toxicity later on. On the other hand, if the dosing is such as to attain target level at steady state, the therapeutic effect will be delayed by about 4 half lives (this may be clinically unacceptable). Such drugs are often administered by initial loading and subsequent maintenance doses.

Loading dose This is a single or few quickly repeated doses given in the beginning to attain target concentration rapidly. It may be calculated as—

$$\text{Loading dose} = \frac{\text{target } C_p \times V}{F} \quad \dots(9)$$

Thus, loading dose is governed only by V and not by CL or $t_{1/2}$.

Maintenance dose This dose is one that is to be repeated at specified intervals after the attainment of target C_{pss} so as to maintain the same by balancing elimination. The maintenance dose rate is computed by equation (7) and is governed by CL (or $t_{1/2}$) of the drug. If facilities for measurement of drug concentration are available, attainment of target level in a patient can be verified subsequently and dose rate adjusted if required.

Such two phase dosing provides rapid therapeutic effect with long term safety; frequently applied to digoxin, chloroquine, long-acting sulfonamides, doxycycline, amiodarone, etc. However, if there is no urgency, maintenance doses can be given from the beginning. The concept of loading and maintenance dose is valid also for short $t_{1/2}$ drugs and i.v. administration in critically ill patients, e.g. lidocaine ($t_{1/2}$ 1.5 hr) used for cardiac arrhythmias is given as an i.v. bolus dose followed by slow i.v. infusion or intermittent fractional dosing.

Monitoring of plasma concentration of drugs

It is clear from the above considerations that the C_{pss} of a drug attained in a given patient depends on its F , V and CL in that patient. Because each of these parameters varies considerably among individuals, the actual C_{pss} in a patient may be 1/3 to 3 times that calculated on the basis of population data. Measurement of plasma drug concentration can give an estimate of the pharmacokinetic variables in that patient and the magnitude of deviation from the 'average patient', so that appropriate adjustments in the dosage regimen can be made.

In case of drugs obeying first order kinetics:

$$\text{Revised dose rate} = \frac{\text{Previous dose rate} \times \text{Target } C_{pss}}{\text{Measured } C_{pss}} \quad \dots(10)$$

Therapeutic drug monitoring (TDM) is particularly useful in the following situations:

1. Drugs with low safety margin—digoxin, anti-convulsants, antiarrhythmics, theophylline, aminoglycoside antibiotics, lithium, tricyclic antidepressants.
2. If individual variations are large—antidepressants, lithium.
3. Potentially toxic drugs used in the presence of renal failure—aminoglycoside antibiotics, vancomycin.
4. In case of poisoning.
5. In case of failure of response without any apparent reason—antimicrobials.
6. To check patient compliance—psychopharmacological agents.

Selection of the correct interval between drug administration and drawing of blood sample for TDM is critical, and depends on the purpose of TDM as well as the nature of the drug.

- a. When the purpose is dose adjustment: In case of drugs which need to act continuously (relatively long-acting drugs), it is prudent to measure the trough steady-state blood levels, i.e. just prior to the next dose, because this is governed by both V and CL . On the other hand, for short-acting drugs which achieve therapeutic levels only intermittently (e.g. ampicillin, gentamicin), sampling is done in the immediate post-absorptive phase (usually after 1–2 hours of oral/i.m. dosing) to reflect the peak levels.
- b. In case of poisoning: Blood for drug level estimation should be taken at the earliest and then repeatedly to confirm the poisoning and to monitor the progress.
- c. For checking compliance to medication: Even random blood sampling can be informative.

Monitoring of plasma concentration is of no value for

1. Drugs whose response is easily measurable—antihypertensives, hypoglycaemics, diuretics, oral anticoagulants, general anaesthetics.
2. Drugs activated in the body—levodopa.
3. 'Hit and run drugs' (whose effect lasts much longer than the drug itself)—reserpine, guanethidine, MAO inhibitors, omeprazole.
4. Drugs with irreversible action—organophosphate anticholinesterases, phenoxybenzamine.

PROLONGATION OF DRUG ACTION

It is sometimes advantageous to modify a drug in such a way that it acts for a longer period. By doing so:

- (i) Frequency of administration is reduced—more convenient.
- (ii) Improved patient compliance—a single morning dose is less likely to be forgotten/omitted than a 6 or 8 hourly regimen; a monthly or quarterly administered contraceptive over one that has to be taken daily.
- (iii) Large fluctuations in plasma concentration are avoided—side effects related to high peak plasma level just after a dose (e.g. nifedipine) would be minimized; better round-the-clock control of blood sugar, etc.
- (iv) Drug effect could be maintained overnight without disturbing sleep, e.g. antiasthmatics, anticonvulsants, etc.

However, all drugs do not need to be made long acting, e.g. those used for brief therapeutic effect (sleep-inducing hypnotic, headache remedy) or those with inherently long duration of action (doxycycline, omeprazole, digoxin, amlodipine). Drugs with $t_{1/2} \leq 4$ hr are suitable for controlled release formulations, while there is no need of such formulations for drugs with $t_{1/2} \geq 12$ hr. Methods utilized for prolonging drug action are summarised below. Some of these have already been described.

1. By prolonging absorption from site of administration

(a) *Oral* Sustained release tablets, spansule capsules, etc.; drug particles are coated with resins, plastic materials or other substances which temporally disperse release of the active ingredient in the g.i.t. Another technique (controlled release tablet/capsule; Fig. 3.7) utilizes a semipermeable membrane to control the release of drug from the dosage form. Such preparations prolong the action by 4 to 8 hours and no more, because in that time drug particles reach the colon. Also, the drug release pattern and consequently the attained blood levels

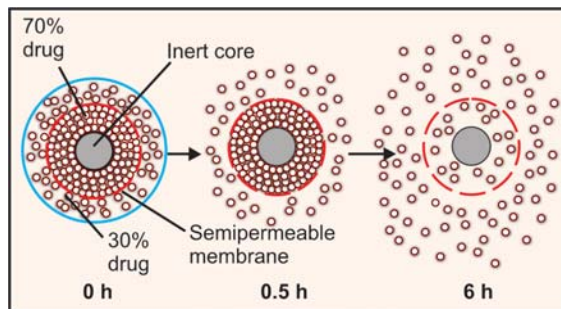

Fig. 3.7: Pattern of drug release from oral controlled release tablet/capsule; 30% of the dose outside the semipermeable membrane is released immediately, while 70% of the dose is released slowly through the membrane over the next 4-8 hours

of the drug may be more variable than the regular tablet of the same drug.

(b) Parenteral The s.c. and i.m. injection of drug in insoluble form (benzathine penicillin, lente insulin) or as oily solution (depot progestins); pellet implantation, sialistic and biodegradable implants can provide for its absorption over a couple of days to several months or even years. Inclusion of a vasoconstrictor with the drug also delays absorption (adrenaline with local anaesthetics).

(c) Transdermal drug delivery systems The drug impregnated in adhesive patches, strips or as ointment applied on skin is becoming popular, e.g. GTN (see p. 9).

2. By increasing plasma protein binding

Drug congeners have been prepared which are highly bound to plasma protein and are slowly released in the free active form, e.g. sulfadoxine.

3. By retarding rate of metabolism

Small chemical modification can markedly affect the rate of metabolism without affecting the biological action, e.g. addition of ethinyl group to estradiol makes it longer acting and suitable for use as oral contraceptive. Inhibition of specific enzyme by one drug can prolong the action of another drug, e.g. allopurinol inhibits the degradation of 6-mercaptopurine, ritonavir boosts the levels of indinavir, cilastatin protects imipenem from degradation in kidney.

4. By retarding renal excretion

The tubular secretion of drug being an active process, can be suppressed by a competing substance, e.g. probenecid prolongs duration of action of penicillin and ampicillin.



CHAPTER 4

Pharmacodynamics: Mechanism of Drug Action; Receptor Pharmacology

Pharmacodynamics is the study of drug effects. It attempts to elucidate the complete action-effect sequence and the dose-effect relationship. Modification of the action of one drug by another drug is also an aspect of pharmacodynamics.

PRINCIPLES OF DRUG ACTION

Drugs (except those gene based) do not impart new functions to any system, organ or cell; they only alter the pace of ongoing activity. The basic types of drug action can be broadly classed as:

1. Stimulation It refers to selective enhancement of the level of activity of specialized cells, e.g. adrenaline stimulates heart, pilocarpine stimulates salivary glands. However, excessive stimulation is often followed by depression of that function, e.g. high dose of picrotoxin, a central nervous system (CNS) stimulant, produces convulsions followed by coma and respiratory depression.

2. Depression It means selective diminution of activity of specialized cells, e.g. barbiturates depress CNS, quinidine depresses heart.

Certain drugs stimulate one type of cells but depress the other, e.g. acetylcholine stimulates intestinal smooth muscle but depresses SA node in heart. Thus, most drugs cannot be simply classed as stimulants or depressants.

3. Irritation This connotes a nonselective, often noxious effect and is particularly applied to less specialized cells (epithelium, connective tissue). Mild irritation may stimulate associated function, e.g. bitters increase salivary and gastric secretion, counterirritants increase blood flow to the site. But strong irritation results in inflammation, corrosion, necrosis and morphological damage. This may result in diminution or loss of function.

4. Replacement This refers to the use of natural metabolites, hormones or their congeners in deficiency states, e.g. levodopa in parkinsonism, insulin in diabetes mellitus, iron in anaemia.

5. Cytotoxic action Selective cytotoxic action for invading parasites or cancer cells, attenuating them without significantly affecting the host cells is utilized for cure/palliation of infections and neoplasms, e.g. penicillin, chloroquine, zidovudine, cyclophosphamide, etc.

MECHANISM OF DRUG ACTION

Only a handful of drugs act by virtue of their simple physical or chemical property; examples are:

- Bulk laxatives (ispaghula)—physical mass
- Dimethicone, petroleum jelly—physical form, opacity

- Paraamino benzoic acid—absorption of UV rays
- Activated charcoal—adsorptive property
- Mannitol, mag. sulfate—osmotic activity
- ^{131}I and other radioisotopes—radioactivity
- Antacids—neutralization of gastric HCl
- Pot. permanganate—oxidizing property
- Chelating agents (EDTA, dimercaprol)—chelation of heavy metals.
- Cholestyramine—sequestration of cholesterol in the gut
- Mesna—Scavenging of vasicotoxic reactive metabolites of cyclophosphamide

Majority of drugs produce their effects by interacting with a discrete target biomolecule, which usually is a protein. Such mechanism confers selectivity of action to the drug. Functional proteins that are targets of drug action can be grouped into *four* major categories, *viz.* enzymes, ion channels, transporters and receptors (See Fig. 4.1). However, a few drugs do act on other proteins (e.g. colchicine, vinca alkaloids, taxanes bind to the structural protein tubulin) or on nucleic acids (alkylating agents).

I. ENZYMES

Almost all biological reactions are carried out under catalytic influence of enzymes; hence, enzymes are a very important target of drug action. Drugs can either increase or decrease the rate of enzymatically mediated reactions. However, in physiological systems enzyme activities are often optimally set. Thus, stimulation of enzymes by drugs, that are truly foreign substances, is unusual. Enzyme stimulation is relevant to some natural metabolites only, e.g. pyridoxine acts as a cofactor and increases decarboxylase activity. Several enzymes are stimulated through receptors and second messengers, e.g. adrenaline stimulates hepatic glycogen phosphorylase through β receptors and cyclic AMP. Stimulation of an enzyme increases its affinity for the substrate so that rate constant (k_M) of the reaction is lowered (Fig. 4.2).

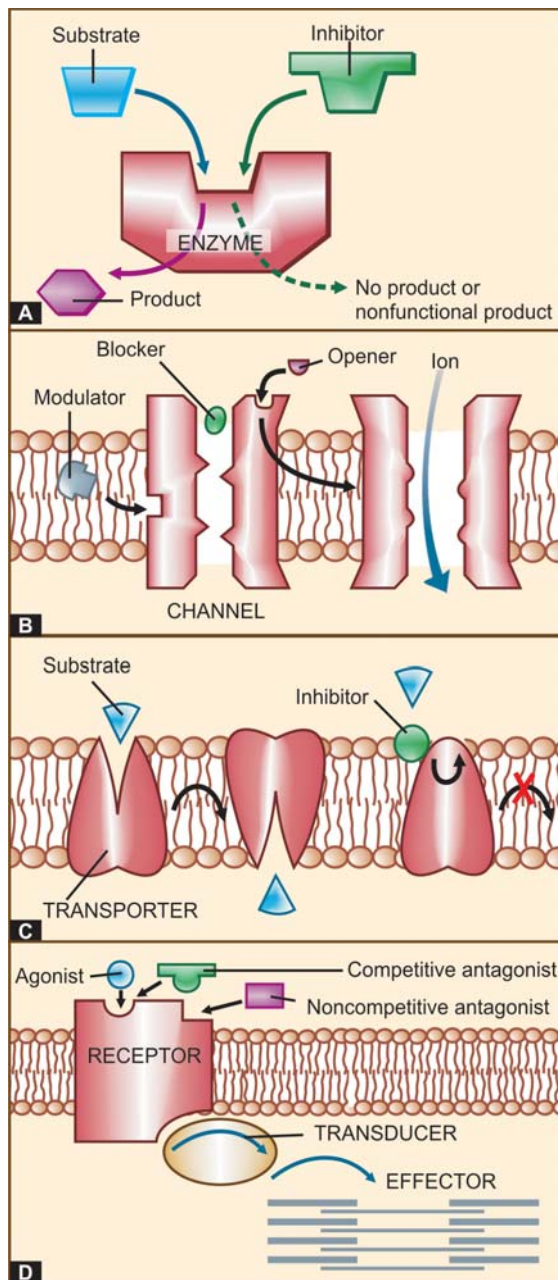

Fig. 4.1: Four major types of biomacromolecular targets of drug action.

(A) Enzyme; (B) Transmembrane ion channel; (C) Membrane bound transporter; (D) Receptor (see text for description)

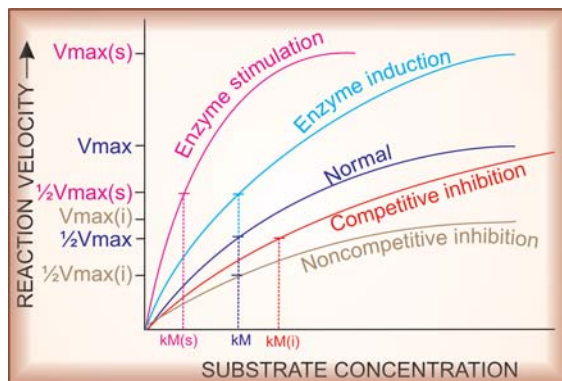

Fig. 4.2: Effect of enzyme induction, stimulation and inhibition on kinetics of enzyme reaction

V_{max} —Maximum velocity of reaction; $V_{max}(s)$ of stimulated enzyme; $V_{max}(i)$ —in presence of noncompetitive inhibitor; kM —rate constant of the reaction; $kM(s)$ —of stimulated enzyme; $kM(i)$ —in presence of competitive inhibitor

Note: Enzyme induction and noncompetitive inhibition do not change the affinity of the enzyme (kM is unaltered), whereas enzyme stimulation and competitive inhibition respectively decrease and increase the kM .

Apparent increase in enzyme activity can also occur by *enzyme induction*, i.e. synthesis of more enzyme protein. This cannot be called stimulation because the kM does not change. Many drugs induce microsomal enzymes (see p. 27).

Inhibition of enzymes is a common mode of drug action.

A. Nonspecific inhibition Many chemicals and drugs are capable of denaturing proteins. They alter the tertiary structure of any enzyme with which they come in contact and thus inhibit it. Heavy metal salts, strong acids and alkalis, alcohol, formaldehyde, phenol inhibit enzymes nonspecifically. Such inhibitors are too damaging to be used systemically.

B. Specific inhibition Many drugs inhibit a particular enzyme without affecting others. Such inhibition is either competitive or noncompetitive.

(i) Competitive (equilibrium type) The drug being structurally similar competes with the normal substrate for the catalytic binding site of the enzyme so that the product is not formed or a

nonfunctional product is formed (Fig. 4.1A), and a new equilibrium is achieved in the presence of the drug. Such inhibitors increase the kM but the V_{max} remains unchanged (Fig. 4.2), i.e. higher concentration of the substrate is required to achieve $\frac{1}{2}$ maximal reaction velocity, but if substrate concentration is sufficiently increased, it can displace the inhibitor and the same maximal reaction velocity can be attained.

- Physostigmine and neostigmine compete with acetylcholine for cholinesterase.
- Sulfonamides compete with PABA for bacterial folate synthetase.
- Moclobemide competes with catecholamines for monoamine oxidase-A (MAO-A).
- Captopril competes with angiotensin 1 for angiotensin converting enzyme (ACE).
- Finasteride competes with testosterone for 5α -reductase
- Letrozole competes with androstenedione and testosterone for the aromatase enzyme.
- Allopurinol competes with hypoxanthine for xanthine oxidase; is itself oxidized to alloxanthine (a non competitive inhibitor).
- Carbidopa and methyldopa compete with levodopa for dopa decarboxylase.

A *nonequilibrium type* of enzyme inhibition can also occur with drugs which react with the same catalytic site of the enzyme but either form strong covalent bonds or have such high affinity for the enzyme that the normal substrate is not able to displace the inhibitor, e.g.

- Organophosphates react covalently with the esteretic site of the enzyme cholinesterase.
- Methotrexate has 50,000 times higher affinity for dihydrofolate reductase than the normal substrate DHFA.

In these situations, kM is increased and V_{max} is reduced.

(ii) Noncompetitive The inhibitor reacts with an adjacent site and not with the catalytic site, but alters the enzyme in such a way that it loses its catalytic property. Thus, kM is unchanged but V_{max} is reduced. Examples are given in the box.

Noncompetitive inhibitor	Enzyme
Acetazolamide	— Carbonic anhydrase
Aspirin, indomethacin	— Cyclooxygenase
Disulfiram	— Aldehyde dehydrogenase
Omeprazole	— H ⁺ K ⁺ ATPase
Digoxin	— Na ⁺ K ⁺ ATPase
Theophylline	— Phosphodiesterase
Propylthiouracil	— Peroxidase in thyroid
Lovastatin	— HMG-CoA reductase
Sildenafil	— Phosphodiesterase-5

II. ION CHANNELS

Proteins which act as ion selective channels participate in transmembrane signaling and regulate intracellular ionic composition. This makes them a common target of drug action (Fig. 4.1B). Drugs can affect ion channels either through specific receptors (ligand gated ion channels, G-protein operated ion channels, *see* Fig. 4.4 and p. 48), or by directly binding to the channel and affecting ion movement through it, e.g. local anaesthetics which physically obstruct voltage sensitive Na⁺ channels (*See* Ch 26). In addition, certain drugs modulate opening and closing of the channels, e.g.:

- Quinidine blocks myocardial Na⁺ channels.
- Dofetilide and amiodarone block myocardial delayed rectifier K⁺ channel.
- Nifedipine blocks L-type of voltage sensitive Ca²⁺ channel.
- Nicorandil opens ATP-sensitive K⁺ channels.
- Sulfonylurea hypoglycaemics inhibit pancreatic ATP-sensitive K⁺ channels.
- Amiloride inhibits renal epithelial Na⁺ channels.
- Phenytoin modulates (prolongs the inactivated state of) voltage sensitive neuronal Na⁺ channel.
- Ethosuximide inhibits T-type of Ca²⁺ channels in thalamic neurones

III. TRANSPORTERS

Several substrates are translocated across membranes by binding to specific transporters

(carriers) which either facilitate diffusion in the direction of the concentration gradient or pump the metabolite/ion against the concentration gradient using metabolic energy (*see* p. 13–15; Fig. 2.5). Many drugs produce their action by directly interacting with the solute carrier (SLC) class of transporter proteins to inhibit the ongoing physiological transport of the metabolite/ion (Fig. 4.1C). Examples are:

- Desipramine and cocaine block neuronal reuptake of noradrenaline by interacting with norepinephrine transporter (NET).
- Fluoxetine (and other SSRIs) inhibit neuronal reuptake of 5-HT by interacting with serotonin transporter (SERT).
- Amphetamines selectively block dopamine reuptake in brain neurons by dopamine transporter (DAT).
- Reserpine blocks the granular reuptake of noradrenaline and 5-HT by the vesicular amine transporter.
- Hemicholinium blocks choline uptake into cholinergic neurones and depletes acetylcholine.
- The anticonvulsant tiagabine acts by inhibiting reuptake of GABA into brain neurones by GABA transporter GAT 1.
- Furosemide inhibits the Na⁺K⁺2Cl⁻ cotransporter in the ascending limb of loop of Henle.
- Hydrochlorothiazide inhibits the Na⁺Cl⁻ symporter in the early distal tubule.
- Probenecid inhibits active transport of organic acids (uric acid, penicillin) in renal tubules by interacting with organic anion transporter (OAT).

IV. RECEPTORS

The largest number of drugs do not bind directly to the effectors, *viz.* enzymes, channels, transporters, structural proteins, template biomolecules, etc. but act through specific regulatory macromolecules which control the above listed effectors. These regulatory macromolecules or the sites on them which bind and interact with the drug are called 'receptors'.

Receptor: It is defined as a macromolecule or binding site located on the surface or inside the effector cell that serves to recognize the signal molecule/drug and initiate the response to it, but itself has no other function.

Though, in a broad sense *all types* of target biomolecules, including the effectors (enzymes, channels, transporters, etc.) with which a drug can bind to produce its action have been denoted as 'receptors' by some authors, such designation tends to steal the specific meaning of this important term. If so applied, xanthine oxidase would be the 'receptor' for allopurinol, L-type Ca^{2+} channel would be the 'receptor' for nifedipine, serotonin transporter (SERT) would be the 'receptor' for fluoxetine; a connotation not in consonance with the general understanding of the term. It is therefore better to reserve the term 'receptor' for purely regulatory macromolecules which combine with and mediate the action of signal molecules including drugs.

The following terms are used in describing drug-receptor interaction:

Agonist An agent which activates a receptor to produce an effect similar to that of the physiological signal molecule.

Inverse agonist An agent which activates a receptor to produce an effect in the opposite direction to that of the agonist.

Antagonist An agent which prevents the action of an agonist on a receptor or the subsequent response, but does not have any effect of its own.

Partial agonist An agent which activates a receptor to produce submaximal effect but antagonizes the action of a full agonist.

Ligand (Latin: *ligare*—to bind) Any molecule which attaches selectively to particular receptors or sites. The term only indicates affinity or binding without regard to functional change: agonists and competitive antagonists are both ligands of the same receptor.

The overall scheme of drug action through receptors is depicted in Fig. 4.1D.

Basic evidences for drug action through receptors

(i) Many drugs exhibit structural specificity of action, i.e. specific chemical configuration is associated with a particular action, e.g. isopropyl substitution on the ethylamine side chain of sympathetic drugs produces compounds with marked cardiac and bronchial activity—most β adrenergic agonists and antagonists have this substitution. A 3 carbon internitrogen separation in the side chain of phenothiazines



results in antidopaminergic-antipsychotic compounds, whereas 2 carbon separation produces anticholinergic-antihistaminic compounds. Further, chiral drugs show stereospecificity in action, e.g. *levo* noradrenaline is 10 times more potent than *dextro* noradrenaline; *d*-propranolol is about 100 times less potent in blocking β receptors than the *l*-isomer, but both are equipotent local anaesthetics.

Thus, the cell must have some mechanism to recognize a particular chemical configuration and three dimensional structure.

(ii) Competitive antagonism is seen between specific agonists and antagonists. Langley in 1878 was so impressed by the mutual antagonism among two alkaloids pilocarpine and atropine that he proposed that both reacted with the same 'receptive substance' on the cell. Ehrlich (1900) observed quantitative neutralization between toxins and antitoxins and designated 'receptor' to be the anchoring group of the protoplasmic molecule for the administered compound.

(iii) It was calculated by Clark that adrenaline and acetylcholine produce their maximal effect on frog's heart by occupying only 1/6000th of the cardiac cell surface—thus, special regions of reactivity to such drugs must be present on the cell.

Receptor occupation theory

After studying quantitative aspects of drug action, Clark (1937) propounded a theory of drug action based on occupation of receptors by specific drugs and that the pace of a cellular function can be altered by interaction of these receptors with drugs which, in fact, are small molecular ligands. He perceived the interaction between the two molecular species, *viz.* drug (D) and receptor (R) to be governed by the law of mass action, and the effect (E) to be a direct function of the drug-receptor complex (DR) formed:



Subsequently, it has been realized that occupation of the receptor is essential but not itself sufficient to elicit a response; the agonist must also be able to activate (induce a conformational change in) the receptor. The ability to bind with the receptor designated as *affinity*, and the capacity to induce a functional change in the receptor designated as *intrinsic activity (IA)* or *efficacy* are independent properties. Competitive antagonists occupy the receptor but do not activate it. Moreover, certain drugs are partial agonists which occupy and submaximally activate the receptor. An all or none action is not a must at the receptor. A theoretical quantity (S) denoting strength of stimulus imparted to the cell was interposed in the Clark's equation:

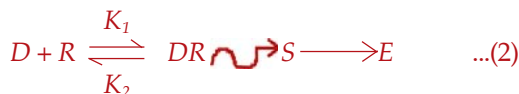

Depending on the agonist, DR could generate a stronger or weaker S, probably as a function of the conformational change brought about by the agonist in the receptor. Accordingly:

Agonists have both affinity and maximal intrinsic activity (IA = 1), e.g. adrenaline, histamine, morphine.

Competitive antagonists have affinity but no intrinsic activity (IA = 0), e.g. propranolol, atropine, chlorpheniramine, naloxone.

Partial agonists have affinity and submaximal intrinsic activity (IA between 0 and 1), e.g. dichloroisoproterenol (on β adrenergic receptor), pentazocine (on μ opioid receptor).

Inverse agonists have affinity but intrinsic activity with a minus sign (IA between 0 and -1), e.g. DMCM (on benzodiazepine receptor).

It has also been demonstrated that many full agonists can produce maximal response even while occupying <1% of the available receptors.

A large receptor reserve exists in their case, or a number of *spare receptors* are present.

The two-state receptor model

A very attractive alternative model for explaining the action of agonists, antagonists, partial agonists and inverse agonists has been proposed.

The receptor is believed to exist in two interchangeable states: *R_a* (active) and *R_i* (inactive) which are in equilibrium. In the case of majority of receptors, the *R_i* state is favoured at equilibrium—no/very weak signal is generated in the absence of the agonist—the receptor exhibits no constitutive activation (Fig. 4.3I). The agonist (A) binds preferentially to the *R_a* conformation and shifts the equilibrium $\rightarrow R_a$ predominates and a response is generated (Fig. 4.3II) depending on

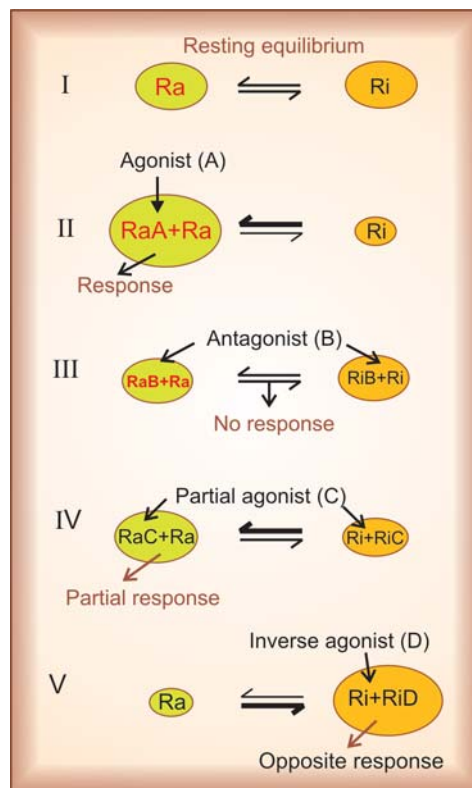

Fig. 4.3: Illustration of the two-state receptor model (see text for explanation)

the concentration of A. The competitive antagonist (B) binds to R_a and R_i with equal affinity \rightarrow the equilibrium is not altered \rightarrow no response is generated (Fig. 4.3 III), and when the agonist is applied fewer R_a are available to bind it—response to agonist is decreased. If an agonist has only slightly greater affinity for R_a than for R_i , the equilibrium is only modestly shifted towards R_a (Fig. 4.3 IV) even at saturating concentrations \rightarrow a submaximal response is produced and the drug is called a partial agonist (C). The inverse agonist (D) has high affinity for the R_i state (Fig. 4.3 V), therefore it can produce an opposite response, provided the resting equilibrium was in favour of the R_a state. Certain receptors (mainly G-protein coupled ones) such as benzodiazepine, histamine H_2 , angiotensin AT_1 , adrenergic β_1 and cannabinoid receptors exhibit constitutive activation, i.e. an appreciable intensity signal is generated even in the basal state (no agonist present). In their case the inverse agonist stabilizes the receptor in the inactive conformation resulting in an opposite response. Only few inverse agonists are known at present, but as more receptors with constitutive activation are found, more inverse agonists are likely to be discovered.

This model has gained wide acceptance because it provides an explanation for the phenomenon of positive cooperativity often seen with neurotransmitters, and is supported by studies of conformational mutants of the receptor with altered equilibrium.

Nature of receptors

Receptors are regulatory macromolecules, mostly proteins, though nucleic acids may also serve as receptors. They are no longer hypothetical. Hundreds of receptor proteins have been isolated, purified, cloned and their primary amino acid (AA) sequence has been worked out. Molecular cloning has also helped in obtaining the receptor protein in larger quantity to study its structure and properties, and in subclassifying receptors. The cell surface receptors with their coupling and

effector proteins are considered to be floating in a sea of membrane lipids; the folding, orientation and topography of the system being determined by interactions between the lipophilic and hydrophilic domains of the peptide chains with solvent molecules (water on one side and lipids on the other). Nonpolar portions of the AA chain tend to bury within the membrane, while polar groups tend to come out in the aqueous medium. In such a delicately balanced system, it is not difficult to visualize that a small molecular ligand binding to one site in the receptor molecule could be capable of tripping the balance (by altering distribution of charges, etc.) and bringing about conformational changes at distant sites. Each of the four major families of receptors (described later) have a well defined common structural motif, while the individual receptors differ in the details of amino acid sequencing, length of intra/extracellular loops, etc. Majority of receptor molecules are made up of several non-identical subunits (heteropolymeric), and agonist binding has been shown to bring about changes in their quaternary structure or relative alignment of the subunits, e.g. on activation the subunits of nicotinic receptor move apart opening a centrally located cation channel.

Radioligand binding studies have helped in characterizing and classifying receptors even when they have been dissociated from the effector system.

Many drugs act upon *physiological receptors* which mediate responses to transmitters, hormones, autacoids and other endogenous signal molecules; examples are cholinergic, adrenergic, histaminergic, steroid, leukotriene, insulin and other receptors. In addition, now some truly *drug receptors* have been described for which there are no known physiological ligands, e.g. benzodiazepine receptor, sulfonylurea receptor, cannabinoid receptor.

Receptor subtypes

The delineation of multiple types and subtypes of receptors for signal molecules has played an important role in the development of a number of

targeted and more selective drugs. Even at an early stage of evolution of receptor pharmacology, it was observed that actions of acetylcholine could be grouped into 'muscarinic' and 'nicotinic' depending upon whether they were mimicked by the then known alkaloids muscarine or nicotine. Accordingly, they were said to be mediated by two types of cholinergic receptors, *viz.* muscarinic (M) or nicotinic (N); a concept strengthened by the finding that muscarinic actions were blocked by atropine, while nicotinic actions were blocked by curare. In a landmark study, Ahlquist (1948) divided adrenergic receptors into ' α ' and ' β ' on the basis of two distinct rankorder of potencies of adrenergic agonists. These receptors have now been further subdivided ($M_1, M_2 \dots M_5$), (N_M, N_N) (α_1, α_2) ($\beta_1, \beta_2, \beta_3$). Multiple subtypes of receptors for practically all transmitters, autacoids, hormones, etc. are now known and have paved the way for introduction of numerous clinically superior drugs. In many cases, receptor classification has provided sound explanation for differences observed in the actions of closely related drugs.

The following criteria have been utilized in classifying receptors:

- a. **Pharmacological criteria** Classification is based on relative potencies of selective agonists and antagonists. This is the classical and oldest approach with direct clinical bearing; was used in delineating M and N cholinergic, α and β adrenergic, H_1 and H_2 histaminergic receptors, etc.
- b. **Tissue distribution** The relative organ/tissue distribution is the basis for designating the subtype, e.g. the cardiac β adrenergic receptors as β_1 , while bronchial as β_2 . This division was confirmed by selective agonists and antagonists as well as by molecular cloning.
- c. **Ligand binding** Measurement of specific binding of high affinity radio-labelled ligand to cellular fragments (usually membranes) *in vitro*, and its displacement by various selective agonists/antagonists is used to delineate receptor subtypes. Multiple 5-HT receptors were distinguished by this approach. Autoradiography has helped in mapping distribution of receptor subtypes in the brain and other organs.
- d. **Transducer pathway** Receptor subtypes may be distinguished by the mechanism through which their activation is linked to the response, e.g. M cholinergic receptor acts through G-proteins, while N cholinergic receptor gates influx of Na^+ ions; α adrenergic receptor

acts *via* IP_3 -DAG pathway and by decreasing cAMP, while β adrenergic receptor increases cAMP; GABA_A receptor is a ligand gated Cl^- channel, while GABA_B receptor increases K^+ conductance through a G-protein.

- e. **Molecular cloning** The receptor protein is cloned and its detailed amino acid sequence as well as three dimensional structure is worked out. Subtypes are designated on the basis of sequence homology. This approach has in the recent years resulted in a flood of receptor subtypes and several isoforms (which do not differ in ligand selectivity) of each subtype. The functional significance of many of these subtypes/isoforms is dubious. Even receptors without known ligands (orphan receptors) have been described.

Application of so many approaches has thrown up several detailed, confusing and often conflicting classifications of receptors. However, a consensus receptor classification is now decided on a continuing basis by an expert group of the International Union of Pharmacological Sciences (IUPHAR).

Silent receptors These are sites which bind specific drugs but no pharmacological response is elicited. They are better called *drug acceptors* or *sites of loss*, e.g. plasma proteins which have binding sites for many drugs. To avoid confusion, the term receptor should be restricted to those regulatory binding sites which are capable of generating a response.

ACTION-EFFECT SEQUENCE

'Drug action' and 'drug effect' are often loosely used interchangeably, but are not synonymous.

Drug action It is the initial combination of the drug with its receptor resulting in a conformational change in the latter (in case of agonists), or prevention of conformational change through exclusion of the agonist (in case of antagonists).

Drug effect It is the ultimate change in biological function brought about as a consequence of drug action, through a series of intermediate steps (transducer).

Receptors subserve two essential functions, *viz.* *recognition* of the specific ligand molecule and *transduction* of the signal into a response. Accordingly, the receptor molecule has a *ligand binding domain* (spatially and energetically suitable for binding the specific ligand) and an *effector domain* (Fig. 4.4) which undergoes a functional conformational change. These domains have

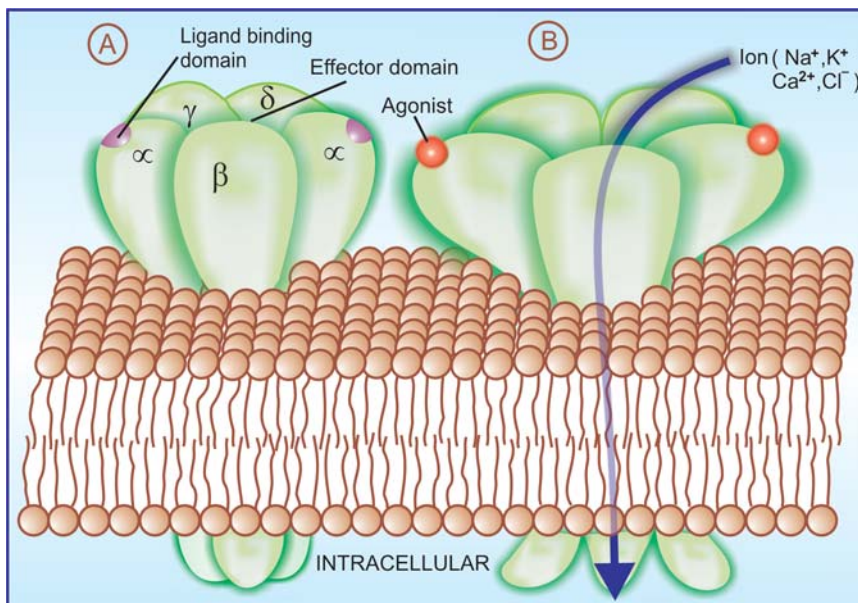

Fig. 4.4: Diagrammatic representation of receptor mediated operation of membrane ion channel.

In case of nicotinic cholinergic receptor, the molecule (8 nm in diameter) is composed of 5 subunits ($2\alpha + \beta + \gamma + \delta$) enclosing a cylindrical ion channel. Normally the channel is closed (A). When two molecules of acetylcholine bind to the two α subunits (B), all subunits move apart opening the central pore to 0.7 nm, enough to allow passage of partially hydrated Na^+ ions. Anions are blocked from passage through the channel by positive charges lining it. In other cases, K^+ , Ca^{2+} or Cl^- ions move through the channel depending on its ion selectivity.

now actually been identified in some receptors. The perturbation in the receptor molecule is variously translated into the response. The sequential relationship between drug action, transducer and drug effect can be seen in Fig. 4.1D and 4.6.

TRANSDUCER MECHANISMS

Considerable progress has been made in the understanding of transducer mechanisms which in most instances have been found to be highly complex multistep processes that provide for amplification and integration of concurrently received extra- and intra-cellular signals at each step. Because only a handful of transducer pathways are shared by a large number of receptors, the cell is able to generate an integrated response reflecting the sum total of diverse signal input. The transducer mechanisms can be grouped into 4 major categories. Receptors falling in one

category have also been found to possess considerable structural homology, and belong to one super family of receptors.

1. G-protein coupled receptors (GPCR)

These are a large family of cell membrane receptors which are linked to the effector (enzyme/channel/carrier protein) through one or more GTP-activated proteins (G-proteins) for response effectuation. All such receptors have a common pattern of structural organization (Fig. 4.5). The molecule has 7 α -helical membrane spanning hydrophobic amino acid (AA) segments which run into 3 extracellular and 3 intracellular loops. The agonist binding site is located somewhere between the helices on the extracellular face, while another recognition site formed by cytosolic segments binds the coupling G-protein. The G-proteins float in the membrane with their exposed

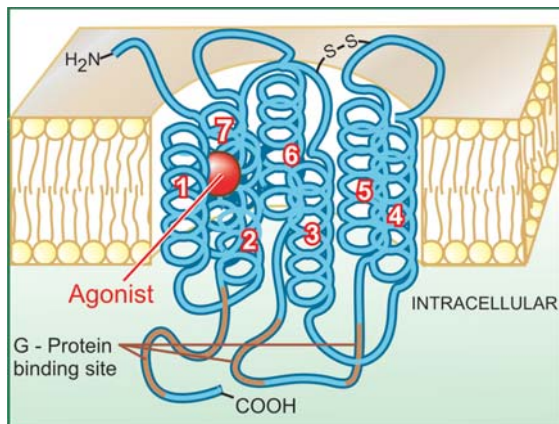

Fig. 4.5: Diagrammatic representation of G-protein coupled receptor molecule

The receptor consists of 7 membrane spanning helical segments of hydrophobic amino acids. The intervening segments connecting the helices form 3 loops on either side of the membrane. The amino terminus of the chain lies on the extracellular face, while the carboxy terminus is on the cytosolic side. The approximate location of the agonist and G-protein binding sites is indicated

domain lying in the cytosol, and are heterotrimeric in composition (α , β and γ subunits). In the inactive state GDP is bound to their exposed domain; activation through the receptor leads to displacement of GDP by GTP. The active α -subunit carrying GTP dissociates from the other two subunits and either activates or inhibits the effector. The $\beta\gamma$ subunits have also been shown to modulate certain effectors like receptor-operated K^+ channels, adenylylcyclase (AC) and phospholipase C.

A number of G proteins distinguished by their α subunits have been described. The important ones with their action on the effector are:

Gs	: Adenylyl cyclase \uparrow , Ca^{2+} channel \uparrow
Gi	: Adenylyl cyclase \downarrow , K^+ channel \uparrow
Go	: Ca^{2+} channel \downarrow
Gq	: Phospholipase C \uparrow
G ₁₃	: Na^+/H^+ exchange \uparrow

In addition Gn, Gk, Gt and G_{olf} have been distinguished. A limited number of G-proteins are shared between different receptors and one receptor can utilize more than one G-protein (agonist pleotropy), e.g. the following couplers have been associated with different receptors.

Receptor	Coupler
Muscarinic	Gi, Go, Gq
Dopamine D2	Gi, Go
β -adrenergic	Gs, Gi
α_1 -adrenergic	Gq
α_2 -adrenergic	Gi, Gs, Go
GABA _B	Gi, Go
5-HT	Gi, Gq, Gs, Gk

In addition, a receptor can utilize different biochemical pathways in different tissues.

The α -subunit has GTPase activity: the bound GTP is slowly hydrolysed to GDP: the α -subunit then dissociates from the effector to rejoin its other subunits, but not before the effector has been activated/inhibited for a few seconds and the signal has been amplified. The onset time of response through this type of receptors is also in seconds.

There are three major effector pathways (Table 4.1) through which GPCRs function.

(a) Adenylylcyclase: cAMP pathway Activation of AC results in intracellular accumulation of second messenger cAMP (Fig. 4.6) which functions mainly through cAMP-dependent protein kinase (PK_A). The PK_A phosphorylates and alters the function of many enzymes, ion channels, transporters and structural proteins to manifest as increased contractility/impulse generation (heart), relaxation (smooth muscle), glycogenolysis, lipolysis, inhibition of secretion/mediator release, modulation of junctional transmission, hormone synthesis, etc. In addition, cAMP directly opens a specific type of membrane Ca^{2+} channel called *cyclic nucleotide gated channel* (CNG) in the heart, brain and kidney. Responses opposite to the above are produced when AC is inhibited through inhibitory Gi-protein.

(b) Phospholipase C: IP₃-DAG pathway Activation of phospholipase C (PLC) hydrolyses the membrane phospholipid phosphatidylinositol 4, 5-bisphosphate (PIP₂) to generate the second messengers inositol 1,4,5-trisphosphate (IP₃) and diacylglycerol (DAG). The IP₃ mobilises Ca^{2+} from intracellular organellar depots and DAG enhances protein kinase C (PKc) activation by Ca^{2+} (Fig. 4.7). Cytosolic Ca^{2+} (third messenger in this

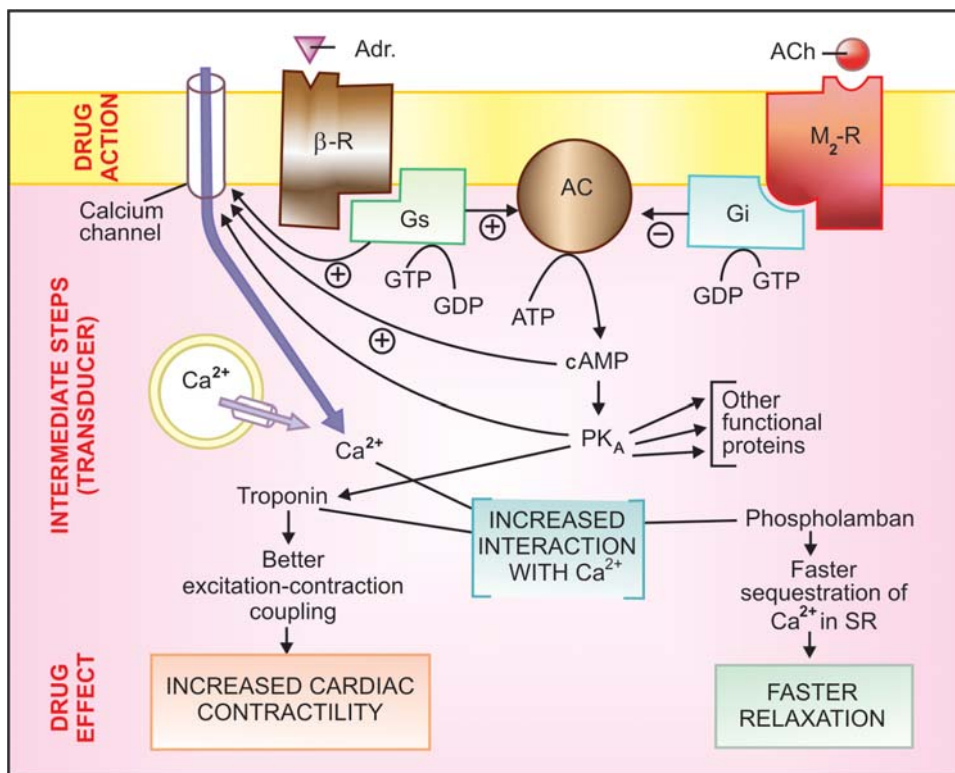

Fig. 4.6: The action-effect sequence of two G-protein coupled (β adrenergic and muscarinic M_2) receptor activation in myocardial cell

Adrenaline (Adr) binds to β -adrenergic receptor (β -R) on the cell surface inducing a conformational change which permits interaction of the G-protein binding site with the stimulatory G-protein (Gs). The activated Gs now binds GTP (in place of GDP), causing its active subunit to dissociate and in turn activate the enzyme adenylyl cyclase (AC) located on the cytosolic side of the membrane: ATP is hydrolysed to cAMP which phosphorylates and thus activates cAMP dependent protein kinase (PK_A). The PK_A phosphorylates many functional proteins including troponin and phospholamban, so that they interact with Ca^{2+} , respectively resulting in increased force of contraction and faster relaxation. Calcium is made available by entry from outside (direct activation of myocardial membrane Ca^{2+} channels by Gs and through their phosphorylation by PK_A) as well as from intracellular stores.

One of the other proteins phosphorylated by cAMP is phosphorylase kinase which then activates the enzyme phosphorylase resulting in breakdown of glycogen to be utilized as energy source for increased contractility.

Action of acetylcholine (ACh) on muscarinic M_2 receptor (M_2 -R), also located in the myocardial membrane, can similarly activate an inhibitory G-protein (Gi) which then opposes the activation of AC by Gs.

setting) is a highly versatile regulator acting through calmodulin (CAM), PKc and other effectors—mediates/modulates contraction, secretion/transmitter release, eicosanoid synthesis, neuronal excitability, intracellular movements, membrane function, metabolism, cell proliferation, etc. Like AC, the PLC can also be inhibited through inhibitory G-protein when directionally opposite responses would be expected.

Intracellular Ca^{2+} release has been found to occur in waves (Ca^{2+} mediated Ca^{2+} release from successive pools facilitated by inositol 1, 3, 4, 5-tetrakisphosphate— IP_4) and exhibits a variety of agonist and concentration dependent oscillatory patterns. The activation of different effectors may depend on the amplitude and pattern of these oscillations. Thus, the same intracellular messenger can trigger different responses depending on the nature and strength of the extracellular signal.

(c) Channel regulation The activated G-proteins can also open or close ionic channels

Table 4.1: Major functional pathways of G-protein coupled receptor transduction

Adenylyl cyclase: cAMP		Phospholipase IP ₃ -DAG	Channel regulation		
↑	↓		Ca ²⁺ ↑	Ca ²⁺ ↓	K ⁺ ↑
Adrenergic-β	Adrenergic-α ₂	Adrenergic-α ₁	Adrenergic-β ₁	Dopamine-D2	Adrenergic-α ₂
Histamine-H ₂	Muscarinic-M ₂	Histamine-H ₁	(Heart,	GABA _B	Muscarinic-M ₂
Dopamine-D1	Dopamine-D2	Muscarinic-M ₁ , M ₃	Sk.muscle)	Opioid-κ	Dopamine-D2
Glucagon	5-HT ₁	5-HT ₂		Adenosine-A ₁	5-HT _{1A}
FSH & LH	GABA _B	Vasopressin-Oxytocin		Somatostatin	GABA _B
ACTH	Opioid-μ, δ	Bradykinin-B ₂			Opioid-μ, δ
TSH	Angiotensin-AT ₁	Angiotensin-AT ₁			Adenosine-A ₁
Prostaglandin-EP ₂	Prostaglandin-EP ₃	Prostaglandin-FP, EP ₁ , EP ₃			
Prostacyclin-IP	Somatostatin	Thromboxane-TP			
Adenosine-A ₂	Adenosine-A ₁	Leukotriene			
		Cholecystokinin-Gastrin			
		PAF			

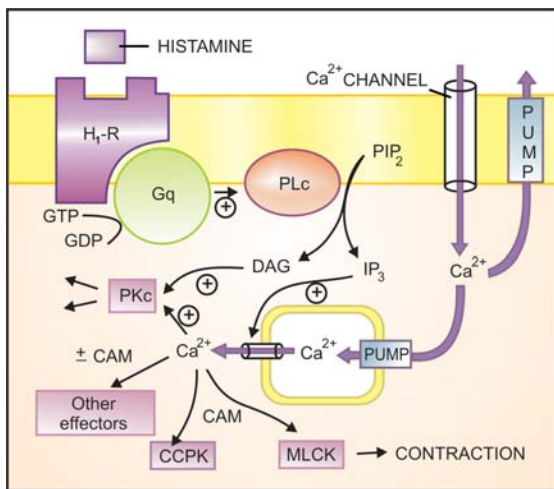
**Fig. 4.7:** The important steps of phospholipase C (PLC) pathway of response effectuation (in smooth muscle)

The agonist, e.g. histamine binds to its H₁ receptor (H₁ R) and activates the G-protein G_q, which in turn activates membrane bound phospholipase C (PLC) that hydrolyses phosphatidylinositol 4, 5-bisphosphate (PIP₂), a membrane bound phospholipid. The products inositol 1, 4, 5-trisphosphate (IP₃) and diacylglycerol (DAG) act as second messengers. The primary action of IP₃ is facilitation of Ca²⁺ mobilization from intracellular organellar pools, while DAG in conjunction with Ca²⁺ activates protein kinase C (PKC) which phosphorylates and alters the activity of a number of functional and structural proteins. Cytosolic Ca²⁺ is a veritable messenger: combines with calmodulin (CAM) to activate myosin light chain kinase (MLCK) inducing contraction, and another important regulator calcium-calmodulin protein kinase (CCPK). Several other effectors are regulated by Ca²⁺ in a CAM dependent or independent manner.

specific for Ca²⁺, K⁺ or Na⁺, without the intervention of any second messenger like cAMP or IP₃, and bring about hyperpolarization/depolarization/changes in intracellular Ca²⁺. The G_s opens Ca²⁺ channels in myocardium and skeletal muscles, while G_i and G_o open K⁺ channels in heart and smooth muscle as well as close neuronal Ca²⁺ channels. Physiological responses like changes in inotropy, chronotropy, transmitter release, neuronal activity and smooth muscle relaxation follow. Receptors found to regulate ionic channels through G-proteins are listed in Table 4.1.

2. Receptors with intrinsic ion channel

These cell surface receptors, also called *ligand gated ion channels*, enclose ion selective channels (for Na⁺, K⁺, Ca²⁺ or Cl⁻) within their molecules. Agonist binding opens the channel (Fig. 4.4) and causes depolarization/hyperpolarization/changes in cytosolic ionic composition, depending on the ion that flows through. The nicotinic cholinergic, GABA_A, glycine (inhibitory), excitatory AA (kainate, NMDA or N-methyl-D-aspartate, quisqualate) and 5HT₃ receptors fall in this category.

The receptor is usually a pentameric protein; all subunits, in addition to large intra- and extracellular segments, generally have four membrane spanning domains in each of which the AA chain traverses the width of the membrane six times. The subunits are thought to be arranged round the channel like a rosette and the α subunits usually bear the agonist binding sites.

Certain receptor-operated (or ligand-gated) ion channels also have secondary ligands which bind to an allosteric site and modulate the gating of the channel by the primary ligand, e.g. the benzodiazepine receptor modulates GABA_A gated Cl channel.

Thus, in these receptors, agonists directly operate ion channels, without the intervention of any coupling protein or second messenger. The onset and offset of responses through this class of receptors is the fastest (in milliseconds).

3. Enzyme-linked receptors

This class of receptors have a subunit with enzymatic property or bind a JAK (Janus-Kinase) enzyme on activation. The agonist binding site and the catalytic site lie respectively on the outer and inner face of the plasma membrane (Fig. 4.8). These two domains are interconnected through a single transmembrane stretch of peptide chain. There are two major subgroups of such receptors.

- Those that have intrinsic enzymatic activity.

- Those that lack intrinsic enzymatic activity, but bind a JAK-STAT kinase on activation.

a. Intrinsic enzyme receptors The intracellular domain is either a protein kinase or guanylyl cyclase.

In most cases the protein kinase specifically phosphorylates tyrosine residues on substrate proteins (Fig. 4.8A), e.g. insulin, epidermal growth factor (EGF), nerve growth factor (NGF) receptors, but in few it is a serine or threonine protein kinase. In the monomeric state, the kinase remains inactive. Agonist binding induces dimerization of receptor molecules and activates the kinase to autophosphorylate tyrosine residues on each other, increasing their affinity for binding substrate proteins and carrying forward the cascade of tyrosine phosphorylations. Intracellular events are triggered by phosphorylation of relevant proteins, many of which carry a SH₂ domain. A general feature of this class of receptors

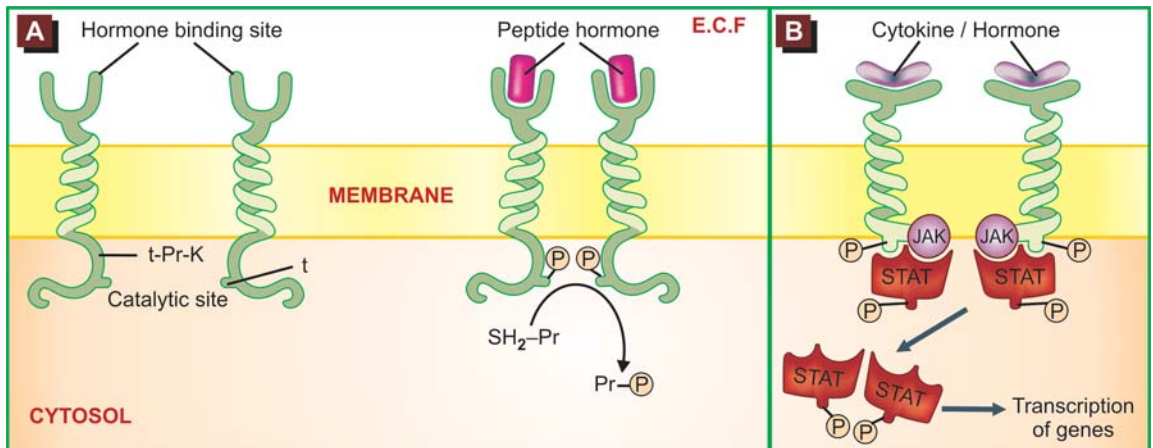

Fig. 4.8: Models of enzyme-linked receptors.

- Intrinsic tyrosine protein kinase receptor:** On binding the peptide hormone to the extracellular domains, the monomeric receptors move laterally in the membrane and form dimers. Dimerization activates tyrosine-protein kinase (t-Pr-K) activity of the intracellular domains so that they phosphorylate tyrosine (t) residues on each other, as well as on several SH₂ domain substrate proteins (SH₂-Pr). The phosphorylated substrate proteins then perform downstream signaling function.
- JAK-STAT kinase binding receptor:** The intracellular domain of these receptors lacks intrinsic protein kinase activity. Signal molecule binding to the extracellular domain induces receptor dimerization which activates the intracellular domain to bind free moving JAK (Janus Kinase) molecules. The activated JAK phosphorylate tyrosine residues on the receptor which then binds another protein STAT (signal transducer and activator of transcription). Tyrosine residues of STAT also get phosphorylated by JAK. The phosphorylated STAT dimerize, dissociate from the receptor and move to the nucleus to regulate transcription of target genes.

is that their dimerization also promotes receptor internalization, degradation in lysosomes and down regulation.

The enzyme can also be guanylyl cyclase (GC), as in the case of atrial natriuretic peptide (ANP). Agonist activation of the receptor generates cGMP in the cytosol as a second messenger which in turn activates cGMP-dependent protein kinase and modulates cellular activity.

b. JAK-STAT-kinase binding receptors These receptors differ in not having any intrinsic catalytic domain. Agonist induced dimerization alters the intracellular domain conformation to increase its affinity for a cytosolic tyrosine protein kinase JAK. On binding, JAK gets activated and phosphorylates tyrosine residues of the receptor, which now binds another free moving protein STAT (signal transducer and activator of transcription) which is also phosphorylated by JAK. Pairs of phosphorylated STAT dimerize and translocate to the nucleus to regulate gene transcription resulting in a biological response. Many cytokines, growth hormone, interferons, etc. act through this type of receptor.

The enzyme-linked receptors transduce responses in a matter of few minutes to a few hours.

4. Receptors regulating gene expression (Transcription factors)

In contrast to the above 3 classes of receptors, these are intracellular (cytoplasmic or nuclear) soluble proteins which respond to lipid soluble chemical messengers that penetrate the cell (Fig. 4.9). The receptor protein (specific for each hormone/regulator) is inherently capable of binding to specific genes, but is kept inhibited till the hormone binds near its carboxy terminus and exposes the DNA binding regulatory segment located in the middle of the molecule. Attachment of the receptor protein to the genes facilitates their expression so that specific mRNA is synthesized on the template of the gene. This mRNA moves to the ribosomes and directs synthesis of specific proteins which regulate the activity of target cells.

All steroidal hormones (glucocorticoids, mineralocorticoids, androgens, estrogens, progesterone), thyroxine, vit D and vit A function in this manner. Different steroidal hormones affect different target cells and produce different effects because each one binds to its own receptor and directs a unique pattern of synthesis of specific proteins. The specificity as to which hormone will be bound is provided by the hormone binding domain, while that as to which gene will be activated or repressed is a function of the DNA binding/N-terminus domain. Chimeric receptors have been produced which respond to one hormone, but produce the effects of the other hormone.

This transduction mechanism is the slowest in its time course of action (takes hours).

Receptor regulation

Receptors exist in a dynamic state; their density and efficacy is subject to regulation by the level of on going activity, feedback from their own signal output and other physiopathological influences. In tonically active systems, prolonged deprivation of the agonist (by denervation or continued use of an antagonist or a drug which reduces input) results in supersensitivity of the receptor as well as the effector system to the agonist. This has clinical relevance in clonidine/CNS depressant/opioid withdrawal syndromes, sudden discontinuation of propranolol in angina pectoris, etc. The mechanisms involved may be unmasking of receptors or their proliferation (*up regulation*) or accentuation of signal amplification by the transducer.

Conversely, continued/intense receptor stimulation causes desensitization or refractoriness: the receptor becomes less sensitive to the agonist. This can be easily demonstrated experimentally (Fig. 4.10); clinical examples are bronchial asthma patients treated continuously with β adrenergic agonists and parkinsonian patients treated with high doses of levodopa. The changes may be brought about by:

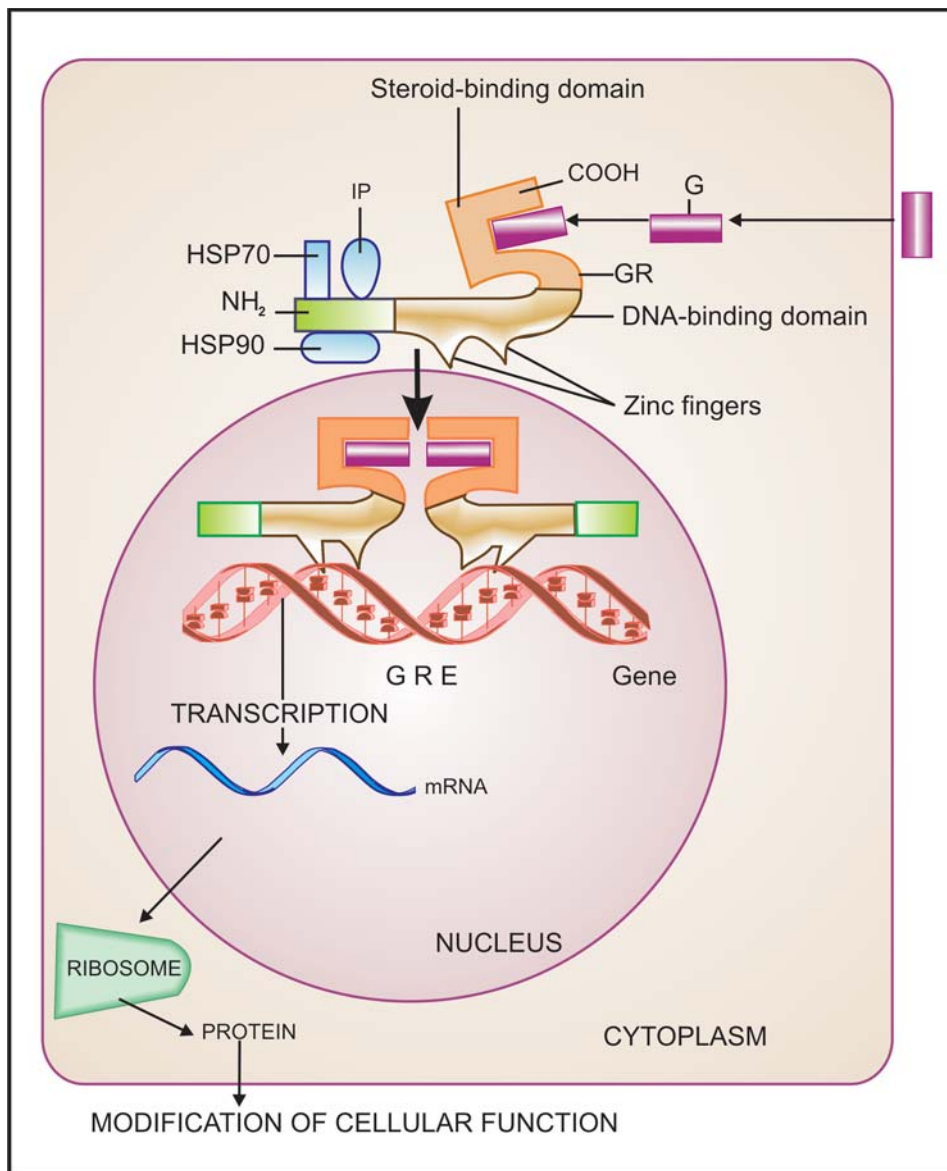

Fig. 4.9: Operational scheme of intracellular (glucocorticoid) receptor

The glucocorticoid (G) penetrates the cell membrane and binds to the glucocorticoid receptor (GR) protein that normally resides in the cytoplasm in association with 3 other proteins, viz. heat shock protein 90 (HSP90), HSP70 and immunophilin (IP). The GR has a steroid binding domain near the carboxy terminus and a mid region DNA binding domain having two 'zinc fingers', each made up of a loop of amino acids with chelated zinc ion. Binding of the steroid to GR dissociates the complexed proteins (HSP90, etc) removing their inhibitory influence on it. A dimerization region that overlaps the steroid binding domain is exposed, promoting dimerization of the occupied receptor. The steroid bound receptor dimer translocates to the nucleus and interacts with specific DNA sequences called 'glucocorticoid responsive elements' (GREs) within the regulatory region of appropriate genes. The expression of these genes is consequently altered resulting in promotion (or suppression) of their transcription. The specific mRNA thus produced is directed to the ribosome where the message is translated into a specific pattern of protein synthesis, which in turn modifies cell function.

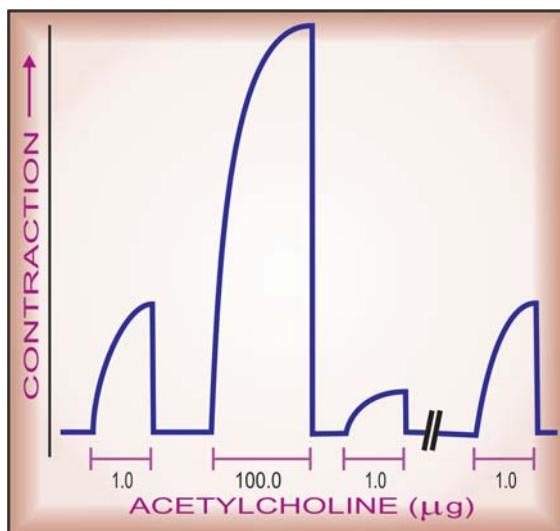

Fig. 4.10: Illustration of the phenomenon of desensitization

Contractile responses of frog's rectus abdominis muscle to acetylcholine. Note that shortly after exposure to a high (100 fold) dose of the agonist, the response is markedly attenuated, but is regained if sufficient time is allowed to elapse.

(i) Masking or internalization of the receptor (it becomes inaccessible to the agonist). In this case refractoriness develops as well as fades quickly.

In the case of β adrenergic receptor, it has been found that agonist binding promotes phosphorylation of its serine residues near the intracellular carboxy terminus by an enzyme β adrenergic receptor kinase (β ARK), allowing it to bind a protein called β -arrestin which hinders its interaction with Gs \rightarrow receptor transduction is impaired. When the β -agonist is removed, the serine residues are dephosphorylated and receptor mediated activation of Gs is restored.

(ii) Decreased synthesis/increased destruction of the receptor (*down regulation*): refractoriness develops over weeks or months and recedes slowly. Receptor down regulation is particularly exhibited by the tyrosine protein kinase receptors.

Some times response to all agonists which act through different receptors but produce the same overt effect (e.g. histamine and acetylcholine both contract intestinal smooth muscle) is decreased by exposure to any one of these agonists (heterologous desensitization), showing that mecha-

nisms of response effectuation have become less efficient. However, often desensitization is limited to agonists of the receptor being repeatedly activated (homologous desensitization).

Both homologous and heterologous desensitization has been observed in the case of GPCRs. The BARK- β arrestin mechanism described above produces homologous desensitization. The GPCRs transduce many responses by activating PK_A and PK_C. These kinases phosphorylate the GPCRs as well rather nonselectively (at a site different from that of BARK) and hinder their interaction with G-proteins, resulting in heterologous desensitization.

Functions of receptors These can be summarized as:

- To propagate regulatory signals from outside to within the effector cell when the molecular species carrying the signal cannot itself penetrate the cell membrane.
- To amplify the signal.
- To integrate various extracellular and intracellular regulatory signals.
- To adapt to short term and long term changes in the regulatory milieu and maintain homeostasis.

Nonreceptor-mediated drug action

This refers to drugs which do not act by binding to specific regulatory macromolecules. Drug action by purely physical or chemical means, interactions with small molecules or ions (antacids, chelating agents, cholestyramine, etc.), as well as direct interaction with enzymes, ionic channels and transporters has already been described. In addition, there are drugs like alkylating agents which react covalently with several critical biomolecules, especially nucleic acids, and have cytotoxic property useful in the treatment of cancer. Another important class of drugs are the antimetabolites (purine/pyrimidine analogues) which lead to production of non-functional or dysfunctional cellular components that exert antineoplastic, antiviral and immunosuppressant activity.

DOSE-RESPONSE RELATIONSHIP

When a drug is administered systemically, the dose-response relationship has two components:

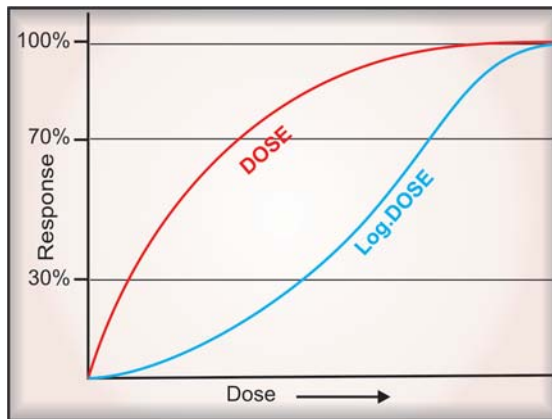

Fig. 4.11: Dose-response curves and log dose-response curves

dose-plasma concentration relationship and *plasma concentration-response* relationship. The former is determined by pharmacokinetic considerations and ordinarily, descriptions of dose-response relationship refer to the latter, which can be more easily studied *in vitro*.

Generally, the intensity of response increases with increase in dose (or more precisely concentration at the receptor) and the dose-response curve is a rectangular hyperbola (Fig. 4.11). This is because drug-receptor interaction obeys law of mass action, accordingly—

$$E = \frac{E_{max} \times [D]}{K_D + [D]} \quad \dots(3)$$

Where E is the observed effect at a dose [D] of the drug, E_{max} is the maximal response, K_D is the dissociation constant of the drug-receptor complex, which is equal to the dose of the drug at which half maximal response is produced. If the dose is plotted on a logarithmic scale, the curve becomes sigmoid and a linear relationship between log of dose and the response is seen in the intermediate (30–70% response) zone, as can be predicted from equation (3). This is not peculiar to drugs. In fact all stimuli are graded biologically by the fractional change in stimulus intensity, e.g. 1 kg and 2 kg weights held in two hands can be easily differentiated, but not 10 kg and 11 kg weights. Though the absolute difference remains

1kg, there is a 100% fractional change in the former case but only 10% change in the latter case. In other words, response is proportional to an exponential function (log) of the dose.

Other advantages of plotting log dose-response curves (DRC) are:

- (i) A wide range of drug doses can be easily displayed on a graph.
- (ii) Comparison between agonists and study of antagonists becomes easier.

Therapeutic window phenomenon

This is an unusual feature seen with certain drugs: optimal therapeutic effect is exerted only over a narrow range of plasma drug concentrations or drug doses; both below and above this range, beneficial effects are suboptimal, i.e., the effect declines if the doses are increased beyond a certain level. Examples are:

- Tricyclics (imipramine etc.) exert maximal antidepressant effect when their plasma concentration is maintained between 50–150 ng/ml.
- Clonidine lowers BP over a plasma concentration range of 0.2–2.0 ng/ml; BP may rise at concentrations above 2 ng/ml.
- Glipizide exerts poorer glycaemia control at doses > 25 mg/day.

The pharmacological basis of this phenomenon is not well understood, but may be due to dual or complex actions of the drug—different facets of which become prominent at different concentrations.

The log dose-response curve (DRC) can be characterized by its shape (slope and maxima) and position on the dose axis.

Drug potency and efficacy

The position of DRC on the dose axis is the index of *drug potency* which refers to the amount of drug needed to produce a certain response. A DRC positioned rightward indicates lower potency (Fig. 4.12). Relative potency is often more meaningful than absolute potency, and is generally defined by comparing the dose (concentration) of the two agonists at which they elicit half maximal response (EC_{50}). Thus, if 10 mg of morphine = 100 mg of pethidine as analgesic, morphine is 10 times more potent than pethidine. However, a higher potency, in itself, does not confer clinical

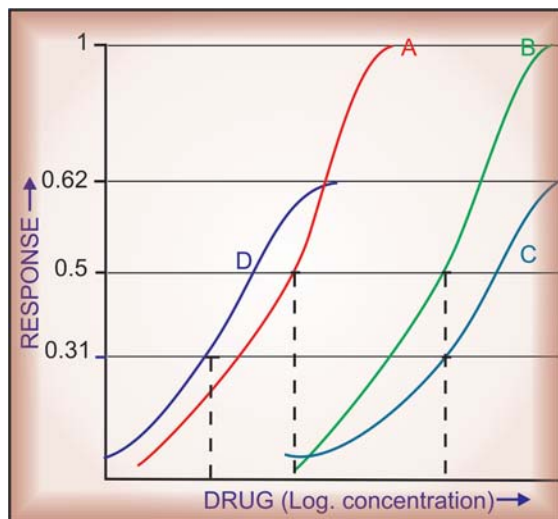

Fig. 4.12: Illustration of drug potency and drug efficacy. Dose-response curve of four drugs producing the same qualitative effect

Note:

Drug B is less potent but equally efficacious as drug A.

Drug C is less potent and less efficacious than drug A.

Drug D is more potent than drugs A, B, & C, but less efficacious than drugs A & B, and equally efficacious as drug C.

superiority unless the potency for therapeutic effect is selectively increased over potency for adverse effect.

The upper limit of DRC is the index of *drug efficacy* and refers to the maximal response that can be elicited by the drug, e.g. morphine produces a degree of analgesia not obtainable with any dose of aspirin—morphine is more efficacious than aspirin. Efficacy is a more decisive factor in the choice of a drug.

Often the terms 'drug potency' and 'drug efficacy' are used interchangeably, but these are not synonymous and refer to different characteristics of the drug. The two can vary independently:

- Aspirin is less potent as well as less efficacious analgesic than morphine.
- Pethidine is less potent but equally efficacious analgesic as morphine.
- Furosemide is less potent but more efficacious diuretic than metolazone.
- Diazepam is more potent but less efficacious CNS depressant than pentobarbitone.

Depending on the type of drug, both higher efficacy (as in the case of furosemide conferring utility in renal failure) or lower efficacy (as in the case of diazepam conferring safety in over-dose) could be clinically advantageous.

The slope of the DRC is also important. A steep slope indicates that a moderate increase in dose will markedly increase the response (dose needs individualization), while a flat one implies that little increase in response will occur over a wide dose range (standard doses can be given to most patients). Hydralazine has a steep, while hydrochlorothiazide has a flat DRC of antihypertensive effect (Fig. 4.13).

Selectivity

Drugs seldom produce just one action: the DRCs for different effects of a drug may be different. The extent of separation of DRCs of a drug for different effects is a measure of its selectivity, e.g. the DRCs for bronchodilatation and cardiac stimulation (Fig. 4.14) are quite similar in case of isoprenaline, but far apart in case of salbutamol—the latter is a more selective drug.

The gap between the therapeutic effect DRC and the adverse effect DRC defines the *safety margin* or the *therapeutic index* of a drug. In

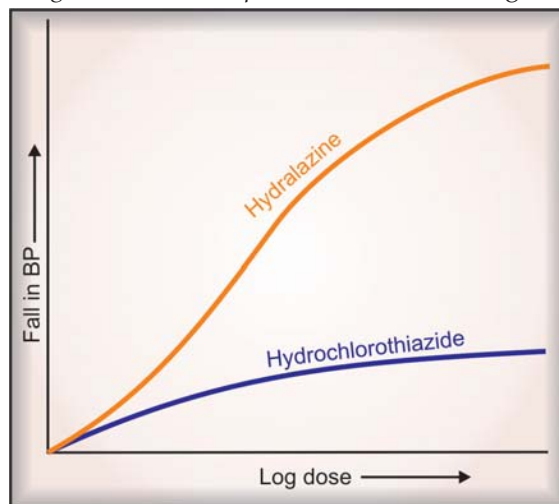

Fig. 4.13: Steep and flat dose-response curves illustrated by antihypertensive effect of hydralazine and hydrochlorothiazide

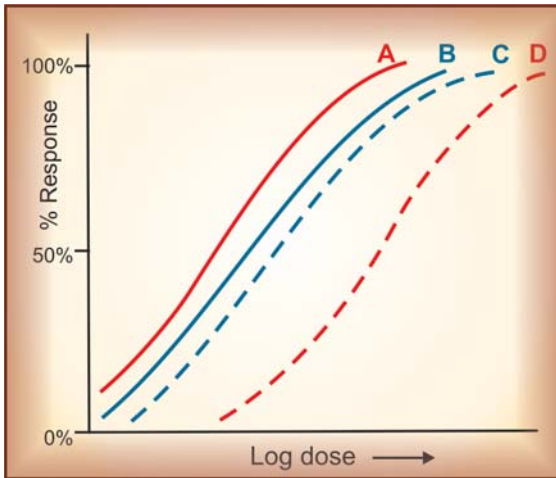

Fig. 4.14: Illustration of drug selectivity. Log dose-response curves of salbutamol for bronchodilatation (A) and cardiac stimulation (D) Log dose-response curves of isoprenaline for bronchodilatation (B) and cardiac stimulation (C)

experimental animals, therapeutic index is often calculated as:

$$\text{Therapeutic index} = \frac{\text{median lethal dose}}{\text{median effective dose}}$$

or

$$\frac{LD_{50}}{ED_{50}}$$

But this is irrelevant in the clinical set up where the *therapeutic range* is bounded by the dose which produces minimal therapeutic effect and the dose which produces maximal acceptable adverse effect (Fig. 4.15). Because of individual variability, the effective dose for some subjects may be toxic for others; defining the therapeutic range for many drugs is a challenging task. A drug may be capable of inducing a higher therapeutic response (have higher efficacy) but development of intolerable adverse effects may preclude use of higher doses, e.g. prednisolone in bronchial asthma.

Risk-benefit ratio This term is very frequently used, and conveys a judgement on the estimated harm (adverse effects, cost, inconvenience) *vs* expected advantages (relief of symptoms, cure, reduction of complications/mortality, improve-

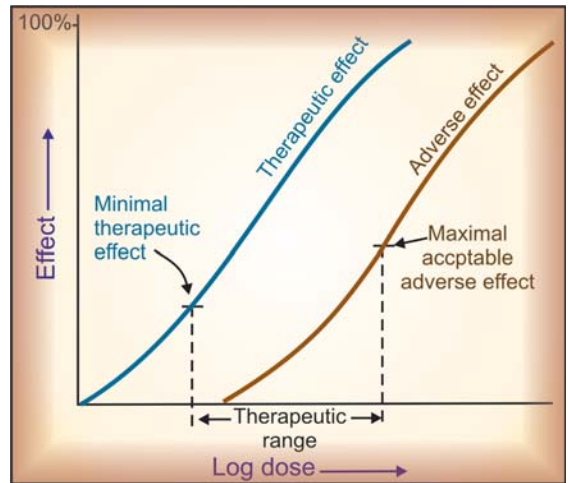

Fig. 4.15: Illustrative dose-response curves for therapeutic effect and adverse effect of the same drug

ment in quality of life). A drug should be prescribed only when the benefits outweigh the risks. However, risk-benefit ratio can hardly ever be accurately measured for each instance of drug use, because 'risk' is the probability of harm; and harm has to be qualified by its nature, quantum, time-course (transient to life-long) as well as the value that the patient attaches to it. None of these can be precisely ascertained. As such, the physician has to rely on data from use of drugs in large populations (pharmacoepidemiology) and his own experience of the drug and the patient.

COMBINED EFFECT OF DRUGS

When two or more drugs are given simultaneously or in quick succession, they may be either indifferent to each other or exhibit *synergism* or *antagonism*. The interaction may take place at pharmacokinetic level (see Ch. 2 and 3) or at pharmacodynamic level.

SYNERGISM

(Greek: *Syn*—together; *ergon*—work)

When the action of one drug is facilitated or increased by the other, they are said to be synergistic. In a synergistic pair, both the drugs can have action in the same direction or given alone

one may be inactive but still enhance the action of the other when given together. Synergism can be:

(a) Additive The effect of the two drugs is in the same direction and simply adds up:

$$\text{effect of drugs A + B} = \text{effect of drug A} + \text{effect of drug B}$$

Additive drug combinations

Aspirin + paracetamol	as analgesic/antipyretic
Nitrous oxide + halothane	as general anaesthetic
Amlodipine + atenolol	as antihypertensive
Glibenclamide + metformin	as hypoglycaemic
Ephedrine + theophylline	as bronchodilator

Side effects of the components of an additive pair may be different—do not add up. Thus, the combination is better tolerated than higher dose of one component.

(b) Supraadditive (potentiation) The effect of combination is greater than the individual effects of the components:

$$\text{effect of drug A + B} > \text{effect of drug A} + \text{effect of drug B}$$

This is always the case when one component is inactive as such.

Supraadditive drug combinations

<i>Drug pair</i>	<i>Basis of potentiation</i>
Acetylcholine + physostigmine	Inhibition of breakdown
Levodopa + carbidopa/benserazide	Inhibition of peripheral metabolism
Adrenaline + cocaine/desipramine	Inhibition of neuronal uptake
Sulfamethoxazole + trimethoprim	Sequential blockade
Antihypertensives (enalapril+ hydrochlorothiazide)	Tackling two contributory factors
Tyramine + MAO inhibitors	Increasing releasable CA store

ANTAGONISM

When one drug decreases or abolishes the action of another, they are said to be antagonistic:

$$\text{effect of drugs A + B} < \text{effect of drug A} + \text{effect of drug B}$$

Usually in an antagonistic pair one drug is inactive as such but decreases the effect of the other. Depending on the mechanism involved, antagonism may be:

(a) Physical antagonism Based on the physical property of the drugs, e.g. charcoal adsorbs alkaloids and can prevent their absorption—used in alkaloidal poisonings.

(b) Chemical antagonism The two drugs react chemically and form an inactive product, e.g.

- KMnO_4 oxidizes alkaloids—used for gastric lavage in poisoning.
- Tannins + alkaloids—insoluble alkaloidal tannate is formed.
- Chelating agents (BAL, Cal. disod. edetate) complex toxic metals (As, Pb).
- Nitrites form methaemoglobin which reacts with cyanide radical.

Drugs may react when mixed in the same syringe or infusion bottle:

- Thiopentone sod. + succinylcholine chloride
- Penicillin-G sod. + succinylcholine chloride
- Heparin + penicillin/tetracyclines/streptomycin/hydrocortisone

(c) Physiological/functional antagonism The two drugs act on different receptors or by different mechanisms, but have opposite overt effects on the same physiological function, i.e. have pharmacological effects in opposite direction, e.g.

- Histamine and adrenaline on bronchial muscles and BP.
- Hydrochlorothiazide and triamterene on urinary K^+ excretion.
- Glucagon and insulin on blood sugar level.

(d) Receptor antagonism One drug (antagonist) blocks the receptor action of the other (agonist). This is a very important mechanism of drug action, because physiological signal molecules act

through their receptors, blockade of which can produce specific and often profound pharmacological effects. Receptor antagonists are selective (relatively), i.e. an anticholinergic will oppose contraction of intestinal smooth muscle induced by cholinergic agonists, but not that induced by histamine or 5-HT (they act through a different set of receptors). Receptor antagonism can be competitive or noncompetitive.

Competitive antagonism (equilibrium type) The antagonist is chemically similar to the agonist, competes with it (Fig. 4.16 A, D) and binds to the same site to the exclusion of the agonist molecules. Because the antagonist has affinity but no intrinsic activity (*see p. 42*), no response is produced and the log DRC of the agonist is shifted to the right. Since antagonist binding is reversible and depends on the relative concentration of the agonist and antagonist molecules, higher concentration of the agonist progressively overcomes the block—a parallel shift of the agonist DRC with no suppression of maximal response is obtained (Fig. 4.17a). The extent of shift is dependent on the affinity and concentration of the antagonist.

A partial agonist (Fig. 4.16 C), having affinity for the same receptor, also competes with and antagonizes a full agonist, while producing a submaximal response of its own.

Noncompetitive antagonism The antagonist is chemically unrelated to the agonist, binds to a different *allosteric site* altering the receptor in such a way that it is unable to combine with the agonist (Fig. 4.16E), or unable to transduce the response, so that the downstream chain of events are uncoupled. Because the agonist and the antagonist are combining with different sites, there is no competition between them—even high agonist concentration is unable to reverse the block completely. Increasing concentrations of the antagonist progressively flatten the agonist DRC (Fig. 4.17b). Noncompetitive antagonists have been produced experimentally, but are not in clinical use.

Nonequilibrium (competitive) antagonism Certain antagonists bind to the receptor with strong

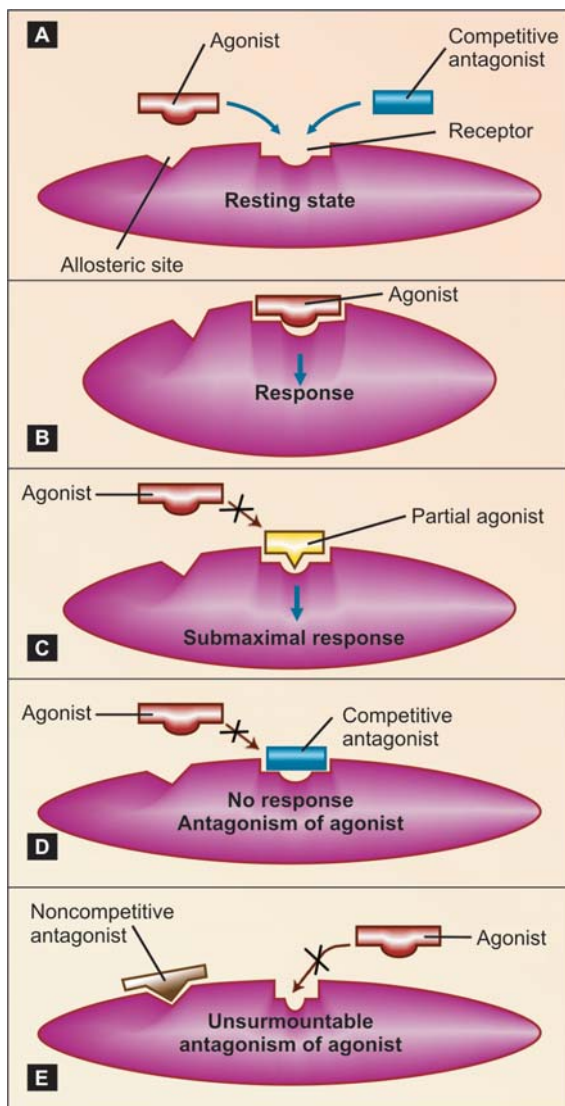

Fig. 4.16: Illustration of sites of action of agonists and antagonists (A), and the action of full agonist (B), partial agonist (C), competitive antagonist (D) and noncompetitive antagonist (E) on the receptor

(covalent) bonds or dissociate from it slowly so that agonist molecules are unable to reduce receptor occupancy of the antagonist molecules—law of mass action cannot apply—an irreversible or nonequilibrium antagonism is produced. The agonist DRC is shifted to the right and the maximal response is lowered (if spare receptors

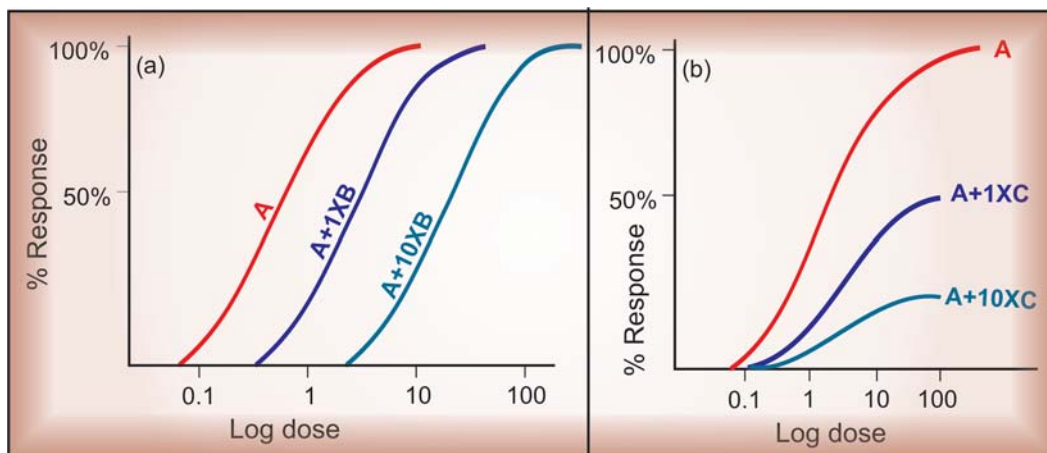

Fig. 4.17: Dose-response curves showing competitive (a) and noncompetitive (b) antagonism
 A—agonist, B—competitive antagonist, C—noncompetitive antagonist

are few). Since flattening of agonist DRC is a feature of noncompetitive antagonism; nonequilibrium antagonism has also been called 'a type of noncompetitive antagonism'. This appears inappropriate because the antagonist is binding to the

same site as the agonist. Phenoxybenzamine is a nonequilibrium antagonist of adrenaline at the α adrenergic receptors.

Features of competitive and noncompetitive antagonism are compared below:

Competitive (equilibrium type)	Noncompetitive
1. Antagonist binds with the same receptor as the agonist	Binds to another site of receptor
2. Antagonist resembles chemically with the agonist	Does not resemble
3. Parallel rightward shift of agonist DRC	Flattening of agonist DRC
4. The same maximal response can be attained by increasing dose of agonist (surmountable antagonism)	Maximal response is suppressed (unsurmountable antagonism)
5. The antagonist appears to have inactivated a certain number of agonist molecules	The antagonist appears to have inactivated a certain number of receptors
6. Intensity of response depends on the concentration of both agonist and antagonist	Maximal response depends only on the concentration of antagonist
7. Examples: ACh—Atropine Morphine—Naloxone	Diazepam—Bicuculline



CHAPTER 5

Aspects of Pharmacotherapy; Clinical Pharmacology and Drug Development

Pharmaco- (drug) therapy is dynamic and an ever evolving science. It requires understanding of the drug, the disease, the patient and the milieu in which it is undertaken. As such, in addition to knowledge of drug action, mechanisms and pharmacokinetics, several aspects like drug dosage, sources of variability in drug response, pharmacogenetics, influence of disease on drug action, etc. are important to optimum drug therapy.

DRUG DOSAGE

'Dose' is the appropriate amount of a drug needed to produce a certain degree of response in a patient. Accordingly, dose of a drug has to be qualified in terms of the chosen response, e.g. the analgesic dose of aspirin for headache is 0.3–0.6 g, its antiplatelet dose is 60–150 mg/day, while its antiinflammatory dose for rheumatoid arthritis is 3–5 g per day. Similarly there could be a *prophylactic dose*, a *therapeutic dose* or a *toxic dose* of the same drug.

The dose of a drug is governed by its inherent potency, i.e. the concentration at which it should be present at the target site, and its pharmacokinetic characteristics. The recommended doses are based on population data and cater to an 'average' patient. However, individual patients

may not be 'average' in respect to a number of pharmacokinetic and pharmacodynamic parameters, emphasizing the need for individualizing drug dose. The strategies adopted for different types of drugs and conditions are:

1. Standard dose The same dose is appropriate for most patients—individual variations are minor or the drug has a wide safety margin so that large enough dose can be given to cover them, e.g. oral contraceptives, penicillin, chloroquine, mebendazole, amantadine.

2. Regulated dose The drug modifies a finely regulated body function which can be easily measured. The dosage is accurately adjusted by repeated measurement of the affected physiological parameter, e.g. antihypertensives, hypoglycaemics, anticoagulants, diuretics, general anaesthetics. In their case, measurement of plasma drug concentration is not needed.

3. Target level dose (*see p. 34*) The response is not easily measurable but has been demonstrated to be obtained at a certain range of drug concentration in plasma. An empirical dose aimed at attaining the target level is given in the beginning and adjustments are made later by actual monitoring of plasma concentrations. When facilities for drug level monitoring are not

available, crude adjustments are made by observing the patient at relatively long intervals, e.g. antidepressants, antiepileptics, digoxin, lithium, theophylline.

4. Titrated dose The dose needed to produce maximal therapeutic effect cannot be given because of intolerable adverse effects. Optimal dose is arrived at by titrating it with an acceptable level of adverse effect. Low initial dose and upward titration (in most non-critical situations) or high initial dose and downward titration (in critical situations) can be practised. Often a compromise between submaximal therapeutic effect but tolerable side effects can be struck, e.g. anticancer drugs, corticosteroids, levodopa.

Fixed dose ratio combination preparations

A large number of pharmaceutical preparations contain two or more drugs in a fixed dose ratio. *Advantages* offered by these are:

1. Convenience and better patient compliance—when all the components present in a formulation are actually needed by the patient. It may also be cost saving compared to both/all the components administered separately.
2. Certain drug combinations are synergistic, e.g. sulfamethoxazole + trimethoprim; levodopa + carbidopa/benserazide; combination oral contraceptives.
3. The therapeutic effect of two components being same may add up while the side effects being different may not, e.g. amlodipine + atenolol as antihypertensive.
4. The side effect of one component may be counteracted by the other, e.g. a thiazide + a potassium sparing diuretic. However, the amount of the latter may not be sufficient in all cases.
5. Combined formulation ensures that a single drug will *not* be administered. This is important in the treatment of tuberculosis and HIV-AIDS.

Before prescribing a combination, the physician must consider whether any of the ingredients

is unnecessary; if it is, the combination should not be prescribed. It can never be justified that a drug is given to a patient who does not need it in order to provide him another one that he needs.

There are many inbuilt *disadvantages* of fixed dose ratio combinations:

1. The patient may not actually need all the drugs present in a combination: he is subjected to additional side effects and expense (often due to ignorance of the physician about the exact composition of the combined formulations).
2. The dose of most drugs needs to be adjusted and individualised. When a combined formulation is used, this cannot be done without altering the dose of the other component(s).
3. The time course of action of the components may be different: administering them at the same intervals may be inappropriate.
4. Altered renal or hepatic function of the patient may differently affect the pharmacokinetics of the components.
5. Adverse effect, when it occurs, cannot be easily ascribed to the particular drug causing it.
6. Contraindication to one component (allergy, other conditions) contraindicates the whole preparation.
7. Confusion of therapeutic aims and false sense of superiority of two drugs over one is fostered, specially in case of antimicrobials whose combinations should be avoided. Corticosteroids should never be combined with any other drug meant for internal use. Drug combinations that are banned in India are listed in Appendix 4.

Thus, only a handful of fixed dose ratio combinations are rational and justified, while far too many are available and vigorously promoted. In fact, the latest WHO essential medicines list incorporates only 21 fixed dose ratio combinations (*see* Appendix-1).

FACTORS MODIFYING DRUG ACTION

Variation in response to the same dose of a drug between different patients and even in the same patient on different occasions is a rule rather than exception. One or more of the following categories of differences among individuals are responsible for the variations in drug response:

- (1) Individuals differ in pharmacokinetic handling of drugs: attain varying plasma/target site concentration of the drug. This is more marked for drugs disposed by metabolism (e.g. propranolol) than for drugs excreted unchanged (e.g. atenolol).
- (2) Variations in number or state of receptors, coupling proteins or other components of response effectuation.
- (3) Variations in neurogenic/hormonal tone or concentrations of specific constituents, e.g. atropine tachycardia depends on vagal tone, propranolol bradycardia depends on sympathetic tone, captopril hypotension depends on body Na⁺ status.

A multitude of host and external factors influence drug response. They fall in two categories *viz* genetic and nongenetic including all environmental, circumstantial and personal variables. Though individual variation cannot be totally accounted for by these factors, their understanding can guide the choice of appropriate drug and dose for an individual patient. However, final adjustments have to be made by observing the response in a given patient on a given occasion.

The factors modify drug action either:

- (a) **Quantitatively** The plasma concentration and/or the action of the drug is increased or decreased. Most of the factors introduce this type of change and can be dealt with by adjustment of drug dosage.
- (b) **Qualitatively** The type of response is altered, e.g. drug allergy or idiosyncrasy. This is less common but often precludes further use of that drug in the affected patient.

The various factors are discussed below—

1. Body size It influences the concentration of the drug attained at the site of action. The average adult dose refers to individuals of medium built. For exceptionally obese or lean individuals and for children dose may be calculated on body weight (BW) basis:

$$\text{Individual dose} = \frac{\text{BW (kg)}}{70} \times \text{average adult dose}$$

It has been argued that body surface area (BSA) provides a more accurate basis for dose calculation, because total body water, extracellular fluid volume and metabolic activity are better paralleled by BSA.

$$\text{Individual dose} = \frac{\text{BSA (m}^2\text{)}}{1.7} \times \text{average adult dose}$$

The BSA of an individual can be calculated from Dubois formula:

$$\text{BSA (m}^2\text{)} = \text{BW (kg)}^{0.425} \times \text{Height (cm)}^{0.725} \times 0.007184$$

or obtained from chart-form or slide-rule nomograms based on BW and height.

However, dose recommendations in terms of BSA are available only for anticancer and a handful of other drugs: for the rest BW has been used as the index. Thus, prescribing on BSA basis suffers from lack of data base, is more cumbersome and has not thrived, except in few cases.

2. Age The dose of a drug for children is often calculated from the adult dose

$$\text{Child dose} = \frac{\text{Age}}{\text{Age} + 12} \times \text{adult dose} \dots (\text{Young's formula})$$

$$\text{Child dose} = \frac{\text{Age}}{20} \times \text{adult dose} \dots (\text{Dilling's formula})$$

It can also be calculated (more accurately) on BW or BSA basis (*see* above), and for many drugs, manufacturers give dosage recommendations on mg/kg basis. Average figures for children are given below.

Age	Ideal BW (Kg)	BSA (m ²)	% of Adult dose
Newborn	3.2	0.23	12.5
1 month	4.0	0.26	15
3 months	5.5	0.32	18
6 months	7.5	0.4	22
1 year	10	0.47	25
3 years	14	0.62	33
5 years	18	0.73	40
7 years	23	0.88	50
12 years	37	1.25	75

However, *infants* and *children* are not small adults. They have important physiological differences from adults. The *newborn* has low g.f.r. and tubular transport is immature. As such, the $t_{1/2}$ of drugs excreted by glomerular filtration (gentamicin) and tubular secretion (penicillin) is prolonged by 3 to 5 times. Glomerular filtration reaches adult rates by 5 month of age and tubular secretion takes about 7 months to mature. Similarly, hepatic drug metabolizing system is inadequate in newborns—chloramphenicol can produce *gray baby syndrome*. Blood-brain barrier is more permeable—drugs attain higher concentration in the CNS (accumulation of unconjugated bilirubin causes *kernicterus*). These defects are exaggerated in the premature infant. Drug absorption may also be altered in infants because of lower gastric acidity and slower intestinal transit. Transdermal absorption however, is faster because their skin is thin and more permeable. Therefore, infant doses must be learned as such and not derived from any formula.

After the first year of life, drug metabolism is often faster than in adults, e.g. theophylline, phenytoin, carbamazepine $t_{1/2}$ is shorter in children. Also, higher per kg dose is needed for drugs which are primarily excreted unchanged by kidney, e.g. daily dose of digoxin is about 8–12 $\mu\text{g}/\text{kg}$ compared to adult dose of 3–5 $\mu\text{g}/\text{kg}$.

Solid dosage forms and aerosol inhalations are difficult to administer to young children.

Children are growing and are susceptible to special adverse effects of drugs, e.g. suppression

of growth can occur with corticosteroids; androgens may promote early fusion of epiphysis resulting in stunting of stature; tetracyclines get deposited in growing teeth and discolour/deform them. Dystonic reactions to phenothiazines are more common in children.

Elderly In the elderly, renal function progressively declines (intact nephron loss) so that g.f.r. is ~ 75% at 50 years and ~ 50% at 75 years age compared to young adults. Drug doses have to be reduced, e.g. daily dose of streptomycin is 0.75 g after 50 years and 0.5 g after 70 years of age compared to 1 g for young adults. There is also a reduction in the hepatic microsomal drug metabolizing activity and liver blood flow: oral bioavailability of drugs with high hepatic extraction is generally increased, but the overall effects on drug metabolism are not uniform. Due to lower renal as well as metabolic clearance, the elderly are prone to develop cumulative toxicity while receiving prolonged medication. Other affected aspects of drug handling are slower absorption due to reduced motility of and blood flow to intestines, lesser plasma protein binding due to lower plasma albumin, increased or decreased volume of distribution of lipophilic and hydrophilic drugs respectively. Aged are relatively intolerant to digitalis. The responsiveness of β adrenergic receptors to both agonists and antagonists is reduced in the elderly and sensitivity to other drugs also may be altered. Due to prostatism in elderly males, even mild anticholinergic activity of the drug can accentuate bladder voiding difficulty. Elderly are also likely to be on multiple drug therapy for hypertension, ischaemic heart disease, diabetes, arthritis, etc. which increases many fold the chances of drug interactions. They are more prone to develop postural instability, giddiness and mental confusion. In general, the incidence of adverse drug reactions is much higher in the elderly.

3. Sex Females have smaller body size and require doses that are on the lower side of the range. Subjective effects of drugs may differ in

females because of their mental makeup. Maintenance treatment of heart failure with digoxin is reported to be associated with higher mortality among women than among men. A number of antihypertensives (clonidine, methyl-dopa, β -blockers, diuretics) interfere with sexual function in males but not in females. Gynaecomastia is a side effect (of ketoconazole, metoclopramide, chlorpromazine, digitalis) that can occur only in men. Ketoconazole causes loss of libido in men but not in women. Obviously androgens are unacceptable to women and estrogens to men. In women consideration must also be given to menstruation, pregnancy and lactation.

Drugs given during pregnancy can affect the foetus (see Ch. 6 and Appendix-2). There are marked and progressive physiological changes during pregnancy, especially in the third trimester, which can alter drug disposition.

- (i) Gastrointestinal motility is reduced \rightarrow delayed absorption of orally administered drug.
- (ii) Plasma and extracellular fluid volume expands—volume of drug distribution may increase.
- (iii) While plasma albumin level falls, that of α_1 acid glycoprotein increases—the unbound fraction of acidic drugs increases but that of basic drugs decreases.
- (iv) Renal blood flow increases markedly—polar drugs are eliminated faster.
- (v) Hepatic microsomal enzymes undergo induction—many drugs are metabolized faster.

Thus, the overall effect on drug disposition is complex and often difficult to predict.

4. Species and race There are many examples of differences in responsiveness to drugs among different species; rabbits are resistant to atropine, rats and mice are resistant to digitalis and rat is more sensitive to curare than cat. These differences are important while extrapolating results from experimental animals to man.

Among human beings some racial differences have been observed, e.g. blacks require higher and

mongols require lower concentrations of atropine and ephedrine to dilate their pupil. β -blockers are less effective as antihypertensive in Afro-Caribbeans. Indians tolerate thiacetazone better than whites. Considering the widespread use of chloramphenicol in India and Hong Kong, relatively few cases of aplastic anaemia have been reported compared to its incidence in the west. Similarly, quiniodochlor related cases of subacute myelo optic neuropathy (SMON) occurred in epidemic proportion in Japan, but there is no confirmed report of its occurrence in India despite extensive use.

5. Genetics The dose of a drug to produce the same effect may vary by 4–6 fold among different individuals. All key determinants of drug response, viz. transporters, metabolizing enzymes, ion channels, receptors with their couplers and effectors are controlled genetically. Hence, a great deal of individual variability can be traced to the genetic composition of the subject. The study of genetic basis for variability in drug response is called 'Pharmacogenetics'. It deals with genetic influences on drug action as well as on drug handling by the body. As the genomic technology has advanced, gene libraries and huge data bases (like 'pharmacogenetics and pharmacogenomics knowledge base', 'Human genome variation database', etc.) have been created aiming at improving precision in drug therapy.

Pharmacogenomics is the use of genetic information to guide the choice of drug and dose on an individual basis. It intends to identify individuals who are either more likely or less likely to respond to a drug, as well as those who require altered dose of certain drugs. Attempt is made to define the genetic basis of an individual's profile of drug response and to predict the best treatment option for him/her. So far, this has been applied largely to patients with known genetic abnormalities, but the goal is 'personalized medicine' on a wide scale. However, a large proportion of genetic variability still remains unaccounted for.

A continuous variation with Gaussian frequency distribution is seen in the case of most drugs. In addition, there are some specific genetic defects which lead to discontinuous variation in drug responses, e.g.—

- a. Atypical pseudocholinesterase results in prolonged succinylcholine apnoea.
- b. G-6-PD deficiency is responsible for haemolysis with primaquine and other oxidizing drugs like sulfonamides, dapson, quinine, nalidixic acid, nitrofurantoin and menadione, etc.
- c. The low activity CYP2C9 variants metabolize warfarin at a slow rate and are at higher risk of bleeding.
- d. Thiopurine methyl transferase (TPMT) deficiency increases risk of severe bone marrow toxicity of 6-mercaptopurine and azathioprine.
- e. Irinotecan induced neutropenia and diarrhoea is more in patients with UGT1A1 *28 allele of glucuronyl transferase.
- f. Severe 5-fluorouracil toxicity occurs in patients with dihydropyrimidine dehydrogenase (DPD) deficiency.
- g. Over expression of P-gp results in tumour resistance to many cancer chemotherapeutic drugs, because it pumps out the drug from the tumour cells.
- h. Polymorphism of N-acetyl transferase 2 (NAT2) gene results in rapid and slow acetylator status. Isoniazid neuropathy, procainamide and hydralazine induced lupus occurs mainly in slow acetylators.
- i. Acute intermittent porphyria—precipitated by barbiturates is due to genetic defect in repression of porphyrin synthesis.
- j. CYP2D6 abnormality causes poor metoprolol/debrisoquin metabolizer status. Since several antidepressants and antipsychotics also are substrates of CYP2D6, deficient patients are more likely to experience their toxicity. Codeine fails to produce analgesia in CYP2D6 deficient, because this enzyme generates morphine from codeine.
- k. Malignant hyperthermia after halothane is due to abnormal Ca^{2+} release channel (ryanodine

receptor) in the sarcoplasmic reticulum of skeletal muscles.

- l. Inability to hydroxylate phenytoin results in toxicity at usual doses.
- m. Resistance to coumarin anticoagulants is due to an abnormal enzyme (that regenerates the reduced form of vit. K) which has low affinity for the coumarins.
- n. Attack of angle closure glaucoma is precipitated by mydriatics in individuals with narrow iridocorneal angle.

Genotype to phenotype predictability is much better in monogenic phenotypic traits such as G-6-PD, CYP2D6, TPMT, etc., than for multigenic traits. Majority of gene polymorphisms are due to substitution of a single base pair by another. When found in the population at a frequency of >1%, these are called 'Single nucleotide polymorphisms' (SNPs). Gene polymorphisms are often encountered at different frequencies among different ethnic/geographical groups.

Despite accumulation of considerable pharmacogenomic data and the fact that genotyping of the individual needs to be done only once, its practical application in routine patient care is at present limited due to prerequisite of multiple drug specific genotypic screening. Simple spot tests for some, e.g. G-6 PD deficiency are currently in use.

6. Route of administration Route of administration governs the speed and intensity of drug response (*see* Ch. 1). Parenteral administration is often resorted to for more rapid, more pronounced and more predictable drug action. A drug may have entirely different uses through different routes, e.g. magnesium sulfate given orally causes purgation, applied on sprained joints—decreases swelling, while intravenously it produces CNS depression and hypotension.

7. Environmental factors and time of administration Several environmental factors affect drug responses. Exposure to insecticides, carcinogens, tobacco smoke and consumption of charcoal broiled meat are well known to induce drug metabolism. Type of diet and temporal relation

between drug ingestion and meals can alter drug absorption, e.g. food interferes with absorption of ampicillin, but a fatty meal enhances absorption of griseofulvin. Subjective effects of a drug may be markedly influenced by the setup in which it is taken. Hypnotics taken at night and in quiet, familiar surroundings may work more easily. It has been shown that corticosteroids taken as a single morning dose cause less pituitary-adrenal suppression.

8. Psychological factor Efficacy of a drug can be affected by patient's beliefs, attitudes and expectations. This is particularly applicable to centrally acting drugs, e.g. a nervous and anxious patient requires more general anaesthetic; alcohol generally impairs performance but if punishment (which induces anxiety) is introduced, it may actually improve performance.

Placebo This is an inert substance which is given in the garb of a medicine. It works by psychological rather than pharmacological means and often produces responses equivalent to the active drug. Some individuals are more suggestible and easily respond to a placebo—'placebo reactors'. Placebos are used in two situations:

1. As a control device in clinical trial of drugs (dummy medication).
2. To treat a patient who, in the opinion of the physician, does not require an active drug.

Placebo is a Latin word meaning 'I shall please'. A patient responds to the whole therapeutic setting; placebo-effect largely depends on the physician-patient relationship.

Placebos do induce physiological responses, e.g. they can release endorphins in brain—causing analgesia. Naloxone, an opioid antagonist, blocks placebo analgesia. Placebo effects can thus supplement pharmacological effects. However, placebo effects are highly variable even in the same individual, e.g. a placebo may induce sleep on the first night but not subsequently. Thus, it has a very limited role in practical therapeutics. Substances commonly used as placebo are lactose tablets/capsules and distilled water injection.

Nocebo It is the converse of placebo, and refers to negative psychodynamic effect evoked by loss of faith in the medication and/or the physician. Nocebo effect can oppose the therapeutic effect of active medication.

9. Pathological states Not only drugs modify disease processes, several diseases can influence drug disposition and drug action:

Gastrointestinal diseases These can alter absorption of orally administered drugs. The changes are complex and drug absorption can increase or decrease, e.g. in coeliac disease absorption of amoxicillin is decreased but that of cephalixin and cotrimoxazole is increased. Thus, malabsorption syndrome does not necessarily reduce absorption of all drugs. Gastric stasis occurring during migraine attack retards the absorption of ingested drugs. Achlorhydria decreases aspirin absorption by favouring its ionization. NSAIDs can aggravate peptic ulcer disease.

Liver disease Liver disease (especially cirrhosis) can influence drug disposition in several ways:

- (i) Bioavailability of drugs having high first pass metabolism (*see* Ch. 3) is increased due to loss of hepatocellular function and portocaval shunting.
- (ii) Serum albumin is reduced—protein binding of acidic drugs (diclofenac, warfarin, etc.) is reduced and more drug is present in the free form.
- (iii) Metabolism and elimination of some drugs (morphine, lidocaine, propranolol) is decreased—their dose should be reduced. Alternative drugs that do not depend on hepatic metabolism for elimination and/or have shorter $t_{1/2}$ should be preferred, e.g. oxazepam or lorazepam in place of diazepam; atenolol as β -blocker.
- (iv) Prodrugs needing hepatic metabolism for activation, e.g. prednisone, bacampicillin, sulindac are less effective and should be avoided.

The changes are complex and there is no simple test (like creatinine clearance for renal disease) to guide the extent of alteration in drug

disposition; kinetics of different drugs is affected to different extents.

Drug action as well can be altered in liver disease in the case of certain drugs, e.g.

- The sensitivity of brain to depressant action of morphine and barbiturates is markedly increased in cirrhotics—normal doses can produce coma.
- Brisk diuresis can precipitate mental changes in patients with impending hepatic encephalopathy, because diuretics cause hypokalemic alkalosis which favours conversion of NH_4^+ to $\text{NH}_3 \rightarrow$ enters brain more easily.
- Oral anticoagulants can markedly increase prothrombin time, because clotting factors are already low.
- Fluid retaining action of phenylbutazone (also other NSAIDs) and lactic acidosis due to metformin are accentuated.

Hepatotoxic drugs should be avoided in liver disease.

Kidney disease It markedly affects pharmacokinetics of many drugs as well as alters the effects of some drugs.

Clearance of drugs that are primarily excreted unchanged (aminoglycosides, digoxin, phenobarbitone) is reduced parallel to decrease in creatinine clearance (CL_{cr}). Loading dose of such a drug is not altered (unless edema is present), but maintenance doses should be reduced or dose interval prolonged proportionately. A rough guideline is given in the box:

CL_{cr} (patient) Dose rate to be reduced to

50–70 ml/min	70%
30–50 ml/min	50%
10–30 ml/min	30%
5–10 ml/min	20%

Dose rate of drugs only partly excreted unchanged in urine also needs reduction, but to lesser extents. If the $t_{1/2}$ of the drug is prolonged, attainment of steady-state plasma concentration with maintenance doses is delayed proportionately.

Plasma proteins, specially albumin, are often low or altered in structure in patients with renal disease—binding of acidic drugs is reduced, but that of basic drugs is not much affected.

The permeability of blood-brain barrier is increased in renal failure; opiates, barbiturates, phenothiazines, benzodiazepines, etc. produce more CNS depression. Pethidine should be avoided because its metabolite nor-pethidine can accumulate on repeated dosing and cause seizures. The target organ sensitivity may also be increased. Antihypertensive drugs produce more postural hypotension in patients with renal insufficiency.

Certain drugs worsen the existing clinical condition in renal failure, e.g.

- Tetracyclines have an anti-anabolic effect and accentuate uraemia.
- NSAIDs cause more fluid retention.
- Potentially nephrotoxic drugs, e.g. cephalothin, aminoglycosides, tetracyclines (except doxycycline), sulfonamides (crystalluria), vancomycin, cyclosporine, amphotericin B should be avoided.

Antimicrobials needing dose reduction in renal failure

<i>Even in mild failure</i>	<i>Only in severe failure</i>
Aminoglycosides	Cotrimoxazole
Cephalexin	Carbenicillin
Ethambutol	Cefotaxime
Vancomycin	Norfloxacin
Amphotericin B	Ciprofloxacin
Acyclovir	Metronidazole

Thiazide diuretics tend to reduce g.f.r.: are ineffective in renal failure and can worsen uraemia; furosemide should be used. Potassium sparing diuretics are contraindicated; can cause hyperkalemia \rightarrow cardiac depression. Repeated doses of pethidine are likely to cause muscle twitching and seizures due to accumulation of its excitatory metabolite norpethidine.

Urinary antiseptics like nalidixic acid, nitrofurantoin and methenamine mandelate fail to

achieve high concentration in urine and are likely to produce systemic toxicity.

Congestive heart failure It can alter drug kinetics by—

- (i) Decreasing drug absorption from g.i.t. due to mucosal edema and splanchnic vasoconstriction. A definite reduction in procainamide and hydrochlorothiazide absorption has been documented.
- (ii) Modifying volume of distribution which can increase for some drugs due to expansion of extracellular fluid volume or decrease for others as a result of decreased tissue perfusion—loading doses of drugs like lidocaine and procainamide should be lowered.
- (iii) Retarding drug elimination as a result of decreased perfusion and congestion of liver, reduced glomerular filtration rate and increased tubular reabsorption; dosing rate of drugs may need reduction, as for lidocaine, procainamide, theophylline.
- (iv) The decompensated heart is more sensitive to digitalis.

Thyroid disease The hypothyroid patients are more sensitive to digoxin, morphine and CNS depressants. Hyperthyroid patients are relatively resistant to inotropic action but more prone to arrhythmic action of digoxin. The clearance of digoxin is roughly proportional to thyroid function, but this only partially accounts for the observed changes in sensitivity.

Other examples of modification of drug response by pathological states are:

- Antipyretics lower body temperature only when it is raised (fever).
- Thiazides induce more marked diuresis in edematous patients.
- Myocardial infarction patients are more prone to adrenaline and digitalis induced cardiac arrhythmias.
- Myasthenics are very sensitive to curare.
- Schizophrenics tolerate large doses of phenothiazines.

- Head injury patients are prone to go into respiratory failure with normal doses of morphine.
- Atropine, imipramine, furosemide can cause urinary retention in individuals with prostatic hypertrophy.
- Hypnotics given to a patient in severe pain may cause mental confusion and delirium.
- Cotrimoxazole produces a much higher incidence of adverse reactions in AIDS patients.

10. Other drugs Drugs can modify the response to each other by pharmacokinetic or pharmacodynamic interaction between them. Many ways in which drugs can interact have already been considered (*see* Ch. 2, 3, 4), and a more comprehensive account of clinically important drug interactions is presented in Ch 69.

11. Cumulation Any drug will cumulate in the body if rate of administration is more than the rate of elimination. However, slowly eliminated drugs are particularly liable to cause cumulative toxicity, e.g. prolonged use of chloroquine causes retinal damage.

- Full loading dose of digoxin should not be given if patient has received it within the past week.
- A course of emetine should not be repeated within 6 weeks.

12. Tolerance It refers to the requirement of higher dose of a drug to produce a given response. Loss of therapeutic efficacy (e.g. of sulfonyleureas in type 2 diabetes), which is a form of tolerance, is often called 'refractoriness'. Tolerance is a widely occurring adaptive biological phenomenon. Drug tolerance may be:

Natural The species/individual is inherently less sensitive to the drug, e.g. rabbits are tolerant to atropine; black races are tolerant to mydriatics. Some individuals in any population are hyporesponders to certain drugs, e.g. to β adrenergic blockers or to alcohol.

Acquired This occurs by repeated use of a drug in an individual who was initially responsive.

Body is capable of developing tolerance to most drugs but the phenomenon is very easily recognized in the case of CNS depressants. An uninterrupted presence of the drug in the body favours development of tolerance. However, significant tolerance does not develop to atropine, digitalis, cocaine, sodium nitroprusside, etc. Tolerance need not develop equally to all actions of a drug, consequently therapeutic index of a drug may increase or decrease with prolonged use, e.g.:

- Tolerance develops to sedative action of chlorpromazine but not to its antipsychotic action.
- Tolerance occurs to the sedative action of phenobarbitone but not as much to its anti-epileptic action.
- Tolerance occurs to analgesic and euphoric action of morphine, but not as much to its constipating and miotic actions.

Cross tolerance It is the development of tolerance to pharmacologically related drugs, e.g. alcoholics are relatively tolerant to barbiturates and general anaesthetics. Closer the two drugs are, more complete is the cross tolerance between them, e.g.—

There is partial cross tolerance between morphine and barbiturates but complete cross tolerance between morphine and pethidine.

Mechanisms responsible for development of tolerance are incompletely understood. However, tolerance may be:

- (i) Pharmacokinetic/drug disposition tolerance—the effective concentration of the drug at the site of action is decreased, mostly due to enhancement of drug elimination on chronic use, e.g. barbiturates, carbamazepine, amphetamine.
- (ii) Pharmacodynamic/cellular tolerance—drug action is lessened; cells of the target organ become less responsive, e.g. morphine, barbiturates, nitrates. This may be due to down regulation of receptors (*see p. 52*), or weakening of response effectuation.

Tachyphylaxis (*Tachy*-fast, *phylaxis*-protection) is rapid development of tolerance when doses of a drug repeated in quick succession result in marked reduction in response. This is usually seen with indirectly acting drugs, such as ephedrine, tyramine, nicotine. These drugs act by releasing catecholamines in the body, synthesis of which is unable to match the rate of release: stores get depleted. Other mechanisms like slow dissociation of the drug from its receptor, desensitization/internalization or down regulation of receptor, etc. (*see p. 51, 52*) and/or compensatory homeostatic adaptation.

Drug resistance It refers to tolerance of microorganisms to inhibitory action of antimicrobials, e.g. *Staphylococci* to penicillin (*see Ch. 49*).

RATIONAL USE OF MEDICINES

It is widely assumed that use of drugs by qualified doctors of modern medicine would be rational. However, in reality, irrationality abounds in almost every aspect of drug use. Medically inappropriate, ineffective and economically inefficient use of drugs occurs all over the world, more so in the developing countries. As per the WHO — ‘rational use of medicines requires that the patients receive medication appropriate to their clinical needs in doses that meet their own individual requirements for an adequate period of time, and at the lowest cost to them and to their community’.

Rational use of medicines addresses every step in the supply-use chain of drugs, i.e. selection, procurement, storage, prescribing, dispensing, monitoring and feedback. However, only rational prescribing and related aspects are dealt here.

Rational prescribing

Rational prescribing is not just the choice of a correct drug for a disease, or mere matching of drugs with diseases, but also the appropriateness of the whole therapeutic set up along with follow up of the outcome. The criteria to evaluate rational prescribing are:

- Appropriate indication: the reason to prescribe the medicine is based on sound medical considerations.
- Appropriate drug in efficacy, tolerability, safety, and suitability for the patient.
- Appropriate dose, route and duration according to specific features of the patient.
- Appropriate patient: no contraindications exist; drug acceptable to the patient; likelihood of adverse effect is minimal and less than the expected benefit.
- Correct dispensing with appropriate information/instruction to the patient.
- Adequate monitoring of patient's adherence to medication, as well as of anticipated beneficial and untoward effects of the medication.

There is no doubt that knowledge of the prescriber about drugs and disease is the most important determinant of his/her prescribing pattern, but it has been demonstrated time and again that simply improving knowledge has failed to promote rational drug use. A variety of other factors influence prescribing as summarized in the box.

Factors influencing prescribing

- Knowledge of the prescriber.
- Role models: one tends to follow prescribing practices of one's teachers or senior/popular physicians.
- Patient load: heavy load tends to promote routinized symptom based prescribing.
- Attitude to afford prompt symptomatic relief at all cost.
- Imprecise diagnosis: medication is given to cover all possible causes of the illness.
- Drug promotion and exaggerated claims by manufacturers.
- Unethical inducements (gifts, dinner parties, conference delegation, etc.).
- Patient's demands: many are not satisfied unless medication is prescribed; misconceptions, unrealistic expectations, 'pill for every ill' belief.

Irrationalities in prescribing It is helpful to know the commonly encountered irrationalities in prescribing so that a conscious effort is made to avoid them.

- Use of drug when none is needed; e.g. antibiotics for viral fevers and nonspecific diarrhoeas.
- Compulsive coprescription of vitamins/tonics.
- Use of drugs not related to the diagnosis, e.g. chloroquine/ciprofloxacin for any fever, proton pump inhibitors for any abdominal symptom.
- Selection of wrong drug, e.g. tetracycline/ciprofloxacin for pharyngitis, β blocker as antihypertensive for asthmatic patient.
- Prescribing ineffective/doubtful efficacy drugs, e.g. serratiopeptidase for injuries/swellings, antioxidants, cough mixtures, memory enhancers, etc.
- Incorrect route of administration: injection when the drug can be given orally.
- Incorrect dose: either underdosing or overdosing; especially occurs in children.
- Incorrect duration of treatment, e.g. prolonged postsurgical use of antibiotics, stoppage of antibiotics as soon as relief is obtained, such as in tuberculosis.
- Unnecessary use of drug combinations, e.g. ciprofloxacin + tinidazole for diarrhoea, ampicillin + cloxacillin for staphylococcal infection, ibuprofen + paracetamol as analgesic.
- Unnecessary use of expensive medicines when cheaper drugs are equally effective; craze for latest drugs, e.g. routine use of newer antibiotics.
- Unsafe use of drugs, e.g. corticosteroids for fever, anabolic steroids in children, use of single antitubercular drug.
- Polypharmacy without regard to drug interactions: each prescription on an average has 3–4 drugs, some may have as many as 10–12 drugs, of which many are combinations.

Irrational prescribing has a number of adverse consequences for the patient as well as the community. The important ones are:

Impact of irrational prescribing

- Delay/inability in affording relief/cure of disease.
- More adverse drug effects.
- Prolongation of hospitalization; loss of man days.
- Increased morbidity and mortality.
- Emergence of microbial resistance.
- Financial loss to the patient/community.
- Loss of patient's confidence in the doctor.
- Lowering of health standards of patients/community.
- Perpetuation of public health problem.

Rational prescribing is a stepwise process of scientifically analyzing the therapeutic set up

Process of rational prescribing

- Establish a diagnosis (at least provisional).
- Define therapeutic problem(s), e.g. pain, infection, etc.
- Define therapeutic goals to be achieved, e.g. symptom relief, cure, prevention of complications, etc.
- Select the class of drug capable of achieving each goal.
- Identify the drug (from the class selected) based on:

Efficacy	}	For the particular patient
Safety		
Suitability		
Cost		
- Decide the route, dose, duration of treatment, considering patient's condition.
- Provide proper information and instructions about the medication.
- Monitor adherence to the medication (compliance).
- Monitor the extent to which therapeutic goal is achieved, e.g. BP lowering, peptic ulcer healing, etc.
- Modify therapy if needed.
- Monitor any adverse drug events that occur, and modify therapy if needed.

based on relevant inputs about the patient as well as the drug, and then taking appropriate decisions. It does not end with handing over the prescription to the patient, but extends to subsequent monitoring, periodic evaluations and modifications as and when needed, till the therapeutic goals are achieved. The important steps are summarized in the box.

Information/instructions to the patient

Rational prescribing also includes giving relevant and adequate information to the patient about the drug(s) and disease, as well as necessary instructions to be followed.

Effects of the drug Which symptoms will disappear and when (e.g. antidepressant will take weeks to act); whether disease will be cured or not (e.g. diabetes, parkinsonism can only be ameliorated, but not cured), what happens if the drug is not taken as advised (e.g. tuberculosis will worsen and may prove fatal).

Side effects There is considerable debate as to how much the patient should be told about the side effects. Detailed descriptions may have a suggestive effect or may scare the patient and dissuade him from taking the drug, while not informing tantamounts to negligence and may upset the unaware patient. Communicating the common side effects without discouraging the patient is a skill to be developed.

Instructions How and when to take the drug (special dosage forms like inhalers, transdermal patches, etc. may need demonstration); how long to take the drug; when to come back to the doctor; instructions about diet and exercise if needed; what laboratory tests are needed, e.g. prothrombin time with oral anticoagulants, leucocyte count with anticancer drugs.

Precautions/warnings What precautions to take; what not to do, e.g. driving (with conventional antihistaminics) or drinking (with metronidazole), or standing still (after sublingual glyceryl

trinitrate); risk of allergy or any serious reaction, etc.

In the end it should be ensured that the instructions have been properly understood by the patient. Rational prescribing, thus, is a comprehensive process.

EXPIRY DATE OF PHARMACEUTICALS

It is a legal requirement that all pharmaceutical products must carry the date of manufacture and date of expiry on their label. The period between the two dates is called the 'life period' or 'shelf-life' of the drug. Under specified storage conditions, the product is expected to remain stable (retain >95% potency) during this period. In India, the schedule P (Rule 96) of Drugs and Cosmetics Act (1940) specifies the life period (mostly 1–5 years) of drugs and the conditions of storage. The expiry of other medicines has to be specified by the manufacturer, but cannot exceed 5 years, unless permitted by the licencing authority on the basis of satisfactory stability proof.

The shelf-life of a medicine is determined by real time stability studies or by extrapolation from accelerated degradation studies. The expiry date does not mean that the medicine has actually been found to lose potency or become toxic after it, but simply that quality of the medicine is not assured beyond the expiry date, and the manufacturer is not liable if any harm arises from the use of the product. Infact, studies have shown that majority of solid oral dosage forms (tablets/capsules, etc.) stored under ordinary conditions in unopened containers remained stable for 1–5 years (some even 25 years) after the expiry date. Liquid formulations (oral and parenteral) are less stable. Suspensions clump by freezing. Injectable solutions may develop precipitates, become cloudy or discoloured by prolonged storage. Adrenaline injection (in ampoules) has been found to lose potency few months after the expiry date of 1 year (it gets oxidized).

There is hardly any report of toxicity of expired medicines. The degradation product of only one drug (tetracycline) has caused toxicity in man. Outdated tetracycline capsules produced renal tubular damage resembling Fanconi syndrome in the early 1960s. The capsules have now been reformulated to minimize degradation.

Loss of potency beyond the 'life period' of the formulation depends on the drug as well as the storage conditions. High humidity and temperature accelerate degradation of many drugs. Though, majority of medicines, especially solid oral dosage forms, remain safe and active years after the stated expiry date, their use cannot be legally allowed beyond this date.

EVIDENCE BASED MEDICINE

Extensive scientific investigation of drugs in man and introduction of numerous new drugs over the past few decades is gradually transforming the practice of medicine from 'experience based' wherein clinical decisions are made based on the experience (or rather impression) of the physician to 'evidence based' wherein the same are guided by scientifically credible evidence from well designed clinical studies. Evidence based medicine is the process of systematically finding, evaluating and using contemporary research findings as the basis of clinical decisions. Results of well designed multicentric interventional trials are forming the basis of constantly evolving guidelines for disease management. Today's physician has to be skilled in searching and evaluating the literature on efficacy, safety and appropriateness of a particular therapeutic measure (drug). Therapeutic evaluation of a drug includes:

- Quantitation of benefit afforded by it.
- The best way (dosage, duration, patient selection, etc.) to use it.
- How it compares with other available drugs.
- Surveillance of adverse effects produced by it.

Clinical studies are basically of the following three types:

- a. Clinical trials
- b. Cohort studies
- c. Case control studies

Clinical trial

It is a prospective ethically designed investigation in human subjects to objectively discover/verify/compare the results of two or more therapeutic measures (drugs). Depending on the objective of the study, clinical trial may be conducted in healthy volunteers or in volunteer patients. Healthy volunteers may be used to determine pharmacokinetic characteristics, tolerability, safety and for certain type of drugs (e.g. hypoglycaemic, hypnotic, diuretic) even efficacy. For majority of drugs (e.g. antiepileptic,

antipsychotic, antiinflammatory, antitubercular, etc.) therapeutic efficacy can only be assessed in patients.

The inclusion of a proper comparator (*control*) group in clinical trials is crucial. The control group, which should be as similar to the test group as possible, receives either a placebo (if ethically permissible) or the existing standard treatment. Separate test and control groups may run simultaneously (*parallel group design*), or all the subjects may be treated by the two options one after the other (*cross over design*) so that the same subjects serve as their own controls. In the cross over design, some patients are treated first by drug 'A' followed by drug 'B', while in others the order is reversed. This nullifies the effect (if any) of order of treatment. This design is applicable only to certain chronic diseases which remain stable over long periods.

It is well known that both the participants and the investigators of the trial are susceptible to conscious as well as unconscious bias in favour of or against the test drug. The greatest challenge in the conduct of clinical trial is the elimination of bias. The credibility of the trial depends on the measures that are taken to minimize bias. The two basic strategies for minimizing bias are 'randomization' and concealment or 'blinding'.

Randomization The subjects are allocated to either group using a preselected random number table or computer programme so that any subject has equal chance of being assigned to the test or the control group. Discretion (and likely bias) of the investigator/subject in treatment allocation is thus avoided. If considered necessary, *stratified randomization* according to age/sex/disease severity/other patient variable may be adopted.

Blinding (masking) This refers to concealment of the nature of treatment (test or control) from the subject (single blind) or both the subject as well as the investigator (double blind). For this purpose the two medications have to appear similar in looks, number, weight, taste, etc. and are to be supplied in unlabelled packets marked for each

patient. In double blind, the key/code to treatment allocation is kept by a third 'data management' party who is not involved in treating or recording observations. The code is broken at the completion of the trial and the results are analysed according to prespecified statistical method. However, all clinical trials need not be blinded. Those in which the nature of treatment is not concealed are called 'open' trials.

Randomized controlled double blind trial is the most credible method of obtaining evidence of efficacy, safety or comparative value of treatments.

Inclusion/exclusion criteria The characteristics of the subject/patient (age, sex, disease/symptom, severity and/or duration of illness, coexistent and past diseases, concurrent/preceding drug therapy, etc.) who are to be recruited in the trial or excluded from it must be decided in advance. The trial results are applicable only to the population specified by these criteria.

End point The primary and secondary (if any) end points (cure, degree of improvement, symptom relief, surrogate marker, avoidance of complication, curtailment of hospitalization, survival, quality of life, etc.) of the trial must be specified in advance. The results are analysed in relation to the specified end points.

Higher efficacy may not always be the aim of a clinical trial. A trial may be designed to prove 'non inferiority' (of the new drug) to the existing treatment, and possibly afford advantages in terms of tolerability, safety, convenience, cost or applicability to special patient subgroup(s).

Sample size: The number of subjects in the trial for obtaining a decisive conclusion (test better than control/control better than test/no difference between the two) must be calculated statistically beforehand. Because the trial is conducted on a sample of the whole patient population, there is always a chance that the sample was *not* representative of the population.

Two types of errors are possible:

Type I (α) error: a difference is found between the two groups while none exists. Its possibility is called 'significance' of the result, e.g. if test drug is found to be better than control at a significance level of 0.05, it means that there is 5% chance that this is not real.

Type II (β) error: no difference is found while it really exists. The probability of failing to detect an actual difference is expressed by the 'power' of the trial. A power of 0.9 means that there is 10% chance of missing a real difference.

The sample size of the trial depends on the desired level of significance and power. The other input needed for calculation of sample size is the magnitude of difference between the two groups that is expected or is considered clinically significant, e.g. a 10% reduction in pain intensity may not be considered clinically significant, while a 10% reduction in mortality may be worthwhile. Larger sample size is required to detect smaller difference. Also, higher the significance and power level desired, greater is the number of subjects.

Many large scale trials are subjected to interim analysis from time to time as the trial progresses by an independent committee which can order an early termination if a decisive result (positive or negative) is obtained; because it would be unethical to subject some of the remaining patients to a treatment (test or control) which has been found inferior.

Multicentric trial Many large trials are conducted at more than one centre by as many teams of investigators, sometimes spread over several countries. The advantages are:

- Larger number of patients can be recruited in a shorter period of time.
- Results are applicable to a wider population base which may cover several countries/ethnic groups.
- Regulatory requirements of several countries may be satisfied.
- Credibility of the trial is enhanced.

Sequential trial

This design attempts to detect a significant result as soon as it is achieved, minimizing the number of subjects. The trial is conducted on matched pairs of subjects and is scored as 'A' treatment better than 'B' or 'B' better than 'A' or no difference. This is plotted continuously as the trial proceeds till the boundaries of predetermined level of significant superiority/inferiority/no difference are touched. The trial is then terminated. This design is applicable only to certain types of drugs and diseases for

which clinical end points are achieved quickly and paired comparisons are possible. Moreover, it may not always be practicable to recruit matching pairs of trial subjects.

Meta-analysis

This is an exercise in which data from several similarly conducted randomized controlled clinical trials with the same drug (or class of drugs) examining the same clinical end point(s) is pooled to bring out the overall balance of evidence by enlarging the number of test and control subjects and increasing the significance and power of the conclusions. Because individual trials are often conducted on relatively smaller number of patients, some may fail to detect a significant difference, while others may find it. Discordant results are published which confuse the medical practitioner. Though there are many criticisms of meta-analysis, such as:

- a. bias in the selection of trials for analysis;
- b. unintentional exclusion of negative results which are less likely to be published (publication bias);
- c. nonuniformity of the trials in details of methodology and conduct;

it is a useful tool to arrive at conclusions that may influence medical practice. For example, meta-analysis of trials has strongly supported the use of β -adrenergic blockers in heart failure and use of statins to reduce risk of coronary artery disease.

To be reliable, the meta-analysis should observe the following:

- Comprehensive search of the literature to identify all eligible trials.
- Use objective criteria for selecting the trials for inclusion.
- Include only randomized trials of assured quality.
- Employ proper statistical methods in pooling and treating the data from individual trials.

Meta-analysis are now frequently published on contemporary therapeutic issues.

Cohort study

This is a type of observational study in which no intervention for the sake of the study is done. 'Cohort' is a group of individuals having some

common feature. In the context of drug research, the common feature is that all study subjects have taken a particular drug. Occurrence of events (beneficial or adverse) in users and nonusers of the drug is compared. It can be a prospective or a retrospective study. In the prospective design, all patients who receive the study drug are followed up for therapeutic outcomes or adverse effects. A matching group of patients who have not received the drug is identified and followed up to serve as control. Cohort studies are primarily used to discover uncommon adverse effects that may be missed during formal therapeutic trials which involve fewer patients and often exclude certain type of patients who may be susceptible to that adverse effect. Its value for defining therapeutic outcomes is less credible. The limitations of cohort studies are that controls included may not be appropriate, and relatively long period of follow up is needed.

In the retrospective cohort study, health records of a population are scrutinized for exposure to the study drug and the subsequent beneficial/adverse events. Its value is questionable because many events may have been missed in the records and several unknown factors may have contributed to the findings. However, it may serve as pointer, or to arouse suspicion.

Case control study

This type of observational study is used mainly to reveal association of a suspected rare adverse event with the use of a particular drug. Cases of the suspected adverse event (e.g. agranulocytosis) are collected from hospital records or disease registries, etc. A matched control group similar in other respects but not having the adverse event is selected. Drug histories of both groups are traced backwards to compare exposure to the indicted drug (e.g. phenylbutazone) among patients with the adverse event to those without it. The suspicion is strengthened if high association is found. Though case control studies can be performed rather quickly because the number of patients analysed is small compared to the cohort design, they do not prove causality. Also, the

c-ausative drug and the adverse event have to be suspected first to plan the study, whereas cohort study can reveal unsuspected adverse events. Variable accuracy of retrospective records, non randomly selected control group, chances of bias and a variety of unknown factors make the case control study a weak instrument for affording convincing evidence.

NEW DRUG DEVELOPMENT

In this era of bewildering new drug introduction and rapid attrition of older drugs, the doctor needs to have an overall idea of the manner in which new drugs are developed and marketed. Drug development now is a highly complex, tedious, competitive, costly and commercially risky process. From the synthesis/identification of the molecule to marketing, a new drug takes at least 10 years and costs 500–1000 million US\$. The major steps/stages in the development of a new drug are given in the box.

Stages in new drug development

- Synthesis/isolation of the compound: (1–2 years)
- Preclinical studies: screening, evaluation, pharmacokinetic and short-term toxicity testing in animals: (2–4 years)
- Scrutiny and grant of permission for clinical trials: (3–6 months)
- Pharmaceutical formulation, standardization of chemical/biological/immuno-assay of the compound: (0.5–1 year)
- Clinical studies: phase I, phase II, phase III trials; long-term animal toxicity testing: (3–10 years)
- Review and grant of marketing permission: (0.5–2 years)
- Postmarketing surveillance: (phase IV studies)

Approaches to drug discovery

Natural sources *Plants* are the oldest source of medicines. Clues about these have been obtained from traditional

systems of medicine prevalent in various parts of the world; Opium (morphine), *Ephedra* (ephedrine), *Cinchona* (quinine), curare (tubocurarine), belladonna (atropine), Qinghaosu (artemisinin) are the outstanding examples. Though *animal* parts have been used as cures since early times, it was physiological experiments performed in the 19th and early 20th century that led to introduction of some animal products into medicine, e.g. adrenaline, thyroxine, insulin, liver extract, antisera, etc. Few *minerals* (iron/calcium salts, etc.) are the other natural medicinal substances. The discovery of penicillin (1941) opened the flood-gates of a vast source—*microorganisms*—of a new kind of drugs (antibiotics). The use of microbes for production of vaccines is older than their use to produce antibiotics.

The above natural sources of medicines are by no means exhausted, search for new plant, animal and microbial products as drugs is still a productive approach, especially to serve as lead compounds.

Chemical synthesis Synthetic chemistry made its debut in the 19th century and is now the largest source of medicines. Randomly synthesized compounds can be tested for a variety of pharmacological activities. Though some useful drugs (barbiturates, chlorpromazine) have been produced serendipitously by this approach, it has very low probability of hitting at the right activity in the right compound.

A more practical approach is to synthesize chemical congeners of natural products/synthetic compounds with known pharmacological activity in the hope of producing more selective/superior drugs. Many families of clinically useful drugs have been fathered by a lead compound. Often only 'mee too' drugs are produced, but sometimes breakthroughs are achieved, e.g. thiazide diuretics from acetazolamide, tricyclic antidepressants from phenothiazines.

Study of several congeners of the lead compound can delineate molecular features responsible for a particular property. Application of this *structure-activity relationship* information has proven useful on many occasions, e.g. selective β_2 agonists (salbutamol) and β blockers (propranolol, etc.) have been produced by modifying the structure of isoprenaline, H_2 blockers by modifying the side chain of histamine, ethinyl-estradiol by introducing a substitution that resists metabolic degradation, mesoprostol (more stable) by esterifying PGE₁.

Many drugs are *chiral* compounds. Because pharmacological activity depends on three dimensional interaction of drugs with their target biomolecules, the *enantiomers* (R and S forms or *d* and *l* isomers) of chiral drugs differ in biological activity, metabolic degradation, etc. Often only one of the enantiomers is active. Single enantiomer drug could be superior to its racemate, because the additional enantiomer may not only be a 'silent passenger' but contribute to side effects, toxicity (dextro-dopa is more toxic than levo-dopa) load on metabolism or even antagonize the active enantiomer. Regulatory authorities

in many countries, led by US-FDA, have mandated separate investigation of the enantiomers in case the new drug is a chiral molecule. Approval is withheld unless the pure enantiomers are shown to be no better than the racemate. Several drugs, originally introduced as racemates, have now been made available as *single enantiomer* preparations as well (see box).

Drugs marketed as single enantiomers

<i>Enantiomer</i>	<i>Advantage claimed</i>
(S) atenolol	half dose, better tolerated
(S) metoprolol	half dose
(S) amlodipine	half dose, less peripheral edema
(S) omeprazole (esomeprazole)	better oral bioavailability
(S) pantoprazole	more potent
(R) salbutamol	more active, (S) may antagonize (R)
(S) citalopram (escitalopram)	lower dose, less side effects
(S) naproxen	less burden on kidney (but inversion occurs <i>in vivo</i>)
cisatracurium	4× more potent, less histamine release
levofloxacin	more active, slower elimination
levocetirizine (R)	half dose, only (R) form active
desloratadine	half dose

Rational approach This depends on sound physiological, biochemical, pathological knowledge and identification of specific target for drug action such as H⁺K⁺ATPase enzyme or glycoprotein IIa/IIIb receptor. The drug is aimed at mitigating the derangement caused by the disease, e.g. levodopa was tried in parkinsonism based on the finding that the condition resulted from deficiency of dopamine in the striatum. The purine, pyrimidine, folate antimetabolites were introduced in cancer chemotherapy after elucidation of key role of these metabolites in cell proliferation. Because virus directed reverse transcriptase is unique to retroviruses, its inhibitors have been developed as anti-HIV drugs. This approach is very attractive but requires a lot of basic research.

Molecular modelling Advances in protein chemistry and computer aided elucidation of three dimensional structure of key receptors, enzymes, etc. has permitted designing of targeted compounds, e.g. designing of selective COX-2

inhibitors was prompted by the comparative configuration of COX-1 and COX-2 enzyme molecules. Study of drug binding to mutated receptors and elucidation of configuration of drug-receptor complexes is now guiding production of improved drugs. Attempts are being made to produce individualized drugs according to pharmacogenomic suitability.

Combinatorial chemistry Chemical groups are combined in a random manner to yield innumerable compounds and subjected to *high-throughput screening* on cells, genetically engineered microbes, receptors, enzymes, etc. in robotically controlled automated assay systems. Computerized analysis is used to identify putative drugs which are then subjected to conventional tests. This new approach has vast potentials, but has not achieved major breakthroughs so far.

Biotechnology Several drugs are now being produced by recombinant DNA technology, e.g. human growth hormone, human insulin, interferon, etc. Some monoclonal and chimeral antibodies have been introduced as drugs.

New molecules, especially antibiotics, regulatory peptides, growth factors, cytokines, etc. produced by biotechnological methods can be evaluated as putative drugs. Other experimental approaches in new drug development are antisense oligonucleotides and gene therapy.

Preclinical studies

After synthesizing/identifying a prospective compound/series of compounds, it is tested on animals to expose the whole pharmacological profile. Experiments are generally performed on a rodent (mouse, rat, guinea pig, hamster, rabbit) and then on a larger animal (cat, dog, monkey). As the evaluation progresses unfavourable compounds get rejected at each step, so that only a few out of thousands reach the stage when administration to man is considered.

The following types of tests are performed.

1. **Screening tests** These are simple and rapidly performed tests to indicate presence or absence of a particular pharmacodynamic activity that is sought for, e.g. analgesic or hypoglycaemic activity.
2. **Tests on isolated organs, bacterial cultures, etc.** These also are preliminary tests to detect specific activity, such as antihistaminic, antisecretory, vasodilator, antibacterial, etc.
3. **Tests on animal models of human disease** Such as kindled seizures in rats, spontaneously (genetically) hypertensive rats, experimental tuberculosis in mouse, alloxan induced diabetes in rat or dog, etc.
4. **General observational test** Performed either in the beginning (in case of totally novel compounds) or

after detecting useful activity in screening test, the drug is injected in tripling doses to small groups of mice which are observed for overt effects. Preliminary clues are drawn from the profile of effects observed.

5. **Confirmatory tests and analogous activities** Compounds found active are taken up for detailed study by more elaborate tests which confirm and characterize the activity. Other related activities, e.g. antipyretic and anti-inflammatory activity in an analgesic are tested.
6. **Mechanism of action** Attempts are made to find out the mechanism of action, e.g. whether an antihypertensive is an α blocker/ β blocker/calcium channel blocker/ACE inhibitor/centrally acting, etc.
7. **Systemic pharmacology** Irrespective of the primary action of the drug, its effects on major organ systems such as nervous, cardiovascular, respiratory, renal, g.i.t are worked out.
8. **Quantitative tests** The dose-response relationship, maximal effect and comparative efficacy with existing drugs is ascertained.
9. **Pharmacokinetics** The absorption, tissue distribution, metabolism, excretion, volume of distribution and half-life of the drug are quantified.
10. **Toxicity tests**

The aim is to determine safety of the compound in at least 2 animal species, mostly mouse/rat and dog by oral and parenteral routes.

Acute toxicity: Single escalating doses are given to small groups of animals that are observed for overt effects and mortality for 1–3 days. The dose which kills 50% animals (LD_{50}) is calculated. Organ toxicity is examined by histopathology on all animals.

Subacute toxicity: Repeated doses are given for 2–12 weeks depending on the duration of intended treatment in man. Doses are selected on the basis of ED_{50} and LD_{50} . Animals are examined for overt effects, food intake, body weight, haematology, etc. and organ toxicity.

Chronic toxicity: The drug is given for 6–12 months and effects are studied as in subacute toxicity. This is generally undertaken concurrently with early clinical trials.

Special long-term toxicity: These tests are generally performed only on drugs which cross phase I clinical trials.

Reproduction and teratogenicity: Effects on spermatogenesis, ovulation, fertility and developing foetus are studied.

Mutagenicity: Ability of the drug to induce genetic damage is assessed in bacteria (Ames test), mammalian cell cultures and in intact rodents.

Carcinogenicity: Drug is given for long-term, even the whole life of the animal and they are watched for development of tumours.

Standardized procedures under 'Good Laboratory Practices' (GLP) have been laid down for the conduct of animal experiments, especially toxicity testing.

Clinical trials

When a compound deserving trial in man is identified by animal studies, the regulatory authorities are approached who on satisfaction issue an 'investigational new drug' (IND) licence. The drug is formulated into a suitable dosage form and clinical trials are conducted in a logical phased manner. To minimize any risk, initially few subjects receive the drug under close supervision. Later, larger numbers are treated with only relevant monitoring. Standards for the design, ethics, conduct, monitoring, auditing, recording and analyzing data and reporting of clinical trials have been laid down in the form of 'Good Clinical Practice' (GCP) guidelines by an International Conference on Harmonization (ICH). Adherence to these provides assurance that the data and reported results are credible and accurate, and that the rights, integrity and confidentiality of trial subjects are protected. The clinical studies are conventionally divided into 4 phases.

Phase I: Human pharmacology and safety

The first human administration of the drug is carried out by qualified clinical pharmacologists/trained physicians in a setting where all vital functions are monitored and emergency/resuscitative facilities are available. Subjects (mostly healthy volunteers, sometimes patients) are exposed to the drug one by one (total 20–40 subjects), starting with the lowest estimated dose and increasing stepwise to achieve the effective dose. The emphasis is on safety and tolerability, while the purpose is to observe the pharmacodynamic effects in man, and to characterize absorption, distribution, metabolism and excretion. No blinding is done: the study is open label.

Phase II: Therapeutic exploration and dose ranging

This is conducted by physicians who are trained as clinical investigators on 100–400 patients

selected according to specific inclusion and exclusion criteria. The primary aim is establishment of therapeutic efficacy, dose range and ceiling effect in a controlled setting. Tolerability and pharmacokinetics are studied as extension of phase I. The study may be blinded or open label and is generally carried out at 2–4 centres.

Phase III: Therapeutic confirmation/comparison

Generally these are randomized double blind comparative trials conducted on a larger patient population (500–3000) by several physicians at many centres. The aim is to establish the value of the drug in relation to existing therapy. Safety, tolerability and possible drug interactions are assessed on a wider scale, while additional pharmacokinetic data may be obtained. Indications are finalized and guidelines for therapeutic use are formulated. A 'new drug application' (NDA) is submitted to the licencing authority, who if convinced give marketing permission.

Phase IV: Postmarketing surveillance/studies

After the drug has been marketed for general use, practicing physicians are identified through whom data are collected on a structured proforma about the efficacy, acceptability and adverse effects of the drug (similar to prescription event monitoring). Patients treated in the normal course form the study population: numbers therefore are much larger. Uncommon/idiosyncratic adverse effects, or those that occur only after long-term use and unsuspected drug interactions are detected at this stage. Patterns of drug utilization and additional indications may emerge from the surveillance data.

Further therapeutic trials involving special groups like children, elderly, pregnant/lactating women, patients with renal/hepatic disease, etc. (which are generally excluded during clinical trials) may be undertaken at this stage. Modified release dosage forms, additional routes of administration, fixed dose drug combinations, etc. may be explored.

As such, many drugs continue their development even after marketing.



Adverse effect is 'any undesirable or unintended consequence of drug administration'. It is a broad term, includes all kinds of noxious effect—trivial, serious or even fatal.

For the purposes of detecting and quantifying only those adverse effects of a drug which are of some import and occur in ordinary therapeutic setting, the term *adverse drug reaction* (ADR) has been defined as 'any noxious change which is suspected to be due to a drug, occurs at doses normally used in man, requires treatment or decrease in dose or indicates caution in the future use of the same drug'. This definition excludes trivial or expected side effects and poisonings or overdose.

Another term '*adverse drug event*' (ADE) has been used to mean 'any untoward medical occurrence that may present during treatment with a medicine, but which does not necessarily have a causal relationship with the treatment'. The idea is to record all adverse events first, and look for causality only while analyzing pooled data.

All drugs are capable of producing adverse effects and whenever a drug is given a risk is taken. The magnitude of risk has to be considered along with the magnitude of expected therapeutic benefit in deciding whether to use or not to use a particular drug in a given patient, e.g. even risk of bone marrow depression may be justified in treating cancer while mild drowsiness caused by

an antihistaminic in treating common cold may be unacceptable.

Adverse effects may develop promptly or only after prolonged medication or even after stoppage of the drug. Adverse effects are not rare; an incidence of 10–25% has been documented in different clinical settings. They are more common with multiple drug therapy and in the elderly. Adverse effects have been classified in many ways. One may divide them into:

Predictable (Type A or Augmented) reactions (mechanism based adverse reactions) These are based on the pharmacological properties of the drug, which means that they are augmented, but qualitatively normal response to the drug; include side effects, toxic effects and consequences of drug withdrawal. They are more common, dose related and mostly preventable and reversible.

Unpredictable (Type B or Bizarre) reactions These are based on peculiarities of the patient and not on drug's known actions; include allergy and idiosyncrasy. They are less common, often non-dose related, generally more serious and require withdrawal of the drug. Some of these reactions can be predicted and prevented if their genetic basis is known and suitable test to characterize the individual's phenotype is performed.

Severity of adverse drug reactions has been graded as:

Minor: No therapy, antidote or prolongation of hospitalization is required.

Moderate: Requires change in drug therapy, specific treatment or prolongs hospital stay by at least one day.

Severe: Potentially life-threatening, causes permanent damage or requires intensive medical treatment.

Lethal: Directly or indirectly contributes to death of the patient.

Pharmacovigilance

Pharmacovigilance has been defined by the WHO as the 'science and activities relating to the detection, assessment, understanding and prevention of adverse effects or any other drug related problems.' The information generated by pharmacovigilance is useful in educating doctors about ADRs and in the official regulation of drug use. It has an important role in rational use of medicines, as it provides the basis for assessing safety of medicines.

The activities involved in pharmacovigilance are:

- a. Postmarketing surveillance and other methods of ADR monitoring such as voluntary reporting by doctors (e.g. yellow card system of UK), prescription event monitoring, computerized medical record linkage and other cohort/case control studies as well as anecdotal case reports by doctors.

Voluntary reporting depends on the initiative and willingness of the health professionals. It is minimal in India, while even in the developed countries only ~10% ADRs are reported voluntarily. Generally, immediately occurring reactions and those that are dramatic are reported. Though even rare reactions can be detected by this method, it does not provide incidence of the reaction.
- b. Dissemination of ADR data through 'drug alerts', 'medical letters,' advisories sent to doctors by pharmaceuticals and regulatory agencies (such as FDA in USA, committee on safety of medicines in UK).
- c. Changes in the labelling of medicines indicating restrictions in use or statutory warnings, precautions, or even withdrawal of the drug.

Pharmacovigilance centres have been set up in most countries. The Uppsala Monitoring Centre (Sweden) is the international collaborating centre. In India, the national coordinating centre is located in the All India Institute of Medical Sciences. Regional centres are expected to collect, communicate and disseminate ADR data by linking with medical institutions and practitioners. The pharmacovigilance centres are also expected to provide expertise for assessing causality and severity of ADRs by using standard algorithms and rating scales.

Prevention of adverse effects to drugs Adverse drug effects can be minimized but not altogether eliminated by observing the following practices:

1. Avoid all inappropriate use of drugs in the context of patient's clinical condition.
2. Use appropriate dose, route and frequency of drug administration based on patient's specific variables.
3. Elicit and take into consideration previous history of drug reactions.
4. Elicit history of allergic diseases and exercise caution (drug allergy is more common in patients with allergic diseases).
5. Rule out possibility of drug interactions when more than one drug is prescribed.
6. Adopt correct drug administration technique (e.g. intravenous injection of vancomycin must be slow).
7. Carry out appropriate laboratory monitoring (e.g. prothrombin time with warfarin, serum drug levels with lithium).

Adverse drug effects may be categorized into:

1. Side effects

These are unwanted but often unavoidable pharmacodynamic effects that occur at therapeutic doses. They can be predicted from the pharmacological profile of a drug and are known to occur in a given percentage of drug recipients. Reduction in dose generally ameliorates the symptoms.

A side effect may be based on the same action as the therapeutic effect, e.g. atropine is used in preanaesthetic medication for its antisecretory action. The same action produces dryness of mouth as a side effect. Acetazolamide acts as a diuretic by promoting bicarbonate excretion—

acidosis occurs as a side effect due to bicarbonate loss.

Side effect may also be based on a different facet of action, e.g. promethazine produces sedation which is unrelated to its antiallergic action; estrogens cause nausea which is unrelated to their antiovarulatory action.

An effect may be therapeutic in one context but side effect in another context, e.g. codeine used for cough produces constipation as a side effect but the latter is its therapeutic effect in traveller's diarrhoea; depression of A-V conduction is the desired effect of digoxin in atrial fibrillation, but the same may be undesirable when it is used for CHF.

Many drugs have been developed from observation of side effects, e.g. early sulfonamides used as antibacterial were found to produce hypoglycaemia and acidosis as side effects which directed research resulting in the development of hypoglycaemic sulfonylureas and carbonic anhydrase inhibitor—acetazolamide.

2. Secondary effects

These are indirect consequences of a primary action of the drug, e.g. suppression of bacterial flora by tetracyclines paves the way for superinfections; corticosteroids weaken host defence mechanisms so that latent tuberculosis gets activated.

3. Toxic effects

These are the result of excessive pharmacological action of the drug due to overdosage or prolonged use. Overdosage may be absolute (accidental, homicidal, suicidal) or relative (i.e. usual dose of gentamicin in presence of renal failure). The effects are predictable and dose related. They result from functional alteration (high dose of atropine causing delirium) or drug induced tissue damage (hepatic necrosis from paracetamol overdosage). The CNS, CVS, kidney, liver, lung, skin and blood forming organs are most commonly involved in drug toxicity.

Toxicity may result from extension of the therapeutic effect itself, e.g. coma by barbiturates, complete A-V block by digoxin, bleeding due to heparin.

Another action may be responsible for toxicity, e.g.—

Morphine (analgesic) causes respiratory failure in overdosage.

Imipramine (antidepressant) overdose causes cardiac arrhythmia.

Streptomycin (antitubercular) causes vestibular damage on prolonged use.

Poisoning Poisoning may result from large doses of drugs because 'it is the dose which distinguishes a drug from a poison'. Poison is a 'substance which endangers life by severely affecting one or more vital functions'. Not only drugs but other household and industrial chemicals, insecticides, etc. are frequently involved in poisonings. Specific antidotes such as receptor antagonists, chelating agents or specific antibodies are available for few poisons. General supportive and symptomatic treatment is all that can be done for others, and this is also important for poisons which have a selective antagonist.

These measures are:

1. *Resuscitation and maintenance of vital functions*

- Ensure patent airway, adequate ventilation, give artificial respiration/100% oxygen inhalation as needed.
- Maintain blood pressure and heart beat by fluid and crystalloid infusion, pressor agents, cardiac stimulants, etc, as needed.
- Maintain body temperature.
- Maintain blood sugar level by dextrose infusion, especially in patients with altered sensorium.

2. *Termination of exposure (decontamination)* by removing the patient to fresh air (for inhaled poisons), washing the skin and eyes (for poisons entering from the surface), induction of emesis with syrup ipecac or gastric lavage (for ingested poisons). Emesis should not be attempted in

comatose or haemodynamically unstable patient, as well as for kerosene poisoning due to risk of aspiration into lungs. These procedures are also contraindicated in corrosive and CNS stimulant poisoning. Emesis/gastric lavage is not recommended if the patient presents > 2 hours after ingesting the poison; if the poison/its dose ingested are known to be non life-threatening, or if the patient has vomited after consuming the poison.

3. *Prevention of absorption of ingested poisons*

A suspension of 20–40 g (1g/kg) of activated charcoal, which has large surface area and can adsorb many chemicals, should be administered in 200 ml of water. However, strong acids and alkalis, metallic salts, iodine, cyanide, caustics, alcohol, hydrocarbons and other organic solvents are not adsorbed by charcoal. Charcoal should not be administered if there is paralytic ileus or intestinal obstruction.

4. *Hastening elimination* of the poison by inducing diuresis (furosemide, mannitol) or altering urinary pH (alkalinization for acidic drugs, e.g. barbiturates). However, excretion of many poisons is not enhanced by forced diuresis and it is generally not employed now. Haemodialysis and haemoperfusion (passage of blood through a column of charcoal or adsorbant resin) are more efficacious procedures.

4. Intolerance

It is the appearance of characteristic toxic effects of a drug in an individual at therapeutic doses. It is the converse of tolerance and indicates a low threshold of the individual to the action of a drug. These are individuals who fall on the extreme left side of the Gaussian frequency distribution curve for sensitivity to the drug. Examples are:

- A single dose of triflupromazine induces muscular dystonias in some individuals, specially children.
- Only few doses of carbamazepine may cause ataxia in some people.
- One tablet of chloroquine may cause vomiting and abdominal pain in an occasional patient.

5. Idiosyncrasy

It is genetically determined abnormal reactivity to a chemical. The drug interacts with some unique feature of the individual, not found in majority of subjects, and produces the uncharacteristic reaction. As such, the type of reaction is restricted to individuals with a particular genotype (*see p. 64*). In addition, certain bizarre drug effects due to peculiarities of an individual (for which no definite genotype has been described) are included among idiosyncratic reactions, e.g.:

- Barbiturates cause excitement and mental confusion in some individuals.
- Quinine/quinidine cause cramps, diarrhoea, purpura, asthma and vascular collapse in some patients.
- Chloramphenicol produces nondose-related serious aplastic anaemia in rare individuals.

6. Drug allergy

It is an immunologically mediated reaction producing stereotype symptoms which are unrelated to the pharmacodynamic profile of the drug, generally occur even with much smaller doses and have a different time course of onset and duration. This is also called drug hypersensitivity; but does not refer to increased response which is called supersensitivity.

Allergic reactions occur only in a small proportion of the population exposed to the drug and cannot be produced in other individuals at any dose. Prior sensitization is needed and a latent period of at least 1–2 weeks is required after the first exposure. The drug or its metabolite acts as antigen (AG) or more commonly *hapten* (incomplete antigen: drugs have small molecules which become antigenic only after binding with an endogenous protein) and induce production of antibody (AB)/sensitized lymphocytes. Presence of AB to a drug is not necessarily followed by allergy to it. Chemically related drugs often show cross sensitivity. One drug can produce different types of allergic reactions in different individuals, while widely different drugs can produce the same reaction. The course of drug

allergy is variable; an individual previously sensitive to a drug may subsequently tolerate it without a reaction and *vice versa*.

Mechanism and types of allergic reactions

A. Humoral

Type-I (anaphylactic) reactions Reaginic antibodies (IgE) are produced which get fixed to the mast cells. On exposure to the drug, AG: AB reaction takes place on the mast cell surface (see Fig. 11.2) releasing mediators like histamine, 5-HT, leukotrienes especially LT-C₄ and D₄, prostaglandins, PAF, etc. resulting in urticaria, itching, angioedema, bronchospasm, rhinitis or anaphylactic shock. The manifestations occur quickly after challenge and are called *immediate hypersensitivity*. Antihistaminic drugs are beneficial in some of these reactions.

Type-II (cytolytic) reactions Drug + component of a specific tissue cell act as AG. The resulting antibodies (IgG, IgM) bind to the target cells; on reexposure AG: AB reaction takes place on the surface of these cells, complement is activated and cytolysis occurs, e.g. thrombocytopenia, agranulocytosis, aplastic anaemia, haemolysis, organ damage (liver, kidney, muscle), systemic lupus erythematosus.

Type-III (retarded, Arthus) reactions These are mediated by circulating antibodies (predominantly IgG, mopping AB). AG: AB complexes bind complement and precipitate on vascular endothelium giving rise to a destructive inflammatory response. Manifestations are rashes, serum sickness (fever, arthralgia, lymphadenopathy), polyarteritis nodosa, Stevens-Johnson syndrome (erythema multiforme, arthritis, nephritis, myocarditis, mental symptoms). The reaction usually subsides in 1–2 weeks.

B. Cell mediated

Type-IV (delayed hypersensitivity) reactions These are mediated through production of sensi-

tized T-lymphocytes carrying receptors for the AG. On contact with the AG these T cells produce *lymphokines* which attract granulocytes and generate an inflammatory response, e.g. contact dermatitis, some rashes, fever, photosensitization. The reaction generally takes > 12 hours to develop.

Treatment of drug allergy

The offending drug must be immediately stopped. Most mild reactions (like skin rashes) subside by themselves and do not require specific treatment. Antihistamines (H₁) are beneficial in some type I reactions (urticaria, rhinitis, swelling of lips, etc.) and some skin rashes (see p. 159). In case of anaphylactic shock or angioedema of larynx the resuscitation council of UK has recommended the following measures:

- Put the patient in reclining position, administer oxygen at high flow rate and perform cardiopulmonary resuscitation if required.
- Inject adrenaline 0.5 mg (0.5 ml of 1 in 1000 solution) i.m.; repeat every 5–10 min in case patient does not improve or improvement is transient. This is the only life saving measure. Adrenaline should not be injected i.v. (can itself be fatal) unless shock is immediately life threatening. If adrenaline is to be injected i.v., it should be diluted to 1:10,000 or 1:100,000 and infused slowly with constant monitoring.
- Administer a H₁ antihistaminic (chlorpheniramine 10–20 mg) i.m./slow i.v. It may have adjuvant value.
- Intravenous glucocorticoid (hydrocortisone sod. succinate 100–200 mg) should be added in severe/recurrent cases. It acts slowly, but is specially valuable for prolonged reactions and in asthmatics.

Adrenaline followed by a short course of glucocorticoids is indicated for bronchospasm attending drug hypersensitivity. Glucocorticoids are the only drug effective in type II, type III and type IV reactions.

Drugs frequently causing allergic reactions

Penicillins	Salicylates
Cephalosporins	Carbamazepine
Sulfonamides	Allopurinol
Tetracyclines	ACE inhibitors
Quinolones	Methyldopa
Antitubercular drugs	Hydralazine
Phenothiazines	Local anaesthetics

Skin tests (intradermal, patch) or intranasal tests may forewarn in case of Type I hypersensitivity, but not in case of other types. However, these tests are not entirely reliable—false positive and false negative results are not rare.

7. Photosensitivity

It is a cutaneous reaction resulting from drug induced sensitization of the skin to UV radiation. The reactions are of two types:

(a) Phototoxic Drug or its metabolite accumulates in the skin, absorbs light and undergoes a photochemical reaction followed by a photobiological reaction resulting in local tissue damage (sunburn-like), i.e. erythema, edema, blistering followed by hyperpigmentation and desquamation. The shorter wave lengths (290–320 nm, UV-B) are responsible. Drugs involved in acute phototoxic reactions are tetracyclines (especially demeclocycline) and tar products. Drugs causing chronic and low grade sensitization are nalidixic acid, fluoroquinolones, sulfones, sulfonamides, phenothiazines, thiazides, amiodarone. This type of reaction is more common than photoallergic reaction.

(b) Photoallergic Drug or its metabolite induces a cell mediated immune response which on exposure to light of longer wave lengths (320–400 nm, UV-A) produces a papular or eczematous contact dermatitis like picture. Rarely antibodies mediate photoallergy and the reaction takes the form of immediate flare and wheal on exposure to sun. Drugs involved are sulfonamides, sul-

fonylureas, griseofulvin, chloroquine, chlorpromazine.

8. Drug dependence

Drugs capable of altering mood and feelings are liable to repetitive use to derive euphoria, withdrawal from reality, social adjustment, etc. Drug dependence is a state in which use of drugs for personal satisfaction is accorded a higher priority than other basic needs, often in the face of known risks to health.

There is a lot of confusion in terminology and definitions; the following may serve to describe different aspects of the problem.

Psychological dependence It is said to have developed when the individual believes that optimal state of wellbeing is achieved only through the actions of the drug. It may start as liking for the drug effects and may progress to compulsive drug use in some individuals. The intensity of psychological dependence may vary from desire to craving. Obviously, certain degree of psychological dependence accompanies all patterns of self medication.

Reinforcement is the ability of the drug to produce effects that make the user wish to take it again or to induce *drug seeing behaviour*. Certain drugs (opioids, cocaine) are strong reinforcers, while others (benzodiazepines) are weak reinforcers. Faster the drug acts, more reinforcing it is.

Physical dependence It is an altered physiological state produced by repeated administration of a drug which necessitates the continued presence of the drug to maintain physiological equilibrium. Discontinuation of the drug results in a characteristic *withdrawal (abstinence) syndrome*. Since the essence of the process is adaptation of the nervous system to function normally in the presence of the drug, it has been called 'neuroadaptation'.

Drugs producing physical dependence are—opioids, barbiturates and other depressants including alcohol and benzodiazepines. Stimulant

drugs, e.g. amphetamines, cocaine produce little or no physical dependence.

Drug abuse Refers to use of a drug by self medication in a manner and amount that deviates from the approved medical and social patterns in a given culture at a given time. The term conveys social disapproval of the manner and purpose of drug use. For regulatory agencies, *drug abuse* refers to any use of an illicit drug.

Drug addiction It is a pattern of compulsive drug use characterized by overwhelming involvement with the use of a drug. Procuring the drug and using it takes precedence over other activities. Even after withdrawal most addicts tend to relapse. Physical dependence, though a strong impetus for continued drug use, is not an essential feature of addiction. Amphetamines, cocaine, cannabis, LSD are drugs which produce addiction but little/no physical dependence. On the other hand, drugs like nalorphine produce physical dependence without imparting addiction in the sense that there is little drug seeking behaviour.

Drug habituation It denotes less intensive involvement with the drug, so that its withdrawal produces only mild discomfort. Consumption of tea, coffee, tobacco, social drinking are regarded habituating, physical dependence is absent.

Basically, habituation and addiction imply different degrees of psychological dependence and it may be difficult to draw a clearcut line of distinction between the two. Therefore, it is better to avoid using these terms in describing drug dependence and related conditions.

9. Drug withdrawal reactions

Apart from drugs that are usually recognised as producing dependence, sudden interruption of therapy with certain other drugs also results in adverse consequences, mostly in the form of worsening of the clinical condition for which the drug was being used, e.g.:

- (i) Acute adrenal insufficiency may be precipitated by abrupt cessation of corticosteroid therapy.

- (ii) Severe hypertension, restlessness and sympathetic overactivity may occur shortly after discontinuing clonidine.
- (iii) Worsening of angina pectoris, precipitation of myocardial infarction may result from stoppage of β blockers.
- (iv) Frequency of seizures may increase on sudden withdrawal of an antiepileptic.

These manifestations are also due to adaptive changes and can be minimized by gradual withdrawal.

10. Teratogenicity

It refers to capacity of a drug to cause foetal abnormalities when administered to the pregnant mother. The placenta does not strictly constitute a barrier and any drug can cross it to a greater or lesser extent. The embryo is one of the most dynamic biological systems and in contrast to adults, drug effects are often irreversible. The thalidomide disaster (1958–61) resulting in thousands of babies born with *phocomelia* (seal like limbs) and other defects focused attention to this type of adverse effect.

Drugs can affect the foetus at 3 stages—

- (i) *Fertilization and implantation*—conception to 17 days—failure of pregnancy which often goes unnoticed.
- (ii) *Organogenesis*—18 to 55 days of gestation—most vulnerable period, deformities are produced.
- (iii) *Growth and development*—56 days onwards—developmental and functional abnormalities can occur, e.g. ACE inhibitors can cause hypoplasia of organs, specially lungs and kidneys; NSAIDs may induce premature closure of ductus arteriosus.

The type of malformation depends on the drug as well as the stage of exposure to the teratogen. Foetal exposure depends on the blood level and duration for which the drug remains in maternal circulation. The teratogenic potential of a drug is to be considered against the background of congenital abnormalities occurring spontaneously,

Human teratogenic drugs	
<i>Drug</i>	<i>Abnormality</i>
Thalidomide	phocomelia, multiple defects
Anticancer drugs (methotrexate)	cleft palate, hydrocephalus, multiple defects, foetal death
Androgens	virilization; limb, esophageal, cardiac defects
Progestins	virilization of female foetus
Stilboestrol	vaginal carcinoma in teenage female offspring
Tetracyclines	discoloured and deformed teeth, retarded bone growth
Warfarin	depressed nose; eye and hand defects, growth retardation
Phenytoin	hypoplastic phalanges, cleft lip/palate, microcephaly
Phenobarbitone	various malformations
Carbamazepine	neural tube defects, other abnormalities
Valproate sod.	spina bifida and other neural tube defects
Alcohol	low IQ baby, growth retardation, foetal alcohol syndrome
ACE inhibitors	hypoplasia of organs, growth retardation, foetal loss
Lithium	foetal goiter, cardiac and other abnormalities
Antithyroid drugs	foetal goiter and hypothyroidism
Indomethacin/aspirin	premature closure of ductus arteriosus
Isotretinoin	craniofacial, heart and CNS defects

Risk category of drugs during pregnancy		
<i>Category</i>		<i>Examples</i>
A	Adequate studies in pregnant women have failed to demonstrate a risk to the foetus	Inj. Mag. sulfate, thyroxine
B	Adequate human studies are lacking, but animal studies have failed to demonstrate a risk to the foetus or Adequate studies in pregnant women have failed to demonstrate a risk to the foetus, but animal studies have shown an adverse effect on the foetus	Penicillin V, amoxicillin, cefactor, erythromycin, paracetamol, lignocaine
C	No adequate studies in pregnant women and animal studies are lacking or have shown and adverse effect on foetus, but potential benefit may warrant use of the drug in pregnant women despite potential risk	Morphine, codeine, atropine, corticosteroids, adrenaline, thiopentone, bupivacaine
D	There is evidence of human foetal risk, but the potential benefits from use of the drug may be acceptable despite the potential risk	Aspirin, phenytoin, carbamazepine, valproate, lorazepam
X	Studies in animals or humans have demonstrated foetal abnormalities, and potential risk clearly outweighs possible benefit	Estrogens, isotretinoin, ergometrine

which is ~ 2% of all pregnancies. Majority of implicated drugs are low grade teratogens, i.e. increase the incidence of malformations only slightly, which may be very difficult to detect, confirm or refute. Nevertheless, some drugs have been clearly associated with causing foetal abnormalities in human beings. These are listed in the box. However, only few mothers out of those who receive these drugs during the vulnerable period will get a deformed baby, but the exact risk posed by a drug is difficult to estimate.

The US-FDA has graded the documentation of risk for causing birth defects into five categories (see box).

It is, therefore, wise to avoid all drugs during pregnancy unless compelling reasons exist for their use regardless of the assigned pregnancy category, or presumed safety (also See Appendix-2).

Frequency of spontaneous as well as drug induced malformations, especially neural tube defects, may be reduced by folate therapy during pregnancy.

11. Mutagenicity and Carcinogenicity

It refers to capacity of a drug to cause genetic defects and cancer respectively. Usually oxidation of the drug results in the production of reactive intermediates which affect genes and may cause structural changes in the chromosomes. Covalent

interaction with DNA can modify it to induce mutations, which may manifest as heritable defects in the next generation. If the modified DNA sequences code for factors that regulate cell proliferation/growth, i.e. are protooncogenes, or for proteins that inhibit transcription of protooncogenes, a tumour (cancer) may be produced. Even without interacting directly with DNA, certain chemicals can promote malignant change in genetically damaged cells, resulting in carcinogenesis. Chemical carcinogenesis generally takes several (10–40) years to develop. Drugs implicated in these adverse effects are—anticancer drugs, radioisotopes, estrogens, tobacco. Generally, drugs which show mutagenic or carcinogenic potential are not approved for marketing/are withdrawn, unless useful in life-threatening conditions.

12. Drug induced diseases

These are also called *iatrogenic* (physician induced) diseases, and are functional disturbances (disease) caused by drugs which persist even after the offending drug has been withdrawn and largely eliminated, e.g.:

- Peptic ulcer by salicylates and corticosteroids.
- Parkinsonism by phenothiazines and other antipsychotics.
- Hepatitis by isoniazid.
- DLE by hydralazine.

Drugs Acting on Autonomic Nervous System

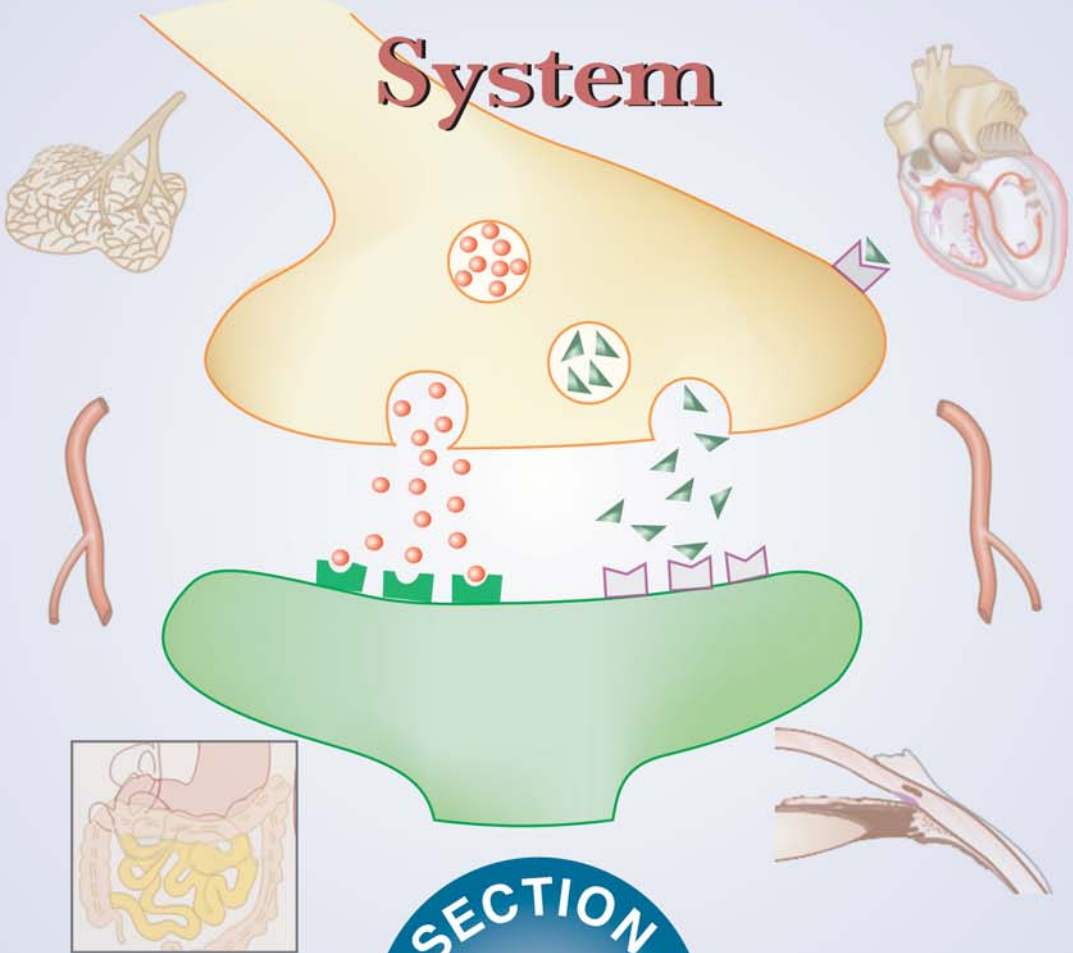

SECTION 2

Autonomic Nervous System: General Considerations

ORGANIZATION AND FUNCTION

The autonomic nervous system (ANS) functions largely below the level of consciousness and controls visceral functions. The major differences between the somatic and autonomic nervous systems are given in Table II.1.

Like the somatic nervous system, the ANS consists of afferents, centre and efferents.

Autonomic afferents Most visceral nerves are mixed nerves and carry nonmyelinated visceral afferent fibres. The cell bodies of these afferent fibres are located in the dorsal root ganglion of spinal nerves and the sensory ganglia (e.g. nodose ganglion of vagus) of cranial nerves. They mediate visceral pain as well as cardiovascular, respiratory and other visceral reflexes.

Central autonomic connections There are no exclusively autonomic areas in the CNS; considerable intermixing and integration of somatic and autonomic innervation occurs. The highest seat regulating autonomic functions is in the hypothalamus—posterior and lateral nuclei are primarily sympathetic while anterior and medial nuclei are primarily parasympathetic. Many autonomic centres (pupillary, vagal, respiratory, etc.) are located in the mid-brain and the medulla in relation to the cranial nerves. The lateral

column in the thoracic spinal cord contains cells which give rise to the sympathetic outflow.

Autonomic efferents The motor limb of the ANS is anatomically divided into sympathetic and parasympathetic. In general, these subdivisions are functionally antagonistic and most organs receive both sympathetic and parasympathetic innervation. The level of activity of innervated organ at a given moment is the algebraic sum of sympathetic and parasympathetic tone. However, refractory period of atrial fibres is decreased by sympathetic as well as parasympathetic influences. Most blood vessels, spleen, sweat glands and hair follicles receive only sympathetic, while ciliary muscle, gastric and pancreatic glands receive only parasympathetic innervation.

The enteric plexus of nerves receives inputs from both sympathetic and parasympathetic divisions, but in addition functions independently to integrate bowel movements as well as regulate secretion and absorption (*see* Fig. 47.2). As such, it has also been labelled as a distinct '*enteric nervous system*'.

The general layout of ANS is depicted in Fig. II.1 and the important differences between its two subdivisions are given in Table II.2.

Table II.1: Differences between somatic and autonomic nervous system

	<i>Somatic</i>	<i>Autonomic</i>
1. Organ supplied	Skeletal muscles	All other organs
2. Distal most synapse	Within CNS	Outside CNS (in ganglia)
3. Nerve fibres	Myelinated	Pregang.—myelinated Postgang.—non-myelinated
4. Peripheral plexus formation	Absent	Present
5. Efferent transmitter	Acetylcholine	Acetylcholine, Noradrenaline
6. Effect of nerve section on organ supplied	Paralysis and atrophy	Activity maintained, no atrophy

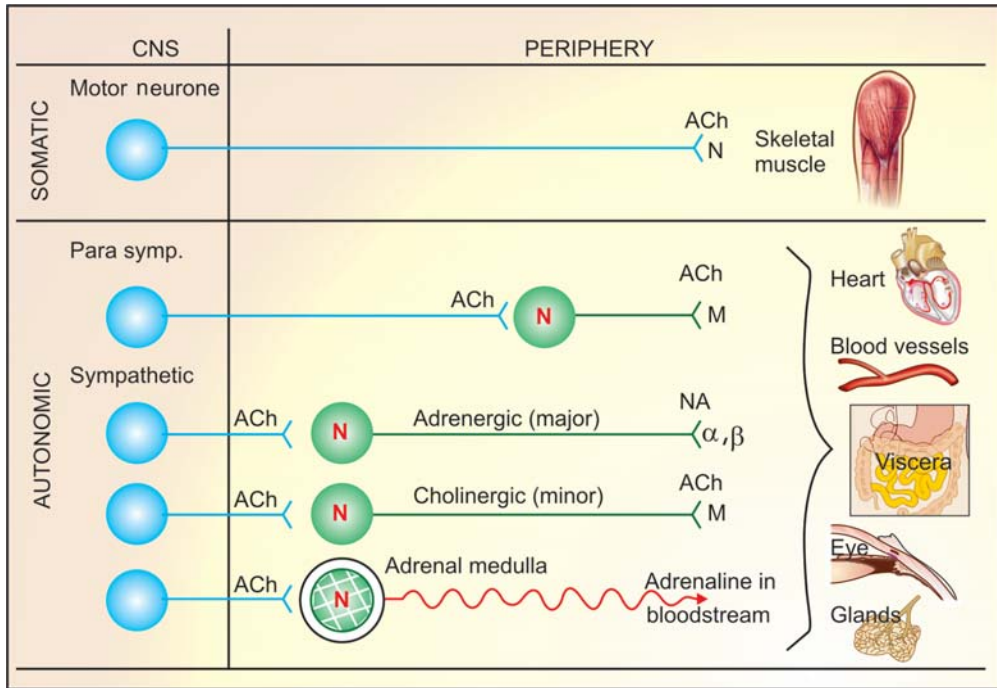

Fig. II.1: The general outlay of efferent autonomic nervous system. The transmitter released and the primary postjunctional receptor subtype is shown at each synapse/neuroeffector junction
 N = Nicotinic, M = Muscarinic, α = α adrenergic, β = β adrenergic

Table II.2: Differences between sympathetic and parasympathetic divisions of the autonomic nervous system

	<i>Sympathetic</i>	<i>Parasympathetic</i>
1. Origin	Dorso-lumbar (T ₁ to L ₂ or L ₃)	Cranio-sacral (III, VII, IX, X; S ₂ -S ₄)
2. Distribution	Wide	Limited to head, neck and trunk
3. Ganglia	Away from organs	On or close to the organ
4. Postgang. fibre	Long	Short
5. Pre: post ganglionic fibre ratio	1: 20 to 1: 100	1: 1 to 1: 2 (except in enteric plexuses)
6. Transmitter (neuroeffector)	Noradrenaline (major) Acetylcholine (minor)	Acetylcholine
7. Stability of transmitter	NA stable, diffuses for wider actions	ACh—rapidly destroyed locally
8. Important function	Tackling stress and emergency	Assimilation of food, conservation of energy

NEUROHUMORAL TRANSMISSION

Neurohumoral transmission implies that nerves transmit their message across synapses and neuroeffector junctions by the release of humoral (chemical) messengers.

Junctional transmission was thought to be electrical (it does occur in some lower animals and probably in certain areas of mammalian brain) but observations at the turn of last century prompted Elliott (1905) to suggest that sympathetic nerves functioned by the release of an

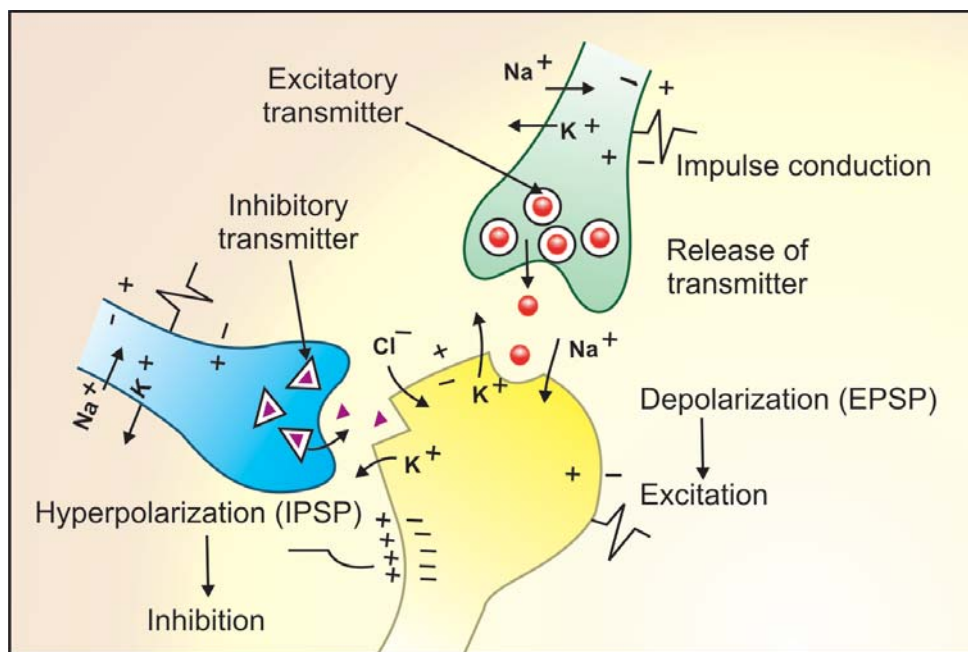

Fig. II.2: Diagrammatic representation of steps in excitatory and inhibitory neurohumoral transmission: EPSP = Excitatory postsynaptic potential; IPSP = Inhibitory postsynaptic potential

adrenaline-like substance, and Dixon (1907) to propose that vagus released a muscarine like chemical. Otto Loewi (1921) provided direct proof of humoral transmission by perfusing two frog hearts in series. Stimulation of vagus nerve of the first heart caused arrest of both. Thus, a chemical must have been released by vagal stimulation in the first heart which passed in the perfusate and arrested the second heart. This *vagusstoff* was found in 1926 to be acetylcholine, which earlier Dale (1914) had characterised as 'parasympathomimetic'. The sympathetic transmitter was eventually shown to be noradrenaline in 1946 by Von Euler. Many humoral transmitters (dopamine, 5-HT, GABA, purines, peptides, etc.) are now known.

To be considered as a postjunctionally acting neurohumoral transmitter a substance must fulfill the following criteria:

- (i) It should be present in the presynaptic neurone (usually along with enzymes synthesizing it).

- (ii) It should be released in the medium following nerve stimulation.
- (iii) Its application should produce responses identical to those produced by nerve stimulation.
- (iv) Its effects should be antagonized or potentiated by other substances which similarly alter effects of nerve stimulation.

Steps in neurohumoral transmission

I. Impulse conduction The resting transmembrane potential (70 mV negative inside) is established by high K⁺ permeability of axonal membrane and high axoplasmic concentration of this ion coupled with low Na⁺ permeability and its active extrusion from the neurone. Stimulation or arrival of an electrical impulse causes a sudden increase in Na⁺ conductance → depolarization and overshoot (reverse polarization: inside becoming 20 mV positive); K⁺ ions then move out in the direction of their

concentration gradient and repolarization occurs. Ionic distribution is normalized during the refractory period by the activation of $\text{Na}^+ \text{K}^+$ pump. The action potential (AP) thus generated sets up local circuit currents which activate ionic channels at the next excitable part of the membrane (next node of Ranvier in myelinated fibre) and the AP is propagated without decrement.

Tetrodotoxin (from puffer fish) and saxitoxin (from certain shell-fish) selectively abolish increase in Na^+ conductance in nerve fibres and thus block impulse conduction.

II. Transmitter release The transmitter (excitatory or inhibitory) is stored in prejunctional nerve endings within 'synaptic vesicles' (Fig. II.2). Nerve impulse promotes fusion of vesicular and axonal membranes through Ca^{2+} entry which fluidizes membranes. All contents of the vesicle (transmitter, enzymes and other proteins) are extruded (exocytosis) in the junctional cleft.

A number of proteins like synaptotagmin, synaptobrevin, neurexin, syntaxin and synaptophysin located on the vesicular and axonal membranes have been found to participate in the docking and fusion of the synaptic vesicles with the axonal membrane resulting in exocytosis. These proteins can be targets of drug action to modify junctional transmission.

The release process can be modulated by the transmitter itself and by other agents through activation of specific receptors located on the prejunctional membrane, e.g. noradrenaline (NA) release is inhibited by NA (α_2 receptor), dopamine, adenosine, prostaglandins and enkephalins while isoprenaline (β_2 receptor) and angiotensin (AT_1 receptor) increase NA release. Similarly, α_2 and muscarinic agonists inhibit acetylcholine (ACh) release at autonomic neuroeffector sites (but not in ganglia and skeletal muscles).

III. Transmitter action on postjunctional membrane The released transmitter combines with specific receptors on the postjunctional membrane and depending on its nature induces an excitatory postsynaptic potential (EPSP) or an inhibitory postsynaptic potential (IPSP).

EPSP Increase in permeability to all cations \rightarrow Na^+ or Ca^{2+} influx (through fast or slow channels) causes *depolarization* followed by K^+ efflux. These ionic movements are passive as the flow is down the concentration gradients.

IPSP Increase in permeability to smaller ions, i.e. K^+ and Cl^- (hydrated K^+ ion is smaller than hydrated Na^+ ion) only, so that K^+ moves out and Cl^- moves in (in the direction of their concentration gradients) resulting in *hyperpolarization*.

In addition, a trophic influence on junctional morphology and functional status is exerted by the background basal release of the transmitter.

IV. Postjunctional activity A suprathreshold EPSP generates a propagated postjunctional AP which results in nerve impulse (in neurone), contraction (in muscle) or secretion (in gland). An IPSP stabilizes the postjunctional membrane and resists depolarizing stimuli.

V. Termination of transmitter action Following its combination with the receptor, the transmitter is either locally degraded (e.g. ACh) or is taken back into the prejunctional neurone by active uptake or diffuses away (e.g. NA, GABA). Specific carrier proteins like norepinephrine transporter (NET), dopamine transporter (DAT), serotonin transporter (SERT) are expressed on the axonal membrane for this purpose. The rate of termination of transmitter action governs the rate at which responses can be transmitted across a junction (1 to 1000/sec).

Cotransmission

It has now become apparent that the classical 'one neurone—one transmitter' model is an over simplification. Most peripheral and central neurones have been shown to release more than one active substance when stimulated. In the ANS, besides the primary transmitters ACh and NA, neurones have been found to elaborate purines (ATP, adenosine), peptides (vasoactive intestinal peptide or VIP, neuropeptide-Y or NPY, substance P, enkephalins, somatostatin, etc.), nitric oxide and prostaglandins as co-transmitters. In most autonomic cholinergic neurones VIP is associated

with ACh, while ATP is associated with both ACh and NA. Vascular adrenergic nerves contain NPY which causes long lasting vasoconstriction. The cotransmitter is stored in the same neurone but in distinct synaptic vesicles or locations (Fig. II.3). However, ATP is stored with NA in the same vesicle. On being released by the nerve impulse it may serve to regulate the presynaptic release of the primary transmitter and/or postsynaptic sensitivity to it (neuromodulator role). The cotransmitter may also serve as an alternative transmitter in its own right and/or exert a trophic influence on the synaptic structures.

Nonadrenergic, noncholinergic (NANC) transmission has been demonstrated in the autonomic innervation of the gut, vas deferens, urinary tract, salivary glands and certain blood vessels, where nerve stimulation is able to evoke limited responses even in the presence of total adrenergic and cholinergic blockade. For example, it has been shown that stimulation of sympathetic nerve to guinea pig vas deferens elicits a biphasic contractile response, the initial short-lasting phase of which is mediated by ATP (through P2 receptors) and the second longer lasting phase by NA (through α_1 receptors). Many anomalous findings have been explained by the revelation of cotransmission.

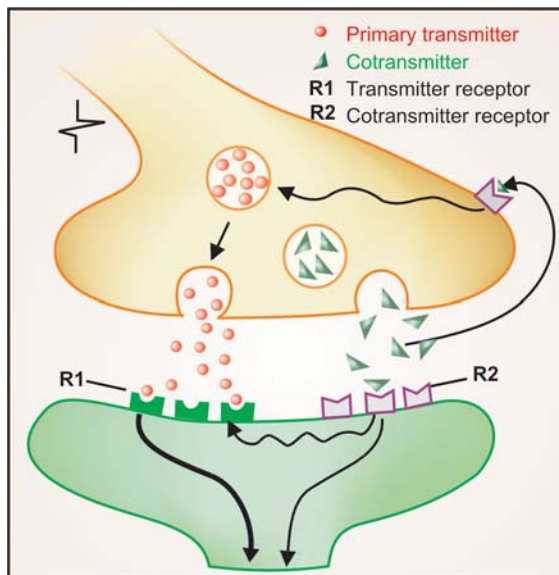
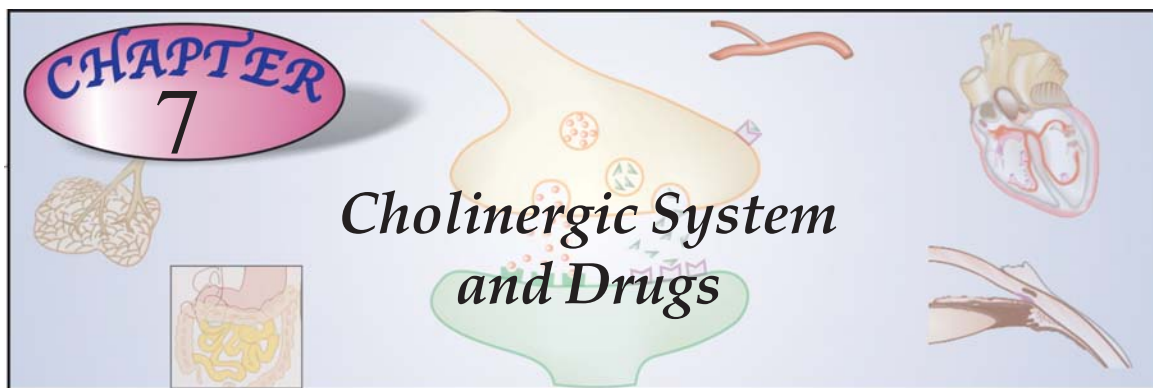

Fig. II.3: Cotransmission

The cotransmitter is stored in the prejunctional nerve terminal along with the primary transmitter, but in separate vesicles (in some cases in the same vesicle itself). Nerve impulse releases both the transmitters concurrently. Acting on its own receptors, the cotransmitter modifies responsiveness of the effector to the primary transmitter or substitutes for it. Cotransmitter may also act on prejunctional receptors and modulate release of the transmitters



CHOLINERGIC TRANSMISSION

Acetylcholine (ACh) is a major neurohumoral transmitter at autonomic, somatic as well as central sites. These sites are listed in Table 7.1

Synthesis, storage and destruction of ACh

The cholinergic neuronal mechanisms are summarized in Fig. 7.1.

Acetylcholine is synthesized locally in the cholinergic nerve endings by the following pathway—

ATP + Acetate + CoEn-A

↓ Acetate activating reaction
Acetyl CoEn-A

CHOLINE ↓ Choline acetyl transferase
ACETYLCHOLINE + CoEn-A

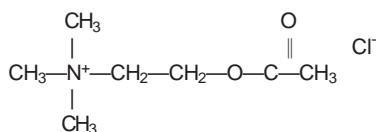

ACETYLCHOLINE CHLORIDE

Choline is actively taken up by the axonal membrane by a Na^+ : choline cotransporter and

acetylated with the help of ATP and coenzyme-A by the enzyme *choline acetyl transferase* present in the axoplasm. *Hemicholinium* blocks choline uptake (the rate limiting step in ACh synthesis) and depletes ACh. Most of the ACh is stored in ionic solution within small synaptic vesicles, but some free ACh is also present in the cytoplasm of cholinergic terminals. Active transport of ACh into synaptic vesicles is effected by another carrier which is blocked by *vesamicol*.

Release of ACh from nerve terminals occurs in small quanta—amount contained in individual vesicles is extruded by exocytosis. In response to a nerve AP synchronous release of multiple quanta triggers postjunctional events.

Two toxins interfere with cholinergic transmission by affecting release: *botulinus toxin* inhibits release, while *black widow spider toxin* induces massive release and depletion. Immediately after release, ACh is hydrolyzed by the enzyme cholinesterase and choline is recycled.

A specific (*Acetylcholinesterase*—AChE or true cholinesterase) and a nonspecific (*Butyrylcholinesterase*—BuChE or pseudocholinesterase) type of enzyme occurs in the body; important differences between these two types are given in Table 7.2. While AChE is strategically located at all cholinergic sites and serves to inactivate ACh instantaneously, BuChE present in plasma and

Table 7.1: Sites of cholinergic transmission and type of receptor involved

	Site	Type of receptor	Selective agonist	Selective antagonist
1.	a. All postganglionic parasymp.	Muscarinic	Muscarine	Atropine
	b. Few postganglionic symp. (sweat glands, some blood vessels)			
2.	a. Ganglia (both symp. and parasymp).	Nicotinic (N _N)	DMPP*	Hexamethonium
	b. Adrenal medulla			
3.	Skeletal muscles	Nicotinic (N _M)	PTMA**	Curare
4.	CNS (cortex, basal ganglia, spinal cord and other sites)	Muscarinic	Muscarine/ Oxotremorine	Atropine
		Nicotinic	Carbachol	Curare

* DMPP—Dimethyl phenyl piperazinium

** PTMA—Phenyl trimethyl ammonium

elsewhere probably serves to metabolize ingested esters.

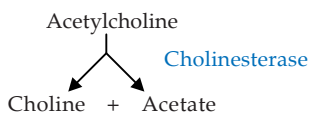

Cholinoceptors

Two classes of receptors for ACh are recognised—muscarinic and nicotinic; the former is a G protein coupled receptor, while the latter is a ligand gated cation channel.

Muscarinic These receptors are selectively stimulated by muscarine and blocked by atropine. They are located primarily on autonomic effector cells in heart, blood vessels, eye, smooth muscles and glands of gastrointestinal, respiratory and urinary tracts, sweat glands, etc. and in the CNS. Subsidiary muscarinic receptors are also present in autonomic ganglia where they appear to play a modulatory role by inducing a long-lasting late EPSP.

Muscarinic autoreceptors are present prejunctionally on postganglionic cholinergic nerve endings: their activation inhibits further ACh release. Similar ones have been demonstrated on adrenergic terminals: their activation inhibits NA release (may contribute to vasodilator action of injected ACh). All blood vessels have muscarinic receptors (though most of them lack cholinergic innervation) located on endothelial cells whose activation releases EDRF which diffuses to the smooth muscle to cause relaxation.

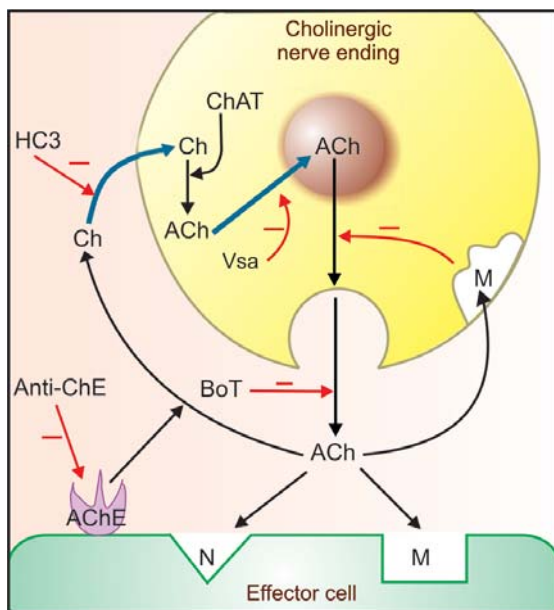

Fig. 7.1: Cholinergic neuronal mechanisms

Minus sign indicates inhibition while bold blue arrow indicates active transport.

Ch—Choline, ACh—Acetylcholine, ChAT—Choline acetyl transferase, AChE—Acetylcholinesterase, Anti-ChE—Anticholinesterase, M—Muscarinic receptor, N—Nicotinic receptor, HC3—Hemicholinium, BoT—Botulinus toxin, Vsa—Vesamicol

Subtypes of muscarinic receptor By pharmacological as well as molecular cloning techniques, muscarinic receptors have been divided into 5 subtypes M₁, M₂, M₃, M₄ and M₅. The first

Table 7.2: Differences between the two types of cholinesterases

	<i>Acetylcholinesterase (True)</i>	<i>Butyrylcholinesterase (Pseudo)</i>
1. Distribution	All cholinergic sites, RBC, gray matter	Plasma, liver, intestine, white matter
2. Hydrolysis		
ACh	Very fast (in μ s)	Slow
Methacholine	Slower than ACh	Not hydrolysed
Benzoylcholine	Not hydrolysed	Hydrolysed
Butyrylcholine	Not hydrolysed	Hydrolysed
3. Inhibition	More sensitive to physostigmine	More sensitive to organophosphates
4. Function	Termination of ACh action	Hydrolysis of ingested esters

3 are the major subtypes (Table 7.3) that are present on effector cells as well as on prejunctional nerve endings, and are expressed both in peripheral organs as well as in the CNS. The M_4 and M_5 receptors are present mainly on nerve endings in certain areas of the brain and regulate the release of other neurotransmitters. Functionally, M_1 , M_3 and M_5 fall in one class while M_2 and M_4 fall in another class. Muscarinic agonists have shown little subtype selectivity, but antagonists (pirenzepine for M_1 ,

tripitramine for M_2 and darifenacin for M_3) are more selective. Most organs have more than one subtype, but usually one subtype predominates in a given tissue.

M_1 : The M_1 is primarily a neuronal receptor located on ganglion cells and central neurones, especially in cortex, hippocampus and corpus striatum. It plays a major role in mediating gastric secretion, relaxation of lower esophageal sphincter (LES) on vagal stimulation and in learning, memory, motor functions, etc.

Table 7.3: Characteristics of important subtypes of muscarinic receptor

	M_1	M_2	M_3	
1. Location and function subserved	<i>Autonomic ganglia:</i> <i>Gastric glands:</i> CNS:	Depolarization (late EPSP) Hist. release, acid secretion Learning, memory, motor functions	<i>SA node:</i> Hyperpolarization, \downarrow rate of impulse generation <i>AV node:</i> \downarrow velocity of conduction <i>Atrium:</i> shortening of APD, \downarrow contractility <i>Ventricle:</i> \downarrow contractility (slight) (receptors sparse) <i>Cholinergic nerve endings:</i> \downarrow ACh release CNS: tremor, analgesia <i>Visceral smooth muscle:</i> contraction	<i>Visceral smooth muscle:</i> contraction <i>Iris:</i> constriction of pupil <i>Ciliary muscle:</i> contraction <i>Exocrine glands:</i> secretion <i>Vascular endothelium:</i> release of NO \rightarrow vasodilatation
2. Nature	G-protein coupled, 7-TM	G-protein coupled, 7-TM	G-protein coupled, 7-TM	
3. Transducer mechanism	$IP_3/DAG \rightarrow \uparrow$ cytosolic Ca^{2+} , $PLA_2 \uparrow \rightarrow$ PG synthesis	K^+ channel opening, \downarrow cAMP	$IP_3/DAG \rightarrow \uparrow$ cytosolic Ca^{2+} $PLA_2 \uparrow \rightarrow$ PG synthesis	
4. Agonists*	MCN-343A, Oxotremorine	Methacholine	Bethanechol	
5. Antagonists*	Pirenzepine, Telenzepine	Methoctramine, Tripitramine	Hexahydrosiladifenidol, Darifenacin	

*Relatively selective; 7-TM—seven transmembrane amino acid sequences.

— ACh activates and atropine blocks all 3 subtypes of muscarinic receptors.

— The CNS contains all subtypes of muscarinic receptors, but M_1 appear to predominate.

— Most smooth muscles and glands have both M_2 and M_3 subtypes; M_3 predominates.

Table 7.4: Characteristics of subtypes of nicotinic receptor

	N_M	N_N
1. Location and function subserved	<i>Neuromuscular junction:</i> depolarization of muscle end plate —contraction of skeletal muscle	<i>Autonomic ganglia:</i> depolarization —postganglionic impulse <i>Adrenal medulla:</i> catecholamine release <i>CNS:</i> site specific excitation or inhibition
2. Nature	Has intrinsic ion channel, pentamer of $\alpha 2 \beta \epsilon$ or γ and δ subunits, each subunit has 4 TM	Has intrinsic ion channel, pentamer of only $\alpha \beta$ subunits, each subunit has 4 TM
3. Transducer mechanism	Opening of cation (Na^+ , K^+) channels	Opening of cation (Na^+ , K^+ , Ca^{2+}) channels
4. Agonists	PTMA, Nicotine	DMPP, Nicotine
5. Antagonists	Tubocurarine, α -Bungarotoxin	Hexamethonium, Trimethaphan

M₂: Cardiac muscarinic receptors are predominantly M₂ and mediate vagal bradycardia. Autoreceptors on cholinergic nerve endings are also of M₂ subtype. Smooth muscles express some M₂ receptors as well which, like M₃, mediate contraction.

M₃: Visceral smooth muscle contraction and glandular secretions are elicited through M₃ receptors, which also mediate vasodilatation through EDRF release. Together the M₂ and M₃ receptors mediate most of the well-recognized muscarinic actions including contraction of LES.

The muscarinic receptors are G-protein coupled receptors having the characteristic 7 membrane traversing amino acid sequences. The M₁ and M₃ (also M₅) subtypes function through G_q protein and activate membrane bound phospholipase C (PLC)—generating inositol trisphosphate (IP₃) and diacylglycerol (DAG) which in turn release Ca²⁺ intracellularly—cause depolarization, glandular secretion and raise smooth muscle tone. They also activate phospholipase A₂ resulting in enhanced synthesis and release of prostaglandins and leucotrienes in certain tissues. The M₂ (and M₄) receptor opens K⁺ channels (through $\beta\gamma$ subunits of regulatory protein G_i) and inhibits adenylyl cyclase (through α subunit of G_i) resulting in hyperpolarization, reduced pacemaker activity, slowing of conduction and decreased force of contraction in the heart. The M₄ receptor has been implicated in facilitation/inhibition of transmitter release in certain areas of the brain, while M₅ has been found to facilitate dopamine release and mediate reward behaviour.

Nicotinic These receptors are selectively activated by nicotine and blocked by tubocurarine or hexamethonium. They are rosette-like pentameric

structures (see Fig. 4.4) which enclose a ligand gated cation channel: their activation causes opening of the channel and rapid flow of cations resulting in depolarization and an action potential. On the basis of location and selective agonists and antagonists two subtypes N_M and N_N (previously labelled N₁ and N₂) are recognized (Table 7.4).

N_M: These are present at skeletal muscle endplate: are selectively stimulated by phenyl trimethyl ammonium (PTMA) and blocked by tubocurarine. They mediate skeletal muscle contraction.

N_N: These are present on ganglionic cells (sympathetic as well as parasympathetic), adrenal medullary cells (embryologically derived from the same site as ganglionic cells) and in spinal cord and certain areas of brain. They are selectively stimulated by dimethyl phenyl piperazinium (DMPP), blocked by hexamethonium, and constitute the primary pathway of transmission in ganglia.

CHOLINERGIC DRUGS (Cholinomimetic, Parasympathomimetic)

These are drugs which produce actions similar to that of ACh, either by directly interacting with cholinergic receptors (cholinergic agonists) or by increasing availability of ACh at these sites (anticholinesterases).

CHOLINERGIC AGONISTS

<i>Choline esters</i>	<i>Alkaloids</i>
Acetylcholine	Muscarine
Methacholine	Pilocarpine
Carbachol	Arecoline
Bethanechol	

ACTIONS (of ACh as prototype)

Depending on the type of receptor through which it is mediated, the peripheral actions of ACh are classified as muscarinic or nicotinic. The central actions are not so classifiable and are described separately.

A. Muscarinic

1. Heart ACh hyperpolarizes the SA nodal cells and decreases the rate of diastolic depolarization. As a result, rate of impulse generation is reduced—*bradycardia* or even cardiac arrest may occur.

At the A-V node and His-Purkinje fibres refractory period (RP) is increased and *conduction is slowed*: P-R interval increases and partial to complete A-V block may be produced. The *force of atrial contraction is markedly reduced* and RP of atrial fibres is abbreviated. Due to nonuniform vagal innervation, the intensity of effect on RP and conduction of different atrial fibres varies—inducing inhomogeneity and predisposing to atrial fibrillation or flutter.

Ventricular contractility is also decreased but the effect is not marked. The cardiac muscarinic receptors are of the M₂ subtype.

2. Blood vessels All blood vessels are dilated, though only few (skin of face, neck, salivary glands) receive cholinergic innervation. Fall in BP and flushing, especially in the blush area occurs. Muscarinic (M₃) receptors are present on vascular endothelial cells: vasodilatation is primarily mediated through the release of an *endothelium dependent relaxing factor* (EDRF) which is nitric oxide (NO). It may also be due to inhibitory action of ACh on NA release from tonically active vasoconstrictor nerve endings.

Stimulation of cholinergic nerves to the penis causes erection by releasing NO and dilating cavernosal vessels through M₃ receptors. However, this response is minimal with injected cholinomimetic drugs.

3. Smooth muscle Smooth muscle in most organs is contracted (mainly through M₃ receptors). Tone and peristalsis in the gastrointestinal tract is increased and sphincters relax → abdominal cramps and evacuation of bowel.

Peristalsis in ureter is increased. The detrusor muscle contracts while the bladder trigone and sphincter relaxes → voiding of bladder.

Bronchial muscles constrict, asthmatics are highly sensitive → dyspnoea, precipitation of an attack of bronchial asthma.

4. Glands Secretion from all parasympathetically innervated glands is increased *via* M₃ and some M₂ receptors: sweating, salivation, lacrimation, tracheobronchial and gastric secretion. The effect on pancreatic and intestinal glands is not marked. Secretion of milk and bile is not affected.

5. Eye Contraction of circular muscle of iris → miosis.

Contraction of ciliary muscle → spasm of accommodation, increased outflow facility, reduction in intraocular tension (especially in glaucomatous patients).

B. Nicotinic

1. Autonomic ganglia Both sympathetic and parasympathetic ganglia are stimulated. This effect is manifested at higher doses. High dose of ACh given after atropine causes tachycardia and rise in BP due to stimulation of sympathetic ganglia and release of catecholamines.

2. Skeletal muscles Iontophoretic application of ACh to muscle endplate causes contraction of the fibre. Intraarterial injection of high dose can cause twitching and fasciculations, but i.v. injection is generally without any effect (due to rapid hydrolysis of ACh).

C. CNS

ACh injected i.v. does not penetrate blood-brain barrier and no central effects are seen. However, direct injection into the brain, or other cholinergic drugs which enter brain, produce a complex pattern of stimulation followed by depression. The important features of other choline esters are summarized in Table 7.5.

Table 7.5: Properties of choline esters

Choline ester	Hydrolysis by		Actions		Selective action on
	ACh E	BuChE	Musc.	Nico.	
Acetylcholine	++	+	+	+	Non selective
Methacholine	+	-	+	±	CVS
Carbachol	-	-	+	+	g.i.t., bladder
Bethanechol	-	-	+	-	g.i.t., bladder

Interactions Anticholinesterases potentiate ACh markedly, methacholine to less extent and have only additive action with carbachol or bethanechol, depending upon the role of ChE in the termination of action of the particular choline ester. Atropine and its congeners competitively antagonize muscarinic actions.

Adrenaline is a physiological antagonist.

Uses Choline esters are rarely, if ever, clinically used. ACh is not used because of evanescent and nonselective action. Methacholine was occasionally used to terminate paroxysmal supraventricular tachycardia but is obsolete now.

Bethanechol has been used in postoperative/postpartum nonobstructive urinary retention, neurogenic bladder, congenital megacolon and gastroesophageal reflux. Side effects are prominent: belching, colic, involuntary urination/defecation, flushing, sweating, fall in BP, bronchospasm.

Dose: 10–40 mg oral, 2.5–5 mg s.c.; **UROTONIN 25 mg tab.**

CHOLINOMIMETIC ALKALOIDS

Pilocarpine It is obtained from the leaves of *Pilocarpus microphyllus* and other species. It has prominent muscarinic actions and also stimulates ganglia—mainly through ganglionic muscarinic receptors.

Pilocarpine causes marked sweating, salivation and increases other secretions as well. The cardiovascular effects are complex. Small doses generally cause fall in BP (muscarinic), but higher doses elicit rise in BP and tachycardia which is probably due to ganglionic stimulation (through ganglionic muscarinic receptors). Applied to the eye, it penetrates cornea and promptly causes miosis, ciliary muscle contraction and fall in intraocular tension lasting 4–8 hours.

Pilocarpine is used only in the eye as 0.5–4% drops. It is a third-line drug in open angle glaucoma. An initial stinging sensation in the eye and painful spasm of accommodation are frequent side effects. Other uses as a miotic are—to counteract mydriatics after they have been used for testing refraction and to prevent/break adhesions of iris with lens or cornea by alternating it with mydriatics.

PILOCAR 1%, 2%, 4% eye drops, CARPINE 0.5% eyedrops, PILODROPS 2% eyedrops.

Muscarine It occurs in poisonous mushrooms *Amanita muscaria* and *Inocybe* species and has only muscarinic actions. It is not used therapeutically but is of toxicological importance.

Mushroom poisoning Depending on the toxic principle present in the particular species, at least 3 types of mushroom poisoning is known.

Muscarine type (Early mushroom poisoning) due to *Inocybe* and related species. Symptoms characteristic of muscarinic actions appear within an hour of eating the mushroom, and are promptly reversed by atropine.

Hallucinogenic type It is due to muscimol and other isoxazole compounds which are present in *A. muscaria* and related mushrooms in much larger quantities than is muscarine. These compounds activate amino acid receptors, and block muscarinic receptors in the brain; have hallucinogenic property. Manifestations of poisoning are primarily central. There is no specific treatment and atropine is contraindicated. Another hallucinogenic mushroom is *Psilocybe mexicana* whose active principle psilocybine is a tryptaminergic (5-HT related) compound.

Phalloidin type (Late mushroom poisoning) It is due to peptide toxins found in *A. phalloides*, *Galerina* and related species. These inhibit RNA and protein synthesis. The symptoms start after many hours and are due to damage to the gastrointestinal mucosa, liver and kidney. Treatment consists of supportive measures. Thioctic acid may have some antidotal effect.

Arecoline It is found in betel nut *Areca catechu* and has muscarinic as well as nicotinic actions, including those on skeletal muscle endplate. It also has prominent CNS effect: has been tried in dementia as an enhancer of cognitive functions, but not found useful—has no therapeutic use.

ANTICHOLINESTERASES

Anticholinesterases (anti-ChEs) are agents which inhibit ChE, protect ACh from hydrolysis—produce cholinergic effects *in vivo* and potentiate ACh both *in vivo* and *in vitro*. Some anti ChEs have additional direct action on cholinergic receptors.

Reversible

<i>Carbamates</i>	<i>Acridine</i>
Physostigmine (Eserine)	Tacrine
Neostigmine	
Pyridostigmine	
Edrophonium	
Rivastigmine, Donepezil	
Galantamine	

Irreversible

<i>Organophosphates</i>	<i>Carbamates</i>
Dyflor (DFP)	Carbaryl* (SEVIN)
Echothiophate	Propoxur* (BAYGON)
Parathion*, Malathion*	*Insecticides
Diazinon* (TIK-20)	†Nerve gases for
Tabun†, Sarin†, Soman†	chemical warfare

CHEMISTRY

Anti-ChEs are either esters of carbamic acid or derivatives of phosphoric acid.

The generic formula of carbamates and organophosphates is shown below:

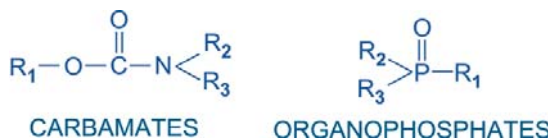

In carbamates R₁ may have a nonpolar tertiary amino N, e.g. in physostigmine, rendering the compound lipid soluble. In others, e.g. neostigmine, R₁ has a quaternary N⁺—rendering it lipid

insoluble. All organophosphates are highly lipid soluble except echothiophate which is water soluble.

MECHANISM OF ACTION

The anti-ChEs react with the enzyme essentially in the same way as ACh. The carbamates and phosphates respectively carbamylate and phosphorylate the esteratic site of the enzyme.

The mammalian AChE has been cloned and details of its structure as well as mode of interaction with ACh and various anti-ChEs has been worked out.

The active region of AChE forms a gorge which contains an aromatic *anionic site* (near tryptophan 86) and an *esteratic site* formed by serine 203, glutamate 334, histidine 447 (Fig. 7.2A). Hydrolysis of ACh involves electrostatic attraction of positively charged N⁺ of ACh to the aromatic pocket (Fig. 7.2B) and nucleophilic attack by serine-OH which is activated by the adjacent histidine leading to acetylation of serine (Fig. 7.2C). The acetylated enzyme reacts with water to produce acetic acid and choline (Fig. 7.2D).

Whereas the acetylated enzyme reacts with water extremely rapidly and the esteratic site is freed in a fraction of a millisecond, the carbamylated enzyme (reversible inhibitors) reacts slowly (Fig. 7.2E, F) and the phosphorylated enzyme (irreversible inhibitors) reacts extremely slowly or not at all (Fig. 7.2G). It is noteworthy that edrophonium and tacrine attach only to the anionic site of the enzyme, while organophosphates attach only to the esteratic site. Reactivation of edrophonium and tacrine inhibited enzyme does not involve hydrolysis of the inhibitor, but only its diffusion—action is brief. The half-life of reactivation of carbamylated enzyme (about 30 min) is less than that of synthesis of fresh enzyme protein, while that of phosphorylated enzyme is more than the regeneration time. The phosphorylated enzyme may also undergo ‘aging’ by the loss of one of the alkyl groups and become totally resistant to hydrolysis. Thus, apparently reversible and irreversible enzyme inhibition is obtained, though the basic pattern of inhibitor-enzyme interaction remains the same.

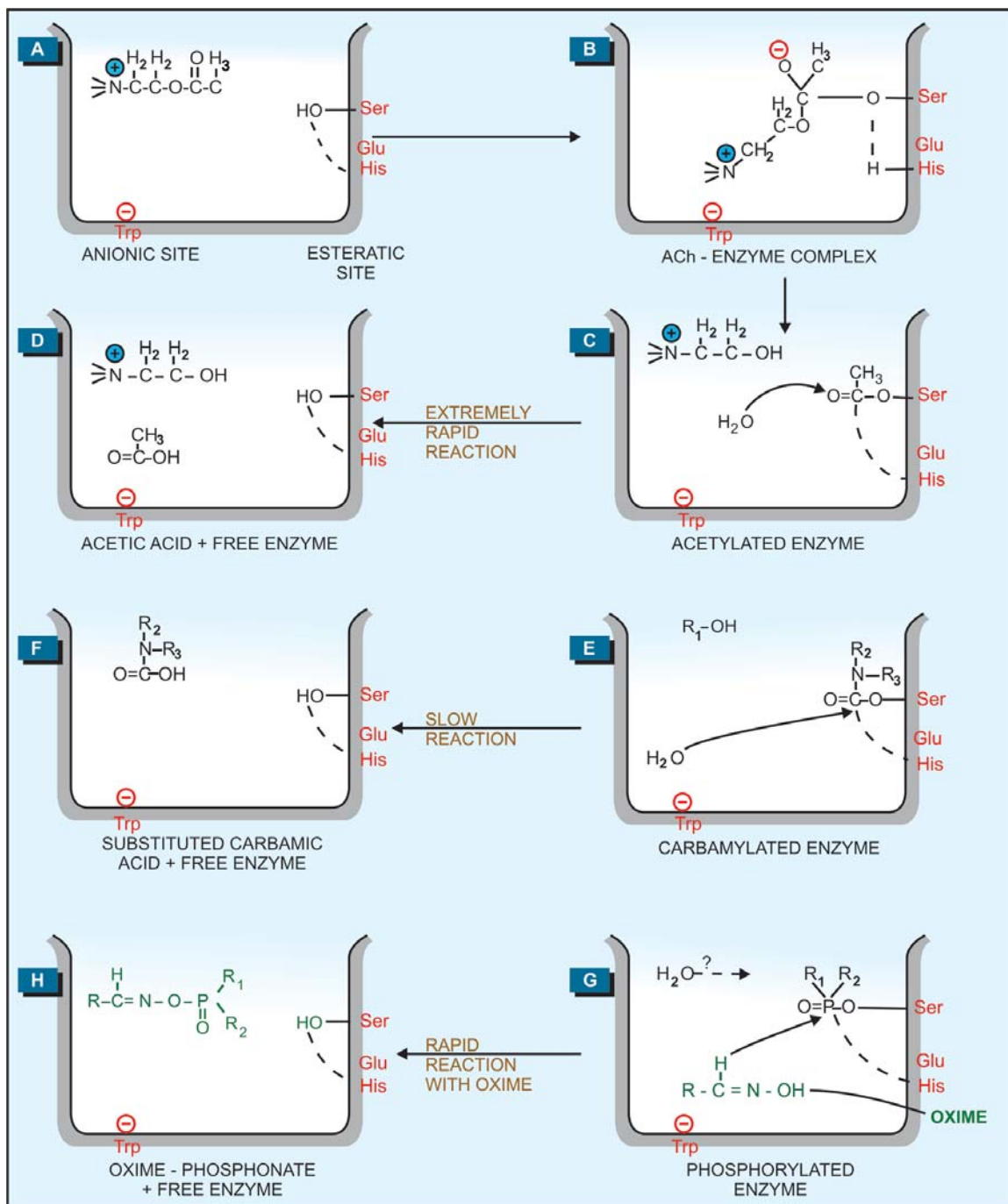

Fig. 7.2: Schematic representation of reaction of acetylcholine (A-D), or carbamate anticholinesterase (E, F), or organophosphate anticholinesterase (G) with cholinesterase enzyme; and reactivation of phosphorylated enzyme by oxime (G, H). Ser—Serine; His—Histidine; Glu—Glutamic acid; Trp—Tryptophan

PHARMACOLOGICAL ACTIONS

The actions of anti-ChEs are qualitatively similar to that of directly acting cholinergic stimulants. However, relative intensity of action on muscarinic, ganglionic, skeletal muscle and CNS sites varies among the different agents.

Lipid-soluble agents (physostigmine and organophosphates) have more marked muscarinic and CNS effects; stimulate ganglia but action on skeletal muscles is less prominent.

Lipid-insoluble agents (neostigmine and other quaternary ammonium compounds) produce more marked effect on the skeletal muscles (direct action on muscle endplate cholinergic receptors as well), stimulate ganglia, but muscarinic effects are less prominent. They do not penetrate CNS and have no central effects.

Ganglia Local hydrolysis of ACh is less important in ganglia: inactivation occurs partly by diffusion and hydrolysis in plasma. Anti-ChEs stimulate ganglia primarily through muscarinic receptors present there. High doses cause persistent depolarization of the ganglionic nicotinic receptors and blockade of transmission.

CVS Cardiovascular effects are complex. Whereas muscarinic action would produce bradycardia and hypotension, ganglionic stimulation would tend to increase heart rate and BP. Action on medullary centres (stimulation followed by depression) further complicates the picture, so does ganglionic blockade with high doses. Thus, the overall effects are often unpredictable and depend on the agent and its dose.

Skeletal muscles After treatment with anti-ChEs, the ACh released by a single nerve impulse is not immediately destroyed—rebinds to the same receptor, diffuses to act on neighbouring receptors and activates prejunctional fibres → repetitive firing → twitching and fasciculations. Force of contraction in partially curarized and myasthenic muscles is increased. Higher doses cause persistent depolarization of endplates resulting in blockade of neuromuscular transmission → weakness and paralysis. Direct action of

neostigmine and its congeners at the muscle endplates results in augmentation of these features.

Other effects These result from stimulation of smooth muscles and glands of the gastrointestinal, respiratory, urinary tracts and in the eye.

PHARMACOKINETICS

Physostigmine It is rapidly absorbed from g.i.t. and parenteral sites. Applied to the eye, it penetrates cornea freely. It crosses blood-brain barrier and is disposed after hydrolysis by ChE.

Neostigmine and congeners These are poorly absorbed orally; oral dose is 20–30 times higher than parenteral dose. They do not effectively penetrate cornea or cross blood-brain barrier. They are partially hydrolysed and partially excreted unchanged in urine.

Organophosphates These are absorbed from all sites including intact skin and lungs. They are hydrolyzed as well as oxidized in the body and little is excreted unchanged.

INDIVIDUAL COMPOUNDS

The important features of physostigmine and neostigmine are presented in Table 7.6.

Physostigmine eye drops are usually prepared freshly by ophthalmology departments.

BI-MIOTIC 0.25% eye drops with 2% pilocarpine nitrate.

Neostigmine PROSTIGMIN, MYOSTIGMIN, TILS-TIGMIN 15 mg tab, 0.5 mg/ml in 1 ml and 5 ml inj.

Pyridostigmine Resembles neostigmine in all respects but is dose to dose less potent and longer acting, less frequent dosing is required in myasthenia gravis.

DISTINON, MYESTIN 60 mg tab; 1–3 tab TDS.

Ambenonium is another longacting congener used in myasthenia.

Edrophonium Resembles neostigmine in action, has a brief duration (10–30 min), suitable as a diagnostic agent for myasthenia gravis and for postoperative decurarization. Dose: 1–10 mg i.v.

Tacrine It is a lipophilic acridine compound which interacts with ChE in a manner analogous to edrophonium. It crosses blood-brain barrier and has a longer duration of action. By increasing brain ACh levels it has been found to

Table 7.6: Comparative features of physostigmine and neostigmine

	<i>Physostigmine</i>	<i>Neostigmine</i>
1. Source	Natural alkaloid from <i>Physostigma venenosum</i> (Calabar bean)	Synthetic
2. Chemistry	Tertiary amine derivative	Quaternary ammonium compound
3. Oral absorption	Good	Poor
4. CNS actions	Present	Absent
5. Applied to eye	Penetrates cornea	Poor penetration
6. Direct action on N _M cholinceptors	Absent	Present
7. Prominent effect on	Autonomic effectors	Skeletal muscles
8. Important use	Miotic (glaucoma)	Myasthenia gravis
9. Dose	0.5–1 mg oral/parenteral 0.1–1.0% eye drops	0.5–2.5 mg i.m./s.c. 15–30 mg orally
10. Duration of action	Systemic 4–6 hrs In eye 6 to 24 hrs	3–4 hrs.

produce partial symptomatic improvement in Alzheimer's disease (AD) *see* Ch. 35.

Rivastigmine This lipophilic relatively cerebroselective ChE inhibitor has been introduced for AD (*see* Ch. 35).

Donepezil Another centrally acting anti-AChE that has produced cognitive and behavioral improvement in AD. It is long-acting and suitable for once daily administration (*see* Ch. 35).

Galantamine This natural alkaloid inhibitor of cerebral AChE has in addition weak agonistic action on nicotinic receptors. It is being used to afford symptomatic relief in AD (*see* Ch. 35).

Dyflon It is Diisopropyl-fluoro-phosphate (DFP), a very potent and long-acting anti-ChE. It has been used as a miotic (0.025%) but is not preferred because it has to be used as oily solution, causes local irritation.

Echothiophate It is an organophosphate with quaternary structure. It is water soluble; local irritancy is low. A 0.025–0.25% solution is rarely used in resistant cases of glaucoma as it is a potent and long-acting (1–3 days) miotic.

Precautions Anti-ChEs are contraindicated in sick sinus, A-V conduction defects and hypotensive states. They are to be used cautiously in peptic ulcer, asthma, COPD and seizure patients.

USES

1. As miotic

(a) In glaucoma: Miotics increase the tone of ciliary muscle (attached to scleral spur) and

sphincter pupillae which pull on and somehow improve alignment of the trabeculae so that outflow facility is increased → i.o.t. falls in open angle glaucoma.

Pilocarpine is the preferred miotic. The action is rapid and short lasting (4–6 hr); 6–8 hourly instillation is required and even then i.o.t. may fluctuate inbetween. Diminution of vision, especially in dim light (due to constricted pupil), spasm of accommodation and brow pain are frequent side effects. Systemic effects—nausea, diarrhoea, sweating and bronchospasm may occur with higher concentration eye drops.

Physostigmine (0.1%) is used only to supplement pilocarpine. Miotics are now 3rd choice drugs, used only as add on therapy in advanced cases. However, they are effective in aphakic glaucoma. Pilocarpine (along with other drugs) is used in angle closure glaucoma as well.

(b) To reverse the effect of mydriatics after refraction testing.

(c) To prevent formation of adhesions between iris and lens or iris and cornea, and even to break those which have formed due to iritis, corneal ulcer, etc.—a miotic is alternated with a mydriatic.

2. Myasthenia gravis

Myasthenia gravis is an autoimmune disorder affecting about 1 in 10,000 population, due to development of antibodies directed to nicotinic

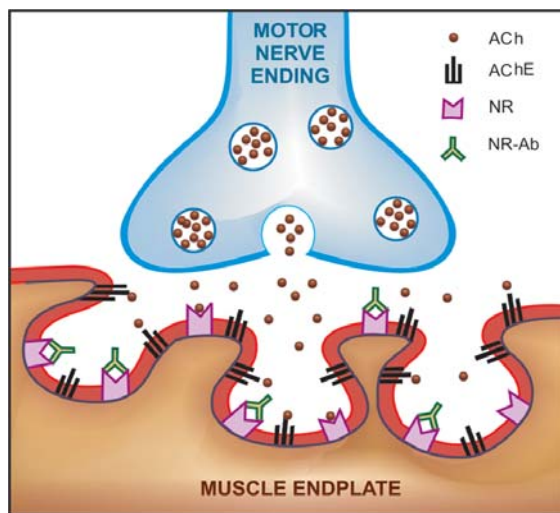

Fig. 7.3: Neuromuscular junction of myasthenic muscle. In myasthenia gravis the population of nicotinic receptors (NR) available at muscle endplate for binding acetylcholine (ACh) is markedly reduced due to their obliteration by nicotinic receptor antibodies (NR-Ab). Acetylcholinesterase (AChE) molecules located strategically at the muscle endplate rapidly hydrolyse ACh. Anticholinesterases inhibit AChE, allowing the same ACh molecules to repeatedly interact with the available NRs; frequency of ACh-NR interaction is increased.

receptors (NR) at the muscle endplate → reduction in number of free N_M cholinceptors to 1/3 of normal or less (Fig. 7.3) and structural damage to the neuromuscular junction → weakness and easy fatigability on repeated activity, with recovery after rest. Neostigmine and its congeners improve muscle contraction by allowing ACh released from prejunctional endings to accumulate and act on receptors over a larger area, and by directly depolarizing the endplate.

Treatment is usually started with *neostigmine* 15 mg orally 6 hourly; dose and frequency is then adjusted according to response. However, the dosage requirement may fluctuate from time to time and there are often unpredictable periods of remission and exacerbation. Pyridostigmine is an alternative which needs less frequent dosing. If intolerable muscarinic side effects are produced, atropine can be added to block them. These drugs have no effect on the basic disorder which often

progresses; ultimately it may not be possible to restore muscle strength adequately with anti-ChEs alone.

Corticosteroids afford considerable improvement in such cases by their immunosuppressant action. They inhibit production of NR-antibodies and may increase synthesis of NRs. However, their long term use has problems of its own (see Ch. 20). Prednisolone 30–60 mg/day induces remission in about 80% of the advanced cases; 10 mg daily or on alternate days can be used for maintenance therapy. Other immunosuppressants have also been used with benefit in advanced cases. Both azathioprine and cyclosporine also inhibit NR-antibody synthesis by affecting T-cells, but response to the former is slow in onset (takes up to 1 year), while that to the latter is relatively quick (in 1–2 months). Removal of antibodies by *plasmapheresis* (plasma exchange) is another therapeutic approach. Dramatic but short lived improvement can often be achieved by it in myasthenic crisis.

Myasthenic crisis is characterized by acute weakness of respiratory muscles. It is managed by tracheal intubation and mechanical ventilation. Generally, i.v. methylprednisolone pulse therapy is given while anti-ChEs are withheld for 2–3 days followed by their gradual reintroduction. Most patients can be weaned off the ventilator in 1–3 weeks. Plasmapheresis hastens recovery.

Thymectomy produces gradual improvement in majority of cases. Even complete remission has been obtained. Thymus may contain modified muscle cells with NRs on their surface, which may be the source of the antigen for production of anti-NR antibodies in myasthenic patients.

Overtreatment with anti-ChEs also produces weakness by causing persistent depolarization of muscle endplate: this is called *cholinergic weakness*. Late cases with high anti-ChE dose requirements often alternately experience myasthenic and cholinergic weakness and these may assume crisis proportions.

The two types of weakness require opposite treatments. They can be differentiated by *edrophonium test*—

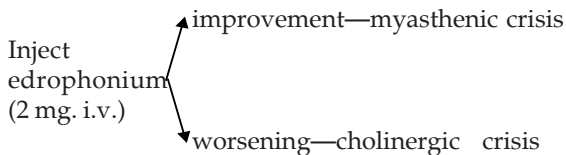

Diagnostic tests for myasthenia gravis

(a) *Ameliorative test*: edrophonium 2–10 mg injected slowly i.v. improves muscle strength only in myasthenia gravis and not in other muscular dystrophies.

(b) *Provocative test*: myasthenics are highly sensitive to d-tubocurarine; 0.5 mg i.v. causes marked weakness in them but is ineffective in non-myasthenics. This test is hazardous: facilities for positive pressure respiration must be at hand before performing it.

(c) Demonstration of anti-NR antibodies in plasma or muscle biopsy specimen is a more reliable test.

3. Postoperative paralytic ileus/urinary retention This can be relieved by 0.5–1 mg s.c. neostigmine, provided no organic obstruction is present.

4. Postoperative decurarization Neostigmine 0.5–2.0 mg i.v., preceded by atropine to block muscarinic effects, rapidly reverses muscle paralysis induced by competitive neuromuscular blockers.

5. Cobra bite Cobra venom has a curare like neurotoxin. Though specific antivenom serum is the primary treatment, neostigmine + atropine prevent respiratory paralysis.

6. Belladonna poisoning Physostigmine 0.5–2 mg i.v. repeated as required is the specific antidote for poisoning with belladonna or other anticholinergics. It penetrates blood-brain barrier and antagonizes both central and peripheral actions. However, physostigmine often itself induces hypotension and arrhythmias; is employed only as a last resort. Neostigmine does not block the central effect, but is less risky.

7. Other drug overdosages Tricyclic antidepressants, phenothiazines and many antihistaminics have additional anticholinergic property. Overdose symptoms and coma produced by these drugs are partly antagonized by physostigmine. It also appears to have a modest nonspecific arousal effect in CNS depression produced by diazepam or general anaesthetics, but is rarely used.

8. Alzheimer's disease Characterized by progressive dementia, is a neurodegenerative

disorder, primarily affecting cholinergic neurones in the brain. Various measures to augment cholinergic transmission in the brain have been tried. The relatively cerebroselective anti-ChEs *tacrine*, *rivastigmine*, *donepezil* and *galantamine* have been approved for clinical use. For details see Ch. 35.

ANTICHOLINESTERASE POISONING

Anticholinesterases are easily available and extensively used as agricultural and household insecticides; accidental as well as suicidal and homicidal poisoning is common.

Local muscarinic manifestations at the site of exposure (skin, eye, g.i.t.) occur immediately and are followed by complex systemic effects due to muscarinic, nicotinic and central actions. They are—

- Irritation of eye, lacrimation, salivation, sweating, copious tracheo-bronchial secretions, miosis, blurring of vision, breathlessness, colic, involuntary defecation and urination.
- Fall in BP, bradycardia or tachycardia, cardiac arrhythmias, vascular collapse.
- Muscular fasciculations, weakness, respiratory paralysis (central as well as peripheral).
- Excitement, tremor, ataxia, convulsions, coma and death.
- Death is generally due to respiratory failure.

Treatment

1. Termination of further exposure to the poison—fresh air, wash the skin and mucous membranes with soap and water, gastric lavage according to need.
2. Maintain patent airway, positive pressure respiration if it is failing.
3. Supportive measures—maintain BP, hydration, control of convulsions with judicious use of diazepam.
4. Specific antidotes—

(a) *Atropine* It is highly effective in counteracting the muscarinic symptoms, but higher doses are required to antagonize the central effects. It

does not reverse peripheral muscular paralysis which is a nicotinic action. All cases of anti-ChE (carbamate or organophosphate) poisoning must be promptly given atropine 2 mg i.v. repeated every 10 min till dryness of mouth or other signs of atropinization appear (upto 200 mg has been administered in a day). Continued treatment with maintenance doses may be required for 1–2 weeks.

(b) Cholinesterase reactivators Oximes are used to restore neuromuscular transmission in case of organophosphate anti-ChE poisoning. The phosphorylated ChE reacts very slowly or not at all with water. However, if more reactive OH groups in the form of oximes (generic formula $R-CH=N-OH$) are provided, reactivation occurs more than a million times faster (see Fig. 7.2G and H).

Pralidoxime (2-PAM) has a quaternary nitrogen: attaches to the anionic site of the enzyme which remains unoccupied in the presence of organophosphate inhibitors. Its oxime end reacts with the phosphorus atom attached to the esteratic site: the oxime-phosphonate so formed diffuses away leaving the reactivated ChE. It is ineffective as an antidote to carbamate anti-ChEs (physostigmine, neostigmine, carbaryl, propoxur) in which case the anionic site of the enzyme is not free to provide attachment to pralidoxime. It is rather contraindicated in carbamate poisoning, because

not only it does not reactivate carbamylated enzyme, it has weak anti-ChE activity of its own.

Pralidoxime (NEOPAM, PAM-A INJ. 500 mg/20 ml infusion, LYPHE 1 g/vial for inj.) is injected i.v. slowly in a dose of 1–2 g (children 20–40 mg/kg). It causes more marked reactivation of skeletal muscle ChE than at autonomic sites and not at all in the CNS (does not penetrate). Treatment should be started as early as possible (within 24 hours), before the phosphorylated enzyme has undergone 'aging' and become resistant to hydrolysis. Doses may be repeated according to need (max. 12 g in first 24 hrs, lower doses according to symptoms for 1–2 weeks). The use of oximes in organophosphate poisoning is secondary to that of atropine.

Other oximes are obidoxime (more potent than pralidoxime) and diacetyl-monoxime (DAM), which is lipophilic.

Chronic organophosphate poisoning Repeated exposure to certain fluorine containing and triaryl organophosphates results in polyneuritis and demyelination after a latent period of days and weeks. Sensory disturbances occur first followed by muscle weakness, tenderness and depressed tendon reflexes—lower motor neurone paralysis. In the second phase, spasticity and upper motor neurone paralysis gradually supervenes. Recovery may take years. The mechanism of this toxicity is not known, but it is not due to inhibition of ChE; there is no specific treatment.

CHAPTER

8

Anticholinergic Drugs and Drugs Acting on Autonomic Ganglia



ANTICHOLINERGIC DRUGS (Muscarinic receptor antagonists, Atropinic, Parasympatholytic)

Conventionally, anticholinergic drugs are those which block actions of ACh on autonomic effectors and in the CNS exerted through muscarinic receptors. Though nicotinic antagonists also block certain actions of ACh, they are generally referred to as 'ganglion blockers' and 'neuromuscular blockers'.

Atropine, the prototype drug of this class, is highly selective for muscarinic receptors, but some of its synthetic substitutes do possess significant nicotinic blocking property in addition. The selective action of atropine can easily be demonstrated on a piece of guinea pig ileum where ACh induced contractions are blocked without affecting those evoked by histamine, 5-HT or other spasmogens. The selectivity is, however, lost at very high doses. All anticholinergics are competitive antagonists.

CLASSIFICATION

1. *Natural alkaloids* Atropine, Hyoscine (Scopolamine).
2. *Semisynthetic derivatives* Homatropine, Atropine methonitrate, Hyoscine butyl

bromide, Ipratropium bromide, Tiotropium bromide.

3. *Synthetic compounds*

- (a) *Mydriatics*: Cyclopentolate, Tropicamide.
- (b) *Antisecretory-antispasmodics*:
 - (i) *Quaternary compounds*: Propantheline, Oxyphenonium, Clidinium, Pirenzepate methylbromide, Isopropamide, Glycopyrrolate.
 - (ii) *Tertiary amines*: Dicyclomine, Valethamate, Pirenzepine.
- (c) *Vasoselective*: Oxybutynin, Flavoxate, Tolterodine.
- (d) *Antiparkinsonian*: Trihexyphenidyl (Benzhexol), Procyclidine, Biperiden.

In addition, many other classes of drugs, i.e. tricyclic antidepressants, phenothiazines, antihistamines and disopyramide possess significant antimuscarinic actions.

The natural alkaloids are found in plants of the solanaceae family. The levo-isomers are much more active than the dextroisomers. Atropine is racemic while scopolamine is *l*-hyoscine.

PHARMACOLOGICAL ACTIONS (Atropine as prototype)

The actions of atropine can be largely predicted from knowledge of parasympathetic responses.

Prominent effects are seen in organs which normally receive strong parasympathetic tone. It blocks all subtypes of muscarinic receptors.

1. CNS Atropine has an overall CNS stimulant action. However, these effects are not appreciable at low doses which produce only peripheral effects because of restricted entry into the brain. Hyoscine produces central effects (depressant) even at low doses.

- Atropine stimulates many medullary centres—vagal, respiratory, vasomotor.
- It depresses vestibular excitation and has antimotion sickness property. The site of this action is not clear—probably there is a cholinergic link in the vestibular pathway, or it is exerted at the cortical level.
- By blocking the relative cholinergic overactivity in basal ganglia, it suppresses tremor and rigidity of parkinsonism.
- High doses cause cortical excitation, restlessness, disorientation, hallucinations and delirium followed by respiratory depression and coma.

Majority of the central actions are due to blockade of muscarinic receptors in the brain, but some actions may have a different basis.

2. CVS

Heart The most prominent effect of atropine is to cause tachycardia. It is due to blockade of M_2 receptors on SA node through which vagal tone decreases HR. Higher the existing vagal tone—more marked is the tachycardia (maximum in young adults, less in children and elderly). On i.m./s.c. injection transient initial bradycardia often occurs. Earlier believed to be due to stimulation of vagal centre, it is now thought to be caused by blockade of muscarinic auto-receptors (M_1) on vagal nerve endings augmenting ACh release. This is suggested by the finding that selective M_1 antagonist pirenzepine is equipotent to atropine in causing bradycardia as are atropine substitutes which do not cross blood-brain barrier. Atropine abbreviates refractory period of A-V node and facilitates A-V conduction, especially if

it has been depressed by high vagal tone. P-R interval is shortened.

BP Since cholinergic impulses are not involved in maintenance of vascular tone, atropine does not have any consistent or marked effect on BP. Tachycardia and vasomotor centre stimulation tend to raise BP, while histamine release and direct vasodilator action (at high doses) tend to lower BP.

Atropine blocks vasodepressor action of cholinergic agonists.

3. Eye The autonomic control of iris muscles and the action of mydriatics as well as miotics is illustrated in Fig. 8.1. Topical instillation of atropine causes mydriasis, abolition of light reflex and cycloplegia lasting 7–10 days. This results in photophobia and blurring of near vision. The ciliary muscles recover somewhat earlier than sphincter pupillae. The intraocular tension tends to rise, especially in narrow angle glaucoma; conventional systemic doses produce minor ocular effects.

4. Smooth muscles All visceral smooth muscles that receive parasympathetic motor innervation are relaxed by atropine (M_3 blockade). Tone and amplitude of contractions of stomach and intestine are reduced; the passage of chyme is slowed—constipation may occur, spasm may be relieved. However, peristalsis is only incompletely suppressed because it is primarily regulated by local reflexes and other neurotransmitters (5-HT, enkephalin, etc.) as well as hormones are involved. Enhanced motility due to injected cholinergic drugs is more completely antagonised than that due to vagal stimulation.

Atropine causes bronchodilatation and reduces airway resistance, especially in COPD and asthma patients. Inflammatory mediators like histamine, PGs and kinins increase vagal activity in addition to their direct action on bronchial muscle and glands. Atropine attenuates their action by antagonizing the reflex vagal component.

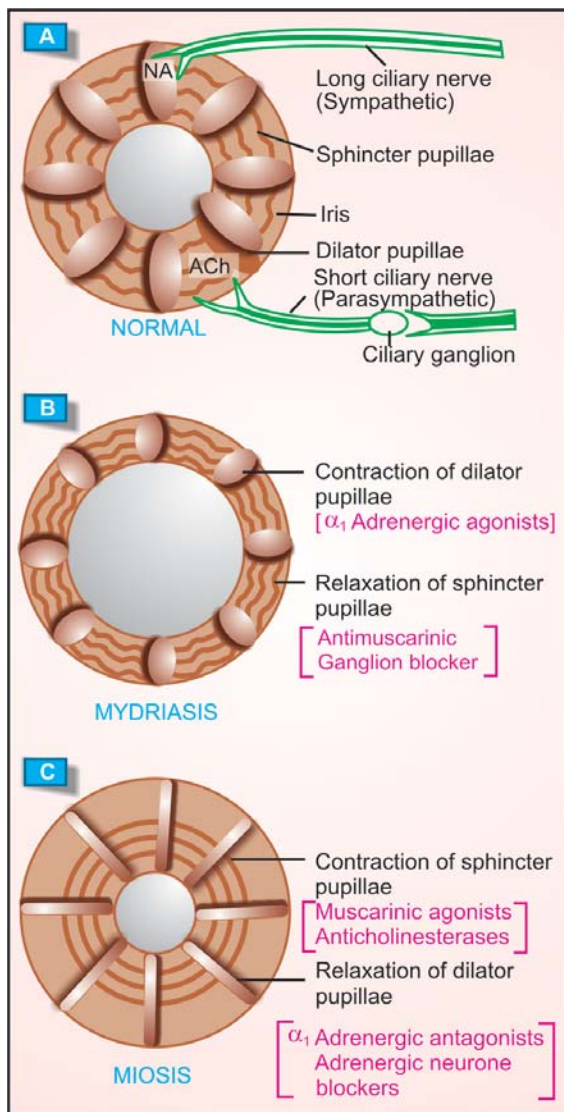

Fig. 8.1: Autonomic control of pupil (A); and site of action of mydriatics (B) and miotics (C)

Atropine has relaxant action on ureter and urinary bladder; urinary retention can occur in older males with prostatic hypertrophy. However, the same can be beneficial for increasing bladder capacity and controlling detrusor hyperreflexia in neurogenic bladder/enuresis. Relaxation of biliary tract is less marked and effect on uterus is minimal.

5. Glands Atropine markedly decreases sweat, salivary, tracheobronchial and lacrimal secretion (M_3 blockade). Skin and eyes become dry, talking and swallowing may be difficult.

Atropine decreases secretion of acid, pepsin and mucus in the stomach, but the primary action is on volume of secretion so that pH of gastric contents may not be elevated unless diluted by food. Since bicarbonate secretion is also reduced, rise in pH of fasting gastric juice is only modest. Relatively higher doses are needed and atropine is less efficacious than H_2 blockers in reducing acid secretion. Intestinal and pancreatic secretions are not significantly reduced. Bile production is not under cholinergic control, so not affected.

6. Body temperature Rise in body temperature occurs at higher doses. It is due to both inhibition of sweating as well as stimulation of temperature regulating centre in the hypothalamus. Children are highly susceptible to atropine fever.

7. Local anaesthetic Atropine has a mild anaesthetic action on the cornea.

Atropine has been found to enhance ACh (also NA) release from certain postganglionic parasympathetic and sympathetic nerve endings, and thus produce paradoxical responses. This is due to blockade of release inhibitory muscarinic autoreceptors present on these nerve terminals.

The sensitivity of different organs and tissues to atropine varies and can be graded as—

Saliva, sweat, bronchial secretion > eye, bronchial muscle, heart > smooth muscle of intestine, bladder > gastric glands and smooth muscle.

The above differences probably reflect the relative dependence of the function on cholinergic tone *vis a vis* other influences, and variation in synaptic gaps in different organs. The pattern of relative activity is nearly the same for other atropine substitutes except *pirenzepine* which inhibits gastric secretion at doses that have little effect on other secretions, heart and eye. This is probably because atropine equally blocks M_1 , M_2 and M_3 receptors whereas *pirenzepine* is a selective M_1 antagonist.

Atropine more effectively blocks responses to exogenously administered cholinergic drugs than those to parasympathetic nerve activity. This may be due to release of ACh very close to the

Table 8.1: Comparative features of atropine and hyoscine

	<i>Atropine</i>	<i>Hyoscine</i>
1. Chief source	<i>Atropa belladonna</i> , <i>Datura stramonium</i>	<i>Hyoscyamus niger</i>
2. Alkaloidal ester of tropic acid with	Tropine (base)	Scopine (base)
3. CNS effect	Excitatory	Depressant (amnesia, fatigue, drowsiness, N-REM sleep)
low dose	Excitation (mild)	Excitation
high dose	Excitation (strong)	
4. Anticholinergic property	More potent on heart, bronchial muscle and intestines	More potent on eye and secretory glands
5. Duration of action	Longer	Shorter
6. Anti-motion sickness	++	+++

receptors by nerves and involvement of cotransmitters (*see p. 91*).

Hyoscine The other natural anticholinergic alkaloid differs from atropine in many respects, these are tabulated in Table 8.1.

PHARMACOKINETICS

Atropine and hyoscine are rapidly absorbed from g.i.t. Applied to eyes they freely penetrate cornea. Passage across blood-brain barrier is somewhat restricted. About 50% of atropine is metabolized in liver and rest is excreted unchanged in urine. It has a $t_{1/2}$ of 3–4 hours. Hyoscine is more completely metabolized and has better blood-brain barrier penetration.

Atropine sulfate: 0.6–2 mg i.m., i.v. (children 10 µg/kg), 1–2% topically in eye. **ATROPINE SULPHATE:** 0.6 mg/ml inj., 1% eye drop/ointment; **ATROSU LPH** 1% eye drop, 5% eye oint.

Hyoscine hydrobromide: 0.3–0.5 mg oral, i.m.; also as transdermal patch.

Combinations of atropine with analgesics and antipyretics are banned in India.

ATROPINE SUBSTITUTES

Many semisynthetic derivatives of belladonna alkaloids and a large number of synthetic compounds have been introduced with the aim of producing more selective action on certain functions. Most of these differ only marginally from the natural alkaloids, but some recent ones are promising.

Quaternary compounds

These have certain common features—

- (i) Incomplete oral absorption.
- (ii) Poor penetration in brain and eye; central and ocular effects are not seen after parenteral/oral administration.
- (iii) Elimination is generally slower; majority are longer acting than atropine.
- (iv) Have higher nicotinic blocking property. Some ganglionic blockade may occur at clinical doses → postural hypotension, impotence are additional side effects.
- (v) At high doses some degree of neuromuscular blockade may also occur.

Drugs in this category are—

1. **Hyoscine butyl bromide** 20–40 mg oral, i.m., s.c., i.v.; less potent and longer acting than atropine; used for esophageal and gastrointestinal spastic conditions.

BUSCOPAN 10 mg tab., 20 mg/ml amp.

2. **Atropine methonitrate** 2.5–10 mg oral, i.m.; for abdominal colics and hyperacidity.

MYDRINDON 1 mg (adult), 0.1 mg (child) tab; in **SPASMOLYSIN** 0.32 mg tab;

3. **Ipratropium bromide** 40–80 µg by inhalation; it acts selectively on bronchial muscle without altering volume or consistency of respiratory secretions. Another desirable feature is that in contrast to atropine, it does not depress mucociliary clearance by bronchial epithelium. It has

a gradual onset and late peak (at 60–90 min) of bronchodilator effect in comparison to inhaled sympathomimetics—more suitable for regular prophylactic use rather than for rapid symptomatic relief during an attack. Action lasts 4–6 hours. It acts on receptors located mainly in the larger central airways (contrast sympathomimetics whose primary site of action is peripheral bronchioles, *see* Fig. 16.2). The parasympathetic tone is the major reversible factor in chronic obstructive pulmonary disease (COPD). Therefore, ipratropium is more effective in COPD than in bronchial asthma. Transient local side effects like dryness of mouth, scratching in trachea, cough, bad taste and nervousness are reported in 20–30% patients, but systemic effects are rare because of poor absorption from the lungs and g.i.t. (major fraction of inhaled drug is swallowed).

IPRAVENT 20 µg and 40 µg/puff metered dose inhaler, 2 puffs 3–4 times daily; **250 µg/ml respirator soln.**, 0.4–2 ml nebulized in conjunction with a β_2 agonist 2–4 times daily.

Also used to control rhinorrhoea in perennial rhinitis and common cold; **IPRANASE-AQ 0.084% nasal spray** (42 µg per actuation), 1–2 sprays in each nostril 3–4 times a day.

4. Tiotropium bromide A recently developed congener of ipratropium bromide which binds very tightly to bronchial M_1/M_3 muscarinic receptors producing long lasting bronchodilatation. Binding to M_2 receptors is less tight conferring relative M_1/M_3 selectivity. Like ipratropium, it is not absorbed from respiratory and g.i. mucosa and has exhibited high bronchial selectivity of action.

TIOVA 18 µg rotacaps; 1 rotacap by inhalation OD.

5. Propantheline 15–30 mg oral; it has been the most popular anticholinergic used for peptic ulcer and gastritis. It has some ganglion blocking activity as well and is claimed to reduce gastric secretion at doses which produce only mild side effects. Gastric emptying is delayed and action lasts for 6–8 hours. Use has declined due to availability of H_2 blockers which are more efficacious.

PROBANTHINE 15 mg tab.

6. Oxyphenonium 5–10 mg (children 3–5 mg) oral; similar to propantheline, recommended for peptic ulcer and gastrointestinal hypermotility.

ANTRENYL 5, 10 mg tab.

7. Clidinium 2.5–5 mg oral; used in combination with benzodiazepines for nervous dyspepsia, gastritis, irritable bowel syndrome, colic, peptic ulcer, etc.

In SPASRIL, EQUIREX 2.5 mg tab with chlordiazepoxide 5 mg. NORMAXIN 2.5 mg with dicyclomine 10 mg and chlordiazepoxide 5 mg.

8. Pipenzolate methyl bromide 5–10 mg (children 2–3 mg) oral; used for flatulent dyspepsia, infantile colics and other gastrointestinal spasm.

In PIPTAL, PIPEN 4 mg + dimethylpolysiloxane 40 mg/ml drops.

9. Isopropamide 5 mg oral; indicated in hyperacidity, nervous dyspepsia, irritable bowel and other gastrointestinal problems, specially when associated with emotional/mental disorders.

In STELABID, GASTABID 5 mg tab. with trifluoperazine 1 mg.

10. Glycopyrrolate 0.1–0.3 mg i.m., 1–2 mg oral; potent and rapidly acting antimuscarinic lacking central effects. Almost exclusively used for pre-anaesthetic medication and during anaesthesia.

GLYCO-P 0.2 mg/ml amp., 1 mg in 5 ml vial, PYROLATE 0.2 mg/ml, 1 ml amp, 10 ml vial.

Tertiary amines

1. Dicyclomine 20 mg oral/i.m., children 5–10 mg; has direct smooth muscle relaxant action in addition to weak anticholinergic; exerts antispasmodic action at doses which produce few atropinic side effects. However, infants have exhibited atropinic toxicity symptoms and it is not recommended below 6 months of age. It also has antiemetic property: has been used in morning sickness and motion sickness. Dysmenorrhoea and irritable bowel are other indications.

CYCLOMINOL, 20 mg tab., 10 mg/ml liquid; DIOSPAS 10 mg, 20 mg tabs, CYCLOPAM INJ. 10 mg/ml in 2 ml, 10 ml, 30 ml amp/vial, also 20 mg tab with paracetamol 500 mg; in COLIMEX 20 mg with paracetamol 500 mg tab, 10 mg/ml drops with dimethicone.

2. Valethamate: The primary indication of this anticholinergic-smooth muscle relaxant is to

hasten dilatation of cervix when the same is delayed during labour, and as visceral antispasmodic.

Dose: 8 mg i.m., 10 mg oral repeated as required.

VALAMATE 8 mg in 1 ml inj, **EPIDOSIN** 8 mg inj., 10 mg tab.

3. Pirenzepine 100–150 mg/day oral; it selectively blocks M₁ muscarinic receptors (*see* p. 95) and inhibits gastric secretion without producing typical atropinic side effects (these are due to blockade of M₂ and M₃ receptors). The more likely site of action of pirenzepine in stomach is intramural plexuses and ganglionic cells rather than the parietal cells themselves. It is nearly equally effective as cimetidine in relieving peptic ulcer pain and promoting ulcer healing, but has been overshadowed by H₂ blockers and proton pump inhibitors.

Vasoselective drugs

1. Oxybutynin This recently introduced anti-muscarinic has high affinity for receptors in urinary bladder and salivary glands with additional smooth muscle relaxant and local anaesthetic properties. It is relatively selective for M₁/M₃ subtypes than for M₂. Because of vasoselective action it is used for detrusor instability resulting in urinary frequency and urge incontinence. Beneficial effects have been demonstrated in neurogenic bladder, spina bifida and nocturnal enuresis. Anticholinergic side effects are common after oral dosing, but intravasical instillation increases bladder capacity with few side effects.

Dose: 5 mg BD/TDS oral; children above 5 yr 2.5 mg BD.
OXYBUTIN, **CYSTRAN**, **OXYSPAS** 2.5 mg and 5 mg tabs.

2. Tolterodine: This relatively M₃ selective muscarinic antagonist has preferential action on urinary bladder; less likely to cause dryness of mouth and other anticholinergic side effects. It is indicated in overactive bladder with urinary frequency and urgency. Since it is metabolized by CYP3A4, dose should be halved in patients receiving CYP3A4 inhibitors (erythromycin, ketoconazole, etc.)

Dose: 2 mg BD oral; **ROLITEN**, **TORQ** 1, 2 mg tabs.

3. Flavoxate has properties similar to oxybutynin and is indicated in urinary frequency, urgency and dysuria associated with lower urinary tract infection.

URISPAS, **FLAVATE** 200 mg tab, 1 tab TDS.

Drotaverine It is a novel non-anticholinergic smooth muscle antispasmodic which acts by inhibiting phosphodiesterase-4 (PDE-4) selective for smooth muscle. Elevation of intracellular cAMP/cGMP attends smooth muscle relaxation. Changes in membrane ionic fluxes and membrane potential have also been shown. It has been used orally as well as parenterally in intestinal, biliary and renal colics, irritable bowel syndrome, uterine spasms, etc. without anticholinergic side effects. Adverse effects reported are headache, dizziness, constipation and flushing. Fall in BP can occur on i.v. injection.

Dose: 40–80 mg TDS; **DROTIN**, **DOTARIN**, **DOVERIN** 40, 80 mg tabs, 40 mg/2 ml inj.

Mydriatics

Atropine is a potent mydriatic but its slow and long lasting action is undesirable for refraction testing. Though the pupil dilates in 30–40 min, cycloplegia takes 1–3 hours, and the subject is visually handicapped for about a week. The substitutes attempt to overcome these difficulties.

1. Homatropine It is 10 times less potent than atropine. Instilled in eye, it acts in 45–60 min, mydriasis lasts 1–3 days while accommodation recovers in 1–2 days. It often produces unsatisfactory cycloplegia in children who have high ciliary muscle tone.

HOMATROPINE EYE, **HOMIDE** 1%, 2% eye drops.

2. Cyclopentolate It is potent and rapidly acting; mydriasis and cycloplegia occur in 30–60 min and last about a day. It is preferred for cycloplegic refraction, but children may show transient behavioural abnormalities due to absorption of the drug after passage into the nasolacrimal duct. It is also used in iritis and uveitis.

CYCLOMID EYE 0.5%, 1%; **CYCLOGYL** 1% eye drops.

3. Tropicamide It has the quickest (20–40 min) and briefest (3–6 hours) action, but is a relatively unreliable cycloplegic. However, it is satisfactory for refraction testing in adults and as a short acting mydriatic for fundoscopy.

OPTIMIDE, TROPICAMET, TROMIDE 0.5%, 1.0% eye drops. TROPAC-P, TROPICAMET PLUS 0.8% with phenylephrine 5% eye drops.

Antiparkinsonian drugs (see Ch. 31)

USES

I. As antisecretory

1. *Preanaesthetic medication* When irritant general anaesthetics (ether) are used, prior administration of anticholinergics (atropine, hyoscine, glycopyrrolate) is imperative to check increased salivary and tracheobronchial secretions. However, with increasing use of nonirritating anaesthetics (halothane) the requirement has decreased, though atropine may still be employed because halothane sensitizes the heart to NA mediated ventricular arrhythmias which are specially prone to occur during vagal slowing. Atropinic drugs also prevent laryngospasm, not by an action on laryngeal muscles, which are skeletal muscles, but by reducing respiratory secretions that reflexly predispose to laryngospasm. Vasovagal attack during anaesthesia may also be prevented.

2. *Peptic ulcer* Atropinic drugs decrease gastric secretion (fasting and neurogenic phase, but little effect on gastric phase) and afford symptomatic relief in peptic ulcer, though effective doses always produce side effects. They have now been superseded by H₂ blockers.

3. *Pulmonary embolism* These drugs benefit by reducing reflex secretions.

4. To check excessive sweating or salivation, e.g. in parkinsonism.

II. As antispasmodic

1. Intestinal and renal colic, abdominal cramps: symptomatic relief is afforded if there is no mechanical obstruction. Atropine is less effective in biliary colic and is not able to completely counteract biliary spasm due to opiates (nitrates are more effective).

2. Nervous and drug induced diarrhoea, functional diarrhoea, but not effective in infective diarrhoea.
3. Spastic constipation, irritable bowel syndrome.
4. Pylorospasm, gastric hypermotility, gastritis, nervous dyspepsia.
5. To relieve urinary frequency and urgency, enuresis in children. Oxybutynin, tolterodine and flavoxate have demonstrated good efficacy, but dry mouth and other anticholinergic effects are dose limiting.
6. Dysmenorrhoea: These drugs are not very effective.

III. Bronchial asthma, asthmatic bronchitis, COPD

Reflex vagal activity is an important factor in causing bronchoconstriction and increased secretion in chronic bronchitis and COPD, but to a lesser extent in bronchial asthma. Orally administered atropinic drugs are bronchodilators, but less effective than adrenergic drugs. They dry up secretion in the respiratory tract, may lead to its inspissation and plugging of bronchioles resulting in alveolar collapse and predisposition to infection. The mucociliary clearance is also impaired. Inhaled ipratropium bromide has been found to be specially effective in asthmatic bronchitis and COPD, though less so in bronchial asthma. Given by aerosol, it has been shown not to decrease respiratory secretions or to impair mucociliary clearance, and there are few systemic side effects. Thus, it has a place in the management of COPD. Its time course of action makes it more suitable for regular prophylactic use rather than for control of acute attacks. The additive bronchodilator action with adrenergic drugs is utilized to afford relief in acute exacerbation of asthma/COPD by administering a combination of nebulized ipratropium and β_2 agonist through a mask.

IV. As mydriatic and cycloplegic

(i) *Diagnostic* For testing error of refraction, both mydriasis and cycloplegia are needed.

Tropicamide having briefer action has now largely replaced homatropine for this purpose. These drugs do not cause sufficient cycloplegia in children: more potent agents like atropine or hyoscine have to be used. Atropine ointment (1%) applied 24 hours and 2 hours before is often preferred for children below 5 years. Cyclopentolate is an alternative.

To facilitate fundoscopy only mydriasis is needed; a short acting antimuscarinic may be used, but phenylephrine is preferred, especially in the elderly, for fear of precipitating or aggravating glaucoma.

(ii) **Therapeutic** Atropine, because of its long lasting mydriatic-cycloplegic and local anodyne action on cornea, is very valuable in the treatment of iritis, iridocyclitis, choroiditis, keratitis and corneal ulcer. It gives rest to the intraocular muscles and cuts down their painful spasm. Atropinic drugs alternated with a miotic prevent adhesions between iris and lens or iris and cornea and may even break them if already formed.

V. As cardiac vagolytic

Atropine is useful in counteracting bradycardia and partial heart block in selected patients where increased vagal tone is responsible, e.g. in some cases of myocardial infarction, digitalis toxicity. However, cardiac arrhythmias or ischaemia may be precipitated in some cases.

VI. For central action

1. **Parkinsonism** (see Ch. 31) Central anticholinergics are less effective than levodopa; They are used in mild cases, in drug induced extrapyramidal syndromes and as adjuvant to levodopa.

2. **Motion sickness** Hyoscine is the most effective drug for motion sickness. It is particularly valuable in highly susceptible individuals and for vigorous motions. The drug should be given prophylactically (0.2 mg oral), because administration after symptoms have set in is less effective; action lasts 4–6 hours. A transdermal

preparation applied behind the pinna 4 hours before journey has been shown to protect for 3 days. Side effects with low oral doses and transdermal medication are few, but sedation and dry mouth may occur. Hyoscine and other anticholinergics are not effective in other types of vomiting.

3. Hyoscine has been used to produce sedation and amnesia during labour (twilight sleep) and to control maniacal states. It had earned a reputation as a 'lie detector' during world war II: its amnesic and depressant action was believed to put the subject 'off guard' in the face of sustained interrogation and sleep deprivation, so that he came out with the truth.

VII. To antagonise muscarinic effects of drugs and poisons

Atropine is the specific antidote for anti ChE and early mushroom poisoning (see Ch. 7). It is also given to block muscarinic actions of neostigmine used for myasthenia gravis, decurarization or cobra envenomation.

SIDE EFFECTS AND TOXICITY

Side effects are quite common with the use of atropine and its congeners; are due to facets of its action other than for which it is being used. They cause inconvenience but are rarely serious.

Belladonna poisoning may occur due to drug overdose or consumption of seeds and berries of belladonna/datura plant. Children are highly susceptible. Manifestations are due to exaggerated pharmacological actions.

Dry mouth, difficulty in swallowing and talking. Dry, flushed and hot skin (especially over face and neck), fever, difficulty in micturition, decreased bowel sounds, a scarlet rash may appear. Dilated pupil, photophobia, blurring of near vision, palpitation.

Excitement, psychotic behaviour, ataxia, delirium, dreadful visual hallucinations.

Hypotension, weak and rapid pulse, cardiovascular collapse with respiratory depression.

Convulsions and coma occur only in severe poisoning.

Diagnosis Methacholine 5 mg or neostigmine 1 mg s.c. fails to induce typical muscarinic effects.

Treatment If poison has been ingested, gastric lavage should be done with tannic acid (KMnO₄ is ineffective in oxidizing atropine). The patient should be kept in a dark quiet room. Cold sponging or ice bags are applied for reducing body temperature. Physostigmine 1–3 mg s.c. or i.v. antagonises both central and peripheral effects, but has been found to produce hypotension and arrhythmias in some cases. As such, its utility is controversial. Neostigmine does not antagonise the central effects.

Other general measures (maintenance of blood volume, assisted respiration, diazepam to control convulsions) should be taken as appropriate.

Contraindications Atropinic drugs are absolutely contraindicated in individuals with a narrow iridocorneal angle—may precipitate acute congestive glaucoma. However, marked rise in intraocular tension is rare in patients with wide angle glaucoma.

Caution is advocated in elderly males with prostatic hypertrophy—urinary retention can occur.

Interactions

1. Absorption of most drugs is slowed because atropine delays gastric emptying. This results in slower absorption and greater peripheral degradation of levodopa—less of it reaches the brain. This does not occur when a peripheral decarboxylase inhibitor is combined.

On the other hand, extent of digoxin and tetracycline absorption may be increased due to longer transit time in the g.i.t.

2. Antacids interfere with absorption of anticholinergics.
3. Antihistaminics, tricyclic antidepressants, phenothiazines, disopyramide, pethidine

have anticholinergic property—additive side effects occur with atropinic drugs.

4. MAO inhibitors interfere with metabolism of anticholinergic antiparkinsonian drugs—delirium may occur.

DRUGS ACTING ON AUTONOMIC GANGLIA

Acetylcholine is the primary excitatory neurotransmitter in both sympathetic and parasympathetic ganglia. Drugs which inhibit synthesis (hemicholinium) or release (botulinus toxin, procaine) of ACh can interfere with ganglionic transmission, but drugs which act on cholinergic receptors in the ganglia are more selective.

In addition to the dominant nicotinic N_N receptors, which mediate the primary rapid depolarization of ganglionic cells, there are subsidiary muscarinic M₁, M₂, adrenergic, dopaminergic, amino acid and peptidergic receptors which bring about secondary, slowly developing but longer lasting changes in membrane potential, both positive and negative, that modulate the primary response. Separate catecholamine (NA, DA) and amino acid containing cells are present in ganglia, but peptides are released from the preganglionic cholinergic terminals themselves. Thus, autonomic ganglion is not merely a one transmitter—one cell junction, but a complex system capable of local adjustments in the level of excitability.

Drugs can either stimulate or block the ganglia.

Ganglionic stimulants

Selective nicotinic agonists

Nicotine (small dose)
Lobeline
Dimethyl phenyl piperazinium (DMPP) iodide
Tetramethyl ammonium (TMA)

Nonselective/muscarinic agonists

Acetylcholine
Carbachol
Pilocarpine
Anticholinesterases
MCN 343-A

Table 8.2: Relative autonomic tone and effects of ganglionic blockade on organ function

<i>Organ</i>	<i>Dominant tone</i>	<i>Effect of ganglionic blockade (Side effect)</i>
1. Heart	Para-symp.	Tachycardia (palpitation)
2. Blood vessels	Symp.	Dilatation, abolition of reflexes (postural and exercise hypotension, syncope)
3. Iris	Para-symp.	Mydriasis (photophobia)
4. Ciliary muscle	Para-symp.	Cycloplegia (blurring of near vision)
5. Intestines	Para-symp.	Decreased motility (distension, constipation)
6. Bladder	Para-symp.	Decreased tone (difficulty in micturition)
7. Male sexual function	Para-symp. Symp.	Inhibition of erection } (impotence) Inhibition of ejaculation }
8. Salivary glands	Para-symp.	Inhibition of salivation (dryness of mouth)
9. Sweat glands	Symp. (cholinergic)	Inhibition of sweating (anhidrosis)

Nicotine (from *Nicotiana tabacum*) is important in the context of smoking or chewing tobacco, but there is no clinical application of ganglionic stimulants, because no useful purpose can be served by stimulating both sympathetic and parasympathetic ganglia concurrently.

Nicotine transdermal has recently become available for treatment of nicotine dependence and as an aid to smoking cessation. It ameliorates the symptoms of nicotine withdrawal, but does not completely suppress craving, because the peak nicotine blood levels that occur after smoking are not reproduced by the patch.

NICOTINELL-TTS 10, 20, 30 cm² patches releasing 7, 14, 21 mg nicotine per 24 hr respectively. In those smoking > 20 cigarettes every day—start with 30 cm² patch, shift to smaller patches every 5–8 days, treat for 3–4 weeks (max. 12 weeks). Headache, insomnia, flu like symptoms, dyspepsia, loose motion and local irritation are the side effects. Cardiac arrhythmias and ischaemic heart disease are the contraindications.

Varenicline This N_N subtype nicotinic receptor partial agonist is under clinical development for smoking cessation. Controlled trials have found it to reduce craving as well as nicotine withdrawal symptoms in those who stop smoking. Abstinence rates after one year were higher than placebo and comparable to bupropion (see Ch. 33).

Rimonabant A selective cannabinoid receptor-1 (CB-1) antagonist which is being tried as antismoking and antiobesity drug. It appears to have the potential to help smoking cessation as well as maintain smoking abstinence.

Ganglion blocking agents

A. Competitive blockers

Quaternary ammonium compounds
Hexamethonium, Pentolinium
Amines (secondary/tertiary)
Mecamylamine, Pempidine
Monosulfonium compound
Trimethaphan camforsulfonate

B. Persistent depolarising blockers

Nicotine (large dose)
Anticholinesterases (large dose)

The competitive ganglion blockers were used in the 1950s for hypertension and peptic ulcer, but have been totally replaced now because they produce a number of intolerable side effects (see Table 8.2). In fact, these side effects help in understanding the relative roles of sympathetic and parasympathetic divisions in regulating the various organ functions.

Trimethaphan It is an ultrashort acting ganglion blocker; has been occasionally used to produce controlled hypotension and in hypertensive emergency due to aortic dissection.

Mecamylamine alone, as well as in combination with nicotine patch, has been tried for smoking cessation. It appears to block the reward effect of nicotine and improve abstinence rate compared to placebo. Constipation occurred in many subjects, and it is not an approved drug.

There is at present no clinical relevance of ganglion blockers.

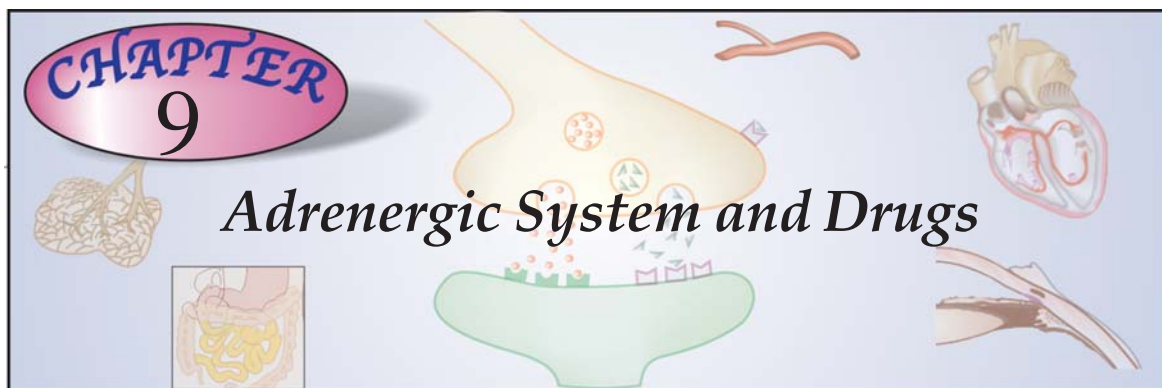

ADRENERGIC TRANSMISSION

Adrenergic (more precisely 'Noradrenergic') transmission is restricted to the sympathetic division of the ANS. There are three closely related endogenous catecholamines (CAs).

Noradrenaline (NA) It acts as transmitter at post-ganglionic sympathetic sites (except sweat glands, hair follicles and some vasodilator fibres) and in certain areas of brain.

Adrenaline (Adr) It is secreted by adrenal medulla and may have a transmitter role in the brain.

Dopamine (DA) It is a major transmitter in basal ganglia, limbic system, CTZ, anterior pituitary, etc. and in a limited manner in the periphery.

1. Synthesis of CAs Catecholamines are synthesized from the amino acid phenylalanine as depicted in Fig. 9.1. Tyrosine hydroxylase is the rate limiting enzyme and its inhibition by α -methyl-p-tyrosine results in depletion of CAs; this can be used in pheochromocytoma before surgery and in inoperable cases. All enzymes of CA synthesis are rather nonspecific and can act on closely related substrates, e.g. dopa decarboxylase can form 5-HT from 5-hydroxytryptophan and α methyl DA from α methyl dopa. Synthesis of NA occurs in all adrenergic neurones, while

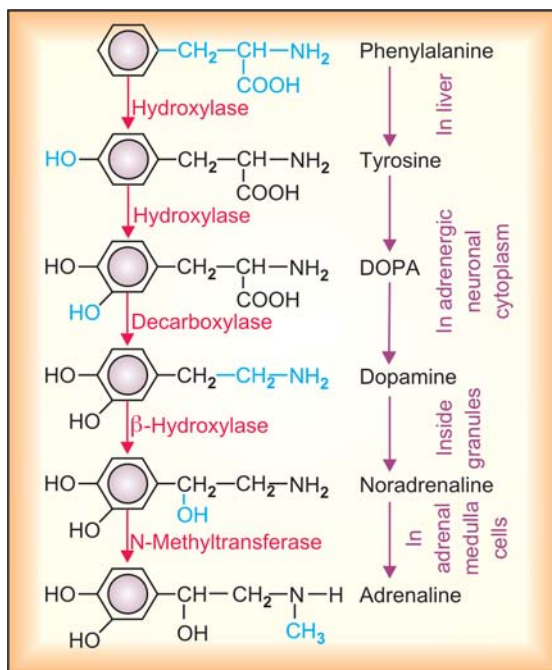

Fig. 9.1: Steps in the synthesis of catecholamines

that of Adr occurs only in the adrenal medullary cells. It probably requires high concentration of glucocorticoids reaching through intraadrenal portal circulation for induction of the methylating enzyme.

2. Storage of CAs NA is stored in synaptic vesicles or 'granules' within the adrenergic nerve terminal (Fig. 9.4). The vesicular membrane actively takes up DA from the cytoplasm and the final step of synthesis of NA takes place inside the vesicle which contains dopamine β -hydroxylase. NA is then stored as a complex with ATP (in a ratio of 4 : 1) which is adsorbed on a protein *chromogranin*. In the adrenal medulla the NA thus formed within the chromaffin granules diffuses out into the cytoplasm, is methylated and Adr so formed is again taken up by a separate set of granules. The cytoplasmic pool of CAs is kept low by the enzyme monoamine oxidase (MAO) present on the outer surface of mitochondria.

3. Release of CAs The nerve impulse coupled release of CA takes place by *exocytosis* (see p. 91) and all the vesicular contents (NA or Adr, ATP, dopamine β hydroxylase, chromogranin) are poured out. In case of vesicles which in addition contain peptides like enkephalin or neuropeptide Y (NPY), these cotransmitters are simultaneously released. The release is modulated by presynaptic receptors, of which α_2 inhibitory control is dominant.

The autoreceptors of other cotransmitters (Y_2 of NPY and P1 of ATP) also inhibit transmitter release. In addition, numerous heteroreceptors are expressed on the adrenergic neurone which either inhibit (dopaminergic, serotonergic, muscarinic and PGE₂) or enhance (β_2 adrenergic, angiotensin AT₁ and nicotinic) NA release.

Indirectly acting sympathomimetic amines (tyramine, etc.) also induce release of NA, but they do so by displacing NA from the nerve ending binding sites and by exchange diffusion utilizing norepinephrine transporter (NET) the carrier of uptake-1 (see below). This process is not exocytotic and does not require Ca²⁺.

4. Uptake of CAs There is a very efficient mechanism by which NA released from the nerve terminal is recaptured. This occurs in 2 steps—

Axonal uptake An active amine pump (NET) is present at the neuronal membrane which transports NA by a Na⁺ coupled mechanism. It

takes up NA at a higher rate than Adr and had been labelled *uptake-1*. The indirectly acting sympathomimetic amines like tyramine, but not isoprenaline, also utilize this pump for entering the neurone. This uptake is the most important mechanism for terminating the postjunctional action of NA. This pump is inhibited by cocaine, desipramine and few other drugs.

Vesicular uptake The membrane of intracellular vesicles has another amine pump the 'vesicular monoamine transporter' (VMAT-2), which transports CA from the cytoplasm to within the storage vesicle. The VMAT-2 transports monoamines by exchanging with H⁺ ions. The vesicular NA is constantly leaking out into the axoplasm and is recaptured by this mechanism. This carrier also takes up DA formed in the axoplasm for further synthesis to NA. Thus, it is very important in maintaining the NA content of the neurone. This uptake is inhibited by reserpine, resulting in depletion of CAs.

Extraneuronal uptake of CAs (uptake-2) is carried out by extraneuronal amine transporter (ENT or OCT3) and other organic cation transporters OCT1 and OCT2 into cells of other tissues. In contrast to NET this uptake transports Adr at a higher rate than NA, is not Na⁺ dependent and is not inhibited by cocaine, but inhibited by corticosterone. It is not of physiological or pharmacological importance.

5. Metabolism of CAs The pathways of metabolism of CAs are depicted in Fig. 9.2. Part of the NA leaking out from granules into cytoplasm as well as that taken up by axonal transport is first attacked by MAO, while that which diffuses into circulation is first acted upon by catechol-O-methyl transferase (COMT) in liver and other tissues. In both cases, the alternative enzyme can subsequently act to produce vanillylmandelic acid (VMA). The major metabolites excreted in urine are VMA and 3-methoxy-4-hydroxy phenylethylene glycol (a reduced product) along with some metanephrine, normetanephrine and 3,4 dihydroxy mandelic acid. These metabolites

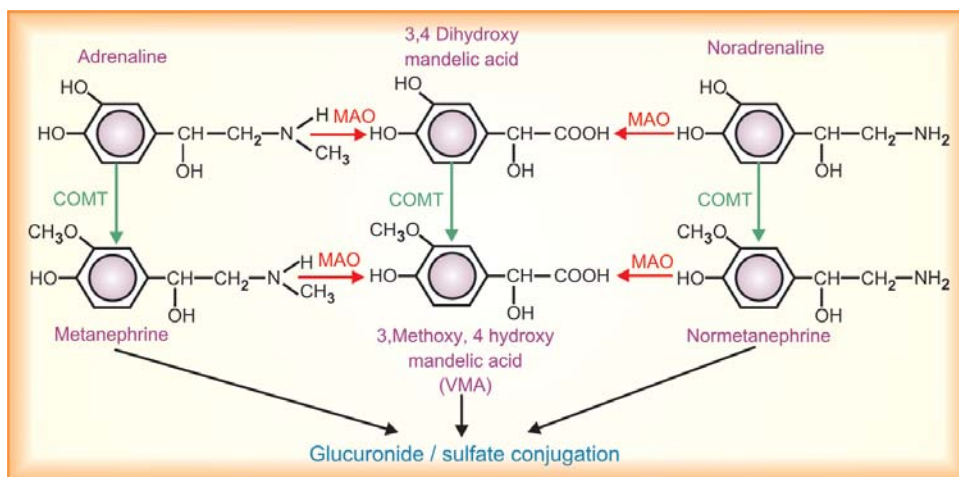

Fig. 9.2: Metabolism of catecholamines

are mostly conjugated with glucuronic acid or sulfate before excretion in urine. Only 25–50 μg of NA and 2–5 μg of Adr are excreted in the free form in 24 hours. However, metabolism does not play an important role in terminating the action of neuronally released CAs.

6. Adrenergic receptors Adrenergic receptors are membrane bound G-protein coupled receptors which function primarily by increasing or decreasing the intracellular production of second

messengers cAMP or IP₃/DAG. In some cases the activated G-protein itself operates K⁺ or Ca²⁺ channels, or increases prostaglandin production.

Ahlquist (1948), on the basis of two distinct rank order of potencies of adrenergic agonists (Fig. 9.3), classified adrenergic receptors into two types α and β . This classification was confirmed later by the discovery of selective α and β adrenergic antagonists. Important features of α and β receptors are given in Table 9.1.

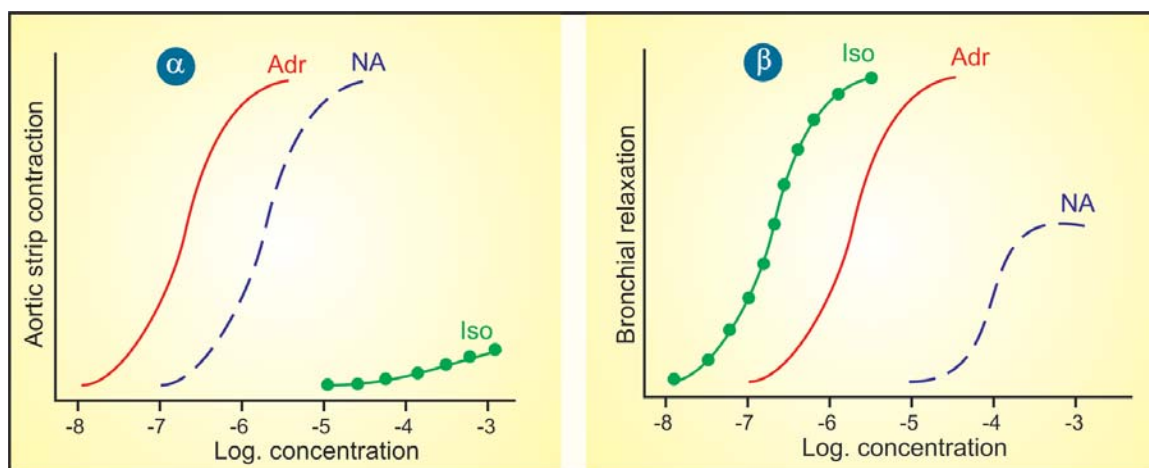

Fig. 9.3: Dose-response curves of 3 catecholamines adrenaline (Adr), noradrenaline (NA) and isoprenaline (Iso) on isolated aortic strip and isolated bronchial smooth muscle illustrating two distinct rank orders of potencies respectively for α and β adrenergic receptors

Table 9.1: Differences between α and β adrenergic receptors

	α	β
1. Rank order of potency of agonists	Adr \geq NA > Iso	Iso > Adr > NA
2. Antagonist	Phenoxybenzamine	Propranolol
3. Effector pathway	IP ₃ /DAG \uparrow , cAMP \downarrow , K ⁺ channel \uparrow	cAMP \uparrow , Ca ²⁺ channel \uparrow

Table 9.2: Differences between β_1 , β_2 and β_3 receptors

	β_1	β_2	β_3
1. Location	Heart, JG cells in kidney	Bronchi, blood vessels, uterus, liver, g.i.t., urinary tract, eye	Adipose tissue
2. Selective agonist	Dobutamine	Salbutamol, terbutalin	BRL 37344
3. Selective antagonist	Metoprolol, Atenolol	ICI 118551 α -methyl propranolol	CGP 20712A (also β_1) ICI 118551 (also β_2)
4. Potency of NA as agonist	Moderate	Weak	Strong

Table 9.3: Differences between α_1 and α_2 receptors

	α_1	α_2
Location	Postjunctional on effector organs	Prejunctional on nerve ending (α_{2A}), also postjunctional in brain, pancreatic β cells and extrajunctional in certain blood vessels, platelets
Function subserved	GU Smooth muscle—contraction Vasoconstriction Gland—secretion Gut—relaxation Liver—glycogenolysis Heart—arrhythmia	Inhibition of transmitter release Vasoconstriction Decreased central sympathetic flow Decreased insulin release Platelet aggregation
Selective agonist	Phenylephrine, Methoxamine	Clonidine
Selective antagonist	Prazosin	Yohimbine, Rauwolscine
Effector pathway	IP ₃ /DAG \uparrow Phospholipase A ₂ \uparrow —PG release	cAMP \downarrow K ⁺ channel \uparrow Ca ²⁺ channel \downarrow or \uparrow IP ₃ /DAG \uparrow

GU: Genitourinary

On the basis of relative organ specificity of selective agonists and antagonists the β receptors were further subdivided into β_1 and β_2 subtypes. Later, β_3 (atypical β) receptors were described which have very low affinity for the standard β blockers. These are located on adipocytes, mediate lipolysis and induce thermogenesis. Selective β_3 agonists are being developed as potential antiobesity drugs.

In the mid 1970s the α receptors were demonstrated to be present prejunctionally as well. To differentiate these release inhibitory prejunctional α receptors, a subdivision into α_1 and α_2 was suggested. However, the present classification into α_1 and α_2 is based on pharmacological criteria (selectivity of agonists and antagonists) and not on anatomical location. Molecular cloning has further identified 3 subtypes of α_1

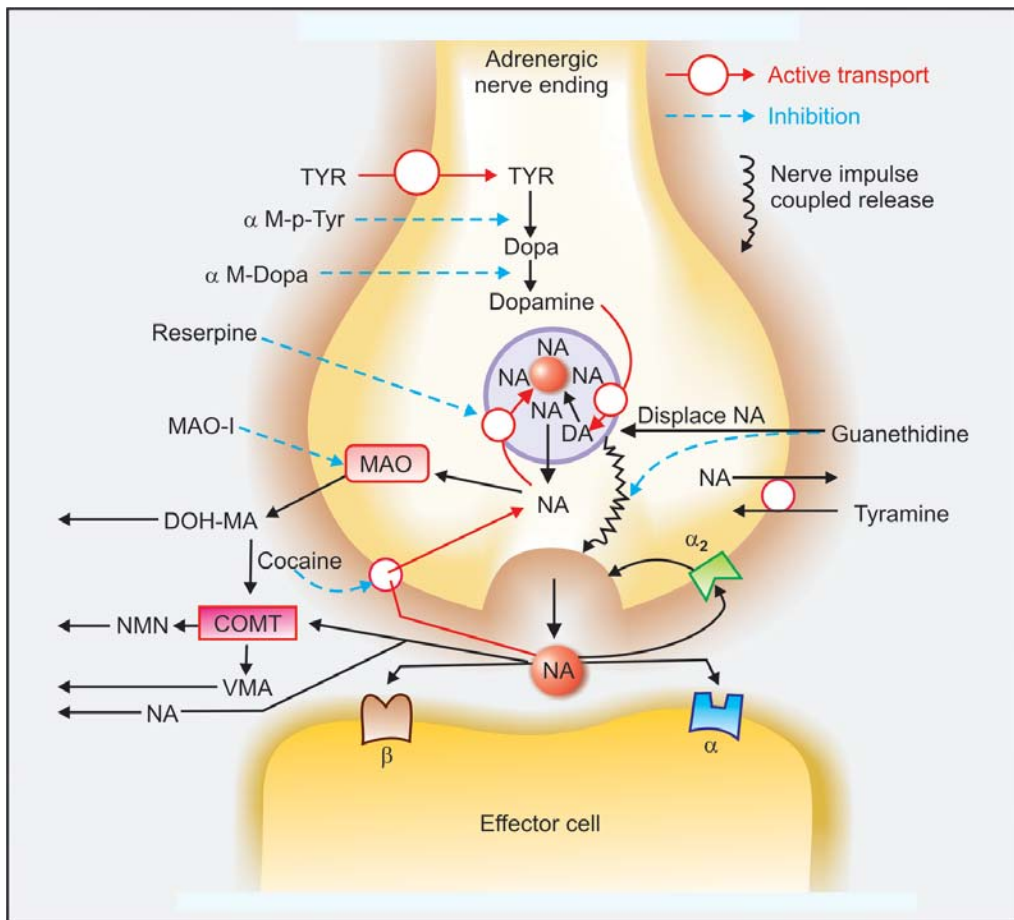

Fig. 9.4: Schematic representation of adrenergic neurotransmission and its modification by drugs
 TYR—tyrosine; α M-p-TYR— α methyl-p-tyrosine; α M-DOPA— α methyl dopa; MAO—monoamineoxidase; MAOI—monoamine oxidase inhibitor; COMT—catechol-o-methyl transferase; DOH-MA—dihydroxy mandelic acid, NMN—nor-metanephrine; VMA—vanillyl mandelic acid

(α_{1A} , α_{1B} , α_{1D}) and 3 subtypes of α_2 (α_{2A} , α_{2B} , α_{2C}) receptors.

Though tissue distribution of subtypes of α_1 and α_2 receptors has been mapped, it is not very clear cut. Sufficiently subtype selective agonists or antagonists have also not yet been developed to pharmacologically exploit the molecular heterogeneity of α_1 and α_2 receptors.

The adrenergic neuronal mechanisms and action of drugs which modify them are depicted in Fig. 9.4. A summary of drugs acting through adrenergic neuronal mechanisms is presented in Table 9.4

ADRENERGIC DRUGS (Sympathomimetics)

These are drugs with actions similar to that of Adr or of sympathetic stimulation.

Direct sympathomimetics They act directly as agonists on α and/or β adrenoceptors—Adr, NA, isoprenaline (Iso), phenylephrine, methoxamine, xylometazoline, salbutamol and many others.

Indirect sympathomimetics They act on adrenergic neurone to release NA, which then acts on the adrenoceptors—tyramine, amphetamine.

Table 9.4: Summary of drug action through modification of adrenergic transmission

<i>Step/site</i>	<i>Action</i>	<i>Drug</i>	<i>Response</i>
1. Synthesis of NA	Inhibition Utilisation of same synthetic pathway	α -methyl-p-tyrosine α -methyl dopa	Depletion of NA Replacement of NA by α -methyl NA (false transmitter)
2. Axonal uptake	Blockade	Cocaine, desipramine, guanethidine, ephedrine	Potentialiation of NA (endo-and exogenous), inhibition of tyramine
3. Vesicular uptake	Blockade	Reserpine	Depletion of NA (degraded by MAO)
4. Nerve impulse coupled release of NA	Inhibition	Guanethidine, bretylium	Loss of transmission
5. Vesicular NA	Displacement	Guanethidine	Initially sympathomimetic, depletion later
6. Membrane NA pool	Exchange diffusion	Tyramine, ephedrine	Indirect sympathomimetic
7. Metabolism	MAO-inhibition	Nialamide, tranylcypromine	Potentialiation of NA (slight), —of tyramine (marked)
	MAO-A inhibition	Moclobemide	Potentialiation of NA and tyramine (slight)
	MAO-B inhibition	Selegiline	Potentialiation of DA in brain
	COMT inhibition	Tolcapone, entacapone	Potentialiation of NA and DA (slight)
8. Receptors	Mimicking	Phenylephrine Clonidine Isoprenaline Dobutamine Salbutamol	α_1 sympathomimetic α_2 —inhibition of NA release, \downarrow sympathetic outflow $\beta_1 + \beta_2$ —sympathomimetic β_1 —sympathomimetic: cardiac stimulation β_2 —sympathomimetic: bronchodilatation
	Blockade	Phenoxybenzamine Prazosin Yohimbine Propranolol Metoprolol	$\alpha_1 + \alpha_2$ —blockade α_1 —blockade α_2 —blockade $\beta_1 + \beta_2$ —blockade β_1 —blockade

Mixed action sympathomimetics They act directly as well as indirectly—ephedrine, dopamine, mephentermine.

ACTIONS

The peripheral actions of Adr in most tissues have been clearly differentiated into those mediated by α or β receptors depending on the predominant receptor type present in a given tissue. These are tabulated in Table 9.5. The

receptor subtype, wherever defined, has been mentioned in parenthesis. The actions of a particular sympathomimetic amine depend on its relative activity at different types of adrenergic receptors.

Adr: $\alpha_1 + \alpha_2 + \beta_1 + \beta_2$ and weak β_3 action
 NA: $\alpha_1 + \alpha_2 + \beta_1 + \beta_3$ but no β_2 action
 Iso: $\beta_1 + \beta_2 + \beta_3$ but no α action

Important actions of Adr, NA and isoprenaline are compared in Table 9.6.

Table 9.5: Adrenergic responses mediated through α and β receptors

α actions	β actions
1. Constriction of arterioles and veins \rightarrow rise in BP ($\alpha_1 + \alpha_2$)	Dilatation of arterioles and veins \rightarrow fall in BP (β_2)
2. Heart—little action, arrhythmia at high dose (α_1)	Cardiac stimulation (β_1), \uparrow rate, force and conduction velocity
3. —	Bronchodilatation (β_2)
4. Contraction of radial muscles of iris \rightarrow mydriasis (α_1), decreased aqueous secretion	No effect on iris, slight relaxation of ciliary muscle, Enhanced aqueous secretion
5. Intestinal relaxation, contraction of sphincters	Intestinal relaxation (β_2)
6. Bladder trigone—contraction (α_1)	Detrusor—relaxation (β_2)
7. Uterus—contraction (α_1)	Relaxation (β_2)
8. Splenic capsule—contraction (α_1)	Relaxation (β_2) (slight)
9. Neuromuscular transmission facilitated, \uparrow ACh release	Active state—prolonged in fast contracting muscle, abbreviated in slow contracting muscle; tremors (β_2)
10. Insulin secretion inhibited (α_2) (dominant)	Augmented insulin (mild) and glucagon secretion (β_2)
11. Liver—glycogenolysis (α in some species)	Liver—glycogenolysis (β_2) \rightarrow hyperglycaemia Muscle—glycogenolysis (β_2) \rightarrow hyperlactacidaemia Fat—lipolysis ($\beta_1 + \beta_2 + \beta_3$) \rightarrow increased blood FFA, calorigenesis
12. —	Renin release from kidney (β_1)
13. Male sex organs—ejaculation (α_1)	—
14. Salivary gland— K^+ and water secretion (α_1)	Ptylin secretion
15. —	ADH secretion from posterior pituitary (β_1)
16. Nictitating membrane—contraction (in animals)	—

Table 9.6: Comparative effects of adrenaline, noradrenaline and isoprenaline

	<i>Adr</i>	<i>NA</i>	<i>Iso</i>
1. Heart rate	\uparrow	\downarrow	$\uparrow\uparrow$
2. Cardiac output	$\uparrow\uparrow$	—	$\uparrow\uparrow$
3. BP—Systolic	$\uparrow\uparrow$	$\uparrow\uparrow$	\uparrow
Diastolic	$\downarrow\uparrow$	$\uparrow\uparrow$	$\downarrow\downarrow$
Mean	\uparrow	$\uparrow\uparrow$	\downarrow
4. Blood flow			
Skin and mm	\downarrow	\downarrow	—
Sk. muscle	$\uparrow\uparrow$	—, \downarrow	\uparrow
Kidney	\downarrow	\downarrow	—
Liver	$\uparrow\uparrow$	—	\uparrow
Coronary	\uparrow	\uparrow	\uparrow
5. Bronchial muscle	$\downarrow\downarrow$	—	$\downarrow\downarrow$
6. Intestinal muscle	$\downarrow\downarrow$	\downarrow	\downarrow
7. Blood sugar	$\uparrow\uparrow$	—, \uparrow	\uparrow

The overall actions are —

1. Heart Adr increases heart rate by increasing the slope of slow diastolic depolarization of cells in the SA node. It also activates latent pacemakers in A-V node and Purkinje fibres; arrhythmias can occur with high doses that raise BP markedly. Raised BP reflexly depresses the SA node and unmasks the latent pacemakers. Certain anaesthetics (chloroform, halothane) sensitize the heart to arrhythmic action of Adr. Idioventricular rate is increased in patients with complete heart block.

Force of cardiac contraction is increased. Development of tension as well as relaxation are accelerated. Thus, systole is shortened more than diastole. Cardiac output and oxygen consumption of the heart are markedly enhanced.

Conduction velocity through A-V node, bundle of His, atrial and ventricular fibres is increased; partial A-V block may be overcome. Refractory period (RP) of all types of cardiac cells is reduced. All cardiac actions are predominantly β_1 receptor mediated.

When BP rises markedly, reflex bradycardia occurs due to stimulation of vagus—this is the usual response seen when NA is injected i.v.

2. Blood vessels Both vasoconstriction (α) and vasodilatation (β_2) can occur depending on the drug, its dose and vascular bed. Constriction predominates in cutaneous, mucous membrane and renal beds. Vasoconstriction occurs through both α_1 and α_2 receptors. However, location of α_2 (extrajunctional) receptors is such that they are activated only by circulating CAs, whereas α_1 (junctional) receptors primarily mediate responses to neuronally released NA. Dilatation predominates in skeletal muscles, liver and coronaries. The direct effect on cerebral vessels is not prominent—blood flow through this bed parallels change in BP.

Action is most marked on arterioles; larger arteries and veins are affected at higher doses.

3. BP The effect depends on the amine, its dose and rate of administration.

- NA causes rise in systolic, diastolic and mean BP; it does not cause vasodilatation (no β_2 action), peripheral resistance increases consistently due to α action.
- Isoprenaline causes rise in systolic but marked fall in diastolic BP (β_1 —cardiac stimulation, β_2 —vasodilatation). The mean BP generally falls.
- Adr given by slow i.v. infusion or s.c. injection causes rise in systolic but fall in diastolic BP; peripheral resistance decreases because vascular β_2 receptors are more sensitive than α receptors. Mean BP generally rises. Pulse pressure is increased.
- Rapid i.v. injection of Adr (in animals) produces a marked increase in both systolic as well as diastolic BP (at high concentration

α response predominates and vasoconstriction occurs even in skeletal muscles). The BP returns to normal within a few minutes and a secondary fall in mean BP follows. The mechanism is—rapid uptake and dissipation \rightarrow concentration of Adr is reduced \rightarrow low concentrations are not able to act on α receptors but continue to act on β_2 receptors.

When an α blocker has been given, only fall in BP is seen—*vasomotor reversal of Dale*.

4. Respiration Adr and isoprenaline, but not NA are potent bronchodilators (β_2). This action is more marked when the bronchi are constricted. Adr given by aerosol additionally decongests bronchial mucosa by α action. Adr can directly stimulate respiratory centre (RC) but this action is seldom manifest at clinically used doses. Rapid i.v. injection (in animals) causes transient apnoea due to reflex inhibition of RC. Toxic doses of Adr cause pulmonary edema by shifting blood from systemic to pulmonary circuit.

5. Eye Mydriasis occurs due to contraction of radial muscles of iris (α_1), but this is minimal after topical application, because Adr penetrates cornea poorly. The intraocular tension tends to fall, especially in wide angle glaucoma.

Adr has complex effects on aqueous humor dynamics (*see p. 146*).

Action of adrenaline on aqueous humor dynamics

Receptor	Agonist action
α_1 :	Vasoconstriction of ciliary vessels \rightarrow reduced aqueous formation
α_2 :	Reduced secretory activity of ciliary epithelium
β_2 :	Enhanced secretory activity of ciliary epithelium Facilitation of trabecular outflow
? :	Augmentation of uveo-scleral outflow

Overall, aqueous formation is reduced and outflow is facilitated.

6. GIT In isolated preparations of gut, relaxation occurs through activation of both α and β receptors. In intact animals and man peristalsis is reduced and sphincters are constricted, but the effects are brief and of no clinical import.

7. Bladder Detrusor is relaxed (β) and trigone is constricted (α): both actions tend to hinder micturition.

8. Uterus Adr can both contract and relax uterine muscle, respectively through α and β receptors. The overall effect varies with species, hormonal and gestational status.

	<i>Nonpregnant</i>	<i>Pregnant</i>
<i>Rat</i>	Relaxation	Relaxation
<i>Rabbit</i>	Contraction	Contraction
<i>Cat</i>	Relaxation	Contraction
<i>Human</i>	Contraction	Relaxation (at term only)

9. Splenic capsule Contracts (α) and more RBCs are poured in circulation. This action is not evident in man.

10. Skeletal muscle Neuromuscular transmission is facilitated. In contrast to action on autonomic nerve endings, α receptor activation on motor nerve endings augments ACh release, probably because it is of the α_1 subtype. The direct effect on muscle fibres is exerted through β_2 receptors and differs according to the type of fibre. The active state is abbreviated and less tension is developed in the slow contracting red fibres— incomplete fusion of individual responses. This along with enhanced firing of muscle spindles is responsible for the tremors produced by β_2 agonists. The action on rapidly contracting white fibres is to prolong the active state and increase the tension developed.

11. CNS Adr, in clinically used doses, does not produce any marked CNS effects because of poor penetration in brain, but restlessness, apprehension and tremor may occur. Activation of α_2 receptors in the brainstem results in decreased sympathetic outflow \rightarrow fall in BP and bradycardia.

12. Metabolic Adr produces glycogenolysis \rightarrow hyperglycaemia, hyperlactacidaemia (β_2); lipolysis \rightarrow rise in plasma free fatty acid (FFA), calorigenesis ($\beta_2 + \beta_3$) and transient hyperkalaemia followed by hypokalaemia due to direct action on liver, muscle and adipose tissue cells. In addition metabolic effects result from reduction of insulin (α_2) and augmentation of glucagon (β_2) secretion.

Biochemical mediation of adrenergic responses

β actions The β actions are mediated through cAMP (see Fig. 4.6). Adr activates membrane bound enzyme *adenylyl cyclase* through a regulatory protein Gs \rightarrow ATP is broken down to cAMP at the inner face. This in turn phosphorylates a number of intracellular cAMP-dependent protein kinases and initiates a series of reactions:

(i) In *liver* and *muscle*, glycogen phosphorylase is activated causing glycogenolysis while glycogen synthetase is inhibited. Both actions result in hyperglycaemia and hyperlactacidemia. Neoglucogenesis in liver adds to the response.

K^+ is first released from liver \rightarrow hyperkalaemia; followed by more prolonged hypokalaemia due to K^+ uptake in muscle and later in liver itself.

(ii) In *adipose tissue*, triglyceride lipase is activated \rightarrow increased plasma free fatty acids. Increased O_2 consumption and heat production result primarily by action on brown adipose tissue, which has predominant β_3 receptors.

(iii) In *heart*, proteins like troponin and phospholamban are phosphorylated. The former results in increased interaction with Ca^{2+} at the myofilaments \rightarrow increased force of contraction; the latter causes sequestration of Ca^{2+} by sarcoplasmic reticulum \rightarrow more rapid relaxation. The activated protein Gs, in addition, interacts directly with the Ca^{2+} channels in the membrane promoting influx of Ca^{2+} which reinforces the positive inotropic action exerted through cAMP.

(iv) In the *gut* and *bronchial muscle*, relaxation (accompanied with hyperpolarization) is induced, but the intermediate steps have not been clearly delineated.

(v) In *pancreatic islets* activation of β_2 receptors on α cells increases glucagon secretion, and that on β cells increases insulin secretion, both by raising intracellular cAMP. However, augmentation of insulin secretion is weak.

α actions The mediation of α actions is varied and less well defined.

(i) In *smooth muscles* (including vascular) that are contracted through α_1 receptors, the activated G-protein increases IP_3 /DAG production \rightarrow mobilization of Ca^{2+} from intracellular organelle \rightarrow activation of calmodulin dependent myosin light chain kinase \rightarrow phosphorylation

of myosin → contraction. The vasoconstrictor α_2 receptors probably enhance Ca^{2+} influx without utilizing IP_3 .

(ii) The *prejunctional* α_2 receptor appears to inhibit neuronal Ca^{2+} channels and also limit the intracellular availability of Ca^{2+} by decreasing cAMP production. Transmitter (NA) release is consequently diminished. Hyperpolarization through activation of K^+ channels may also occur.

(iii) In the *gut*, α_2 receptor activation hyperpolarizes the cholinergic neurone → decreased release of ACh → reduced tone; whereas α_1 receptors located directly on the smooth muscle cell increase K^+ efflux → hyperpolarization → relaxation.

(iv) In *pancreatic β cells*, stimulation of α_2 receptors reduces the formation of cAMP → decreased insulin release.

Administration and preparations

CAs are absorbed from the intestine but are rapidly degraded by MAO and COMT present in the intestinal wall and liver. They are thus orally inactive.

1. *Adrenaline (Epinephrine)* For systemic action, 0.2–0.5 mg s.c., i.m., action lasts ½ to 2 hrs. **ADRENALINE 1 mg/ml inj.**

As local vasoconstrictor, 1 in 200,000 to 1 in 100,000 added to lidocaine; in **XYLOCAINE** with **ADRENALINE**: lidocaine 21.3 mg + adrenaline 0.005 mg/ml inj; 30 ml vial.

2. *Noradrenaline (Norepinephrine, levarterenol)* 2–4 $\mu\text{g}/\text{min}$ i.v. infusion; local tissue necrosis occurs if the solution extravasates; do not mix with NaHCO_3 in the same bottle (rapid oxidation occurs); action starts declining within 5 min of discontinuing infusion. It is rarely used now as a pressor agent. **ADRENOR, NORAD, VASCUE, NORDRIN 2 mg (base)/2 ml amp.**

3. *Isoprenaline (Isoproterenol)* 20 mg sublingual, 1–2 mg i.m., 5–10 $\mu\text{g}/\text{min}$ i.v. infusion; action lasts 1–3 hrs. It is occasionally used to maintain idioventricular rate till pacemaker is implanted. For bronchial asthma, it has been superseded by selective β_2 agonists. **ISOPRIN 4 mg/2 ml inj, NEOEPININE 20 mg sublingual tablets.**

Adverse effects and contraindications

- Transient restlessness, palpitation, anxiety, tremor, pallor may occur after s.c./i.m. injection of Adr.

- Marked rise in BP leading to cerebral haemorrhage, ventricular tachycardia/fibrillation, angina, myocardial infarction are the hazards of large doses or inadvertent i.v. injection of Adr.
- Adr is contraindicated in hypertensive, hyperthyroid and angina patients.
- Adr should not be given during anaesthesia with halothane (risk of arrhythmias) and to patients receiving β blockers (marked rise in BP can occur due to unopposed α action).

THERAPEUTIC CLASSIFICATION OF ADRENERGIC DRUGS

I. *Pressor agents*

Noradrenaline	Phenylephrine
Ephedrine	Methoxamine
Dopamine	Mephentermine

II. *Cardiac stimulants*

Adrenaline	Dobutamine
Isoprenaline	

III. *Bronchodilators*

Isoprenaline	Salmeterol
Salbutamol	Formoterol
(Albuterol)	Bambuterol
Terbutaline	

IV. *Nasal decongestants*

Phenylephrine	Naphazoline
Xylometazoline	Pseudoephedrine
Oxymetazoline	Phenylpropanolamine

V. *CNS stimulants*

Amphetamine	Methamphetamine
Dexamphetamine	

VI. *Anorectics*

Fenfluramine	Sibutramine
Dexfenfluramine	

VII. *Uterine relaxant and vasodilators*

Ritodrine	Salbutamol
Isoxsuprine	Terbutaline

Salient features of important adrenergic drugs are described below.

Dopamine (DA) It is a dopamine (D1 and D2) as well as adrenergic α and β_1 (but not β_2) agonist. The D1 receptors in renal and mesenteric blood vessels are the most sensitive; i.v. infusion of low dose of DA dilates these vessels (by raising intracellular cAMP). This increases g.f.r. and Na^+ excretion. Moderately high doses produce a positive inotropic (direct β_1 and D1 action + that due to NA release), but little chronotropic effect on heart. Vasoconstriction (α_1 action) occurs only when large doses are infused. At doses normally employed, it raises cardiac output and systolic BP with little effect on diastolic BP. It has practically no effect on nonvascular α and β receptors; does not penetrate blood-brain barrier—no CNS effects.

Dopamine is used in patients of cardiogenic or septic shock and severe CHF wherein it increases BP and urine outflow. It is administered by i.v. infusion (0.2–1 mg/min) which is regulated by monitoring BP and rate of urine formation.

DOPAMINE, INTROPIN, DOPACARD 200 mg in 5 ml amp.

Dobutamine A derivative of DA, but not a D1 or D2 receptor agonist. Though it acts on both α and β adrenergic receptors, the only prominent action of clinically employed doses (2–8 $\mu\text{g}/\text{kg}/\text{min}$ i.v. infusion) is increased force of cardiac contraction and output, without significant change in heart rate, peripheral resistance and BP. As such, it has been considered to be a relatively selective β_1 agonist. It is used as an inotropic agent in pump failure accompanying myocardial infarction, cardiac surgery, and for short term management of severe congestive heart failure. It is less arrhythmogenic than Adr.

CRDIJECT 50 mg/4 ml and 250 mg per 20 ml amp, **DOBUTREX, DOBUSTAT** 250 mg vial.

Ephedrine It is an alkaloid obtained from *Ephedra vulgaris*. Mainly acts indirectly but has some direct action on α and β receptors also. Repeated injections produce tachyphylaxis, primarily because the neuronal pool of NA available for displacement is small. It is resistant to MAO, therefore, effective orally. It is about 100

times less potent than Adr, but longer acting (4–6 hours). Ephedrine crosses to brain and causes stimulation, but central: peripheral activity ratio is lower than that of amphetamine.

Ephedrine can be used for a variety of purposes, but it lacks selectivity, and efficacy is low. Use is now restricted to that in mild chronic bronchial asthma and for hypotension during spinal anaesthesia; occasionally for postural hypotension; 15–60 mg TDS.

EPHEDRINE HCl 15, 30 mg tab; **SULFIDRIN** 50 mg in 1 ml inj, in **ENDRINE** 0.75% nasal drops.

Amphetamines These are synthetic compounds having a pharmacological profile similar to ephedrine; orally active with long duration (4–6 hours). The CNS actions are more prominent; maximal selectivity is exhibited by dextroamphetamine and methamphetamine, which in the usual doses produce few peripheral effects.

The central effects include alertness, increased concentration and attention span, euphoria, talkativeness, increased work capacity. Fatigue is allayed. Athletic performance is improved temporarily followed by deterioration. It is one of the drugs included in the 'dope test' for athletes. The reticular activating system is stimulated resulting in wakefulness and postponement of sleep deprivation induced physical disability. But this is short-lived and may be accompanied by anxiety, restlessness, tremor, dysphoria and agitation. Such use before examinations can only be condemned.

Amphetamines stimulate respiratory centre, specially if it has been depressed. Hunger is suppressed as a result of inhibition of hypothalamic feeding centre. They also have weak anticonvulsant, analgesic and antiemetic actions: potentiate antiepileptics, analgesics and antimotion-sickness drugs. Peripheral effects on heart and BP are not significant at the usual doses (which cause only slight rise in BP), but tone of vesical sphincter is definitely increased.

Amphetamines are drugs of abuse and are capable of producing marked psychological but little or no physical dependence. Amphetamine

abusers are generally teenagers seeking thrill or kick which is obtained on rapid i.v. injection. High doses produce euphoria, marked excitement which may progress to mental confusion, delirium, hallucinations and an acute psychotic state. Peripheral component of toxicity includes vasomotor effects, palpitation, arrhythmias, vomiting, abdominal cramps and vascular collapse. Death is usually preceded by convulsions and coma.

Repeated use is more likely to produce long lasting behavioural abnormalities; psychosis may be precipitated.

Tolerance to central actions and toxic effects of amphetamine develops, and is both pharmacokinetic as well as pharmacodynamic. Starvation due to suppression of appetite produces acidic urine; amphetamine is ionized more at acidic pH and is excreted more rapidly.

Treatment of amphetamine toxicity includes administration of chlorpromazine which controls both central as well as peripheral α adrenergic effects. The central actions are largely mediated by release of NA in the brain. However, certain actions are probably due to DA and 5-HT release. It also inhibits neuronal uptake of DA.

Amphetamine: 5–15 mg oral; **BENZEDRINE 5 mg tab.**
 Dexamphetamine: 5–10 mg (children 2.5–5 mg) oral; **DEXEDRINE 5 mg tab.**
 Methamphetamine: 5–10 mg oral; **METHEDRINE 5 mg tab.**

Phenylephrine It is a selective α_1 agonist, has negligible β action. It raises BP by causing vasoconstriction. Because it has little cardiac action, reflex bradycardia is prominent. Topically it is used as a nasal decongestant and for producing mydriasis when cycloplegia is not required. Phenylephrine tends to reduce intraocular tension by constricting ciliary body blood vessels. It is also a frequent constituent of orally administered nasal decongestant preparations. Central effects are not seen with usual clinical doses.

Dose: 2–5 mg i.m., 0.1–0.5 mg slow i.v. inj, 30–60 μ g/min i.v. infusion; 5–10 mg oral; 0.25–0.5% nasal instillation; 5–10% topically in eye;

FRENIN 10 mg in 1 ml inj; DECOLD PLUS 5 mg with paracetamol 400 mg + chlorpheniramine 2 mg + caffeine

15 mg tab., FENOX 0.25% with naphazoline 0.025% nasal drops, DROSYN 10% eye drops, in DROSYN-T, TROPAC-P 5% with tropicamide 0.8% eye drops.

Methoxamine Another selective α_1 agonist with no β actions (has weak β blocking action). Resembles phenylephrine very closely. Occasionally used as a pressor agent.

Dose: 10–20 mg i.m.; 3–5 mg slow i.v. inj.
VASOXINE 20 mg/ml inj.

Mephentermine It produces both cardiac stimulation and vasoconstriction by directly activating α and β adrenergic receptors as well as by releasing NA. Cardiac output, systolic and diastolic BP are increased. The direct positive chronotropic effect on heart is generally counter balanced by vagal stimulation due to rise in mean BP.

Mephentermine is not a substrate for either MAO or COMT: active orally with longer duration of action (2–6 hr). It crosses blood-brain barrier to some extent—may produce excitatory effects at higher doses. It is used to prevent and treat hypotension due to spinal anaesthesia and surgical procedures, shock in myocardial infarction and other hypotensive states.

Dose: 10–20 mg oral/i.m., also by slow i.v. infusion.
MEPHENTINE 10 mg tab, 15 mg in 1 ml amp, 3 mg/ml in 10 ml vial.

SELECTIVE β_2 STIMULANTS

These include, salbutamol, terbutaline, salmeterol, formoterol and ritodrine. They cause bronchodilatation, vasodilatation and uterine relaxation, without producing significant cardiac stimulation. β_2 selectivity is only relative. Salbutamol has β_2 : β_1 action ratio of about 10. They are primarily used in bronchial asthma (for description see Ch. 16). Other uses are:

- As uterine relaxant to delay premature labour. Ritodrine is the preferred drug (see p. 323);
- In hyperkalaemic familial periodic paralysis— β_2 agonists benefit by enhancing K^+ uptake into muscles \rightarrow lowering plasma K^+ levels.

The most important side effect is muscle tremor; tachycardia and arrhythmias are less likely.

Isoxsuprine It is an orally effective long-acting selective β receptor stimulant which has direct smooth muscle relaxant property as well. It has been used as uterine relaxant for threatened abortion and dysmenorrhoea, but efficacy is poor. Beneficial effects in peripheral and cerebral vascular diseases are disappointing.

Side effects: nausea, tachycardia, flushing, hypotension, dizziness, tremor.

Dose: 5–10 mg oral, i.m. 4–6 hourly, DUVADILAN 10 mg tab, 40 mg SR cap, 10 mg/2 ml inj.

NASAL DECONGESTANTS

These are α agonists which on topical application as dilute solution (0.05–0.1%) produce local vasoconstriction. The imidazoline compounds—naphazoline, xylometazoline and oxymetazoline are relatively selective α_2 agonist (like clonidine). They have a longer duration of action (12 hours) than ephedrine. After-congestion is claimed to be less than that with ephedrine or phenylephrine. They may cause initial stinging sensation (specially naphazoline). Regular use of these agents for long periods should be avoided because mucosal ciliary function is impaired: atrophic rhinitis and anosmia can occur due to persistent vasoconstriction. They can be absorbed from the nose and produce systemic effects—CNS depression and rise in BP. These drugs should be used cautiously in hypertensives and in those receiving MAO inhibitors.

Xylometazoline: 0.05–0.1% topical in nose; OTRIVIN 0.05% (pediatric), 0.1% nasal drops.

Oxymetazoline: 0.025–0.05% topical in nose; NASIVION, SINAREST 0.025% (pediatric), 0.05% nasal drops.

Naphazoline: 0.1% topical in nose; PRIVINE 0.1% nasal drops.

Pseudoephedrine A stereoisomer of ephedrine; causes vasoconstriction, especially in mucosae and skin, but has fewer CNS and cardiac effect and is a poor bronchodilator (little β_2 agonistic activity). It has been used orally as a decongestant of upper respiratory tract, nose and eustachian tubes. Combined with antihistaminics, mucolytics, antitussives and analgesics, it is believed to afford symptomatic relief in common cold,

allergic rhinitis, blocked eustachian tubes and upper respiratory tract infections. However, no selective action on these vascular beds has been demonstrated; rise in BP can occur, especially in hypertensives.

Dose: 30–60 mg TDS.

SUDAFED 60 mg tab, 30 mg/5 ml syrup; in SINAREST 60 mg with chlorpheniramine 2 mg + caffeine 30 mg + paracetamol 500 mg tab; in CHESTON 30 mg with chlorpheniramine 2 mg + bromhexine 4 mg per tab/5 ml syr; in ACTICOLD 60 mg with chlorpheniramine 4 mg + paracetamol 500 mg tab; in CODYLEX 60 mg with chlorpheniramine 4 mg + ibuprofen 400 mg tab.

Phenylpropanolamine (PPA) Chemically and pharmacologically similar to ephedrine; causes vasoconstriction and has some amphetamine like CNS effects. It is included in a large number of oral cold/decongestant combination remedies; in USA it was used as an appetite suppressant as well.

Many reports associating PPA use (for weight loss) with haemorrhagic stroke among women appeared in the USA. A case control study “Haemorrhagic Stroke Project” was undertaken, which found that though overall data showed only a marginally increased risk in men and women (whether used for weight loss or for cold), there was a strong association when 3 day exposure preceding stroke was considered. Also, there have been concerns regarding its potential to precipitate behavioral/psychiatric disturbances. The FDA concluded that indications for which PPA is used do not warrant the excess risk (though marginal) and recommended discontinuation of PPA containing products. In UK, Canada and Japan warnings have been issued and labelling changed. In India PPA containing formulations are available over the counter, but the recommended daily dose does not exceed 100 mg (which is lower than the dosage used in USA).

Dose: 25–50 mg TDS;

In ACTIFED 25 mg with triprolidine 2.5 mg tab; in ESKOLD 50 mg with diphenylpyraline 5 mg spansule; in FLUCOLD 25 mg with chlorpheniramine 2 mg + paracetamol 500 mg tab.

ANORECTIC AGENTS

Because of adverse central effects, the use of amphetamines to suppress appetite cannot be justified. A number of related drugs have been developed which inhibit feeding centre (like amphetamine) but have little/no CNS stimulant action or abuse liability. All of them act by

inhibiting the reuptake of NA/DA or 5-HT, enhancing monoaminergic transmission in the brain. Accordingly they may be grouped into:

Noradrenergic agents: Phentermine, phenylpropranolamine (PPA), diethylpropion, mazindol.

Serotonergic agents: Fenfluramine, dexfenfluramine.

Noradrenergic/serotonergic agent: Sibutramine.

The noradrenergic agents primarily affect the appetite centre, while the serotonergic ones primarily affect the satiety centre. The noradrenergic agents activate hypothalamic adrenergic/dopaminergic receptors and have residual stimulatory effects; interfere with sleep. None is marketed in India (PPA is included only in decongestant formulations).

Fenfluramine and *dexfenfluramine* reduce food seeking behaviour by enhancing serotonergic transmission in the hypothalamus. However, tolerance to the anorectic action develops in 2–3 months. They have tranquillising rather than stimulant property, and were extensively used by slimming centres.

In the late 1990s ecocardiographic abnormalities, valvular defects, pulmonary hypertension and sudden deaths were related to the use of a combined preparation of fenfluramine + phentermine. Similar valvular lesions are known to occur in carcinoid. The US-FDA recommended discontinuation of fenfluramine, dexfenfluramine and their combinations. These are now banned in India and most other countries.

Sibutramine This recently introduced anti-obesity drug inhibits the reuptake of both NA as well as 5-HT, but does not have clinically useful antidepressant property. It suppresses appetite in a manner similar to fenfluramine and appears to stimulate thermogenesis by indirectly activating β_3 system in adipose tissue. It can cause loss of 3–9 kg weight, but many subjects regain the same when therapy is discontinued. Side effects include dry mouth, constipation, anxiety, insomnia, mood swings, chest pain and a mild increase in BP and HR. A number of serious adverse reaction reports including cardiovascular events and deaths have been received by the US-FDA and drug committees in Europe. An ongoing study is assessing its impact on long-term morbidity and mortality.

Dose: Start with 10 mg OD, increase to 15 mg OD if tolerated. **OBESTAT, SIBUTREX 5 mg, 10 mg caps.**

THERAPEUTIC USES

1. Vascular Uses

(i) **Hypotensive states** (shock, spinal anaesthesia, hypotensive drugs) One of the pressor agents can be used along with volume replacement for neurogenic and haemorrhagic shock; also as an expedient measure to maintain cerebral circulation for other varieties of shock. They should not be used in secondary shock when reflex vasoconstriction is already marked. Use in cardiogenic shock is tricky, because attempts to raise BP may also increase cardiac work. Slow i.v. infusion of dopamine/dobutamine is more appropriate in this situation; use of NA is practically obsolete. Adr 0.5 mg injected promptly i.m. is the drug of choice in anaphylactic shock (*see p. 82*). It not only raises BP, but counteracts bronchospasm/laryngeal edema that may accompany. Because of the rapidity and profile of action Adr is the only life saving measure. Oral ephedrine has been used to treat postural hypotension due to autonomic neuropathy (diabetes, parkinsonism, idiopathic) or advanced age. However, it is not satisfactory because it cannot mimic selective NA release that occurs only on standing. Elastic stockings and use of fludrocortisone to expand plasma volume are more helpful.

(ii) **Along with local anaesthetics** Adr 1 in 200,000 to 1 in 100,000 for infiltration, nerve block and spinal anaesthesia. Duration of anaesthesia is prolonged and systemic toxicity of local anaesthetic is reduced. Local bleeding is minimised.

(iii) **Control of local bleeding** From skin and mucous membranes, e.g. epistaxis: compresses of Adr 1 in 10,000, phenylephrine/ephedrine 1% soaked in cotton can control arteriolar and capillary bleeding. NA 8 mg in 100–200 ml saline put in stomach through a tube can control bleeding from gastric erosions and stress ulcers.

(iv) **Nasal decongestant** In colds, rhinitis, sinusitis, blocked nose or eustachian tube—one of the α -agonists is used as nasal drops. Shrinkage of

mucosa provides relief, but after-congestion, atrophy of mucosa on prolonged use are still a problem. The imidazolines should be used in lower concentrations in infants and young children, because they are more sensitive to central effects of these drugs. Nasal decongestants should be used very cautiously in hypertensive patients and in elderly males.

Pseudoephedrine, PPA, and phenylephrine have been used orally as decongestants, but effective doses will constrict other blood vessels as well and cause rise in BP. However, they do not produce after-congestion.

(v) *Peripheral vascular diseases* like Buerger's disease, Raynaud's phenomena, diabetic vascular insufficiency, gangrene, frost bite, ischaemic ulcers, night leg cramps, cerebral vascular inadequacy : vasodilators including isoxsuprine have been used, but are far from satisfactory in most cases, because often the capacity of the affected vessels to dilate is severely limited, and ischaemia itself is a potent vasodilator.

2. Cardiac uses

(i) *Cardiac arrest* (drowning, electrocution, Stokes-Adams syndrome and other causes) Adr may be used to stimulate the heart; i.v. administration is justified in this setting with external cardiac massage.

(ii) *Partial or complete A-V block* Isoprenaline may be used as temporary measure to maintain sufficient ventricular rate.

(iii) *Congestive heart failure (CHF)* Adrenergic inotropic drugs are not useful in the routine treatment of CHF. However, controlled short term i.v. infusion of DA/dobutamine can tide over acute cardiac decompensation during myocardial infarction, cardiac surgery and in resistant CHF.

3. Bronchial asthma Adrenergic drugs, especially β_2 stimulants are the primary drugs for relief of reversible airway obstruction (*see* Ch. 16).

4. Allergic disorders Adr is a physiological antagonist of histamine which is an important mediator of many acute hypersensitivity reactions. It affords quick relief in urticaria, angio-

edema; is life saving in laryngeal edema and anaphylaxis. It is ineffective in delayed, retarded and other types of allergies, because histamine is not involved.

5. Mydriatic Phenylephrine is used to facilitate fundus examination; cycloplegia is not required. It tends to reduce intraocular tension in wide angle glaucoma. The ester prodrug of Adr dipivefrine is a second choice/adjuvant drug for open angle glaucoma (*see* p. 146).

6. Central uses

(i) *Hyperkinetic children* (minimal brain dysfunction, attention deficit hyperkinetic disorder): Amphetamines have an apparently paradoxical effect to calm down hyperkinetic children. This disorder is recognized as the mildest grade of mental retardation or a reduction in the ability to concentrate, i.e. the span of time for which attention can be focused on a subject is abbreviated. Amphetamines by increasing attention span improve behaviour and performance in studies; tolerance to this effect does not develop. However, growth retardation may occur due to reduction in appetite. The risk-benefit ratio of such therapy needs to be considered in individual patients.

(ii) *Narcolepsy* Narcolepsy is sleep occurring in fits and is adequately controlled by amphetamines. Development of tolerance, abuse and behavioural abnormalities are the calculated risks of such therapy. Imipramine like drugs are generally tried first.

(iii) *Epilepsy* Amphetamines are occasionally used as adjuvants and to counteract sedation caused by antiepileptics.

(iv) *Parkinsonism* Amphetamines improve mood and reduce rigidity (slightly) but do not benefit tremor. They are occasionally used as adjuvants in parkinsonism.

(v) *Obesity* The anorectic drugs can help the obese to tolerate a reducing diet for short periods, but do not improve the long-term outlook. Their use (for 2–3 months) may be considered in severe obesity, but not for cosmetic reasons in mild to moderate obesity. In the absence of dietary restriction none of them has any significant weight

reducing effect, and lifestyle modification is required to maintain weight loss. Tolerance develops to the anorectic action of all available drugs. Most subjects tend to regain weight after the slimming regimen is over. Currently, sibutramine is being used, though its long-term safety is not established.

The newer approaches being developed for control of obesity are:

Orlistat An inhibitor of gastric and pancreatic lipase; it interferes with digestion and absorption of dietary triglycerides. Absorption of cholesterol and fat soluble vitamins is also impaired. It has facilitated weight loss in clinical trials. Fluid motions, steatorrhoea, abdominal pain, nausea, flatulence and vitamin deficiency are the side effects.

Olestra is a sucrose polyester which can be used as a cooking medium in place of fat but is neither digested nor absorbed. Its acceptability is inconsistent.

Leptin (the endogenous slimming peptide) *analogues*, *neuropeptide Y antagonists* and β_3 *adrenergic agonists* are under investigation as antiobesity drugs.

Rimonabant A selective cannabinoid (CB-1) receptor antagonist that blocks hunger promoting action of cannabis has been found in clinical trials to decrease appetite and help weight reduction by the obese. Nausea is a side effect. Rimonabant has also been tried to help smoking cessation.

7. Nocturnal enuresis in children and urinary incontinence Amphetamine affords benefit both by its central action as well as by increasing tone of vesical sphincter.

8. Uterine relaxant Isoxsuprine has been used in threatened abortion and dysmenorrhoea, but efficacy is doubtful. Selective β_2 stimulants, specially ritodrine, infused i.v. have been successfully used to postpone labour but maternal morbidity and mortality may be increased due to their cardiac and metabolic actions and incidents of pulmonary edema (*see* Ch. 23).

9. Insulin hypoglycaemia Adr may be used as an expedient measure, but glucose should be given as soon as possible.



These are drugs which antagonize the receptor action of adrenaline and related drugs. They are competitive antagonists at α or β or both α and β adrenergic receptors and differ in important ways from the “adrenergic neurone blocking agents”, which act by interfering with the release of adrenergic transmitter on nerve stimulation. These differences are given in Table 10.1.

α ADRENERGIC BLOCKING DRUGS

These drugs inhibit adrenergic responses mediated through the α adrenergic receptors without affecting those mediated through β receptors.

CLASSIFICATION

I. Nonequilibrium type

- (i) β -Haloalkylamines—Phenoxybenzamine.

II. Equilibrium type (competitive)

A. Nonselective

- (i) *Ergot alkaloids*—Ergotamine, Ergotoxine
- (ii) *Hydrogenated ergot alkaloids*—Dihydroergotamine (DHE), Dihydroergotoxine
- (iii) *Imidazolines*—Tolazoline, Phentolamine
- (iv) *Miscellaneous*—Chlorpromazine

B. α_1 selective—Prazosin, Terazosin, Doxazosin, Tamsulosin

C. α_2 selective—Yohimbine

GENERAL EFFECTS OF α BLOCKERS

1. Blockade of vasoconstrictor α_1 (also α_2) receptors reduces peripheral resistance and causes pooling of blood in capacitance vessels \rightarrow venous return and cardiac output are reduced \rightarrow fall in BP. Postural reflex is interfered with \rightarrow marked hypotension occurs on standing \rightarrow dizziness and syncope. Hypovolemia accentuates the hypotension. The α blockers abolish the pressor action of Adr, which then produces only fall in BP due to β_2 mediated vasodilatation—*vasomotor reversal of Dale*. Pressor and other actions of selective α agonists (NA, phenylephrine) are suppressed.
2. Reflex tachycardia occurs due to fall in mean arterial pressure and increased release of NA due to blockade of presynaptic α_2 receptors.
3. Nasal stuffiness and miosis result from blockade of α receptors in nasal blood vessels and in radial muscles of iris respectively.
4. Intestinal motility is increased due to partial inhibition of relaxant sympathetic influences—diarrhoea may occur.
5. Hypotension produced by α blockers can reduce renal blood flow \rightarrow g.f.r. is reduced and more complete reabsorption of Na^+ and water occurs in the tubules \rightarrow Na^+ retention and increase in blood volume. This is accentuated by

Table 10.1: Differences between antiadrenergic and adrenergic neurone blocking drugs

	<i>Antiadrenergic drugs</i>	<i>Adrenergic neurone blocking drugs</i>
1. Locus of action	Adrenergic receptors on effector cells or neurones	Adrenergic neuronal membrane or contents
2. Effects of adrenergic nerve stimulation	Blocked (less completely)	Blocked (more completely)
3. Effect of injected Adr	Blocked	Not blocked (may be potentiated)
4. Type of effects blocked by a single drug	Either α or β (except Labetalol and its congeners)	Sympathetic function decreased irrespective of the receptor type
5. Examples	α —Phentolamine β —Propranolol	Reserpine, Guanethidine, Bretylium, α -methyl-p-tyrosine

reflex increase in renin release mediated through β_1 receptors.

6. Tone of smooth muscle in bladder trigone, sphincter and prostate is reduced by blockade of α_1 receptors (mostly of the α_{1A} subtype) \rightarrow urine flow in patients with benign hypertrophy of prostate (BHP) is improved.

7. Contractions of vas deferens and related organs which result in ejaculation are coordinated through α receptors— α blockers can inhibit ejaculation; this may manifest as impotence.

The α blockers have no effect on adrenergically induced cardiac stimulation, bronchodilatation, vasodilatation and most of the metabolic changes, because these are mediated predominantly through β receptors.

Apart from these common effects, most of which manifest as side effects, many α blockers have some additional actions. Their pharmacological profile is also governed by their central effects and by the relative activity on α_1 and α_2 receptor subtypes. Only the distinctive features of different α blockers are described below.

Phenoxybenzamine It cyclizes spontaneously in the body giving rise to a highly reactive ethyleniminium intermediate which reacts with α adrenoceptors and other biomolecules by forming strong covalent bonds. The α blockade develops gradually (even after i.v. injection) and lasts for 3–4 days.

In isolated preparations of vascular smooth muscle, low concentrations cause DRC of NA to shift to right without suppression of maxima

(till spare receptors are available); higher concentrations progressively flatten the DRC and nonequilibrium antagonism is manifested. Increased release of NA from sympathetic nerves (due to α_2 blockade) occurs and reflex tachycardia is prominent in intact animals. Partial blockade of 5-HT, histaminergic and cholinergic receptors, but not β adrenergic receptors, can be demonstrated at higher doses.

The fall in BP caused by phenoxybenzamine is mainly postural because venodilatation is more prominent than arteriolar dilatation. In recumbent subjects cardiac output and blood flow to many organs are increased due to reduction in peripheral resistance and increased venous return. It tends to shift blood from pulmonary to systemic circuit because of differential action on the two vascular beds. It also tends to shift fluid from extravascular to vascular compartment. Phenoxybenzamine is lipid soluble, penetrates brain and can produce CNS stimulation, nausea and vomiting on rapid i.v. injection. However, oral doses produce depression, tiredness and lethargy. Major side effects are postural hypotension, palpitation, nasal blockage, miosis, inhibition of ejaculation.

Pharmacokinetics Oral absorption of phenoxybenzamine is erratic and incomplete; i.m. and s.c. injections are very painful—should not be given. Though most of the administered dose is excreted in urine in 24 hours, small amounts that have covalently reacted remain in tissues for long

periods. Chronic administration leads to accumulation in adipose tissue.

Dose: 20–60 mg/day oral; 1 mg/kg by slow i.v. infusion over 1 hour; used primarily in pheochromocytoma, occasionally in secondary shock and peripheral vascular disease.

FENOXENE 10 mg cap, 50 mg/ml inj.

Natural and hydrogenated ergot alkaloids (see Ch. 12 and Ch. 21) Ergot alkaloids are the adrenergic antagonists with which Dale demonstrated the vasomotor reversal phenomenon. The amino acid alkaloids *ergotamine* and *ergotamine* are partial agonists and antagonists at α adrenergic, serotonergic and dopaminergic receptors. The amine alkaloid *ergometrine* has no α blocking activity.

The natural ergot alkaloids produce long lasting vasoconstriction which predominates over their α blocking action—peripheral vascular insufficiency and gangrene of toes and fingers occurs in ergotism. Ergotamine is a more potent α blocker and less potent vasoconstrictor than ergotamine. Hydrogenation reduces vasoconstrictor and increases α blocking activity.

The α blockade produced by clinical doses of ergot alkaloids is low grade and short lasting; they are not employed for this purpose. The principal use is in migraine (see Ch. 12). Diagnostic use of ergotamine has been made to precipitate ECG signs of ischaemia in coronary artery disease. Dihydroergotamine has been used as a cognition enhancer.

Tolazoline It is an imidazoline compound with complex pharmacological properties. The α blocking action is only modest and short lasting. In addition, it is a direct vasodilator and stimulates the heart.

Tolazoline also blocks 5-HT receptors, has a histamine like gastric secretagogue and ACh like motor action on intestines. It was used in peripheral vascular diseases and pulmonary hypertension of the newborn.

Phentolamine This congener of tolazoline is a rapidly acting α blocker with short duration of action (in minutes). It equally blocks α_1 and α_2 receptors—NA release is increased and venodilatation predominates over arteriolar dilatation. It is used as a quick and short acting α blocker for diagnosis and intraoperative management of pheochromocytoma and for control of hypertension due to clonidine withdrawal, cheese reaction, etc. It is the most suitable α blocker for local infiltration to counteract vasoconstriction due to extravasated NA/DA during their i.v. infusion.

Dose: 5 mg i.v. repeated as required;

REGITINE, FENTANOR 10 mg/ml inj.

Prazosin It is first of the highly selective α_1 blockers having $\alpha_1 : \alpha_2$ selectivity ratio 1000:1. All subtypes of α_1 receptor (α_{1A} , α_{1B} , α_{1D}) are blocked equally. It blocks sympathetically mediated vasoconstriction and produces fall in BP which is attended by only mild tachycardia; NA release is not increased due to absence of α_2 blockade.

Prazosin dilates arterioles more than veins. Postural hypotension is less marked, occurs especially in the beginning, which may cause dizziness and fainting as 'first dose effect'. This can be minimized by starting with a low dose and taking it at bedtime. Subsequently tolerance develops to this side effect. Other α blocking side effects are also milder. It also inhibits phosphodiesterase which degrades cAMP. Rise in smooth muscle cAMP could contribute to its vasodilator action.

Prazosin is effective orally (bioavailability ~60%), highly bound to plasma proteins (mainly to α_1 acid glycoprotein), metabolized in liver and excreted primarily in bile. Its plasma $t_{1/2}$ is 2–3 hours; effect of a single dose lasts for 6–8 hours.

Prazosin is primarily used as an antihypertensive (see Ch. 40). Other uses are—Raynaud's disease and prostatic hypertrophy—blocks α_1 receptors in bladder trigone and prostate and thus improves urine flow, reduces residual urine in bladder.

PRAZOPRES 0.5, 1.0 and 2.0 mg tabs. Start with 0.5–1 mg at bedtime; usual dose 1–4 mg BD or TDS.

MINIPRESS XL: Prazosin GITS (gastrointestinal therapeutic system) 2.5 mg and 5 mg tablets; 1 tab OD.

Terazosin It is chemically and pharmacologically similar to prazosin; differences are higher bioavailability (90%) and longer plasma $t_{1/2}$ (~12 hr); a single daily dose lowers BP over 24 hrs. Terazosin is more popular for use in BHP due to single daily dose and a probable apoptosis promoting effect on prostate.

HYTRIN, TERALFA, OLYSTER 1, 2, 5 mg tab; usual maintenance dose 2–10 mg OD.

Doxazosin Another long acting ($t_{1/2}$ 18 hr) congener of prazosin with similar pharmacological profile, used in hypertension and BHP.

Dose: 1 mg OD initially, increase upto 8 mg BD;

DOXACARD, DURACARD, DOXAPRESS 1, 2, 4 mg tabs.

Tamsulosin This uroselective α_{1A}/α_{1D} blocker ($\alpha_{1A} : \alpha_{1B}$ affinity 7–38 fold) has been found as effective as terazosin in improving BHP symptoms. Because α_{1A} subtype predominate in the bladder base and prostate, while α_{1B} receptors are dominant in blood vessels, tamsulosin does not cause significant changes in BP or HR at doses which relieve urinary symptoms. No increase in adverse cardiovascular events, including postural hypotension has been noted. Dizziness and retrograde ejaculation are the only significant side effects. Its plasma $t_{1/2}$ is 6–9 hrs, but the modified release (MR) cap needs only once daily dosing. It appears to be a better tolerated α_1 blocker for BHP. CONTIFLO-OD 0.4 mg Cap, URIMAX, DYNAPRES 0.2, 0.4 mg MR cap; 1 cap (max 2) in the morning with meals. No dose titration is needed in most patients.

Trimazosin is a less potent congener of prazosin. *Alfuzosin* is a α_1 blocker used primarily in BHP, but is subtype nonselective.

Indoramine and *Urapidil* are α_1 blockers chemically distinct from prazosin; are being used as antihypertensive in some countries.

Yohimbine An alkaloid from West African plant *Yohimbehe*. It is a relatively selective α_2 blocker with short duration of action. Also blocks 5-HT receptors. Heart rate and BP are generally elevated due to increased central sympathetic outflow as well as peripheral NA release. Other CNS effects include excitation, tremor, ADH release (antidiuresis), nausea and vomiting. It may cause congestion of genitals and has been claimed to be an aphrodisiac. This effect is only psychological, but can overcome psychogenic impotence in some patients. There are no valid indications for clinical use of yohimbine.

Chlorpromazine and some other neuroleptics have additional α adrenergic blocking activity—cause fall in BP, nasal stuffiness and inhibition of ejaculation as side effect.

USES OF α BLOCKERS

1. **Pheochromocytoma** It is a tumour of adrenal medullary cells. Excess CAs are secreted which can cause intermittent or persistent hypertension. Estimation of urinary CA metabolites (VMA, normetanephrine) is diagnostic. In addition, pharmacological tests can be performed.

Phentolamine test Inject phentolamine 5 mg i.v. over 1 min in recumbent subject. A fall in BP > 35 mm Hg systolic and/or > 25 mm Hg diastolic is indicative of pheochromocytoma. However, it is not very reliable and both false positive and false negative results are obtained.

Provocative tests have been performed by injecting histamine, methacholine or glucagon—which provoke release of CAs and cause marked rise in BP if pheochromocytoma is present. These tests are dangerous; phentolamine must be available to counteract excessive rise in BP.

Therapeutic Phenoxybenzamine can be used as definitive therapy for inoperable and malignant tumours. When surgical removal of the tumour is contemplated, it is desirable to give phenoxybenzamine orally for 1–2 weeks preoperatively and infuse it i.v. during surgery because:

- (i) Due to excess circulating CAs blood volume is low (they shift fluid from vascular to extravascular compartment). Treatment with α blocker normalizes blood volume and distribution of body water.
- (ii) Handling of the tumour during surgery may cause outpouring of CAs in blood → marked rise in BP. This is prevented by phenoxybenzamine given pre and intraoperatively. Alternatively, phentolamine drip can be instituted during the operation.
- (iii) Removal of the tumour is often attended by marked fall in BP as blood vessels dilate and the blood volume is low. This does not happen if volume has been restored before hand with the aid of an α blocker.

2. **Hypertension** α blockers other than those selective for α_1 like prazosin have been a failure in the management of essential hypertension, because vasodilatation is compensated by cardiac stimulation. Moreover, postural hypotension, impotence, nasal blockage and other side effects produced by nonselective α blockers are unacceptable. However, phentolamine/phenoxybenzamine are of great value in controlling episodes of rise in BP during clonidine withdrawal and cheese reaction in patients on MAO inhibitors.

3. **Benign hypertrophy of prostate (BHP)** The urinary obstruction caused by BHP has a static component due to increased size of prostate and a dynamic component due to increased tone of bladder neck/prostate smooth muscle. Two classes of drugs are available:

- α_1 adrenergic blockers (prazosin like): decrease tone of prostatic/bladder neck muscles.
- 5- α reductase inhibitor (finasteride): arrest growth/reduce size of prostate (*see* Ch. 21).

Since activation of α_1 adrenoceptors in bladder trigone, prostate and prostatic urethra increases smooth muscle tone, their blockade relaxes these structures, reducing dynamic obstruction, increasing urinary flow rate and causing more complete emptying of bladder in many patients of BHP.

Voiding symptoms (hesitancy, narrowing of stream, dribbling and increased residual urine) are relieved better than irritative symptoms like urgency, frequency and nocturia. The α_1 blockers afford faster (within 2 weeks) and greater symptomatic relief than finasteride which primarily affects static component of obstruction and has a delayed onset taking nearly six months for clinical improvement. The α_1 blockers do not affect prostate size, but are more commonly used. However, effects last only till the drug is given. Even with continued therapy, benefit may decline after several years due to disease progression. They may be used concurrently with finasteride.

Terazosin, doxazosin and tamsulosin are the preferred α_1 blockers because of once daily dosing. There is some evidence that terazosin and doxazosin promote apoptosis in prostate. Tamsulosin appears to cause fewer vascular side effects because of relative α_{1A}/α_{1D} selectivity.

4. **Secondary shock** Shock due to blood or fluid loss is accompanied by reflex vasoconstriction. If volume replacement fails to reverse this (extremities remain pale and cold, pulse pressure does not improve), therapy with an α blocker (phenoxybenzamine i.v.) can help by:

- (i) Counteracting vasoconstriction.
- (ii) Shifting blood from pulmonary to systemic circuit.
- (iii) Returning fluid from extravascular to the vascular compartment so that cardiac output improves.

5. **Peripheral vascular diseases** α blockers do increase skin and to some extent muscle blood flow in normal individuals, but these drugs are largely disappointing in peripheral vascular diseases when obstruction is organic (Buerger's disease). However, when vasoconstriction is a prominent feature (Raynaud's phenomenon, acrocyanosis), good symptomatic relief is afforded by prazosin or phenoxybenzamine.

6. **Congestive heart failure (CHF)** The vasodilator action of prazosin can afford symptomatic relief in CHF in the short-term, but long-term prognosis is not improved.

7. **Papaverine/Phentolamine Induced Penile Erection (PIPE) therapy for impotence** In patients unable to achieve erection, injection of papaverine (3–20 mg) with or without phentolamine (0.5–1 mg) in the corpus cavernosum has been found to produce penile tumescence to permit intercourse. However, the procedure requires skill and training. Priapism occurs in 2–15% cases, which if not promptly treated leads to permanent damage. This is reversed by aspirating blood from the corpus cavernosum or by injecting phenylephrine locally. Repeated injections can cause penile fibrosis. Other complications are—local haematoma, infection, paresthesia and penile deviation. This therapy should therefore be reserved for selected situations with proper facilities.

β ADRENERGIC BLOCKING DRUGS

These drugs inhibit adrenergic responses mediated through the β receptors.

The dichloro derivative of isoprenaline was the first compound found in 1958 to block adrenergic responses which could not be blocked till then by the available adrenergic antagonists. However, it was not suitable for clinical use. *Propranolol* introduced in 1963 was a therapeutic breakthrough. Since then, drugs in this class have proliferated and diversified.

All β blockers are competitive antagonists. Propranolol blocks β_1 and β_2 receptors but has weak activity on β_3 subtype. It is also an inverse agonist: reduces resting heart rate as well.

CLASSIFICATION

Nonselective (β_1 and β_2)

- a. *Without intrinsic sympathomimetic activity*
Propranolol, Sotalol, Timolol.
- b. *With intrinsic sympathomimetic activity*
Pindolol
- c. *With additional α blocking property*
Labetalol, Carvedilol

Cardioselective (β_1)

Metoprolol, Atenolol, Acebutolol, Bisoprolol, Esmolol, Betaxolol, Celiprolol, Nebivolol

Another system of classifying β blockers into 3 generations has been proposed.

First generation (older, nonselective)	Second generation (β_1 selective)	Third generation (with additional α blocking and/or vasodilator property)
Propranolol	Metoprolol	Labetalol
Timolol	Atenolol	Carvedilol
Sotalol	Acebutolol	Celiprolol
Pindolol	Bisoprolol	Nebivolol
	Esmolol	

The pharmacology of propranolol is described as prototype.



PHARMACOLOGICAL ACTIONS

1. CVS

(a) Heart Propranolol decreases heart rate, force of contraction (at relatively higher doses) and cardiac output (c.o.). It prolongs systole by retarding conduction so that synergy of contraction of ventricular fibres is disturbed. The effects on a normal resting subject are mild, but become prominent under sympathetic overactivity (exercise, emotion). Ventricular dimensions are decreased in normal subjects, but dilatation can occur in those with reduced reserve—CHF may be precipitated or aggravated.

Cardiac work and oxygen consumption are reduced as the product of heart rate and aortic pressure decreases. Total coronary flow is reduced (blockade of dilator β receptors), but this is largely restricted to the subepicardial region, while the subendocardial area (which is the site of ischaemia in angina patients) is not affected. Overall effect in angina patients is improvement of O_2 supply/demand status; exercise tolerance is increased.

Propranolol abbreviates refractory period of myocardial fibres and decreases automaticity—

rate of diastolic depolarization in ectopic foci is reduced, specially if it had been augmented by adrenergic stimuli. The A-V conduction is delayed. At high doses a direct depressant and membrane stabilizing (quinidine like) action is exerted, but this contributes little to the antiarrhythmic effect at usual doses. Propranolol blocks cardiac stimulant action of adrenergic drugs but not that of digoxin, Ca^{2+} , methylxanthines or glucagon.

(b) Blood vessels Propranolol blocks vasodilatation and fall in BP evoked by isoprenaline and enhances the rise in BP caused by Adr—there is re-reversal of vasomotor reversal that is seen after α blockade. It has no direct effect on blood vessels and there is little acute change in BP. On prolonged administration BP gradually falls in hypertensive subjects but not in normotensive. Total peripheral resistance (t.p.r.) is increased initially (due to blockade of β mediated vasodilatation) and c.o. is reduced—little change in BP. With continued treatment, resistance vessels gradually adapt to chronically reduced c.o. so that t.p.r. decreases—both systolic and diastolic BP fall. This is considered to be the most likely explanation of the antihypertensive action. Other mechanisms that may contribute are:

(i) Reduced NA release from sympathetic terminals due to blockade of β receptor mediated facilitation of the release process.

(ii) Decreased renin release from kidney (β_1 mediated): Propranolol causes a more marked fall in BP in hypertensives who have high or normal plasma renin levels and such patients respond at

relatively lower doses than those with low plasma renin. However, pindolol does not decrease plasma renin activity but is an effective antihypertensive. (iii) Central action reducing sympathetic outflow. However, β blockers which penetrate brain poorly are also effective antihypertensives.

2. Respiratory tract Propranolol increases bronchial resistance by blocking β_2 receptors. The effect is hardly discernible in normal individuals because sympathetic bronchodilator tone is minimal. In asthmatics, however, the condition is consistently worsened and a severe attack may be precipitated.

3. CNS No overt central effects are produced by propranolol. However, subtle behavioural changes, forgetfulness, increased dreaming and nightmares have been reported with long-term use of relatively high doses.

Propranolol suppresses anxiety in short term stressful situations, but this is due to peripheral rather than a specific central action.

4. Local anaesthetic Propranolol is as potent a local anaesthetic as lidocaine, but is not clinically used for this purpose because of its irritant property.

5. Metabolic Propranolol blocks adrenergically induced lipolysis and consequent increase in plasma free fatty acid levels. Plasma triglyceride level and LDL/HDL ratio is increased during propranolol therapy. It also inhibits glycogenolysis in heart, skeletal muscles and in liver (inconsistently), which occurs due to Adr release during hypoglycaemia—recovery from insulin action is delayed. Though there is no effect on normal blood sugar level, prolonged propranolol therapy may reduce carbohydrate tolerance by decreasing insulin release.

6. Skeletal muscle Propranolol inhibits adrenergically provoked tremor. This is a peripheral action exerted directly on the muscle fibres (through β_2 receptors). It tends to reduce exercise capacity by attenuating β_2 mediated

increase in blood flow to the exercising muscles, as well as by limiting glycogenolysis and lipolysis which provide fuel to working muscles.

7. Eye Instillation of propranolol and some other β blockers reduces secretion of aqueous humor, i.o.t. is lowered. There is no consistent effect on pupil size or accommodation.

8. Uterus Relaxation of uterus in response to isoprenaline and selective β_2 agonists is blocked by propranolol. However, normal uterine activity is not significantly affected.

PHARMACOKINETICS

Propranolol is well absorbed after oral administration, but has low bioavailability due to high first pass metabolism in liver. Oral: parenteral dose ratio of up to 40:1 has been found. Interindividual variation in the extent of first pass metabolism is marked—equieffective oral doses vary considerably. It is lipophilic and penetrates into brain easily.

Metabolism of propranolol is dependent on hepatic blood flow. Chronic use of propranolol itself decreases hepatic blood flow—oral bioavailability of propranolol is increased and its $t_{1/2}$ is prolonged (by about 30%) on repeated administration. Bioavailability of propranolol is more when it is taken with meals because food decreases its first pass metabolism. Higher bioavailability and prolongation of $t_{1/2}$ also occur with high doses because metabolism of propranolol is saturable.

A number of metabolites of propranolol have been found, of which the hydroxylated product has β blocking activity. The metabolites are excreted in urine, mostly as glucuronides. More than 90% of propranolol is bound to plasma proteins.

Dose: Oral—10 mg BD to 160 mg QID (average 40–160 mg/day). Start with a low dose and gradually increase according to need; i.v.—2 to 5 mg injected over 10 min with constant monitoring. It is not injected s.c. or i.m. because of irritant property.

INDERAL, CIPLAR 10, 40, 80 mg tab, 1 mg/ml inj., BETABLOC 10, 40 mg tab.

INTERACTIONS

1. Additive depression of sinus node and A-V conduction with digitalis and verapamil — cardiac arrest can occur. However, propranolol has been safely used with nifedipine.
2. Propranolol delays recovery from hypoglycaemia due to insulin and oral antidiabetics. Warning signs of hypoglycaemia mediated through sympathetic stimulation (tachycardia, tremor) are suppressed. In some cases BP rises due to unopposed α action of released Adr.
3. Phenylephrine, ephedrine and other α agonists present in cold remedies can cause marked rise in BP due to blockade of sympathetic vasodilatation.
4. Indomethacin and other NSAIDs attenuate the antihypertensive action of β blockers.
5. Cimetidine inhibits propranolol metabolism. However, the dose range of propranolol is wide, and this may not be clinically significant.
6. Propranolol retards lidocaine metabolism by reducing hepatic blood flow.
7. Propranolol increases bioavailability of chlorpromazine by decreasing its first pass metabolism.

ADVERSE EFFECTS AND CONTRAINDICATIONS

1. Propranolol can accentuate myocardial insufficiency and can precipitate CHF/edema by blocking sympathetic support to the heart, especially during cardiovascular stress. However, when compensation has been restored, careful addition of a β_1 blocker is now established therapy to prolong survival.
2. Bradycardia: resting HR may be reduced to 60/min or less. Patients of sick sinus are more prone to severe bradycardia.
3. Propranolol worsens chronic obstructive lung disease, can precipitate life-threatening attack of bronchial asthma: contraindicated in asthmatics.
4. Propranolol exacerbates variant (Prinzmetal's) angina due to unopposed α mediated coronary constriction. In some patients, even classical

angina may be worsened if ventricular dilatation and asynergy of contraction occurs—specially with high doses.

5. Carbohydrate tolerance may be impaired in prediabetics.
6. Plasma lipid profile is altered on long term use: total triglycerides and LDL-cholesterol tend to increase while HDL-cholesterol falls. This may enhance risk of coronary artery disease. Cardioselective β blockers and those with intrinsic sympathomimetic activity have little/no deleterious effect on blood lipids.
7. Withdrawal of propranolol after chronic use should be gradual, otherwise rebound hypertension, worsening of angina and even sudden death can occur. This is due to supersensitivity of β receptors occurring as a result of long-term reduction in agonist stimulation.
8. Propranolol is contraindicated in partial and complete heart block: arrest may occur.
9. Tiredness and reduced exercise capacity: due to blunting of β_2 mediated increase in blood flow to the exercising muscles as well as attenuation of glycogenolysis and lipolysis.
10. Cold hands and feet, worsening of peripheral vascular disease are noticed due to blockade of vasodilator β_2 receptors.
11. Side effects not overtly due to β blockade are—g.i.t. upset, lack of drive, nightmares, forgetfulness, rarely hallucinations. Male patients more frequently complain of sexual distress.

OTHER β BLOCKERS

A number of β blockers have been developed having some special features. Their comparative properties are presented in Table 10.2. The associated properties with their significance can be summarized as:

Cardioselectivity (in metoprolol, atenolol, acebutolol, bisoprolol, nebivolol).

These drugs are more potent in blocking cardiac (β_1) than bronchial (β_2) receptors. However, selectivity is only relative and is lost at high doses. Their features are:

Table 10.2: Comparative properties of β blockers

β -BLOCKER	Potency (on β_1)	Partial agonistic action	Membrane stabilizing action	Lipid solubility	Daily dose (mg)	Oral bioavailability (%)	First pass metabolism	Major route of elimination	Plasma $t_{1/2}$ (hours)
NONSELECTIVE									
1. Propranolol	1	-	++	++	40–480	~30	Yes	Hep.*	3–5
2. Sotalol	1/3	-	-	\pm	160–480	~60	No	Ren. [†] +Hep.	6–12
3. Timolol	6	-	\pm	+	10–40	50–75	Partial	Ren.+Hep.	4–5
4. Pindolol	6	++	\pm	+	10–30	80–90	No	Ren.+Hep.	3–4
CARDIOSELECTIVE									
1. Metoprolol	1	-	\pm	+	100–400	40–50	Yes	Hep.	3–4
2. Atenolol	1	-	-	-	25–100	50–60	No	Ren.	6–9
3. Acebutolol	1/3	+	+	\pm	400–1200	40–60	Yes	Hep.+Ren.	3–4
4. Bisoprolol	6	-	-	-	2.5–10	80	No	Hep.+Ren.	9–12
α+β BLOCKER									
1. Labetalol	1/3	\pm	+	\pm	300–600	~20	Yes	Hep.	4–6

*Hep—Hepatic metabolism; †Ren.—Renal excretion

1. Lower propensity to cause bronchoconstriction, but even these drugs should be avoided, if possible, in asthmatics.

2. Less interference with carbohydrate metabolism and less inhibition of glycogenolysis during hypoglycaemia—safer in diabetics.

However, tachycardia in response to hypoglycaemia is blocked.

3. Lower incidence of cold hands and feet, less chances of precipitating Raynaud's phenomenon.

4. No/less deleterious effect on blood lipid profile.

5. Ineffective in suppressing essential tremor (it occurs through β_2 action on muscle fibres).

6. Less liable to impair exercise capacity.

Partial agonistic (intrinsic sympathomimetic) action (in pindolol, acebutolol). These drugs themselves activate β_1 and/or β_2 receptors submaximally. The benefits of this property are controversial.

1. Bradycardia and depression of contractility at rest are not prominent, but exercise tachycardia is blocked; may be preferred in those prone to severe bradycardia (elderly patients; sick sinus) or with low cardiac reserve.

2. Withdrawal is less likely to exacerbate hypertension or angina; continued agonistic action on

β receptors (of the drug itself) prevents development of supersensitivity.

3. Plasma lipid profile is not/less worsened.

4. Not effective in migraine prophylaxis—they dilate cerebral vessels.

5. Not suitable for secondary prophylaxis of MI.

Membrane stabilizing activity (in propranolol, oxprenolol, acebutolol). This activity is claimed to contribute to the antiarrhythmic action, but appears to be significant only at high doses.

Lipid insolubility (atenolol, sotalol)

1. They are less likely to produce central effects.

2. They are incompletely absorbed orally, but do not undergo first pass metabolism and are primarily excreted unchanged in urine: are longer acting ($t_{1/2}$ 6–20 hours) and tend to be effective in a narrow dose range. In contrast, the lipid soluble agents are primarily metabolized in liver and have shorter $t_{1/2}$ (2–6 hours).

Salient features of important β blockers are given below.

1. Sotalol Nonselective β blocker with lower lipid solubility. It has additional K^+ channel blocking and class III antiarrhythmic property. **SOTAGARD 40, 80 mg tab.**

2. Timolol It is the β blocker preferred for topical use in eye (*see* p. 144).

Orally it is a potent β blocker—has been used in hypertension, angina and prophylaxis of myocardial infarction.

Betaxolol, Levobunolol, Carteolol and Metipranolol are β blockers employed exclusively for topical application to the eye (see p. 145).

3. Pindolol A potent β blocker with prominent intrinsic sympathomimetic activity. It has been used primarily as antihypertensive: may be advantageous in patients who develop marked bradycardia with propranolol. Chances of rebound hypertension on withdrawal are also less. The effective dose range is rather narrow.

PINADOL 5 mg tab, VISKEN 10, 15 mg tab.

4. Metoprolol It is the prototype of cardioselective (β_1) blockers; nearly 50 times higher dose is needed to block isoprenaline induced vasodilatation. It is less likely to worsen asthma, but is not entirely safe. It may be preferred in diabetics receiving insulin or oral hypoglycaemics. Patients who complain of cold hands and feet while on propranolol do better on metoprolol.

First pass metabolism of metoprolol is less marked than propranolol, but 90% or more is ultimately metabolized before excretion. There are slow and fast hydroxylators of metoprolol (CYP2D6 alleles); the former may require a lower dose.

Side effects of metoprolol are milder. It is generally given orally, but i.v. injection (5–15 mg) has been used in myocardial infarction provided bradycardia is absent.

BETALOC 25, 50, 100 mg tab, 5 mg/ml inj. LOPRESOR, METOLAR 50, 100 mg tab.

S(-) Metoprolol is the active enantiomer, now available as a single enantiomer product. It is to be used at half the dose as the racemate.

Dose: 12.5–50 mg OD–BD.

METPURE-XL 12.5, 25, 50 mg extended release tabs.

5. Atenolol A relatively selective β_1 blocker having low lipid solubility. It is incompletely absorbed orally, but first pass metabolism is not significant. Because of longer duration of action, once daily dose is often sufficient. Side effects related to CNS action are less likely. No deleterious

effects on lipid profile have been noted. Effective dose for most individuals falls in a narrow range. It is one of the most commonly used β blockers for hypertension and angina.

BETACARD, ATEN, TENORMIN 25, 50, 100 mg tab.

S(-) Atenolol This pure active enantiomer is effective at half the dose and may be better tolerated.

Dose: 12.5–50 mg OD;

ATPURE 12.5, 25, 50 mg tabs.

6. Acebutolol Another cardioselective agent with significant partial agonistic and membrane stabilizing properties. Effect on resting heart rate is less. The side effect profile is like that of metoprolol. Acebutolol is rapidly metabolized to an active metabolite diacetolol which is primarily excreted by kidney and has a longer $t_{1/2}$ (8–12 hours). As such, a single daily dose is sufficient in many patients.

SECTRAL 200, 400 mg tab., 10 mg/2 ml amp.
Intravenous dose for arrhythmias 20–40 mg.

7. Bisoprolol A cardioselective β blocker lacking intrinsic sympathomimetic activity; suitable for once daily administration in angina, hypertension and CHF.

CONCOR, CORBIS 5 mg tab; ½ to 2 tab OD.

8. Esmolol It is an ultrashort acting β_1 blocker devoid of partial agonistic or membrane stabilizing actions. It is inactivated by esterases in blood; plasma $t_{1/2}$ is < 10 min; action disappears 15–20 min after terminating i.v. infusion—degree of β blockade can be titrated by regulating rate of infusion. Rapid onset, short lasting fall in BP attends i.v. infusion of esmolol.

A loading dose of 0.5 mg/kg is given followed by 0.05–0.2 mg/kg/min infusion. It has been used to terminate supraventricular tachycardia, episodic atrial fibrillation or flutter, arrhythmia during anaesthesia, to reduce HR and BP during and after cardiac surgery, and in early treatment of myocardial infarction.

MINIBLOCK 100 mg/10 ml, 250 mg/10 ml inj.

9. Celiprolol It is a selective β_1 blocker having additional weak β_2 agonistic activity which reduces vascular resistance and holds promise of safety in asthmatics. Nonadrenoceptor media-

ted vasodilatation (probably due to NO production) adds to its antihypertensive action.

Dose: 200–600 mg OD; **CELIPRES 100, 200 mg tab.**

10. Nebivolol This highly selective β_1 blocker also acts as a NO donor, produces vasodilatation and has the potential to improve endothelial function, which may delay atherosclerosis. In contrast to older β blockers, hypotensive response to nebivolol has a rapid onset. It has been used in hypertension and CHF.

Dose: 5 mg (elderly 2.5 mg) OD;

NEBICARD 2.5, 5 mg tabs, NODON 5 mg tab.

USES

1. Hypertension β blockers are relatively mild antihypertensives. All agents, irrespective of associated properties, are nearly equally effective. They are one of the first choice drugs because of good patient acceptability and cardioprotective potential (*see* Ch. 40).

2. Angina pectoris All β blockers benefit angina of effort. Taken on a regular schedule they decrease frequency of attacks and increase exercise tolerance. High doses, however, may worsen angina in some patients by increasing ventricular size and reducing coronary flow (*see* Ch. 39).

3. Cardiac arrhythmias β blockers suppress extrasystoles and tachycardias, especially those mediated adrenergically (during anaesthesia, digitalis induced)—may be used i.v. for this purpose. They control ventricular rate in atrial fibrillation and flutter, but only occasionally restore sinus rhythm. Esmolol is an alternative drug for paroxysmal supraventricular tachycardia (*see* Ch. 38).

4. Myocardial infarction (MI) In relation to MI, β blockers have been used for two purposes:

(a) *Secondary prophylaxis of MI:* There is now firm evidence of benefit. Long-term use after recovery from MI has been found to decrease subsequent mortality by 20%.

- (i) By preventing reinfarction
- (ii) By preventing sudden ventricular fibrillation at the second attack of MI.

High risk patients (those who had large infarcts) should be put on β blockers (if there are no haemodynamic contraindications) for at least 2 years. β blockers with partial agonistic action are less suitable for this purpose.

(b) *Myocardial salvage during evolution of MI:* Administered i.v. within 4–6 hours of an attack followed by continued oral therapy. β blockers—

- (i) May limit infarct size by reducing O_2 consumption—marginal tissue which is partially ischaemic may survive.
- (ii) May prevent arrhythmias including ventricular fibrillation.

However, β blockers can be given to only those patients not in shock or cardiac failure and who have heart rate > 50 /min with not higher than first degree heart block (P-R interval < 0.24 sec). In megatrials such therapy has been found to reduce mortality by 20–25%.

5. Congestive heart failure Although β blockers can acutely worsen heart failure, several studies have reported beneficial haemodynamic effects of β_1 blockers over long-term in selected patients with dilated cardiomyopathy. Introduced gradually and maintained for long term, these drugs retard the progression of CHF and prolong life. The benefit may result from antagonism of deleterious effects of sympathetic overactivity on myocardium. Overactivation of cardiac β_1 receptors has been found to exert toxic effects on the heart by accelerating myocyte apoptosis and promoting functionally unfavourable remodeling. Certain β_1 blockers, used appropriately along with other measures, is now established as standard therapy for most mild to moderate CHF patients. However, they should not be given to patients with marked fluid retention and to those requiring i.v. vasodilators or i.v. inotropic drugs (*see* Ch. 37).

6. Dissecting aortic aneurysm β blockers help by reducing cardiac contractile force and aortic pulsation.

7. Pheochromocytoma β blockers may be used to control tachycardia and arrhythmia, but should

never be administered unless an α blocker has been given before, otherwise dangerous rise in BP can occur. They suppress cardiomyopathy caused by excess CAs.

8. Thyrotoxicosis Propranolol rapidly controls sympathetic symptoms (palpitation, nervousness, tremor, fixed stare, severe myopathy and sweating) without significantly affecting thyroid status. It inhibits peripheral conversion of T_4 to T_3 and is highly valuable during thyroid storm. Major use, however, is preoperatively and while awaiting response to antithyroid drugs/radioactive iodine.

9. Migraine Propranolol is the most effective drug for chronic prophylaxis of migraine (*see* p. 172).

10. Anxiety Propranolol exerts an apparent antianxiety effect, especially under conditions which provoke nervousness and panic, e.g. examination, unaccustomed public appearance, etc. This is probably due to blockade of peripheral manifestations of anxiety (palpitation, tremor) which have a reinforcing effect. It is largely ineffective in anxiety neurosis, but may benefit somatic symptoms.

11. Essential tremor Nonselective β blockers have now an established place in treating essential tremor. However, they do not benefit parkinsonian tremor.

12. Glaucoma Ocular β blockers are widely used for chronic simple (wide angle) glaucoma; also used as adjuvant in angle closure glaucoma (*see* below).

13. Hypertrophic obstructive cardiomyopathy The subaortic region is hypertrophic. Forceful contraction of this region under sympathetic stimulation (exercise, emotion) increases outflow resistance which has incapacitating haemodynamic consequence. β blockers improve c.o. in these patients during exercise by reducing left ventricular outflow obstruction, though they have little effect while at rest.

$\alpha + \beta$ ADRENERGIC BLOCKERS

Labetalol It is the first adrenergic antagonist capable of blocking both α and β receptors. There are 4 diastereomers of labetalol, each of which has a distinct profile of action on subtypes of α and β receptors. The commercial preparation has equal parts of each diastereomer and displays $\beta_1 + \beta_2 + \alpha_1$ blocking as well as weak β_2 agonistic activity. The β blocking potency is about 1/3 that of propranolol, while α blocking potency is about 1/10 of phentolamine.

Labetalol is 5 times more potent in blocking β than α receptors. As such, effects of a low dose resemble those of propranolol alone while at high dose they are like a combination of propranolol and prazosin. Fall in BP (both systolic and diastolic) is due to α_1 and β_1 blockade as well as β_2 agonism (vasodilatation). Relatively high doses reduce both c.o. and t.p.r. Heart rate is unchanged or slightly decreased. In contrast to propranolol, limb blood flow increases with labetalol. It has also been shown to inhibit NA uptake by adrenergic nerve endings.

Labetalol is orally effective but undergoes considerable first pass metabolism.

It is a moderately potent hypotensive and is especially useful in pheochromocytoma and clonidine withdrawal; can also be used in essential hypertension.

Most important side effect is postural hypotension, but this is significant only in some patients. Failure of ejaculation and other side effects of α and β blockers can also occur, but plasma lipid levels are not altered. Rashes and liver damage have been reported.

Dose: Start with 50 mg BD, increase to 100–200 mg TDS oral. In hypertensive emergencies 20–40 mg i.v. every 10 min till desired response is obtained.

NORMADATE 50, 100, 200 mg tab.

Carvedilol It is a $\beta_1 + \beta_2 + \alpha_1$ adrenoceptor blocker; produces vasodilatation due to α_1 blockade as well as calcium channel blockade, and has antioxidant property. It has been used in hypertension and is the β blocker especially employed as cardioprotective in CHF. Oral

bioavailability of carvedilol is 30%. It is primarily metabolized and has a $t_{1/2}$ of 6–8 hrs.

CHF: Start with 3.125 mg BD for 2 weeks, if well tolerated gradually increase to max. of 25 mg BD.

Hypertension/angina: 6.25 mg BD initially, titrate to max. of 25 mg BD.

CARVIL, **CARLOC**, **CARVAS** 3.125, 6.25, 12.5, 25 mg tabs; **ORICAR** 12.5, 25 mg tabs.

DRUGS FOR GLAUCOMA

Glaucoma is a group of diseases characterized by a progressive form of optic nerve damage. This is generally associated with raised (> 21 mmHg) intraocular tension (i.o.t), but the etiology is unknown and there are many risk factors. The chief therapeutic measure is to lower i.o.t. to target level, either by reducing secretion of aqueous humor or by promoting its drainage. The site of formation and pathway of drainage of aqueous humor as well as sites of action of antiglaucoma drugs is illustrated in Fig. 10.1. Major amount of aqueous ($\sim 90\%$) drains through the *trabecular route*, while $\sim 10\%$ fluid passes into the connective tissue spaces within the ciliary muscle—then *via* suprachoroid into episcleral vessels (*uveoscleral outflow*). Glaucoma is seen in *two* principal clinical forms:

A. Open angle (wide angle, chronic simple) glaucoma

It is probably a genetically predisposed degenerative disease affecting patency of the trabecular meshwork which is gradually lost past middle age. The i.o.t. rises insidiously and progressively. Ocular hypotensive drugs are used on a long term basis and constitute the definitive treatment in majority of cases.

1. β Adrenergic blockers

Topical β blockers are one of the first line drugs, but PG $F_{2\alpha}$ analogues are increasingly used now. In contrast to miotics, the β blockers do not affect pupil size, tone of ciliary muscle or outflow facility, but lower i.o.t. by reducing aqueous formation. This probably results from down regulation of adenylyl cyclase due to β_2 receptor

blockade in the ciliary epithelium and a secondary effect due to reduction in ocular blood flow. They are as effective as miotics and produce less ocular side effects. Ocular β blockers are lipophilic with high ocular capture (to reduce systemic effects) and have no/weak local anaesthetic activity (to avoid corneal hypoesthesia and damage).

Advantages of topical β blockers over miotics

- No change in pupil size: no diminution of vision in dim light and in patients with cataract
- No induced myopia which is especially troublesome in young patients
- No headache/brow pain due to persistent spasm of iris and ciliary muscles
- No fluctuations in i.o.t. as occur with pilocarpine drops
- Convenient twice/once daily application sufficient

Ocular side effects of β blockers *viz.* stinging, redness and dryness of eye, corneal hypoesthesia, allergic blepharoconjunctivitis and blurred vision are generally mild and infrequent. Their major limitation are the *systemic adverse effects* that occur due to absorption through nasolacrimal duct. Life-threatening bronchospasm has been reported in asthmatics. Bradycardia, accentuation of heart block and CHF are likely, especially in the elderly. In fact all adverse effects and contraindications of systemic β blocker therapy (*see p. 139*) apply to ocular β blockers as well.

Timolol It is the prototype of ocular β blockers; is nonselective ($\beta_1 + \beta_2$) and has no local anaesthetic or intrinsic sympathomimetic activity. The ocular hypotensive action (20–35% fall in i.o.t.) is smooth and well sustained. After chronic use, effect on i.o.t. persists for 2–3 weeks following discontinuation. This feature, in contrast to pilocarpine drops, gives a high level of clinical safety, i.e. 1 or 2 missed doses will not affect i.o.t. control. However, upto 30% cases of open angle

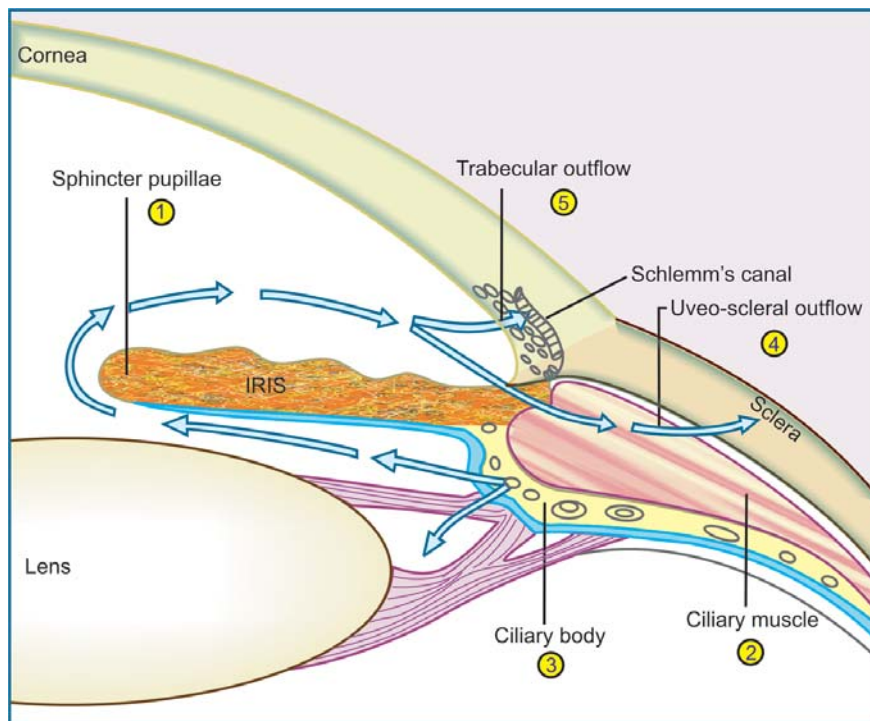

Fig. 10.1: Illustration of aqueous humor dynamics and the sites of action of ocular hypotensive drugs

- (1) Site of action of miotics in angle closure glaucoma: contraction of sphincter pupillae removes pupillary block and reverses obliteration of iridocorneal angle
- (2) Site of action of miotics in open angle glaucoma: contraction of ciliary muscle pulls on scleral spur and improves trabecular patency
- (3) Site of action of (a) β blockers (b) α_1 agonists (c) α_2 agonists (d) carbonic anhydrase inhibitors: all reduce aqueous secretion by ciliary body
- (4) Site of action of prostaglandins and possibly adrenaline: increase uveoscleral outflow by altering permeability and/or pressure gradients
- (5) Site of action of adrenaline: possibly increases aqueous conductivity of trabecular filtering cells (β_2 action)

glaucoma fail to achieve the desired level of i.o.t. with timolol alone, and may need additional medication.

GLUCOMOL, OCUPRES, IOTIM, LOPRES 0.25% and 0.5% eye drops; start with 0.25% drops BD, change to 0.5% drops in case of inadequate response.

Betaxolol It is β_1 selective blocker offering the advantage of less bronchopulmonary and probably less cardiac, central and metabolic side effects. In addition, it may exert a protective effect on retinal neurones independent of i.o.t. lowering, possibly by reducing Na^+/Ca^+ influx. However,

it is less efficacious in lowering i.o.t. than timolol, because ocular β receptors are predominantly of the β_2 subtype. Transient stinging and burning in the eye is more common with it. Most ophthalmologists prefer to start with betaxolol and change over to timolol (or a similar drug) only if i.o.t. control is insufficient or there is local intolerance to betaxolol.

OPTIPRESS, IOBET 0.5% eye drops; 1 drop in each eye BD.

Levobunolol It has been introduced as a once daily alternative to timolol. The ocular and

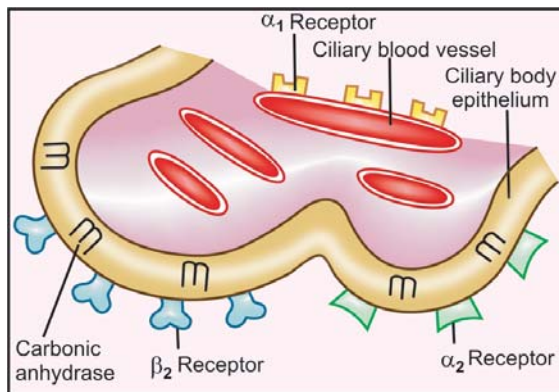

Fig. 10.2: Location of α_1 , α_2 and β_2 adrenergic receptors and of carbonic anhydrase enzyme (molecules which are targets of drug action for reducing aqueous formation) in the processes of the ciliary body

α_1 adrenoceptors constrict ciliary vessels and reduce aqueous production

α_2 adrenoceptors located on ciliary epithelium reduce aqueous secretion.

β_2 adrenoceptors located on ciliary epithelium enhance aqueous secretion *via* increased cAMP. Their blockade reduces secretion.

Carbonic anhydrase present within ciliary epithelial cells generates HCO_3^- ion which is secreted into aqueous humor.

systemic effects are very similar to timolol except for longer duration of action.

BETAGAN 0.5% ophthalmic soln., 1 drop OD.

Carteolol and *Metipranolol* are the other ocular β blockers.

Table 10.3: Mode of action of ocular hypotensive drugs

Drug/class	Aqueous secretion	Trabecular outflow	Uveoscleral outflow
1. β -blockers (Timolol)	↓	–	–
2. Adrenaline/Dipivefrine	↓?	↑	↑
3. Brimonidine/apraclonidine	↓	–	↑
4. Prostaglandins (Latanoprost)	–	↑?	↑
5. Miotics (Pilocarpine)	–	↑	–
6. Carbonic anhydrase inhibitors	↓	–	–

2. α Adrenergic agonists

Adrenaline Applied topically 0.5–1% Adr can lower i.o.t., but response is variable due to poor corneal penetration. The i.o.t. reduction is due to increased uveoscleral outflow and β_2 receptor mediated increased hydraulic conductivity of trabecular filtering cells. Reduction in aqueous formation can result from α_2 and α_1 receptor activation in ciliary body.

Adrenaline frequently produces ocular smarting and vasoconstriction followed by reactive hyperemia. It is not used now because of ocular intolerance and possible systemic effects.

Dipivefrine It is a prodrug of Adr; penetrates cornea and is hydrolysed by the esterases present there into Adr. Though better tolerated and longer acting than Adr, dipivefrine still produces significant ocular side effects. It is used only as add on therapy in poorly controlled patients.

PROPINE 0.1% eye drop; 1 drop in each eye BD.

Apraclonidine It is a polar clonidine congener which does not cross blood-brain barrier, but applied topically (0.5–1%) it lowers i.o.t. by ~25%. It decreases aqueous production by primary α_2 and subsidiary α_1 action in the ciliary body. Itching, lid dermatitis, follicular conjunctivitis, mydriasis, eyelid retraction, dryness of mouth and nose are common side effects. Its use is restricted to control of spikes of i.o.t. after laser trabeculoplasty or iridotomy.

Brimonidine This recently introduced clonidine congener is more α_2 selective and more lipophilic than apraclonidine. It lowers i.o.t. by 20–27% by reducing aqueous production and by increasing uveoscleral flow. Ocular side effects are similar to but less frequent than with apraclonidine. Because of weaker α_1 action, side effects like mydriasis, eyelid retraction, conjunctival blanching—hyperemia are less prominent, but dry mouth, sedation and small fall in BP have been noted.

Brimonidine is indicated both for short-term (prophylaxis of i.o.t. spikes post laser/post surgery) as well as long-term use in glaucoma. It is a 3rd choice/add on drug only.

ALPHAGAN, IOBRIM 0.2% eyedrops; 1 drop in each eye TDS.

3. Prostaglandin analogues

Low concentration of $\text{PGF}_{2\alpha}$ was found to lower i.o.t without inducing ocular inflammation. It acts

by increasing uveoscleral outflow, possibly by increasing permeability of tissues in ciliary muscle or by an action on episcleral vessels. An effect on trabecular outflow is also possible. Ciliary body COX-2 is down regulated in wide angle glaucoma indicating a physiological role of PG in aqueous humor dynamics.

Latanoprost Instilled in the eye, this $\text{PGF}_{2\alpha}$ derivative has shown efficacy similar to timolol (i.o.t. reduction by 25–35%) and the effect is well sustained over long-term. It reduces i.o.t. in normal pressure glaucoma also. Though ocular irritation and pain are frequent, no systemic side effects are reported. Blurring of vision, increased iris pigmentation, thickening and darkening of eyelashes have occurred in some cases.

Because of good efficacy, once daily application and absence of systemic complications, PG analogues have become the first choice drugs in developed countries. High cost limits their use in resource poor countries.

LACOMA, XALATAN 0.005% eye drops, one drop in each eye OD in the evening; LACOMA-T with timolol 0.5% eye drops. (To be stored in cold)

Unoprostone, Travoprost and Bimatoprost are other ocular PG analogues.

4. Carbonic anhydrase inhibitors

Acetazolamide (see Ch. 41) Oral treatment with acetazolamide (0.25 g 6–12 hourly) reduces aqueous formation by limiting generation of bicarbonate ion in the ciliary epithelium. It is used to supplement ocular hypotensive drugs for short term indications like angle closure, before and after ocular surgery/laser therapy. Systemic side effects—paresthesia, anorexia, hypokalaemia, acidosis, malaise and depression restrict long-term use to few cases in which target i.o.t. is not achieved even by concurrent use of 2–3 topical drugs.

Dorzolamide (2% eyedrops TDS) It is a topically useful carbonic anhydrase inhibitor developed to circumvent systemic side effects of acetazolamide. It lowers i.o.t. by ~20%; somewhat less efficacious than timolol. Ocular stinging, burning, itching and bitter taste are the side effects.

Dorzolamide is used only as add on drug to topical β blockers/PG analogues, or when these drugs are contraindicated.

DORTAS, DORZOX 2% eye drops.

Brinzolamide is another ocular carbonic anhydrase inhibitor.

5. Miotics: Till the 1970s topical pilocarpine and/or antiChEs were the standard antiglaucoma drugs. However, because of several drawbacks, they are now used only as the last option. In open angle glaucoma, they lower i.o.t. by increasing ciliary muscle tone thereby improving patency of trabeculae.

The current approach to treatment of open angle glaucoma can be summarized as—start monotherapy with latanoprost or a topical β blocker; if target i.o.t. is not attained either change over to the alternative drug or use both the above concurrently. Brimonidine/dorzolamide/dipivefrine are used only when there are contraindications to PG analogues/ β blockers, or to supplement their action. Topical miotics and oral acetazolamide are added only as the last resort.

B. Angle closure (narrow angle, acute congestive) glaucoma

It occurs in individuals with a narrow irido-corneal angle and shallow anterior chamber. The i.o.t. remains normal until an attack is precipitated, usually by mydriasis (Fig. 10.3A,B). The i.o.t. rises rapidly to very high values (40–60 mmHg). It is an emergent condition; failure to lower i.o.t. quickly may result in loss of sight.

Vigorous therapy employing various measures to reduce i.o.t. is instituted.

1. *Hypertonic mannitol* (20%) 1.5–2 g/kg or *glycerol* (10%): infused i.v. decongest the eye by osmotic action. A retention enema of 50% glycerine is also some times used.
2. *Acetazolamide*: 0.5 g i.v. followed by oral twice daily is started concurrently.
3. *Miotic*: Once the i.o.t. starts falling due to the above i.v. therapy, pilocarpine 1–4% is instilled every 10 min initially and then at

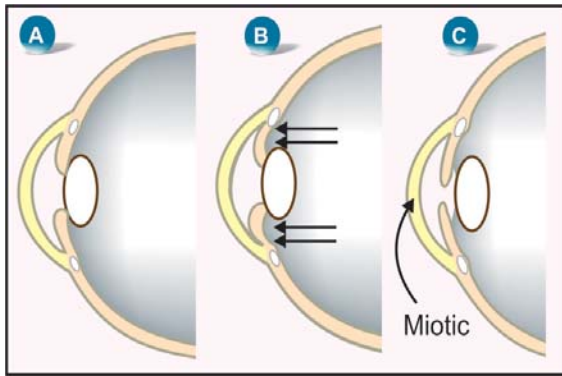

Fig. 10.3: Development of angle closure glaucoma and its reversal by miotic

- A. Mydriasis occurs in an eye with narrow iridocorneal angle and iris makes contact with lens blocking passage of aqueous from posterior to anterior chamber.
- B. Pressure builds up behind iris which bulges forward and closes the iridocorneal angle thus blocking aqueous outflow.
- C. Miotic makes the iris thin and pulls it away from the lens removing the pupillary block and restoring aqueous drainage

longer intervals. Contraction of sphincter pupillae changes the direction of forces in the iris to lessen its contact with the lens and spreads the iris mass centrally → pupillary block is removed and iridocorneal angle is freed (Fig. 10.3C). However, when i.o.t. is very high, the iris muscle fails to respond to miotics; tension should be reduced by other measures before miotics can act.

4. *Topical β blocker:* Timolol 0.5% is instilled 12 hourly in addition.
5. *Apraclonidine (1%)/latanoprost 0.005%* instillation may be added.

Drugs are used only to terminate the attack of angle closure glaucoma. Definitive treatment is surgical or laser iridotomy. Few cases, who have chronic narrow angle glaucoma, may be treated with a miotic/other ocular hypotensive drug for long periods, but often surgery/laser therapy is ultimately required.

Autacoids and Related Drugs

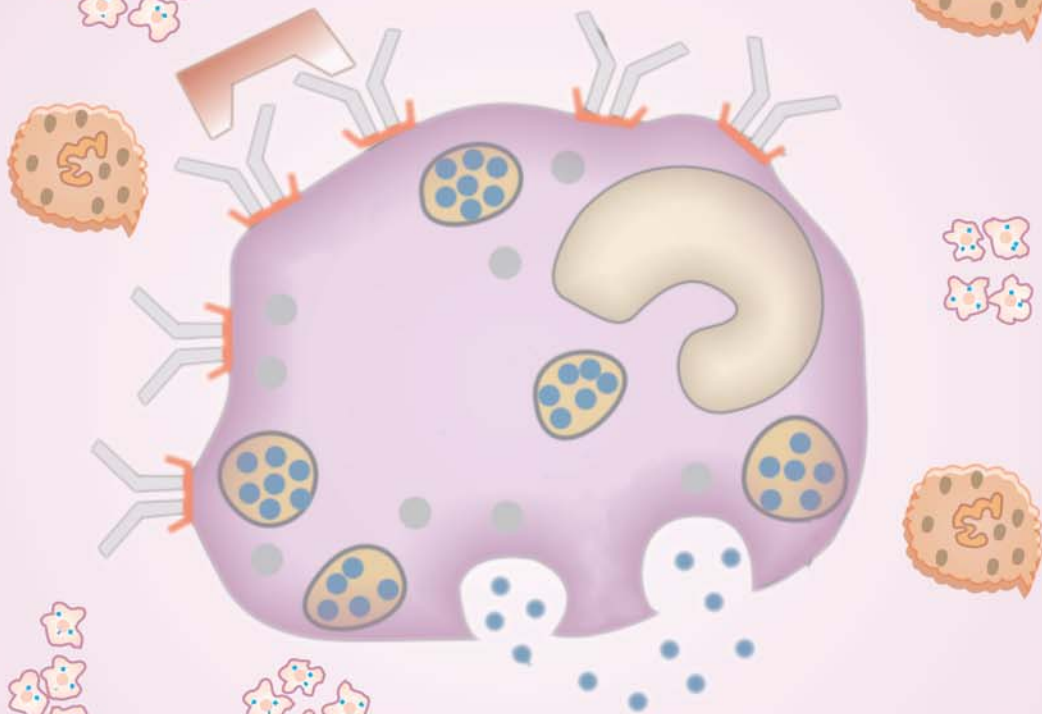

SECTION 3

Autacoids and Related Drugs

Autacoid This term is derived from Greek: *autos*—self, *akos*—healing substance or remedy.

These are diverse substances produced by a *wide variety of cells* in the body, having intense biological activity, but generally *act locally* (e.g. within inflammatory pockets) at the site of synthesis and release.

They have also been called 'local hormones'. However, they differ from 'hormones' in two important ways—hormones are produced by *specific cells*, and are transported through circulation to act on *distant target tissues*.

Autacoids are involved in a number of physiological and pathological processes (especially reaction to injury and immunological insult) and even serve as transmitters or modulators in the

nervous system, but their role at many sites is not precisely known. A number of useful drugs act by modifying their action or metabolism. The classical autacoids are—

Amine autacoids Histamine, 5-Hydroxytryptamine (Serotonin)

Lipid derived autacoids Prostaglandins, Leukotrienes, Platelet activating factor

Peptide autacoids Plasma kinins (Bradykinin, Kallidin), Angiotensin

In addition, cytokines (interleukins, TNF α , GM-CSF etc.) and several peptides like gastrin, somatostatin, vasoactive intestinal peptide and many others may be considered as autacoids.



HISTAMINE

Histamine, meaning 'tissue amine' (*histo*—tissue) is almost ubiquitously present in animal tissues and in certain plants, e.g. stinging nettle. Its pharmacology was studied in detail by Dale in the beginning of the 20th century when close parallelism was noted between its actions and the manifestations of certain allergic reactions. It was implicated as a mediator of hypersensitivity phenomena and tissue injury reactions. It is now known to play important physiological roles.

Histamine is present mostly within storage granules of *mast cells*. Tissues rich in histamine are skin, gastric and intestinal mucosa, lungs, liver and placenta. Nonmast cell histamine occurs in brain, epidermis, gastric mucosa and growing regions. Turnover of mast cell histamine is slow, while that of nonmast cell histamine is fast.

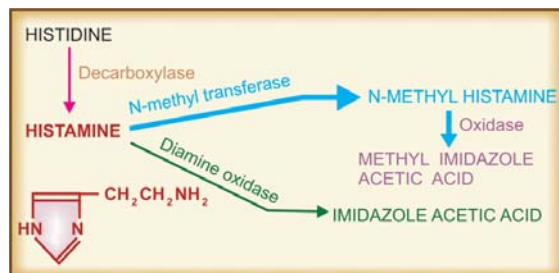

Fig. 11.1: Synthesis and degradation of histamine

Histamine is also present in blood, most body secretions, venoms and pathological fluids.

Synthesis, storage and destruction Histamine is β imidazolylethylamine. It is synthesized locally from the amino acid histidine and degraded rapidly by oxidation and methylation (Fig. 11.1). In mast cells, histamine (positively charged) is held by an acidic protein and heparin (negatively charged) within intracellular granules. When the granules are extruded by exocytosis, Na^+ ions in e.c.f. exchange with histamine to release it free (Fig. 11.2). Increase in intracellular cAMP inhibits histamine release. Histamine is inactive orally because liver degrades all histamine that is absorbed from the intestines.

Histamine receptors Analogous to adrenergic α and β receptors, histaminergic receptors were classified by Asch and Schild (1966) into H_1 and H_2 : those blocked by then available antihistamines were labelled H_1 . Sir James Black (1972) developed the first H_2 blocker burimamide and confirmed this classification. Both H_1 and H_2 receptors have now been cloned. A third H_3 receptor, which serves primarily as an autoreceptor controlling histamine release from neurones in brain was identified in 1983. Though some selective H_3 agonists and antagonists have been produced, none has found any clinical application. Features of these 3 types

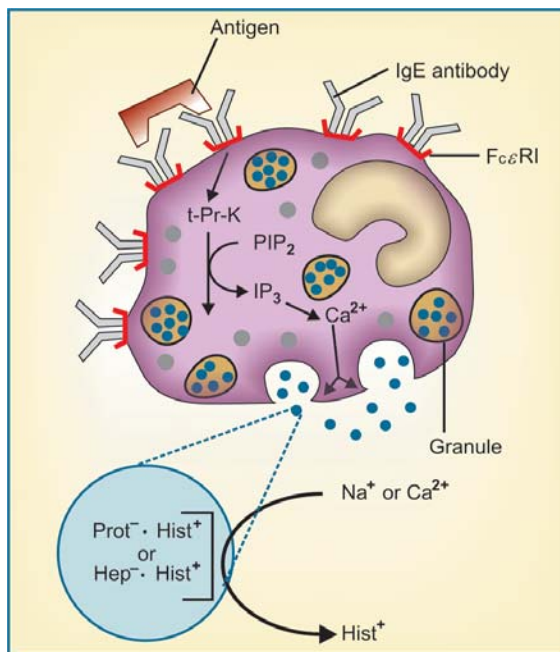

Fig. 11.2: Mechanism of antigen-antibody reaction induced release of histamine from mast cell.

In sensitized atopic individual, specific reaginic (IgE) antibody is produced and gets bound to Fc epsilon receptor I (FcεRI) on the surface of mast cells. On challenge, the antigen bridges IgE molecules resulting in transmembrane activation of a tyrosine-protein kinase (t-Pr-K) which phosphorylates and activates phospholipase C γ . Phosphatidyl inositol bisphosphate (PIP₂) is hydrolysed and inositol trisphosphate (IP₃) is generated which triggers intracellular release of Ca²⁺. The Ca²⁺ ions induce fusion of granule membrane with plasma membrane of the mast cell resulting in exocytotic release of granule contents. In the granule, positively charged histamine (Hist⁺) is held complexed with negatively charged protein (Prot⁻) and heparin (Hep⁻) molecules. Cationic exchange with extracellular Na⁺ (and Ca²⁺) sets histamine free to act on the target cells.

of histaminergic receptor are compared in Table 11.1.

Molecular cloning has revealed yet another (H₄) receptor in 2001. It has considerable homology with H₃ and binds many H₃ ligands. Eosinophils, mast cells and basophils are the primary cells expressing H₄ receptors; activation enhances chemotaxis of these cells. The H₄ receptor may be playing a role in allergic inflammation: H₄ antagonists are being explored as potential drugs for allergic inflammatory conditions like rhinitis and asthma. Intestines and brain are the other sites where H₄ receptors have been located.

PHARMACOLOGICAL ACTIONS

1. Blood vessels Histamine causes marked dilatation of smaller blood vessels, including arterioles, capillaries and venules. On s.c. injection flushing, especially in the blush area, heat, increased heart rate and cardiac output, with little or no fall in BP are produced. Rapid i.v. injection causes fall in BP which has an early short lasting H₁ and a slow but more persistent H₂ component. With low doses only the H₁ component is manifest since H₁ receptors have higher affinity. Fall in BP due to large doses is completely blocked only by a combination of H₁ and H₂ antagonists. Dilatation of cranial vessels causes pulsatile headache.

Like ACh and many other autacoids, vasodilatation caused by histamine is partly (H₁ component) indirect, mediated through 'endothelium dependent relaxing factor' (EDRF): the receptor being located on the endothelial cells. H₂ receptors mediating vasodilatation are located directly on the vascular smooth muscle.

Larger arteries and veins are constricted by histamine: mediated by H₁ receptor on vascular smooth muscle. Histamine also causes increased capillary permeability due to separation of endothelial cells → exudation of plasma. This is primarily a H₁ response.

Injected intradermally, it elicits the *triple response* consisting of:

- Red spot: due to intense capillary dilatation.
- Wheal: due to exudation of fluid from capillaries and venules.
- Flare: i.e. redness in the surrounding area due to arteriolar dilatation mediated by axon reflex.

2. Heart Direct effects of histamine on *in situ* heart are not prominent, but the isolated heart, especially of guinea pig, is stimulated—rate as well as force of contraction is increased. These are primarily H₂ responses but a H₁ mediated negative dromotropic (slowing of A-V conduction) effect has also been demonstrated.

3. Visceral smooth muscle Histamine causes bronchoconstriction; guinea pigs and patients of

Table 11.1: Distinctive features of three types of histaminergic receptors

	H_1	H_2	H_3
1. Selective agonists (relative selectivity H_1 : H_2)	2-Methylhistamine (8:1) 2-Pyridylethylamine(30:1) 2-Thiazolyethylamine (90:1)	4-Methylhistamine (1:170) Dimaprit (1:2000) Impromidine (1:10,000)	(R) α -Methylhistamine (H_1 : H_3 1:3000) Imetit
2. Selective antagonists (relative selectivity H_1 : H_2)	Mepyramine (6000:1) Chlorpheniramine (15000:1)	Cimetidine (1: 500) Ranitidine (1 : >500)	Thiopramide (H_1 : H_3 1: 23000) Impromidine (H_2 -agonist) Clobenpropit
3. Receptor type	G-protein coupled	G-protein coupled	G-protein coupled
4. Effector pathway	PIP ₂ hydrolysis → IP ₃ /DAG; Release of Ca ²⁺ from intracellular stores; Protein kinase-C activation	Adenylyl cyclase activation → cAMP ↑ → phosphorylation of specific proteins	a) Restricting Ca ²⁺ influx b) K ⁺ channel activation c) cAMP ↓
5. Distribution in body: actions mediated	a) Smooth muscle (intestine, airway, uterus) — contraction b) Blood vessels i) Endothelium: Release of NO and, PGI ₂ — vasodilatation. widening of gap junctions — increased capillary permeability ii) Smooth muscle — vasoconstriction. c) Afferent nerve endings — stimulation d) Ganglionic cell — stimulation. e) Adrenal medulla — release of CAs. f) Brain — transmitter.	a) Gastric glands — acid secretion b) Blood vessels (smooth muscle) — dilatation c) Heart Atria: +ive chronotropy Ventricles: +ive inotropy d) Uterus (rat) — relaxation e) Brain — transmitter	a) Brain (presynaptically) — inhibition of histamine release — sedation b) Lung, spleen, skin, gastric mucosa — decrease histamine release c) Ileum — inhibition of ACh release from myenteric plexus neurones d) Certain blood vessels — inhibit NA release — vasodilatation

PIP₂ — Phosphatidylinositol bisphosphate; IP₃ — Inositol trisphosphate; DAG — Diacylglycerols;

EDRF — Endothelium dependent relaxing factor; PGI₂ — Prostacyclin;

CAs — Catecholamines; cAMP — Cyclic 3',5' adenosine monophosphate; ACh — acetylcholine

asthma are highly sensitive. Large doses cause abdominal cramps and colic by increasing intestinal contractions. Guinea pig uterus is contracted while that of rat is relaxed; human uterus is not much affected as are most other visceral smooth muscles.

Smooth muscle contraction is a H_1 response. In few instances H_2 mediated relaxation is also seen, e.g. bronchial muscle of sheep, human bronchi after H_1 blockade.

4. Glands Histamine causes marked increase in gastric secretion—primarily of acid but also of pepsin (*see* Ch. 46). This is a direct action exerted on parietal cells through H_2 receptors and is mediated by increased cAMP generation, which in turn activates the membrane proton pump (H^+K^+ ATPase).

Histamine can increase other secretions also, but the effect is hardly discernable.

5. Sensory nerve endings Itching occurs when histamine is injected i.v. or intracutaneously. Higher concentrations injected more deeply cause pain. These are reflections of the capacity of histamine to stimulate nerve endings.

6. Autonomic ganglia and adrenal medulla These are stimulated and release of Adr occurs, which can cause a secondary rise in BP.

7. CNS Histamine does not penetrate blood-brain barrier—no central effects are seen on i.v. injection. However, intracerebroventricular administration produces rise in BP, cardiac stimulation, behavioural arousal, hypothermia, vomiting and ADH release. These effects are mediated through both H_1 and H_2 receptors.

PATHOPHYSIOLOGICAL ROLES

1. Gastric secretion Histamine has dominant physiological role in mediating secretion of HCl in the stomach (*see* Fig. 46.1). Nonmast cell histamine occurs in gastric mucosa, possibly in cells called 'histaminocytes'; situated close to the parietal cells, and has high turnover rate. It is released locally under the influence of all stimuli

that evoke gastric secretion (feeding, vagal stimulation, cholinergic drugs and gastrin) and activates the proton pump (H^+K^+ ATPase) through H_2 receptors.

H_2 blockers not only suppress acid secretion induced by histamine but also markedly diminish that in response to ACh and gastrin. By a mutually synergistic interaction the three secretagogues amplify responses to each other with histamine playing the dominant role. As such, antimuscarinic drugs dampen the response to histamine and gastrin also. All three secretagogues activate the same proton pump (H^+K^+ ATPase) in the parietal cell membrane, but through their own receptors.

2. Allergic phenomena Mediation of hypersensitivity reactions has been the first role ascribed to histamine. However, histamine is only one of the mediators of such phenomena. Released from mast cells following AG : AB reaction on their surface (involving IgE type of reaginic antibodies; Fig. 11.2) in immediate type of hypersensitivity reactions, histamine is causative in urticaria, angioedema, bronchoconstriction and anaphylactic shock. The H_1 antagonists are effective in controlling these manifestations to a considerable extent, except asthma and to a lesser extent anaphylactic fall in BP in which leukotrienes (especially LTD₄) and PAF appear to be more important. Histamine is not involved in delayed or retarded type of allergic reactions.

3. As transmitter Histamine is believed to be the afferent transmitter which initiates the sensation of itch and pain at sensory nerve endings.

Nonmast cell histamine occurs in brain, especially hypothalamus and midbrain. It is involved in maintaining wakefulness; H_1 antihistaminics owe their sedative action to blockade of this function. In the brain H_1 agonism suppresses appetite; certain H_1 antagonists stimulate appetite. Histamine also appears to act as a transmitter regulating body temperature, cardiovascular function, thirst, hormone release from anterior pituitary and possibly other functions.

4. Inflammation Histamine has been implicated as a mediator of vasodilatation and other changes that occur during inflammation. It promotes adhesion of leukocytes to vascular endothelium by expressing adhesion molecule *P-selectin* on endothelial cell surface, sequestering leukocytes at the inflammatory site. It may also regulate microcirculation according to local needs.

5. Tissue growth and repair Because growing and regenerating tissues contain high concentrations of histamine, it has been suggested to play an essential role in the process of growth and repair.

6. Headache Histamine has been implicated in certain vascular headaches, but there is no conclusive evidence.

USES

Histamine has no therapeutic use. In the past it has been used to test acid secreting capacity of stomach, bronchial hyperreactivity in asthmatics, and for diagnosis of pheochromocytoma, but these pharmacological tests are risky and obsolete now.

Betahistine It is an orally active, somewhat H_1 selective histamine analogue, which is used to control vertigo in patients of Menière's disease: possibly acts by causing vasodilatation in the internal ear. It is contraindicated in asthmatics and ulcer patients.

VERTIN 8 mg tab., 1/2 to 1 tab. QID.

HISTAMINE RELEASERS

A variety of mechanical, chemical and immunological stimuli are capable of releasing histamine from mast cells.

1. Tissue damage: trauma, stings and venoms, proteolytic enzymes, phospholipase A.
2. Antigen: antibody reaction involving IgE antibodies.
3. Polymers like dextran, polyvinyl pyrrolidone (PVP).
4. Some basic drugs—tubocurarine, morphine, atropine, stilbamidine, polymyxin B, vancomycin and even some antihistaminics directly release histamine without an immunological reaction.
5. Surface acting agents like Tween 80, compound 48/80 etc. The primary action of these substances is release of histamine from mast cells, therefore they are called histamine liberators. They produce an 'anaphylactoid' reaction—itching and burning sensation, flushing, urticaria, fall in BP, tachycardia, headache, colic and asthma. Most of these symptoms are controlled by a H_1 antihistaminic, better still if H_2 blocker is given together.

H_1 ANTAGONISTS (Conventional antihistaminics)

These drugs competitively antagonize actions of histamine at the H_1 receptors. The first compounds of this type were introduced in the late 1930s and have subsequently proliferated into an unnecessary motley of drugs. Nevertheless, they are frequently used for a variety of purposes. More commonly employed now are the less sedating second generation H_1 antihistaminics that have been added after 1980. Seemingly, H_1 antihistaminics have diverse chemical structures, but majority have a substituted ethylamine side chain.

PHARMACOLOGICAL ACTIONS

Qualitatively all H_1 antihistaminics have similar actions, but there are quantitative differences, especially in the sedative property.

1. Antagonism of histamine They effectively block histamine induced bronchoconstriction, contraction of intestinal and other smooth muscle and triple response—especially wheal, flare and itch. Fall in BP produced by low doses of histamine is blocked, but additional H_2 antagonists are required for complete blockade of higher doses. Pretreatment with these drugs protects animals from death caused by i.v. injection of large doses of histamine. Release of Adr from adrenal medulla in response to histamine is abolished. Constriction of larger blood vessel by histamine is also antagonized. Action of histamine on gastric secretion is singularly not affected by these drugs.

2. Antiallergic action Many manifestations of immediate hypersensitivity (type I reactions) are suppressed. Urticaria, itching and angioedema are well controlled. Anaphylactic fall in BP is only partially prevented. Asthma in man is practically unaffected though anaphylactic bronchoconstriction in guinea pig is largely prevented. This tissue and species dependence of response probably reflects extent of involvement of histamine in the reaction. It is now well established that

Table 11.2: Clinical classification, doses and preparations of H₁ antihistaminics

<i>Drug</i>	<i>Dose and route</i>	<i>Preparations</i>
I. HIGHLY SEDATIVE		
Diphenhydramine	25–50 mg oral	BENADRYL 25, 50 mg cap., 12.5 mg/5ml syr.
Dimenhydrinate	25–50 mg oral,	DRAMAMINE 16 mg/5 ml syr, 50 mg tab
Promethazine	25–50 mg oral, i.m. (1 mg/kg)	PHENERGAN 10, 25 mg tab., 5 mg/ml elixer, 25 mg/ml inj
Hydroxyzine	25–50 mg oral, i.m.	ATARAX 10, 25 mg tab., 10 mg/5 ml syr, 6 mg/ml drops, 25 mg/ml inj.
II. MODERATELY SEDATIVE		
Pheniramine	20–50 mg oral, i.m.	AVIL 25 mg, 50 mg tab, 15 mg/5 ml syr, 22.5 mg/ml inj.
Cyproheptadine	4 mg oral	PRACTIN, CIPLACTIN 4 mg tab., 2 mg/5ml syrup,
Meclizine	25–50 mg oral	In DILIGAN 12.5 mg + niacin 50 mg tab In PREGNIDOXIN 25 mg + Caffeine 20 mg tab
Buclizine	25–50 mg oral	LONGIFENE 25 mg tab, 6 mg/5 ml syrup.
Cinnarizine	25–50 mg oral	STUGERON, VERTIGON 25 and 75 mg tab.
III. MILD SEDATIVE		
Chlorpheniramine	2–4 mg (0.1 mg/kg) oral, i.m.	PIRITON, CADISTIN 4 mg tab,
Dexchlorpheniramine	2 mg oral	POLARAMINE 2 mg tab, 0.5 mg/ 5 ml syr
Dimethindene	1 mg oral	FORISTAL 1 mg tab., 2.5 mg SR tab.
Triprolidine	2.5–5 mg oral	ACTIDIL 2.5 mg tab.
Mebhydroline	100–300 mg oral	INCIDAL 50 mg (base) tab.
Cyclizine	50 mg oral	MAREZINE 50 mg tab.
Clemastine	1–2 mg oral	TAVEGYL 1 mg tab., 0.5 mg/5 ml syr
IV. SECOND GENERATION ANTIHISTAMINICS		
Fexofenadine	120–180 mg oral	ALLEGRA, ALTIVA, FEXO 120, 180 mg tab
Loratadine	10 mg oral	LORFAST, LORIDIN, LORMEG, 10 mg tab, 1 mg/ml susp.
Desloratadine	5 mg oral	DESLOR, LORDAY 5 mg tab
Cetirizine	10 mg oral	ALERID, CETZINE, ZIRTIN, SIZON 10 mg tab, 5 mg/5 ml syr.
Levocetirizine	5–10 mg oral	LEVOSIZ, LEVORID, TECZINE 5, 10 mg tab
Azelastine	4 mg oral 0.28 mg intranasal	AZEP NASAL SPRAY 0.14 mg per puff nasal spray
Mizolastine	10 mg oral	ELINA 10 mg tab
Ebastine	10 mg oral	EBAST 10 mg tab
Rupatadine	10 mg oral	RUPAHIST 10 mg tab

leukotrienes (C₄ and D₄) and PAF are more important mediators for human asthma.

3. CNS The older antihistamines produce variable degree of CNS depression. This appears to depend on the compound's ability to penetrate blood-brain barrier and its affinity for the central (compared to peripheral) H₁ receptors. Individual susceptibility to different agents varies considerably, but an overall grading of the sedative property is presented in Table 11.2. Some individuals also experience stimulant effects like restlessness and insomnia. Excitement and convulsions are frequently seen at toxic doses. The second generation antihistaminics are practically non-sedating.

Certain (*see below*) H₁ antihistamines are effective in preventing motion sickness. It is not certain whether this is due to antagonism of histamine in the brain or reflects antimuscarinic property of these drugs. Promethazine also controls vomiting of pregnancy and other causes.

Promethazine and few other antihistaminics reduce tremor, rigidity and sialorrhoea of parkinsonism. Anticholinergic and sedative properties underlie the benefit.

Some H₁ antihistamines are also effective antitussives (*see Ch. 16*).

4. Anticholinergic action Many H₁ blockers in addition antagonize muscarinic actions of ACh. The anticholinergic action can be graded as:

High	Low	Minimal/Absent
Promethazine	Chlorpheniramine	Fexofenadine
Diphenhydramine	Hydroxyzine	Astemizole
Dimenhydrinate	Triprolidine	Loratadine
Pheniramine	Cyclizine	Cetirizine
Cyproheptadine		Mizolastine

If used concurrently with atropine or its substitutes, phenothiazines, tricyclic antidepressants or disopyramide, the anticholinergic action adds up.

5. Local anaesthetic Some drugs like pheniramine, have strong while others have weak

membrane stabilizing property. However, they are not used clinically as local anaesthetic because they cause irritation when injected s.c.

Membrane stabilizing activity also confers antiarrhythmic property to these compounds.

6. BP Most antihistaminics cause a fall in BP on i.v. injection (direct smooth muscle relaxation). However, this is not evident on oral administration.

PHARMACOKINETICS

The classical H₁ antihistaminics are well absorbed from oral and parenteral routes, metabolized in the liver and excreted in urine. They are widely distributed in the body and enter brain. The newer compounds penetrate brain poorly. Duration of action of most agents is 4–6 hours, except meclizine, loratadine, cetirizine and fexofenadine which act for 12–24 hours or more.

SIDE EFFECTS AND TOXICITY

Side effects with first generation H₁ antihistaminics are frequent, but are generally mild. Individuals show marked differences in susceptibility to side effects with different drugs. Some tolerance to side effects develops on repeated use.

Sedation, diminished alertness and concentration, light headedness, motor incoordination, fatigue and tendency to fall asleep are the most common. Objective testing shows impairment of psychomotor performance. Patients should be cautioned not to operate motor vehicles or machinery requiring constant attention. Alcohol synergises in producing these effects as do other CNS depressants. Few individuals become restless, nervous and are unable to sleep. Second generation compounds are largely free of CNS effects.

Dryness of mouth, alteration of bowel movement, urinary hesitancy and blurring of vision can be ascribed to anticholinergic property.

Epigastric distress and headache are also common. Local application can cause contact dermatitis.

Some like cyclizine and fexofenadine are teratogenic in animals; but not in humans; caution is nevertheless to be exercised during pregnancy.

Acute overdose produces central excitation, tremors, hallucinations, muscular incoordination, convulsions, flushing, hypotension, fever and some other features of belladonna poisoning. Death is due to respiratory and cardiovascular failure.

SECOND GENERATION ANTIHISTAMINICS

The second generation antihistaminics (SGAs) may be defined as those H₁ receptor blockers marketed after 1980 which have one or more of the following properties :

- Higher H₁ selectivity: no anticholinergic side effects.
- Absence of CNS depressant property.
- Additional antiallergic mechanisms apart from histamine blockade: some also inhibit late phase allergic reaction by acting on leukotrienes or by antiplatelet activating factor effect.

Some recent compounds like fexofenadine and cetirizine that are active metabolites of earlier drugs have also been referred as 'third generation antihistamines', but this has not been accepted by an international consensus group of experts.

These newer drugs have the advantage of not impairing psychomotor performance (driving etc. need not be contraindicated), produce no subjective effects, no sleepiness, do not potentiate alcohol or benzodiazepines. Some patients do complain of sedation, but incidence is similar to placebo. However, they have a narrow spectrum of therapeutic usefulness which is limited by the extent of involvement of histamine (acting through H₁ receptors) in the disease state. Their principal indications are:

- (i) Allergic rhinitis and conjunctivitis, hay fever, pollinosis—control sneezing, runny but not blocked nose, and red, watering, itchy eyes.
 - (ii) Urticaria, dermatographism, atopic eczema.
 - (iii) Acute allergic reactions to drugs and foods.
- They have poor antipruritic, antiemetic and antitussive actions.

Fexofenadine It is the active metabolite of terfenadine, the first nonsedating SGA that was withdrawn because of several deaths due to polymorphic ventricular tachycardia (*Torsades de pointes*) occurring with its higher doses or when it was coadministered with CYP3A4 inhibitors (erythromycin, clarithromycin, ketoconazole, itraconazole, etc.). This toxicity is based on blockade of delayed rectifier K⁺ channels in the heart at higher concentrations. Astemizole is another SGA banned for the same reason. Fexofenadine has a low propensity to block delayed rectifier K⁺ channels, does not prolong QTc interval; no interaction with CYP3A4 inhibitors have been reported. It is largely free of arrhythmogenic potential, but some cases of ventricular arrhythmia in patients with pre-existing long QT interval have been reported. Thus, it is not entirely safe in patients with long QT, bradycardia or hypokalemia.

Fexofenadine does not cross blood-brain barrier—does not produce sedation or impair psychomotor performance and is free of atropinic side effects. It is rapidly absorbed, excreted unchanged in urine and bile, has plasma t_{1/2} 11–16 hours and duration of action 24 hours. Though erythromycin and ketoconazole increase its blood levels, but no arrhythmias have been observed.

Dose: For allergic rhinitis 120 mg OD; for urticaria and other skin allergies 180 mg OD.

Loratadine Another long-acting selective peripheral H₁ antagonist which lacks CNS depressant effects and is fast acting. It is partly metabolized by CYP3A4 to an active metabolite with a longer t_{1/2} of 17 hr, but has not produced cardiac arrhythmia in overdose, though seizures are reported. No interaction with macrolides or antifungals has been noted. Good efficacy has been reported in urticaria and atopic dermatitis.

Desloratadine It is the major active metabolite of loratadine effective at half the dose. Non-interference with psychomotor performance and cardiac safety are documented.

Cetirizine It is a metabolite of hydroxyzine with marked affinity for peripheral H₁ receptors;

penetrates brain poorly, but subjective somnolence has been experienced at higher doses. It is not metabolized; does not prolong cardiac action potential or produce arrhythmias when given with erythromycin/ketoconazole.

Cetirizine in addition inhibits release of histamine and of cytotoxic mediators from platelets as well as eosinophil chemotaxis during the secondary phase of the allergic response. Thus, it may benefit allergic disorders by other actions as well. It attains high and longer lasting concentration in skin, which may be responsible for superior efficacy in urticaria/atopic dermatitis, as well as for once daily dosing despite elimination $t_{1/2}$ of 7–10 hr. It is indicated in upper respiratory allergies, pollinosis, urticaria and atopic dermatitis; also used as adjuvant in seasonal asthma.

Levocetirizine is the active R(–) enantiomer of cetirizine. It is effective at half the dose and appears to produce few side effects.

Azelastine This newer H_1 blocker has good topical activity; in addition inhibits histamine release and inflammatory reaction triggered by LTs and PAF; and has bronchodilator property. After intranasal application it has been shown to down regulate intracellular adhesion molecule-1 (ICAM-1) expression on nasal mucosa. Its $t_{1/2}$ is 24 hr, but action lasts longer due to active metabolite. Its metabolism is inhibited by CYP3A4 inhibitors. Given by nasal spray for seasonal and perennial allergic rhinitis it provides quick symptomatic relief lasting 12 hr. Stinging in the nose and altered taste perception are the local side effects. Some somnolence has been reported on nasal application and a tendency to weight gain noted after oral use.

Mizolastine This nonsedating antihistaminic is effective in allergic rhinitis and urticaria by single daily dosing despite a $t_{1/2}$ of 8–10 hr and no active metabolite.

Ebastine Another newer SGA that rapidly gets converted to the active metabolite carbastine having a $t_{1/2}$ of 10–16 hr. It is nonsedating and active in nasal and skin allergies. Animal studies

have found it to prolong Q-Tc interval which makes it liable to arrhythmogenic potential and CYP3A4 interaction, but actual reports are still few.

Rupatadine This recently introduced antihistaminic has additional PAF antagonistic property, and is indicated in allergic rhinitis.

USES

The uses of H_1 antihistaminics are based on their ability to block certain effects of histamine released endogeneously, as well as on sedative and anticholinergic properties.

1. Allergic disorders Antihistaminics do not suppress AG: AB reaction, but block the effects of released histamine—are only palliative. They effectively control certain immediate type of allergies, e.g. itching, urticaria, seasonal hay fever, allergic conjunctivitis and angioedema of lips, eyelids, etc. However, their action is slow—Adr alone is life-saving in laryngeal angioedema. Similarly, they cannot be relied upon in anaphylactic shock and have a secondary place to Adr. Benefits are less marked in perennial vasomotor rhinitis, atopic dermatitis and chronic urticarias; combination with an H_2 antagonist succeeds in some cases of chronic urticaria not responding to H_1 antagonist alone.

The antihistaminics are ineffective in bronchial asthma: reasons may be—

- (i) Leukotrienes (C_4 , D_4) and PAF are more important mediators than histamine.
- (ii) Concentration of antihistaminics attained at the site may not be sufficient to block high concentration of histamine released locally in the bronchi.

Certain newer compounds like cetirizine have adjuvant role in seasonal asthma.

Antihistaminics are also ineffective in other types of humoral and cell mediated allergies because histamine is not involved. They do suppress urticaria and swellings in serum sickness, but not other components of the syndrome.

Type I hypersensitivity reactions to drugs (except asthma and anaphylaxis) are suppressed. Some skin rashes also respond.

2. Other conditions involving histamine Antihistaminics block symptoms produced by histamine liberators; afford symptomatic relief in insect bite and ivy poisoning. Abnormal dermographism is suppressed. They have prophylactic value in blood/saline infusion induced rigor.

3. Pruritides Many conventional antihistamines have antipruritic action independent of H₁ antagonism. Though relief is often incomplete, older antihistaminics remain the first choice drugs for idiopathic pruritus.

4. Common cold Antihistaminics do not affect the course of the illness but may afford symptomatic relief by anticholinergic (reduce rhinorrhoea) and sedative actions. The newer non-sedating antihistamines are less effective in this respect.

5. Motion sickness Promethazine, diphenhydramine, dimenhydrinate and cyclizine have prophylactic value in milder types of motion sickness; should be taken one hour before starting journey. Promethazine can also be used in morning sickness, drug induced and postoperative vomiting, radiation sickness. Cyproheptadine has appetite stimulating effect; has been used in underweight children.

6. Vertigo Cinnarizine is the H₁ antihistamine having additional anticholinergic, anti-5-HT, sedative and vasodilator properties which has been widely used in vertigo. It modulates Ca²⁺ fluxes and attenuates vasoconstrictor action of many endogenous substances.

Cinnarizine inhibits vestibular sensory nuclei in the inner ear, suppresses postrotatory labyrinthine reflexes, possibly by reducing stimulated influx of Ca²⁺ from endolymph into the vestibular sensory cells. Beneficial effects have been reported in Ménière's disease and other types of vertigo. Side effects are sedation and mild g.i. upset.

DRUGS FOR VERTIGO

The therapy of vertigo occurring in Ménière's disease and other conditions is imperfect. A variety of approaches have been tried and have met with partial success.

1. Labyrinthine suppressants They suppress end-organ receptors or inhibit central cholinergic pathway (in vestibular nuclei).

(a) *Antihistaminics* (with anticholinergic action)—cinnarizine, cyclizine, dimenhydrinate, diphenhydramine, promethazine.

(b) *Anticholinergics*—atropine, hyoscine.

(c) *Antiemetic phenothiazines*—prochlorperazine, thietilperazine.

2. Vasodilators They improve blood flow to labyrinth and brainstem—betahistine, codergocrine, nicotinic acid, naftidrofuryl.

3. Diuretics They decrease labyrinthine fluid pressure—acetazolamide, thiazides, furosemide.

4. Anxiolytics, antidepressants These drugs appear to modify the sensation of vertigo—diazepam, amitriptyline.

5. Corticosteroids They suppress intralabyrinthine edema due to viral infection or other causes.

Parenteral prochlorperazine is the most effective drug for controlling violent vertigo and vomiting.

7. Preanaesthetic medication Promethazine has been used for its anticholinergic and sedative properties.

8. Cough Antihistaminics like chlorpheniramine, diphenhydramine and promethazine are constituents of many popular cough remedies. They have no selective cough suppressant action, but may afford symptomatic relief by sedative and anticholinergic property (*see* Ch. 16).

9. Parkinsonism Promethazine and some others afford mild symptomatic relief in early cases—based on anticholinergic and sedative property.

10. Acute muscle dystonia Caused by antidopaminergic-antipsychotic drugs is promptly relieved by parenteral promethazine or hydroxyzine. This is again based on central anticholinergic action of the drugs.

11. As sedative, hypnotic, anxiolytic Antihistaminics with CNS depressant action have been used as sedative and to induce sleep, especially in children. However, promethazine has produced serious respiratory depression in young children; few deaths are on record; it is not indicated in

children aged 2 years or less. For promoting sleep, antihistaminics are not as dependable as benzodiazepines. Hydroxyzine has been used in anxiety associated with autonomic manifestations.

(Combinations of antihistaminics with antidiarrhoeals or bronchodilators, or those containing more than one antihistaminic are banned in India.)

H₂ antagonist The first H₂ blocker *Burimamide* was developed by Black in 1972. *Metiamide* was

the next, but both were not found suitable for clinical use. *Cimetidine* was introduced in 1977 and gained wide usage. *Ranitidine*, *famotidine*, *roxatidine*, and many others have been added subsequently. They are primarily used in peptic ulcer and other gastric hypersecretory states and are described in Ch. 46.

H₃ antagonist Though a selective H₃ antagonist thioperamide has been produced, it has not found any clinical utility.

CHAPTER 12

5-Hydroxytryptamine, its Antagonists and Drug Therapy of Migraine

5-HYDROXYTRYPTAMINE (5-HT, Serotonin)

Serotonin was the name given to the vasoconstrictor substance which appeared in the serum when blood clotted and *Enteramine* to the smooth muscle contracting substance present in enterochromaffin cells of gut mucosa. In the early 1950s both were shown to be *5-hydroxytryptamine* (5-HT). About 90% of body's content of 5-HT is localized in the intestines; most of the rest is in platelets and brain. It is also found in wasp and scorpion sting, and is widely distributed in invertebrates and plants (banana, pear, pineapple, tomato, stinging nettle, cowhage).

SYNTHESIS, STORAGE AND DESTRUCTION

5-HT is β -aminoethyl-5-hydroxyindole. It is synthesized from the amino acid tryptophan and degraded primarily by MAO and to a small extent by a dehydrogenase (Fig. 12.1).

There is close parallelism between CAs and 5-HT. The decarboxylase is non-specific, acts on DOPA as well as 5-hydroxytryptophan (5-HTP) to produce NA and 5-HT respectively. Like NA, 5-HT is actively taken up by an amine pump *serotonin transporter* (SERT), a Na^+ dependent carrier, which operates at the membrane of

platelets (therefore, 5-HT does not circulate in free form in plasma) and serotonergic nerve endings. This is inhibited by selective serotonin reuptake inhibitors (SSRIs) and tricyclic antidepressants. Platelets do not synthesize but acquire 5-HT by uptake during passage through intestinal blood vessels. Again like CAs, 5-HT is stored within storage vesicles, and its uptake at the vesicular membrane by *vesicular monoamine transporter* (VMAT-2) is inhibited by reserpine, which causes depletion of CAs as well as 5-HT. The degrading enzyme MAO is also common for both. The isoenzyme MAO-A preferentially metabolizes 5-HT.

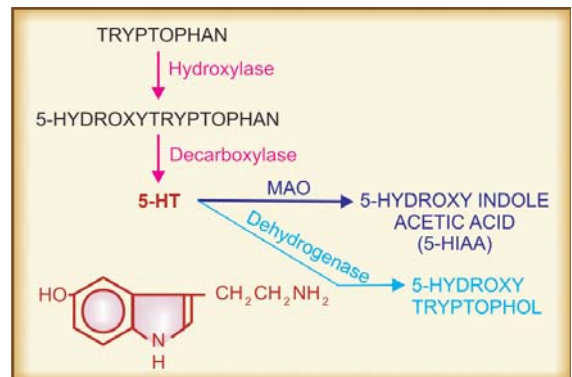

Fig. 12.1: Synthesis and degradation of 5-hydroxytryptamine (5-HT)

SEROTONERGIC (5-HT) RECEPTORS

Gaddum and Picarelli (1957) classified 5-HT receptors into muscletropic (D type) and neurotropic (M type) on the basis of pharmacological criteria. The classical 5-HT antagonists methysergide and cyproheptadine blocked D type receptors. Subsequently 5-HT receptors were differentiated by their high or low affinity for [³H] 5-HT in radioligand binding studies. The present system of classifying 5-HT receptors is based on molecular characterization and cloning of the receptor cDNAs.

Four families of 5-HT receptors (5-HT₁, 5-HT₂, 5-HT₃, 5-HT₄₋₇) comprising of 14 receptor subtypes have so far been recognized. However, only some of these have been functionally correlated or their selective agonists/antagonists defined. Knowledge of subtypes of 5-HT receptors has assumed importance because some newly developed therapeutically useful drugs can only be described as 5-HT receptor subtype selective agonists or antagonists.

All 5-HT receptors (except 5-HT₃) are G protein coupled receptors which function through decreasing (5-HT₁) or increasing (5-HT₄, 5-HT₆, 5-HT₇) cAMP production or by generating IP₃/DAG (5-HT₂) as second messengers. The 5-HT₃ is a ligand gated cation (Na⁺, K⁺) channel which on activation elicits fast depolarization.

5-HT₁ Receptors Five subtypes (5-HT_{1A, B, D, E, F}) have been identified. The 5-HT_{1C} receptor is now designated 5HT_{2c}. All subtypes of 5-HT₁ receptor inhibit adenylyl cyclase; 5-HT_{1A} in addition activates K⁺ channels (resulting in hyperpolarization) and inhibits Ca²⁺ channels. These receptors function primarily as autoreceptors in brain—inhibit firing of 5-HT neurones or release of 5-HT from nerve endings.

The most important location of 5-HT_{1A} receptor are raphe nuclei of brainstem and hippocampus. The anti-anxiety drug *bupirone* acts as a partial agonist of 5-HT_{1A} receptor. The 5-HT_{1D} receptor has been shown to regulate dopaminergic tone in substantia nigra–basal ganglia, and 5-HT_{1B/1D} to cause constriction of cranial blood vessels. The antimigraine drug *sumatriptan* is a selective 5-HT_{1B/1D} agonist. Other functions subserved by 5-HT_{1D} receptors are inhibition of NA release from sympathetic nerve endings and that of inflammatory neuropeptides from nerve endings in cranial blood vessels.

5-HT₂ Receptors There are 3 subtypes of 5-HT₂ receptor; all are coupled to phospholipase C and function through generation of IP₃/DAG. 5-HT_{2A} receptor also inhibits K⁺ channels resulting in slow depolarization of neurones. α -methyl 5-HT is a selective agonist for all 3 subtypes.

5-HT_{2A} is the most widely expressed postjunctional 5-HT receptor (designated earlier as D type) located on vascular and visceral smooth muscle, platelets and cerebral neurones especially prefrontal cortex. It mediates most of the direct actions of 5-HT like vasoconstriction, intestinal, uterine and bronchial contraction, platelet aggregation and activation of cerebral neurones. *Ketanserin* is a 5-HT₂ antagonist more selective for 5-HT_{2A}.

Contraction of rat gastric fundus is mediated by 5-HT_{2B} receptor.

5-HT_{2C} receptor is located on vascular endothelium—elicits vasodilatation through EDRF release. Choroid plexus expresses large number of 5-HT_{2C} receptors.

5-HT₃ Receptor This is the neuronal 5-HT receptor which rapidly depolarizes nerve endings by opening the cation channel located within it and corresponds to the original M type receptor. It mediates the indirect and reflex effects of 5-HT at:

- (i) Somatic and autonomic nerve endings → pain, itch, coronary chemoreflex (bradycardia, fall in BP due to withdrawal of sympathetic tone, respiratory stimulation or apnoea elicited by stimulation of receptors in the coronary bed), other visceral reflexes.
- (ii) Nerve endings in myenteric plexus → augmentation of peristalsis, emetic reflex.
- (iii) Area postrema and nucleus tractus solitarius in brainstem → nausea, vomiting.

Ondansetron is a selective 5-HT₃ antagonist which inhibits vomiting by blocking these receptors in brainstem as well as in gut wall. 2-Methyl 5-HT is a selective 5-HT₃ agonist.

5-HT₄₋₇ Receptors The 5-HT₄ receptor has been demonstrated in the mucosa, plexuses and smooth muscle of the gut → probably involved in augmenting intestinal secretion and peristalsis. It is also located in brain, especially hippocampus and the colliculi where it causes slow depolarization by decreasing K⁺ conductance.

Cisapride and *renzapride* are selective 5-HT₄ agonists.

The recently cloned 5-HT₅, 5-HT₆ and 5-HT₇ receptors are closely related to the 5-HT₄ receptor. These are mainly located in specific brain areas, but their functional role is not known. An interesting finding is that *clozapine* (atypical neuroleptic) has high affinity for 5-HT₆ and 5-HT₇ receptors in addition to being a 5-HT_{2A/2C} antagonist.

ACTIONS

5-HT is a potent depolarizer of nerve endings. It thus exerts direct as well as reflex and indirect

Important 5-HT receptor subtypes

- 5-HT₁:** Autoreceptors; inhibit serotonergic neural activity in brain.
5-HT_{1A}—present in raphe nuclei and hippocampus; buspirone may act through these receptors.
5-HT_{1B/1D}—Constricts cranial blood vessels and inhibits release of inflammatory neuropeptides in them; sumatriptan acts through these receptors.
- 5-HT_{2A}:** Previously D type receptor; most important postjunctional receptor mediating direct actions of 5-HT like vascular and visceral smooth muscle contraction, platelet aggregation, neuronal activation in brain; ketanserin blocks these receptors.
- 5-HT₃:** Previously M type receptor; depolarizes neurones by gating cation channels; elicits reflex effects of 5-HT—emesis, gut peristalsis, bradycardia, transient hypotension, apnoea, pain, itch; ondansetron acts by blocking these receptors.
- 5-HT₄:** Mediate intestinal secretion, augmentation of peristalsis. Renzapride is a selective 5-HT₄ agonist.

effects. Tachyphylaxis is common with repeated doses of 5-HT. The overall effects therefore are often variable.

1. CVS Arteries are constricted (by action on smooth muscle) as well as dilated (through EDRF release) by direct action of 5-HT, depending on the vascular bed and the basal tone. In addition, 5-HT releases Adr from adrenal medulla, affects ganglionic transmission and evokes cardiovascular reflexes. The net effect is complex. Larger arteries and veins are characteristically constricted. In the microcirculation 5-HT dilates arterioles and constricts venules: capillary pressure rises and fluid escapes. The direct action to increase capillary permeability is feeble.

Isolated heart is stimulated by 5-HT: both directly and by release of NA from nerve endings. In intact animals, bradycardia is mostly seen due to activation of coronary chemoreflex (Bezold Jarisch reflex) through action on vagal afferent nerve endings in the coronary bed, evoking bradycardia, hypotension and apnoea.

BP: a triphasic response is classically seen on i.v. injection of 5-HT in animals.

Early sharp fall in BP—due to coronary chemoreflex.

Brief rise in BP—due to vasoconstriction and increased cardiac output.

Prolonged fall in BP—due to arteriolar dilatation and extravasation of fluid.

However, 5-HT is not involved in the physiological regulation of BP.

2. Smooth muscles 5-HT is a potent stimulator of g.i.t., both by direct action as well as through enteric plexuses. Several subtypes of 5-HT receptors are present in the gut (*See box*). Peristalsis is increased and diarrhoea can occur (also due to increased secretion). It constricts bronchi, but is less potent than histamine. Action on other smooth muscles in man are feeble and inconsistent.

5-HT receptor function in the gut

5-HT _{2A}	: intestinal smooth muscle—contraction.
5-HT ₃	: fast depolarization of enteric plexus neurones, release of 5-HT from enterochromaffin cells.
5-HT ₄	: lower esophageal sphincter—contraction, enteric plexus—ACh release—peristalsis, intestinal mucosa—secretion.
5-HT ₁	: slow depolarization of enteric plexus neurones.

3. Glands 5-HT inhibits gastric secretion (both acid and pepsin), but increases mucus production. It thus has ulcer protective property. Effect on other glandular secretions is not significant.

4. Nerve endings and adrenal medulla Afferent nerve endings are activated—tingling and pricking sensation, pain. Depolarization of visceral afferents elicits respiratory and cardiovascular reflexes, nausea and vomiting. 5-HT is less potent than histamine in releasing CAs from adrenal medulla.

5. Respiration A brief stimulation of respiration (mostly reflex from bronchial afferents) and hyperventilation are the usual response, but large doses can cause transient apnoea through coronary chemoreflex.

6. Platelets 5-HT causes changes in shape of platelets and is a weak aggregator through 5-HT_{2A} receptors. However, it does not induce the release reaction.

7. CNS Injected i.v., 5-HT does not produce central effects because it poorly crosses blood-brain barrier. However, it serves as a transmitter, primarily inhibitory. Direct injection in the brain produces sleepiness, changes in body temperature, hunger and a variety of behavioural effects.

PATHOPHYSIOLOGICAL ROLES

1. Neurotransmitter 5-HT is a confirmed neurotransmitter in the brain; brain 5-HT has a fast turnover rate. Cells containing 5-HT are present in the raphe nuclei of brainstem, substantia nigra and few other sites—send axons rostrally (to limbic system, cortex and neostriatum) as well as caudally to spinal cord. 5-HT is probably involved in sleep, temperature regulation, thought, cognitive function, behaviour and mood (imbalance may result in affective disorders and schizophrenia), vomiting and pain perception. Some serotonergic fibres are present in intestines also.

2. Precursor of melatonin in pineal gland. It is believed to regulate biological clock and maintain circadian rhythm.

3. Neuroendocrine function The hypothalamic neurones that control release of anterior pituitary hormones are probably regulated by serotonergic mechanism.

4. Nausea and vomiting Especially that evoked by cytotoxic drugs or radiotherapy is mediated by release of 5-HT and its action on 5-HT₃ receptors in the gut, area postrema and nucleus tractus solitarius.

5. Migraine 5-HT is said to initiate the vasoconstrictor phase of migraine and to participate in neurogenic inflammation of the affected blood vessels. Methysergide (5-HT antagonist) is an effective prophylactic and sumatriptan (5-HT_{1B/1D} agonist) can control an attack. However, the role of 5-HT in this condition is not precisely known.

6. Haemostasis Platelets release 5-HT during aggregation at the site of injury to blood vessel. Acting in concert with collagen and other mediators, this 5-HT accelerates platelet aggregation and clot formation. Thus, it serves to amplify the response. Its contractile action appears to promote retraction of the injured vessel. Both the above actions contribute to haemostasis.

7. Raynaud's phenomenon Release of 5-HT from platelets may trigger acute vasospastic episodes of larger arteries. Ketanserin has prophylactic value in Raynaud's.

8. Variant angina Along with thromboxane A₂, 5-HT released from platelets has been implicated in causing coronary spasm and variant angina. However, the inefficacy of anti 5-HT drugs in this condition points to involvement of other mediators.

9. Hypertension Increased responsiveness to 5-HT as well as its reduced uptake and clearance by platelets has been demonstrated in hypertensive patients. Ketanserin has antihypertensive property. 5-HT has been held responsible for preeclamptic rise in BP.

10. Intestinal motility Enterochromaffin cells and 5-HT containing neurones may regulate peristalsis and local reflexes in the gut. This system appears to be activated by intestinal distension and vagal efferent activity.

11. Carcinoid syndrome The carcinoid tumours produce massive quantities of 5-HT. Bowel hyper-

motility and bronchoconstriction in carcinoid is due to 5-HT but flushing and hypotension are probably due to other mediators. Pellagra may occur due to diversion of tryptophan for synthesizing 5-HT.

DRUGS AFFECTING 5-HT SYSTEM

1. **5-HT precursor** Tryptophan increases brain 5-HT and produces behavioural effects because tryptophan hydroxylase in brain is not saturated by the amount of tryptophan available physiologically.

2. **Synthesis inhibitor** p-Chlorophenylalanine (PCPA) selectively inhibits tryptophan hydroxylase (rate limiting step) and reduces 5-HT level in tissues. It is not used clinically due to high toxicity.

3. **Uptake inhibitor** Tricyclic antidepressants inhibit 5-HT uptake along with that of NA. Some like fluoxetine, sertraline are selective serotonin reuptake inhibitors (SSRI).

4. **Storage inhibitor** Reserpine blocks 5-HT (as well as NA) uptake into storage granules and causes depletion of all monoamines. Fenfluramine selectively releases 5-HT and has anorectic property.

5. **Degradation inhibitor** Nonselective MAO inhibitor (tranylcypromine) and selective MAO-A inhibitor (chlorgyline) increase 5-HT content by preventing its degradation.

6. **Neuronal degeneration** 5, 6 dihydroxytryptamine selectively destroys 5-HT neurones.

7. **5-HT receptor agonists** A diverse range of compounds producing a variety of actions have been found to activate one or more subtypes of 5-HT receptors. Notable among these are:

(i) *D-Lysergic acid diethyl amide (LSD)*—Synthesized as an ergot derivative LSD was found to be an extremely potent hallucinogen. It is a nonselective 5-HT agonist—activates many subtypes of 5-HT receptors including 5-HT_{1A} on raphe cell bodies, 5-HT_{2A/2C} (probably responsible for the hallucinogenic effect) and 5-HT_{5,7} in specific brain areas. However, it antagonizes 5-HT_{2A} receptors in the ileum. A number of other hallucinogens also interact with brain 5-HT receptors.

(ii) *Azapirones* like buspirone, gepirone and ipsapirone are a new class of antianxiety drugs which do not produce sedation. They act as partial agonists of 5-HT_{1A} receptors in the brain.

(iii) *8-Hydroxydipropylamino tetraline (8-OH DPAT)* is a highly selective 5-HT_{1A} agonist which is used only as an experimental tool.

(iv) *Sumatriptan* and other triptans are selective 5-HT_{1B/1D} agonists, constrict cerebral blood vessels and have emerged as the most effective treatment of acute migraine attacks.

(v) *Cisapride* This prokinetic drug which increases gastrointestinal motility is a selective 5-HT₄ agonist. Renzapride is still more selective for 5-HT₄ receptors.

(vi) *m-chlorophenyl piperazine (mCPP)* It is an active metabolite of the antidepressant drug trazodone; found to be an agonist of 5-HT_{1B} as well as 5-HT_{2A/2C} receptors in the brain. In human volunteers it induces anxiety and enhances release of prolactin, ACTH, and growth hormone.

8. **5-HT receptor antagonists** A variety of drugs block serotonergic receptors; many are nonselective, but some newer ones are highly subtype selective.

5-HT ANTAGONISTS

The ability to antagonize at least some actions of 5-HT is found in many classes of drugs, e.g. ergot derivatives (ergotamine, LSD, 2-bromo LSD, methysergide), adrenergic α blockers (phenoxybenzamine), antihistaminics (cyproheptadine, cinnarizine), chlorpromazine, morphine, etc., but these are nonselective and interact with several other receptors as well. Many are partial agonists or antagonize certain actions of 5-HT but mimic others. The salient features of drugs which have been used clinically as 5-HT antagonists and some newly developed selective antagonists are described below:

1. **Cyproheptadine** It primarily blocks 5-HT_{2A} receptors and has additional H₁ antihistaminic, anticholinergic and sedative properties. Like other antihistaminics, it has been used in allergies and is a good antipruritic, but the anti 5-HT action has no role in these conditions. It increases appetite and has been recommended in children and poor eaters to promote weight gain. An action on growth hormone secretion has been suggested to account for this.

The anti 5-HT activity of cyproheptadine has been utilized in controlling intestinal manifestations of carcinoid and postgastrectomy dumping syndromes as well as in antagonizing priapism/orgasmic delay caused by 5-HT uptake inhibitors like fluoxetine and trazodone.

Side effects drowsiness, dry mouth, confusion, ataxia, weight gain.

2. **Methysergide** It is chemically related to ergot alkaloids; antagonizes action of 5-HT on smooth muscles including that of blood vessels, without producing other ergot like effects: does not interact with α adrenergic or dopamine receptors. Methysergide is a potent 5-HT_{2A/2C}

antagonist with some tissue specific agonistic actions as well; but is nonselective—acts on 5-HT₁ receptors also. It has been used for migraine prophylaxis, carcinoid and postgastrectomy dumping syndrome. Prolonged use has caused abdominal, pulmonary and endocardial fibrosis, because of which it has gone into disrepute.

3. Ketanserin It has selective 5-HT₂ receptor blocking property with negligible action on 5-HT₁, 5-HT₃ and 5-HT₄ receptors and no partial agonistic activity. Among 5-HT₂ receptors, blockade of 5-HT_{2A} is stronger than 5-HT_{2C} blockade. 5-HT induced vasoconstriction, platelet aggregation and contraction of airway smooth muscle are antagonized but not contraction of guinea pig ileum or rat stomach. It has additional weak α_1 , H₁ and dopaminergic blocking activities.

Ketanserin is an effective antihypertensive, but α_1 adrenergic blockade appears to be causative rather than 5-HT_{2A} blockade.

Trials of Ketanserin in vasospastic conditions have shown symptomatic improvement only in Raynaud's disease.

Ritanserin is a relatively more 5-HT_{2A} selective congener of ketanserin.

4. Clozapine In addition to being a dopaminergic antagonist (weaker than the typical neuroleptics), this atypical antipsychotic is a 5-HT_{2A/2C} blocker (see Ch. 32). Clozapine may also exert inverse agonist activity at cerebral 5-HT_{2A/2C} receptors which may account for its efficacy in resistant cases of schizophrenia.

5. Risperidone This atypical antipsychotic is a combined 5-HT_{2A} + dopamine D2 antagonist, similar to clozapine. Like the latter, it especially ameliorates negative symptoms of schizophrenia, but produces extrapyramidal side effects at only slightly higher doses.

Other atypical antipsychotics like *olanzapine* and *quetiapine* are also combined 5-HT and DA antagonists, but interact with other neurotransmitter receptors as well.

6. Ondansetron It is the prototype of the new class of selective 5-HT₃ antagonists that have shown remarkable efficacy in controlling nausea and vomiting following administration of highly emetic anticancer drugs and radiotherapy. It is described in Ch. 47.

Granisetron and *Tropisetron* are the other selective 5-HT₃ antagonists.

ERGOT ALKALOIDS

Ergot is a fungus *Claviceps purpurea* which grows on rye, millet and some other grains. The grain is replaced by a purple, hard, curved body called 'sclerotium'. Epidemics of ergot poisoning (ergotism), due to consumption of contaminated grains, have been recorded from the beginning of history. It still occurs in epidemic and sporadic forms. Dry gangrene of hands and feet which become black (as if burnt) is the most prominent feature. Miscarriages occur in women and cattle. A convulsive type is also described.

Ergot had been used by midwives to quicken labour since the middle ages. This use received medical sanction in the 19th century, but its dangers were recognized by the beginning of the present century and then it was advocated only after delivery. Dale and Barger (1906 onwards) isolated the ergot alkaloids and studied their pharmacology. Ergometrine was isolated in 1935.

Ergot contains a host of pharmacologically active substances—alkaloids, LSD, histamine, ACh, tyramine and other amines, sterols, etc.

Natural ergot alkaloids These are tetracyclic indole containing compounds which may be considered as derivatives of *lysergic acid*. They are divided into—

- Amine alkaloid* Ergometrine (Ergonovine): which is oxytocic
- Amino acid alkaloids* Ergotamine, Ergotoxine (mixture of ergocristine + ergocornine + ergocryptine): they are vasoconstrictor and α adrenergic blocker.

Other semisynthetic derivatives

- Dihydroergotamine (DHE), Dihydroergotoxine (Codergocrine): are antiadrenergic, cerebroactive.
- 2-Bromo- α -ergocryptine (Bromocriptine): is a dopaminergic agonist (see Ch. 17).
- Methysergide: it is mainly anti 5-HT.

Synthetic non-lysergic acid derivatives which pharmacologically resemble ergot alkaloids are — Lisuride, Pergolide, Lergotril and Metergoline.

The ergot alkaloid related compounds have diverse pharmacological properties. They act as agonists, partial agonists and antagonists on certain subtypes of α adrenergic, serotonergic and dopaminergic receptors in a tissue specific manner.

Actions

Ergotamine It acts as a partial agonist and antagonist at α adrenergic and all subtypes of 5-HT₁ and 5-HT₂ receptors, but does not interact with 5-HT₃ or dopamine receptors: produces sustained vasoconstriction, visceral smooth muscle contraction, vasomotor centre depression and antagonizes the action of NA and 5-HT on smooth muscles. The overall effect of oral/rectal doses of ergotamine on BP is insignificant. It is a potent emetic (through CTZ) and moderately potent oxytocic. At high doses CNS stimulation and paresthesias may be experienced. On chronic exposure (ergot poisoning) vasoconstriction is accompanied by damage to capillary endothelium—thrombosis, vascular stasis and gangrene.

Dihydroergotamine (DHE) Hydrogenation of ergotamine reduces serotonergic and α -adrenergic agonistic actions, but enhances α -receptor blocking property. Consequently DHE is a less potent vasoconstrictor; primarily constricts capacitance vessels and causes less intimal damage. It is a weaker emetic and oxytocic, but has some antidopaminergic action as well.

Dihydroergotoxine (Codergocrine) This hydrogenated mixture of ergotoxine group of alkaloids is a more potent α blocker and a very weak vasoconstrictor. In the brain, a variety of partial agonistic/antagonistic actions on 5-HT receptors, metabolic and vascular effects and enhancement of ACh release in cerebral cortex have been demonstrated. It has been advocated for treatment of dementia (see Ch. 35).

Bromocriptine The 2 bromo derivative of ergocryptine is a relatively selective dopamine D₂ agonist on pituitary lactotropes (inhibits prolactin

release), in striatum (antiparkinsonian) and in CTZ (emetic—but less than ergotamine). In certain brain areas weak antidopaminergic action has also been shown. It has very weak anti 5-HT or α blocking actions and is not an oxytocic.

Ergometrine (Ergonovine) This amine ergot alkaloid has very weak agonistic and practically no antagonistic action on α adrenergic receptors: vasoconstriction is not significant. Partial agonistic action on 5-HT receptors has been demonstrated in uterus, placental and umbilical blood vessels and in certain brain areas. It is a moderately potent 5-HT₂ antagonist in g.i. smooth muscle and a weak dopaminergic agonist on the pituitary lactotropes as well as CTZ; emetic potential is low. The most prominent action is contraction of myometrium; used exclusively in obstetrics (see Ch. 23).

Pharmacokinetics Oral bioavailability of amino acid ergot alkaloids and their hydrogenated derivatives is poor (< 1%) due to slow and incomplete absorption as well as high firstpass metabolism. Bioavailability is better after sublingual and rectal administration, but still often erratic. They are metabolized in liver and excreted primarily in bile. Ergotamine is sequestered in tissues—produces longer lasting actions compared to its plasma t_{1/2} of 2 hours. Ergot alkaloids effectively cross blood-brain barrier.

Adverse effects Nausea, vomiting, abdominal pain, muscle cramps, weakness, paresthesias, coronary and other vascular spasm, chest pain are the frequent side effects. These drugs are contraindicated in presence of sepsis, ischaemic heart disease, peripheral vascular disease, hypertension, pregnancy, liver and kidney disease.

Preparations and dose

Ergotamine: For migraine 1–3 mg oral/sublingual, repeat as required (max 6 mg in a day); rarely 0.25–0.5 mg i.m. or s.c.; **ERGOTAMINE, GYNERGEN, INGAGEN 1 mg tab, 0.5 mg/ml and 1 mg/ml inj.**

Dihydroergotamine: For migraine 2–6 mg oral (max 10 mg/day), 0.5–1 mg i.m., s.c. repeat hourly (max 3 mg); **DIHYDERGOT, DHE 1 mg tab, MIGRANIL 1 mg/ml inj.** Also used for postural hypotension, herpes zoster, mumps.

Dihydroergotoxine (codergocrine) For dementia 1–1.5 mg oral or sublingual, 0.15–0.6 mg i.m., **HYDERGINE 1.5 mg tab**, **CERELOID 1 mg tab**.

DRUG THERAPY OF MIGRAINE

Migraine is a mysterious disorder characterized by pulsating headache, usually restricted to one side, which comes in attacks lasting 4–48 hours and is often associated with nausea, vomiting, sensitivity to light and sound, flashes of light, vertigo, loose motions and other symptoms. Two major types are—*migraine with aura* (classical migraine) in which headache is preceded by visual or other neurological symptoms, and *migraine without aura* (common migraine). Pulsatile dilatation of certain large cranial vessels is the immediate cause of pain. The pathogenic mechanisms are not well understood. The *Vascular theory* holds that initial vasoconstriction or shunting of blood through carotid arterio-venous anastomoses produces cerebral ischaemia and starts the attack. The *Neurogenic theory* considers it to be a spreading depression of cortical electrical activity followed by vascular phenomena. Some triggering event appears to produce neurogenic inflammation of the affected blood vessel wall which is amplified by retrograde transmission in the afferent nerves and release of mediators like 5-HT, neurokinin, substance P, calcitonin gene related peptide (CGRP), nitric oxide, etc.

Changes in blood/urinary levels of 5-HT and its metabolites during migraine attack, its precipitation by 5-HT releasers and efficacy of drugs having actions in the serotonergic system to prevent/abort/terminate migraine attacks suggests a pivotal role of 5-HT in this disorder.

Drug therapy of migraine has to be individualized: severity and frequency of attacks and response of individual patients to drugs used earlier determine the choice. The strategy mostly adopted is summarized in the box.

Mild migraine Cases having fewer than one attack per month of throbbing but tolerable headache lasting upto 8 hours which does not incapacitate the individual may be classified as mild migraine.

(i) **Simple analgesics** like paracetamol (0.5–1 g) or aspirin (300–600 mg) taken at the first indication of an attack and repeated 4–6 hourly abort and suppress most mild attacks.

(ii) **Nonsteroidal antiinflammatory drugs (NSAIDs) and their combinations** Drugs like ibuprofen (400–800 mg 8 hourly), naproxen (500 mg followed by 250 mg 8 hourly), diclofenac (50 mg 8 hourly), mephenamic acid (500 mg 8 hourly), indomethacin (50 mg 6–8 hourly) either alone or combined with paracetamol/codeine/diazepam or another sedative/diphenhydramine or another antihistaminic/caffeine are found more satisfactory by some patients. These drugs are more effective in migraine without aura, but certain patients of migraine with aura also prefer them over ergot alkaloids. Drugs are taken only till the attack passes off. Taken in the prodromal stage they also have a prophylactic effect, but long-term treatment on a regular schedule to ward off migraine attacks is not advised.

(iii) **Antiemetics** Gastric stasis occurs during migraine which delays absorption of oral drugs. Metoclopramide (10 mg oral/i.m.) is frequently used: relieves nausea, vomiting and gastric stasis. Domperidone (10–20 mg oral) and prochlorperazine (10–25 mg oral/i.m.) are also effective. Diphenhydramine or promethazine exert sedative as well as antiemetic action.

Drug therapy of migraine

Severity	Drug therapy
Mild	: Simple analgesics/NSAIDs or their combinations (\pm antiemetic)
Moderate	: NSAIDs combinations/ergot alkaloids/sumatriptan (+ antiemetic)
Severe	: Ergot alkaloids/sumatriptan/rizatriptan (+ antiemetic) + Prophylaxis
	<ul style="list-style-type: none"> • Propranolol/other β blockers • Amitriptyline/other tricyclic antidepressants • Flunarizine/other Ca^{2+} channel blockers • Valproate/topiramate • Methysergide/cyproheptadine

Moderate migraine Migraine may be labelled as moderate when the throbbing headache is more intense, lasts for 6–24 hours, nausea/vomiting and other features are more prominent and the patient is functionally impaired. One or more attacks occur per month.

Simple analgesics are usually not effective, but stronger NSAIDs or their combinations mentioned above are beneficial in many cases. The remaining are treated with an ergot preparation or sumatriptan. Antiemetics are almost regularly needed. Prophylactic therapy is advised only when attacks are more frequent than 2–3 per month.

Severe migraine These patients suffer 2–3 or more attacks per month of severe throbbing headache lasting 12–48 hours, often accompanied by vertigo, vomiting and other symptoms; the subject is grossly incapacitated during the attack.

Analgesics/NSAIDs and their combinations usually do not afford adequate relief—specific drugs like ergot alkaloids/sumatriptan have to be prescribed along with antiemetics. Prophylactic regimens lasting 6 months or more are recommended.

Ergotamine It is the most effective ergot alkaloid for migraine. Given early in attack, relief is often dramatic and lower doses suffice, but when pain has become severe—larger doses are needed and control may be achieved only after few hours. Oral/sublingual route is preferred, 1 mg is given at half hour intervals till relief is obtained or a total of 6 mg is given. Parenteral administration, though rapid in action is more hazardous.

Ergotamine acts by constricting the dilated cranial vessels and/or by specific constriction of carotid A-V shunt channels. Ergotamine and DHE have also been shown to reduce neurogenic inflammation and leakage of plasma in duramater that occurs due to retrograde stimulation of perivascular afferent nerves. These actions appear to be mediated through partial agonism at 5-HT_{1B/1D} receptors in and around cranial vessels.

Dihydroergotamine (DHE) It is nearly as effective as ergotamine and preferred for parenteral administration because injected DHE is less hazardous.

Because of erratic oral absorption, frequent side effects, especially nausea and vomiting, and availability of triptans, ergot preparations are not preferred now, except for considerations of cost. Ergot alkaloids have no prophylactic value: regular use is not justified—may itself produce a dull background headache and an attack may be precipitated on discontinuation. *Caffeine* 100 mg taken with ergotamine enhances its absorption from oral and rectal routes and adds to the cranial vasoconstricting action. Many combination preparations are available.

MIGRANIL: Ergotamine 1 mg, caffeine 100 mg, belladonna dry ext 10 mg, paracetamol 250 mg tab.

MIGRIL: Ergotamine 2 mg, caffeine 100 mg, cyclizine 50 mg tab.

VASOGRAIN: Ergotamine 1 mg, caffeine 100 mg, paracetamol 250 mg, prochlorperazine 2.5 mg tab.

ERGOPHEN: Ergotamine 0.3 mg, belladonna dry ext. 10 mg, phenobarbitone 20 mg tab.

SELECTIVE 5-HT_{1B/1D} AGONISTS

These are a new class of antimigraine drugs that selectively activate 5-HT_{1B/1D} receptors, and are called 'triptans'. Currently, they are the preferred drugs for patients who fail to respond to analgesics. Ergot alkaloids are now required only in few cases. Because these drugs have been designed to act on the same subtype of 5-HT receptor, pharmacodynamic differences among them are minor, but there are significant pharmacokinetic differences. All have higher oral bioavailability than sumatriptan. Fewer headache recurrences in an attack are reported with naratriptan and frovatriptan due to their longer $t_{1/2}$, but may be slower in affording initial pain relief.

Sumatriptan It is the first selective 5-HT_{1B/1D} receptor agonist; activates other subtypes of 5-HT₁ receptors only at very high concentrations, and does not interact with 5-HT₂, 5-HT₃, 5-HT₄₋₇, α or β adrenergic, dopaminergic, cholinergic or

GABA receptors. Administered at the onset of an attack of migraine, sumatriptan is as effective and better tolerated than ergotamine. About 3/4 patients obtain complete/significant relief within 2–3 hours. However, recurrence of headache within 24 hr has been noted in 20–40% patients, probably due to short $t_{1/2}$ of sumatriptan. It tends to suppress nausea and vomiting of migraine, while ergotamine accentuates these symptoms.

The antimigraine activity of sumatriptan has been ascribed to 5-HT_{1B/1D} receptor mediated constriction of dilated cranial extracerebral blood vessels, especially the arterio-venous shunts in the carotid artery, which express 5-HT_{1B/1D} receptors. Dilatation of these shunt vessels during migraine attack is believed to divert blood flow away from brain parenchyma. In addition it can reduce 5-HT and inflammatory neuropeptide release around the affected vessels as well as extravasation of plasma proteins across dural vessels. Like ergotamine, the triptans have been found to suppress neurogenic inflammation of cranial vessels. Suppression of impulse transmission in the trigeminovascular system has also been implicated.

Pharmacokinetics: Sumatriptan is absorbed rapidly and completely after s.c. injection. Oral bioavailability averages 15%. It is rapidly metabolized by MAO-A isoenzyme and metabolites are excreted in urine; elimination $t_{1/2}$ is ~2 hours.

Side effects: to sumatriptan are usually mild. Tightness in head and chest, feeling of heat and other paresthesias in limbs, dizziness, weakness are short lasting, but dose related side effects.

These are more common after s.c. injection, which is painful. Slight rise in BP occurs, but has little clinical relevance, because sumatriptan is not a drug for regular use. Bradycardia, coronary vasospasm and risk of myocardial infarction are the serious, but infrequent adverse effects. Few cases of sudden death have been ascribed to sumatriptan. Seizures and hypersensitivity reactions are rare.

Contraindications: are in patients with ischaemic heart disease, hypertension, epilepsy, hepatic or renal impairment and during pregnancy. Patients should be cautioned not to drive.

Sumatriptan and ergotamine should not be administered within 24 hours of each other. Interaction with 5-HT uptake inhibitors, MAO inhibitors and lithium has been reported.

Dose: 50–100 mg oral at the onset of migraine attack, may be repeated once within 24 hours if required. Those not responding to the first dose should not be given the second dose. It is the only triptan available for parenteral use; 6 mg s.c. may be given to patients who cannot take the drug orally or in whom the pain develops very rapidly; acts in 10–20 min and is more consistently effective.

MIGRATAN, 50, 100 mg tabs, SUMINAT 25, 50, 100 mg tab, 60 mg/5 ml inj; SUMITREX 25, 50, 100 mg tab, 6 mg/0.5 ml inj.

Rizatriptan: This congener of sumatriptan is more potent, has higher oral bioavailability with slightly faster onset of action.

Dose: 10 mg; repeat once after 2 hr (if required).

RIZACT 5, 10 mg tab.

Naratriptan, Zolmitriptan, Almotriptan, Frovatriptan and Eletriptan are other triptans used in some countries. Features of some triptans are compared in the box.

Comparative features of triptans

	Suma.	Frova.	Riza.	Nara.	Zolmi.
1. Oral bioavailability (%)	15	25	45	70	40
2. T_{max} * (hr)	1.5–2	2–4	1–1.5	2–3	1.5–2
3. Plasma $t_{1/2}$ (hr)	~2	26	2–3	6	2–3
4. Oral dose (mg)					
Initial	50–100	2.5	5–10	2.5	2.5
Max. in 24 hr	200	5–7.5	20–30	5	10

* T_{max} : Time to peak plasma concentration after oral dosing.

Prophylaxis of migraine

Regular medication to reduce the frequency and/or severity of attacks is recommended for moderate-to-severe migraine when 2–3 or more attacks occur per month. Diverse classes of drugs are used but none is effective in all cases, and none abolishes the attacks totally. It may be prudent to discontinue prophylaxis every 6 months to check whether its continuation is needed or not. It is important to avoid the precipitating factor(s).

(i) ***β-Adrenergic blockers*** Propranolol is the most commonly used drug: reduces frequency as well as severity of attacks in up to 70% patients. Effect is generally seen in 4 weeks and is sustained during prolonged therapy. The starting dose is 40 mg BD, which may be increased up to 160 mg BD if required. The mechanism of action is not clear; that it is due to β adrenergic blockade has been questioned. Other nonselective (timolol) and β_1 selective (metoprolol, atenolol) agents are also effective, but pindolol and others having intrinsic sympathomimetic action are not useful.

(ii) ***Tricyclic antidepressants*** Many tricyclic compounds of which amitriptyline has been most extensively tried (25–50 mg at bed time) reduce migraine attacks. It is effective in many patients but produces more side effects than propranolol. It is not known whether its 5-HT (and other monoamine) uptake blocking property is causally related to the prophylactic effect. The antimigraine effect is independent of antidepressant property, but this class of drugs

are better suited for patients who also suffer from depression.

(iii) ***Calcium channel blockers*** Verapamil was found to reduce migraine attacks, but was judged inferior to propranolol. *Flunarizine* is a relatively weak Ca^{2+} channel blocker that also inhibits Na^+ channels. It is claimed to be as effective as propranolol, but convincing proof is lacking. Frequency of attacks is often reduced, but effect on intensity and duration of attacks is less well documented. It is claimed to be a cerebro-selective Ca^{2+} channel blocker; may benefit migraine by reducing intracellular Ca^{2+} overload due to brain hypoxia and other causes. Side effects are sedation, constipation, dry mouth, hypotension, flushing, weight gain and rarely extrapyramidal symptoms.

Dose: 10–20 mg OD, children 5 mg OD, NOMIGRAIN, FLUNARIN 5 mg, 10 mg caps/tab.

(iv) ***Anticonvulsants*** Valproic acid (400–1200 mg/day) and gabapentin (300–1200 mg/day) have some prophylactic effect in migraine. The newer drug topiramate has recently been approved for migraine prophylaxis. A 50% reduction in the number of attacks in half of the patients was noted in 2 randomized trials. Start with 25 mg OD and gradually increase to 50 mg OD or BD. Efficacy of anticonvulsants in migraine is lower than that of β blockers. They are indicated in patients refractory to other drugs or when propranolol is contraindicated.

(v) ***5-HT antagonists*** The prophylactic effect of methysergide and cyproheptadine is less impressive than β blockers. They are seldom used now for migraine.

CHAPTER 13

Prostaglandins, Leukotrienes (Eicosanoids) and Platelet Activating Factor

PROSTAGLANDINS AND LEUKOTRIENES (Eicosanoids)

Prostaglandins (PGs) and Leukotrienes (LTs) are biologically active derivatives of 20 carbon atom polyunsaturated essential fatty acids that are released from cell membrane phospholipids. They are the major lipid derived autacoids.

In the 1930s human semen was found to contract isolated uterine and other smooth muscle strips and to cause fall in BP in animals. The active principle was termed 'prostaglandin', thinking that it was derived from prostate. Only in the 1960s it was shown to be a mixture of closely related compounds, the chemical structures were elucidated and widespread distribution was revealed. In 1970s it became clear that aspirin like drugs act by inhibiting PG synthesis, and that in addition to the classical PGs (Es and Fs), thromboxane (TX), prostacyclin (PGI) and leukotrienes (LTs) were of great biological importance. Bergstrom, Samuelsson and Vane got the Nobel prize in 1982 for their work on PGs and LTs. Over the past 40 years they have been among the most intensely investigated substances.

CHEMISTRY, BIOSYNTHESIS AND DEGRADATION

Chemically, PGs may be considered to be derivatives of *prostanoic acid*, though prostanoic acid does not naturally occur in the body. It has a five membered ring and two side chains projecting in opposite directions at right angle to the plane of the ring. There are many series of PGs and

thromboxanes (TXs) designated A, B, C....I, depending on the ring structure and the substituents on it. Each series has members with subscript 1, 2, 3 indicating the number of double bonds in the side chains.

Leukotrienes are so named because they were first obtained from leukocytes (*leuko*) and have 3 conjugated double bonds (*triene*). They have also been similarly designated A, B, C.....F and given subscripts 1, 2, 3, 4.

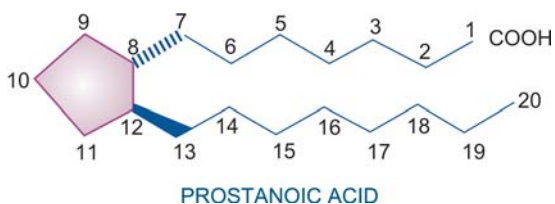

In the body PGs, TXs and LTs are all derived from eicosa (referring to 20 C atoms) tri/tetra/penta enoic acids. Therefore, they can be collectively called *eicosanoids*. In human tissues, the fatty acid released from membrane lipids in largest quantity is 5,8,11,14 *eicosa tetraenoic acid* (*arachidonic acid*). During PG, TX and prostacyclin synthesis, 2 of the 4 double bonds of arachidonic acid get saturated in the process of cyclization, leaving 2 double bonds in the side chain. Thus, subscript 2 PGs are most important in man, e.g.

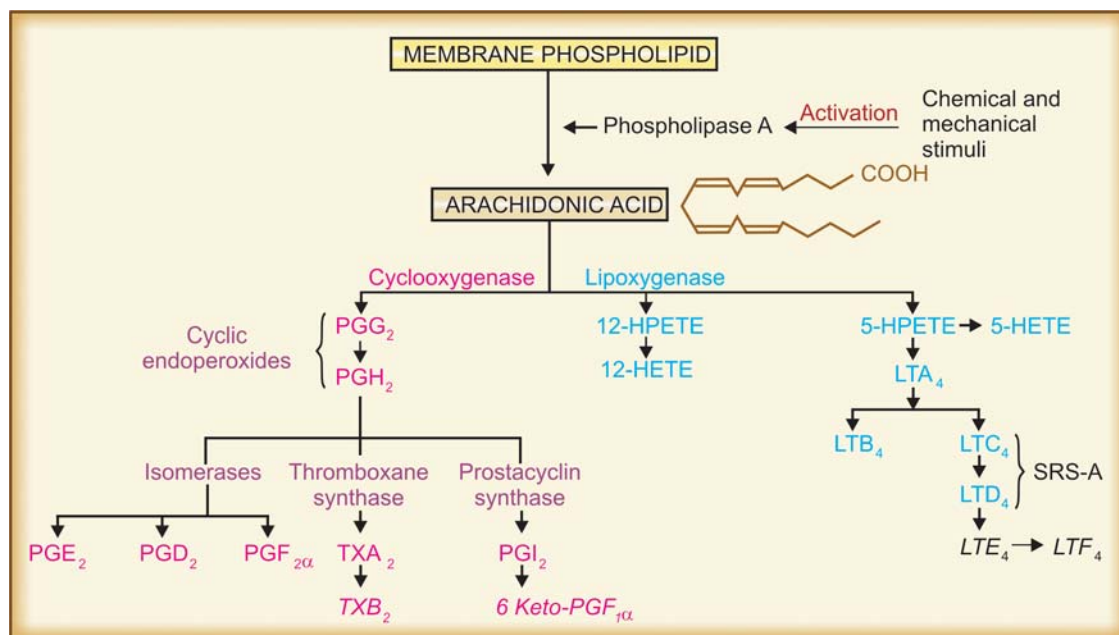

Fig. 13.1: Biosynthesis of prostaglandins (PG) and leukotrienes (LT). Less active metabolites are shown in italics TX—Thromboxane, PGI—Prostacyclin; HPETE—Hydroperoxy eicosatetraenoic acid (Hydroperoxy arachidonic acid); HETE—Hydroxyeicosatetraenoic acid (Hydroxy arachidonic acid); SRS-A—Slow reacting substance of anaphylaxis

PGE₂, PGF_{2α}, PGI₂, TXA₂. No cyclization or reduction of double bonds occurs during LT synthesis—the LTs of biological importance are LTB₄, LTC₄, LTD₄.

Eicosanoids are the most universally distributed autacoids in the body. Practically every cell and tissue is capable of synthesizing one or more types of PGs or LTs. The pathways of biosynthesis of eicosanoids are summarized in Fig. 13.1.

There are no preformed stores of PGs and LTs. They are synthesized locally at rates governed by the release of arachidonic acid from membrane lipids in response to appropriate stimuli. These stimuli activate hydrolases, including phospholipase A, probably through increased intracellular Ca²⁺.

The *cyclooxygenase* (COX) pathway generates eicosanoids with a ring structure (PGs, TXs, prostacyclin) while *lipoxygenase* (LOX) produces open chain compounds (LTs). All tissues have COX—can form cyclic endoperoxides PGG₂ and PGH₂ which are unstable compounds. Further

course in a particular tissue depends on the type of isomerases or other enzymes present in it. PGE₂ and PGF_{2α} are the primary prostaglandins (name based on the separation procedure: PGE partitioned into *Ether* while PGF into phosphate [*Fosfat* in Swedish] buffer; α in PGF_{2α} refers to orientation of OH group on the ring). PGs A, B and C are not found in the body: they are artifacts formed during extraction procedures. Lung and spleen can synthesize the whole range of COX products. Platelets primarily synthesize TXA₂ which is—chemically unstable, spontaneously changes to TXB₂. Endothelium mainly generates prostacyclin (PGI₂); also chemically unstable and rapidly converts to 6-keto PGF_{1α}.

Cyclooxygenase is now known to exist in two isoforms COX-1 and COX-2. While both isoforms catalyse the same reactions, COX-1 is a constitutive enzyme in most cells—its activity is not changed once the cell is fully grown. On the other hand, COX-2 normally present in insignificant amounts, is inducible by cytokines, growth factors

and other stimuli during the inflammatory response. It is believed that eicosanoids produced by COX-1 participate in physiological (house keeping) functions such as secretion of mucus for protection of gastric mucosa, haemostasis and maintenance of renal function, while those produced by COX-2 lead to inflammatory and other pathological changes. However, certain sites in kidney and brain constitutively express COX-2 which may play physiological role.

A splice variant of COX-1 (designated COX-3) has been found in the dog brain. This isoenzyme is inhibited by paracetamol, but its role in humans is not known.

Lipoxygenase pathway appears to operate mainly in the lung, WBC and platelets. Its most important products are the LTs, (generated by 5-LOX) particularly LTB₄ (potent chemotactic) and LTC₄, LTD₄ which together constitute the 'slow reacting substance of anaphylaxis' (SRS-A) described in 1938 to be released during anaphylaxis. A membrane associated transfer protein called FLAP (five lipoxygenase activating protein) carries arachidonic acid to 5-LOX, and is essential for the synthesis of LTs. Platelets have only 12-LOX.

HPETEs produced by LOX can also be converted to *hepoxilins*, *trioxilins* and lipoxins. A third enzymatic pathway involving cytochrome P450 can metabolize arachidonic acid into 19- and 20-HETEs and *epoxyeicosatrienoic acids*. Free radicals can attack arachidonic acid to produce *isoprostanes* nonenzymatically. Brain cells couple arachidonic acid with ethanolamine to produce *anandamide* which has cannabinoid like action. The above named metabolites of arachidonic acid have a variety of vascular, inflammatory and other actions, but their pathophysiological role is not clear.

Inhibition of synthesis Synthesis of COX products can be inhibited by nonsteroidal antiinflammatory drugs (NSAIDs). Aspirin acetylates COX at a serine residue and causes irreversible inhibition while other NSAIDs are competitive and reversible inhibitors. Most NSAIDs are nonselective COX-1 and COX-2 inhibitors, but some newer ones like celecoxib, rofecoxib are selective for COX-2.

The sensitivity of COX in different tissues to inhibition by these drugs varies; selective inhibition of formation of some products may be possible

at lower doses. NSAIDs do not inhibit the production of LTs: this may even be increased since all the arachidonic acid becomes available to the LOX pathway.

Zileuton inhibits LOX and decreases the production of LTs. It was used briefly in asthma, but has been withdrawn.

Glucocorticosteroids inhibit the release of arachidonic acid from membrane lipids (by stimulating production of proteins called *annexins* or *lipocortins* which inhibit phospholipase A₂)—indirectly reduce production of all eicosanoids—PGs, TXs and LTs. Moreover, they inhibit the induction of COX-2 by cytokines at the site of inflammation.

Degradation of arachidonates occurs rapidly in most tissues, but fastest in the lungs. Most PGs, TXA₂ and prostacyclin have plasma t_{1/2} of a few seconds to a few minutes. First a specific carrier mediated uptake into cells occurs, the side chains are then oxidized and double bonds are reduced in a stepwise manner to yield inactive metabolites. Metabolites are excreted in urine. PGI₂ is catabolized mainly in the kidney.

ACTIONS AND PATHOPHYSIOLOGICAL ROLES

Prostaglandins, thromboxanes and prostacyclin

The cyclic eicosanoids produce a wide variety of actions depending upon the particular PG (or TX or PGI), species on which tested, tissue, hormonal status and other factors. PGs differ in their potency to produce a given action and different PGs sometimes have opposite effects. Even the same PG may have opposite effects under different circumstances. The actions of PGs and TXA₂ are summarized in Table 13.1. Since virtually all cells and tissues are capable of forming PGs, they have been implicated as mediators or modulators of a number of physiological processes and pathological states.

1. CVS PGE₂ and PGF_{2α} cause vasodilatation in most, but not all, vascular beds. In isolated

preparations, they are more potent vasodilators than ACh or histamine. $\text{PGF}_{2\alpha}$ constricts many larger veins including pulmonary vein and artery. Fall in BP occurs when PGE_2 is injected i.v., but $\text{PGF}_{2\alpha}$ has little effect on BP.

- PGI_2 is uniformly vasodilatory and is more potent hypotensive than PGE_2 .
- TXA_2 consistently produces vasoconstriction.
- PG endoperoxides (G_2 and H_2) are inherently vasoconstrictor, but often produce vasodilatation or a biphasic response due to rapid conversion to other PGs, especially PGI_2 in the blood vessels themselves.
- PGE_2 and $\text{F}_{2\alpha}$ stimulate heart by weak direct but more prominent reflex action due to fall in BP. The cardiac output increases.

Role

- PGI_2 is probably involved in the regulation of local vascular tone as a dilator.
- PGE_2 and PGI_2 are believed to be continuously produced locally in the ductus arteriosus during foetal life—keep it patent; at birth their synthesis is inhibited and closure occurs. Aspirin and indomethacin induce closure when it fails to occur spontaneously. These PGs may also be important in maintaining placental blood flow.
- PGs, along with LTs and other autacoids may mediate vasodilatation and exudation at the site of inflammation.

2. Platelets TXA_2 , which can be produced locally by platelets, is a potent inducer of aggregation and release reaction. The endoperoxides PGG_2 and PGH_2 are also proaggregatory. On the other hand PGI_2 (generated by vascular endothelium) is a potent inhibitor of platelet aggregation. PGD_2 has antiaggregatory action, but much less potent than PGI_2 . PGE_2 has inconsistent effects.

Role TXA_2 produced by platelets and PGI_2 produced by vascular endothelium probably constitute a mutually antagonistic system: preventing aggregation of platelets while in circu-

lation and inducing aggregation on injury, when plugging and thrombosis are needed.

Aspirin interferes with haemostasis by inhibiting platelet aggregation which is due to TXA_2 production. Before it is deacetylated in liver, aspirin acetylates COX in platelets while they are in portal circulation. Further, platelets are unable to regenerate fresh COX (lack nucleus: do not synthesize protein), while vessel wall is able to do so (fresh enzyme is synthesized within hours). Thus, in low doses, aspirin selectively inhibits TXA_2 production and has antithrombotic effect lasting > 3 days.

3. Uterus PGE_2 and $\text{PGF}_{2\alpha}$ uniformly contract human uterus, pregnant as well as nonpregnant *in vivo*. The sensitivity is higher during pregnancy and there is a further modest increase with progress of pregnancy. However, even during early stages uterus is quite sensitive to PGs though not to oxytocin. PGs increase tone as well as amplitude of uterine contractions.

When tested *in vitro*, $\text{PGF}_{2\alpha}$ consistently produces contraction while PGE_2 relaxes nonpregnant but contracts pregnant human uterine strips. At term, PGs at low doses soften the cervix and make it more compliant.

Role

- Foetal tissues produce PGs and at term $\text{PGF}_{2\alpha}$ has been detected in maternal blood. It has been postulated that PGs mediate initiation and progression of labour. Aspirin has been found to delay the initiation of labour and also prolongs its duration.
- Because PGs are present in high concentration in semen and can be rapidly absorbed when lodged in the vagina at coitus, it is believed that they so coordinate movements of the female genital tract that transport of sperms and fertilization is facilitated.
- Dysmenorrhoea in many women is associated with increased PG synthesis by the endometrium. This apparently induces uncoordinated uterine contractions which compress blood vessels → uterine ischaemia → pain. Aspirin group of drugs are

Table 13.1: A summary of the actions of major prostaglandins, prostacyclin and thromboxane

Organ	Prostaglandin E_2 (PGE_2)	Prostaglandin $F_{2\alpha}$ ($PGF_{2\alpha}$)	Prostacyclin (PGI_2)	Thromboxane A_2 (TXA_2)
1. Blood vessels	Vasodilatation, ↓ BP	Vasodilatation (mostly), larger veins constrict, little effect on BP	Vasodilatation (marked and widespread), ↓ ↓ BP	Vasoconstriction
2. Heart	Weak inotropic, reflex cardiac stimulation	Weak inotropic	—	—
3. Platelets	Variable effect	—	Antiaggregatory	Aggregation and release reaction
4. Uterus	Contraction (<i>in vivo</i>), relaxes nonpregnant human uterus <i>in vitro</i> , softening of cervix	Contraction (<i>in vivo</i> and <i>in vitro</i>), softening of cervix	—	—
5. Bronchi	Dilatation, Inhibit histamine release	Constriction	Dilatation (mild), inhibit histamine release	Constriction
6. Stomach	↓ acid secretion, ↑ mucus production	—	↓ acid secretion (weak), mucosal vasodilatation	—
7. Intestine	Contracts longitudinal & relaxes circular muscles, ↑ peristalsis, ↑ Cl^- & water secretion	Spasmogenic, ↑ fluid & electrolyte secretion (weak)	Weak spasmogenic, inhibit toxin-induced fluid secretion	Weak spasmogenic
8. Kidney	Natriuresis, ↓ Cl^- reabsorption, inhibit ADH action, vasodilatation, renin release	—	Natriuresis, vasodilatation, renin release	Vasoconstriction
9. CNS	Pyrogenic, variety of effects on i.c.v. inj.	—	—	—
10. Release of NA nerves	↑ or ↓	↑ or ↓	—	—
11. Afferent nerves	Sensitize to noxious stimuli → tenderness	—	Same as PGE_2	—
12. Endocrine system	Release of ant. pituitary hormones, steroids, insulin; TSH-like action	Release of gonadotropins & prolactin, luteolysis (in animals)	—	—
13. Metabolism	Antilipolytic, insulin like action, mobilization of bone Ca^{2+}	—	—	—

highly effective in relieving dysmenorrhoea in most women.

4. Bronchial muscle $\text{PGF}_{2\alpha}$, PGD_2 and TXA_2 are potent bronchoconstrictors (more potent than histamine) while PGE_2 is a powerful bronchodilator. PGI_2 produces mild dilatation. Asthmatics are more sensitive to constrictor as well as dilator effects of PGs. PGE_2 and PGI_2 also inhibit histamine release and are effective by aerosol—but produce irritation of the respiratory tract and have a brief action.

Role Asthma may be due to an imbalance between constrictor PGs ($\text{F}_{2\alpha}$, PGD_2 , TXA_2) and LTs on one hand and dilator ones (PGE_2 , PGI_2) on the other. In few individuals aspirin-like drugs consistently induce asthma, possibly by diverting arachidonic acid to produce excess LTC_4 and D_4 . This sensitivity is not shared by selective COX-2 inhibitors, indicating that suppression of COX-1 at the pulmonary site is responsible for the reaction. In allergic human asthma, LTs are more important and COX inhibitors are without any effect in most patients.

5. GIT (i) In isolated preparations, the longitudinal muscle of gut is contracted by PGE_2 and $\text{PGF}_{2\alpha}$ while the circular muscle is either contracted (usually by $\text{PGF}_{2\alpha}$) or relaxed (usually by PGE_2). Propulsive activity is enhanced in man, especially by PGE_2 → colic and watery diarrhoea are important side effects. PGE_2 acts directly on the intestinal mucosa and increases water, electrolyte and mucus secretion. PGI_2 does not produce diarrhoea and in fact opposes PGE_2 and toxin induced fluid movement.

Role PGs may be involved in mediating toxin induced increased fluid movement in secretory diarrhoeas. In certain diarrhoeas, aspirin can reduce stool volume, but is not uniformly effective. PGs appear to play a role in the growth of colonic polyps and cancer. Association of low incidence of colon cancer with regular intake of aspirin is now established. NSAIDs afford relief in familial colonic polyposis by reducing polyp formation.

(ii) PGE_2 markedly reduces acid secretion in the stomach. Volume of juice and pepsin content are also decreased. It inhibits fasting as well as stimulated secretion (by feeding, histamine, gastrin). The gastric pH may rise up to 7.0. PGI_2 also inhibits gastric secretion, but is less potent. Secretion of mucus in stomach and mucosal blood flow are increased; PGs are antiulcerogenic.

Role PGs (especially PGI_2) appear to be involved in the regulation of gastric mucosal blood flow. They may be functioning as natural ulcer protectives by enhancing gastric mucus production. The ulcerogenic action of NSAIDs may be due to loss of this protective influence.

Normally, gastric mucosal PGs are produced by COX-1. Selective COX-2 inhibitors are less ulcerogenic. However, COX-2 gets induced during ulcer healing, and COX-2 inhibitors have the potential to delay healing.

6. Kidney PGE_2 and PGI_2 increase water, Na^+ and K^+ excretion and have a diuretic effect. PGE_2 has been shown to have a furosemide-like inhibitory effect on Cl^- reabsorption as well. They cause renal vasodilatation and inhibit tubular reabsorption. PGE_2 antagonizes ADH action, and this adds to the diuretic effect. In contrast, TXA_2 causes renal vasoconstriction. PGI_2 , PGE_2 and PGD_2 evoke release of renin.

Role

- (i) PGs appear to function as intrarenal regulators of blood flow as well as tubular reabsorption in kidney. The NSAIDs tend to retain salt and water. The diuretic action of furosemide is blunted by indomethacin—indicating a facilitatory role of PGs by increasing renal blood flow and/or augmenting inhibition of tubular reabsorption.
- (ii) Renin release in response to sympathetic stimulation and other influences may be facilitated by PGs.
- (iii) Bartter's syndrome, characterized by decreased sensitivity to angiotensin II is associated with increased PG production; many of the manifestations are improved by prolonged use of NSAIDs.

7. CNS PGs injected i.v. penetrate brain poorly and central effects are not prominent. However, injected intracerebroventricularly PGE₂ produces a variety of effects—sedation, rigidity, behavioral changes and marked rise in body temperature. PGI₂ also induces fever, but TXA₂ is not pyrogenic.

Role

- (i) PGE₂ may mediate pyrogen induced fever and malaise. Aspirin and other inhibitors of PG synthesis are antipyretic. Pyrogens, including cytokines released during bacterial infection, trigger synthesis of PGE₂ in the hypothalamus, which resets the thermostat to cause fever. COX-2 is the major isoenzyme involved; selective COX-2 inhibitors are equally efficacious antipyretics. A role of COX-3 has also been proposed.
- (ii) PGs may be functioning as neuromodulators in the brain by regulating neuronal excitability. A role in pain perception, sleep and some other functions has been suggested.

8. ANS Depending on the PG, species and tissue, both inhibition as well as augmentation of NA release from adrenergic nerve endings has been observed.

Role PGs may modulate sympathetic neurotransmission in the periphery.

9. Peripheral nerves PGs (especially E₂ and I₂) sensitize afferent nerve endings to pain inducing chemical and mechanical stimuli (Fig. 13.2). They irritate mucous membranes and produce long lasting dull pain on intradermal injection.

Role PGs appear to serve as algescic agents during inflammation. They cause tenderness and amplify the action of other algescics. Inhibition of PG synthesis is a major antiinflammatory mechanism. Aspirin injected locally decreases pain produced by injection of bradykinin at the same site.

10. Eye: PGF_{2α} induces ocular inflammation and lowers i.o.t by enhancing uveoscleral outflow.

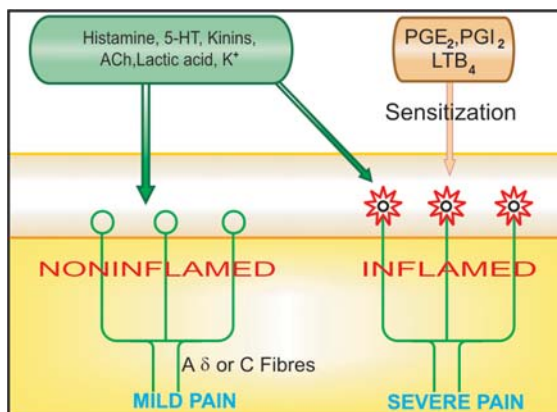

Fig. 13.2: Sensitization of nociceptors (pain receptors) to mediators of pain by prostaglandins at the inflammatory site

Non irritating congeners like *latanoprost* are now first line drugs in wide angle glaucoma.

Role Locally produced PGs appear to facilitate aqueous humor drainage, since COX-2 expression in the ciliary body has been found to be deficient in wide angle glaucoma patients.

11. Endocrine system PGE₂ facilitates the release of anterior pituitary hormones—growth hormone, prolactin, ACTH, FSH and LH as well as that of insulin and adrenal steroids. It has a TSH like effect on thyroid.

PGF_{2α} causes luteolysis and terminates early pregnancy in many mammals, but this effect is not significant in humans. Though PGs can terminate early pregnancy in women, this is not associated with fall in progesterone levels.

12. Metabolism PGEs are antilipolytic, exert an insulin like effect on carbohydrate metabolism and mobilize Ca²⁺ from bone: may mediate hypercalcaemia due to bony metastasis.

Leukotrienes

The straight chain lipoxygenase products of arachidonic acid are produced by a more limited number of tissues (LTB₄ mainly by neutrophils; LTC₄ and LTD₄—the cysteinyl LTs—mainly by macrophages), but probably they are pathophysiologically as important as PGs.

1. CVS and blood LTC₄ and LTD₄ injected i.v. evoke a brief rise in BP followed by a more prolonged fall. The fall in BP is not due to vasodilatation because no relaxant action has been seen on blood vessels. It is probably a result of coronary constriction induced decrease in cardiac output and reduction in circulating volume due to increased capillary permeability. These LTs markedly increase capillary permeability and are more potent than histamine in causing local edema formation. LTB₄ is highly chemotactic for neutrophils and monocytes; this property is shared by HETE but not by other LTs. Migration of neutrophils through capillaries and their clumping at sites of inflammation in tissues is also promoted by LTB₄.

Role LTs are important mediators of inflammation. They are produced (along with PGs) locally at the site of injury. While LTC₄ and D₄ cause exudation of plasma, LTB₄ attracts the inflammatory cells which reinforce the reaction. 5-HPETE and 5-HETE may facilitate local release of histamine from mast cells.

2. Smooth muscle LTC₄ and D₄ contract most smooth muscles. They are potent bronchoconstrictors and induce spastic contraction of g.i.t. at low concentrations.

They also increase mucus secretion in the airways.

Role The cysteinyl LTs (C₄ and D₄) are the most important mediators of human allergic asthma. They are released along with PGs and other autacoids during AG: AB reaction in the lungs. In comparison to other mediators, they are more potent and are metabolized slowly in the lungs, exert a long lasting action. LTs may also be responsible for abdominal colics during systemic anaphylaxis.

3. Afferent nerves Like PGE₂ and I₂, the LTB₄ also sensitizes afferents carrying pain impulses—contributes to pain and tenderness of inflammation.

PROSTANOID RECEPTORS

PGs, TX and prostacyclin act on their own specific receptors located on cell membrane. Five major types of prostanoid receptors have been designated, each after the natural PG for which it has the greatest affinity. This has been supported by receptor cloning. All prostanoid receptors are G-protein coupled receptors which utilize the IP₃/DAG or cAMP transducer mechanisms. Some selective antagonists of prostanoid receptors have been produced. The prostanoid receptors are:

DP Has greatest affinity for PGD₂, but PGE₂ also acts on it; activation increases cAMP which inhibits platelet aggregation.

EP Has greatest affinity for PGE₂; *enprostil* is a selective agonist. It has been subdivided into EP₁ which causes smooth muscle contraction through IP₃/DAG pathway and EP₂ which mediates smooth muscle relaxation by increasing cAMP. Cloning studies have identified two more subtypes EP₃ and EP₄. PGE₂ enhances Cl⁻ and water secretion in intestinal mucosa also by increasing cAMP. However, in some tissues (adipocytes) PGE₂ inhibits cAMP formation—responsible for its antilipolytic action. EP₁ receptors are activated by PGF_{2α} also.

FP Has greatest affinity for PGF_{2α}; *fluprostenol* is a selective agonist. The most prominent effect of activation of this receptor is smooth muscle contraction mediated through IP₃/DAG formation.

IP Has greatest affinity for PGI₂; PGE also acts on it and *cicaprost* is a selective agonist. It functions by activating adenylyl cyclase in platelets (inhibiting aggregation) and smooth muscles (relaxation).

TP Has greatest affinity for TXA₂; PGH₂ also acts on it. It utilizes IP₃/DAG as second messengers which mediate platelet aggregation and smooth muscle contraction.

LEUKOTRIENE RECEPTORS

Separate receptors for LTB₄ (BLT) and for the cysteinyl LTs (LTC₄, LTD₄) have been defined. Two subtypes, *cys*LT₁ and *cys*LT₂ of the cysteinyl LT receptor have been cloned. All LT receptors function through the IP₃/DAG transducer mechanism. The *cys*LT₁ receptor antagonists, *viz.* *Montelukast*, *Zafirlukast*, etc are now valuable drugs for bronchial asthma (*see* Ch. 16).

USES

Clinical use of PGs and their analogues is rather restricted because of limited availability, short lasting action, cost, side effects and other practical considerations. Their approved indications are:

1. Abortion During first trimester, termination of pregnancy by transcervical suction is the pro-

cedure of choice. Intravaginal PGE₂ pessary inserted 3 hours before attempting dilatation can minimise trauma to the cervix by reducing resistance to dilatation.

Medical termination of pregnancy of upto 7 weeks has been achieved with high success rate by administering mifepristone (antiprogestin) 600 mg orally 2 days before a single oral dose of misoprostol 400 µg. Uterine contractions are provoked and the conceptus is expelled within the next few hours. Ectopic pregnancy should be ruled out beforehand and complete expulsion should be confirmed afterwards. Uterine cramps, vaginal bleeding, nausea, vomiting and diarrhoea are the possible complications. Methotrexate administered along with misoprostol is also highly successful in inducing abortion in the first few weeks of pregnancy.

PGs have a place in midterm abortion, missed abortion and molar gestation, though delayed and erratic action and incomplete abortion are a problem. The initial enthusiasm has given way to more considered use. PGs convert the oxytocin resistant midterm uterus to oxytocin responsive one: a single extraamniotic injection (PGE₂) followed by i.v. infusion of oxytocin or intraamniotic (PGF_{2α}) with hypertonic solution produces 2nd trimester abortion in a high percentage without undue side effects. Pretreatment with mifepristone improves the efficacy of PGE as abortifacient.

2. Induction/augmentation of labour PGs do not offer any advantage over oxytocin for induction of labour at term. They are less reliable and show wider individual variation in action. PGE₂ and PGF_{2α} (rarely) have been used in place of oxytocin in toxæmic and renal failure patients, because they do not cause fluid retention. PGE₂ may also be used to augment labour, if it is slow, in primipara. Intravaginal route is preferred now: side effects are milder; extra/intra amniotic route is infrequently used.

3. Cervical priming Applied intravaginally or in the cervical canal, low doses of PGE₂ which do

not affect uterine motility make the cervix soft and compliant. This procedure has yielded good results in cases with unfavourable cervix. If needed labour may be induced 12 hours later with oxytocin: chances of failure are reduced.

4. Postpartum haemorrhage (PPH) Carboprost (15-methyl PGF_{2α}) injected i.m. is an alternative for control of PPH due to uterine atony, especially in patients unresponsive to ergometrine and oxytocin.

PGE₂ (*Dinoprostone*) **PROSTIN-E₂** for induction/augmentation of labour, midterm abortion.

Vaginal gel (1 mg or 2 mg in 2.5 ml) 1 mg inserted into posterior fornix, followed by 1–2 mg after 6 hour if required.

Vaginal tab (3 mg) 3 mg inserted into posterior fornix, followed by another 3 mg if labour does not start within 6 hour.

Extraamniotic solution (10 mg/ml in 0.5 ml amp.) infrequently used.

Intravenous solution (1 mg/ml in 0.75 ml amp., 10 mg/ml in 0.5 ml amp) rarely used.

Oral tablet **PRIMIPROST 0.5 mg tab**, one tab. hourly till induction, max 1.5 mg per hr; rarely used.

Cervical gel **CERVIPRIME (0.5 mg in 2.5 ml prefilled syringe)** 0.5 mg inserted into cervical canal for preinduction cervical softening and dilatation in patients with poor Bishop's score.

Gemeprost **CERVAGEM 1 mg vaginal pessary**: for softening of cervix in first trimester—1 mg 3 hr before attempting dilatation; for 2nd trimester abortion/molar gestation—1 mg every 3 hours, max. 5 doses.

PGF_{2α} (*Dinoprost*) **PROSTIN F₂ ALPHA intraamniotic injection** 5 mg/ml in 4 ml amp. for midterm abortion/induction of labour (rarely used).

15-methyl PGF_{2α} (Carboprost) **PROSTODIN 0.25 mg in 1 ml amp**; 0.25 mg i.m. every 30–120 min for PPH, midterm abortion, missed abortion.

T-PILL + MISO Mifepristone 200 mg tab (3 tabs) + misoprostol 200 µg (2 tabs); mifepristone 3 tab orally followed 2 days later by misoprostol 2 tab orally, for termination of pregnancy of upto 49 days.

5. Peptic ulcer Stable analogue of PGE₁ (misoprostol) is occasionally used for healing peptic ulcer, especially in patients who need continued NSAID therapy or who continue to smoke (see Ch. 46).

6. Glaucoma Topical $\text{PGF}_{2\alpha}$ analogues like *latanoprost* and *isopropyl unoprostone* are one of the first choice drugs in wide angle glaucoma (see p. 146).

7. To maintain patency of ductus arteriosus in neonates with congenital heart defects, till surgery is undertaken. PGE_1 (Alprostadil) is used; apnoea occurs in few cases.

PROSTIN VR 0.5 mg in 1 ml amp; dilute and infuse i.v.

8. To avoid platelet damage PGI_2 (Epoprostenol) can be used to prevent platelet aggregation and damage during haemodialysis or cardiopulmonary bypass. It also improves harvest of platelets for transfusion. Few cases of primary pulmonary hypertension have been successfully maintained on epoprostenol infusion.

FLOLAN 0.5 mg vial for reconstitution.

The other suggested uses of PGs are:

- Peripheral vascular diseases** PGI_2 (or PGE_1) infused i.v. can relieve rest pain and promote ulcer healing in severe cases of intermittent claudication and in Raynaud's disease.
- Impotence** Alprostadil (PGE_1) injected into the penis causes erection lasting 1–2 hours. However, oral sildenafil/tadalafil is now preferred for erectile dysfunction.

SIDE EFFECTS

Side effects are common in the use of PGs, but their intensity varies with the PG, the dose and the route. These are: nausea, vomiting, watery diarrhoea, uterine cramps, unduly forceful uterine contractions, vaginal bleeding, flushing, shivering, fever, malaise, fall in BP, tachycardia, chest pain.

PLATELET ACTIVATING FACTOR (PAF)

Like eicosanoids, platelet activating factor (PAF) is a cell membrane derived polar lipid with intense biological activity; discovered in 1970s and now recognized to be an important signal molecule. PAF is acetyl-glycerol ether-phosphoryl choline.

Synthesis and degradation PAF is synthesized from precursor phospholipids present in cell membrane by the following reactions:

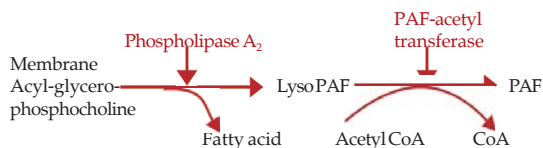

The second step is rate limiting. Antigen-antibody reaction and a variety of mediators stimulate PAF synthesis in a Ca^{2+} dependent manner on demand: there are no preformed stores of PAF. In contrast to eicosanoids, the types of cells which synthesize PAF is quite limited—mainly WBC, platelets, vascular endothelium and kidney cells.

PAF is degraded in the following manner:

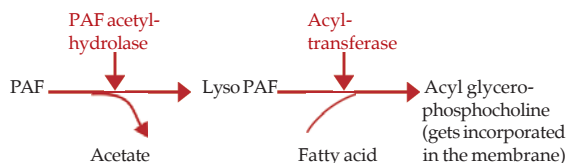

Actions PAF has potent actions on many tissues/organs.

Platelets Aggregation and release reaction; also releases TXA_2 ; i.v. injection results in intravascular thrombosis.

WBC PAF is chemotactic to neutrophils, eosinophils and monocytes. It stimulates neutrophils to aggregate, to stick to vascular endothelium and migrate across it to the site of infection. It also prompts release of lysosomal enzymes and LTs and generation of superoxide radical by the polymorphs. The chemotactic action may be mediated through release of LTB_4 . It induces degranulation of eosinophils.

Blood vessels Vasodilatation mediated by release of EDRF occurs → fall in BP on i.v. injection. Decreased coronary blood flow has been observed on intracoronary injection, probably due to formation of platelet aggregates and release of TXA_2 .

PAF is the most potent agent known to increase vascular permeability. Wheal and flare occur at the site of intradermal injection.

Injected into the renal artery PAF reduces renal blood flow and Na^+ excretion by direct vasoconstrictor action, but this is partly counteracted by local PG release.

Visceral smooth muscle Contraction occurs by direct action as well as through release of LTC_4 , TXA_2 and PGs. Aerosolized PAF is a potent bronchoconstrictor. In addition, it produces mucosal edema, secretion and a delayed and long-lasting bronchial hyper-responsiveness. It also stimulates intestinal and uterine smooth muscle.

Stomach PAF is ulcerogenic: erosions and mucosal bleeding occur shortly after i.v. injection of PAF. The gastric smooth muscle contracts.

Mechanism of action Membrane bound specific PAF receptors have been identified. The PAF receptor is a G-protein coupled receptor which exerts most of the actions through intracellular messengers $IP_3/DAG \rightarrow Ca^{2+}$ release.

As mentioned above, many actions of PAF are mediated/augmented by PGs, TXA_2 and LTs which may be considered its extracellular messengers. PAF also acts intracellularly, especially in the endothelial cells; rise in PAF concentration within the endothelial cells is associated with exposure of neutrophil binding sites on their surface. Similarly, its proaggregatory action involves unmasking of fibrinogen binding sites on the surface of platelets.

PAF antagonists A number of natural and synthetic PAF receptor antagonists have been investigated. Important among these are ginkgolide B (from a Chinese plant), and some structural analogues of PAF. The PAF antagonists have manifold therapeutic potentials like treatment of stroke, intermittent claudication, sepsis, myocardial infarction, shock, g.i. ulceration, asthma and as contraceptive. Some of them have been tried clinically but none has been found worth marketing. Alprazolam and triazolam antagonize some actions of PAF.

Pathophysiological roles PAF has been implicated in many physiological processes and pathological states, especially those involving cell-to-cell interaction. These are:

1. **Inflammation:** Generated by leukocytes at the site of inflammation PAF appears to participate in the causation of vasodilatation, exudation, cellular infiltration and hyperalgesia.
2. **Bronchial asthma:** Along with LTC_4 and LTD_4 , PAF appears to play a major role by causing bronchoconstriction, mucosal edema and secretions. It is unique in producing prolonged airway hyper-reactivity, so typical of bronchial asthma patient.
3. **Anaphylactic (and other) shock conditions:** are associated with high circulating PAF levels.
4. **Haemostasis and thrombosis:** PAF may participate by promoting platelet aggregation.
5. **Rupture of mature graafian follicle and implantation:** Early embryos which produce PAF have greater chance of implanting. However, PAF is not essential for reproduction.
6. **Ischaemic states of brain, heart and g.i.t.,** including g.i. ulceration.

CHAPTER 14

Nonsteroidal Antiinflammatory Drugs and Antipyretic-Analgesics

All drugs grouped in this class have analgesic, antipyretic and antiinflammatory actions in different measures. In contrast to morphine they do not depress CNS, do not produce physical dependence, have no abuse liability and are weaker analgesics (except for inflammatory pain). They are also called *nonnarcotic, nonopioid* or *aspirin-like* analgesics. They act primarily on peripheral pain mechanisms, but also in the CNS to raise pain threshold. They are more commonly employed and many are over-the-counter drugs.

Willow bark (*Salix alba*) had been used for many centuries. Salicylic acid was prepared by hydrolysis of the bitter glycoside obtained from this plant. *Sodium salicylate* was used for fever and pain in 1875; its great success led to the introduction of acetylsalicylic acid (aspirin) in 1899. *Phenacetin* and *antipyrine* were also produced at that time. The next major advance was the development of phenylbutazone in 1949 having antiinflammatory activity almost comparable to corticosteroids. The term Nonsteroidal Antiinflammatory Drug (NSAID) was coined to designate such drugs. *Indomethacin* was introduced in 1963. A host of compounds heralded by the propionic acid derivative *ibuprofen* have been added since then and cyclooxygenase (COX) inhibition is recognised to be their most important mechanism of action. Recently some selective COX-2 inhibitors (celecoxib, etc.) have been added.

The antipyretic-analgesics are chemically diverse, but most are organic acids.

CLASSIFICATION

A. *Nonselective COX inhibitors (traditional NSAIDs)*

1. *Salicylates*: Aspirin.
2. *Propionic acid derivatives*: Ibuprofen, Naproxen, Ketoprofen, Flurbiprofen.
3. *Anthranilic acid derivative*: Mephenamic acid.
4. *Aryl-acetic acid derivatives*: Diclofenac, Aceclofenac.
5. *Oxicam derivatives*: Piroxicam, Tenoxicam.
6. *Pyrrolo-pyrrole derivative*: Ketorolac.
7. *Indole derivative*: Indomethacin.
8. *Pyrazolone derivatives*: Phenylbutazone, Oxyphenbutazone.

B. *Preferential COX-2 inhibitors*

Nimesulide, Meloxicam, Nabumetone.

C. *Selective COX-2 inhibitors*

Celecoxib, Etoricoxib, Parecoxib.

D. *Analgesic- antipyretics with poor antiinflammatory action*

1. *Paraaminophenol derivative*: Paracetamol (Acetaminophen).
2. *Pyrazolone derivatives*: Metamizol (Dipyrone), Propiphenazone.
3. *Benzoxazocine derivative*: Nefopam.

NSAIDs and prostaglandin (PG) synthesis inhibition

In 1971 Vane and coworkers made the landmark observation that aspirin and some NSAIDs blocked PG generation. This is now considered to be the major mechanism of action of NSAIDs. Prostaglandins, prostacyclin (PG I₂) and thromboxane A₂ (TXA₂) are produced from arachidonic acid by the enzyme cyclooxygenase (*see* p. 174) which exists in a constitutive (COX-1) and an inducible (COX-2) isoforms; the former serves physiological 'house keeping' functions, while the latter, normally present in minute quantities, is induced by cytokines and other signal molecules at the site of inflammation → generation of PGs locally which mediate many of the inflammatory changes. However, COX-2 is constitutively present at some sites in brain and in juxtaglomerular cells: may serve physiological role at these sites. Most NSAIDs inhibit COX-1 and COX-2 nonselectively, but now some selective COX-2 inhibitors have been produced. Features of nonselective COX-1/COX-2 inhibitors (traditional NSAIDs) and selective COX-2 inhibitors are compared in Table 14.1

Aspirin inhibits COX irreversibly by acetylating one of its serine residues; return of COX activity depends on synthesis of fresh enzyme.

Beneficial actions due to PG synthesis inhibition

- Analgesia: prevention of pain nerve ending sensitization
- Antipyresis
- Antiinflammatory
- Antithrombotic
- Closure of ductus arteriosus in newborn

Other NSAIDs are competitive and reversible inhibitors of COX, return of activity depends on their dissociation from the enzyme which in turn is governed by the pharmacokinetic characteristics of the compound.

Analgesia PGs induce hyperalgesia (*see* p. 179) by affecting the transducing property of free

nerve endings—stimuli that normally do not elicit pain are able to do so. NSAIDs do not affect the tenderness induced by direct application of PGs, but block the pain sensitizing mechanism induced by bradykinin, TNF α , interleukins (ILs) and other algescic substances. They are, therefore, more effective against inflammation associated pain.

Antipyresis NSAIDs reduce body temperature in fever, but do not cause hypothermia in normothermic individuals. Fever during infection is produced through the generation of pyrogens including, ILs, TNF α , interferons which induce PGE₂ production in hypothalamus—raise its temperature set point. NSAIDs block the action of pyrogens but not that of PGE₂ injected into the hypothalamus. The isoform present at this site appears to be COX-2 (possibly COX-3 also). However, fever can occur through non-PG mediated mechanisms as well.

Shared toxicities due to PG synthesis inhibition

- Gastric mucosal damage
- Bleeding: inhibition of platelet function
- Limitation of renal blood flow : Na⁺ and water retention
- Delay/prolongation of labour
- Asthma and anaphylactoid reactions in susceptible individuals

Antiinflammatory The most important mechanism of antiinflammatory action of NSAIDs is considered to be inhibition of PG synthesis at the site of injury. The antiinflammatory potency of different compounds roughly corresponds with their potency to inhibit COX. However, nimesulide is a potent antiinflammatory but relatively weak COX inhibitor. PGs are only one of the mediators of inflammation; inhibition of COX does not depress the production of other mediators like LTs, PAF, cytokines, etc. Inflammation is the result of concerted participation of a large number of vasoactive, chemotactic and proliferative factors at different stages, and there are many targets for antiinflammatory action.

Activated endothelial cells express adhesion molecules (ECAM-1, ICAM-1) on their surface and play a key role in directing circulating leucocytes to the site of inflammation (chemotaxis). Similarly, inflammatory cells express *selectins* and *integrins*. Certain NSAIDs may act by additional mechanisms including inhibition of expression/activity of some of these molecules and generation of superoxide/other free radicals. Growth factors like GM-CSF, IL-6 and lymphocyte transformation factors may also be affected. Stabilization of leucocyte lysosomal membrane and antagonism of certain actions of kinins may be contributing to NSAID action.

Table 14.1: Features of nonselective COX inhibitors and selective COX-2 inhibitors

Action	COX-1/COX-2 inhibitors	COX-2 inhibitors
1. Analgesic	+	+
2. Antipyretic	+	+
3. Antiinflammatory	+	+
4. Antiplatelet aggregatory	+	-
5. Gastric mucosal damage	+	-
6. Renal salt/water retention	+	+
7. Delay/prolongation of labour	+	+
8. Ductus arteriosus closure	+	?
9. Aspirin sensitive asthma precipitation	+	-

Dysmenorrhoea Involvement of PGs in dysmenorrhoea has been clearly demonstrated: level of PGs in menstrual flow, endometrial biopsy and that of $\text{PGF}_{2\alpha}$ metabolite in circulation are raised in dysmenorrhoeic women. Intermittent ischaemia of the myometrium is probably responsible for menstrual cramps. NSAIDs lower uterine PG levels—afford excellent relief in 60–70% and partial relief in the remaining. Ancillary symptoms of headache, muscle ache and nausea are also relieved. Excess flow may be normalized.

Antiplatelet aggregatory NSAIDs inhibit synthesis of both proaggregatory (TXA_2) and antiaggregatory (PGI_2) prostanoids, but effect on platelet TXA_2 (COX-1 generated) predominates

→ therapeutic doses of most NSAIDs inhibit platelet aggregation: bleeding time is prolonged. Aspirin is highly active; acetylates platelet COX irreversibly in the portal circulation before it is deacetylated by first pass metabolism in liver. Small doses are therefore able to exert antithrombotic effect for several days. Risk of surgical bleeding is enhanced.

Ductus arteriosus closure During foetal circulation ductus arteriosus is kept patent by local elaboration of PGE_2 and PGI_2 . Unknown mechanisms switch off this synthesis at birth and the ductus closes. When this fails to occur, small doses of indomethacin or aspirin bring about closure in majority of cases within a few hours by inhibiting PG production. Administration of NSAIDs in late pregnancy has been found to promote premature closure of ductus in some cases. Prescribing of NSAIDs near term should be avoided.

Parturition Sudden spurt of PG synthesis by uterus probably triggers labour and facilitates its progression. Accordingly, NSAIDs have the potential to delay and retard labour. However, labour can occur in the absence of PGs.

Gastric mucosal damage Gastric pain, mucosal erosion/ulceration and blood loss are produced by all NSAIDs to varying extents: relative gastric toxicity is a major consideration in the choice of NSAIDs. Inhibition of COX-1 mediated synthesis of gastroprotective PGs (PGE_2 , PGI_2) is clearly involved, though local action inducing back diffusion of H^+ ions in gastric mucosa also plays a role. Deficiency of PGs reduces mucus and HCO_3^- secretion, tends to enhance acid secretion and may promote mucosal ischaemia. Thus, NSAIDs enhance aggressive factors and contain defensive factors in gastric mucosa—are ulcerogenic. Paracetamol, a very weak inhibitor of COX is practically free of gastric toxicity and selective COX-2 inhibitors are safer. Stable PG analogues (misoprostol) administered concurrently with NSAIDs antagonise their gastric toxicity.

Renal effects Conditions leading to hypovolaemia, decreased renal perfusion and Na^+ loss induce renal PG synthesis which brings about intrarenal adjustments by promoting vasodilatation, inhibiting tubular Cl^- reabsorption (Na^+ and water accompany) and opposing ADH action.

NSAIDs produce renal effects by at least 3 mechanisms:

- COX-1 dependent impairment of renal blood flow and reduction of g.f.r. → can worsen renal insufficiency.
- Juxtaglomerular COX-2 (probably COX-1 also) dependent Na^+ and water retention.
- Ability to cause papillary necrosis on habitual intake.

Renal effects of NSAIDs are not marked in normal individuals, but become significant in those with CHF, hypovolaemia, hepatic cirrhosis, renal disease and in patients receiving diuretics or antihypertensives: Na^+ retention and edema can occur; diuretic and antihypertensive drug effects are blunted.

Involvement of PG synthesis inhibition in analgesic nephropathy (see p. 198) is uncertain.

Anaphylactoid reactions Aspirin precipitates asthma, angioneurotic swellings, urticaria or rhinitis in certain susceptible individuals. These subjects react similarly to chemically diverse NSAIDs, ruling out immunological basis for the reaction. Inhibition of COX with consequent diversion of arachidonic acid to LTs and other

products of lipoxygenase pathway may be involved, but there is no proof.

SALICYLATES

Aspirin (prototype)

Aspirin is acetylsalicylic acid. It is rapidly converted in the body to salicylic acid which is responsible for most of the actions. Other actions are the result of acetylation of certain macromolecules including COX. It is one of the oldest analgesic-antiinflammatory drugs and is still widely used.

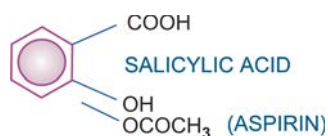

PHARMACOLOGICAL ACTIONS

1. Analgesic, antipyretic, antiinflammatory actions Aspirin is a weaker analgesic than morphine type drugs: aspirin 600 mg \approx codeine 60 mg. However, it effectively relieves inflammatory, tissue injury related, connective tissue and integumental pain, but is relatively ineffective in severe visceral and ischaemic pain. The analgesic action is mainly due to obtunding of peripheral pain receptors and prevention of PG-mediated sensitization of nerve endings. A central subcortical action raising threshold to pain perception also contributes, but the morphine-like action on psychic processing or reaction component of the

Adverse effects of NSAIDs

Gastrointestinal

Gastric irritation, erosions, peptic ulceration, gastric bleeding/perforation, esophagitis

Renal

Na^+ and water retention, chronic renal failure, interstitial nephritis, papillary necrosis (rare)

Hepatic

Raised transaminases, hepatic failure (rare)

CNS

Headache, mental confusion, behavioural disturbances, seizure precipitation

Haematological

Bleeding, thrombocytopenia, haemolytic anaemia, agranulocytosis

Others

Asthma exacerbation, nasal polyposis, skin rashes, pruritus, angioedema

pain is missing. No sedation, subjective effects, tolerance or physical dependence is produced.

Aspirin resets the hypothalamic thermostat and rapidly reduces fever by promoting heat loss (sweating, cutaneous vasodilatation), but does not decrease heat production.

Antiinflammatory action is exerted at high doses (3–6 g/day or 100 mg/kg/day). Signs of inflammation like pain, tenderness, swelling, vasodilatation and leucocyte infiltration are suppressed. In addition to COX inhibition, quenching of free radicals may contribute to its antiinflammatory action.

2. Metabolic effects These are significant only at antiinflammatory doses. Cellular metabolism is increased, especially in skeletal muscles, due to uncoupling of oxidative phosphorylation → increased heat production. There is increased utilization of glucose → blood sugar may decrease (especially in diabetics) and liver glycogen is depleted. However, hyperglycaemia is often seen at toxic doses: this is due to central sympathetic stimulation → release of Adr and corticosteroids. Chronic use of large doses cause negative N₂ balance by increased conversion of protein to carbohydrate. Plasma free fatty acid and cholesterol levels are reduced.

3. Respiration The effects are dose dependent. At antiinflammatory doses, respiration is stimulated by peripheral (increased CO₂ production) and central (increased sensitivity of respiratory centre to CO₂) actions. Hyperventilation is prominent in salicylate poisoning. Further rise in salicylate level causes respiratory depression; death is due to respiratory failure.

4. Acid-base and electrolyte balance Antiinflammatory doses produce significant changes in the acid-base and electrolyte composition of body fluids. Initially, respiratory stimulation predominates and tends to wash out CO₂ despite increased production → respiratory alkalosis, which is compensated by increased renal excretion of HCO₃⁻ (with accompanying Na⁺, K⁺ and water). Most adults treated with 4–5 g/day of

aspirin stay in a state of *compensated respiratory alkalosis*.

Still higher doses cause respiratory depression with CO₂ retention, while excess CO₂ production continues → *respiratory acidosis*. To this are added dissociated salicylic acid as well as metabolic acids (lactic, pyruvic, acetoacetic) which are produced in excess + metabolically derived sulfuric and phosphoric acid which are retained due to depression of renal function. All these combine to cause *uncompensated metabolic acidosis* since plasma HCO₃⁻ is already low. Most children manifest this phase during salicylate poisoning; while in adults it is seen in late stages of poisoning only.

Dehydration occurs in poisoning due to increased water loss in urine (to accompany Na⁺, K⁺ and HCO₃⁻) increased sweating and hyperventilation.

5. CVS Aspirin has no direct effect in therapeutic doses. Larger doses increase cardiac output to meet increased peripheral O₂ demand and cause direct vasodilatation. Toxic doses depress vasomotor centre: BP may fall. Because of increased cardiac work as well as Na⁺ and water retention, CHF may be precipitated in patients with low cardiac reserve.

6. GIT Aspirin and released salicylic acid irritate gastric mucosa → cause epigastric distress, nausea and vomiting. It also stimulates CTZ: vomiting has a central component as well at higher doses.

Aspirin (pKa 3.5) remains unionized and diffusible in the acid gastric juice, but on entering the mucosal cell (pH 7.1) it ionizes and becomes indiffusible. This 'ion trapping' in the gastric mucosal cell enhances gastric toxicity. Further, aspirin particle coming in contact with gastric mucosa promotes local back diffusion of acid → focal necrosis of mucosal cells and capillaries → acute ulcers, erosive gastritis, congestion and microscopic haemorrhages. The occult blood loss in stools is increased by even a single tablet of aspirin; averages 5 ml/day at antiinflammatory

doses. Haematemesis occurs occasionally: may be an idiosyncratic reaction.

Soluble aspirin tablets containing calcium carbonate + citric acid and other buffered preparations are less liable to cause gastric ulceration.

- 7. Urate excretion** Dose-related effect is seen:
 < 2 g/day—urate retention and antagonism of all other uricosuric drugs.
 2–5 g/day—variable effects, often no change.
 > 5 g/day—increased urate excretion.

Aspirin is not suitable for use in chronic gout.

8. Blood Aspirin, even in small doses, irreversibly inhibits TXA₂ synthesis by platelets. Thus, it interferes with platelet aggregation and bleeding time is prolonged to nearly twice the normal value. This effect lasts for about a week (turnover time of platelets).

Long-term intake of large dose decreases synthesis of clotting factors in liver and predisposes to bleeding; can be prevented by prophylactic vit K therapy.

PHARMACOKINETICS

Aspirin is absorbed from the stomach and small intestines. Its poor water solubility is the limiting factor in absorption: microfining the drug-particles and inclusion of an alkali (solubility is more at higher pH) enhances absorption. However, higher pH also favours ionization, thus decreasing the diffusible form.

Aspirin is rapidly deacetylated in the gut wall, liver, plasma and other tissues to release salicylic acid which is the major circulating and active form. It is ~80% bound to plasma proteins and has a volume of distribution ~0.17 L/kg. It slowly enters brain but freely crosses placenta. Both aspirin and salicylic acid are conjugated in liver with glycine → salicyluric acid (major pathway); and with glucuronic acid. Few other minor metabolites are also produced. The metabolites are excreted by glomerular filtration as well as tubular secretion. Normally, only 1/10th is excreted as free salicylic acid, but this can be increased by alkalinization.

The plasma t_{1/2} of aspirin as such is 15–20 min, but taken together with that of released salicylic acid, it is 3–5 hours. However, metabolic processes get saturated over the therapeutic range; t_{1/2} of antiinflammatory doses may be 8–12 hours while that during poisoning may be up to 30 hours. Thus, elimination is dose dependent.

ADVERSE EFFECTS

(a) **Side effects** that occur at analgesic dose (0.3–1.5 g/day) are nausea, vomiting, epigastric distress, increased occult blood loss in stools. The most important adverse effect of aspirin is gastric mucosal damage and peptic ulceration.

(b) **Hypersensitivity and idiosyncrasy** Though infrequent, these can be serious. Reactions include rashes, fixed drug eruption, urticaria, rhinorrhoea, angioedema, asthma and anaphylactoid reaction. Profuse gastric bleeding occurs in rare instances.

(c) **Antiinflammatory doses** (3–5 g/day) produce the syndrome called salicylism—dizziness, tinnitus, vertigo, reversible impairment of hearing and vision, excitement and mental confusion, hyperventilation and electrolyte imbalance. The dose has to be titrated to one which is just below that producing these symptoms; tinnitus is a good guide.

Aspirin therapy in children with rheumatoid arthritis has been found to raise serum transaminases, indicating liver damage. Most cases are asymptomatic but it is potentially dangerous. An association between salicylate therapy and 'Reye's syndrome', a rare form of hepatic encephalopathy seen in children having viral (varicella, influenza) infection has been noted.

In adults also, long-term therapy with high dose aspirin can cause insidious onset hepatic injury. Salt and water retention occurs in a dose related manner.

(d) **Acute salicylate poisoning** It is more common in children. Fatal dose in adults is estimated to be 15–30 g, but is considerably lower in chil-

dren. Serious toxicity is seen at serum salicylate levels > 50 mg/dl. Manifestations are:

Vomiting, dehydration, electrolyte imbalance, acidotic breathing, hyper/hypoglycaemia, petechial haemorrhages, restlessness, delirium, hallucinations, hyperpyrexia, convulsions, coma and death due to respiratory failure + cardiovascular collapse.

Treatment is symptomatic and supportive. Most important is external cooling and i.v. fluid with Na^+ , K^+ , HCO_3^- and glucose: according to need determined by repeated monitoring. Gastric lavage to remove unabsorbed drug; forced alkaline diuresis or haemodialysis to remove absorbed drug is indicated in severe cases. Blood transfusion and vit K should be given if bleeding occurs.

Precautions and contraindications

- Aspirin is contraindicated in patients who are sensitive to it and in peptic ulcer, bleeding tendencies, in children suffering from chicken pox or influenza. Due to risk of Reye's syndrome pediatric formulations of aspirin are prohibited in India and the UK.
- In chronic liver disease: cases of hepatic necrosis have been reported.
- It should be avoided in diabetics, in those with low cardiac reserve or frank CHF and in juvenile rheumatoid arthritis.
- Aspirin should be stopped 1 week before elective surgery.
- Given during pregnancy it may be responsible for low birth weight babies. Delayed or prolonged labour, greater postpartum blood loss and premature closure of ductus arteriosus are possible if aspirin is taken at or near term.
- It should be avoided by breastfeeding mothers.
- Avoid high doses in G-6-PD deficient individuals—haemolysis can occur.

Interactions

1. Aspirin displaces warfarin, naproxen, sulfonylureas, phenytoin and methotrexate from

binding sites on plasma proteins: toxicity of these drugs may occur. Its antiplatelet action increases the risk of bleeding in patients on oral anticoagulants.

2. It inhibits tubular secretion of uric acid (at analgesic doses) and antagonizes uricosuric action of probenecid. Tubular secretion of methotrexate is also interfered.

3. Aspirin blunts diuretic action of furosemide and thiazides and reduces K^+ conserving action of spironolactone. Competition between canrenone (active metabolite of spironolactone) and aspirin for active transport in proximal tubules has been demonstrated.

4. Aspirin reduces protein bound iodine levels by displacement of thyroxine; but hypothyroidism does not occur.

USES

1. *As analgesic* For headache (including mild migraine), backache, myalgia, joint pain, pulled muscle, toothache, neuralgias and dysmenorrhoea; it is effective in low doses (0.3–0.6 g 6–8 hourly). Analgesic effect is maximal at ~ 1000 mg (single dose).

2. *As antipyretic* It is effective in fever of any origin; dose is same as for analgesia. However, paracetamol, being safer, is generally preferred. Antipyretics are not useful in fever due to heat stroke; only external cooling lowers body temperature.

3. *Acute rheumatic fever* Aspirin is the first drug to be used in all cases; other drugs are added or substituted only when it fails or in severe cases (corticosteroids act faster). In a dose of 4–5 g or 75–100 mg/kg/day (in divided portions producing steady state serum salicylate concentration 15–30 mg/dl) it brings about marked symptomatic relief in 1–3 days. Dose reduction may be started after 4–7 days and maintenance doses (50 mg/kg/day) are continued for 2–3 weeks or till signs of active disease (raised ESR) persist. Withdrawal should be gradual over the next 2 weeks.

Granulomatous lesions, nodules, cardiac complications, valvular defects, chorea and duration of disease are not altered by salicylate therapy.

4. Rheumatoid arthritis Aspirin in a dose of 3–5 g/day is effective in most cases; produces relief of pain, swelling and morning stiffness, but progress of the disease process is not affected. Since large doses of aspirin are poorly tolerated for long periods it is rarely used now; other NSAIDs are preferred.

5. Osteoarthritis It affords symptomatic relief only; may be used on 'as and when required' basis, but paracetamol is the first choice analgesic for most cases.

6. Postmyocardial infarction and poststroke patients By inhibiting platelet aggregation aspirin lowers the incidence of reinfarction. TXA₂ synthesis in platelets is inhibited at low doses. It has been argued that high doses can reverse the beneficial effects by concurrently inhibiting PGI₂ (antiaggregatory and vasodilatory) synthesis in vessel wall. Large studies have demonstrated that aspirin 60–100 mg/day reduces the incidence of myocardial infarction (MI): it is now routinely prescribed to post-infarct patients; many recommend it for primary prophylaxis as well. 'New onset' or 'sudden worsening' angina is associated with high infarction rate. This can be reduced to half by 100–150 mg aspirin per day for 12 weeks.

Aspirin reduces 'transient ischaemic attacks' and lowers incidence of stroke in such patients. But the risk of stroke in post-MI patients is not reduced.

7. Other less well established uses of aspirin are:

(a) Pregnancy-induced hypertension and pre-eclampsia: imbalance between TXA₂ and PGI₂ is believed to be involved: aspirin 80–100 mg/day benefits many cases by selectively suppressing TXA₂ production.

(b) Patent ductus arteriosus: aspirin can bring about closure and avoid surgery.

(c) Familial colonic polyposis: aspirin and other NSAIDs suppress polyp formation and afford symptomatic relief in this rare disorder.

(d) Prevention of colon cancer: incidence of colon cancer among regular aspirin users is much lower. Colonic tumours express large quantities of COX-2. However, the rofecoxib trial (APPROVE) was prematurely terminated and the drug withdrawn due to increased incidence of cardiovascular events. The Adenoma Prevention with Celecoxib (APC) trial has also been terminated due to 2.5 fold increase in risk of major fatal/nonfatal cardiovascular events.

(e) To prevent flushing attending nicotinic acid ingestion, which is due to PGD₂ release in the skin.

ASPIRIN 350 mg tab, COLSPRIN 100, 325, 650 mg tabs, ECOSPRIN 75, 150, 325 mg tabs, DISPRIN 350 mg tab, LOPRIN 75, 162.5 mg tabs.

An injectable preparation has been made available recently; BIOSPIRIN: Lysine acetylsalicylate 900 mg + glycine 100 mg/vial for dissolving in 5 ml water and i.v. injection.

Other salicylates (salicylamide, benorylate, diflunisal) are seldom if ever used.

PROPRIONIC ACID DERIVATIVES

Ibuprofen was the first member of this class to be introduced in 1969 as a better tolerated alternative

Drug interactions with NSAIDs

Pharmacodynamic

Diuretics	:	↓ diuresis
β blocker	:	↓ antihypertensive effect
ACE inhibitors	:	↓ antihypertensive effect
Anticoagulants	:	↑ risk of g.i. bleed
Sulfonylureas	:	↑ risk of hypoglycaemia
Alcohol	:	↑ risk of g.i. bleed
Cyclosporine	:	↑ nephrotoxicity
Corticosteroids	:	↑ risk of g.i. bleed

Pharmacokinetic

Oral anticoagulants	}	Metabolism
Sulfonylureas		inhibited;
Phenytoin		competition
Valproate		for plasma protein binding
Digoxin	}	↓ Renal
Lithium		excretion of
Aminoglycosides		interacting drug
Methotrexate		

Comorbid conditions aggravated by NSAIDs

- Peptic ulcer
- Hypertension
- Congestive heart failure
- Renal insufficiency
- Hemostatic disorders

to aspirin. Many others have followed. All have similar pharmacodynamic properties but differ considerably in potency and to some extent in duration of action (Table 14.2).

The analgesic, antipyretic and antiinflammatory efficacy is rated somewhat lower than high dose of aspirin. All inhibit PG synthesis, naproxen being the most potent; but their *in vitro* potency for this action does not closely parallel *in vivo* antiinflammatory potency. Inhibition of platelet aggregation is short-lasting with ibuprofen, but longer lasting with naproxen.

Adverse effects Ibuprofen and all its congeners are better tolerated than aspirin. Side effects are milder and their incidence is lower.

Gastric discomfort, nausea and vomiting, though less than aspirin or indomethacin, are still the most common side effects. Gastric erosion and occult blood loss are rare.

CNS side effects include headache, dizziness, blurring of vision, tinnitus and depression.

Rashes, itching and other hypersensitivity phenomena are infrequent. However, these drugs precipitate aspirin-induced asthma.

Fluid retention is less marked than that with phenylbutazone.

They are not to be prescribed to pregnant women and should be avoided in peptic ulcer patient.

Pharmacokinetics and interactions All are well absorbed orally, highly bound to plasma proteins (90–99%), but displacement interactions are not clinically significant—dose of oral anticoagulants and oral hypoglycaemics need not be altered. Because they inhibit platelet function, use with anticoagulants should, nevertheless, be avoided. Similar to other NSAIDs, they are likely to decrease diuretic and antihypertensive action of thiazides, furosemide and β blockers.

All propionic acid derivatives enter brain, synovial fluid and cross placenta. They are largely metabolized in liver by hydroxylation and glucuronide conjugation and excreted in urine as well as bile.

Uses

1. Ibuprofen is used as a simple analgesic and antipyretic in the same way as low dose of aspirin. It is particularly effective in dysmenorrhoea in which the action is clearly due to PG synthesis inhibition. It is available as an 'over-the-counter' drug.

2. Ibuprofen and its congeners are widely used in rheumatoid arthritis, osteoarthritis and other musculoskeletal disorders, especially where pain is more prominent than inflammation.

Table 14.2: Dosage and preparations of propionic acid derivatives

Drug	Plasma $t_{1/2}$	Dosage	Preparations
1. Ibuprofen	2 hr	400–600 mg (5–10 mg/kg) TDS	BRUFEN, EMFLAM, IBUSYNTH 200, 400, 600 mg tab, IBUGESIC also 100 mg/5 ml susp.
2. Naproxen	12–16 hr	250 mg BD–TDS	NAPROSYN, NAXID, ARTAGEN, XENOBID 250 mg tab., NAPROSYN also 500 mg tab.
3. Ketoprofen	2–3 hr	50–100 mg BD–TDS	KETOFEN 50, 100 mg tab; OSTOFEN 50 mg cap. RHOVENID 100 mg tab, 200 mg SR tab; 100 mg/2 ml amp.
4. Flurbiprofen	4–6 hr	50 mg BD–QID	ARFLUR 50, 100 mg tab, 200 mg SR tab, FLUROFEN 100 mg tab.

3. They are indicated in soft tissue injuries, fractures, vasectomy, tooth extraction, postpartum and postoperatively: suppress swelling and inflammation.

Ibuprofen has been rated as the safest conventional NSAID by the spontaneous adverse drug reaction reporting system in U.K. Ibuprofen (400 mg) has been found equally or more efficacious than a combination of aspirin (650 mg) + codeine (60 mg) in relieving dental surgery pain.

Concurrent treatment with ibuprofen has been found to prevent irreversible COX inhibition by low dose aspirin. Thus, it may antagonize the antiplatelet and cardioprotective effect of low dose aspirin.

Naproxen is particularly potent in inhibiting leucocyte migration—may be more valuable in acute gout: dose 750 mg stat followed by 250 mg 8 hourly till attack subsides. It is also recommended for ankylosing spondylitis. Dose should be reduced in the elderly.

Naproxen is marketed as active single S(-) enantiomer preparation, which poses less renal burden. However, some R(+) enantiomer is formed *in vivo* due to inversion.

Ketoprofen An additional action to stabilize lysosomes and inhibit LOX has been demonstrated with ketoprofen; though antiinflammatory efficacy is similar to other NSAIDs.

Flurbiprofen more effective than ibuprofen, but gastric side effects are also more. It is used as an ocular antiinflammatory as well.

OCUFLUR, FLUR, FLURBIN, 0.03% eyedrops, 1 drop 6 hourly.

Choice among different propionic acid derivatives is difficult; *naproxen* is probably more efficacious and better tolerated in antiinflammatory doses. It is longer acting and has the advantage of twice daily dosing. However, individuals vary in their preference for different members.

ANTHRANILIC ACID DERIVATIVE (FENAMATE)

Mephenamic acid An analgesic, antipyretic and weaker antiinflammatory drug, which inhibits COX as well as antagonises certain actions of PGs. Mephenamic acid exerts peripheral as well as central analgesic action.

Adverse effects Diarrhoea is the most important dose-related side effect. Epigastric distress is complained, but gut bleeding is not significant. Skin rashes, dizziness and other CNS manifestations have occurred. Haemolytic anaemia is a rare but serious complication.

Pharmacokinetics Oral absorption is slow but almost complete. It is highly bound to plasma proteins—displacement interactions can occur; partly metabolized and excreted in urine as well as bile. Plasma $t_{1/2}$ is 2–4 hours.

Uses Mephenamic acid is indicated primarily as analgesic in muscle, joint and soft tissue pain where strong antiinflammatory action is not needed. It is quite effective in dysmenorrhoea. It may be useful in some cases of rheumatoid and osteoarthritis but has no distinct advantage.

Dose: 250–500 mg TDS; MEDOL 250, 500 mg cap; MEFTAL 250, 500 mg tab, 100 mg/5 ml susp. PONSTAN 125, 250, 500 mg tab, 50 mg/ml syrp.

ARYL-ACETIC ACID DERIVATIVES

Diclofenac sodium An analgesic-antipyretic-antiinflammatory drug, similar in efficacy to naproxen. It inhibits PG synthesis and is somewhat COX-2 selective. The antiplatelet action is short lasting. Neutrophil chemotaxis and superoxide production at the inflammatory site are reduced.

It is well absorbed orally, 99% protein bound, metabolized and excreted both in urine and bile. The plasma $t_{1/2}$ is ~2 hours. However, it has good tissue penetrability and concentration in synovial fluid is maintained for 3 times longer period than in plasma, exerting extended therapeutic action in joints.

Adverse effects of diclofenac are generally mild: epigastric pain, nausea, headache, dizziness, rashes. Gastric ulceration and bleeding are less common. Reversible elevation of serum aminotransferases has been reported more commonly; kidney damage is rare.

Diclofenac is among the most extensively used NSAID; employed in rheumatoid and

osteoarthritis, bursitis, ankylosing spondylitis, toothache, dysmenorrhoea, post-traumatic and postoperative inflammatory conditions—affords quick relief of pain and wound edema.

Dose: 50 mg TDS, then BD oral, 75 mg deep i.m. **VOVERAN**, **DICLONAC**, **MOVONAC** 50 mg enteric coated tab, 100 mg S.R. tab, 25 mg/ml in 3 ml amp. for i.m. inj. **DICLOMAX** 25, 50 mg tab, 75 mg/3 ml inj. Diclofenac potassium: **VOLTAFLAM** 25, 50 mg tab, **ULTRA-K** 50 mg tab; **VOVERAN** 1% topical gel. **DICLONAC**, **VOVERAN OPHTHA** 0.1% eye drops.

Aceclofenac A somewhat COX-2 selective congener of diclofenac having similar properties. Enhancement of glycosaminoglycan synthesis may confer chondroprotective property.

Dose: 100 mg BD; **ACECLO**, **DOLOKIND** 100 mg tab, 200 mg SR tab.

OXICAM DERIVATIVES

Piroxicam It is a long-acting potent NSAID with antiinflammatory potency similar to indomethacin and good analgesic-antipyretic action. It is a reversible inhibitor of COX; lowers PG concentration in synovial fluid and inhibits platelet aggregation—prolonging bleeding time. In addition, it decreases the production of IgM rheumatoid factor and leucocyte chemotaxis. Thus, it can inhibit inflammation in diverse ways.

Pharmacokinetics It is rapidly and completely absorbed: 99% plasma protein bound; largely metabolized in liver by hydroxylation and glucuronide conjugation; excreted in urine and bile; enterohepatic cycling occurs. Plasma $t_{1/2}$ is long—nearly 2 days. Steady-state concentrations are achieved in a week. Single daily administration is sufficient.

Adverse effects The g.i. side effects are more than ibuprofen, but it is better tolerated and less ulcerogenic than indomethacin or phenylbutazone; causes less faecal blood loss than aspirin. Rashes and pruritus are seen in < 1% patients. Edema and reversible azotaemia have been observed.

Uses Piroxicam is suitable for use as short-term analgesic as well as long-term antiinflammatory drug—rheumatoid and osteo-arthritis, ankylosing spondylitis, acute gout, musculoskeletal injuries, dentistry, episiotomy, dysmenorrhoea, etc.

Dose: 20 mg BD for two days followed by 20 mg OD: **DOLONEX**, **PIROX** 10, 20 mg cap, 20 mg dispersible tab, 20 mg/ml inj in 1 and 2 ml amps; **PIRICAM** 10, 20 mg cap.

Tenoxicam A congener of piroxicam with similar properties and uses.

TOBITIL 20 mg tab; dose 20 mg OD.

PYRROLO-PYRROLE DERIVATIVE

Ketorolac A novel NSAID with potent analgesic and modest antiinflammatory activity. In postoperative pain it has equalled the efficacy of morphine, but does not interact with opioid receptors and is free of opioid side effects. Like other NSAIDs, it inhibits PG synthesis and relieves pain by a peripheral mechanism. In short-lasting pain, it has compared favourably with aspirin.

Ketorolac is rapidly absorbed after oral and i.m. administration. It is highly plasma protein bound and 60% excreted unchanged in urine. Major metabolic pathway is glucuronidation; plasma $t_{1/2}$ is 5–7 hours.

Adverse effects Nausea, abdominal pain, dyspepsia, ulceration, loose stools, drowsiness, headache, dizziness, nervousness, pruritus, pain at injection site, rise in serum transaminase and fluid retention have been noted.

Ketorolac has been used concurrently with morphine. However, it should not be given to patients on anticoagulants.

Use Ketorolac is frequently used in postoperative, dental and acute musculoskeletal pain: 15–30 mg i.m. or i.v. every 4–6 hours (max. 90 mg/day). It may also be used for renal colic, migraine and pain due to bony metastasis.

Orally it is used in a dose of 10–20 mg 6 hourly for short-term management of moderate pain. Ketorolac has been rated superior to aspirin (650

mg), paracetamol (600 mg) and equivalent to ibuprofen (400 mg). Continuous use for more than 5 days is not recommended. It should not be used for preanaesthetic medication or for obstetric analgesia.

KETOROL, ZOROVON, KETANOV, TOROLAC 10 mg tab, 30 mg in 1 ml amp.

KETLUR, ACULAR 0.5% eye drops; 1–2 drops 2–4 times a day for noninfective ocular inflammatory conditions.

INDOLE DERIVATIVE

Indomethacin It is a potent antiinflammatory drug with prompt antipyretic action. Indomethacin relieves only inflammatory or tissue injury related pain. It is a highly potent inhibitor of PG synthesis and suppresses neutrophil motility. In toxic doses it uncouples oxidative phosphorylation (like aspirin).

Pharmacokinetics Indomethacin is well absorbed orally, rectal absorption is slow but dependable. It is 90% bound to plasma proteins, partly metabolized in liver to inactive products and excreted by kidney. Plasma $t_{1/2}$ is 2–5 hours.

Adverse effects A high incidence (up to 50%) of gastrointestinal and CNS side effects is produced.

Gastric irritation, nausea, anorexia, gastric bleeding and diarrhoea are prominent.

Frontal headache (very common), dizziness, ataxia, mental confusion, hallucination, depression and psychosis can occur.

Leukopenia, rashes and other hypersensitivity reactions are also reported.

Increased risk of bleeding due to decreased platelet aggregability.

It is contraindicated in machinery operators, drivers, psychiatric patients, epileptics, kidney disease, pregnant women and in children.

Dose: 25–50 mg BD-QID. Those not tolerating the drug orally may be given nightly suppository.

IDICIN, INDOCAP 25 mg cap, 75 mg SR cap, **ARTICID** 25, 50 mg cap, **INDOFLAM** 25, 75 mg caps, 1% eye drop. **RECTICIN** 50 mg suppository.

Uses Because of prominent adverse effects, indomethacin is used as a reserve drug in

conditions requiring potent antiinflammatory action like ankylosing spondylitis, acute exacerbations of destructive arthropathies, psoriatic arthritis and acute gout that are not responding to better tolerated NSAIDs.

Maligancy associated fever refractory to other antipyretics may respond to indomethacin. It has been the most common drug used for medical closure of patent ductus arteriosus: three 12 hourly doses of 0.1–0.2 mg/kg achieve closure in majority of cases.

Bartter's syndrome responds dramatically, as it does to other PG synthesis inhibitors.

PYRAZOLONES

Antipyrine (phenazone) and amidopyrine (aminopyrine) were introduced in 1884 as antipyretic and analgesic. Their use was associated with high incidence of agranulocytosis: are banned in many countries, including India. *Phenylbutazone* was introduced in 1949 and soon its active metabolite *oxyphenbutazone* was also marketed. These two are potent antiinflammatory drugs, inhibit COX, but have slow onset, weak analgesic and antipyretic action. Their gastric toxicity is high; edema due to Na^+ and water retention is frequent and CNS side effects, hypersensitivity reactions, hypothyroidism are reported. They are banned in many countries and rarely used in others due to residual risk of bone marrow depression and other toxicity. Two other pyrazolones available in India—*metamizol* and *propiphenazone* are primarily used as analgesic and antipyretic.

Metamizol (Dipyrone) In contrast to phenylbutazone, this derivative of amidopyrine is a potent and promptly acting analgesic and antipyretic but poor antiinflammatory and not uricosuric. It can be given orally, i.m. as well as i.v, but gastric irritation, pain at injection site occurs. Occasionally, i.v. injection produces precipitous fall in BP.

Few cases of agranulocytosis were reported and metamizol is banned in the USA and some European countries. However, it has been extensively used in India and other European countries. Adverse reaction data collected over four decades shows that risk of serious toxicity with this drug is lower than with aspirin or many other NSAIDs. However, its fixed dose combination with antispasmodics is banned in India.

Dose: 0.5–1.5 g oral/i.m./i.v.; **ANALGIN** 0.5 g tab; **NOVALGIN**, **BARALGAN** 0.5 g tab, 0.5 g/ml in 2 ml and 5 ml amps; **ULTRAGIN** 0.5 g/ml inj in 2 ml amp and 30 ml vial.

Propiphenazone Another pyrazolone, similar in properties to metamizol; claimed to be better tolerated. Agranulocytosis has not been reported.

Dose: 300–600 mg TDS; marketed only in combination in several ‘over-the-counter’, preparations—in **SARIDON**, **ANAFEBRIN**: propiphenazone 150 mg + paracetamol 250 mg tab.

DART: propiphenazone 150 mg + paracetamol 300 mg + caffeine 50 mg tab.

PREFERENTIAL COX-2 INHIBITORS

Nimesulide This newer NSAID is a relatively weak inhibitor of PG synthesis and there is some evidence to indicate relative COX-2 selectivity. Antiinflammatory action may be exerted by other mechanisms as well, e.g. reduced generation of superoxide by neutrophils, inhibition of PAF synthesis and TNF α release, free radical scavenging, inhibition of metalloproteinase activity in cartilage. The analgesic, antipyretic and antiinflammatory activity of nimesulide has been rated comparable to other NSAIDs. It has been used primarily for short-lasting painful inflammatory conditions like sports injuries, sinusitis and other ear-nose-throat disorders, dental surgery, bursitis, low backache, dysmenorrhoea, postoperative pain, osteoarthritis and for fever.

Nimesulide is almost completely absorbed orally, 99% plasma protein bound, extensively metabolized and excreted mainly in urine with a $t_{1/2}$ of 2–5 hours.

Adverse effects of nimesulide are gastrointestinal (epigastralgia, heart burn, nausea, loose motions), dermatological (rash, pruritus) and central (somnolence, dizziness). Gastric tolerability of nimesulide is better, though an Italian study has shown that ulcer complications are as prevalent as with other NSAIDs. There is also no proof that renal complications are missing; hematuria is reported in few children. Instances of fulminant hepatic failure have been associated with nimesulide and it has been withdrawn in Spain and Turkey; use in children is banned in Portugal and Israel. However, a Finish committee

for proprietary medicinal products has concluded that hepatic reactions to nimesulide are similar to other NSAIDs. Considering that it has not been marketed in many countries like the UK, USA, Australia, Canada, the overall safety of this drug, especially in children, has been questioned. However, most asthmatics and those who develop bronchospasm or intolerance to aspirin and other NSAIDs do not cross react with nimesulide. Its specific usefulness appears to be only in such patients.

Dose: 100 mg BD; **NIMULID**, **NIMEGESIC**, **NIMODOL** 100 mg tab, 50 mg/5 ml susp.

Meloxicam This newer congener of piroxicam has a COX-2/COX-1 selectivity ratio of about 10. Since measurable inhibition of platelet TXA₂ production (a COX-1 function) occurs at therapeutic doses of meloxicam, it has been labelled ‘preferential COX-2 inhibitor’. Efficacy of meloxicam in osteo- and rheumatoid arthritis is comparable to piroxicam. In short-term studies, gastric changes with the lower dose (7.5 mg/day) were found to be similar to placebo, but at the higher dose (15 mg/day) they were intermediate between placebo and piroxicam. Gastric side effects of meloxicam are milder, but ulcer complications (bleeding, perforation) have been reported on long-term use. Thus, there is no convincing evidence that meloxicam is safer than other NSAIDs.

Dose: 7.5–15 mg OD; **MELFLAM**, **MEL-OD**, **MUVIK**, **M-CAM** 7.5 mg, 15 mg tabs.

Nabumetone It is a prodrug—generates an active metabolite (6-MNA), and is a relatively more potent COX-2 than COX-1 inhibitor. It possesses analgesic, antipyretic and antiinflammatory activities; effective in the treatment of rheumatoid and osteoarthritis as well as soft tissue injury. Nabumetone has caused a lower incidence of gastric erosions, ulcers and bleeding, probably because the active COX inhibitor is produced in tissues after absorption. However, abdominal cramps and diarrhoea can occur and there is no firm evidence of its relative safety compared to traditional NSAIDs.

NABUFLAM 500 mg tab; 1 tab OD.

SELECTIVE COX-2 INHIBITORS (Coxibs)

Because of the theoretical advantage of inhibiting COX-2 without affecting COX-1 function, some highly selective COX-2 inhibitors have been introduced over the past decade. They cause little gastric mucosal damage; occurrence of peptic ulcer and ulcer bleeds is clearly lower than with traditional NSAIDs. They do not depress TXA₂ production by platelets (COX-I dependent); do not inhibit platelet aggregation or prolong bleeding time, but reduce PGI₂ production by vascular endothelium.

Currently, 3 selective COX-2 inhibitors (also called coxibs) *Celecoxib*, *Etoricoxib* and *Parecoxib* are available in India; *Lumiracoxib* is marketed in Europe, while *Rofecoxib* and *Valdecoxib* have been withdrawn for increasing cardiovascular (CV) risk.

Selective COX-2 inhibitors and cardiovascular risk

COX-2 inhibitors reduce endothelial PGI₂ production without affecting platelet TXA₂ synthesis. This appears to exert prothrombotic influence and enhance CV risk.

- VIGOR (VIOXX gastrointestinal outcomes research) study in over 8000 patients found 4-fold higher incidence of myocardial infarction (MI) in rofecoxib (VIOXX) recipients compared to those on naproxen.
- APPROVE (adenomatous polyp prevention on VIOXX) a placebo controlled trial among subjects with history of colorectal adenomas was stopped prematurely at 3 years because it confirmed higher risk of heart attack and stroke: rofecoxib was withdrawn globally in 2004.
- A metaanalysis of 18 trials with rofecoxib for musculoskeletal disorders has also inferred that it increases incidence of MI.
- Valdecoxib increased occurrence of MI in patients undergoing coronary bypass surgery. There were reports of severe skin reactions as well. It was withdrawn in 2005.
- Though CLASS (celecoxib long-term safety study) did not find any increase in CV events, the APC (adenoma prevention with celecoxib) trial has been terminated prematurely due to 2.5 fold higher risk of the same.
- There is no clear evidence as yet that etoricoxib and lumiracoxib also increase CV risk.
- A joint committee in USA (2005) has concluded that enough evidence to withdraw all selective COX-2 inhibitors is lacking, but that their labelling should include a warning of CV risk.

It has been concluded that selective COX-2 inhibitors should be used only in patients at high risk of peptic ulcer, perforation or bleeds. If selected, they should be administered in the lowest dose for the shortest period of time. Moreover, they should be avoided in patients with history of ischaemic heart disease/hypertension/cardiac failure/cerebrovascular disease, who are pre-disposed to CV events.

Concerns, other than cardiovascular, have also been expressed about selective COX-2 inhibitors.

Other concerns with selective COX-2 inhibitors

- COX-1 generated PGs may also play a role in inflammation: COX-2 inhibitors may not have as broad range of efficacy as traditional NSAIDs.
- Ulcer injury and *H. pylori* induce COX-2 in gastric mucosa, which may contribute to gastroprotective PG synthesis; COX-2 inhibition may delay ulcer healing.
- Juxtaglomerular COX-2 is constitutive; its inhibition can cause salt and water retention; pedal edema, precipitation of CHF and rise in BP can occur with all coxibs.

Celecoxib The COX-2 selectivity of celecoxib is modest (6–20 fold). It exerts antiinflammatory, analgesic and antipyretic actions with low ulcerogenic potential. Comparative trials in rheumatoid arthritis have found it to be as effective as naproxen or diclofenac, without affecting COX-1 activity in gastroduodenal mucosa. Platelet aggregation in response to collagen exposure remained intact in celecoxib recipients and serum TXB₂ levels were not reduced. Though tolerability of celecoxib is better than traditional NSAIDs, still abdominal pain, dyspepsia and mild diarrhoea are the common side effects. Rashes, edema and a small rise in BP have also been noted.

Celecoxib is slowly absorbed, 97% plasma protein bound and metabolized primarily by CYP2C9 with a t_{1/2} of ~10 hours. It is approved for use in osteo- and rheumatoid arthritis in a dose of 100–200 mg BD.

CELACT, REVIBRA, COLCIBRA 100, 200 mg caps.

Etoricoxib This newer COX-2 inhibitor has the highest COX-2 selectivity. It is suitable for once-a-day treatment of osteo/rheumatoid/acute gouty arthritis, dysmenorrhoea, acute dental surgery pain and similar conditions, without affecting platelet function or damaging gastric mucosa. The $t_{1/2}$ is ~ 24 hours. Side effects are dry mouth, aphthous ulcers, taste disturbance and paresthesias.

Dose: 60–120 mg OD; **ETODY**, **TOROCOXIA**, **ETOXIB**, **NUCOXIA** 60, 90, 120 mg tabs.

Parecoxib It is a prodrug of valdecoxib suitable for injection, and to be used in postoperative or similar short-term pain, with efficacy similar to ketorolac.

Dose: 40 mg oral/i.m./i.v., repeated after 6–12 hours. **REVALDO**, **VALTO-P** 40 mg/vial inj, **PAROXIB** 40 mg tab.

PARA-AMINO PHENOL DERIVATIVES

Phenacetin introduced in 1887 was extensively used as analgesic-antipyretic, but is now banned because it was implicated in analgesic abuse nephropathy.

Paracetamol (acetaminophen) the deethylated active metabolite of phenacetin, was also introduced in the last century but has come into common use only since 1950.

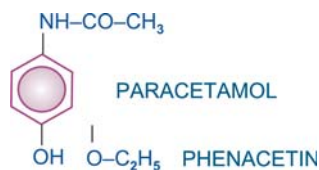

Actions The central analgesic action of paracetamol is like aspirin, i.e. it raises pain threshold, but has weak peripheral antiinflammatory component. Analgesic action of aspirin and paracetamol is additive. Paracetamol is a good and promptly acting antipyretic.

Paracetamol has negligible antiinflammatory action. It is a poor inhibitor of PG synthesis in peripheral tissues, but more active on COX in the brain. One explanation offered for the discrepancy between its analgesic-antipyretic and antiinflam-

matory actions is its inability to inhibit COX in the presence of peroxides which are generated at sites of inflammation, but are not present in the brain. The ability of paracetamol to inhibit COX-3 (an isoenzyme so far located in dog brain) could also account for its analgesic-antipyretic action.

In contrast to aspirin, paracetamol does not stimulate respiration or affect acid-base balance; does not increase cellular metabolism. It has no effect on CVS. Gastric irritation is insignificant—mucosal erosion and bleeding occur rarely only in overdose. It does not affect platelet function or clotting factors and is not uricosuric.

Pharmacokinetics Paracetamol is well absorbed orally, only about 1/4th is protein bound in plasma and it is uniformly distributed in the body. Metabolism occurs mainly by conjugation with glucuronic acid and sulfate: conjugates are excreted rapidly in urine. Plasma $t_{1/2}$ is 2–3 hours. Effects after an oral dose last for 3–5 hours.

Adverse effects In isolated antipyretic doses paracetamol is safe and well tolerated. Nausea and rashes occur occasionally, leukopenia is rare.

Analgesic nephropathy occurs after years of heavy ingestion of analgesics; such individuals probably have some personality defect. Pathological lesions are papillary necrosis, tubular atrophy followed by renal fibrosis. Urine concentrating ability is lost and the kidneys shrink. Because phenacetin was first implicated, it went into disrepute, though other analgesics are also liable to produce similar effects.

Acute paracetamol poisoning It occurs especially in small children who have low hepatic glucuronide conjugating ability. If a large dose (> 150 mg/kg or > 10 g in an adult) is taken, serious toxicity can occur. Fatality is common with > 250 mg/kg.

Early manifestations are just nausea, vomiting, abdominal pain and liver tenderness with no impairment of consciousness. After 12–18 hours centrilobular hepatic necrosis occurs which may be accompanied by renal tubular necrosis and hypoglycaemia that may progress to coma. Jaundice starts after 2 days. Further course

depends on the dose taken. Fulminating hepatic failure and death are likely if the plasma levels are above the line joining 200 µg/ml at 4 hours and 30 µg/ml at 15 hours. If the levels are lower—recovery with supportive treatment is the rule.

Mechanism of toxicity N-acetyl-p-benzoquinoneimine (NABQI) is a highly reactive arylating minor metabolite of paracetamol which is detoxified by conjugation with glutathione. When a very large dose of paracetamol is taken, glucuronidation capacity is saturated, more of the minor metabolite is formed—hepatic glutathione is depleted and this metabolite binds covalently to proteins in liver cells (and renal tubules) causing necrosis. Toxicity thus shows a threshold effect manifesting only when glutathione is depleted to a critical point.

In chronic alcoholics even 5–6 g/day taken for a few days can result in hepatotoxicity because alcoholism induces CYP2E1 that metabolises paracetamol to NABQI.

Paracetamol is not recommended in premature infants (< 2 kg) for fear of hepatotoxicity.

Treatment If the patient is brought early, vomiting should be induced or gastric lavage done. Activated charcoal is given orally or through the tube to prevent further absorption. Other supportive measures, as needed, should be taken.

Specific: N-acetylcysteine (MUCOMIX, ANTIFEN 200 mg/ml inj in 2, 5 ml amps) 150 mg/kg should be infused i.v. over 15 min, followed by the same dose i.v. over the next 20 hours. Alternatively, 75 mg/kg may be given orally every 4–6 hours for 2–3 days. It replenishes the glutathione stores of liver and prevents binding of the toxic metabolite to other cellular constituents.

Ingestion-treatment interval is critical; earlier the better. It is practically ineffective if started 16 hours or more after paracetamol ingestion.

Uses Paracetamol is one of the most commonly used 'over-the-counter' analgesic for headache, mild migraine, musculoskeletal pain, dysmenorrhoea, etc. but is relatively ineffective when inflammation is prominent. Paracetamol is recom-

mended as first choice analgesic for osteoarthritis by many professional bodies. It is one of the best drugs to be used as antipyretic, especially in children (no risk of Reye's syndrome).

Dose to dose it is equally efficacious as aspirin for noninflammatory conditions. It is much safer than aspirin in terms of gastric irritation, ulceration and bleeding (can be given to ulcer patients), does not prolong bleeding time. Hypersensitivity reactions are rare; no metabolic effects or acid-base disturbances; can be used in all age groups (infants to elderly), pregnant/lactating women, in presence of other disease states and in patients in whom aspirin is contraindicated. It does not have significant drug interactions. Thus, it may be preferred over aspirin for most minor conditions. *Dose:* 0.5–1g TDS; infants 50 mg; children 1–3 years 80–160 mg, 4–8 years 240–320 mg, 9–12 years 300–600 mg. CROCIN 0.5, 1.0 g tabs; METACIN, PARACIN 500 mg tab, 125 mg/5 ml syrup, 150 mg/ml paed. drops, ULTRAGIN, PYRIGESIC, CALPOL 500 mg tab, 125 mg/5 ml syrup, NEOMOL, FEVASTIN, FEBRINIL 300 mg/2 ml inj., CROCIN PAIN RELIEF: 650 mg + Caffeine 50 mg tab.

BENZOXAZOCINE DERIVATIVE

Nefopam It is a nonopioid analgesic which does not inhibit PG synthesis and acts rapidly in traumatic and postoperative pain. Favourable results have been obtained in short-lasting musculoskeletal pain.

Nefopam produces anticholinergic (dry mouth, urinary retention, blurred vision) and sympathomimetic (tachycardia, nervousness) side effects, and nausea is often dose limiting. It is contraindicated in epileptics.

Dose: 30–60 mg TDS oral, 20 mg i.m. 6 hourly.

NEFOMAX 30 mg tab, 20 mg in 1 ml amp.

Topical NSAIDs

Many NSAIDs have been marketed in topical formulations (mostly as gels) for application over painful muscles or joints. These preparations are being used for osteoarthritis, sprains, sports injuries, tenosinovitis, backache, spondylitis and other forms of soft tissue rheumatism. It is believed that the drug would penetrate to the subjacent tissues attaining high concentrations in the affected muscles/joints, while maintaining low blood levels. Consequently the g.i. and other

systemic adverse effects would be minimised and first pass hepatic metabolism would also be avoided.

While there is no doubt about their safety, doubt has been raised about their actual efficacy over and above a strong placebo effect of local application, massaging and that due to presence of counter irritants like menthol, methyl salicylate, etc. in most of them. Often they are used in addition to oral NSAID medication; the benefit of topical application *per se* is difficult to assess.

Measurement of drug concentration attained in tissues underlying the site of application, as well as concurrent blood levels has shown that systemic absorption from topical NSAID preparations is slow taking ~10 times longer time to attain peak concentration compared to oral dosing. Highest blood levels remain below 15% of the same dose given orally. This is consistent with their lack of systemic toxicity. Local concentrations are high upto a depth of 4–6 mm, i.e. in dermis, but at 25 mm depth in muscles, the concentration is low and nearly the same as in blood. Marked variation has been noted in the concentration attained in muscles and joints depending on the type of formulation, depth and distance from site of application and among different individuals. Reports on the clinical efficacy of topical NSAIDs are even more variable (range 18–92% response). Better responses have generally been obtained in short lasting musculo-skeletal pain. Contribution of the NSAID present in the formulation to the beneficial effect, when elicited, is uncertain.

Preparations

Diclofenac 1% gel	: VOVERAN EMULGEL, RELAXYL GEL, DICLONAC GEL
Ibuprofen 10% gel	: RIBUFEN GEL
Naproxen 10% gel	: NAPROSYN GEL
Ketoprofen 2.5% gel	: RHOVENID GEL
Flurbiprofen 5% gel	: FROBEN GEL
Nimesulide 1% gel	: NIMULID TRANS GEL, ZOLANDIN GEL, NIMEGESIC-T-GEL
Piroxicam 0.5% gel	: DOLONEX GEL, MOVON GEL, PIROX GEL, MINICAM GEL

Choice of nonsteroidal antiinflammatory drug

NSAIDs have their own spectrum of adverse effects. They differ quantitatively among themselves in producing different side effects and there are large inter-individual differences. At present NSAIDs are a bewildering array of strongly promoted drugs. No single drug is superior to all others for every patient. Choice of drug is inescapably empirical.

The cause and nature of pain (mild, moderate or severe; acute or chronic; ratio of pain: inflammation) along with consideration of risk factors in the given patient govern selection of the analgesic. Also to be considered are the past experience of the patient, acceptability and individual preference. Patients differ in their analgesic response to different NSAIDs. If one NSAID is unsatisfactory in a patient, it does not mean that other NSAIDs will also be unsatisfactory. Some subjects 'feel better' on a particular drug, but not on a closely related one. It is in this context that availability of such a wide range of NSAIDs may be welcome. Some guidelines are:

1. Mild-to-moderate pain with little inflammation: paracetamol or low-dose ibuprofen.
2. Postoperative or similar acute but short-lasting pain: ketorolac, a propionic acid derivative, diclofenac, nimesulide or aspirin.
3. Acute musculoskeletal, osteoarthritic, injury associated pain: paracetamol, a propionic acid derivative or diclofenac.
4. Exacerbation of rheumatoid arthritis, ankylosing spondylitis, acute gout, acute rheumatic fever: naproxen, piroxicam, indomethacin, high dose aspirin.
5. Gastric intolerance to traditional NSAIDs or predisposed patients: a selective COX-2 inhibitor or paracetamol.
6. Patients with history of asthma or anaphylactoid reaction to aspirin/other NSAIDs: nimesulide, COX-2 inhibitor.
7. Paediatric patients: only paracetamol, aspirin, ibuprofen and naproxen have been adequately evaluated in children — should

- be preferred in them. Due to risk of Reye's syndrome, aspirin should be avoided.
8. Pregnancy: paracetamol is the safest; low-dose aspirin is probably the second best.
 9. Hypertensive, diabetic, ischaemic heart disease, epileptic and other patients receiving long-term regular medication: possibility of drug interaction with NSAIDs should be considered.

Analgesic combinations

Combination of aspirin and paracetamol is additive (not supra-additive) and a ceiling analgesic effect is obtained when the total amount of aspirin + paracetamol is ~ 1000 mg. The same is true of combinations of paracetamol with other NSAIDs like ibuprofen, diclofenac, etc. There is

no convincing evidence that such combinations are superior to single agents, either in efficacy or in safety. If at all used, such combinations should be limited to short periods.

Combination of codeine (an opioid analgesic) with aspirin or paracetamol is also additive, but in this case combination provides additional analgesia beyond the ceiling effect of aspirin/paracetamol. The mechanisms of pain relief by these two classes of drugs are different. Such combination can be considered rational for providing greater analgesia. Adequate clinical data supports use of such combination for pain refractory to single agent.

To obviate inadvertant misuse and chance of producing dependence, fixed dose combinations of analgesics with hypnotics/sedatives/anxiolytics is banned in India.



ANTIRHEUMATOID DRUGS

These are drugs which (except corticosteroids), can suppress the rheumatoid process and bring about a remission, but do not have nonspecific antiinflammatory or analgesic action. They are used in rheumatoid arthritis (RA) in addition to NSAIDs and are also referred to as *disease modifying antirheumatic drugs* (DMARDs) or *slow acting antirheumatic drugs* (SAARDs). The onset of benefit with DMARDs takes a few months of regular treatment and relapses occur a few months after cessation of therapy. Recently, some *biologic response modifiers* (BRMs) have been added for resistant cases.

Rheumatoid arthritis (RA) is an autoimmune disease in which there is joint inflammation, synovial proliferation and destruction of articular cartilage. Immune complexes composed of IgM activate complement and release cytokines (mainly TNF α and IL-1) which are chemotactic for neutrophils. These inflammatory cells secrete lysosomal enzymes which damage cartilage and erode bone, while PGs produced in the process cause vasodilatation and pain. RA is a chronic progressive, crippling disorder with a waxing and waning course. NSAIDs are the first line drugs and afford symptomatic relief in pain,

swelling, morning stiffness, immobility, but do not arrest the disease process.

The goals of drug therapy in RA are:

- Ameliorate pain, swelling and joint stiffness
- Prevent articular cartilage damage and bony erosions
- Prevent deformity and preserve joint function.

Though mild/early cases are still mostly treated only with NSAIDs, the current recommendation is to add DMARDs as soon as the diagnosis of RA is confirmed. However, use of DMARDs in early/mild RA should be weighed against their potential adverse effects, which may be serious. More than one DMARD may be used concurrently; advanced cases may require 2 or 3 drugs together, because all DMARDs tend to lose effectiveness with time.

A. *Disease modifying antirheumatic drugs (DMARDs)*

1. *Immunosuppressants*: Methotrexate, Azathioprine, Cyclosporine
2. Sulfasalazine
3. Chloroquine or Hydroxychloroquine
4. Leflunomide
5. Gold sod. thiomalate, Auranofin
6. d-Penicillamine

B. Biologic response modifiers (BRMs)

1. *TNF α* inhibitors: Etanercept, Infliximab, Adalimumab
2. *IL-1 antagonist*: Anakinra

C. Adjuvant drugs

Corticosteroids: Prednisolone and others

1. Immunosuppressants (see Ch. 63)

Methotrexate (Mtx) This dihydrofolate reductase inhibitor has prominent immunosuppressant and antiinflammatory property. Beneficial effects in RA are probably related to inhibition of cytokine production, chemotaxis and cell-mediated immune reaction. Induction of oral low-dose (7.5–15 mg) weekly Mtx regimen has improved acceptability of this drug in RA. Onset of symptom relief is relatively rapid (4–6 weeks), therefore preferred for initial treatment. Mtx is now the DMARD of first choice and the standard treatment for most patients, including cases of juvenile RA. Response is more predictable and sustained over long-term.

Oral bioavailability of Mtx is variable and may be affected by food. Its excretion is hindered in renal disease: not recommended for such patients. Probenecid and aspirin increase Mtx levels and toxicity. Trimethoprim can add to inhibition of dihydrofolate reductase and depress bone marrow. Nodulosis, oral ulceration and g.i. upset are the major side effects of low dose Mtx regimen. With prolonged therapy, dose dependent progressive liver damage leading to cirrhosis occurs in some patients (this is not seen with short courses used in cancer). Incidence of chest infection is increased. Mtx is contraindicated in pregnancy, breast-feeding, liver disease, active infection, leucopenia and peptic ulcer.

NEOTREXATE, BIOTREXATE 2.5 mg tab.

Azathioprine This purine antimetabolite acts after getting converted to 6-mercaptopurine by the enzyme thiopurine methyl transferase (TPMT). It is a potent suppressant of cell-mediated immunity; appears to selectively affect differentia-

tion and function of T-cells and natural killer cells. It also suppresses inflammation. However, remission is induced in smaller percentage of RA patients and it is less commonly used. Given along with corticosteroids, it has a steroid sparing effect, for which it is primarily used now, especially in cases with systemic manifestations. It is not combined with Mtx.

Dose: 50–150 mg/day; **IMURAN 50 mg tab.**

Other immunosuppressants like cyclosporine, chlorambucil, cyclophosphamide are rarely used in RA; are reserved for cases not responding to other DMARDs.

2. Sulfasalazine (see Ch. 48)

It is a compound of sulfapyridine and 5-amino salicylic acid (5-ASA); has antiinflammatory activity and is primarily used in ulcerative colitis. In addition, it suppresses the disease in significant number of RA patients. The mechanism of action is not known. Sulfapyridine split off in the colon by bacterial action and absorbed systemically appears to be the active moiety (contrast ulcerative colitis, in which 5-ASA acting locally in the colon is the active component). Generation of superoxide radicals and cytokine elaboration by inflammatory cells may be suppressed. Efficacy of sulfasalazine in RA is modest and side effects are few, but neutropenia/thrombocytopenia occurs in about 10% patients and hepatitis is possible. It is used as a second line drug for milder cases.

Dose: 1–3 g/day in 2–3 divided doses.

SALAZO PYRIN, SAZO-EN 0.5 g tab.

3. Chloroquine and hydroxychloroquine (see Ch. 59)

These are antimalarial drugs found to induce remission in upto 50% patients of RA, but take 3–6 months. Their advantage is relatively low toxicity, but efficacy is also low; bony erosions are not prevented. Their mechanism of action is not known, however, they have been found to reduce monocyte IL-1, consequently inhibiting B lymphocytes. Antigen processing may be interfered with. Lysosomal stabilization and free

radical scavenging are the other proposed mechanisms.

For RA, these drugs have to be given for long periods: accumulate in tissues and produce toxicity, most disturbing of which is retinal damage and corneal opacity. This is less common and reversible in case of hydroxychloroquine, which is preferred over chloroquine.

Other adverse effects are rashes, graying of hair, irritable bowel syndrome, myopathy and neuropathy.

Chloroquine/hydroxychloroquine are employed in milder nonerosive disease, especially when only one or a few joints are involved, or they are combined with Mtx/sulfasalazine.

Dose: Chloroquine 150 mg (base) per day.

Hydroxychloroquine 400 mg/day for 4–6 weeks, followed by 200 mg/day for maintenance.

4. Leflunomide

This immunomodulator inhibits proliferation of activated lymphocytes in patients with active RA. Arthritic symptoms are suppressed and radiological progression of disease is retarded. In clinical trials its efficacy has been rated comparable to Mtx and onset of benefit is as fast (4 weeks).

Leflunomide is rapidly converted in the body to an active metabolite which inhibits *dihydroorotate dehydrogenase* and pyrimidine synthesis in actively dividing cells. Antibody production by B-cells may be depressed. The active metabolite has a long $t_{1/2}$ of 2 weeks; leflunomide, therefore, is given in a loading dose of 100 mg daily for 3 days followed by 20 mg OD.

Adverse effects of leflunomide are diarrhoea, headache, nausea, rashes, loss of hair, thrombocytopenia, leucopenia, increased chances of chest infection and raised hepatic transaminases. It is not to be used in children and pregnant/lactating women. Leflunomide is an alternative to Mtx or can be added to it, but the combination is more hepatotoxic. Combination with sulfasalazine improves benefit.

LEFRA 10 mg, 20 mg tab.

5. Gold

Gold is considered to be the most effective agent for arresting the rheumatoid process and preventing involvement of additional joints. It was the standard DMARD before the advent of low-dose Mtx regimen. A remission is induced in over half of the patients. It reduces chemotaxis, phagocytosis, macrophage and lysosomal activity, monocyte differentiation and inhibits cell mediated immunity (CMI). Rheumatoid factor levels and ESR are lowered. By an effect on synovial membrane and collagen, it prevents joint destruction; may induce healing of bony erosions. It is effective in psoriatic arthropathy also.

Gold is heavily bound to plasma and tissue proteins, especially in kidney : stays in the body for years.

Toxicity of parenteral gold salt (hypotension, dermatitis, stomatitis, kidney and liver damage, bone marrow depression) is high. It is rarely used now.

Auranofin It is an orally active gold compound containing 29% gold, with a bioavailability of 25%. Plasma gold levels and efficacy are lower than with injected gold sod. thiomalate, but it is less toxic. Main adverse effect is diarrhoea (30% incidence) and abdominal cramps. Others are: pruritus, taste disturbances, mild anaemia and alopecia. Auranofin is used infrequently.

Dose: 6 mg/day in 1 or 2 doses; **RIDAURA** 3 mg cap, **GOLDAR** 3 mg tab.

6. d-Penicillamine

It is a copper chelating agent (*see* Ch. 66) with a gold-like action in RA, but less efficacious; bony erosions do not heal. It is not favoured now because it does not offer any advantage in terms of toxicity, which is similar to that of gold. Loss of taste, systemic lupus and myasthenia gravis are the other adverse effects.

Penicillamine increases soluble collagen and is the preferred drug for stage II and III scleroderma.

Dose: start with 125–250 mg OD, then 250 mg BD; **ARTIN** 150, 200 mg caps; **CILAMIN** 250 mg cap.

7. Biologic response modifiers

Recently, several recombinant proteins/monoclonal antibodies that bind and inhibit cytokines, especially TNF α or IL-1 have been produced and found to afford substantial benefit in autoimmune diseases like RA, inflammatory bowel diseases, psoriasis, scleroderma, etc.

TNF α inhibitors

Because TNF α plays a key role in the inflammatory cascade of RA by activating membrane bound receptors (TNFR $_1$ and TNFR $_2$) on the surface of T-cells, macrophages, etc., exogenously administered soluble TNF-receptor protein or antibody can neutralize it and interrupt the reaction. TNF inhibitors mainly suppress macrophage and T-cell function; inflammatory changes in the joint regress and

new erosions are slowed. Quicker response than DMARDs has been obtained. Though effective as monotherapy, they are generally added to Mtx when response to the latter is not adequate or in rapidly progressing cases. Side effects are few, but susceptibility to opportunistic infections, including tuberculosis and pneumocystis pneumonia is increased. All are very expensive.

Etanercept: It is a recombinant fusion protein of TNF-receptor and Fc portion of human IgG₁; administered by s.c. injection 50 mg weekly. Pain, redness, itching and swelling occur at injection site and chest infections may be increased, but immunogenicity is not a clinical problem.

Infliximab: It is a chimeral monoclonal antibody which binds and neutralizes TNF α ; 3–5 mg/kg is infused i.v. every 4–8 weeks. An acute reaction comprising of fever, chills, urticaria, bronchospasm, rarely anaphylaxis may follow the infusion. Susceptibility to respiratory infections is increased and worsening of CHF has been noted. It is usually combined with Mtx which improves the response and decreases antibody formation against infliximab.

Adalimumab: This recombinant monoclonal anti-TNF antibody is administered s.c. 40 mg every 2 weeks. Injection site reaction and respiratory infections are the common adverse effects. Combination with Mtx is advised to improve the response and decrease antibody formation.

IL-1 antagonist

Anakinra: It is a recombinant human IL-1 receptor antagonist. Though clinically less effective than TNF inhibitors, it has been used in cases who have failed on one or more DMARDs.

Dose: 100 mg s.c. daily.

Local reaction and chest infections are the main adverse effects.

8. Corticosteroids (see Ch. 20)

They have potent immunosuppressant and anti-inflammatory activity: can be inducted almost at any stage in RA along with first or second line drugs, if potent antiinflammatory action is required while continuing the NSAID \pm DMARD. Symptomatic relief is prompt, but they do not arrest the rheumatoid process, though joint destruction may be slowed and bony erosions delayed.

Long-term use of corticosteroids carries serious disadvantages. Therefore, either low doses (5–10 mg prednisolone or equivalent) are used to supplement NSAIDs (once used in this manner, it is difficult to withdraw steroids—exacerbation is precipitated: patient becomes steroid

dependent), or high doses are employed over short periods in cases with severe systemic manifestations (organ-threatening disease, vasculitis) while the patient awaits response from a remission inducing drug.

In cases with single or few joint involvement with severe symptoms, intraarticular injection of a soluble glucocorticoid affords relief for several weeks; joint damage may be slowed. However, this procedure should not be repeated before 4–6 months.

DRUGS USED IN GOUT

Gout It is a metabolic disorder characterized by hyperuricaemia (normal plasma urate 1–4 mg/dl). Uric acid, a product of purine metabolism, has low water solubility, especially at low pH. When blood levels are high, it precipitates and deposits in joints, kidney and subcutaneous tissue (tophy).

Secondary hyperuricaemia occurs in:

- Leukaemias, lymphomas, polycythaemia—especially when treated with chemotherapy or radiation: due to enhanced nucleic acid metabolism and uric acid production.
- Drug induced—thiazides, furosemide, pyrazinamide, ethambutol, levodopa, clofibrate reduce uric acid excretion by kidney.

Drugs used in gout are:

For acute gout

NSAIDs
Colchicine
Corticosteroids

For chronic gout / hyperuricaemia

Uricosurics *Synthesis inhibitor*
Probenecid Allopurinol
Sulfinpyrazone

ACUTE GOUT

Acute gout manifests as sudden onset of severe inflammation in a small joint (commonest is metatarso-phalangeal joint of great toe) due to precipitation of urate crystals in the joint space.

The joint becomes red, swollen and extremely painful: requires immediate treatment.

1. NSAIDs

One of the strong antiinflammatory drugs, e.g. *indomethacin*, *naproxen*, *piroxicam*, *diclofenac* or *etoricoxib* is given in relatively high and quickly repeated doses. They are quite effective in terminating the attack, but may take 12–24 hours, i.e. response is somewhat slower than with colchicine, but they are generally better tolerated; majority of patients prefer them over colchicine. Their strong antiinflammatory (not uricosuric) action is responsible for the benefit. Naproxen and piroxicam specifically inhibit chemotactic migration of leucocytes into the inflamed joint. After the attack is over, they may be continued at lower doses for 3–4 weeks while drugs to control hyperuricaemia take effect. They are not recommended for long term management due to risk of toxicity.

The NSAIDs have also substituted colchicine for covering up the period of initiation of therapy (6–8 weeks) with allopurinol or uricosurics in chronic gout.

2. Colchicine

It is an alkaloid from *Colchicum autumnale* which was used in gout since 1763. The pure alkaloid was isolated in 1820.

Colchicine is neither analgesic nor anti-inflammatory, but it specifically suppresses gouty inflammation. It does not inhibit the synthesis or promote the excretion of uric acid. Thus, it has no effect on blood uric acid levels.

An acute attack of gout is started by the precipitation of urate crystals in the synovial fluid. They start an inflammatory response, chemotactic factors are produced → granulocyte migration into the joint; they phagocytose urate crystals and release a glycoprotein which aggravates the inflammation by:

- (i) Increasing lactic acid production from inflammatory cells → local pH is reduced → more urate crystals are precipitated in the affected joint.

- (ii) Releasing lysosomal enzymes which cause joint destruction.

Colchicine does not affect phagocytosis of urate crystals but inhibits release of the glycoprotein and the subsequent events. By binding to fibrillar protein tubulin, it inhibits granulocyte migration into the inflamed joint and thus interrupts the vicious cycle. Other actions of colchicine are:

- (a) Antimitotic: causes metaphase arrest by binding to microtubules of mitotic spindle. It was tried for cancer chemotherapy but abandoned due to toxicity. It is used to produce polyploidy in plants.
- (b) Increases gut motility through neural mechanisms.

Pharmacokinetics Colchicine is rapidly absorbed orally, partly metabolized in liver and excreted in bile—undergoes enterohepatic circulation; ultimate disposal occurs in urine and faeces over many days.

Toxicity is high and dose related.

Nausea, vomiting, watery or bloody diarrhoea and abdominal cramps occur as dose limiting adverse effects. Accumulation of the drug in intestine and inhibition of mitosis in its rapid turnover mucosa is responsible for the toxicity. In overdose, colchicine produces kidney damage, CNS depression, intestinal bleeding; death is due to muscular paralysis and respiratory failure.

Chronic therapy with colchicine is not recommended because it causes aplastic anaemia, agranulocytosis, myopathy and loss of hair.

Use

- (a) **Treatment of acute gout** Colchicine is the fastest acting drug to control an acute attack of gout; 1 mg orally followed by 0.25 mg 1–3 hourly till control of the attack is achieved (occurs in 4–12 hour), or till total dose 6 mg is reached, or diarrhoea starts. The response is dramatic, so much so that it may be considered diagnostic. However, because of higher toxicity, most physicians prefer using a NSAID. Maintenance doses (0.5–1 mg/day) may be given for 4–8 weeks

in which time control of hyperuricaemia is achieved with other drugs.

(b) *Prophylaxis* Colchicine 0.5–1 mg/day can prevent further attacks of acute gout, but NSAIDs are generally preferred.

Taken at the first symptom of an attack, small doses (0.5–1.5 mg) of colchicine abort it.

COLCHINDON, GOUTNIL 0.5 mg tab.

3. Corticosteroids

Intraarticular injection of a soluble steroid suppresses symptoms of acute gout. Crystalline preparations should not be used. It is indicated in refractory cases and those not tolerating NSAIDs/colchicine.

Systemic steroids are rarely needed. They are very effective and produce nearly as rapid a response as colchicine, but are reserved for patients with renal failure/history of peptic ulcer bleed in whom NSAIDs are contraindicated or for cases not responding to or not tolerating NSAIDs. Prednisolone 40–60 mg may be given in one day, followed by tapering doses over few weeks.

CHRONIC GOUT

When pain and stiffness persist in a joint between attacks, gout has become chronic. Other cardinal features are hyperuricaemia, tophi (chalk-like stones under the skin in pinna, eyelids, nose, around joints and other places) and urate stones in the kidney. Chronic gouty arthritis may cause progressive disability and permanent deformities.

A. URICOSURIC DRUGS

1. Probenecid

It is a highly lipid-soluble organic acid developed in 1951 to inhibit renal tubular secretion of penicillin so that its duration of action could be prolonged. It competitively blocks active transport of organic acids by OATP at all sites; that in renal tubules being the most prominent. This transport is bidirectional: net effect depends on whether

secretion or reabsorption of the particular organic acid is quantitatively more important, e.g.:

(a) Penicillin is predominantly secreted by the proximal tubules, its reabsorption is minimal. Net effect of probenecid is inhibition of excretion; more sustained blood levels are achieved.

(b) Uric acid is largely reabsorbed by active transport, while less of it is secreted; only 1/10th of filtered load is excreted in urine. Probenecid, therefore, promotes its excretion and reduces its blood level.

Probenecid does not have any other significant pharmacological action; it is neither analgesic nor antiinflammatory.

Interactions

1. In addition to penicillins, probenecid inhibits the urinary excretion of cephalosporins, sulfonamides, Mtx and indomethacin.
2. It inhibits biliary excretion of rifampicin. Pyrazinamide and ethambutol may interfere with uricosuric action of probenecid.
3. Probenecid inhibits tubular secretion of nitrofurantoin which may not attain antibacterial concentration in urine.
4. Salicylates block uricosuric action of probenecid.

Pharmacokinetics Probenecid is completely absorbed orally; 90% plasma protein bound: partly conjugated in liver and excreted by the kidney; plasma $t_{1/2}$ is 8–10 hours.

Adverse effects Probenecid is generally well tolerated.

Dispepsia is the most common side effect (upto 25% incidence with high doses). It should be used cautiously in peptic ulcer patients. Rashes and other hypersensitivity phenomena are rare. Toxic doses cause convulsions and respiratory failure.

Uses

1. Chronic gout and hyperuricaemia: Probenecid is a second line/adjuvant drug to allopurinol. Started at 0.25 g BD and increased to

0.5 g BD, it gradually lowers blood urate level; arthritis, tophi and other lesions may take months to resolve. Colchicine/NSAID cover is advised during the initial 1–2 months to avoid precipitation of acute gout.

Probenecid and other uricosurics are ineffective in the presence of renal insufficiency (serum creatinine > 2 mg/dl). Plenty of fluids should be given with probenecid to avoid urate crystallization in urinary tract.

2. Probenecid is also used to prolong penicillin or ampicillin action by enhancing and sustaining their blood levels, e.g. in gonorrhoea, SABE.

BENEMID, BENCID 0.5 g tab.

2. Sulfapyrazone

It is a pyrazolone derivative related to phenylbutazone having consistent uricosuric action, but is neither analgesic nor antiinflammatory. At the usual therapeutic doses, it inhibits tubular reabsorption of uric acid, but smaller doses can decrease urate excretion as do small doses of probenecid. Its uricosuric action is additive with probenecid but antagonised by salicylates. It inhibits platelet aggregation.

Pharmacokinetics Sulfapyrazone is well absorbed orally; 98% plasma protein bound—displacement interactions can occur. Excretion is fairly rapid, mainly by active secretion in proximal tubule. Uricosuric action of a single dose lasts for 6–10 hours.

Sulfapyrazone inhibits metabolism of sulfonylureas and warfarin.

Adverse effects Gastric irritation is the most common side effect—contraindicated in patients with peptic ulcer.

Rashes and other hypersensitivity reactions are uncommon.

Unlike phenylbutazone, it does not produce fluid retention or blood dyscrasias.

Uses In chronic gout, the results are comparable to probenecid; same precautions should be exercised. Start with 100–200 mg BD, gradually

increase according to response, maximal dose 800 mg/day.

ANTURANE, ARTIRAN 200 mg cap.

Benzbromarone is another uricosuric drug marketed in Europe, but not in India.

B. URIC ACID SYNTHESIS INHIBITOR

Allopurinol

This hypoxanthine analogue was synthesized as a purine antimetabolite for cancer chemotherapy. However, it had no antineoplastic activity but was a substrate as well as inhibitor of *xanthine oxidase*, the enzyme responsible for uric acid synthesis (Fig. 15.1).

Allopurinol itself is a short-acting ($t_{1/2}$ 2 hrs) competitive inhibitor of xanthine oxidase, but its major metabolite *alloxanthine* (*oxypurine*) is a long-acting ($t_{1/2}$ 24 hrs) and noncompetitive inhibitor—primarily responsible for uric acid synthesis inhibition *in vivo*. During allopurinol administration, plasma concentration of uric acid is reduced and that of hypoxanthine and xanthine is somewhat increased. In place of uric acid alone, all 3 oxipurines are excreted in urine. Since xanthine and hypoxanthine are more soluble, have a higher renal clearance than that of uric acid and each has its individual solubility, precipitation and crystallization in tissues and urine does not occur.

Because of raised levels of xanthine and hypoxanthine, some feedback inhibition of *de novo* purine synthesis and reutilization of metabolically derived purine also occurs.

Pharmacokinetics About 80% of orally administered allopurinol is absorbed. It is not bound to plasma proteins; metabolized largely to alloxanthine. During chronic medication, it inhibits its own metabolism and about 1/3rd is excreted unchanged, the rest as alloxanthine.

Interactions

(a) Allopurinol inhibits the degradation of 6-mercaptopurine and azathioprine: their doses should be reduced to 1/3rd, but not that of thioguanine, because it follows a different metabolic path (S-methylation).

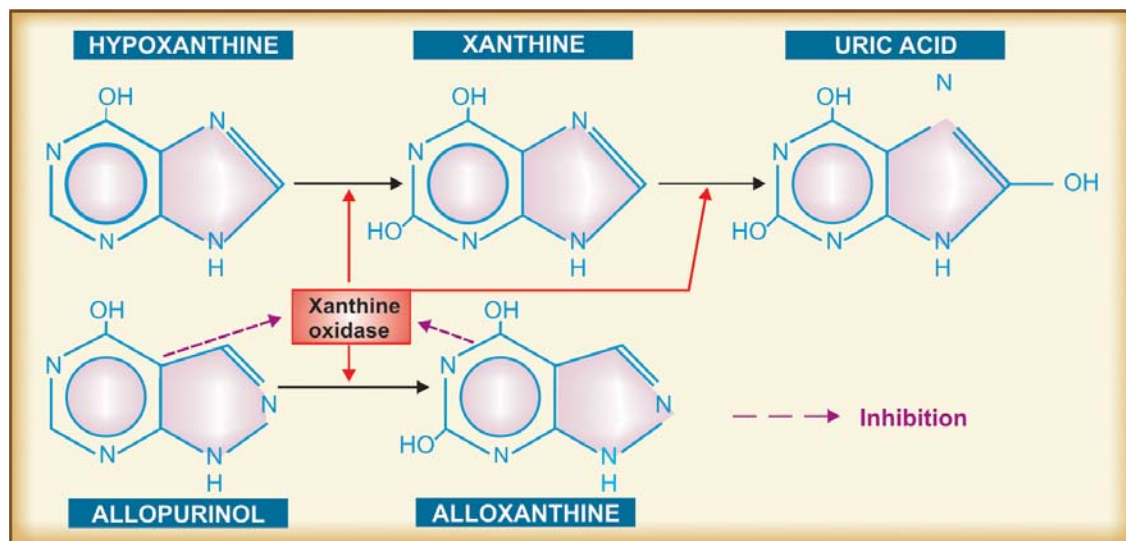

Fig. 15.1: Uric acid synthesis and the action of allopurinol

(b) Probenecid given with allopurinol has complex interaction; while probenecid shortens $t_{1/2}$ of alloxanthine, allopurinol prolongs $t_{1/2}$ of probenecid.

(c) Allopurinol can potentiate warfarin and theophylline by inhibiting their metabolism.

(d) A higher incidence of skin rashes has been reported when ampicillin is given to patients on allopurinol.

(e) Iron therapy is not recommended during allopurinol treatment. The exact nature of interaction is not known, but interference with mobilization of hepatic iron stores is suggested.

Adverse effects These are uncommon.

Hypersensitivity reaction consisting of rashes, fever, malaise and muscle pain is the most frequent. It subsides on stopping the drug. Renal impairment increases the incidence of rashes and other reactions to allopurinol.

Stevens-Johnson syndrome is a rare but serious risk.

Gastric irritation, headache, nausea and dizziness are infrequent; do not need withdrawal.

Liver damage is rare.

Precautions and contraindications Liberal fluid intake is advocated during allopurinol therapy.

It is contraindicated in hypersensitive patients, during pregnancy and lactation.

It should be cautiously used in the elderly, children and in kidney or liver disease.

Uses Allopurinol is the first choice drug in chronic gout. It can be used in both *over producers* and *under excretors* of uric acid, particularly more severe cases, with tophi or nephropathy. Uricosurics are infrequently used in India; they are less effective when g.f.r. is low and are inappropriate in stone formers. The two classes of drugs can also be used together when the body load of urate is large.

With long-term allopurinol therapy, tophi gradually disappear and nephropathy is halted, even reversed.

Secondary hyperuricaemia due to cancer chemotherapy/radiation/thiazides or other drugs: can be controlled by allopurinol. It can even be used prophylactically in these situations.

To potentiate 6-mercaptopurine or azathioprine in cancer chemotherapy and immunosuppressant therapy.

Dose: Start with 100 mg OD, gradually increase to maintenance dose of 300 mg/day; maximum 600 mg/day.

ZYLORIC 100, 300 mg tabs., ZYLOPRIM, CIPLORIC 100 mg cap.

Caution Allopurinol as well as uricosurics should not be started during acute attack of gout. During the initial 1–2 months of treatment with these drugs, attacks of acute gout are more common—probably due to fluctuating plasma

urate levels favouring intermittent solubilization and recrystallization in joints; cover with NSAIDs/colchicine may be provided.

Kala-azar Allopurinol inhibits *Leishmania* by altering its purine metabolism. It is used as adjuvant to sodium stibogluconate in resistant kala-azar cases (*see* Ch. 60).

Respiratory System Drugs

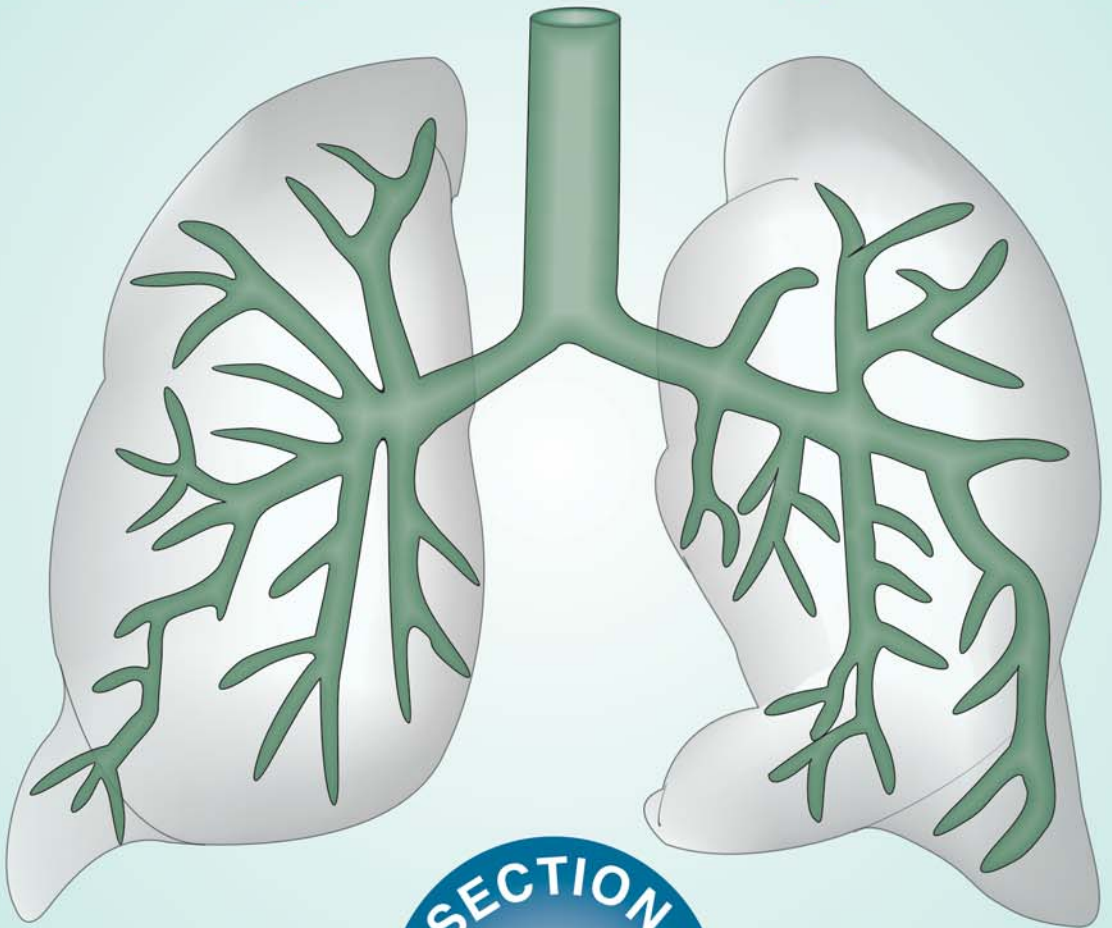

SECTION
4

CHAPTER 16

Drugs for Cough and Bronchial Asthma



DRUGS FOR COUGH

Cough is a protective reflex, its purpose being expulsion of respiratory secretions or foreign particles from air passages. It occurs due to stimulation of mechano- or chemoreceptors in throat, respiratory passages or stretch receptors in the lungs. Cough may be useful or useless. Useless (nonproductive) cough should be suppressed. Useful (productive) cough serves to drain the airway, its suppression is not desirable, may even be harmful, except if the amount of expectoration achieved is small compared to the effort of continuous coughing. Apart from specific remedies (antibiotics, etc. *see* box), cough may be treated as a symptom (nonspecific therapy) with:

1. **Pharyngeal demulcents** Lozenges, cough drops, linctuses containing syrup, glycerine, liquorice.
2. **Expectorants (Mucokinetics)**
 - (a) *Bronchial secretion enhancers* Sodium or Potassium citrate, Potassium iodide, Guaiphenesin (Glyceryl guaiacolate), balsum of Tolu, Vasaka, Ammonium chloride.
 - (b) *Mucolytics* Bromhexine, Ambroxol, Acetyl cysteine, Carbocisteine

3. **Antitussives (Cough centre suppressants)**

- (a) *Opioids* Codeine, Pholcodeine.
- (b) *Nonopioids* Noscapine, Dextromethorphan, Chlophedianol.
- (c) *Antihistamines* Chlorpheniramine, Diphenhydramine, Promethazine.

4. **Adjuvant antitussives**

Bronchodilators Salbutamol, Terbutalin.

DEMULCENTS AND EXPECTORANTS

Pharyngeal demulcents soothe the throat and reduce afferent impulses from the inflamed/irritated pharyngeal mucosa, thus provide symptomatic relief in dry cough arising from throat.

Expectorants (Mucokinetics) are drugs believed to increase bronchial secretion or reduce its viscosity, facilitating its removal by coughing.

Sodium and potassium citrate are considered to increase bronchial secretion by salt action. Potassium iodide is secreted by bronchial glands and can irritate the airway mucosa. Prolonged use can affect thyroid function and produce iodism. It is rarely used now. Guaiphenesin, vasaka, tolu balsum are plant products which are supposed to enhance bronchial secretion and mucociliary function while being secreted by tracheobronchial glands. Ammonium salts are

Specific treatment approaches to cough

Etiology of cough

- Upper/lower respiratory tract infection
- Smoking/chronic bronchitis
- Pulmonary tuberculosis
- Asthmatic cough
- Postnasal drip due to sinusitis
- Postnasal drip due to allergic/perennial rhinitis
- Gastroesophageal reflux
- ACE inhibitor associated cough

Treatment approach

Appropriate antibiotics
 Cessation of smoking/avoidance of pollutants
 Antitubercular drugs
 Inhaled β_2 agonists/ipratropium/corticosteroids
 Antibiotic, nasal decongestant, H₁ antihistaminic
 Avoidance of precipitating factor(s), corticosteroid nasal spray, H₁ antihistaminic
 Bed head elevation, light dinner, diet modification, H₂ blocker, proton pump inhibitor, cisapride
 Substitute ACE inhibitor by losartan, calcium channel blocker, NSAID

nauseating—reflexly increase respiratory secretions. A variety of expectorant formulations containing an assortment of the above ingredients, often in combination with antitussives/antihistaminics are marketed and briskly promoted, but objective evidence of efficacy of these is non-conclusive.

Mucolytics

Bromhexine A derivative of the alkaloid *vasicine* obtained from *Adhatoda vasica* (Vasaka), is a potent mucolytic and mucokinetic, capable of inducing thin copious bronchial secretion. It depolymerises mucopolysaccharides directly as well as by liberating lysosomal enzymes—network of fibres in tenacious sputum is broken. It is particularly useful if mucus plugs are present. *Side effects* are rhinorrhoea and lacrimation, gastric irritation, hypersensitivity.

Dose: adults 8 mg TDS, children 1–5 years 4 mg BD, 5–10 years 4 mg TDS.

BROMHEXINE 8 mg tablet, 4 mg/5 ml elixir.

Ambroxol A metabolite of bromhexine having similar mucolytic action, uses and side effects.

Dose: 15–30 mg TDS.

AMBROLIL, AMBROLITE, AMBRODIL, MUCOLITE 30 mg tab, 30 mg/5 ml liquid, 7.5 mg/ml drops.

Acetylcysteine It opens disulfide bonds in mucoproteins present in sputum—makes it less viscid, but has to be administered directly into the respiratory tract.

MUCOMIX 200 mg/ml inj in 1,2,5 ml amps; injectable solution may be nebulized/instilled through trachostomy tube.

Carbocisteine It liquefies viscid sputum in the same way as acetylcysteine and is administered orally (250–750 mg TDS). Some patients of chronic bronchitis have been shown to benefit. Side effects are g.i. irritation and rashes.

MUCODYNE 375 mg cap, 250 mg/5 ml syr.

It is available in combination with amoxicillin or cephalexin for treatment of bronchitis, bronchiectasis, sinusitis, etc.

CARBOMOX: Carbocisteine 150 mg + amoxicillin 250 or 500 mg caps. **CARBICEF:** Carbocisteine 150 mg + cephalexin 250 or 500 mg caps.

ANTITUSSIVES

These are drugs that act in the CNS to raise the threshold of cough centre or act peripherally in the respiratory tract to reduce tussal impulses, or both these actions. Because they aim to control rather than eliminate cough, antitussives should be used only for dry unproductive cough or if cough is unduly tiring, disturbs sleep or is hazardous (hernia, piles, cardiac disease, ocular surgery).

Opioids

Codeine (see Ch. 34) An opium alkaloid, qualitatively similar to but less potent than morphine. It is more selective for cough centre and is treated as the standard antitussive; suppresses cough for about 6 hours. The antitussive action is blocked by naloxone indicating that it is exerted through opioid receptors in the brain. Abuse liability is low, but present; constipation is the chief draw-

back. At higher doses respiratory depression and drowsiness can occur—driving may be impaired. Like morphine, it is contraindicated in asthmatics and in patients with diminished respiratory reserve.

Dose: 10–30 mg; children 2–6 years 2.5–5 mg, 6–12 years 5–10 mg, frequently used as syrup codeine phos. 4–8 ml.
CODINE 15 mg tab, 15 mg/5 ml linctus.

Pholcodeine It has practically no analgesic or addicting property, but is similar in efficacy as antitussive to codeine and is longer acting—acts for 12 hours; dose: 10–15 mg.
(ETHNINE 5 mg/5 ml syr).

Nonopioids

Noscapine (Narcotine) An opium alkaloid of the benzoisoquinoline series (*see* Ch. 34). It depresses cough but has no narcotic, analgesic or dependence inducing properties. It is nearly equipotent antitussive as codeine, especially useful in spasmodic cough. Headache and nausea occur occasionally as side effect. It can release histamine and produce bronchoconstriction in asthmatics.
Dose: 15–30 mg, children 2–6 years 7.5 mg, 6–12 years 15 mg.
COSCOPIN 7 mg/5 ml syrup, COSCOTABS 25 mg tab.

Dextromethorphan A synthetic compound; the *d*-isomer has selective antitussive action (raises threshold of cough centre) while *l*-isomer is analgesic. Dextromethorphan is as effective as codeine, does not depress mucociliary function of the airway mucosa and is practically devoid of constipating and addicting actions. The antitussive action lasts for ~6 hours and is not blocked by naloxone: therefore not exerted through opioid receptors.

Side effect: Dizziness, nausea, drowsiness, ataxia.
Dose: 10–20 mg, children 2–6 years 2.5–5 mg, 6–12 years 5–10 mg.

Chlophedianol It is a centrally acting antitussive with slow onset and longer duration of action.
Side effect: Dryness of mouth, vertigo, irritability.
Dose: 20–40 mg; **DETIGON, TUSSIGON 20 mg/5 ml linctus with Ammon. chloride 50 mg and menthol 0.25 mg.**

Antihistamines

Many H₁ antihistamines have been conventionally added to antitussive/expectorant

formulations (*see* below). They afford relief in cough due to their sedative and anticholinergic actions, but lack selectivity for the cough centre. They have no expectorant property, may even reduce secretions by anticholinergic action. They have been specially promoted for cough in respiratory allergic states, though their lack of efficacy in asthma is legendary.

Chlorpheniramine (2–5 mg), Diphenhydramine (15–25 mg) and Promethazine (15–25 mg; **PHENERGAN 5 mg/5 ml elixir**) are commonly used. Second generation antihistamines like fexofenadine, loratadine are ineffective.

Bronchodilators Bronchospasm can induce or aggravate cough. Stimulation of pulmonary receptors can trigger both cough and bronchoconstriction, especially in individuals with bronchial hyperreactivity. Bronchodilators relieve cough in such individuals and improve the effectiveness of cough in clearing secretions by increasing surface velocity of airflow during cough. They should be used only when an element of bronchoconstriction is present and not routinely. Their fixed dose combinations with antitussives are not satisfactory because of differences in time course of action of the components and liability for indiscriminate use.

Fixed dose combinations of a centrally acting antitussive with a bronchodilator or with an antihistaminic having high atropinic activity have been banned in India, but many are still marketed.

Aeromatic chest rub is widely advertized as a cough remedy. Though it has been shown to reduce experimentally induced cough in healthy volunteers, there is no evidence of benefit in pathological cough.

SOME ANTITUSSIVE-EXPECTORANT COMBINATIONS

ASTHALIN EXPECTORANT: Salbutamol 2 mg, guaiphenesin 100 mg per 10 ml syr; dose 10–20 ml.

ASCORIL-C: Codeine 10 mg, chlorpheniramine 4 mg per 5 ml syr.

AXALIN: Ambroxol 15 mg, guaiphenesin 50 mg, salbutamol 1 mg, menthol 1 mg per 5 ml syr.

BRONCHOSOLVIN: Guaiphenesin 100 mg, terbutalin 2.5 mg, bromhexine 8 mg per 10 ml susp.

CADICOFF, GRILINCTUS: Dextromethorphan 5 mg, chlorpheniramine 2.5 mg, guaiphenesin 50 mg, Amm. chloride 60 mg per 5 ml syr.

BENADRYL COUGH FORMULA: Diphenhydramine 14 mg, amm. chlor. 138 mg, sod. citrate 57 mg, menthol 1.1 mg per 5 ml syrup; dose 5–10 ml, children 2.5–5 ml.

BRO-ZEDEX: Bromhexine 8 mg, guaiphenesin 100 mg, terbutaline 2.5 mg, menthol 5 mg per 10 ml syrup; dose 10 ml.

CADISTIN EXPECTORANT: Chlorpheniramine 2 mg, glyceryl guaiacolate 80 mg, amm. chlor. 100 mg, sod. citrate 44 mg, menthol 0.8 mg, terpin hydrate 4 mg, tolu balsum 6 mg, Vasaka syrup 0.13 ml per 5 ml syrup; dose 10 ml.

CLISTIN: Carbinoxamine 4 mg, amm. chlor. 240 mg, sod. citrate 240 mg per 10 ml syrup.

COREX: Chlorpheniramine 4 mg, codeine phos. 10 mg, menthol 0.1 mg per 5 ml syrup; dose 5 ml, children 1.25–2.5 ml.

COSCOPIN LINCTUS: Noscapine 7 mg, chlorpheniramine 2 mg, citric acid 29 mg, sod. citrate 3 mg, amm. chlor. 28 mg, per 5 ml syrup; dose 10–20 ml.

COSOME: Dextromethorphan 10 mg, phenylpropanolamine 25 mg, chlorpheniramine 4 mg per 10 ml syr; dose 10 ml.

GRILINCTUS: Dextromethorphan 5 mg, chlorpheniramine 2.5 mg, guaiphenesin 50 mg, ammon. chlor. 60 mg/5 ml syr; dose 5–10 ml.

GRILINCTUS SOFTCAPS: Dextromethorphan 10 mg, chlorpheniramine 2 mg, phenylpropanolamine 12.5 mg softcaps.

SOLVIN EXPECTORANT: Bromhexine 4 mg, pseudoephedrine 30 mg tablet and in 10 ml liquid; dose 1 tablet/5 ml liquid.

TOSSEX: Codeine phos 10 mg, chlorpheniramine 4 mg, menthol 1.5 mg, sod. citrate 75 mg per 5 ml liquid; dose 5 ml.

VENTORLIN EXPECTORANT: Salbutamol 2 mg, guaiphenesin 100 mg per 10 ml syrup; dose 10 ml, children 2.5–7.5 ml.

ZEET LINCTUS: Dextromethorphan 10 mg, guaiphenesin 50 mg, phenylpropanolamine 25 mg per 5 ml syr; dose 5 ml.

DRUGS FOR BRONCHIAL ASTHMA

Bronchial asthma is characterised by hyperresponsiveness of tracheobronchial smooth muscle to a variety of stimuli, resulting in narrowing of air tubes, often accompanied by increased secretion, mucosal edema and mucus plugging. Symptoms include dyspnoea, wheezing, cough and may be limitation of activity.

Asthma is now recognized to be a primarily inflammatory condition: inflammation underlying hyperreactivity. An allergic basis can be demonstrated in many adult, and higher percentage of pediatric patients. In others, a variety of trigger factors (infection, irritants, pollution, exercise, exposure to cold air, psychogenic) may be involved:

Extrinsic asthma: It is mostly episodic, less prone to status asthmaticus.

Intrinsic asthma: It tends to be perennial, status asthmaticus is more common.

Mast cells (present in lungs) and inflammatory cells recruited as a result of the initial reaction produce a multitude of mediators:

- Release of mediators stored in granules (*immediate*): histamine, protease enzymes, TNF α .
- Release of phospholipids from cell membrane followed by mediator synthesis (*within minutes*): PGs, LTs, PAF.
- Activation of genes followed by protein synthesis (*over hours*): Interleukins, TNF α .

These mediators together constrict bronchial smooth muscle, cause mucosal edema, hyperemia and produce viscid secretions, all resulting in reversible airway obstruction. The inflammation perpetuates itself by cell-to-cell communication and recruitment of more and more inflammatory cells. Bronchial smooth muscle hypertrophy occurs over time and damage to bronchial epithelium accentuates the hyperreactivity. Vagal discharge to bronchial muscle is enhanced reflexly. Airway remodeling progressively worsens the disease.

Chronic obstructive pulmonary disease (COPD) is a progressive disease with emphysema (alveolar destruction) and bronchiolar fibrosis in variable proportions. The expiratory airflow limitation does not fluctuate markedly over long periods of time but there are exacerbations precipitated by respiratory infections, pollutants, etc. It is clearly related to smoking and characteristically starts after the age of 40. Quitting smoking reduces the rate of decline in lung function. Patients derive <15% improvement in forced expiratory volume in 1 sec (FEV₁) following inhalation of a β agonist bronchodilator: airway obstruction is largely irreversible.

APPROACHES TO TREATMENT

1. *Prevention of AG:AB reaction*—avoidance of antigen, hyposensitization—possible in extrinsic asthma and if antigen can be identified.
2. *Neutralization of IgE (reaginic antibody)*—Omalizumab.
3. *Suppression of inflammation and bronchial hyperreactivity*—corticosteroids.
4. *Prevention of release of mediators*—mast cell stabilizers.
5. *Antagonism of released mediators*—leukotriene antagonists, antihistamines, PAF antagonists.
6. *Blockade of constrictor neurotransmitter*—anticholinergics.
7. *Mimicking dilator neurotransmitter*—sympathomimetics.
8. *Directly acting bronchodilators*—methylxanthines.

CLASSIFICATION

I. Bronchodilators

- A. β_2 Sympathomimetics: Salbutamol, Terbutaline, Bambuterol, Salmeterol, Formoterol, Ephedrine.
- B. Methylxanthines: Theophylline (anhydrous), Aminophylline, Choline theophyllinate, Hydroxyethyl theophylline, Theophylline ethanolate of piperazine, Doxophylline.
- C. Anticholinergics: Ipratropium bromide, Tiotropium bromide.

II. Leukotriene antagonists

Montelukast, Zafirlukast.

III. Mast cell stabilizers

Sodium cromoglycate, Ketotifen.

IV. Corticosteroids

- A. *Systemic*: Hydrocortisone, Prednisolone and others.
- B. *Inhalational*: Beclomethasone dipropionate, Budesonide, Fluticasone propionate, Flunisolide, Ciclesonide.

V. Anti-IgE antibody

Omalizumab

SYMPATHOMIMETICS (see Ch. 9)

Adrenergic drugs cause bronchodilatation through β_2 receptor stimulation \rightarrow increased cAMP formation in bronchial muscle cell \rightarrow relaxation. In addition, increased cAMP in mast cells and other inflammatory cells decreases mediator release. Since β_2 receptors on inflammatory cells are more prone to desensitization, the contribution of this action to the beneficial effect of β_2 agonists in asthma is uncertain. Adrenergic drugs are the mainstay of treatment of reversible airway obstruction but should be cautiously used in hypertensives, ischaemic heart disease patients and in those receiving digitalis. They are the fastest acting bronchodilators when inhaled.

Though adrenaline and isoprenaline are effective bronchodilators, it is the selective β_2 agonists that are now used in asthma to minimize cardiac side effects.

Salbutamol (Albuterol) A highly selective β_2 agonist; cardiac side effects are less prominent. Selectivity is further increased by inhaling the drug. Inhaled salbutamol produces bronchodilatation within 5 min and the action lasts for 2–4 hours. It is, therefore, used to abort and terminate attacks of asthma, but is not suitable for round-the-clock prophylaxis. Muscle tremors are the dose related side effect. Palpitation, restlessness, nervousness, throat irritation and ankle edema can also occur. Salbutamol undergoes presystemic metabolism in the gut wall, oral bioavailability is 50%. Oral salbutamol acts for 4–6 hours, is longer acting and safer than isoprenaline, but similar in efficacy.

Because of more frequent side effects, oral β_2 agonist therapy is reserved for patients who cannot correctly use inhalers or as alternative/adjuvant drugs in severe asthma.

Dose: 2–4 mg oral, 0.25–0.5 mg i.m./s.c., 100–200 μ g by inhalation.

ASTHALIN 2, 4 mg tab., 8 mg SR tab., 2 mg/5 ml syrup, 100 μ g metered dose inhaler; 5 mg/ml respirator soln., 200 μ g rota caps; CROYSAL 0.5 mg/ml inj, SALOL 2.5 mg/3 ml inj; VENTORLIN 2 mg/5 ml syr, 4 mg, 8 mg CR caps; DERIHALER 100 μ g metered dose inhaler.

Single enantiomer preparation of R(-) salbutamol has also been marketed, because it is the active β_2 agonist and more potent bronchodilator which may produce fewer side effects than the racemate.

Terbutaline It is similar to salbutamol in properties and use.

Dose: 5 mg oral, 0.25 mg s.c., 250 μ g by inhalation.

TERBUTALINE, BRICAREX 2.5, 5 mg tab., 3 mg/5 ml syrup, 0.5 mg/ml inj; MISTHALER 250 μ g/metered dose, 10 mg/ml nebulizing soln.; BRICANYL 0.5 mg/ml inj, 2.5 mg, 5 mg tabs, 1.5 mg/5 ml syr.

Inhaled salbutamol and terbutaline are currently the most popular drugs for quick reversal or bronchospasm, but should not be used on any regular schedule. Regular use does not reduce bronchial hyperreactivity; may even worsen it—this may be responsible for the diminished responsiveness seen after long-term use of these drugs. Regular use also down regulates bronchial β_2 receptors. It is advised that patients requiring regular medication should be treated with inhaled steroids, and use of β_2 agonist inhalers should be restricted to symptomatic relief of wheezing.

Bambuterol This bis-carbamate ester prodrug of terbutaline is slowly hydrolysed in plasma and lungs by pseudocholinesterase to release the active drug over 24 hours. Reversible inhibition of pseudocholinesterase occurs in a dose dependent manner. It is indicated in chronic bronchial asthma in a single evening dose of 10–20 mg.

BAMBUDIL 10 mg, 20 mg tabs, 5 mg/5 ml oral soln.; BETADAY 10, 20 mg tabs.

Salmeterol It is the first long-acting selective β_2 agonist with a slow onset of action; used by inhalation on a twice daily schedule for maintenance therapy and for nocturnal asthma, but not for acute symptoms. It is also more β_2 selective than salbutamol, and more lipophilic which probably accounts for its longer action. Concern of asthma worsening due to regular use of inhaled β_2 agonists applies to salmeterol also. However, clinical studies have shown sustained improvement in asthma symptoms and lung function. Concurrent use of inhaled salmeterol

with inhaled glucocorticoid produces effects equivalent to double dose of the corticoid alone. It is advocated that long-acting β_2 agonists should be used only in combination with an inhaled steroid; combined formulations are available.

COPD: Long-acting β_2 agonists are superior to short-acting ones, and equivalent to inhaled anticholinergics in COPD. They reduce breathlessness by abolishing the reversible component of airway obstruction.

SALMETER, SEROBID 25 μ g per metered dose inhaler; 2 puffs BD; severe cases 4 puffs BD; also SEROBID ROTACAPS 50 μ g; 1–2 caps BD by inhalation.

SEROFLO—100/250/500 ROTACAPS: Salmeterol 50 μ g + fluticasone 100 μ g/250 μ g/500 μ g per rotacap

SEROFLO—125/250 INHALERS: Salmeterol 25 μ g + fluticasone 125 μ g/250 μ g per puff.

Formoterol Another long-acting selective β_2 agonist which acts for 12 hrs when inhaled. In comparison to salmeterol, it has a faster onset of action. It is used on a regular morning-evening schedule for round-the-clock bronchodilatation.

Dose: 12–24 μ g by inhalation twice daily.

FORATEC 12 μ g rotacaps.

Ephedrine It has α + β_1 + β_2 actions; causes mild slowly developing bronchodilatation lasting for 3–5 hours. It is a constituent of older combination formulations and is used for mild to moderate chronic asthma. Because of low efficacy and frequent side effects, it is not preferred now.

METHYL XANTHINES

Theophylline and its compounds have been extensively used in asthma, but are not considered first line drugs any more. They are used more often in COPD. Theophylline is one of the three naturally occurring methylated xanthine alkaloids *caffeine*, *theophylline* and *theobromine*. The chemical relation between the three is depicted below:

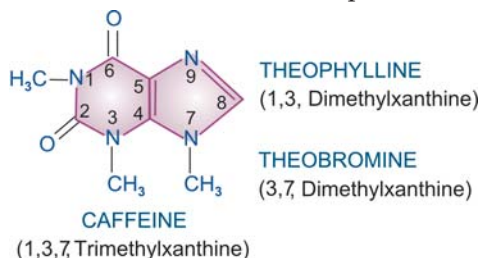

They are consumed as beverages. The sources and average alkaloid contents of the beverages, as they are usually prepared are given below.

Source	Alkaloid content in beverage		
1. <i>Thea sinensis</i> (Tea leaves)	Caffeine	50 mg	in an average cup of tea
	Theophylline	1 mg	
2. <i>Coffea arabica</i> (Coffee seeds)	Caffeine	75 mg	in an average cup of coffee
3. <i>Theobroma cacao</i> (Cocoa, chocolate)	Theobromine	200 mg	in an average cup of cocoa
	Caffeine	4 mg	
4. <i>Cola acuminata</i> (Guru nuts)	Caffeine	30 mg	in 200 ml bottle of cola drink

All three alkaloids have qualitatively similar actions, but there are marked quantitative (Table 16.1) and pharmacokinetic differences.

Pharmacological actions

1. CNS Caffeine and theophylline are CNS stimulants, primarily affect the higher centres. Caffeine 150–250 mg produces a sense of well-being, alertness, beats boredom, allays fatigue, thinking becomes clearer even when dullness has tended to prevail after a sustained intellectual effort. It tends to improve performance and increase motor activity. Caffeine is more active than theophylline in producing these effects. Higher doses cause nervousness, restlessness, panic, insomnia and excitement. Still higher doses

produce tremors, delirium and convulsions. Theophylline has greater propensity to produce these adverse effects at higher doses and is definitely more toxic than caffeine.

They also stimulate medullary vagal, respiratory and vasomotor centres. Vomiting at high doses is due both to gastric irritation and CTZ stimulation.

2. CVS Methylxanthines directly stimulate the heart and increase force of myocardial contractions. They tend to increase heart rate by direct action, but decrease it by causing vagal stimulation—net effect is variable. Tachycardia is more common with theophylline, but caffeine generally decreases heart rate. Cardiac output and cardiac work are increased. At high doses cardiac arrhythmias may be produced.

While consumption of > 9 cups of coffee per day has been found to be associated with increased incidence of arrhythmias, moderate ingestion of caffeine (upto 500 mg/day) does not increase frequency or severity of cardiac arrhythmias even in patients with ischaemic heart disease or preexisting ventricular extrasystoles.

Methylxanthines, especially theophylline, dilate systemic blood vessels, including coronaries, by direct action: peripheral resistance is reduced. However, cranial vessels are constricted, especially by caffeine; this is one of the basis of its use in migraine.

Effect on BP is variable and unpredictable—

- Vasomotor centre and direct cardiac stimulation—tends to raise BP.
- Vagal stimulation and direct vasodilatation—tends to lower BP.

Usually a rise in systolic and fall in diastolic BP is observed.

3. Smooth muscles All smooth muscles are relaxed, most prominent effect is exerted on bronchi, especially in asthmatics. Theophylline is more potent than caffeine. Slow and sustained dose-related bronchodilatation is produced, but the effect is much less marked compared to inhaled β_2 agonists. Vital capacity is increased. Biliary spasm is relieved, but effect on intestines and urinary tract is negligible.

Table 16.1: Comparative pharmacological actions of caffeine and theophylline

ACTION	CAFF.	THEO.
1. CNS—stimulation (low dose)	+++	++
—toxicity	++	+++
2. Heart—stimulation	++	+++
3. Blood vessel—relaxation	+	++
4. Bronchi—dilatation	+	+++
5. Kidney—diuresis	+	++
6. Sk. muscle—increased contractility	+++	++
7. Gastric mucosa—irritation	+	++
8. Phosphodiesterase inhibition	++	+++
9. Adenosine antagonism	++	+++

CAFF—Caffeine; THEO—Theophylline
Theobromine is of no therapeutic importance.

4. **Kidney** Methylxanthines are mild diuretics; act by inhibiting tubular reabsorption of Na^+ and water. In addition, vascular effects may result in increased renal blood flow and g.f.r. Theophylline is more potent, but action is brief.

5. **Skeletal muscles** Caffeine enhances contractile power of skeletal muscles. At high concentrations it increases release of Ca^{2+} from sarcoplasmic reticulum by direct action. At low doses, twitch response to nerve stimulation is augmented, while at toxic doses contracture is produced.

In addition, caffeine facilitates neuromuscular transmission by increasing ACh release. Its central action relieves fatigue and increases muscular work. Enhanced diaphragmatic contractility noted with theophylline in the therapeutic concentration range probably contributes to its beneficial effects in dyspnoea.

6. **Stomach** Methylxanthines enhance secretion of acid and pepsin in stomach, even on parenteral injection. They are also gastric irritants—theophylline more than caffeine.

7. **Metabolism** Caffeine and to a smaller extent theophylline increase BMR: plasma free fatty acid levels are raised. Release of endogenous catecholamines appears to be partly responsible for these effects.

8. **Mast cells and inflammatory cells** Theophylline decreases release of histamine and other mediators from mast cells and activated inflammatory cells. This may contribute to its therapeutic effect in bronchial asthma.

Mechanism of action Three distinct cellular actions of methylxanthines have been defined—
(a) Release of Ca^{2+} from sarcoplasmic reticulum, especially in skeletal and cardiac muscle.
(b) Inhibition of phosphodiesterase (PDE) which degrades cyclic nucleotides intracellularly.

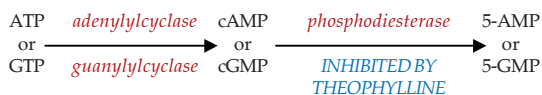

The concentration of cyclic nucleotides is increased. Bronchodilatation, cardiac stimulation

and vasodilatation occur when cAMP level rises in the concerned cells.

Several isoenzymes of the PDE superfamily exist in different tissues. Theophylline is a subtype nonselective PDE inhibitor, but PDE4 and PDE5 inhibition is mainly responsible for bronchodilatation. Some selective PDE4 inhibitors like *Cilomilast* and *Roflumilast* are under clinical evaluation as antiasthma drugs, but their better tolerability is yet to be demonstrated.

(c) Blockade of adenosine receptors: adenosine acts as a local mediator in CNS, CVS and other organs—contracts smooth muscles, especially bronchial; dilates cerebral blood vessels, depresses cardiac pacemaker and inhibits gastric secretion. Methylxanthines produce opposite effects.

Action (a) is exerted only at concentrations much higher than therapeutic plasma concentrations of caffeine and theophylline (ranging from 5–20 $\mu\text{g}/\text{ml}$). Action (b) and action (c) are exerted at concentrations in the therapeutic range and appear to contribute to bronchodilatation. Raised cAMP levels in inflammatory cells may attenuate mediator release and add to the therapeutic effect of theophylline in asthma.

(Pharmacokinetics, adverse effects and uses of caffeine are described in Ch. 35)

Theophylline

Pharmacokinetics Theophylline is well absorbed orally; rectal absorption from suppositories is erratic. It is distributed in all tissues—crosses placenta and is secreted in milk, ($V 0.51/\text{kg}$), 50% plasma protein bound and extensively metabolized in liver by demethylation and oxidation. Only 10% is excreted unchanged in urine. Its elimination rate varies considerably with age. At therapeutic concentrations, the $t_{1/2}$ in adults is 7–12 hours. Children eliminate it much faster ($t_{1/2}$ 3–5 hours) and elderly more slowly. In premature infants also the $t_{1/2}$ is prolonged (24–36 hours). There are marked interindividual variations in plasma concentrations attained with same dose.

Theophylline metabolizing enzymes are saturable, $t_{1/2}$ is prolonged with higher doses (to as much as 60 hours) as kinetics changes from first to zero order: plasma concentrations, therefore, increase disproportionately.

Factors which need dose reduction are—age > 60 yr ($\times 0.6$), CHF ($\times 0.6$), pneumonia ($\times 0.4$), liver failure ($\times 0.2$ – 0.4).

Adverse effects Theophylline has a narrow margin of safety. Dose-dependent toxicity starts from the upper part of therapeutic concentration range (Fig. 16.1). Adverse effects are primarily referable to the g.i.t., CNS and CVS. Children are more liable to develop CNS toxicity.

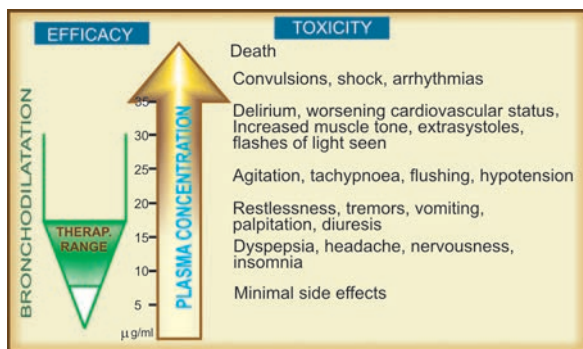

Fig. 16.1: Relationship between efficacy and toxicity of theophylline with its plasma concentration. The depicted concentration ranges are approximate

The irritant property of theophylline is reflected in gastric pain (with oral), rectal inflammation (with suppositories) and pain at site of i.m. injection. Rapid i.v. injection causes precordial pain, syncope and even sudden death—due to marked fall in BP, ventricular arrhythmias or asystole.

Interactions

- Agents which induce theophylline metabolism decrease its plasma level: dose has to be increased by the factor given in parenthesis. Smoking (1.6), phenytoin (1.5), rifampicin (1.5), phenobarbitone (1.2), charcoal broiled meat meal (1.3).
- Drugs which inhibit theophylline metabolism and increase its plasma level are—erythromycin, ciprofloxacin, cimetidine, oral contraceptives, allopurinol; dose should be reduced to 2/3.
- Theophylline enhances the effects of—furosemide, sympathomimetics, digitalis, oral anti-coagulants, hypoglycaemics.

- Theophylline decreases the effects of—phenytoin, lithium.
- Aminophylline injection should not be mixed in the same infusion bottle/syringe with—ascorbic acid, chlorpromazine, promethazine, morphine, pethidine, phenytoin, phenobarbitone, insulin, penicillin G, tetracyclines, erythromycin.

Preparations and dose

(i) *Theophylline (Anhydrous)* Poorly water soluble, cannot be injected. 100–300 mg TDS (15 mg/kg/day) **THEOLONG 100, 200 mg SR cap., DURALYN-CR 400 mg continuous release cap, UNICONTIN 400 mg, 600 mg CR tabs.**

Because solubility of theophylline is low, a number of soluble complexes and salts have been prepared, particularly for parenteral use.

(ii) *Aminophylline (Theophylline-ethylenediamine; 85% theophylline)* water soluble, can be injected i.v. but not i.m. or s.c.—highly irritating. 250–500 mg oral or slow i.v. injection; children 7.5 mg/kg i.v.; **AMINOPHYLLINE 100 mg tab, 250 mg/10 ml inj.**

(iii) *Hydroxyethyl theophylline (Etophylline, 80% theophylline)* water soluble; can be injected i.v. and i.m. (but not s.c.), less irritating; 250 mg oral/i.m./i.v.; **DERIPHYLLIN 100 mg tab., 300 mg SR tab., 220 mg/2 ml inj.**

(iv) *Choline theophyllinate (Oxtriphylline; 64% theophylline)* 250–500 mg oral, **CHOLIPHYLLINE 125 mg cap., 125 mg/5 ml elixir.**

(v) *Theophylline ethanolate of piperazine* 250–500 mg oral or i.v.; **CADIPHYLLATE 80 mg/5 ml elixir, ETOPHYLLATE 125 mg/5 ml syrup.**

Doxophylline A long-acting oral methylxanthine that is claimed not to interfere with sleep or stimulate gastric secretion.

Dose: 400 mg OD in the evening; **OXPUR 400 mg tab**

The double salts/derivatives of theophylline are claimed to be less gastric irritant and better absorbed. However, anhydrous theophylline is completely absorbed and gastric irritancy is same in terms of theophylline content.

Uses

- Bronchial asthma and COPD:* Theophylline benefits by causing bronchodilatation as well as presumably by decreasing release of inflammatory mediators, improved mucociliary clearance,

stimulation of respiratory drive and by augmenting diaphragmatic contractility. However, because of narrow margin of safety and limited efficacy, its use has declined. Oral theophylline can be used in mild-to-moderately severe asthma, as a 3rd line or alternative adjuvant drug, especially in patients with nocturnal asthma. It is more useful in COPD.

Use of intravenous aminophylline in status asthmaticus is outmoded.

2. *Apnoea in premature infant*: Theophylline reduces the frequency and duration of episodes of apnoea that occur in some preterm infants in the first few weeks of life. Closely monitored oral or i.v. treatment is employed for 1–3 weeks. Caffeine is equally effective.

ANTICHOLINERGICS (see Ch. 8)

Atropinic drugs cause bronchodilatation by blocking cholinergic constrictor tone; act primarily in the larger airways (Fig. 16.2).

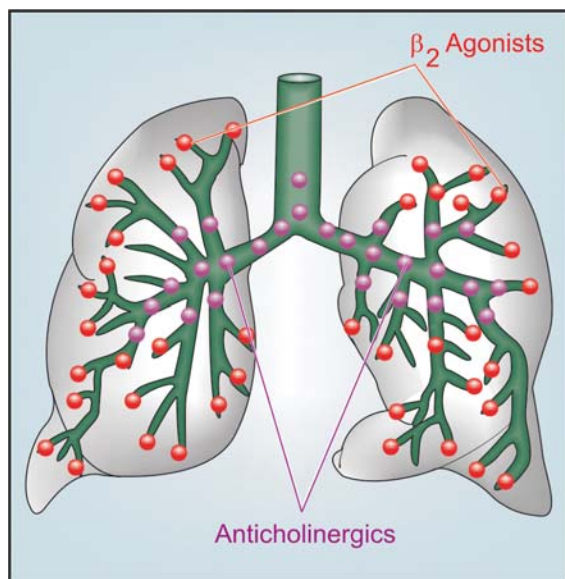

Fig. 16.2: Primary sites of bronchodilator action of inhaled adrenergic β_2 agonists and inhaled anticholinergics. Salbutamol mainly relaxes bronchiolar smooth muscle; Ipratropium blocks bronchoconstriction mainly in the larger airways

Inhaled ipratropium bromide is less efficacious than sympathomimetics. Patients of asthmatic bronchitis, COPD and psychogenic asthma respond better to anticholinergics. Inhaled ipratropium/tiotropium are the bronchodilators of choice in COPD. They produce slower response than inhaled sympathomimetics and are better suited for regular prophylactic use (ipratropium 2–4 puffs 6 hourly or tiotropium 1 rotacap OD) than for control of an acute attack. Combination of inhaled ipratropium with β_2 agonist produces more marked and longer lasting bronchodilatation; can be utilized in severe asthma. Nebulized ipratropium mixed with salbutamol is employed in refractory asthma. Combined formulations are available.

Salbutamol + Ipratropium

DUOLIN INHALER:	100 μ g + 20 μ g	per metered dose
DUOLIN ROTACAP:	200 μ g + 40 μ g	per rotacap
DUOLIN RESPULES:	2.5 mg + 500 μ g	in 2.5 ml solution

LEUKOTRIENE ANTAGONISTS

Since it was realized that cystenyl leukotrienes (LT-C₄/D₄) are important mediators of bronchial asthma, efforts were made to develop their antagonists and synthesis inhibitors. Two *cys*LT₁ receptor antagonist *montelukast* and *zafirlukast* are available.

Montelukast and Zafirlukast Both have similar actions and clinical utility. They competitively antagonize *cys*LT₁ receptor mediated bronchoconstriction, increased vascular permeability and recruitment of eosinophils. Bronchodilatation, reduced sputum eosinophil count, suppression of bronchial inflammation and hyperreactivity are noted in asthma patients. Parameters of lung function show variable but definite improvement. Some studies have found that certain patients are 'responders' while others are 'nonresponders' to anti-LT therapy.

Montelukast and zafirlukast are indicated for prophylactic therapy of mild-to-moderate asthma as alternatives to inhaled glucocorticoids. Though overall efficacy is lower than inhaled steroids, they may obviate need for the

latter, and may be more acceptable in children. In severe asthma, they may permit reduction in steroid dose and need for rescue β_2 agonist inhalations. However, they are not to be used for terminating asthma episodes. *cysLT₁* antagonists are effective in aspirin induced asthma.

Both montelukast and zafirlukast are very safe drugs; produce few side effects like headache and rashes. Eosinophilia and neuropathy are infrequent. Few cases of Churg-Strauss syndrome (vasculitis with eosinophilia) have been reported.

They are well absorbed orally, highly plasma protein bound and metabolized by CYP2C9 (montelukast also by CYP3A4). The plasma $t_{1/2}$ of montelukast is 3–6 hours, while that of zafirlukast is 8–12 hours.

Montelukast: 10 mg OD; children 2–5 yr mg OD, 6–14 yr 5 mg OD;

EMLUKAST, MONTAIR, VENTAIR 4 mg, 5 mg, 10 mg tabs
Zafirlukast: 20 mg BD; children 5–11 yr 10 mg BD;
ZUVAIR 10 mg, 20 mg tabs.

Zileuton It is a 5-LOX inhibitor, blocks LTC_4/D_4 as well as LTB_4 synthesis. It therefore has the potential to prevent all LT induced responses including those exerted by activation of *cysLT₁* receptor. However, clinical efficacy in asthma is similar to montelukast. The duration of action of zileuton is short and it has hepatotoxic potential. These limitations have restricted its use.

MAST CELL STABILIZERS

Sodium cromoglycate (Cromolyn sod.)

It is a synthetic chromone derivative which inhibits degranulation of mast cells (as well as other inflammatory cells) by trigger stimuli. Release of mediators of asthma like histamine, LTs, PAF, interleukins, etc. is restricted. The basis of this effect is not well understood, but may involve a delayed Cl^- channel in the membrane of these cells. Chemotaxis of inflammatory cells is inhibited. Long-term treatment decreases the cellular inflammatory response; bronchial hyperreactivity is reduced to variable extents. Bronchospasm induced by allergens, irritants, cold air and exercise may be prevented. However, AG:AB reaction is not interfered with. It is also not a bronchodilator and does not antagonize

constrictor action of histamine, ACh, LTs, etc. Therefore, it is ineffective if given during an asthmatic attack.

Pharmacokinetics Sod. cromoglycate is not absorbed orally. It is administered as an aerosol through metered dose inhaler delivering 1 mg per dose: 2 puffs 4 times a day. The earlier spinhaler capsule formulation delivering the drug as a fine powder has become less popular. Only a small fraction of the inhaled drug is absorbed systemically; this is rapidly excreted unchanged in urine and bile.

Uses

1. *Bronchial asthma*: Sod. cromoglycate is used as a long-term prophylactic in mild-to-moderate asthma. Decrease in the frequency and severity of attacks and improvement in lung function is more likely in extrinsic (atopic) and exercise induced asthma, especially in younger patients. Therapeutic benefit (when it occurs) develops slowly over 2–4 weeks and lasts 1–2 weeks after discontinuing. However, the prophylactic effect of cromoglycate is less marked and less consistent than that of corticosteroids. Its popularity has declined.

2. *Allergic rhinitis*: Cromoglycate is not a nasal decongestant, but regular 4 times daily prophylactic use as a nasal spray produces symptomatic improvement in many patients after 4–6 weeks: need for nasal decongestants is reduced.

3. *Allergic conjunctivitis*: Regular use as eye drops is beneficial in some chronic cases.

FINTAL inhaler: 1 mg metered dose aerosol; 2 puffs 4 times daily.

FINTAL nasal spray: 2% aqueous solution; 2 squeezes in each nostril QID.

FINTAL eye drops: 2% aqueous solution; 1 drop in each eye QID.

CROMAL-5 INHALER: 5 mg metered dose aerosol, 2 puffs 4 times daily.

Adverse effects Because of poor aqueous solubility, absorption of cromoglycate is

negligible; systemic toxicity is minimal. Bronchospasm, throat irritation and cough occurs in some patients, especially with fine powder inhalation. Rarely nasal congestion, headache, dizziness, arthralgia, rashes and dysuria have been reported.

Ketotifen It is an antihistaminic (H_1) with some cromoglycate like action; stimulation of immunogenic and inflammatory cells (mast cells, macrophages, eosinophils, lymphocytes, neutrophils) and mediator release are inhibited. It is not a bronchodilator, but produces sedation.

After 6–12 weeks of use, it reduces respiratory symptoms in ~50% patients of bronchial asthma, but improvement in lung function is marginal. It also produces symptomatic relief in many patients with atopic dermatitis, perennial rhinitis, conjunctivitis, urticaria and food allergy. Thus, it is especially indicated in patients with multiple disorders.

Ketotifen is absorbed orally; bioavailability is 50% due to first pass metabolism. It is largely metabolized; $t_{1/2}$ is 22 hours.

Adverse effects Generally well tolerated. Sedation and dry mouth are common. Other side effects are dizziness, nausea, weight gain.

Dose: 1–2 mg BD; children 0.5 mg BD.

ASTHAFEN, 1 mg tab, 1 mg/5 ml syrup; **KETOVENT** 1 mg tab.

CORTICOSTEROIDS

Glucocorticoids are not bronchodilators. They benefit by reducing bronchial hyperreactivity, mucosal edema and by suppressing inflammatory response to AG:AB reaction or other trigger stimuli. Their mechanism of action is detailed in Ch. 20.

The realization that asthma is primarily an inflammatory disease which, if not controlled, accentuates with time, and the availability of inhaled steroids that produce few adverse effects has led to early introduction and more extensive use of glucocorticoids in asthma. Corticosteroids afford more complete and sustained symptomatic relief than bronchodilators or cromoglycate;

improve airflow, reduce asthma exacerbations and may influence airway remodeling, retarding disease progression. However, long-term systemic steroid therapy has its own adverse effects which may be worse than asthma itself.

SYSTEMIC STEROID THERAPY

Systemic steroid therapy is resorted to in asthma under the following two situations:

(i) **Severe chronic asthma:** not controlled by bronchodilators and inhaled steroids, or when there are frequent recurrences of increasing severity; start with prednisolone 20–60 mg (or equivalent) daily; attempt dose reduction after 1–2 weeks of good control and finally try shifting the patient onto an inhaled steroid. Only few patients require long term oral steroids—in them dose should be kept at minimum.

In patients requiring long-term glucocorticoid therapy, alternative treatment with immunosuppressants like methotrexate (low dose) or cyclosporine has been tried.

(ii) **Status asthmaticus/acute asthma exacerbation:** Asthma attack not responding to intensive bronchodilator therapy: start with high dose of a rapidly acting i.v. glucocorticoid which generally acts in 6–24 hours—shift to oral therapy for 5–7 days and then discontinue abruptly or taper rapidly.

COPD A short course (1–3 week) of oral glucocorticoid may benefit some patients of COPD during an exacerbation.

INHALED STEROIDS

These are glucocorticoids with high topical and low systemic activity (due to poor absorption and/or marked first pass metabolism). *Beclomethasone dipropionate*, *Budesonide* and *Fluticasone* have similar properties. *Ciclesonide* is a new addition. Because airway inflammation is present in early mild disease as well, and bronchial remodeling starts developing from the beginning, it has been suggested that inhaled steroids should be the ‘step one’ for all asthma patients. However, currently inhaled steroids are not considered necessary for patients with mild

and episodic asthma. They are indicated when inhaled β_2 agonists are required almost daily or the disease is not only episodic. Start with 100–200 μg BD, titrate dose upward every 3–5 days; max. 400 μg QID, beyond which no further benefit generally occurs.

Inhaled steroids suppress bronchial inflammation, increase peak expiratory flow rate, reduce need for rescue β_2 -agonist inhalations and prevent episodes of acute asthma. However, they have no role during an acute attack or in status asthmaticus. Peak effect is seen after 4–7 days of instituting inhaled steroids and benefit persists for a few weeks after discontinuation. They can be started in patients who in past have required oral steroids as well as in those with no such history. Patients who are to be switched over from oral steroid should receive inhaled steroid in addition for 1–2 weeks before the former is tapered, otherwise steroid withdrawal may manifest (precipitation of asthma, muscular pain, lassitude, depression, hypotension). This confirms lack of systemic activity of inhaled steroids (at doses < 600 $\mu\text{g}/\text{day}$). Long-term experience has shown that efficacy of inhaled steroids is maintained and reinstatement of oral steroids is seldom needed. Short courses of oral steroids may be added during periods of exacerbation. Some patients who remain well controlled for long periods can even stop inhaled steroids without worsening of asthma.

COPD: High dose inhaled steroids are beneficial only in advanced COPD with frequent exacerbations; should not be used in early/mild cases. There is no proof that they slow disease progression.

Hoarseness of voice, dysphonia, sore throat, asymptomatic or symptomatic oropharyngeal candidiasis are the most common side effects. These can be minimized by the use of a spacer, gargling after every dose (to wash off the drug deposited on oral and pharyngeal mucosa) and prevented as well as treated by topical nystatin/clotrimazole. There is no evidence of mucosal damage or increased incidence of chest infections, even on prolonged use.

Systemic effects of long-term inhaled glucocorticoids are clinically relevant only at doses > 600 $\mu\text{g}/\text{day}$. The significant ones are—mood changes, osteoporosis, growth retardation in children, bruising, petechiae, hyperglycaemia and pituitary-adrenal suppression; several reports of adrenal crisis have appeared, especially in children, during stress (of an infection, etc).

Inhaled steroids are safe during pregnancy.

Beclomethasone dipropionate

BECLATE INHALER 50 μg , 100 μg , 200 μg per metered dose, 200 doses inhaler, BECORIDE 50, 100, 250 μg per puff inhaler.

BECLATE ROTACAPS (with rotahaler) 100, 200, 400 μg powder per cap.

AEROCORT INHALER 50 μg /metered aerosol dose with salbutamol 100 μg .

AEROCORT ROTACAPS 100 μg with salbutamol 200 μg rotacaps (with rotahaler).

Intranasal spray (50 μg in each nostril BD–TDS) is effective in perennial rhinitis.

Budesonide A nonhalogenated glucocorticoid with high topical: systemic activity ratio; claimed to be better than beclomethasone. Small fraction that is absorbed is rapidly metabolized.

Dose: 200–400 μg BD–QID by inhalation in asthma; 200–400 $\mu\text{g}/\text{day}$ by intranasal spray for allergic rhinitis.

PULMICORT 100, 200, 400 μg /metered dose inhaler, BUDECORT 100 μg /metered dose inhalation.

FORACORT: Formoterol 6 μg + Budesonide 100 μg /200 μg rotacaps.

RHINOCORT 50 μg per metered dose nasal spray; BUDENASE AQ 100 μg metered dose aqueous nasal spray; for prophylaxis and treatment of seasonal and perennial allergic or vasomotor rhinitis, nasal polyposis; initially 2 puffs in each nostril every morning, maintenance 1 puff in each nostril in the morning.

Nasal irritation, sneezing, crusting, itching of throat and dryness may occur, especially in the beginning. Contraindicated in presence of infection or nasal ulcers.

Fluticasone propionate This newer inhaled glucocorticoid has high potency, longer duration and negligible oral bioavailability. The dose swallowed after inhalation has little propensity to produce systemic effects. At high doses, systemic effects may be due to absorption from the lungs. The inhalational dose is 100–250 μg BD (max 1000 $\mu\text{g}/\text{day}$).

FLOHALE INHALER 25 µg, 50 µg, 125 µg per actuation.
 FLOHALE ROTACAPS 50 µg, 100 µg, 250 µg rotacaps.
 FLOMIST 50 µg per actuation nasal spray.

Flunisolide This topical steroid is available for prophylaxis and treatment of seasonal and perennial rhinitis.

SYNTARIS 25 µg per actuation nasal spray; one spray in each nostril 2–3 times daily.

Ciclesonide This inhalational steroid utilizes a novel approach to improve topical: systemic activity ratio. It is a prodrug that is cleaved by esterases in the bronchial epithelium to release the active moiety. Though it is absorbed from the lungs, oral bioavailability is <1%. In the circulation it is extensively bound to plasma proteins, further minimizing exposure of tissue cells to the free and active drug.

Dose: 80–160 µg by inhalation OD, preferably in the evening.
 CICLEZ 80 µg and 160 µg per metered dose inhaler with HFA propellant.

ANTI-IgE ANTIBODY

Omalizumab It is a humanized monoclonal antibody against IgE. Administered i.v. or s.c., it neutralizes free IgE in circulation without activating mast cells and other inflammatory cells. On antigen challenge, little IgE is available bound to the mast cell surface receptors (FcεR1) to trigger mediator release (see Fig. 11.2) and cause bronchoconstriction. In severe extrinsic asthma, omalizumab has been found to reduce exacerbations and steroid requirement. It is very expensive; use is reserved for resistant asthma patients with positive skin tests or raised IgE levels who require frequent hospitalization. It is not itself immunogenic; only injection site local reactions have been noted so far. It is being tried in other allergic diseases as well.

INHALED ASTHMA MEDICATION

Four classes of antiasthma drugs, *viz.* β₂ agonists, anticholinergics, cromoglycate and glucocorticoids are available for inhalational use. They are aimed at delivering the drug to the site of action so that lower dose is needed and systemic side effects are minimized. Most asthma patients are now maintained on inhaled medication only. Aerosols are of two types:

- (i) use drug in solution: metered dose inhaler, nebulizer.
 - (ii) use drug as dry powder: spinhaler, rothaler
- Metered dose inhalers use chlorofluorocarbon (are being banned now for their effect on ozone layer) or hydrofluoroalkane (HFA) propellants and deliver a specified dose

of the drug in spray form per actuation. Device actuation has to be properly coordinated with deep inspiration, which many patients are unable to learn. A 'spacer' (chamber interposed between the inhaler and the patient's mouth) can be used to improve drug delivery. Nebulizers produce a mist of the drug solution generated by pressurized air or oxygen which can be inhaled through a mouth piece, face mask or in a tent. Metered dose inhalers are convenient hand-held devices which can be carried along, while nebulizers are used at patient's bed side. Nebulizers are preferred for severe episodes of asthma as well as for children and elderly. More than one drug can be nebulized simultaneously.

Dry powder inhalers are also portable devices in which the capsule (rotacap) containing the drug is punctured/cut across and the powder is aerosolized by the inspiratory air flow of the patient. It requires high velocity inspiration which children, elderly and the very sick may not be capable of. The dry powder is also more likely to irritate the air passage—producing cough and bronchoconstriction.

Efficacy of aerosolized drug depends on the particle size: 1–5 µm diameter particles deposit on the bronchioles and effectively deliver the drug. Larger particles settle on the oropharynx, while very fine particles do not settle anywhere and are exhaled out. On an average only 4–10% of the inhaled drug reaches the site of action. A considerable fraction is swallowed. Therefore, to minimize systemic action, the drug should have low oral bioavailability. Spacer devices improve inhaled to swallowed drug ratio. Slow and deep inbreathing after device actuation and holding the breath after inhalation also enhances efficacy of the inhaler.

CHOICE OF TREATMENT

A stepwise guideline to the treatment of asthma as per needs of the patient has been recommended:

1. **Mild episodic asthma** (symptoms less than once daily, normal in between attacks): Inhaled short-acting β₂ agonist at onset of each episode. No regular prophylactic therapy (**Step-1**).
2. **Seasonal asthma** Start regular inhaled cromoglycate/low-dose inhaled steroid (200–400 µg/day) 3–4 weeks before anticipated seasonal attacks and continue till 3–4 weeks after the season is over. Treat individual episodes with inhaled short-acting β₂ agonist.
3. **Mild chronic asthma with occasional exacerbations** (symptoms once daily or so) Regular inhaled low-dose steroid (**Step-2**). Alternatively, inhaled

cromoglycate. Episode treatment with inhaled short-acting β_2 agonist.

4. Moderate asthma with frequent exacerbations (attacks affect activity, occur > 1 per day or mild baseline symptoms) Increasing doses of inhaled steroid (up to 800 $\mu\text{g}/\text{day}$) + inhaled long-acting β_2 agonist (**Step-3**). Leukotriene antagonists may be tried in patients not accepting inhaled steroids and in those not well controlled. Theophylline may be used as alternative additional drug. Episode treatment with inhaled short-acting β_2 agonist.

5. Severe asthma (continuous symptoms; activity limitation; frequent exacerbations/hospitalization) Regular high dose inhaled steroid (800–2000 $\mu\text{g}/\text{day}$) through a large volume spacer device + inhaled long-acting β_2 agonist (salmeterol) twice daily. Additional treatment with one or more of the following (**Step-4**):

Leukotriene antagonist/sustained release oral theophylline/oral β_2 agonist/inhaled ipratropium bromide.

Rescue treatment with short-acting inhaled β_2 agonist.

In patients not adequately controlled or those needing frequent emergency care—institute oral steroid therapy (**Step-5**). Attempt withdrawing oral steroid periodically.

6. Status asthmaticus/Refractory asthma

Any patient of asthma has the potential to develop acute severe asthma which may be life-threatening. Upper respiratory tract infection is the most common precipitant.

- (i) Hydrocortisone hemisuccinate 100 mg (or equivalent dose of another glucocorticoid)

i.v. *stat*, followed by 100–200 mg 4–8 hourly infusion; may take up to 6 hours to act.

- (ii) Nebulized salbutamol (2.5–5 mg) + ipratropium bromide (0.5 mg) intermittent inhalations driven by O_2 .
- (iii) High flow humidified oxygen inhalation.
- (iv) Salbutamol/terbutaline 0.4 mg i.m./s.c. may be added, since inhaled drug may not reach smaller bronchi due to severe narrowing/plugging.
- (v) Intubation and mechanical ventilation, if needed.
- (vi) Treat chest infection with intensive antibiotic therapy.
- (vii) Correct dehydration and acidosis with saline + sod. bicarbonate/lactate infusion.

Aminophylline 250–500 mg diluted in 20–50 ml glucose (5%) solution injected i.v. over 20–30 min had been routinely used, but recent evidence shows that it does not afford additional benefit; may even produce more adverse effects; use is restricted to resistant cases.

Some antiasthma combinations

BRONKOPLUS: Salbutamol 2 mg, anhydrous theophylline 100 mg tab., also per 5 ml syrup.

BRONKOTUS: Bromhexine 8 mg, salbutamol 2 mg tab., also syrup—bromhexine 4 mg, salbutamol 2 mg per 5 ml.

TERPHYLIN: Terbutaline 2.5 mg, etophylline 100 mg tab.

THEO ASTHALIN: Salbutamol 2 mg, theophylline anhydrous 100 mg tab.

THEO ASTHALIN-SR: Salbutamol 4 mg, theophylline 300 mg SR tab, also syrup—Salbutamol 2 mg, theophylline 100 mg per 10 ml.

THEO BRIC: Terbutaline 2.5 mg, theophylline 100 mg tab.

THEOBRIC SR: Terbutaline 5 mg, theophylline 300 mg SR tab.

DURASALYN-CR: Salbutamol 4 mg, theophylline 200 mg CR cap.

Hormones and Related Drugs



Introduction

Hormone (Greek *hormaein*—to stir up) is a substance of intense biological activity that is produced by *specific cells* in the body and is transported *through circulation* to act on its target cells.

Hormones regulate body functions to bring about a programmed pattern of life events and maintain homeostasis in the face of markedly variable external/internal environment.

Body function	Major regulator hormone(s)
1. Availability of fuel	: Insulin, Glucagon, Growth hormone
2. Metabolic rate	: Triiodothyronine, Thyroxine
3. Somatic growth	: Growth hormone, Insulin-like growth factors
4. Sex and reproduction	: Gonadotropins, Androgens, Estrogens, Progestins
5. Circulating volume	: Aldosterone, Antidiuretic hormone
6. Adaptation to stress	: Glucocorticoids, Adrenaline
7. Calcium balance	: Parathormone, Calcitonin, Vitamin D

Hormones are secreted by the *endocrine* or *ductless* glands. These are:

1. Pituitary

- (a) **Anterior** Growth hormone (GH), Prolactin (Prl), Adrenocorticotrophic hormone (ACTH, Corticotropin), Thyroid stimulating hormone (TSH, Thyrotropin), Gonadotropins—Follicle stimulating hormone (FSH) and Luteinizing hormone (LH).

- (b) **Posterior**—Oxytocin, Antidiuretic hormone (ADH, Vasopressin).
2. **Thyroid** Thyroxine (T_4), Triiodothyronine (T_3), Calcitonin.
3. **Parathyroid** Parathormone (PTH).
4. **Pancreas** (*Islets of Langerhans*) Insulin, Glucagon.
5. **Adrenals**
- (a) **Cortex** Glucocorticoids (hydrocortisone) Mineralocorticoids (aldosterone) Sex steroids (dehydroepiandrosterone)
- (b) **Medulla** Adrenaline, Noradrenaline
6. **Gonads** Androgens (testosterone) Estrogens (estradiol) Progestins (progesterone)

In addition, hypothalamus, which is a part of the CNS and not a gland, produces many releasing and inhibitory hormones which control the secretion of anterior pituitary hormones. Some important ones of these are given below

Hypothalamic hormone/factor	Chemical nature
1. Thyrotropin releasing hormone (TRH)	Tripeptide
2. Corticotropin releasing hormone (CRH)	Peptide (41 AAs)
3. Gonadotropin releasing hormone (GnRH, LH-RH/FSH-RH), Gonadorelin	Decapeptide
4. Prolactin release inhibitory hormone (PRIH)	Dopamine
5. Growth hormone releasing hormone (GHRH)	Peptide (40, 44 AAs)
6. Somatostatin (Growth hormone release inhibitory hormone)	Peptide (14 AA)

Placenta also secretes many hormones:

Chorionic gonadotropin	Prolactin
Estrogens	Progesterone
Placental lactogen	Chorionic thyrotropin

The natural hormones and in many cases their synthetic analogues which may be more suitable therapeutically, are used as drugs for substitution therapy as well as for pharmacotherapy. In addition, hormone antagonists and synthesis/release inhibitors are of therapeutic importance.

Sites and mechanisms of hormone action

The hormones act on their specific receptors located on or within their target cells. Receptor activation by the hormones is translated into response in a variety of ways.

1. *At cell membrane receptors*

- (a) Through alteration of intracellular cAMP concentration → alteration of protein kinase A → regulation of cell function: Ca^{2+} acting as third messenger in some situations.
- Adrenaline, Glucagon, TSH, FSH, LH, PTH, Calcitonin, ACTH, some hypothalamic releasing hormones, Vasopressin (V_2)

- (b) Through IP_3/DAG generation: release of intracellular Ca^{2+} and protein kinase C activation. Vasopressin (V_1), Oxytocin
- (c) Direct transmembrane activation of tyrosine protein kinase → phosphorylation cascade → regulation of various enzymes. Insulin, Growth hormone, Prolactin

2. *At cytoplasmic receptors*

- Penetrating cell membrane, hormone combines with a cytoplasmic receptor → exposes its DNA binding domain → migrates to nucleus and binds to specific genes → DNA mediated mRNA synthesis → synthesis of functional proteins.
- Steroidal hormones: Glucocorticoids, Mineralocorticoid, Androgens, Estrogens, Progestins; Calcitriol

3. *At nuclear receptor*

- The hormone penetrates the nucleus → combines with its receptor → alters DNA-RNA mediated protein synthesis.
- Thyroid hormones: Thyroxine, Triiodothyronine



Anterior pituitary (adenohypophysis), the master endocrine gland, elaborates a number of important regulatory hormones. All of these are peptide in nature and act at extracellular receptors located on their target cells. Their secretion is controlled by the hypothalamus through *releasing* and *release-inhibitory* hormones that are transported *via* hypothalamohypophyseal portal system, and is subjected to feedback inhibition by hormones of their target glands. Each anterior pituitary hormone is produced by a separate group of cells, which according to their staining characteristic are either acidophilic or basophilic.

The *acidophils* are either somatotropes → GH; or lactotropes → Prolactin.

The *basophils* are gonadotropes → FSH and LH; thyrotropes → TSH; and corticotrope-lipotropes → ACTH. The latter in addition to ACTH also produce two melanocyte stimulating hormones (MSHs) and two lipotropins, but these are probably not important in man.

GROWTH HORMONE (GH)

It is a 191 amino acid, single chain peptide of MW 22000.

Physiological functions GH promotes growth of all organs by inducing hyperplasia. In general, there is a proportionate increase in the size and

mass of all parts, but in the absence of gonadotropins, sexual maturation does not take place. The growth of brain and eye is independent of GH. It promotes retention of nitrogen and other tissue constituents: more protoplasm is formed. The positive nitrogen balance results from increased uptake of amino acids by tissues and their synthesis into proteins. GH promotes utilization of fat and spares carbohydrates: uptake of glucose by muscles is reduced while its output from liver is enhanced; fat is broken down.

GH acts on cell surface JAK-STAT protein kinase receptors (present on practically all cells). Binding of one GH molecule to the extracellular domain of two GH receptor molecules induces their dimerization and activates the intracellular domain to associate with cytoplasmic JAK-STAT tyrosine-protein kinase resulting in metabolic effects as well as regulation of gene expression.

The growth promoting, nitrogen retaining and certain metabolic actions of GH are exerted *indirectly* through the elaboration of peptides called *Somatomedins* or *Insulin-like growth factors* (mainly IGF-1, also IGF-2) which are extracellular mediators of GH response. Liver is the major source of circulating IGF-1, while IGF-1 produced by other target cells acts locally in a paracrine manner. Like insulin, IGF-1 promotes lipogenesis and glucose uptake by muscles. The IGF-1 receptor also is structurally and functionally analogous to the insulin receptor (*see p. 258*).

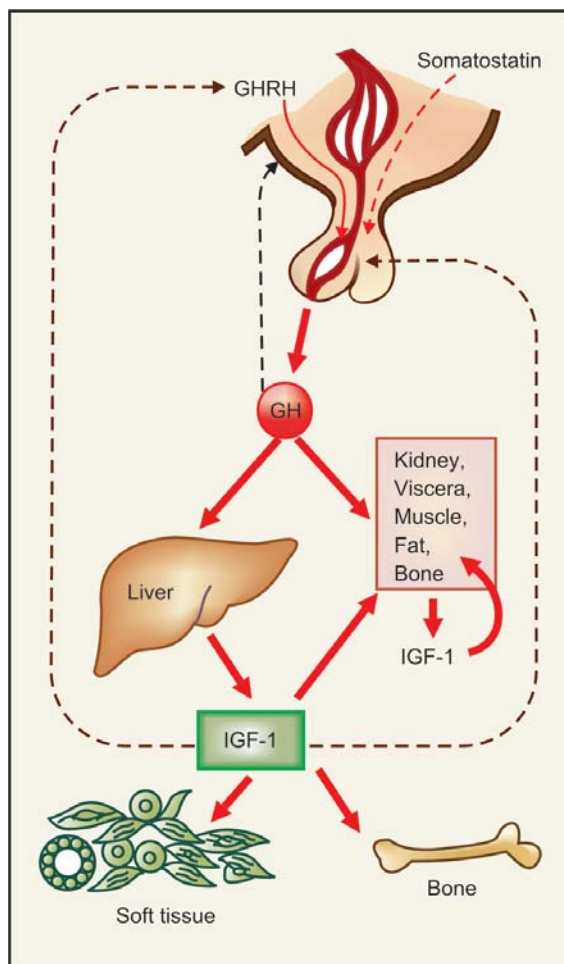

Fig. 17.1: Action of growth hormone (GH) and regulation of its secretion

GHRH—Growth hormone releasing hormone; IGF-1: Insulin like growth factor-1; Stimulation (—>); Inhibition (- - ->)

GH acts directly as well to induce lipolysis in adipose tissue, glycogenolysis in liver and decreased glucose utilization by muscles. These effects are opposite to those of IGF-1 and insulin. As such, GH accentuates the metabolic derangement in diabetes.

Regulation of secretion The hypothalamus produces GH releasing (GHRH) as well as release inhibitory (*somatostatin*) hormones. Both are peptides. *Somatostatin* is also produced by D cells of islets of Langerhans in the pancreas and by few other tissues. Receptors for GHRH and somatostatin are G protein coupled receptors which

enhance or inhibit GH secretion by increasing or decreasing cAMP formation respectively in pituitary somatotropes. Somatostatin has also been shown to inhibit Ca^{2+} channels and open K^+ channels.

Stimuli that cause GH release are—fasting, hypoglycaemia, exercise, stress and i.v. infusion of arginine. GH secretion is inhibited by increase in plasma free fatty acid levels and by high doses of glucocorticoids. Dopaminergic agents cause a brief increase in GH release in normal subjects but paradoxically depress it in acromegalics. IGF-1 causes feedback inhibition of GH secretion. Short-loop feedback inhibition of secretion by GH itself has also been described.

Pathological involvements Excess production of GH is responsible for *gigantism* in childhood and *acromegaly* in adults. Hyposecretion of GH in children results in *pituitary dwarfism*. Adult GH deficiency is rare.

Preparations and use The primary indication for GH is *pituitary dwarfism*—0.03–0.07 mg/kg (0.06–0.16 Units/kg) i.m. or s.c. 3 times a week upto the age of 20–25 years. Two forms of human GH produced by recombinant DNA technique (*rhGH*) *somatropin* (191AA) and *somatrem* (192AA) are available for clinical use. *rhGH* causes IGF-1 to appear in plasma after a delay of several hours. IGF-1 then remains detectable for upto 48 hours. Early diagnosis and institution of GH therapy restores stature to near normal. *rhGH* can also be used in *Turner's syndrome* and in children with *renal failure*.

rhGH has been tried in children with *constitutional short stature* (only if epiphyses are open) with encouraging results. Commercial interests are promoting it for accelerating growth in children without GH deficiency, but medical, ethical, cost-benefit and social objections have been raised. In *adult GH deficient* patients, it increases lean body mass, decreases body fat, improves energy and mentation and may reduce excess morbidity and mortality, but stature is unaffected. Unlimited availability of recombinant GH has provided opportunity for its trial in *catabolic states* like severe burns, bedridden patients, chronic renal failure, osteoporosis, etc. It is now approved for *AIDS-related wasting*: higher dose (0.05–0.1 mg/kg/day) is needed. However, it should not be given to postoperative, trauma, cancer and other critically ill patients. Its abuse by athletes is banned, and it is one of the drugs included in 'dope testing'. Somatropin: **GENOTROPIN, NORDITROPIN 4 iu, 12 iu, 16 iu, 36 iu, SAIZEN 10 iu vials for inj** (12 iu=5 mg).

Adverse effects Somatrem has an additional methionine residue and is more immunogenic than somatropin, but allergic reactions or resistance to treatment are not a problem. Pain at injection site and lipodystrophy can occur. Glucose intolerance, hypothyroidism (due to unmasking of TSH deficiency), salt and water retention, hand stiffness, myalgia, headache are the possible adverse effects. Rise in intracranial tension occurs in few cases.

GH Inhibitors

Somatostatin

This 14 amino acid peptide inhibits the secretion of GH, TSH and prolactin by pituitary; insulin and glucagon by pancreas and of almost all gastrointestinal secretions including that of gastrin and HCl. The g.i. action produces steatorrhoea, diarrhoea, hypochlorhydria, dyspepsia and nausea as side effect. Somatostatin constricts splanchnic, hepatic and renal blood vessels. The decreased g.i. mucosal blood flow can be utilized for controlling bleeding esophageal varices and bleeding peptic ulcer, but octreotide is preferred now due to longer duration of action. Its anti-secretory action is beneficial in pancreatic, biliary or intestinal fistulae; can also be used to reduce complications after pancreatic surgery. It also has adjuvant value in diabetic ketoacidosis (by inhibiting glucagon and GH secretion).

Use of somatostatin in acromegaly is limited by its short duration of action ($t_{1/2}$ 2–3 min), lack of specificity for inhibiting only GH secretion and GH rebound on discontinuation.

Dose: (for upper g.i.bleeding) 250 μ g slow i.v. injection over 3 min followed by 3 mg i.v. infusion over 12 hours.

STILMEN, SOMATOSAN 250 μ g and 3 mg amps.

Octreotide This synthetic octapeptide surrogate of somatostatin is 40 times more potent in suppressing GH secretion and longer acting ($t_{1/2}$ ~90 min), but only a weak inhibitor of insulin secretion. It is being preferred over somatostatin for acromegaly and seretory diarrhoeas associated with carcinoid, AIDS, cancer chemotherapy or diabetes. Control of diarrhoea is due to suppression of hormones which enhance intestinal mucosal secretion.

Dose: Initially 50–100 μ g s.c. twice daily, increased upto 500 μ g TDS.

Adverse effects are abdominal pain, nausea, steatorrhoea, diarrhoea, and gall stones (due to biliary stasis).

Octreotide injected i.v. (100 μ g followed by 25–50 μ g/hr) reduces hepatic blood flow and helps stop esophageal variceal bleeding.

SANDOSTATIN, OCTRIDE 50 μ g, 100 μ g in 1 ml amps.

Pegvisomant: This polyethylene glycol complexed mutant GH binds to the GH receptor but does not trigger signal transduction: acts as a GH antagonist. It is indicated in acromegaly due to small pituitary adenomas.

PROLACTIN

It is a 199 amino acid, single chain peptide of MW 23000; quite similar chemically to GH. It was originally described as the hormone which causes secretion of milk from crop glands of pigeon and has now been shown to be of considerable importance in human beings as well.

Physiological function Prolactin is the primary stimulus which in conjunction with estrogens, progesterone and several other hormones, causes growth and development of breast during pregnancy. It promotes proliferation of ductal as well as acinar cells in the breast and induces synthesis of milk proteins and lactose. After parturition, prolactin induces milk secretion, since the inhibitory influence of high estrogen and progesterone levels is withdrawn.

Prolactin suppresses hypothalamo-pituitary-gonadal axis by inhibiting GnRH release. Continued high level of prolactin during breastfeeding is responsible for lactational amenorrhoea, inhibition of ovulation and infertility for several months postpartum. Prolactin may affect immune response through action on T-lymphocytes.

A specific prolactin receptor is expressed on the surface of target cells, which is structurally and functionally analogous to GH receptor: action is exerted by transmembrane activation of cytoplasmic tyrosine protein kinases. Placental lactogen and GH also bind to prolactin receptor and exert similar effects.

Regulation of secretion Prolactin is under predominant inhibitory control of hypothalamus through PRIFH which is dopamine that acts on pituitary lactotrope D2 receptor. Dopaminergic agonists (DA, bromocriptine, cabergoline) decrease plasma prolactin levels, while dopaminergic antagonists (chlorpromazine, haloperidol, metoclopramide) and DA depleters (reserpine, methyl dopa) cause hyperprolactinemia.

Though TRH can stimulate prolactin secretion, no specific prolactin releasing factor has been identified. Endogenous opioid peptides may also be involved in regulating prolactin secretion, but no feedback regulation by any peripheral hormone is known. Prolactin levels in blood are low in childhood, increase in girls at puberty and are higher

in adult females than in males. A progressive increase occurs during pregnancy, peaking at term. Subsequently, high prolactin secretion is maintained by suckling; it falls if breast feeding is discontinued. Stress, exertion and hypoglycaemia also stimulate prolactin release.

Physio-pathological involvement Hyperprolactinaemia is responsible for the galactorrhoea–amenorrhoea–infertility syndrome. In males it causes loss of libido and depressed fertility. The causes of hyperprolactinaemia are:

- (i) Disorders of hypothalamus removing the inhibitory control over pituitary.
- (ii) Antidopaminergic and DA depleting drugs—these are a frequent cause now.
- (iii) Prolactin secreting tumours—these may be microprolactinomas or macroprolactinomas.
- (iv) Hypothyroidism with high TRH levels—also increases prolactin secretion.

Use There are no clinical indications for prolactin.

Prolactin inhibitors

Bromocriptine

This synthetic ergot derivative 2-bromo- α -ergocryptine is a potent dopamine agonist; most of its actions are based on this property. It has greater action on D2 receptors, while at certain dopamine sites in the brain it acts as a partial agonist or antagonist of D1 receptor. It is also a weak α adrenergic blocker but not an oxytocic.

Actions

1. Decreases prolactin release from pituitary by activating dopaminergic receptors on lactotrope cells—a strong antilactopoietic.
2. Increases GH release in normal individuals, but decreases the same from pituitary tumours that cause acromegaly.
3. Has levodopa like actions in CNS—anti-parkinsonian and behavioral effects.
4. Produces nausea and vomiting by stimulating dopaminergic receptors in the CTZ.
5. Hypotension—due to central suppression of postural reflexes and weak peripheral α adrenergic blockade.
6. Decreases gastrointestinal motility.

Pharmacokinetics Only 1/3 of an oral dose of bromocriptine is absorbed; bioavailability is further lowered by high first pass metabolism in liver. Even then, it has higher oral: parenteral activity ratio than ergotamine. Metabolites are excreted mainly in bile. Its plasma $t_{1/2}$ is 3–6 hours. **PROCTINAL, PARLODEL, SICRIPTIN, BROMOGEN** 1.25 mg, 2.5 mg tabs.

Uses Bromocriptine should always be started at a low dose, 1.25 mg BD and then gradually increased till response occurs otherwise side effects become limiting.

1. **Hyperprolactinemia** due to microprolactinomas causing galactorrhoea, amenorrhoea and infertility in women; gynaecomastia, impotence and sterility in men. Bromocriptine and cabergoline are the first line drug for most cases. Relatively lower doses (bromocriptine 2.5–10 mg/day or cabergoline 0.25–1.0 mg twice weekly) are effective. Response occurs in a few weeks and serum prolactin levels fall to the normal range; many women conceive. Bromocriptine should be stopped when pregnancy occurs, though no teratogenic effect is reported. Most (60–75%) tumours show regression during therapy. However, response is maintained only till the drug is given—recurrences occur on stopping; life-long maintenance therapy is needed.

2. **Acromegaly** due to small pituitary tumours and inoperable cases. Relatively higher doses are required (5–20 mg/day) and it is less effective than somatostatin/octreotide. Oral administration and lower cost are the advantages..

3. **Parkinsonism** Bromocriptine, if used alone, is effective only at high doses (20–80 mg/day) which produce marked side effects. However, response is similar to that of levodopa. It is now recommended in low dose only, as an adjunct to levodopa in patients not adequately benefited and in those showing marked 'on-off' effect.

4. **Hepatic coma:** Bromocriptine may cause arousal.
5. Bromocriptine suppresses lactation and breast engorgement in case of neonatal death, but not recommended due to unfavourable risk: benefit ratio.

Side effects: Side effects are frequent and dose related.

Early: Nausea, vomiting, constipation, nasal blockage. Postural hypotension may be marked at initiation of therapy—syncope may occur if starting dose is high. Hypotension is more likely in patients taking antihypertensives.

Late: Behavioral alterations, mental confusion, hallucinations, psychosis—are more prominent than with levodopa.

Abnormal movements, livedo reticularis.

Cabergoline

It is a newer D2 agonist; more potent; more D2 selective and longer acting ($t_{1/2} > 60$ days) than bromocriptine; needs to be given only twice weekly. Incidence of nausea and vomiting is also lower; some patients not tolerating or not responding to bromocriptine have been successfully treated with cabergoline. It is being preferred for treatment of hyperprolactinemia and acromegaly.

Dose: Start with 0.25 mg twice weekly; if needed increase after every 4–8 weeks to max. of 1 mg twice weekly.

CABERLIN 0.5 mg tab, CAMFORTE 0.5, 1 mg tabs.

Pergolide and *Quinagolide* are other D2 agonists effective in hyperprolactinemia.

GONADOTROPINS (Gns)

The anterior pituitary secretes two Gns *viz.* FSH and LH. Both are glycoproteins containing 23–28% sugar and consist of two peptide chains having a total of 207 amino acid residues. FSH has MW 32,000 while LH has MW 30,000.

Physiological functions FSH and LH act in concert to promote gametogenesis and secretion of gonadal hormones.

FSH In the female it induces follicular growth, development of ovum and secretion of estrogens. In the male it supports spermatogenesis and has a trophic influence on seminiferous tubules. Ovarian and testicular atrophy occurs in the absence of FSH.

LH It induces preovulatory swelling of the ripe graafian follicle and triggers ovulation followed

by luteinization of the ruptured follicle and sustains corpus luteum till the next menstrual cycle. It is also probably responsible for atresia of the remaining follicles. Progesterone secretion occurs only under the influence of LH. In the male LH stimulates testosterone secretion by the interstitial cells and is designated interstitial cell stimulating hormone (ICSH).

Distinct LH and FSH receptors are expressed on the target cells. Both are G protein coupled receptors which on activation increase cAMP production. This in turn stimulates gametogenesis and conversion of cholesterol to pregnenolone—the first step in progesterone, testosterone and estrogen synthesis. In the testes FSH receptor is expressed on seminiferous (Sertoli) cells while LH receptor is expressed on interstitial (Leydig) cells. In the ovaries FSH receptors are present only on granulosa cells, while LH receptors are widely distributed on interstitial cells, theca cells, preovulatory granulosa cells and luteal cells.

Regulation of secretion A single releasing factor (decapeptide designated GnRH) is produced by the hypothalamus which stimulates synthesis and release of both FSH and LH from pituitary. It is, therefore, also referred to as FSH/LH-RH or simply LHRH or gonadorelin. It has been difficult to explain how hypothalamus achieves a divergent pattern of FSH and LH secretion in menstruating women through a single releasing hormone. Since GnRH is secreted in pulses and the frequency as well as amplitude of the pulses differs during follicular (high frequency, low amplitude) and luteal (lower frequency, higher amplitude) phases, it has been proposed that frequency and amplitude of GnRH pulses determines whether FSH or LH or both will be secreted as well as the amount of each. Further, the feedback regulation of FSH and LH may be different. In general, feedback inhibition of LH is more marked than that of FSH. In females estradiol and progesterone inhibit both FSH and LH secretion mainly through hypothalamus, but also by direct action on pituitary. However, the preovulatory rise in estrogen level paradoxically stimulates LH and FSH secretion. In addition there are other regulatory substances, e.g. *Inhibin*—a peptide from ovaries and testes selectively inhibits FSH release: *dopamine* inhibits only LH release. Testosterone is weaker than estrogens in inhibiting Gn secretion, but has effect on both FSH and LH. GnRH acts on gonadotropes through a G-protein coupled receptor which acts by increasing intracellular Ca^{2+} through PIP_2 hydrolysis.

The Gn secretion increases at puberty and is higher in women than in men. In men, the levels of FSH and LH remain practically constant (LH > FSH) while in menstruating women they fluctuate cyclically. During the follicular phase, moderate levels of FSH and low levels of LH prevail. There is a midcycle surge of both, but more of LH, just

before ovulation, followed by progressive fall during the luteal phase. Gn levels are high in menopausal women due to loss of feedback inhibition by sex steroids and inhibin.

Pathological involvement Disturbances of Gn secretion from pituitary may be responsible for delayed puberty or precocious puberty both in girls and boys.

Inadequate Gn secretion results in amenorrhoea and sterility in women; oligozoospermia, impotence and infertility in men. Excess production of Gn in adult women causes polycystic ovaries.

Preparations

All gonadotropin preparations are administered by i.m. route. They are partly metabolized, but mainly excreted unchanged in urine: $t_{1/2}$ 2–6 hours.

1. *Menotropins (FSH + LH)*: is a preparation obtained from urine of menopausal women:

PREGNORM, PERGONAL, GYNOGEN 75/150; 75 IU FSH + 75 IU LH activity per amp, also 150 IU FSH + 150 IU LH per amp.

2. *Urofollitropin or Menotropin (pure FSH)*: **METRODIN, ENDOGEN, FOLICULIN, PUREGON 75 IU and 150 IU per amp.** This preparation has been preferred over the combined FSH + LH preparation for induction of ovulation in women with polycystic ovarian disease: these patients have elevated LH/FSH ratio; use of FSH alone is considered advantageous. It is also claimed to improve chances of obtaining good quality ova for *in vitro* fertilization.

3. *Human chorionic gonadotropin (HCG)*: is derived from urine of pregnant women.

CORION, PROFASI, PUBERGEN 1000 IU, 2000 IU, 5000 IU, 10,000 IU, all as dry powder with separate solvent for injection.

The foetal placenta secretes HCG which is absorbed in maternal circulation and maintains corpus luteum of pregnancy. It is a glycoprotein with 33% sugar and 237 amino acids in two chains, MW 38000. It is excreted in urine by the mother from which it is commercially obtained. HCG binds to LH receptor with equal avidity; action of HCG is indistinguishable from that of LH.

Recombinant human FSH (rFSH: *Follitropin α* and *follitropin β*) and recombinant human LH (rLH: *Lutropin*) as well as recombinant HCG (rHCG: *Choriogonadotropin α*) have become available in some countries, but are more expensive.

Uses

1. ***Amenorrhoea and infertility*** When it is due to deficient production of Gns by pituitary. Gns are generally tried when attempts to induce ovulation with clomiphene have failed or when nonovulation is due to polycystic ovaries. The

procedure is to give 1 injection of menotropins (75 IU FSH + 75 IU LH or 75 IU pure FSH) i.m. daily for 10 days followed the next day by 10,000 IU of HCG. Ovulation occurs within the next 24–48 hours in upto 75% cases and the woman may conceive. However, rates of abortion and multiple pregnancy are high, but not of teratogenesis.

To improve predictability of time of ovulation (controlled ovarian hyperstimulation) most experts now concurrently suppress endogenous FSH/LH secretion either by continuous pretreatment with a superactive GnRH agonist or by a GnRH antagonist.

2. ***Hypogonadotrophic hypogonadism in males*** manifesting as delayed puberty or defective spermatogenesis \rightarrow oligozoospermia, male sterility — start with 1000–4000 IU of HCG i.m. 2–3 times a week (to stimulate testosterone secretion), add FSH 75 IU + LH 75 IU after 3–4 months (to stimulate spermatogenesis) and reduce dose of HCG; continue treatment for 6–12 months for optimum results, which nevertheless are not always impressive.

3. ***Cryptorchism*** Since undescended testes can cause infertility and predispose to testicular cancer, medical/surgical treatment is imperative. Descent of testes can be induced by androgens whose production is stimulated by LH. Treatment with HCG can be tried between the age of 1–7 years if there is no anatomical obstruction; 1000–2000 IU is given i.m. 2–3 times a week till the testes descend. If 2–6 week treatment does not induce descent, surgery should be performed.

4. ***To aid in vitro fertilization*** Menotropins (FSH + LH or pure FSH) have been used to induce simultaneous maturation of several ova and to precisely time ovulation so as to facilitate their harvesting for *in vitro* fertilization.

Adverse effects and precautions

Ovarian hyperstimulation—polycystic ovary, pain in lower abdomen and even ovarian bleeding and shock can occur in females.

Precocious puberty is a risk when given to children.

Allergic reactions have occurred and skin tests are advised. Hormone dependent malignancies (prostate, breast) must be excluded.

Other side effects are edema, headache, mood changes.

Gonadotropin releasing hormone (Gn RH): Gonadorelin Synthetic Gn RH injected i.v. (100 µg) induces prompt release of LH and FSH followed by elevation of gonadal steroid levels. It has a short plasma $t_{1/2}$ (4–8 min) due to rapid enzymatic degradation; has been used for testing pituitary-gonadal axis in male as well as female hypogonadism.

Since only pulsatile exposure to GnRH induces FSH/LH secretion, while continuous exposure desensitizes pituitary gonadotropes resulting in loss of Gn release, therapy with GnRH or its analogues is not useful in the treatment of hypogonadism.

Superactive /long-acting GnRH agonists Many analogues of GnRH, e.g. Buserelin, Goserelin, Leuprolide, Nafarelin, Triptorelin, have been developed: are 15–150 times more potent than natural Gn RH and longer acting ($t_{1/2}$ 2–6 hours) because of high affinity for GnRH receptor and resistance to enzymatic hydrolysis. They acutely increase Gn secretion, but after 1–2 weeks cause desensitization and down regulation of Gn RH receptors → inhibition of FSH and LH secretion → suppression of gonadal function. Spermatogenesis or ovulation cease and testosterone or estradiol levels fall to castration levels. Recovery occurs within 2 months of stopping treatment.

The superactive GnRH agonists are used as nasal spray or injected s.c. Long-acting preparations for once a month s.c. injection have been produced (triptorelin, goserelin depot). The resulting reversible pharmacological oophorectomy/orchiectomy is being used in precocious puberty, prostatic carcinoma, endometriosis, premenopausal breast cancer, uterine leiomyoma, polycystic ovarian disease and to assist induced ovulation. It also has potential to be used as contraceptive for both males and females.

Nafarelin This long-acting GnRH agonist is 150 times more potent than native GnRH; used as **NASAREL 2 mg/ml soln for nasal spray; 200 µg per actuation.**

Down regulation of pituitary GnRH receptors occurs in 10 days but peak inhibition of Gn release occurs at one month. It is broken down in the body to shorter peptide segments; plasma $t_{1/2}$ is 2–3 hours. Uses are:

Assisted reproduction: Endogenous LH surge needs to be suppressed when controlled ovarian hyperstimulation is attempted by exogenous FSH and LH injection, so that precisely timed mature oocytes can be harvested. This is achieved by 400 µg BD intranasal nafarelin, reduced to 200 µg BD when menstrual bleeding occurs.

Uterine fibroids: Nafarelin 200 µg BD intranasal for 3–6 months can reduce the size of leiomyoma and afford symptomatic relief.

Endometriosis: 200 µg in alternate nostril BD for upto 6 months. As effective as danazol, but second course cannot be given due to risk of osteoporosis.

Central precocious puberty: 800 µg BD by nasal spray; breast and genital development is arrested in girls and boys. The effect is reversible; pubertal changes resume when therapy is discontinued.

Adverse effects: Hot flashes, loss of libido, vaginal dryness, osteoporosis, emotional lability.

Triptorelin: This long-acting GnRH agonist can be injected i.m. at 4 week intervals; therefore preferred for indications where long-term Gn suppression is desired, such as carcinoma prostate, endometriosis, precocious puberty and uterine leiomyoma. For prostate cancer, it is combined with an androgen antagonist flutamide or bicalutamide to prevent the initial flare up of the tumour that occurs due to increase in Gn secretion for the first 1–2 weeks.

Dose: 2.5–3.5 mg i.m. at 3–4 week intervals.

TRYPLOG 2.5 mg/5 ml vial for inj.

GnRH antagonists Some more extensively substituted GnRH analogues act as GnRH receptor antagonists. They inhibit Gn secretion without causing initial stimulation. The early GnRH antagonists had the limitation of producing reactions due to histamine release. Newer agents like *ganirelix* and *cetrorelix* have low histamine releasing potential and are being clinically used in specialized centres for inhibiting LH surges during controlled ovarian stimulation in women undergoing *in vitro* fertilization. Their advantages over long-acting GnRH agonists include:

- They produce quick Gn suppression by competitive antagonism, need to be started only from 6th day of ovarian hyperstimulation.
- They carry a lower risk of ovarian hyperstimulation syndrome.

- They achieve more complete suppression of endogenous Gn secretion.

However, pregnancy rates are similar or may even be lower.

THYROID STIMULATING HORMONE (TSH, THYROTROPIN)

It is a 210 amino acid, two chain glycoprotein (22% sugar), MW 30000.

Physiological function TSH stimulates thyroid to synthesize and secrete thyroxine (T_4) and triiodothyronine (T_3). Its actions are:

- Induces hyperplasia and hypertrophy of thyroid follicles and increases blood supply to the gland.
- Promotes trapping of iodide by thyroid.
- Promotes organification of trapped iodine and its incorporation into T_3 and T_4 by increasing peroxidase activity.
- Enhances endocytotic uptake of thyroid colloid by the follicular cells and proteolysis of thyroglobulin to release more of T_3 and T_4 . This action starts within minutes of TSH administration.

The TSH receptor present on thyroid cells is a G protein coupled receptor which utilizes the adenylyl cyclase-cAMP transducer mechanism to produce its effects. In human thyroid cells high concentration of TSH also induces PIP_2 hydrolysis. The resulting increase in cytosolic Ca^{2+} and protein kinase C activation may also mediate TSH actions.

Regulation of secretion Synthesis and release of TSH by pituitary is controlled by hypothalamus through TRH. The negative feedback inhibiting TSH secretion is provided by the thyroid hormones which act primarily at the level of the pituitary, but also in the hypothalamus. T_3 has been shown to reduce TRH receptors on thyrotropes.

Pathological involvement Only few cases of hypo- or hyperthyroidism are due to inappropriate TSH secretion. In majority of cases of myxoedema TSH levels are markedly elevated because of deficient feedback inhibition. Graves' disease is due to an immunoglobulin of the IgG class which attaches to the thyroid cells and stimulates them in the same way as TSH. Consequently, TSH levels are low. Contrary to earlier belief, TSH is not responsible for exophthalmos seen in Graves' disease because TSH levels are low.

Use Thyrotropin has no therapeutic use. Thyroxine is the drug of choice even when hypothyroidism is due to TSH deficiency. The diagnostic application is to differentiate myxoedema due to pituitary dysfunction from primary thyroid disease.

ADRENOCORTICOTROPIC HORMONE (ACTH, CORTICOTROPIN)

It is a 39 amino acid single chain peptide, MW 4500, derived from a larger peptide *pro-opio melanocortin* (MW 30,000) which also gives rise to endorphins, two lipotropins and two MSHs.

Physiological function ACTH promotes steroidogenesis in adrenal cortex by stimulating cAMP formation in cortical cells (through specific cell surface G protein coupled receptors) → rapidly increases the availability of cholesterol for conversion to pregnenolone which is the rate limiting step in the production of gluco, mineralo and weakly androgenic steroids. Induction of steroidogenic enzymes occurs after a delay. The stores of adrenal steroids are very limited and rate of synthesis primarily governs the rate of release. ACTH also exerts trophic influence on adrenal cortex (again through cAMP): high doses cause hypertrophy and hyperplasia. Absence of ACTH results in adrenal atrophy. However, zona glomerulosa is little affected because angiotensin II also exerts trophic influence on this layer and sustains aldosterone secretion.

Regulation of secretion Hypothalamus regulates ACTH release from pituitary through corticotropin-releasing hormone (CRH). The CRH receptor on corticotropes is also a G protein coupled receptor which increases ACTH synthesis as well as release through increased cAMP. Secretion of ACTH has a circadian rhythm. Peak plasma levels occur in the early morning, decrease during day and are lowest at midnight. Corticosteroids exert inhibitory feedback influence on ACTH production by acting directly on the pituitary as well as indirectly through hypothalamus.

A variety of stressful stimuli, e.g. trauma, surgery, severe pain, anxiety, fear, blood loss, exposure to cold, etc. generate neural impulses which converge on median eminence to cause elaboration of CRH. The feedback inhibition appears to be overpowered during stress—rise in ACTH secretion continues despite high plasma level of cortisol induced by it. Vasopressin has been found to enhance action of CRH on corticotropes and augment ACTH release.

Pathological involvement Excess production of ACTH from basophil pituitary tumours is responsible for some cases of Cushing's syndrome. Hypocorticism occurs in pituitary insufficiency due to low ACTH production. Iatrogenic suppression of ACTH secretion and pituitary adrenal axis is the most common form of abnormality encountered currently due to the use of pharmacological doses of glucocorticoids in nonendocrine diseases.

Use ACTH is used primarily for the diagnosis of disorders of pituitary adrenal axis. Injected i.v. 25 IU causes increase in plasma cortisol if the adrenals are functional. Direct assay of plasma ACTH level is now preferred.

For therapeutic purposes, ACTH does not offer any advantage over corticosteroids and is more inconvenient, expensive as well as less predictable.

CHAPTER 18

Thyroid Hormones and Thyroid Inhibitors

THYROID HORMONE

The thyroid gland secretes 3 hormones—thyroxine (T_4), triiodothyronine (T_3) and calcitonin. The former two are produced by thyroid follicles, have similar biological activity and the term ‘thyroid hormone’ is restricted to these only. *Calcitonin* produced by interfollicular ‘C’ cells is chemically and biologically entirely different. It is considered along with parathormone, (Ch. 24) with which it regulates calcium metabolism.

The physiological significance of thyroid gland was recognized only after Graves and Basedow (1835, 1840) associated the clinical features of the ‘Graves’ disease’ with swelling of thyroid gland and Gull (1874) correlated myxoedema with its atrophy. Kendall (1915) obtained crystalline thyroxine and suggested its chemical formula which was confirmed in 1926. Thyroxine was the first hormone to be synthesized in the laboratory. Later, as T_4 could not account for all the biological activity of thyroid extract, search was made and more potent T_3 was discovered in 1952.

CHEMISTRY AND SYNTHESIS

Both T_4 and T_3 are iodine containing derivatives of *thyronine* which is a condensation product of two molecules of the amino acid *tyrosine*. *Thyroxine*; is 3, 5, 3', 5'-tetraiodothyronine while T_3 is 3, 5, 3' triiodothyronine.

The thyroid hormones are synthesized and stored in the thyroid follicles as part of *thyroglo-*

bulin molecule—which is a glycoprotein synthesized by thyroid cells, MW 660 KDa, contains 10% sugar. The synthesis, storage and release of T_4 and T_3 is summarized in Fig. 18.1 and involves the following processes.

1. **Iodide uptake** The total body content of I_2 , obtained from food and water, is 30–50 mg, out of which about 1/5 is present in the thyroid. Concentration of iodide in blood is low (0.2–0.4 $\mu\text{g}/\text{dl}$) but thyroid cells have an active transport process ($\text{Na}^+:\text{I}^-$ symporter or NIS) to concentrate this anion; this trapping is stimulated by TSH to exceed a gradient of more than 100 fold. The I_2 content of thyroid gland somehow regulates the uptake mechanism: meagre store activating and large store inhibiting it. The iodide concentrating mechanism is not peculiar to thyroid; skin, salivary glands, gastric mucosa, intestine, mammary glands and placenta also possess it, but uptake in these organs is not stimulated by TSH.

2. **Oxidation and iodination** Iodide trapped by follicular cells is carried across the apical membrane by another transporter termed ‘pendrin’ and oxidized by the membrane bound thyroid peroxidase enzyme to iodinium (I^+) ions or hypoiodous acid (HOI) or enzyme-linked hypoiodate (E-OI) with the help of H_2O_2 . These forms of iodine combine avidly with tyrosil residues of

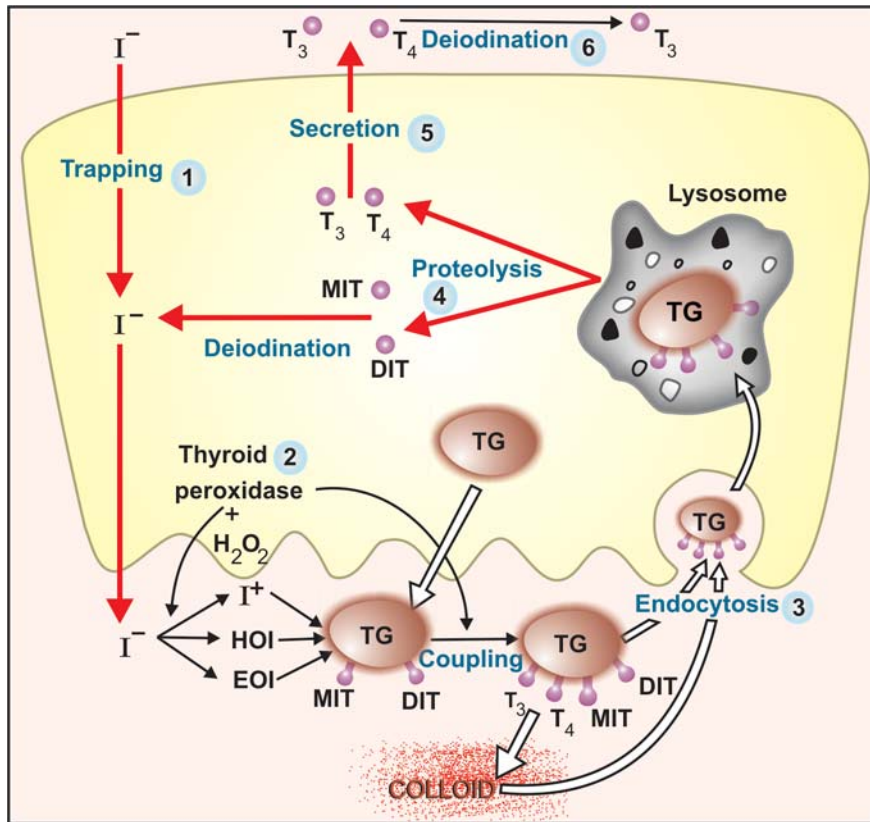

Fig. 18.1: Synthesis, storage and secretion of thyroid hormone
 TG—Thyroglobulin; MIT—Monoiodotyrosine; DIT—Diiodotyrosine; T₃—Triiodothyronine; T₄—Thyroxine (Tetraiodothyronine); HOI—Hypoiodous acid; EOI—Enzyme linked hypoiodate
 Thyroid-stimulating hormone (TSH) activates steps 1, 2, 3, 4, and 5; Ionic inhibitors block step 1; Excess iodide interferes with steps 1, 2, 3 and 5 with primary action on step 3 and 5; Propylthiouracil inhibits steps 2 and 6; Carbimazole inhibits step 2 only

thyroglobulin, apparently without any enzymatic intervention, to form monoiodotyrosine (MIT) and diiodotyrosine (DIT) while the residues are still attached to the thyroglobulin chains.

3. Coupling Pairs of iodinated tyrosil residues couple together (Fig. 18.2) to form T₃ and T₄.

Normally much more T₄ than T₃ is formed, but during I₂ deficiency relatively more MIT is available and a greater proportion of T₃ is formed. Thus, more active hormone is generated with lesser amount of I₂.

Coupling is an oxidative reaction and is catalysed by the same thyroid peroxidase.

Thyroglobulin is the most efficient protein in supporting coupling by providing favourable spatial configuration to facilitate the reaction. Oxidation of iodide and coupling are both stimulated by TSH.

4. Storage and release Thyroglobulin containing iodinated tyrosil and thyronil residues is transported to the interior of the follicles and remains stored as thyroid colloid till it is taken back into the cells by endocytosis and broken down by lysosomal proteases. The T₄ and T₃ so released is secreted into circulation while MIT and DIT residues are deiodinated and the iodide

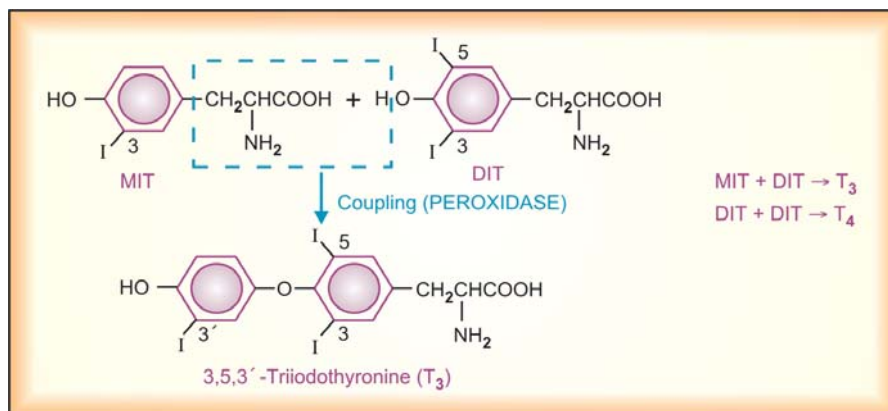

Fig. 18.2: Coupling of monoiodotyrosine (MIT) and diiodotyrosine (DIT) to produce triiodothyronine (T₃)

released is reutilized. The uptake of colloid and proteolysis are stimulated by TSH: the quiescent gland has follicles distended with colloid and cells are flat or cubical, while the TSH stimulated gland has columnar cells and colloid virtually disappears.

Normal human thyroid secretes 60–90 µg of T₄ and 10–30 µg of T₃ daily.

5. Peripheral conversion of T₄ to T₃ Peripheral tissues, especially liver and kidney, convert T₄ to T₃. About 1/3 of T₄ secreted by thyroid undergoes this change and most of the T₃ in plasma is derived from liver. Target tissues take up T₃ from circulation for their metabolic need, except brain and pituitary which take up T₄ and convert it to T₃ within their own cells. Almost equal amounts of 3,5,3' triiodothyronine (normal T₃: active) and 3,3',5' triiodothyronine (reverse T₃: inactive) are produced in the periphery. Propylthiouracil (but not carbimazole), propranolol (high doses), amiodarone and glucocorticoids inhibit peripheral conversion of T₄ to T₃ (except in brain and pituitary).

TRANSPORT, METABOLISM AND EXCRETION

Thyroid hormones are avidly bound to plasma proteins—only 0.03–0.08% of T₄ and 0.2–0.5% of T₃ are in the free form. Almost all protein bound

iodine (PBI) in plasma is thyroid hormone, of which 90–95% is T₄ and the rest T₃. Binding occurs to 3 plasma proteins. In the order of affinity for T₄, these are:

- (i) Thyroxine binding globulin (TBG)
- (ii) Thyroxine binding prealbumin (transthyretin)
- (iii) Albumin

The normal concentration of PBI is 4–10 µg/dl; only 0.1–0.2 µg/dl of this is T₃, rest is T₄. During pregnancy thyroxine binding globulin is increased—PBI levels are elevated, but there is no effect on thyroid status as the concentration of free hormone remains unaltered.

Only the free hormone is available for action as well as for metabolism and excretion. Metabolic inactivation of T₄ and T₃ occurs by deiodination and glucuronide/sulfate conjugation of the hormones as well as of their deiodinated products. Liver is the primary site (also salivary glands and kidneys). The conjugates are excreted in bile. A significant fraction is deconjugated in intestines and reabsorbed (enterohepatic circulation) to be finally excreted in urine.

Plasma t_{1/2} of T₄ is 6–7 days, while that of T₃ is 1–2 days. The half-lives are shortened in hyperthyroidism and prolonged in hypothyroidism due respectively to faster and slower metabolism.

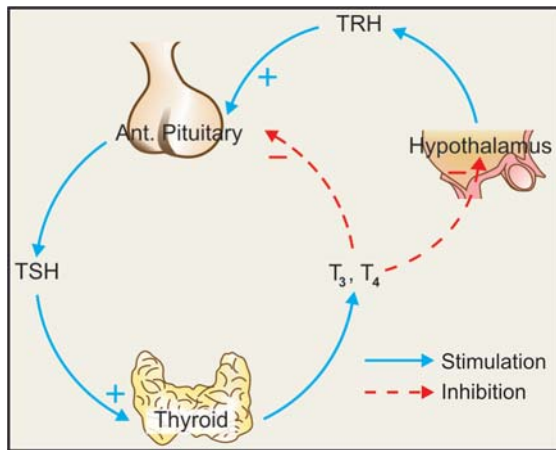

Fig. 18.3: Regulation of thyroid function

TSH—Thyroid stimulating hormone; TRH—Thyrotropin releasing hormone; T_3 —Triiodothyronine; T_4 —Thyroxine.

REGULATION OF SECRETION

The secretion of hormones from the thyroid is controlled by anterior pituitary by the elaboration of thyrotropin (*see p. 240*). The relation between the two glands is depicted in Fig. 18.3. The negative feedback by the thyroid hormones is exercised directly on the pituitary as well as through hypothalamus. The action of TRH on pituitary and that of TSH on thyroid cells is mediated by enhanced cAMP synthesis. High concentration of TSH also acts *via* IP_3 /DAG—increased intracellular Ca^{2+} pathway in the thyroid cells.

ACTIONS

The actions of T_4 and T_3 are qualitatively similar and are nicely depicted in the features of hypo and hyperthyroidism. They affect the function of practically all body cells.

1. Growth and development T_4 and T_3 are essential for normal growth and development. The most remarkable action is metamorphosis of tadpole to frog: the tail is used-up to build lungs, limbs and other organs. The action cannot be broadly labelled as catabolic or anabolic. It is exerted through a critical control of protein

synthesis in the translation of the genetic code. Congenital deficiency of T_4 and T_3 resulting in cretinism emphasizes their importance. The milestones of development are delayed and practically every organ and tissue of the body suffers. The greatest sufferer, however, is the nervous system. Retardation and nervous deficit is a consequence of paucity of axonal and dendritic ramification, synapse formation and impaired myelination. In adult hypothyroidism also, intelligence is impaired and movements are slow.

2. Intermediary metabolism Thyroid hormones have marked effect on lipid, carbohydrate and protein metabolism.

Lipid T_4 and T_3 indirectly enhance lipolysis by potentiating the action of catecholamines and other lipolytic hormones, probably by suppressing a phosphodiesterase \rightarrow increased cAMP: plasma free fatty acid levels are elevated. Lipogenesis is also stimulated. All phases of cholesterol metabolism are accelerated, but its conversion to bile acids dominates. Thus, hyperthyroidism is characterized by hypocholesterolemia. LDL levels in blood are reduced.

Carbohydrate Carbohydrate metabolism is also stimulated. Though utilization of sugar by tissues is increased (mainly secondary to increased BMR), glycogenolysis and gluconeogenesis in liver as well as faster absorption of glucose from intestines more than compensate it \rightarrow hyperglycaemia and diabetic-like state with insulin resistance occur in hyperthyroidism.

Protein Synthesis of certain proteins is increased, but the overall effect of T_3 is catabolic—increased amounts of protein being used as energy source. Prolonged action results in negative nitrogen balance and tissue wasting. Weight loss is a feature of hyperthyroidism. T_3 , T_4 in low concentrations inhibit mucoprotein synthesis which so characteristically accumulates in myxoedema.

3. Calorigenesis T_3 and T_4 increase BMR by stimulation of cellular metabolism and resetting

of the energystat. This is important for maintaining body temperature. However, metabolic rate in brain, gonads, uterus, spleen and lymph nodes is not significantly affected. The mechanism of calorogenesis was believed to be uncoupling of oxidative phosphorylation: excess energy being released as heat. However, this occurs only at very high doses and is not involved in mediating the physiological actions of T_3 , T_4 . Dinitrophenol uncouples oxidative phosphorylation, but has no thyroid-like activity.

4. CVS T_3 and T_4 cause a hyperdynamic state of circulation which is partly secondary to increased peripheral demand and partly due to direct cardiac actions. Heart rate, contractility and output are increased resulting in a fast, bounding pulse. T_3 and T_4 stimulate heart by direct action on contractile elements (increasing the myosin fraction having greater Ca^{2+} ATPase activity) and probably by up regulation of β adrenergic receptors. Atrial fibrillation and other irregularities are common in hyperthyroidism. Thyroid hormones can also precipitate CHF and angina. BP, specially systolic, is often raised. Myocardial O_2 consumption can be markedly reduced by induction of hypothyroidism.

5. Nervous system T_3 , T_4 have profound functional effect on CNS. Mental retardation is the hallmark of cretinism; sluggishness and other behavioral features are seen in myxoedema. Hyperthyroid individuals are anxious, nervous, excitable, exhibit tremors and hyperreflexia.

6. Skeletal muscle Muscles are flabby and weak in myxoedema, while thyrotoxicosis produces increased muscle tone, tremor and weakness due to myopathy.

7. GIT Propulsive activity of gut is increased by T_3/T_4 . Hypothyroid patients are often constipated, while diarrhoea is common in hyperthyroidism.

8. Kidney T_3 and T_4 do not cause diuresis in euthyroid individuals, but the rate of urine flow is often increased when myxoedematous patients are treated with it.

9. Haemopoiesis Hypothyroid patients suffer from some degree of anaemia which is restored only by T_4 treatment. Thus, T_4 appears to be facilitatory to erythropoiesis.

10. Reproduction Thyroid has an indirect effect on reproduction. Fertility is impaired in hypothyroidism and women suffer from oligomenorrhoea. Normal thyroid function is required for maintenance of pregnancy and lactation.

Mechanism of action

Both T_3 and T_4 penetrate cells by active transport and produce majority of their actions by combining with a nuclear thyroid hormone receptor (TR) which belongs to the steroid and retinoid superfamily of intracellular receptors.

Two TR isoform families ($TR\alpha$ and $TR\beta$) have been identified. Both bind T_3 and function in similar manner, but their tissue distribution differs, which may account for quantitative differences in the sensitivity of different tissues to T_3 .

In contrast to the steroid receptor, the TR resides in the nucleus even in the unliganded inactive state. It is bound to the 'thyroid hormone response element' (TRE) in the enhancer region of the target genes along with corepressors (Fig. 18.4). This keeps gene transcription suppressed. When T_3 binds to the ligand-binding domain of TR, it heterodimerizes with retinoid X receptor (RXR) and undergoes a conformation change releasing the corepressor and binding the coactivator. This induces gene transcription \rightarrow production of specific mRNA and a specific pattern of protein synthesis \rightarrow various metabolic and anatomic effects.

Many of the effects, e.g. tachycardia, arrhythmias, raised BP, tremor, hyperglycaemia are mediated, at least partly, by sensitization of adrenergic receptors to catecholamines. Induction of adenylyl cyclase, proliferation of β adrenoceptors and a better coupling between these two has been demonstrated.

Apart from the nuclear T_3 receptor, other sites of thyroid hormone action have been described. It acts on cell membrane to enhance amino acid and glucose entry and on

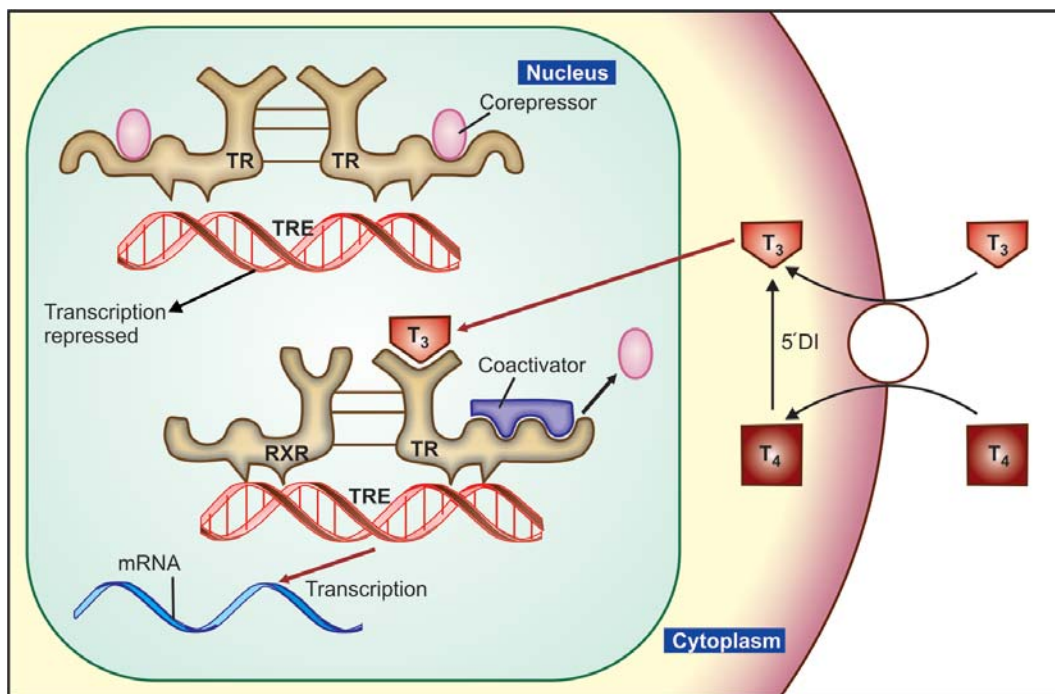

Fig. 18.4: Mechanism of action of thyroid hormone on nuclear thyroid hormone receptor (TR).

T₃—Triiodothyronine; T₄—Thyroxine; TRE—Thyroid hormone response element; RXR—Retinoid X receptor; mRNA—Messenger ribonucleic acid; 5'DI—5'Deiodinase (See text for explanation)

mitochondria to increase oxygen consumption. At these sites T₄ appears to be equipotent to T₃, while at the nuclear receptor T₄ has much lower affinity, and even when bound to the TR, T₄ does not promote gene transcription.

Relation between T₄ and T₃

- Thyroid secretes more T₄ than T₃, but in iodine deficient state this difference is reduced.
- T₄ is the major circulating hormone because it is 15 times more tightly bound to plasma proteins.
- T₃ is 5 times more potent than T₄ and acts faster. Peak effect of T₃ comes in 1–2 days while that of T₄ takes 6–8 days.
- T₃ is more avidly bound to the nuclear receptor than T₄ and the T₄-receptor complex is unable to activate/derepress gene transcription.
- About 1/3 of T₄ is converted to T₃ in the thyroid cells, liver and kidney by D1 type of 5'deiodinase (5'DI) and released into

circulation. In addition, T₃ is generated within the target cells (skeletal muscle, heart, brain, pituitary) by another type (D2) of 5'DI. Thus, it may be concluded that T₃ is the active hormone, while T₄ is mainly a transport form; functions as a prohormone of T₃. However, it may directly produce some nongenomic actions.

Preparations

l-thyroxine sod.: **ELTROXIN, ROXIN 100 µg tab. THYRONORM, THYROX 25 µg, 50 µg, 100 µg tabs.**
 Triiodothyronine (Liothyronine) 5, 25 µg tab—25 µg is equivalent to 100 µg of l-thyroxine: not freely available in India. It is occasionally used i.v. along with l-thyroxine in myxoedema coma.

Oral bioavailability of l-thyroxine is ~ 75%, but severe hypothyroidism can reduce oral absorption. It should be administered in empty stomach to avoid interference by food. Sucralfate, iron and calcium also reduce l-thyroxine absorption. Enzyme inducers like rifampin, phenytoin and

carbamazepine accelerate metabolism of T_4 ; dose of l-thyroxine may need enhancement. Clinically, l-thyroxine is preferred for all indications over liothyronine because of more sustained and uniform action as well as lower risk of cardiac arrhythmias.

USES

The most important uses of thyroid hormone are as *replacement therapy* in deficiency states:

1. Cretinism It is due to failure of thyroid development or a defect in hormone synthesis (sporadic cretinism) or due to extreme iodine deficiency (endemic cretinism). It is usually detected during infancy or childhood. Treatment with thyroxine (8–12 $\mu\text{g}/\text{kg}$) daily should be started as early as possible, because mental retardation that has already ensued is only partially reversible. Response is dramatic: physical growth and development are restored and further mental retardation is prevented.

2. Adult hypothyroidism This is one of the commonest endocrine disorders which develops as a consequence of thyroiditis, thyroidectomy; may accompany simple goiter if iodine deficiency is severe, or may be idiopathic. Important drugs that can cause hypothyroidism are ^{131}I , iodides, lithium and amiodarone. Treatment with T_4 is most gratifying. It is often wise to start with a low dose—50 μg of l-thyroxine daily and increase every 2–3 weeks to an optimum of 100–200 $\mu\text{g}/\text{day}$ (adjusted by clinical response and serum TSH levels). Further dose adjustments are made at 4–6 week intervals needed for reaching steady-state. Individualization of proper dose is critical, aiming at normalization of serum TSH levels. Increase in dose is mostly needed during pregnancy.

Subclinical hypothyroidism characterized by euthyroid status and raised TSH level ($>10\text{ mU}/\text{L}$) should be treated with T_4 if other cardiovascular risk factors are present; otherwise replacement therapy is optional.

3. Myxoedema coma It is an emergency; characterized by progressive mental deterioration

due to acute hypothyroidism: carries significant mortality. Rapid thyroid replacement is crucial. Though liothyronine (T_3) acts faster, its use is attended by higher risk of cardiac arrhythmias, angina, etc. Drug of choice is l-thyroxine (T_4) 200–500 μg i.v. followed by 100 μg i.v. OD till oral therapy can be instituted. Some authorities recommend adding low dose i.v. T_3 10 μg 8 hourly in younger patients with no arrhythmia or ischaemia. Alternatively oral T_4 500 μg loading dose followed by 100–300 μg daily may be used, but in severe hypothyroidism, oral absorption is delayed and inconsistent.

Corticosteroids to cover attendant adrenal insufficiency, ventilatory and cardiovascular support, correction of hyponatraemia, hypoglycaemia, etc. are the other measures.

4. Nontoxic goiter It may be endemic or sporadic. Endemic is due to iodine deficiency which may be accentuated by factors present in water (excess calcium), food or milk (goitrin, thiocyanates). A defect in hormone synthesis may be responsible for sporadic cases. In both types, deficient production of thyroid hormone leads to excess TSH \rightarrow thyroid enlarges, more efficient trapping of iodide occurs and probably greater proportion of T_3 is synthesized \rightarrow enough hormone to meet peripheral demands is produced. Thus, treatment with T_4 is in fact replacement therapy in this condition also, despite no overt hypothyroidism. Full maintenance doses must be given. Most cases of recent diffuse enlargement of thyroid regress. Long-standing goiters with degenerative and fibrotic changes and nodular goiter respond poorly or not at all. Therapy may be withdrawn after a year or so in some cases if adequate iodine intake is ensured. Others need life-long therapy.

Endemic goiter and cretinism due to iodine deficiency in pregnant mother is preventable by ensuring daily ingestion of 150–200 μg of iodine. This is best achieved by iodizing edible salt. In India iodization of table salt (100 μg iodine/g salt) is required under the National Programme, but recently mandatory iodization rule has been withdrawn.

5. Thyroid nodule Certain benign functioning nodules regress when TSH is suppressed by T_4 therapy. Nonfunctional nodules and those non-responsive to TSH (that are associated with low TSH levels) do not respond. T_4 therapy should be stopped if the nodule does not decrease in size within 6 months and when it stops regressing.

6. Papillary carcinoma of thyroid It is often responsive to TSH. In nonresectable cases, full doses of T_4 suppress TSH production and may induce temporary regression.

7. Empirical uses T_4 has been sometimes used in the following conditions without any rationale; response is unpredictable.

Refractory anaemias.

Menstrual disorders, infertility not corrected by usual treatment.

Chronic/non healing ulcers.

Obstinate constipation.

Thyroxine is not recommended for obesity and as a hypocholesterolemic agent.

THYROID INHIBITORS

These are drugs used to lower the functional capacity of the hyperactive thyroid gland.

Thyrotoxicosis is due to excessive secretion of thyroid hormones. The two main causes are *Graves' disease* and *toxic nodular goiter*. *Graves' disease* is an autoimmune disorder: IgG class of antibodies to the TSH receptor are detected in blood. They bind to and stimulate thyroid cells, and produce other TSH like effects. Due to feedback inhibition, TSH levels are low. The accompanying exophthalmos is due to autoimmune inflammation of periorbital tissues.

Toxic nodular goiter, which produces thyroid hormone independent of TSH, mostly supervenes on old nontoxic goiters. It is more common in the elderly; ocular changes are generally absent.

CLASSIFICATION

1. *Inhibit hormone synthesis (Antithyroid drugs)*
Propylthiouracil, Methimazole, Carbimazole.

2. *Inhibit iodide trapping (Ionic inhibitors)*

Thiocyanates ($-\text{SCN}$), Perchlorates ($-\text{ClO}_4$), Nitrates ($-\text{NO}_3$).

3. *Inhibit hormone release*

Iodine, Iodides of Na and K, Organic iodide.

4. *Destroy thyroid tissue*

Radioactive iodine (^{131}I , ^{125}I , ^{123}I).

Compounds in groups 1 and 2 may be collectively called *goitrogens*.

In addition, certain drugs used in high doses for prolonged periods cause hypothyroidism/goiter as a side effect:

- Lithium: inhibits thyroid hormone release.
- Amiodarone: inhibits peripheral conversion of T_4 to T_3 ; also interferes with thyroid hormone action.
- Sulfonamides, paraaminosalicylic acid: inhibit thyroglobulin iodination and coupling reaction.
- Phenobarbitone, phenytoin, carbamazepine, rifampin: induce metabolic degradation of T_4/T_3

Goitrin—found in plants (cabbage, turnip, mustard, etc.), is the cause of goiter in cattle who feed on these plants. May contribute to endemic goiter in certain iodine deficient regions.

ANTITHYROID DRUGS

By convention, only the synthesis inhibitors are called antithyroid drugs, though this term has also been applied to all thyroid inhibitors.

Thiourea derivatives were found to produce goiter and hypothyroidism in rats in the 1940s. Open chain compounds were found to be toxic. Subsequently, methyl and propyl thiouracil and thioimidazole derivatives methimazole and carbimazole were found to be safe and effective.

Antithyroid drugs bind to thyroid peroxidase and prevent oxidation of iodide/iodotyrosyl residues, thereby;

- Inhibit iodination of tyrosine residues in thyroglobulin
- Inhibit coupling of iodotyrosine residues to form T_3 and T_4 .

Action (ii) has been observed at lower concentration of antithyroid drugs than action (i). Thyroid colloid is depleted over time and blood levels of T_3/T_4 are reduced.

They do not interfere with trapping of iodide and do not modify the action of T_3 and T_4 on peripheral tissues or on pituitary. Goiter is not

Table 18.1: Differences between propylthiouracil and carbimazole

<i>Propylthiouracil</i>	<i>Carbimazole</i>
1. Dose to dose less potent	About 5 × more potent
2. Highly plasma protein bound	Less bound
3. Less transferred across placenta and in milk	Larger amounts cross to foetus and in milk
4. Plasma $t_{1/2}$ 1–2 hours	6–10 hours
5. Single dose acts for 4–8 hours	12–24 hours
6. No active metabolite	Produces active metabolite—methimazole
7. Multiple (2–3) daily doses needed	Mostly single daily dose
8. Inhibits peripheral conversion of T_4 to T_3	Does not inhibit T_4 to T_3 conversion

the result of potentiation of TSH action on thyroid, but is due to increased TSH release as a consequence of reduction in feedback inhibition. No goiter occurs if antithyroid drugs are given to hypophysectomised animals or if T_4 is given along with them. Antithyroid drugs do not affect release of T_3 and T_4 —their effects are not apparent till thyroid is depleted of its hormone content.

Propylthiouracil also inhibits peripheral conversion of T_4 to T_3 by D1 type of 5'DI, but not by D2 type. This may partly contribute to its effects. Methimazole and carbimazole do not have this action (Table 18.1) and may even antagonize that of propylthiouracil.

Pharmacokinetics All antithyroid drugs are quickly absorbed orally, widely distributed in the body, enter milk and cross placenta; are metabolized in liver and excreted in urine primarily as metabolites. All are concentrated in thyroid: intrathyroid $t_{1/2}$ is longer: effect of a single dose lasts longer than would be expected from the plasma $t_{1/2}$. Carbimazole acts largely by getting converted to methimazole in the body.

Adverse effects Hypothyroidism and goiter can occur due to overtreatment, but is reversible on stopping the drug. It is indicated by enlargement of thyroid, and is due to excess TSH production. Goiter does not develop with appropriate doses which restore T_4 concentration to normal so that feedback TSH inhibition is maintained.

Important side effects are: g.i. intolerance, skin rashes and joint pain.

Loss or graying of hair, loss of taste, fever and liver damage are infrequent.

A rare but serious adverse effect is agranulocytosis (1 in 500 to 1000 cases); It is mostly reversible. There is partial cross reactivity between propylthiouracil and carbimazole.

Preparations and dose

Propylthiouracil: 50–150 mg TDS followed by 25–50 mg BD–TDS for maintenance. **PTU 50 mg tab.**

Methimazole: 5–10 mg TDS initially, maintenance dose 5–15 mg daily in 1–2 divided doses.

Carbimazole: 5–15 mg TDS initially, maintenance dose 2.5–10 mg daily in 1–2 divided doses, **NEO MERCAZOLE, THYROZOLE, ANTITHYROX 5 mg tab.**

Carbimazole is more commonly used in India. Propylthiouracil (600–900 mg/day) may be preferred in thyroid storm for its inhibitory action on peripheral conversion of T_4 to more active T_3 . It is also used in patients developing adverse effects with carbimazole.

Use Antithyroid drugs control thyrotoxicosis in both Graves' disease and toxic nodular goiter. Clinical improvement starts after 1–2 weeks or more (depending on hormone content of thyroid gland). Iodide loaded patients are less responsive. Maintenance doses are titrated on the basis of clinical status of the patient. The following strategies are adopted.

(i) *As definitive therapy* (a) Remission may occur in upto half of the patients of Graves' disease after 1–2 years of treatment: the drug can

then be withdrawn. If symptoms recur—treatment is reinstated. This is preferred in young patients with a short history of Graves' disease and a small goiter.

(b) Remissions are rare in toxic nodular goiter: surgery (or ^{131}I) is preferred. However, in frail elderly patient with multinodular goiter who may be less responsive to ^{131}I , permanent maintenance therapy with antithyroid drugs can be employed.

(ii) *Preoperatively* Surgery in thyrotoxic patients is risky. Young patients with florid hyperthyroidism and substantial goiter are rendered euthyroid with carbimazole before performing subtotal thyroidectomy.

(iii) *Along with ^{131}I* Initial control with antithyroid drug—1 to 2 weeks gap—radioiodine dosing—resume antithyroid drug after 5–7 days and gradually withdraw over 3 months as the response to ^{131}I develops. This approach is preferred in older patients who are to be treated with ^{131}I , but require prompt control of severe hyperthyroidism. This will also prevent initial hyperthyroidism following ^{131}I due to release of stored T_4 .

Advantages of antithyroid drugs over surgery / ^{131}I are:

- (a) No surgical risk, scar or chances of injury to parathyroids or recurrent laryngeal nerve.
- (b) Hypothyroidism, if induced, is reversible.
- (c) Can be used even in children and young adults.

Disadvantages are:

- (a) Prolonged (often life long) treatment is needed because relapse rate is high.
- (b) Not practicable in uncooperative/unintelligent patient.
- (c) Drug toxicity.

During pregnancy thyroidectomy and ^{131}I are contraindicated. With antithyroid drugs risk of foetal hypothyroidism and goiter is there. However, low doses of propylthiouracil are preferred: its greater protein binding allows less transfer to the foetus. For the same reason it is to be

preferred in the nursing mother. However, some reports of safety of methimazole during pregnancy have appeared.

Propylthiouracil is also used in thyroid storm (*see p. 253*).

IONIC INHIBITORS

Certain monovalent anions inhibit iodide trapping by the thyroid probably because of similar hydrated ionic size— T_4/T_3 cannot be synthesized. Thiocyanate also inhibits iodination at high doses. Their relative inhibitory potency is—

SCN 1: CLO₄ 10: NO₃ 1/30

They are toxic and not used now.

Thiocyanates: can cause liver, kidney, bone marrow and brain toxicity.

Perchlorates: produce rashes, fever, aplastic anaemia, agranulocytosis.

Nitrates: are weak drugs, can induce methemoglobinaemia and vascular effects.

IODINE AND IODIDES

Though iodine is a constituent of thyroid hormones, it is the fastest acting thyroid inhibitor. It is reduced in the intestines to iodide and the response to iodine or iodides is identical. The gland, if enlarged, shrinks, becomes firm and less vascular. The thyroid status starts returning to normal at a rate commensurate with complete stoppage of hormone release from the gland. The gland itself involutes and colloid is restored. With daily administration, peak effects are seen in 10–15 days, after which 'thyroid escape' occurs and thyrotoxicosis may return with greater vengeance. Worsening of hyperthyroidism especially occurs in multinodular goiter.

All facets of thyroid function seem to be affected, but the most important action is inhibition of hormone release—'thyroid constipation'. Endocytosis of colloid and proteolysis of thyroglobulin comes to a halt. The mechanism of action is not clear. It appears to be a direct action on thyroid cells, though attenuation of TSH and cAMP induced thyroid stimulation has been demonstrated. Excess iodide inhibits its own transport in thyroid cells and may alter the redox potential of cells, thus interfering with

iodination → reduced T_3/T_4 synthesis (Wolff-Chaikoff effect).

Preparations and dose Lugol's solution (5% iodine in 10% Pot. iodide solution): **LUGOL'S SOLUTION, COLLOID IODINE 10%: 5–10 drops/day. COLLOSOL 8 mg iodine/5 ml liq.**

Iodide (Sod./Pot.) 100–300 mg/day (therapeutic), 5–10 mg/day (prophylactic) for endemic goiter.

Uses

1. **Preoperative preparation** for thyroidectomy: generally given for 10 days just preceding surgery. The aim is to make the gland firm, less vascular and easier to operate on. Though iodide itself will lower the thyroid status, it cannot be relied upon to attain euthyroidism which is done by use of carbimazole before starting iodide. Propranolol may be given additionally for rapid control of symptoms.

2. **Thyroid storm** Lugol's iodine (6–10 drops) or iodine containing radiocontrast media (iopanoic acid/ipodate) orally are used to stop any further release of T_3/T_4 from the thyroid and to decrease T_4 to T_3 conversion.

3. **Prophylaxis of endemic goiter** It is generally used as "iodized salt".

4. **Antiseptic** As tincture iodine, etc. *see* Ch. 65.

Adverse effects

1. **Acute reaction** It occurs in sensitive individuals only—swelling of lips, eyelids, angioedema of larynx (may be dangerous), fever, joint pain, petechial haemorrhages, thrombocytopenia, lymphadenopathy.

2. **Chronic overdose (iodism)** Inflammation of mucous membranes, salivation, rhinorrhoea, sneezing, lacrimation, swelling of eyelids, burning sensation in mouth, headache, rashes, g.i. symptoms, etc. The symptoms regress on stopping iodide ingestion.

Long-term use of high doses can cause hypothyroidism and goiter.

Iodide may cause flaring of acne in adolescents. Given to pregnant or nursing mothers, it

may be responsible for foetal/infantile goiter and hypothyroidism.

RADIOACTIVE IODINE

The stable isotope of iodine is ^{127}I . Its radioactive isotopes of medicinal importance are:

^{131}I : physical half-life is 8 days—most commonly used in medicine.

^{123}I : physical half-life is 13 hours—only rarely used diagnostically.

^{125}I : physical half-life is 60 days.

Their chemical behaviour is similar to the stable isotope.

^{131}I emits X-rays as well as β particles. The former are useful in tracer studies, as they traverse the tissues and can be monitored by a counter, while the latter are utilized for their destructive effect on thyroid cells. ^{131}I is concentrated by thyroid, incorporated in colloid—emits radiation from within the follicles. The β particles penetrate only 0.5–2 mm of tissue. The thyroid follicular cells are affected from within, undergo pyknosis and necrosis followed by fibrosis when a sufficiently large dose has been administered, without damage to neighbouring tissues. With carefully selected doses, it is possible to achieve partial ablation of thyroid.

It is used as sodium salt of ^{131}I dissolved in water and taken orally.

Diagnostic 25–100 μ curie is given; counting or scanning is done at intervals. No damage to thyroid cells occurs at this dose.

Therapeutic The most common indication is *hyperthyroidism* due to Graves' disease or toxic nodular goiter. The average therapeutic dose is 3–6 m curie—calculated on the basis of previous tracer studies and thyroid size. Higher doses are generally required for toxic multinodular goiter than for Graves' disease. The response is slow—starts after 2 weeks and gradually increases, reaching peak at 3 months or so. Thyroid status is evaluated after 3 months, and a repeat dose, if needed, is given. About 20–40% patients require one or more repeat doses.

Advantages

1. Treatment with ^{131}I is simple, conveniently given on outpatient basis and inexpensive.
2. No surgical risk, scar or injury to parathyroids/recurrent laryngeal nerves.
3. Once hyperthyroidism is controlled, cure is permanent.

Disadvantages

1. Hypothyroidism: About 5–10% patients of Graves' disease treated with ^{131}I become hypothyroid every year (upto 50% or more patients may ultimately require supplemental thyroxine treatment). This probably reflects the natural history of Graves' disease, because only few patients of toxic nodular goiter treated with ^{131}I develop hypothyroidism. Moreover, eventual hypothyroidism is a complication of subtotal thyroidectomy/prolonged carbimazole therapy as well.
2. Long latent period of response.
3. Contraindicated during pregnancy—foetal thyroid will also be destroyed resulting in cretinism, other abnormalities if given during first trimester.
4. Not suitable for young patients: they are more likely to develop hypothyroidism later and would then require life-long T_4 treatment. Genetic damage/cancer is also feared, though there is no evidence for it.

^{131}I is the treatment of choice after 25 years of age and if CHF, angina or any other contraindication to surgery is present.

Metastatic carcinoma of thyroid (especially papillary or those cases of follicular which concentrate iodine), ^{131}I may be used as palliative therapy after thyroidectomy. Much higher doses are required and prior stimulation with TSH is recommended.

β ADRENERGIC BLOCKERS

Propranolol (and other nonselective β blockers) have emerged as an important form of therapy to rapidly alleviate manifestations of thyrotoxicosis that are due to sympathetic overactivity: palpitation, tremor, nervousness, severe myopathy, sweating. They have little effect on thyroid function and the hypermetabolic state. They are used in hyperthyroidism in the following situations.

(i) While awaiting response to carbimazole or ^{131}I .

(ii) Along with iodide for preoperative preparation before subtotal thyroidectomy.

(iii) *Thyroid storm (thyrotoxic crisis)*: It is an emergency due to decompensated hyperthyroidism. Vigorous treatment with the following is indicated:

- Nonselective β blockers are the most valuable measure: afford dramatic symptomatic relief. In addition, they reduce peripheral conversion of T_4 to T_3 . Propranolol 1–2 mg slow i.v. may be followed by 40–80 mg oral every 6 hours.
- Propylthiouracil 200–300 mg oral 6 hourly: reduces hormone synthesis as well as peripheral T_4 to T_3 conversion.
- Iopanoic acid (0.5–1 g OD oral) or ipodate are iodine containing radiocontrast media. They are potent inhibitors of thyroid hormone release from thyroid, as well as of peripheral T_4 to T_3 conversion.
- Corticosteroids (hydrocortisone 100 mg i.v. 8 hourly followed by oral prednisolone): help to tide over crisis, cover any adrenal insufficiency and inhibit conversion of T_4 to T_3 in periphery.
- Diltiazem 60–120 mg BD oral may be added if tachycardia is not controlled by propranolol alone.
- Rehydration, anxiolytics, external cooling and appropriate antibiotics are the other measures.

CHAPTER 19

Insulin, Oral Hypoglycaemic Drugs and Glucagon

Diabetes mellitus (DM) It is a metabolic disorder characterized by hyperglycaemia, glycosuria, hyperlipaemia, negative nitrogen balance and sometimes ketonaemia. A widespread pathological change is thickening of capillary basement membrane, increase in vessel wall matrix and cellular proliferation resulting in vascular complications like lumen narrowing, early atherosclerosis, sclerosis of glomerular capillaries, retinopathy, neuropathy and peripheral vascular insufficiency.

Enhanced nonenzymatic glycosylation of tissue proteins due to persistent exposure to high glucose concentrations and the accumulation of larger quantities of sorbitol (a reduced product of glucose) in tissues are believed to be causative in the pathological changes of diabetes. The concentration of glycosylated haemoglobin

(HbA_{1c}) is taken as an index of protein glycosylation: it reflects the state of glycaemia over the preceding 2–3 months.

Two major types of diabetes mellitus are:

Type 1 Insulin-dependent diabetes mellitus (IDDM), juvenile onset diabetes mellitus:

There is β cell destruction in pancreatic islets; majority of cases are autoimmune (type 1A) antibodies that destroy β cells are detectable in blood, but some are idiopathic (type 1B)—no β cell antibody is found. In all type 1 cases circulating insulin levels are low or very low, and patients are more prone to ketosis. This type is less common and has a low degree of genetic predisposition.

Approaches to drug therapy in type 2 DM

Improve insulin availability

Exogenous insulin
Sulfonylureas
Meglitinide/phenylalanine analogues

Major limitations

Hypoglycaemic episodes
Weight gain
Concern about premature atherosclerosis due to hyperinsulinaemia

Overcome insulin resistance

Biguanides
Thiazolidinediones
 α glucosidase inhibitors

Major limitations

Inability to achieve normoglycaemia by themselves in many patients, especially moderate-to-severe cases

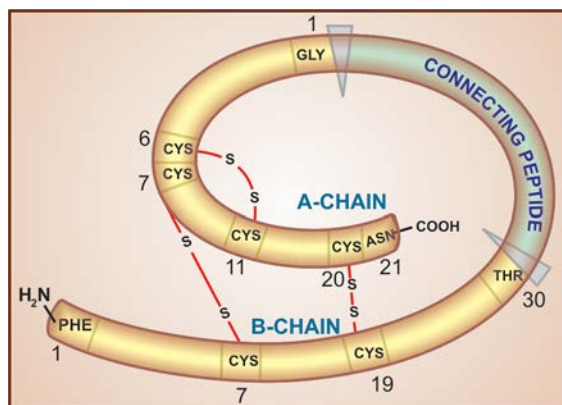

Fig. 19.1: Human proinsulin; simplified structure depicting the main features. The connecting peptide, having 35 amino acids, is split off leaving insulin molecule with two chains joined by two disulfide bridges

Type II Noninsulin-dependent diabetes mellitus (NIDDM), maturity onset diabetes mellitus:

There is no loss or moderate reduction in β cell mass; insulin in circulation is low, normal or even high, no anti- β -cell antibody is demonstrable; has a high degree of genetic predisposition; generally has a late onset (past middle age). Over 90% cases are type 2 DM. Causes may be:

- Abnormality in gluco-receptor of β cells so that they respond at higher glucose concentration or relative β cell deficiency.
- Reduced sensitivity of peripheral tissues to insulin: reduction in number of insulin receptors, 'down regulation' of insulin receptors. Many hypertensives are hyperinsulinaemic, but normoglycaemic; exhibit insulin resistance associated with dyslipidaemia (metabolic syndrome). Hyperinsulinaemia *per se* has been implicated in causing angiopathy.
- Excess of hyperglycaemic hormones (glucagon, etc.)/obesity: cause relative insulin deficiency—the β cells lag behind.

INSULIN

Insulin was discovered in 1921 by Banting and Best who demonstrated the hypoglycaemic action of an extract of pancreas prepared after degeneration of the exocrine part due to ligation of

pancreatic duct. It was first obtained in pure crystalline form in 1926 and the chemical structure was fully worked out in 1956 by Sanger. Insulin is a two chain polypeptide having 51 amino acids and MW about 6000. The A-chain has 21 while B-chain has 30 amino acids. There are minor differences between human, pork and beef insulins:

Species	A-chain		B-chain
	8th AA	10th AA	30th AA
Human	THR	ILEU	THR
Pork	THR	ILEU	ALA
Beef	ALA	VAL	ALA

Thus, pork insulin is more homologous to human insulin than is beef insulin. The A and B chains are held together by two disulfide bonds.

Insulin is synthesized in the β cells of pancreatic islets as a single chain peptide *Preproinsulin* (110 AA) from which 24 AAs are first removed to produce *Proinsulin* (Fig. 19.1). The connecting or 'C' peptide (35 AA) is split off by proteolysis in Golgi apparatus; both insulin and C peptide are stored in granules within the cell. The C peptide is secreted in the blood along with insulin.

Assay Insulin is bioassayed by measuring blood sugar depression in rabbits (1 U reduces blood glucose of a fasting rabbit to 45 mg/dl) or by its potency to induce hypoglycaemic convulsions in mice. 1 mg of the International Standard of insulin = 28 units. With the availability of pure preparations, it can now be assayed chemically also. Plasma insulin can be measured by radioimmunoassay or enzyme immunoassay.

Regulation of insulin secretion

Under basal condition ~1U insulin is secreted per hour by human pancreas. Much larger quantity is secreted after every meal. Secretion of insulin from β cells is regulated by chemical, hormonal and neural mechanisms.

Chemical The β cells have a glucose sensing mechanism dependent on entry of glucose into

β cells (through the aegis of a glucose transporter GLUT2) and its phosphorylation by *glucokinase*. Glucose entry and activation of the glucoceptor indirectly inhibits the ATP-sensitive K^+ channel resulting in partial depolarization of the β cells. This increases intracellular Ca^{2+} availability (due to increased influx, decreased efflux and release from intracellular stores) \rightarrow exocytotic release of insulin storing granules. Other nutrients that can evoke insulin release are—amino acids, fatty acids and ketone bodies, but glucose is the principal regulator and it stimulates synthesis of insulin as well. Glucose induces a brief pulse of insulin output within 2 min (*first phase*) followed by a delayed but more sustained *second phase* of insulin release.

Glucose and other nutrients are more effective in invoking insulin release when given orally than i.v. They generate chemical signals '*incretins*' from the gut which act on β cells in the pancreas to cause anticipatory release of insulin. The incretins involved are glucagon-like peptide-1 (GLP-1), glucose-dependent insulinotropic polypeptide (GIP), vasoactive intestinal peptide (VIP), pancreatico-zymin-cholecystokinin, etc.; but different incretin may mediate signal from different nutrient. Glucagon and some of these peptides enhance insulin release by increasing cAMP formation in the β cells.

Hormonal A number of hormones, e.g. growth hormone, corticosteroids, thyroxine modify insulin release in response to glucose. PGE has been shown to inhibit insulin release. More important are the intra-islet paracrine interactions between the hormones produced by different types of islet cells. The β cells constitute the core of the islets and are the most abundant cell type. The α cells, comprising 25% of the islet cell mass, surround the core and secrete glucagon. The D cells (5–10%) elaborating somatostatin are interspersed between the α cells. There are some PP (or F) cells (pancreatic polypeptide containing) also.

- Somatostatin inhibits release of both insulin and glucagon.
- Glucagon evokes release of insulin as well as somatostatin.
- Insulin inhibits glucagon secretion.

The three hormones released from closely situated cells influence each other's secretion and

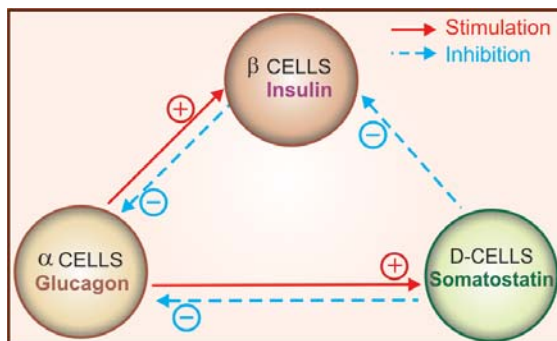

Fig. 19.2: Paracrine modulation of hormone secretion within the pancreatic islets of Langerhans

appear to provide fine tuning of their output in response to metabolic needs (Fig. 19.2).

Neural The islets are richly supplied by sympathetic and vagal nerves.

- Adrenergic α_2 receptor activation decreases insulin release (predominant) by inhibiting β cell adenylyl cyclase.
- Adrenergic β_2 stimulation increases insulin release (less prominent) by stimulating β cell adenylyl cyclase.
- Cholinergic—muscarinic activation by ACh or vagal stimulation causes insulin secretion through IP_3 /DAG-increased intracellular Ca^{2+} in the β cells.

These neural influences appear to govern both basal as well as evoked insulin secretion, because the respective blocking agents have effects opposite to that mentioned above. The primary central site of regulation of insulin secretion is in the hypothalamus: stimulation of ventrolateral nuclei evokes insulin release, whereas stimulation of ventromedial nuclei has the opposite effect.

ACTIONS OF INSULIN

The overall effects of insulin are to favour storage of fuel. The actions of insulin and the results of its deficiency can be summarized as:

1. Insulin facilitates glucose transport across cell membrane; skeletal muscle and fat are highly sensitive. The availability of glucose intracellu-

larly is the limiting factor for its utilization in these and some other tissues. However, glucose entry in liver, brain, RBC, WBC and renal medullary cells is largely independent of insulin. Ketoacidosis interferes with glucose utilization by brain → diabetic coma. Muscular activity induces glucose entry in muscle cells without the need for insulin. As such, exercise has insulin sparing effect.

The intracellular pool of vesicles containing glucose transporter glycoproteins GLUT4 (insulin activated) and GLUT1 is in dynamic equilibrium with the GLUT vesicles inserted into the membrane. This equilibrium is regulated by insulin to favour translocation to the membrane. Moreover, on a long-term basis, synthesis of GLUT4 is upregulated by insulin.

2. The first step in intracellular utilization of glucose is its phosphorylation to form glucose-6-phosphate. This is enhanced by insulin through increased production of glucokinase. Insulin facilitates glycogen synthesis from glucose in liver, muscle and fat by stimulating the enzyme glycogen synthase. It also inhibits phosphorylase → decreased glycogenolysis in liver.

3. Insulin inhibits gluconeogenesis (from protein, FFA and glycerol) in liver by gene mediated decreased synthesis of phosphoenol pyruvate carboxykinase. In insulin deficiency, proteins and amino acids are funneled from peripheral tissues to liver where these are converted to carbohydrate and urea. Thus, in diabetes there is underutilization and over production of glucose → hyperglycaemia → glycosuria.

4. Insulin inhibits lipolysis in adipose tissue and favours triglyceride synthesis. In diabetes increased amount of fat is broken down due to unchecked action of lipolytic hormones (glucagon, Adr, thyroxine, etc.) → increased FFA and glycerol in blood → taken up by liver to produce acetyl-CoA. Normally acetyl-CoA is resynthesized to fatty acids and triglycerides, but this process is reduced in diabetics and acetyl CoA is diverted to produce ketone bodies (acetone, acetoacetate, β -hydroxy-butyrate). The ketone bodies are released in blood—partly used up by muscle and heart as energy source, but when their capacity is exceeded, ketonaemia and ketonuria result.

5. Insulin enhances transcription of vascular endothelial lipoprotein lipase and thus increases clearance of VLDL and chylomicrons.

6. Insulin facilitates AA entry and their synthesis into proteins, as well as inhibits protein breakdown in muscle and most other cells. Insulin deficiency leads to protein breakdown → AAs are released in blood → taken up by liver and converted to pyruvate, glucose and urea. The excess urea produced is excreted in urine resulting in negative nitrogen balance. Thus, catabolism takes the upper hand over anabolism in the diabetic state.

Most of the above metabolic actions of insulin are exerted within seconds or minutes and are called the *rapid actions*. Others involving DNA mediated synthesis of glucose transporter and some enzymes of amino acid metabolism have a

Actions of insulin producing hypoglycaemia

Liver	Muscle	Adipose tissue
<ul style="list-style-type: none"> ▲ Increases glucose uptake and glycogen synthesis ▲ Inhibits glycogenolysis and glucose output ▲ Inhibits gluconeogenesis from protein, pyruvate, FFA and glycerol 	<ul style="list-style-type: none"> ▲ Increases glucose uptake and utilization ▲ Inhibits proteolysis and release of amino acids, pyruvate, lactate into blood which form substrate for gluconeogenesis in liver 	<ul style="list-style-type: none"> ▲ Increases glucose uptake and storage as fat and glycogen ▲ Inhibits lipolysis and release of FFA + glycerol which form substrate for gluconeogenesis in liver

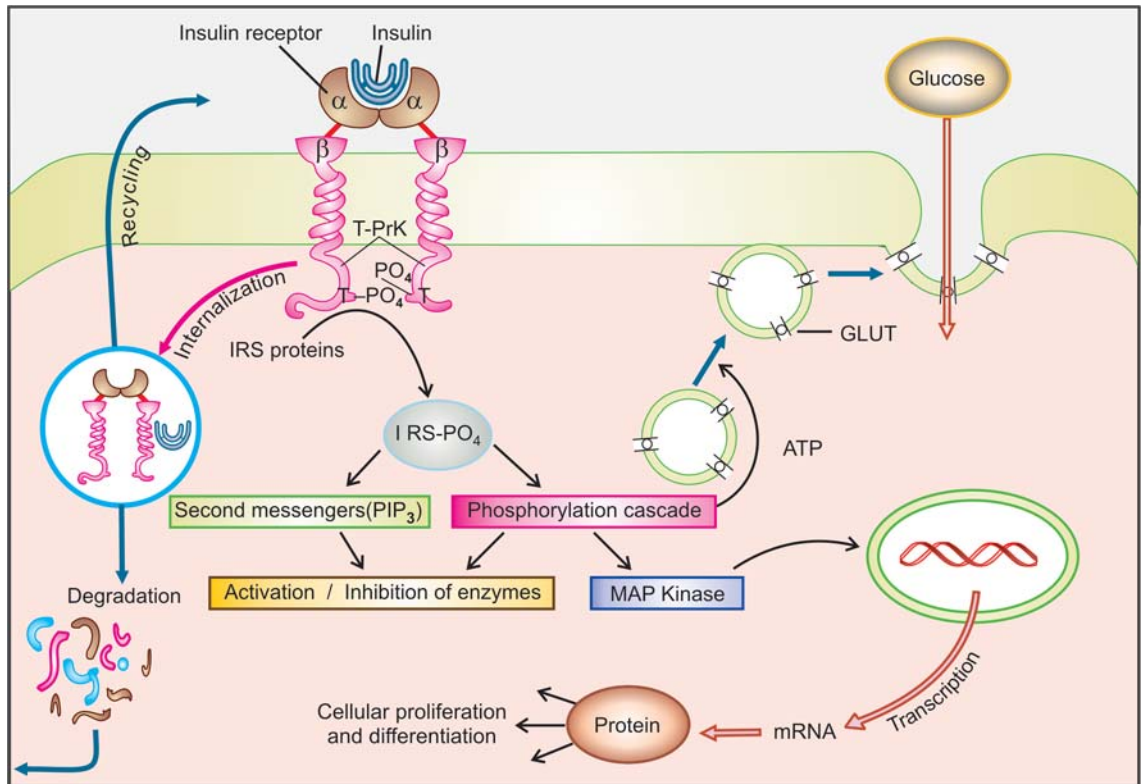

Fig. 19.3: A model of insulin receptor and mediation of its metabolic and cellular actions; T—Tyrosine residue; GLUT—Glucose transporter; IRS—Insulin receptor substrate proteins; PIP₃—Phosphatidyl inositol trisphosphate; MAP-kinase—Mitogen activated protein kinase; T-PrK—Tyrosine protein kinase

latency of few hours—the *intermediate* actions. In addition insulin exerts major *long-term* effects on multiplication and differentiation of cells.

Mechanism of action Insulin acts on specific receptors located on the cell membrane of practically every cell, but their density depends on the cell type: liver and fat cells are very rich. The insulin receptor is a heterotetrameric glycoprotein consisting of 2 extracellular α and 2 transmembrane β subunits linked together by disulfide bonds. It is oriented across the cell membrane as a heterodimer (Fig. 19.3). The α subunits carry insulin binding sites, while the β subunits have tyrosine protein kinase activity.

Binding of insulin to α subunits induces aggregation and internalization of the receptor along with the bound insulin molecules. This activates tyrosine kinase activity of the β subunits \rightarrow pairs of β subunits phosphorylate tyrosine residues on each other \rightarrow expose the catalytic site to phosphorylate tyrosine residues of Insulin Receptor Substrate proteins (IRS1, IRS2, etc). In turn, a cascade of

phosphorylation and dephosphorylation reactions is set into motion resulting in stimulation or inhibition of enzymes involved in the rapid metabolic actions of insulin.

Certain second messengers like phosphatidyl inositol trisphosphate (PIP₃) which are generated through activation of a specific PI₃-kinase also mediate the action of insulin on metabolic enzymes.

Insulin stimulates glucose transport across cell membrane by ATP dependent translocation of glucose transporter GLUT4 and GLUT1 to the plasma membrane as well as by increasing its activity. Over a period of time it also promotes expression of the genes directing synthesis of GLUT4. Genes for a large number of enzymes and carriers have been shown to be regulated by insulin primarily through MAP kinases. Activation of transcription factors also promotes proliferation and differentiation of specific cells.

The internalized receptor-insulin complex is either degraded intracellularly or returned back to the surface from where the insulin is released extracellularly. The relative preponderance of these two processes differs

Table 19.1: Types of insulin preparations and insulin analogues

Type	Appearance	Onset (hr)	Peak (hr)	Duration (hr)	Can be mixed with
<i>Rapid acting</i>					
Insulin lispro	Clear	0.2–0.4	1–2	3–5	Regular, NPH
Insulin aspart	Clear	0.2–0.4	1–1.5	3–5	Regular, NPH
Insulin glulisine	Clear	0.3–0.5	1–2	2–4	Regular, NPH
<i>Short acting</i>					
Regular (soluble) insulin	Clear	0.5–1	2–4	6–8	All preparations (except insulin glargine)
<i>Intermediate acting</i>					
Insulin zinc suspension or Lente*	Cloudy	1–2	8–10	20–24	Regular
Neutral protamine hagedorn (NPH) or isophane insulin	Cloudy	1–2	8–10	20–24	Regular
<i>Long acting</i>					
Protamine zinc insulin (PZI)	Cloudy	4–6	14–20	24–36	Regular
Insulin glargine	Clear	2–4	5–12	24	None

* Lente insulin is a 7:3 mixture of ultralente (crystalline) and semilente (amorphous) insulin zinc suspension. Ultralente (long-acting) and semilente (short-acting) are not separately marketed in India.

among different tissues: maximum degradation occurs in liver, least in vascular endothelium.

Fate of insulin Insulin is distributed only extracellularly. It is a peptide; gets degraded in the g.i.t. if given orally. Injected insulin or that released from pancreas is metabolized primarily in liver and to a smaller extent in kidney and muscles. Nearly half of the insulin entering portal vein from pancreas is inactivated in the first passage through liver. Thus, normally liver is exposed to a much higher concentration (4–8 fold) of insulin than are other tissues. As noted above, degradation of insulin after receptor mediated internalization occurs to variable extents in most target cells. During biotransformation the disulfide bonds are reduced—A and B chains are separated. These are further broken down to the constituent amino acids. The plasma $t_{1/2}$ is 5–9 min.

Conventional preparations of insulin

The conventional commercial preparations are produced from beef and pork pancreas. They contain ~1% (10,000 ppm) of other proteins (pro-insulin, other polypeptides, pancreatic proteins,

insulin derivatives, etc.) which are potentially antigenic. In the developed countries, these have been totally replaced by highly purified pork insulins/recombinant human insulins/insulin analogues. However, because of low cost, conventional preparations are still used in India and many developing countries. The types of insulin preparations are tabulated in Table 19.1.

Regular (soluble) insulin: It is a buffered solution of unmodified insulin stabilized by a small amount of zinc. At the concentration of the injectable solution, the insulin molecules self aggregate to form hexamers around zinc ions. After s.c. injection, insulin monomers are released gradually by dilution, so that absorption occurs slowly. Peak action is produced only after 2–4 hours and action continues upto 6–8 hours. The absorption pattern is also affected by dose; higher doses act longer. When injected s.c. just before a meal, this pattern often creates a mismatch between need and availability of insulin to result in early postprandial hyperglycaemia and late postprandial hypoglycaemia. Regular insulin injected s.c. is also not suitable for providing a low constant basal level of action in the interdigestive period.

To overcome the above problems, some long-acting 'modified' or 'retard' preparations of insulin were soon developed. Recently, both rapidly acting as well as peakless and long-acting insulin analogues have become available. However, after i.v. injection, the hexameric regular insulin dissociates rapidly to produce prompt action.

For obtaining retard preparations, insulin is rendered insoluble either by complexing it with protamine (a small molecular basic protein) or by precipitating it with excess zinc and increasing the particle size.

Lente insulin (Insulin-zinc suspension): Two types of insulin-zinc suspensions have been produced. The one with large particles is crystalline and practically insoluble in water (ultralente or 'extended insulin zinc suspension'). It is long-acting. The other has smaller particles and is amorphous (semilente or 'prompt insulin zinc suspension'), is short-acting. Their 7:3 ratio mixture is called 'Lente insulin' and is intermediate-acting.

Isophane (Neutral Protamine Hagedorn or NPH) insulin: Protamine is added in a quantity just sufficient to complex all insulin molecules; neither of the two is present in free form and pH is neutral. On s.c. injection, the complex dissociates slowly to yield an intermediate duration of action.

Protamine zinc insulin (PZI): It contains excess of protamine, so that the complexed insulin is released more slowly at the site of s.c. injection and a long-acting preparation results. It is rarely used now.

1. Regular insulin: SOLUBLE INSULIN 40 U/ml, 100 U/ml, for s.c. or i.v. injection.
2. Lente insulin (insulin zinc suspension) 7:3: LENTE INSULIN 40 U/ml for s.c. inj.
3. Neutral protamine Hagedorn (NPH) insulin: ISOPHANE (NPH) INSULIN 40 U/ml for s.c. inj.
4. Protamine zinc insulin: PROTAMINE ZINC INSULIN 40 U/ml for s.c. inj.

Highly purified insulin preparations

In the 1970s improved purification techniques were applied to produce highly purified and

practically nonantigenic insulins. Pork insulin, being more homologous to human insulin, is less immunogenic and is used. Gel filtration reduces proinsulin content to 50–200 ppm, but pancreatic peptides and insulin derivatives remain; the preparation is called 'single peak insulin'. It still has significant immunogenicity. Further purification by ion-exchange chromatography removes most contaminants and reduces proinsulin to <10 ppm. These preparations are termed 'Highly purified' or 'Monocomponent (MC) insulins'. Immunogenicity of pork MC insulins is similar to that of human insulins. Moreover, MC insulins are more stable, cause less insulin resistance or injection site lipodystrophy.

1. Highly purified (monocomponent) pork regular insulin: ACTRAPID MC, RAPIDICA 40 U/ml inj.
2. Highly purified (MC) pork lente insulin: LENTARD, MONOTARD MC, LENTINSULIN-HPI, ZINULIN 40 U/ml
3. Highly purified (MC) pork isophane (NPH) insulin: INSULATARD 40 U/ml inj.
4. Mixture of highly purified pork regular insulin (30%) and isophane insulin (70%): RAPIMIX, MIXTARD 40 U/ml inj.

Human insulins In the 1980s, the human insulins (having the same amino acid sequence as human insulin) were produced by recombinant DNA technology in *Escherichia coli*—'proinsulin recombinant bacterial' (prb) and in yeast—'precursor yeast recombinant' (pyr), or by 'enzymatic modification of porcine insulin (emp).

1. HUMAN ACTRAPID: Human regular insulin; 40 U/ml, 100 U/ml, ACTRAPID HM PENFIL 100 U/ml pen inj., WOSULIN-R 40 U/ml inj vial and 100 U/ml pen injector cartridge.
2. HUMAN MONOTRAD: Human lente insulin; 40 U/ml, 100 U/ml.
3. HUMAN INSULATARD, HUMINSULIN-N: Human isophane insulin 40 U/ml. WOSULIN-N 40 U/ml inj. vial and 100 U/ml pen injector cartridge.
4. HUMAN ACTRAPHANE, HUMINSULIN 30/70, HUMAN MIXTARD: Human soluble insulin (30%) and isophane insulin (70%), 40 U/ml. WOSULIN 30/70: 40 U/ml vial and 100 U/ml cartridge.
5. ACTRAPHANE HM PENFIL: Human soluble insulin 30% + isophane insulin 70% 100 U/ml pen injector.
6. INSUMAN 50/50: Human soluble insulin 50% + isophane insulin 50% 40 U/ml inj; WOSULIN 50/50 40 U/ml vial, 100 U/ml cartridge.

In the USA and Europe the use of human insulins has rapidly overtaken that of purified animal insulins: in Britain now > 90% diabetics who use insulin are taking human insulins or insulin analogues. Human insulin is more water soluble as well as hydrophobic than porcine or bovine insulin. It has a slightly more rapid s.c. absorption, earlier and more defined peak and slightly shorter duration of action.

The allegation that human insulin produces more *hypoglycaemic unawareness* has not been substantiated. However, after prolonged treatment, irrespective of the type of insulin, many diabetics develop relative hypoglycaemic unawareness/change in symptoms, because of autonomic neuropathy, changes in perception/attitude and other factors. The cost of human insulin now is the same as that of pork MC insulin.

Superiority of human insulin over pork MC insulin has not been demonstrated. Though new patients may be started on human insulins, the only indication for transfer from purified pork to human insulin is allergy to pork insulin. It is unwise to transfer stabilized patients from one to another species insulin without good reason.

Though it is desirable to employ human/highly purified pork insulin in all diabetics, in developing countries conventional insulin preparations are still used for economic reasons. Human/highly purified insulins are specially indicated in the following situations:

1. Insulin resistance: especially when due to large amounts of insulin-binding antibodies.
2. Allergy to conventional preparations.
3. Injection site lipodystrophy; changeover causes resolution of the lesions.
4. Short-term use of insulin in diabetics who are otherwise stabilized on diet and exercise with/without oral hypoglycaemics, e.g. to tideover surgery, trauma, infections, ketoacidosis, etc.
5. During pregnancy.

Insulin analogues

Using recombinant DNA technology, analogues of insulin have been produced with modified pharmacokinetics on s.c. injection, but similar pharmacodynamic effects. Greater stability and consistency are the other advantages.

Insulin lispro: Produced by reversing proline and lysine at the carboxy terminus B 28 and B 29 positions, it forms very weak hexamers that dissociate rapidly after s.c. injection resulting in a quick and more defined peak as well as shorter duration of action. Unlike regular insulin, it needs to be injected immediately before or even after the meal, so that dose can be altered according to the quantity of food consumed. A better control of meal-time glycaemia and a lower incidence of late post-prandial hypoglycaemia have been obtained. Using a regimen of 2–3 daily meal-time insulin lispro injections, a slightly greater reduction in HbA_{1c} compared to regular insulin has been reported. Fewer hypoglycaemic episodes occurred.

HUMALOG 100 U/ml inj.

Insulin aspart: The proline at B 28 of human insulin is replaced by aspartic acid. This change reduces the tendency for self-aggregation, and a time-action profile similar to insulin lispro is obtained. It more closely mimics the physiological insulin release pattern after a meal, with the same advantages as above.

NOVOLOG, NOVORAPID 100 U/ml inj.

Insulin glulisine: Another rapidly acting insulin analogue with lysine replacing asparagine at B 23 and glutamic acid replacing lysine at B 29. Properties and advantages are similar to insulin lispro.

Insulin glargine: This long-acting biosynthetic insulin has 2 additional arginine residues at the carboxy terminus of B chain and glycine replaces asparagine at A 21. It remains soluble at pH4 of the formulation, but precipitates at neutral pH encountered on s.c. injection. A depot is created from which monomeric insulin dissociates slowly to enter the circulation. Onset of action is delayed, but relatively low blood levels of insulin are maintained for upto 24 hours. A smooth 'peakless' effect is obtained. Thus, it is suitable for once daily injection to provide background insulin action. Fasting and interdigestive blood glucose levels are effectively lowered irrespective of time of the day when injected or the site of s.c. injection. Lower incidence of night-time hypoglycaemic episodes compared to isophane

insulin has been reported. However, it does not control meal-time glycaemia, for which a rapid acting insulin or an oral hypoglycaemic is used concurrently. Because of acidic pH, it cannot be mixed with any other insulin preparation; must be injected separately.

LANTUS OPTISET 100 U/ml in 5 ml vial and 3 ml prefilled pen injector.

REACTIONS TO INSULIN

1. Hypoglycaemia This is the most frequent and potentially the most serious reaction. It is commonly seen in patients of 'labile' diabetes in whom insulin requirement fluctuates unpredictably. Hypoglycaemia can occur in any diabetic following inadvertent injection of large doses, by missing a meal or by performing vigorous exercise. The symptoms can be divided into those due to counter-regulatory sympathetic stimulation—sweating, anxiety, palpitation, tremor; and those due to deprivation of the brain of its essential nutrient glucose (neuroglucopenic symptoms)—dizziness, headache, behavioural changes, visual disturbances, hunger, fatigue, weakness, muscular incoordination and sometimes fall in BP. Generally, the reflex sympathetic symptoms occur before the neuroglucopenic, but the warning symptoms of hypoglycaemia differ from patient to patient and also depend on the rate of fall in blood glucose level. After long-term treatment about 30% patients lose adrenergic symptoms. Diabetic neuropathy can abolish the autonomic symptoms. Hypoglycaemic unawareness tends to develop in patients who experience frequent episodes of hypoglycaemia.

Finally, when blood glucose falls further (to < 40 mg/dl) mental confusion, abnormal behaviour, seizures and coma occur. Irreversible neurological deficits are the sequelae of prolonged hypoglycaemia.

Treatment Glucose must be given orally or i.v. (for severe cases)—reverses the symptoms rapidly. Glucagon 0.5–1 mg i.v. or Adr 0.2 mg s.c. (less desirable) may be given as an expedient measure in patients who are not able to take sugar orally and injectable glucose is not available.

2. Local reactions Swelling, erythema and stinging sometimes occur especially in the beginning. *Lipodystrophy* occurs at injection sites after long usage. This is not seen with newer preparations—which may even facilitate reversal of lipoatrophy when injected at the same sites.

3. Allergy This is infrequent; is due to contaminating proteins; very rare with human/highly purified insulins.

Urticaria, angioedema and anaphylaxis are the manifestations.

4. Edema Some patients develop short-lived dependent edema (due to Na⁺ retention) when insulin therapy is started.

Drug interactions

1. β adrenergic blockers prolong hypoglycaemia by inhibiting compensatory mechanisms operating through β_2 receptors (β_1 selective agents are less liable). Warning signs of hypoglycaemia like palpitation, tremor and anxiety are masked. Rise in BP can occur due to unopposed α action of released Adr.

2. Thiazides, furosemide, corticosteroids, oral contraceptives, salbutamol, nifedipine tend to raise blood sugar and reduce effectiveness of insulin.

3. Acute ingestion of alcohol can precipitate hypoglycaemia by depleting hepatic glycogen.

4. Salicylates, lithium and theophylline may also accentuate hypoglycaemia by enhancing insulin secretion and peripheral glucose utilization.

USES OF INSULIN

Diabetes mellitus The purpose of therapy in diabetes mellitus is to restore metabolism to normal, avoid symptoms due to hyperglycaemia and glucosuria, prevent short-term complications (infection, ketoacidosis, etc.) and long-term sequelae (cardiovascular, retinal, neurological, renal, etc.)

Insulin is effective in all forms of diabetes mellitus and is a must for type 1 cases, as well as for post pancreatectomy diabetes and gestational

diabetes. Many type 2 cases can be controlled by diet, reduction in body weight and appropriate exercise. Insulin is needed by such patients when:

- Not controlled by diet and exercise or when these are not practicable.
- Primary or secondary failure of oral hypoglycaemics or when these drugs are not tolerated.
- Under weight patients.
- Temporarily to tide over infections, trauma, surgery, pregnancy. In the perioperative period and during labour, monitored i.v. insulin infusion is preferable.
- Any complication of diabetes, e.g. ketoacidosis, nonketotic hyperosmolar coma, gangrene of extremities.

When instituted, insulin therapy is generally started with regular insulin given s.c. before each major meal. The requirement is assessed by testing urine or blood glucose levels (glucose oxidase based spot tests and glucometers are available). Most type 1 patients require 0.4–0.8 U/kg/day. In type 2 patients, insulin dose varies (0.2–1.6 U/kg/day) with the severity of diabetes and body weight: obese patients require proportionately higher doses due to relative insulin resistance. A suitable regimen for each patient is then devised by including modified insulin preparations.

Any satisfactory regimen should provide basal control by inhibiting hepatic glucose output, as well as supply extra amount to meet postprandial needs for disposal of absorbed glucose and amino acids. Often mixtures of regular and lente/isophane insulins are used. The total daily dose of a 30:70 mixture of regular and NPH insulin is usually split into two (split-mixed regimen) and injected s.c. before breakfast and before dinner. Several variables *viz.* site and depth of s.c. injection, posture, regional muscular activity, injected volume, type of insulin can alter the rate of absorption of s.c. injected insulin and can create mismatch between the actual requirement (high after meals, low at night) and the attained insulin levels.

Another preferred regimen is to give a long-acting insulin (glargine) once daily either before breakfast or before bed-time for basal coverage along with 2–3 meal-time injections of a rapid acting preparation (insulin lispro or aspart). Such intensive regimens have the objective of achieving round-the-clock euglycaemia. The large multicentric diabetes control and complications trial (DCCT) among type 1 patients has established that

intensive insulin therapy markedly reduces the occurrence of primary diabetic retinopathy, neuropathy, nephropathy and slows progression of these complications in those who already have them in comparison to conventional regimens which attain only intermittent euglycaemia. Thus, the risk of macrovascular disease appears to be related to the glycaemia control. The UK prospective diabetes study (UK PDS, 1998) has extended these observations to type 2 DM patients as well. Since the basis of pathological changes in both type 1 and type 2 DM is accumulation of glycosylated proteins and sorbitol in tissues as a result of exposure to high glucose concentrations, tight glycaemia control can delay end-organ damage in all diabetic subjects.

However, regimens attempting near normoglycaemia are associated with higher incidence of severe hypoglycaemic episodes. Moreover, injected insulin fails to reproduce the normal pattern of increased insulin secretion in response to each meal, and liver is exposed to the same concentration of insulin as other tissues while normally liver receives much higher concentration. As such, the overall desirability and practicability of intensive insulin therapy has to be determined in individual patients. Intensive insulin therapy is best avoided in young children (risk of hypoglycaemic brain damage) and in the elderly (more prone to hypoglycaemia and its serious consequences).

Diabetic ketoacidosis (Diabetic coma) Ketoacidosis of different grades generally occurs in insulin dependent diabetics. It is infrequent in type 2 DM. The most common precipitating cause is infection; others are trauma, stroke, pancreatitis, stressful conditions and inadequate doses of insulin.

The development of cardinal features of diabetic ketoacidosis is outlined in Fig. 19.4. Patients may present with varying severity. Typically they are dehydrated, hyperventilating and have impaired consciousness. The principles of treatment remain the same, irrespective of severity, only the vigour with which therapy is instituted is varied.

1. Insulin Regular insulin is used to rapidly correct the metabolic abnormalities. A bolus dose of 0.1–0.2 U/kg i.v. is followed by 0.1 U/kg/hr infusion; the rate is doubled if no significant fall in blood glucose occurs in 2 hr. Fall in blood glucose level by 10% per hour can be considered adequate response.

Usually, within 4–6 hours blood glucose reaches 300 mg/dl. Then the rate of infusion is

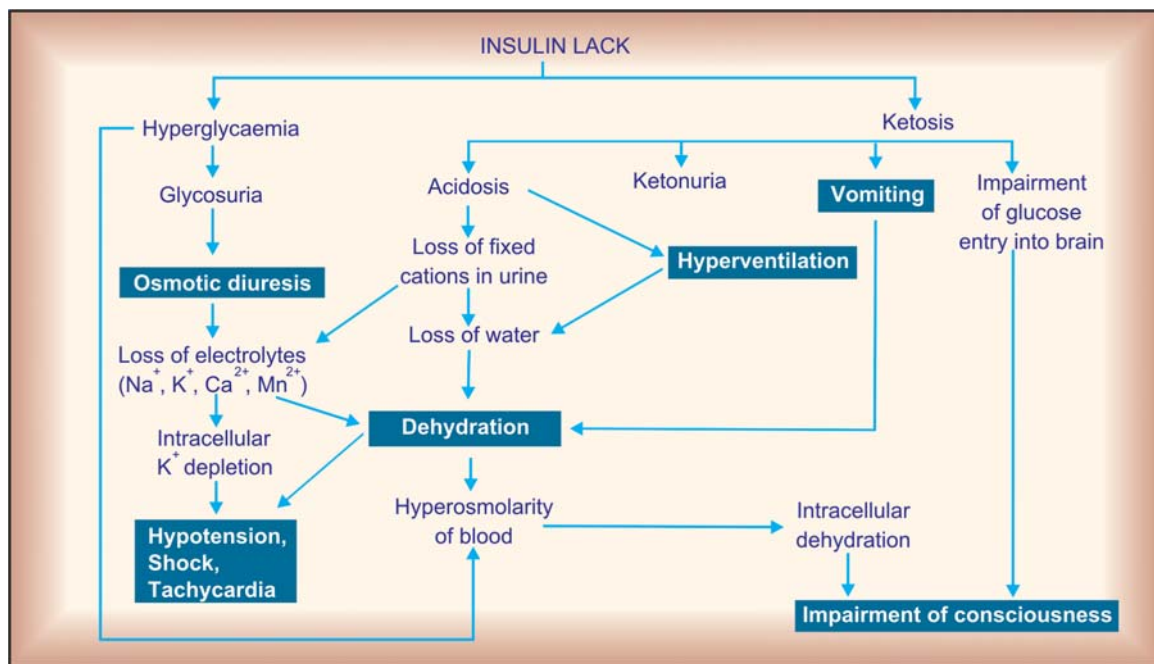

Fig. 19.4: Schematic depiction of the development of diabetic ketoacidosis due to insulin lack. Symptoms produced are shown within boxes

reduced to 2–3 U/hr. This is maintained till the patient becomes fully conscious and routine therapy with s.c. insulin is instituted.

2. Intravenous fluids It is vital to correct dehydration. Normal saline is infused i.v., initially at the rate of 1 L/hr, reducing progressively to 0.5 L/4 hours depending on the volume status. Once BP and heart rate have stabilized and adequate renal perfusion is assured change over to $\frac{1}{2}$ N saline. After the blood sugar has reached 300 mg/dl, 5% glucose in $\frac{1}{2}$ N saline is the most appropriate solution because blood glucose falls before ketones are fully cleared from the circulation. Also glucose is needed to restore the depleted hepatic glycogen.

3. KCl Though upto 400 mEq of K^+ may be lost in urine during ketoacidosis, serum K^+ is usually normal due to exchange with intracellular stores. When insulin therapy is instituted ketosis subsides and K^+ is driven intracellularly—dangerous hypokalemia can occur. After 4 hours

it is appropriate to add 10–20 mEq/hr KCl to the i.v. fluid. Further rate of infusion is guided by serum K^+ measurements and ECG.

4. Sodium bicarbonate It is not routinely needed. Acidosis subsides as ketosis is controlled. However, if arterial blood pH is < 7.1 , acidosis is not corrected spontaneously or hyperventilation is exhausting, 50 mEq of sod. bicarbonate is added to the i.v. fluid. Bicarbonate infusion is continued slowly till blood pH rises above 7.2.

5. Phosphate When serum PO_4 is in the low-normal range, 5–10 m mol/hr of sod./pot. phosphate infusion is advocated. However, routine use of PO_4 in all cases is still controversial.

6. Antibiotics and other supportive measures and treatment of precipitating cause must be instituted simultaneously.

Hyperosmolar (nonketotic hyperglycaemic) coma This usually occurs in elderly type 2 cases. Its cause is obscure, but appears to be

precipitated by the same factors as ketoacidosis, especially those resulting in dehydration. Uncontrolled glycosuria of DM produces diuresis resulting in dehydration and haemoconcentration over several days → urine output is finally reduced and glucose accumulates in blood rapidly to > 800 mg/dl, plasma osmolarity is > 350 mOsm/L → coma, and death can occur if not vigorously treated.

The general principles of treatment are the same as for ketoacidotic coma, except that faster fluid replacement is to be instituted and alkali is usually not required. These patients are prone to thrombosis (due to hyperviscosity and sluggish circulation), prophylactic heparin therapy is recommended.

Despite intensive therapy, mortality in hyperosmolar coma remains high. Treatment of precipitating factor and associated illness is vital.

Insulin resistance

When insulin requirement is increased (conventionally > 200 U/day, but physiologically >100 U/day), insulin resistance is said to have developed. However, it may be of different grades.

1. **Acute** It develops rapidly and is usually a short term problem. Causes are—
 - (a) Infection, trauma, surgery, emotional stress; corticosteroids and other hyperglycaemic hormones may be produced in excess as a reaction to the stress → oppose insulin action.
 - (b) Ketoacidosis—ketone bodies and FFA inhibit glucose uptake by brain and muscle. Also insulin binding may increase.

Treatment is to overcome the precipitating cause and to give high doses of regular insulin. The insulin requirement comes back to normal once the condition has been controlled.

2. **Chronic** This is generally seen in patients treated for years with conventional preparations of beef or pork insulins. Antibodies to homologous contaminating proteins are produced which also bind insulin. Very high grades of insulin resistance may be produced in this way. It is more common in type 2 DM.

Development of such insulin resistance is an indication for switching over to the more purified newer preparations. Some patients may be selectively resistant to beef insulin and respond well to pork or human insulin. After instituting highly pure preparations, insulin requirement gradually declines over weeks and months, and majority of patients stabilize at ~ 60 U/day.

Pregnancy and oral contraceptives often induce relatively low grade and reversible insulin resistance. Other rare causes are—acromegaly, Cushing's syndrome, pheochromocytoma, lipotrophic diabetes mellitus. Hypertension is often accompanied with relative insulin resistance as part of metabolic syndrome.

Newer insulin delivery devices A number of innovations have been made to improve ease and accuracy of insulin administration as well as to achieve tight glycaemia control. These are:

1. **Insulin syringes** Prefilled disposable syringes contain specific types or mixtures of regular and modified insulins.
2. **Pen devices** Fountain pen like: use insulin cartridges for s.c. injection through a needle. Preset amounts (in 2 U increments) are propelled by pushing a plunger; convenient in carrying and injecting.
3. **Inhaled insulin** Recently, an inhaled human insulin preparation has been marketed in Europe and the USA. The fine powder is delivered through a nebulizer; absorption is rapid. Peak action occurs at ~2 hours and duration of action is 6–7 hours. It is used to control meal-time glycaemia, but is not suitable for round-the-clock basal effect. Less than 10% of inhaled insulin is absorbed. Pulmonary fibrosis and other complications are apprehended on long-term use.
4. **Insulin pumps** Portable infusion devices connected to a subcutaneously placed cannula: provide 'continuous subcutaneous insulin infusion' (CSII). Only regular insulin is used. They can be programmed to deliver insulin at a low basal rate (approx. 1 U/hr) and premeal boluses (4–15 times the basal rate) to control post-prandial glycaemia. Though, theoretically more appealing, no definite advantage of CSII over multidose s.c. injection has been demonstrated. Moreover, cost, strict adherence to diet, exercise, care of the device and cannula, risk of pump failure, site infection, are too demanding on the patient.
5. **Implantable pumps** Consist of an electromechanical mechanism which regulates insulin delivery from a percutaneously refillable reservoir. Mechanical pumps, fluorocarbon propellant and osmotic pumps are being developed.

6. **External artificial pancreas** This is a microprocessor controlled device connected through i.v. lines, which measures blood glucose and then infuses appropriate amounts of insulin in a continuous feedback manner. Its size, cost and other problems limit use to only research situations.

7. **Other routes of insulin delivery** Intraperitoneal, oral (by complexing insulin into liposomes or coating it with impermeable polymer) and rectal routes are being tried. These have the advantage of providing higher concentrations in the portal circulation, which is more physiological.

ORAL HYPOGLYCAEMIC DRUGS

These drugs lower blood glucose levels and are effective orally. The chief drawback of insulin is—it must be given by injection. Orally active drugs have always been searched.

The early sulfonamides tested in 1940s produced hypoglycaemia as side effect. Taking this lead, the first clinically acceptable sulfonylurea *tolbutamide* was introduced in 1957. Others followed soon after. In the 1970s many so called ‘second generation’ sulfonylureas have been developed which are 20–100 times more potent. Clinically useful biguanide *phenformin* was developed parallel to sulfonylureas in 1957. Recently 3 newer classes of drugs, *viz.* α glucosidase inhibitors, *meglitinide analogues* and *thiazolidinediones* have been inducted.

SULFONYLUREAS

<i>First generation</i>	<i>Second generation</i>
Tolbutamide	Glibenclamide
Chlorpropamide	(Glyburide)
	Glipizide
	Gliclazide
	Glimepiride

BIGUANIDES

Metformin

MEGLITINIDE / PHENYL ALANINE ANALOGUES

Repaglinide	Nateglinide
-------------	-------------

THIAZOLIDINEDIONES

Rosiglitazone	Pioglitazone
---------------	--------------

α GLUCOSIDASE INHIBITORS

Acarbose	Miglitol
----------	----------

SULFONYLUREAS

The generic formula of sulfonylureas is—

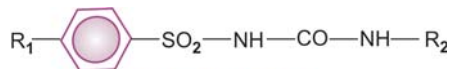

SULFONYLUREA

All have similar pharmacological profile—sole significant action being lowering of blood glucose level in normal subjects and in type 2 diabetics, but not in type 1 diabetics.

Mechanism of action Sulfonylureas provoke a brisk release of insulin from pancreas. They act on the so called ‘sulfonylurea receptors’ (SUR1) on the pancreatic β cell membrane—cause depolarization by reducing conductance of ATP sensitive K^+ channels. This enhances Ca^{2+} influx \rightarrow degranulation. The rate of insulin secretion at any glucose concentration is increased. In type 2 DM the kinetics of insulin release in response to glucose or meals is delayed and subdued. The sulfonylureas primarily augment the 2nd phase insulin secretion with little effect on the 1st phase. That they do not cause hypoglycaemia in pancreatectomised animals and in type 1 diabetics (presence of at least 30% functional β cells is essential for their action) confirms their indirect action through pancreas.

A minor action reducing glucagon secretion, probably by increasing insulin and somatostatin release has been demonstrated. Hepatic degradation of insulin is slowed.

Extrapancreatic action After chronic administration, the insulinaemic action of sulfonylureas declines probably due to down regulation of sulfonylurea receptors on β cells, but improvement in glucose tolerance is maintained. In this phase, they sensitize the target tissues (especially liver) to the action of insulin. This is due to increase in number of insulin receptors and/or a postreceptor action—improving translation of receptor activation. It is hypothesized that long term improvement in carbohydrate tolerance leads to a decreased insulin concentration in blood which reverses the down regulation of insulin receptors—apparent increase in their

number. A direct extrapancreatic action of sulfonylureas to increase insulin receptors on target cells and to inhibit gluconeogenesis in liver has been suggested, but appears to have little clinical relevance.

Pharmacokinetics All sulfonylureas are well absorbed orally, and are 90% or more bound to plasma proteins: have low volumes of distribution (0.2–0.4 L/kg). Some are primarily metabolized—may produce active metabolite; others are mainly excreted unchanged in urine. Accordingly they should be used cautiously in patients with liver or kidney dysfunction.

The distinctive features of different sulfonylureas are given in Table 19.2.

Interactions

Drugs that enhance sulfonylurea action (may precipitate hypoglycaemia) are—

(a) *Displace from protein binding:* Phenylbutazone, sulfinpyrazone, salicylates, sulfonamides, PAS.

(b) *Inhibit metabolism/excretion:* Cimetidine, sulfonamides, warfarin, chloramphenicol, acute alcohol intake (also synergises by causing hypoglycaemia).

(c) *Synergise with or prolong pharmacodynamic action:* Salicylates, propranolol (cardioselective β_1 blockers less liable), sympatholytic antihypertensives, lithium, theophylline, alcohol (by inhibiting gluconeogenesis).

Drugs that decrease sulfonylurea action (vitiates diabetes control) are—

(a) *Induce metabolism:* Phenobarbitone, phenytoin, rifampicin, chronic alcoholism.

(b) *Opposite action/suppress insulin release:* Corticosteroids, diazoxide, thiazides, furosemide, oral contraceptives.

Adverse effects Incidence of adverse effects is quite low (3–7%).

1. **Hypoglycaemia** It is the commonest problem, may occasionally be severe and rarely fatal. It is more common in elderly, liver and kidney disease

patients and when potentiating drugs are added. Chlorpropamide is a frequent culprit due to its long action. Tolbutamide carries lowest risk due to its low potency and short duration of action. Lower incidence is also reported with glipizide, glibenclamide, glimepiride.

Treatment is to give glucose, may be for a few days because hypoglycaemia may recur.

2. **Nonspecific side effects** Nausea, vomiting, flatulence, diarrhoea or constipation, headache, paresthesias and weight gain.

3. **Hypersensitivity** Rashes, photosensitivity, purpura, transient leukopenia, rarely agranulocytosis.

Chlorpropamide in addition causes cholestatic jaundice, dilutional hyponatremia (sensitises the kidney to ADH action), intolerance to alcohol in predisposed subjects (flushing and a disulfiram like reaction); other sulfonylureas are less prone to this interaction.

Tolbutamide reduces iodide uptake by thyroid but hypothyroidism does not occur.

Safety of sulfonylureas during pregnancy is not established—change over to insulin. They are secreted in milk: should not be given to nursing mothers.

BIGUANIDES

Two biguanide antidiabetics, *phenformin* and *metformin* were introduced in the 1950s. Because of higher risk of lactic acidosis, phenformin was withdrawn in many countries and has been banned in India since 2003.

The generic formula of biguanides is:

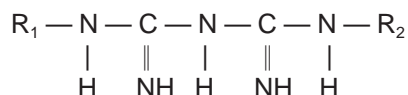

They differ markedly from sulfonylureas: cause little or no hypoglycaemia in nondiabetic subjects, and even in diabetics episodes of hypoglycaemia due to metformin are rare. They do not stimulate pancreatic β cells. Metformin is reported to improve lipid profile as well in type 2 diabetics.

Table 19.2: Important features of oral hypoglycaemics

Drug	Preparations	Plasma $t_{1/2}$ (hr)	Duration of action (hr)	Clearance route*	Daily dose	No. of doses per day	Remarks
SULFONYLUREAS							
1. Tolbutamide	RASTINON , 0.5 g tab.	6-8	6-8	L	0.5-3 g	2-3	Weaker, shorter acting, flexible dosage, safer in elderly and in those prone to hypoglycaemia
2. Chlorpropamide	DIABINESE , 0.1, 0.25 g tab.	30-36	36-48	K,L	0.1-0.5 g	1	Longest-acting, can cause prolonged hypoglycaemia, potentiates ADH action, more cholestatic jaundice, alcohol flush
3. Glibenclamide (Glyburide)	DAONIL , EUGLUCON , BETANASE 2.5, 5 mg tab.	4-6	18-24	L	5-15 mg	1-2	Potent but slow acting, marked initial insulinaemic action, may work when others fail, higher incidence of hypoglycaemia, single daily dose possible despite short $t_{1/2}$
4. Glipizide	GLYNASE , GLIDE MINIDIAB 5 mg tab	3-5	12-18	L	5-20 mg	1-2	Fast acting, insulinaemic action persists even after prolonged use, can be given once daily despite short $t_{1/2}$, hypoglycaemia and weight gain less likely
5. Gliclazide	DIAMICRON 80 mg tab. DIAZIDE 20, 80 mg tab GLIZID 30, 40, 80 mg tab	8-20	12-24	L	40-240 mg	1-2	Has antiplatelet action, reduces free radicals, may delay diabetic retinopathy, less weight gain
6. Glimpiride	AMARYL , GLYPRIDE GLIMER 1, 2 mg tab	5-7	24	L	1-6 mg	1	Stronger extrapancreatic action; less hyperinsulinaemia. Low incidence of hypoglycaemia divide in two if daily dose \geq 4 mg
BIGUANIDES							
1. Metformin	GLYCIPHAGE GLYCOMET 0.5, 0.85 g tab.	1.5-3	6-8	K	0.5-2.5 g	2-3	Not metabolized at all, lactic acidosis less common
MEGLITINIDE / PHENYLALANINE ANALOGUES							
1. Repaglinide	EUREPA , RAPLIN 0.5, 1, 2 mg tab	\leq 1	3-5	L	1.5-8 mg	3-4	Given $\frac{1}{2}$ hr before each meal for limiting p.p. hyperglycaemia
2. Nateglinide	GLINATE 60,120 mg tab	1.5	2-3	L	180-480 mg	3-4	Stimulates 1st phase insulin secretion, less likely to cause delayed hypoglycaemia
THIAZOLIDINEDIONES							
1. Rosiglitazone	REGLIT , ROSINORM ROSS , 2,4,8 mg tab	4	12-24	L	4-8 mg	1-2	Reverses insulin resistance. No hypoglycaemia, C/I in liver and heart disease
2. Pioglitazone	PIONORM , PIOREST , PIOZONE 15, 30 mg tab	3-5	24	L	15-45 mg	1	-d-; May improve lipid profile

*L—Metabolized in liver, K—Excreted unchanged by kidney, p.p.—postprandial

Mechanism of action It is not clearly understood. Biguanides do not cause insulin release, but presence of some insulin is essential for their action. Explanations offered for their hypoglycaemic action are—

1. Suppress hepatic gluconeogenesis and glucose output from liver: the major action.
2. Enhance insulin-mediated glucose disposal in muscle and fat. Though they do not alter translocation of GLUT4 (the major glucose transporter in skeletal muscle), they enhance GLUT1 transport from intracellular site to plasma membrane. The effect thus differs from that of insulin.
3. Retard intestinal absorption of glucose, other hexoses, amino acids and vit B₁₂.
4. Interfere with mitochondrial respiratory chain—promote peripheral glucose utilization by enhancing anaerobic glycolysis. However, metformin binds less avidly to mitochondrial membrane.

Actions 3 and 4 appear to contribute little to the therapeutic effect.

Pharmacokinetics The important features are given in Table 19.2. Clearance of metformin approximates g.f.r. It accumulates and increases the risk of lactic acidosis in renal failure.

Adverse effects Abdominal pain, anorexia, nausea, metallic taste, mild diarrhoea and tiredness are the frequent side effects. Metformin does not cause hypoglycaemia except in overdose.

Lactic acidosis Small increase in blood lactate occurs with metformin, but lactic acidosis is rare (<1 per 10,000 patient years) because it is poorly concentrated in hepatic cells. Alcohol ingestion can precipitate severe lactic acidosis.

Vit B₁₂ deficiency due to interference with its absorption can occur with high dose of metformin.

In addition to general restrictions for use of oral hypoglycaemics (*see below*), biguanides are contraindicated in hypotensive states, cardiovascular, respiratory, hepatic and renal disease and in alcoholics because of increased risk of lactic acidosis.

MEGLITINIDE / D-PHENYLALANINE ANALOGUES

These are recently developed quick and short acting insulin releases.

Repaglinide It is a meglitinide analogue oral hypoglycaemic designed to normalise meal-time glucose excursions. Though not a sulfonylurea, it acts in an analogous manner by binding to sulfonylurea receptor as well as to other distinct receptors → closure of ATP dependent K⁺ channels → depolarisation → insulin release.

Repaglinide induces rapid onset short-lasting insulin release. It is administered before each major meal to control postprandial hyperglycaemia; the dose should be omitted if a meal is missed. Because of short lasting action it may have a lower risk of serious hypoglycaemia. Side effects are mild headache, dyspepsia, arthralgia and weight gain.

Repaglinide is indicated only in type 2 DM as an alternative to sulfonylureas, or to supplement metformin/long-acting insulin. It should be avoided in liver disease.

Nateglinide This D-phenylalanine derivative principally stimulates the 1st phase insulin secretion resulting in rapid onset and shorter duration of hypoglycaemic action than repaglinide. Ingested 10–20 min before meal, it limits postprandial hyperglycaemia in type 2 diabetics without producing late phase hypoglycaemia. There is little effect on fasting blood glucose level. Episodes of hypoglycaemia are less frequent than with sulfonylureas. Side effects are dizziness, nausea, flu like symptoms and joint pain. It is used in type 2 DM along with other antidiabetics, to control postprandial rise in blood glucose.

THIAZOLIDINEDIONES

Two thiazolidinediones *Rosiglitazone* and *Pioglitazone* are available. This novel class of oral antidiabetic drugs are selective agonists for the nuclear *peroxisome proliferator-activated receptor* γ (PPAR γ) which enhances the transcription of several insulin responsive genes. They tend to

reverse insulin resistance by stimulating GLUT4 expression and translocation: entry of glucose into muscle and fat is improved. Hepatic gluconeogenesis is also suppressed. Activation of genes regulating fatty acid metabolism and lipogenesis in adipose tissue contributes to the insulin sensitizing action. Adipocyte turnover and differentiation may also be affected. Thus, fatty tissue is a major site of their action. The magnitude of blood glucose reduction is somewhat less than sulfonylureas and metformin. Improved glycaemic control results in lowering of circulating HbA_{1c} and insulin levels in type 2 DM patients.

Pioglitazone lowers serum triglyceride level and raises HDL level without much change in LDL level, probably because it acts on PPAR α as well. The effect of rosiglitazone on lipid profile is inconsistent.

Both pioglitazone and rosiglitazone are well tolerated; adverse effects are plasma volume expansion, edema, weight gain, headache, myalgia and mild anaemia. Monotherapy with glitazones is not associated with hypoglycaemic episodes. Few cases of hepatic dysfunction and some cardiovascular events have been reported; CHF may be precipitated or worsened. Monitoring of liver function is advised. They are contraindicated in liver disease and in CHF. Rosiglitazone has been found to increase the risk of fractures, especially in elderly women.

Rosiglitazone is metabolized by CYP2C8 while pioglitazone is metabolized by both CYP2C8 and CYP3A4. Failure of oral contraception may occur during pioglitazone therapy. Ketoconazole inhibits metabolism of pioglitazone. Drug interactions are less marked with rosiglitazone.

The thiazolidinediones are indicated in type 2 DM, but not in type 1 DM. They reduce blood glucose and HbA_{1c} without increasing circulating insulin. Some patients may not respond (non-responders), especially those with low baseline insulin levels. Glitazones are primarily used to supplement sulfonylureas/metformin and in case of insulin resistance. They may also be used as

monotherapy (along with diet and exercise) in mild cases. Reduction in mortality due to myocardial infarction and stroke (macrovascular complications) has been obtained in type 2 DM.

Several reports associating precipitation of CHF after combined use of glitazones with insulin have appeared; avoid such combinations. They should not be used during pregnancy. The Diabetes Prevention Programme (2005) has shown that glitazones have the potential to prevent type 2 DM in prediabetics.

α GLUCOSIDASE INHIBITORS

Acarbose It is a complex oligosaccharide which reversibly inhibits α -glucosidases, the final enzymes for the digestion of carbohydrates in the brush border of small intestine mucosa. It slows down and decreases digestion and absorption of polysaccharides and sucrose: postprandial glycaemia is reduced without increasing insulin levels. Regular use tends to lower Hb A_{1c}, body weight and serum triglyceride. These beneficial effects, though modest, have been confirmed in several studies. Further, the stop-NIDDM trial (2002) has shown that long-term acarbose treatment in prediabetics reduces occurrence of type 2 DM as well as hypertension and cardiac disease. In diabetics, it reduces cardiovascular events.

Acarbose is a mild antihyperglycaemic and not a hypoglycaemic; may be used as an adjuvant to diet (with or without a sulfonylurea) in obese diabetics. Dose 50–100 mg TDS is taken at the beginning of each major meal. It is minimally absorbed, but produces flatulence, abdominal discomfort and loose stool in about 50% patients due to fermentation of unabsorbed carbohydrates. **GLUCOBAY 50, 100 mg tabs, ASUCROSE, GLUCAR 50 mg tabs.**

Miglitol is similar to acarbose, and is more potent in inhibiting sucrase.

Status of oral hypoglycaemics in diabetes mellitus

After 8 years of prospective study involving large number of patients, the University Group

Diabetes Programme (UGDP) of USA (1970) presented findings that cardiovascular mortality was higher in patients treated with oral hypoglycaemics than in those treated with diet and exercise alone or with insulin. A decline in their use followed. Subsequent studies both refuted and supported these conclusions.

The controversy has now been settled; UK PDS found that both sulfonylureas and metformin did not increase cardiovascular mortality over > 10 years observation period. Related to degree of glycaemia control, both insulin and sulfonylureas reduced microvascular complications in type 2 DM, but did not have significant effect on macrovascular complications. Metformin, however, could reduce macrovascular complications as well; it decreased risk of death and other diabetes related endpoints in overweight patients. This may be related to the fact that both sulfonylureas and exogenous insulin improve glycaemic control by increasing insulin supply rather than by reducing insulin resistance, while metformin can lower insulin resistance. The thiazolidinediones are another class of drugs which reverse insulin resistance, and have been found to reduce macrovascular complications and mortality in type 2 DM. All oral hypoglycaemics do however control symptoms that are due to hyperglycaemia and glycosuria, and are much more convenient than insulin.

Oral hypoglycaemics are indicated only in type 2 diabetes, when not controlled by diet and exercise. They are best used in patients with—

1. Age above 40 years at onset of disease.
2. Obesity at the time of presentation.
3. Duration of disease < 5 years when starting treatment.
4. Fasting blood sugar < 200 mg/dl.
5. Insulin requirement < 40 U/day.
6. No ketoacidosis or a history of it, or any other complication.

Introduced in the prediabetic 'impaired glucose tolerance phase', sulfonylurea + dietary regulation has been shown to postpone manifest type 2 DM. This may be due to the fact that

hyperglycaemia is a self perpetuating condition. The Diabetes Prevention Programme (2002) has established that in middle aged, obese prediabetics metformin prevented progression to type 2 DM, but not in older nonobese prediabetics. Glitazones appear to have similar potential. Long-term acarbose therapy can also prevent type 2 DM.

Oral hypoglycaemics should be used to supplement dietary management and not to replace it. Metformin is preferred in obese type 2 patients: its anorectic action aids weight reduction and it has the potential to lower risk of myocardial infarction and stroke. The g.i. tolerance of metformin is poorer and its patient acceptability is less than that of sulfonylureas. Moreover, the sulfonylureas appear to produce greater blood sugar lowering. As such, many patients are treated initially with a sulfonylurea alone. Metformin can be used to supplement sulfonylureas in patients not adequately controlled by the latter.

There is no difference in the clinical efficacy of different sulfonylureas. This however does not signify that choice of drug is irrelevant. Differences between them are mainly in dose, onset and duration of action which governs flexibility of regimens. The second generation drugs are dose to dose more potent, produce fewer side effects and drug interactions, and are commonly used, but no spectacular features have emerged.

Chlorpropamide is not recommended because of long duration of action, greater risk of hypoglycaemia, jaundice, alcohol flush, dilutional hyponatraemia and other adverse effects. *Tolbutamide* is less popular due to low potency, but may be employed in the elderly to avoid hypoglycaemia. *Glibenclamide* and *glyclazide* are suitable for most patients, but have been found to cause hypoglycaemia more frequently. *Glipizide* is preferred when a faster and shorter acting drug is required. *Glimepiride* is a newer sulfonylurea, claimed to have stronger extrapancreatic action by enhancing GLUT4 translocation to the plasma membrane, thus causing lesser hyperinsulinaemia.

A low incidence of hypoglycaemic episodes has been reported with glimepiride. This may be due to its ability to preserve hypoglycaemia induced glucagon release and suppression of insulin release, responses that are attenuated by glibenclamide. Glimepiride is suitable for once daily dosing due to gradual release from tissue binding.

Even in properly selected patients, sulfonylureas may fail from the beginning (primary failure 5–28%) or become ineffective after a few months or years of satisfactory control (secondary failure 5–10% per year): may be due to progressive loss of β cells, reduced physical activity, continuing insulin resistance, drug and dietary noncompliance or desensitization of receptors. If one sulfonylurea proves ineffective in a patient, another one (especially a second

generation) may still work. Combined use of a sulfonylurea and a biguanide may be tried if either is not effective alone and the glitazones are now available as add on/alternative drugs. Patients with marked/only postprandial hyperglycaemia may be treated with repaglinide/nateglinide. Upto 50% patients of type 2 DM initially treated with oral hypoglycaemics ultimately need insulin. Despite their limitations, oral hypoglycaemics are suitable therapy for majority of type 2 DM patients. However, when a diabetic on oral hypoglycaemics presents with infection, severe trauma or stress, pregnancy, ketoacidosis or any other complication or has to be operated upon—switch over to insulin (see Fig. 19.5).

Sulfonylureas and metformin can also be combined with insulin, particularly when a

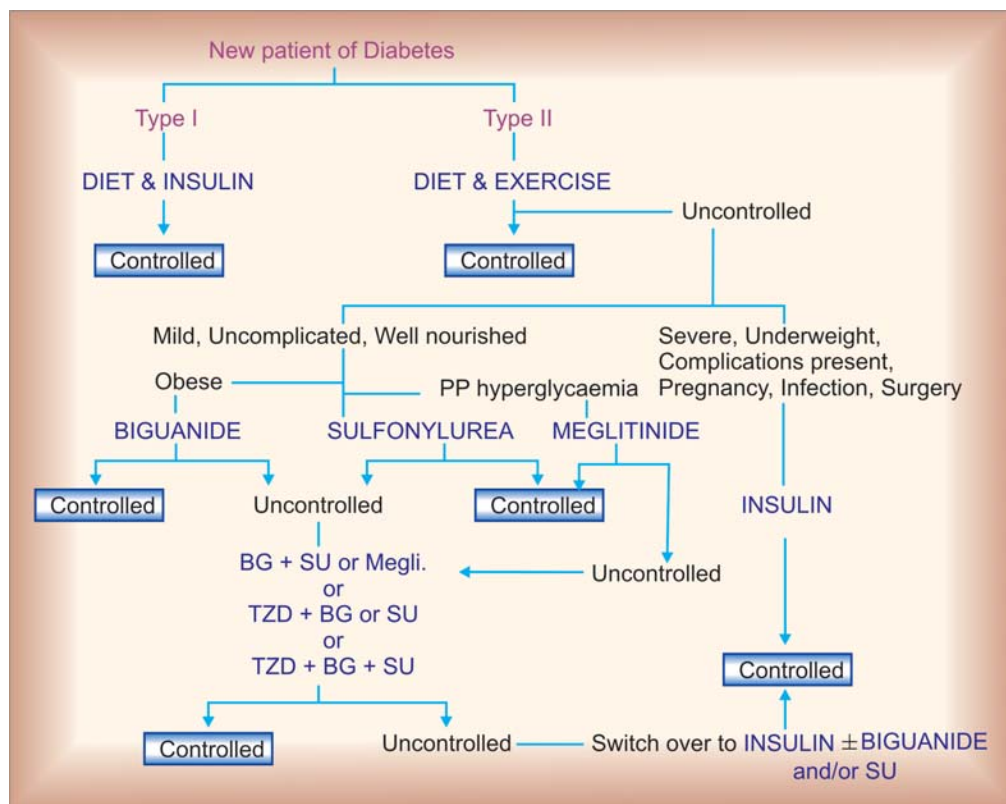

Fig. 19.5: Flow chart of management approach in diabetes mellitus.
BG: Biguanide; SU: Sulfonylureas; TZD: Thiazolidinedione; PP: Postprandial

single daily injection of long-acting insulin is used to provide basal control, the oral hypoglycaemics given before meals serve to check postprandial glycaemia.

Guargum It is a dietary fibre (polysaccharide) from Indian cluster beans (Guar), which forms a viscous gel on contact with water. Administered just before or mixed with food, it slows gastric emptying, intestinal transit and carbohydrate absorption: postprandial glycaemia is suppressed but overall lowering of blood glucose is marginal. It also reduces serum cholesterol by about 10%.

Guargum can be used to supplement diet and to lower sulfonyleurea dose, and as a hypocholesterolemic. It is not absorbed but fermented in the colon. Side effects are flatulence, feeling of fullness, loss of appetite, nausea, gastric discomfort and diarrhoea. Start with a low dose (2.5 g/day) and gradually increase to 5 g TDS.

DIATAID, CARBOTARD 5 g sachet.

Glucomannan This powdered extract from tubers of Konjar is promoted as a dietary adjunct for diabetes. It swells in the stomach by absorbing water and is claimed to reduce appetite, blood sugar, serum lipids and relieve constipation.

DIETMANN 0.5 g cap, 1 g sachet; 1 g to be taken before meals.

NEWER APPROACHES IN DIABETES

Exenatide The glucagon-like peptide-1 (GLP-1) is an important incretin that is released from the gut in response to oral glucose. It is difficult to use clinically because of rapid degradation by the enzyme dipeptidyl peptidase-4 (DPP-4). *Exenatide* is a synthetic GLP-1 analogue, resistant to DPP-4, but with similar actions, *viz.* enhancement of postprandial insulin release, suppression of glucagon release and appetite as well as slowing of gastric emptying. It has been marketed in the USA to be used as an additional drug with metformin and/or sulfonyleureas in type 2 diabetics who have inadequate response to the oral hypoglycaemics. Exenatide is injected s.c. twice daily 1 hour before meals; acts for 6–10 hours. Nausea is an important side effect.

Sitagliptin This orally active inhibitor of DPP-4 prevents degradation of endogenous GLP-1 and other incretins, potentiating their action, resulting in limitation of postprandial hyperglycaemia. It is undergoing clinical evaluation as an add-on drug to sulfonyleurea/ metformin/ thiazolidinediones in type 2 DM.

Pramlintide This synthetic amylin (a polypeptide produced by pancreatic β cells which reduces glucagon secretion from α cells and delays gastric emptying)

analogue attenuates postprandial hyperglycaemia when injected s.c. just before a meal, and exerts a centrally mediated anorectic action. The duration of action is 2–3 hours. It has been marketed as an adjuvant to insulin/ sulfonyleureas/metformin for control of meal-time glycaemia in both type-1 and type-2 diabetes.

GLUCAGON

A hyperglycaemic principle was demonstrated to be present in the pancreatic islets just two years after the discovery of insulin in 1921. It was named 'glucagon'. Glucagon is a single chain polypeptide containing 29 amino acids, MW 3500. Beef and pork glucagon are identical to human glucagon. It is secreted by the α cells of the islets of Langerhans.

Regulation of Secretion Like insulin, glucagon is also derived by cleavage of a larger peptide prohormone. Its secretion is regulated by glucose levels, other nutrients, paracrine hormones and nervous system. Glucose has opposite effects on insulin and glucagon release, i.e. high glucose level inhibits glucagon secretion and it is more sensitive to orally administered glucose: suggesting that the same gastrointestinal incretins which evoke insulin release may be inhibiting glucagon secretion. FFA and ketone bodies also inhibit glucagon release. Amino acids, however, induce both insulin and glucagon secretion. Insulin, amylin and somatostatin, elaborated by the neighbouring β and D cells, inhibit glucagon secretion. Sympathetic stimulation consistently and parasympathetic stimulation under certain conditions evokes glucagon release.

Actions Glucagon is hyperglycaemic; most of its actions are opposite to that of insulin. Glucagon causes hyperglycaemia primarily by enhancing glycogenolysis and gluconeogenesis in liver; suppression of glucose utilization in muscle and fat contributes modestly. It is considered to be the hormone of fuel mobilization. Its secretion is increased during fasting; this serves to maintain energy supply by mobilizing stored fat and carbohydrate as well as by promoting gluconeogenesis in liver. It plays an essential role in the development of diabetic ketoacidosis. Increased secretion of glucagon has been shown to attend all forms of severe tissue injury.

Glucagon increases the force and rate of cardiac contraction and this is not antagonized by β blockers. It has a relaxant action on the gut and inhibits gastric acid production.

Mechanism of action Glucagon, through its own receptor and coupling Gs protein activates adenylyl cyclase and increases cAMP in liver, fat cells, heart and other tissues; most of its actions are mediated through this cyclic nucleotide.

Glucagon is inactive orally; that released from pancreas is broken down in liver, kidney, plasma and other tissues. Its $t_{1/2}$ is 3–6 min.

Uses

1. *Hypoglycaemia* due to insulin or oral hypoglycaemics; use of glucagon is secondary to that of glucose; only an expedient measure. It may not work if hepatic glycogen is already depleted: 0.5–1 mg i.v. or i.m.
2. *Cardiogenic shock* to stimulate the heart in β adrenergic blocker treated patients. However, action is not very marked.
3. *Diagnosis of pheochromocytoma* 1 mg i.v. causes release of catecholamines from the tumour and markedly raises BP. Phentolamine should be at hand to counter excessive rise in BP.

GLUCAGON 1 mg inj.

Other hyperglycaemics

Diazoxide It inhibits insulin release from β cells and causes hyperglycaemia lasting 4–8 hours. Its action on ATP sensitive K^+ channels is opposite to that of sulfonylureas. Other actions which may contribute to hyperglycaemia are decreased peripheral utilization of glucose and release of catecholamines. It has been used to prevent hypoglycaemia in insulinomas.

Thiazide diuretics and phenytoin These are also mild hyperglycaemics.

Somatostatin It causes hyperglycaemia primarily by inhibiting insulin release.

Streptozocin It is obtained from *Streptomyces achromogenes*. Causes selective damage to insulin secreting β cells. It has been used to produce experimental diabetes in animals and to treat insulin secreting tumours of pancreas.



The adrenal cortex secretes steroidal hormones which have glucocorticoid, mineralocorticoid and weakly androgenic activities. Conventionally, the term 'corticosteroid' or 'corticoid' includes natural gluco- and mineralo-corticoids and their synthetic analogues.

By the middle of 19th century it was demonstrated that adrenal glands were essential for life. Later it was appreciated that the cortex was more important than the medulla. A number of steroidal active principles were isolated and their structures were elucidated by Kendall and his coworkers in the 1930s. However, the gate to their great therapeutic potential was opened by Hench (1949) who obtained striking improvement in rheumatoid arthritis by using cortisone. The Nobel Prize was awarded the very next year to Kendall, Reichstein and Hench.

BIOSYNTHESIS

The corticoids (both gluco and mineralo) are 21 carbon compounds having a cyclopentanoperhydro-phenanthrene (steroid) nucleus. They are synthesized in the adrenal cortical cells from cholesterol. A simplified version of the biosynthetic pathways is presented in Fig. 20.1. Adrenal steroidogenesis takes place under the influence of ACTH which makes more cholesterol available for conversion to pregnenolone and induces steroidogenic enzymes. Since adrenal cortical cells store only minute quantities of the hormones, rate of release is governed by the rate of biosynthesis.

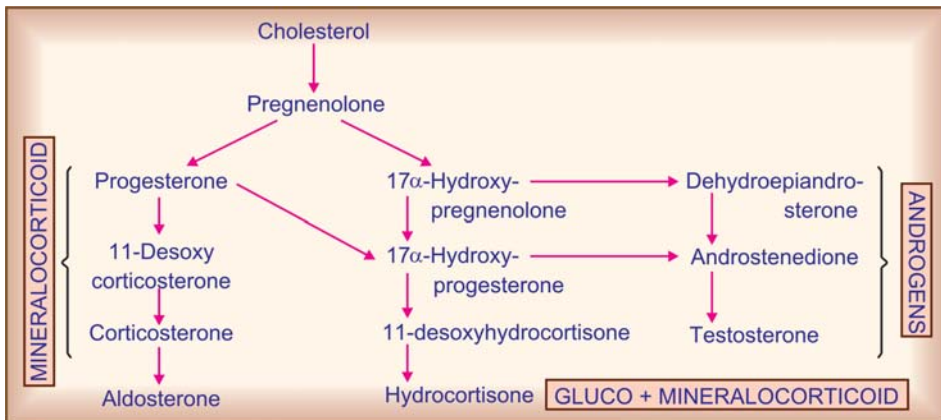

Fig. 20.1: Simplified depiction of the pathways of adrenal steroid hormone biosynthesis

The normal rate of secretion of the two principal corticoids in man is—

Hydrocortisone—10–20mg daily (nearly half of this in the few morning hours).

Aldosterone —0.125 mg daily.

ACTIONS

The corticoids have widespread actions. They maintain fluid-electrolyte, cardiovascular and energy substrate homeostasis and functional status of skeletal muscles and nervous system. They prepare the body to withstand effects of all kinds of noxious stimuli and stress. The involvement of hypothalamo-pituitary-adrenal axis in stress response is depicted in Fig. 20.2.

Corticoids have some *direct* and some *permissive* actions. By permissive action is meant that while they do not themselves produce an effect, their presence facilitates other hormones to exert that action, e.g. they do not have any effect on BP but the pressor action of Adr is markedly blunted in their absence. Actions of corticoids are divided into:

Glucocorticoid Effects on carbohydrate, protein and fat metabolism, and other activities that are inseparably linked to these.

Mineralocorticoid Effects on Na^+ , K^+ and fluid balance.

Marked dissociation between these two types of actions is seen among natural as well as synthetic

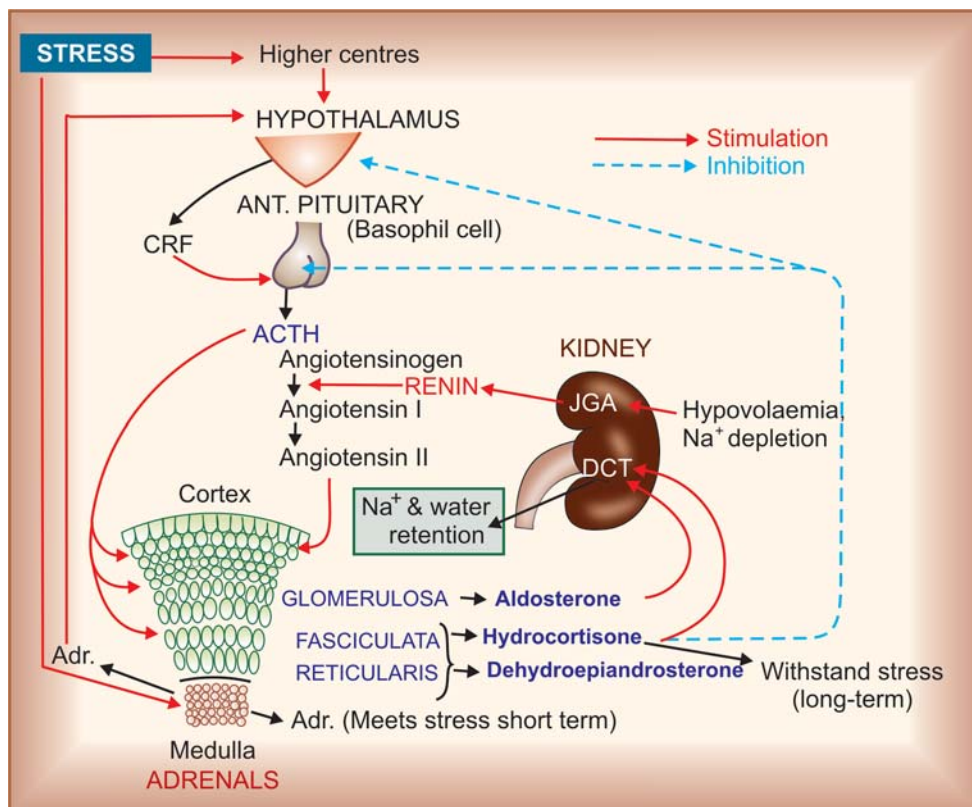

Fig. 20.2: Hypothalamo-pituitary-adrenal axis; regulation of corticosteroid production and response to stress

corticoids. Accordingly, compounds are labelled as 'glucocorticoid' or 'mineralocorticoid'.

Mineralocorticoid actions

The principal mineralocorticoid action is enhancement of Na^+ reabsorption in the distal convoluted tubule in kidney. There is an associated increase in K^+ and H^+ excretion. Its deficiency results in decreased maximal tubular reabsorptive capacity for Na^+ ; kidney is not able to retain Na^+ even in the Na^+ deficient state \rightarrow Na^+ is progressively lost: kidneys absorb water without attendant Na^+ (to maintain e.c.f. volume which nevertheless decreases) \rightarrow dilutional hyponatraemia \rightarrow excess water enters cells \rightarrow cellular hydration: decreased blood volume and raised haematocrit. Hyperkalaemia and acidosis accompany. These distortions of fluid and electrolyte balance progress and contribute to circulatory collapse. Thus, these actions make adrenal cortex essential for survival.

Similar action on cation transport is exerted in other tissues also. The action of aldosterone is expressed by gene mediated increased transcription of m-RNA in renal tubular cells which directs synthesis of proteins (aldosterone-induced proteins—AIP). The Na^+K^+ ATPase of tubular basolateral membrane responsible for generating gradients for movement of cations in these cells is the major AIP (see Fig. 41.3). Synthesis of β subunit of amiloride sensitive Na^+ channel is also induced. Because of the time taken to induce protein synthesis, aldosterone has a latency of action of 1–2 hours. In addition, aldosterone rapidly induces phosphorylation and activation of amiloride sensitive Na^+ channel.

The main adverse effect of excessive mineralocorticoid action is fluid retention and hypertension. The natural and some of the synthetic glucocorticoids have significant mineralocorticoid activity responsible for side effects like edema, progressive rise in BP, hypokalemia and alkalosis. The diuretic induced hypokalemia is aggravated.

Aldosterone has been shown to promote CHF associated myocardial fibrosis and progression of the disease.

Glucocorticoid actions

1. Carbohydrate and protein metabolism

Glucocorticoids promote glycogen deposition in liver (they are assayed on the basis of this action) by inducing hepatic glycogen synthase and promoting gluconeogenesis. They inhibit glucose utilization by peripheral tissues. This along with increased glucose release from liver results in hyperglycaemia, resistance to insulin and a diabetes-like state. They also cause protein breakdown and amino acid mobilization from peripheral tissues—responsible for side effects—like muscle wasting, lympholysis, loss of osteoid from bone and thinning of skin. The amino acids so mobilized funnel into liver \rightarrow used up in gluconeogenesis, excess urea is produced \rightarrow negative nitrogen balance. Glucocorticoids are thus catabolic. Their function appears to be aimed at maintaining blood glucose levels during starvation—so that brain continues to get its nutrient. When food is withheld from an adrenalectomized animal—liver glycogen is rapidly depleted and hypoglycaemia occurs. They also increase uric acid excretion.

2. Fat metabolism The action is primarily permissive in nature: promote lipolysis due to glucagon, growth hormone, Adr and thyroxine. cAMP induced breakdown of triglycerides is enhanced. Fat depots in different areas respond differently—redistribution of body fat occurs. Subcutaneous tissue over extremities loses fat which is deposited over face, neck and shoulder—'moon face', 'fish mouth', 'buffalo hump'. Explanation offered is—because peripheral adipocytes are less sensitive to insulin, corticosteroid enhanced lipolytic action of GH and Adr predominates, whereas truncal adipocytes respond mainly to enhanced insulin levels under the influence of glucocorticoids.

3. Calcium metabolism They inhibit intestinal absorption and enhance renal excretion of

Ca²⁺. There is also loss of calcium from bone indirectly due to loss of osteoid (decreased formation and increased resorption), negative calcium balance. Spongy bones (vertebrae, ribs, etc.) are more sensitive.

4. Water excretion Effect on water excretion is independent of action on Na⁺ transport; hydrocortisone and other glucocorticoids, but not aldosterone, maintain normal g.f.r. In adrenal insufficiency, the capacity to excrete a water load is markedly reduced—such patients are prone to water intoxication from i.v. infusions.

Glucocorticoids also enhance secretory activity of renal tubules.

5. CVS Glucocorticoids restrict capillary permeability, maintain tone of arterioles and myocardial contractility. Applied topically, they cause cutaneous vasoconstriction. They have a permissive effect on pressor action of Adr and angiotensin. They also play a permissive role in development of hypertension—should be cautiously used in hypertensives.

Adrenal insufficiency is attended by low cardiac output, arteriolar dilatation, poor response to Adr (repeated doses of Adr cause destructive changes in blood vessels) and increased permeability of capillaries. These changes along with hypovolemia (due to lack of mineralocorticoid) are responsible for cardiovascular collapse.

6. Skeletal muscles Optimum level of corticosteroids is needed for normal muscular activity. Weakness occurs in both hypo- and hypercorticism, but the causes are different.

Hypocorticism: diminished work capacity and weakness are primarily due to hypodynamic circulation.

Hypercorticism: excess mineralocorticoid action → hypokalaemia → weakness;

Excess glucocorticoid action → muscle wasting and myopathy → weakness.

7. CNS Mild euphoria is quite common with pharmacological doses of glucocorticoids. This is a direct effect on brain, independent of relief of

disease symptoms; sometimes progresses to cause increased motor activity, insomnia, and hypomania or depression. On the other hand, patients of Addison's disease suffer from apathy, depression and occasionally psychosis.

Glucocorticoids also maintain the level of sensory perception and normal level of excitability of neurones. High doses lower seizure threshold—cautious use in epileptics. This action is independent of electrolyte changes in the brain and is not shared by aldosterone.

8. Stomach Secretion of gastric acid and pepsin is increased—may aggravate peptic ulcer.

9. Lymphoid tissue and blood cells Glucocorticoids enhance the rate of destruction of lymphoid cells (T cells are more sensitive than B cells); but in man the effect on normal lymphoid tissue is modest. However, a marked lytic response is shown by malignant lymphatic cells; basis of their use in lymphomas.

Glucocorticoids increase the number of RBCs, platelets and neutrophils in circulation. They decrease lymphocytes, eosinophils and basophils. This is not due to destruction of these cells but due to their sequestration in tissues. Blood counts come back to normal after 24 hours.

10. Inflammatory responses Irrespective of the type of injury or insult, the attending inflammatory response is suppressed by glucocorticoids. This is the basis of most of their clinical uses. The action is nonspecific and covers all components and stages of inflammation. This includes reduction of—increased capillary permeability, local exudation, cellular infiltration, phagocytic activity and late responses like capillary proliferation, collagen deposition, fibroblastic activity and ultimately scar formation. The action is direct and local—topical use is possible. The cardinal signs of inflammation—redness, heat, swelling and pain are suppressed.

Glucocorticoids interfere at several steps in the inflammatory response (*see* cellular mechanism below), but the most important overall mechanism appears to be limitation of recruitment of

inflammatory cells at the local site and production of proinflammatory mediators like PGs, LTs, PAF through inhibition of phospholipase A₂.

Corticoids are only palliative, do not remove the cause of inflammation; the underlying disease continues to progress while manifestations are dampened. They favour spread of infections because capacity of defensive cells to kill microorganisms is impaired. They also interfere with healing and scar formation: peptic ulcer may perforate asymptotically. Indiscriminate use of corticoids is hazardous.

11. Immunological and allergic responses

Glucocorticoids impair immunological competence. They suppress all types of hypersensitization and allergic phenomena. At high concentrations and *in vitro* they have been shown to interfere with practically every step of the immunological response, but at therapeutic doses

in vivo there is no impairment of antibody production or complement function. The clinical effect appears to be due to suppression of recruitment of leukocytes at the site of contact with antigen and of inflammatory response to immunological injury.

They cause greater suppression of CMI in which T cells are primarily involved, e.g. delayed hypersensitivity and graft rejection—basis of use in autoimmune diseases and organ transplantation (*see* Ch. 63). Factors involved may be inhibition of IL-1 release from macrophages; inhibition of IL-2 formation and action → T cell proliferation is not stimulated; suppression of natural killer cells, etc.

The broad action seems to be interruption of communication between cells involved in the immune process by interfering with production of or action of lymphokines.

Gene mediated cellular actions of glucocorticoids

Mechanism	Action
<ul style="list-style-type: none"> • Translocation of glucose transporters from plasma membrane to deeper sites. • Induction of hepatic gluconeogenic enzymes. • Induction of hepatic glycogen synthase. • Site specific changes in sensitivity of adipocytes to GH, Adr, insulin. • ↑ expression of vascular adrenergic and AT₁ receptor. • ↓ expression of POMC gene in pituitary corticotropes 	<ul style="list-style-type: none"> • ↓ glucose uptake and utilization in peripheral tissues. • ↑ production of glucose from amino acids. • Deposition of glycogen in hepatocytes. • Altered distribution of body fat. • Enhanced reactivity to vasopressor substances. • ↓ production of ACTH
<i>Antiinflammatory and Immunosuppressant actions</i>	
<ul style="list-style-type: none"> • Induction of lipocortins in macrophages, endothelium and fibroblasts. • Negative regulation of COX-2 • Negative regulation of genes for cytokines in macrophages, endothelial cells and lymphocytes. • ↓ production of acute phase reactants from macrophages and endothelial cells • ↓ production of ELAM-1 and ICAM-1 in endothelial cells. • ↓ production of collagenase and stromolysin 	<ul style="list-style-type: none"> • Lipocortins inhibit phospholipase A₂ → decreased production of PGs, LTs & PAF. • ↓ inducible PG production • ↓ production of IL-1, IL-2, IL-3, IL-6, TNFα, GM-CSF, γ interferon → fibroblast proliferation and T-lymphocyte function are suppressed, chemotaxis interfered. • Complement function is interfered. • Adhesion and localization of leukocytes is interfered. • Prevention of tissue destruction

POMC—Proopiomelanocortin; IL—Interleukin; TNF α —Tumour necrosis factor α ; GM-CSF—Granulocyte macrophage colony stimulating factor; ELAM-1—Endothelial leukocyte adhesion molecule-1; ICAM-1—Intracellular adhesion molecule-1.

Mechanism of action at cellular level

Corticosteroids penetrate cells and bind to a high affinity cytoplasmic receptor protein → a structural change occurs in the steroid receptor complex that allows its migration into the nucleus and binding to glucocorticoid response elements (GRE) on the chromatin → transcription of specific m-RNA → regulation of protein synthesis (see Fig. 4.9). This process takes at least 30–60 min: effects of corticosteroid are not immediate, and once the appropriate proteins are synthesized—effects persist much longer than the steroid itself. In many tissues, the overall effect is catabolic, i.e. inhibition of protein synthesis. This may be a consequence of steroid directed synthesis of an inhibitory protein.

The glucocorticoid receptor (GR) is very widely distributed (in practically all cells). It has been cloned and its structure determined; made up of ~ 800 amino acids.

Several *coactivators* and *corepressors* modulate the interaction of liganded GR with the GREs, altering the intensity of response.

Because the GR largely maintains uniformity throughout the body, tissue specificity is not exhibited by different glucocorticoids, and all members produce the same constellation of effects.

The functional scheme of glucocorticoid receptor is presented in Fig. 4.9. Direct evidence of gene expression mediated action has been obtained for actions listed in the box (p. 279).

Some actions of corticoids are exerted more rapidly (like inhibition of ACTH release from pituitary). These may be mediated by a cell membrane receptor or a different mechanism not involving protein synthesis.

PHARMACOKINETICS

All natural and synthetic corticoids, except DOCA are absorbed and are effective by the oral route. Water soluble esters, e.g. hydrocortisone hemisuccinate, dexamethasone sod. phosphate can be given i.v. or i.m., act rapidly and achieve high concentrations in tissue fluids. Insoluble esters, e.g. hydrocortisone acetate, triamcinolone acetonide cannot be injected i.v., but are slowly

absorbed from i.m. site and produce more prolonged effects.

Hydrocortisone undergoes high first pass metabolism, has low oral: parenteral activity ratio. Oral bioavailability of synthetic corticoids is high.

Hydrocortisone is 90% bound to plasma protein, mostly to a specific cortisol-binding globulin (CBG; transcortin) as well as to albumin. Transcortin concentration is increased during pregnancy and by oral contraceptives—corticoid levels in blood are increased but hypercorticism does not occur, because free cortisol levels are normal.

The corticosteroids are metabolized primarily by hepatic microsomal enzymes. Pathways are—

- (i) Reduction of 4, 5 double bond and hydroxylation of 3-keto group.
- (ii) Reduction of 20-keto to 20-hydroxy form.
- (iii) Oxidative cleavage of 20C side chain (only in case of compounds having a 17-hydroxyl group) to yield 17-ketosteroids.

These metabolites are further conjugated with glucuronic acid or sulfate and are excreted in urine.

The plasma $t_{1/2}$ of hydrocortisone is 1.5 hours. However, the biological $t_{1/2}$ is longer because of action through intracellular receptors and regulation of protein synthesis—effects that persist long after the steroid is removed from plasma.

The synthetic derivatives are more resistant to metabolism and are longer acting.

Phenobarbitone and phenytoin induce metabolism of hydrocortisone, prednisolone and dexamethasone, etc. to decrease their therapeutic effect.

CHEMISTRY AND RELATIVE ACTIVITY OF CORTICOIDS

Fig. 20.3 depicts the chemical structure of desoxycorticosterone in blue line. It is a selective mineralocorticoid. Chemical modifications that result in clinically useful compounds are also indicated. Fluorination at position 9 or 6 has resulted in highly potent compounds. Synthetic steroids have largely replaced the natural compounds in therapeutic use, because they are potent, longer acting, more

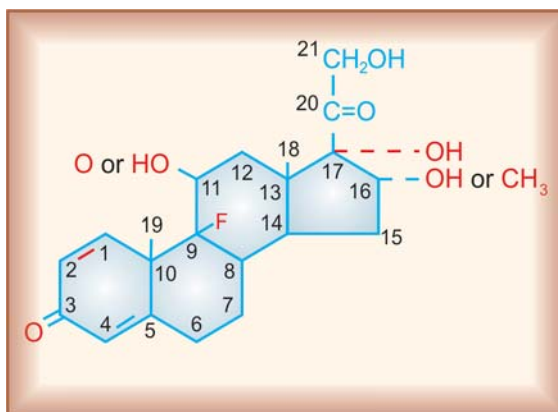

Fig. 20.3: Chemical structure of corticosteroids. The structure in blue is desoxycorticosterone. Important substitutions which yield other useful compounds are shown in red

+ OH at 11	— Corticosterone
+ OH at 11 + OH at 17	— Hydrocortisone
(if O at 11) + OH at 17	— Cortisone
+ OH at 11 + OH at 17 + Δ 1, 2	— Prednisolone
+ OH at 11 + OH at 17 + Δ 1, 2 + F at 9 + OH at 16	— Triamcinolone
+ OH at 11 + OH at 17 + Δ 1, 2 + F at 9 + CH ₃ α at 16	— Dexamethasone
+ OH at 11 + OH at 17 + Δ 1, 2 + F at 9 + CH ₃ β at 16	— Betamethasone
Hydrocortisone + F at 9	— Fludrocortisone
Corticosterone + CHO at 18	— Aldosterone

selective for glucocorticoid/mineralocorticoid action and have high oral activity.

DISTINCTIVE FEATURES

The relative potency and activity of different natural and synthetic corticosteroids employed systemically is compared in Table 20.1.

1. Hydrocortisone (cortisol) Acts rapidly but has short duration of action. In addition to primary glucocorticoid, it has significant mineralocorticoid activity as well. Used for:

Replacement therapy—20 mg morning + 10 mg afternoon orally.

Shock, status asthmaticus, acute adrenal insufficiency—100 mg i.v. bolus + 100 mg 8 hourly i.v. infusion.

Topically (*see* Ch. 64) and as suspension for enema in ulcerative colitis (*see* Ch. 48).

LYCORTIN-S, EFCORLIN SOLUBLE 100 mg/2 ml inj. (as hemisuccinate for i.v. inj.) WYCORT, EFCORLIN 25 mg/ml inj (as acetate for i.m./intraarticular inj.). PRIMACORT 100, 200, 400 mg/vial inj.

2. Prednisolone It is 4 times more potent than hydrocortisone, also more selective glucocorticoid, but fluid retention does occur with high doses. Has intermediate duration of action: causes less pituitary-adrenal suppression when a single morning dose or alternate day treatment is given. Used for allergic, inflammatory, autoimmune diseases and in malignancies: 5–60 mg/day oral, 10–40 mg i.m., intraarticular; also topically.

DELTACORTRIL, HOSTACORTIN-H, 5, 10 mg tab, 20 mg/ml (as acetate) for i.m., intraarticular inj., WYSOLONE, NUCORT, 5, 10, 20, 30, 40 mg tabs.

3. Methylprednisolone Slightly more potent and more selective than prednisolone: 4–32 mg/day oral. Methylprednisolone acetate has been used as a retention enema in ulcerative colitis.

Pulse therapy with high dose methylprednisolone (1 g infused i.v. every 6–8 weeks) has been tried in nonresponsive active rheumatoid arthritis, renal transplant, pemphigus, etc. with good results and minimal suppression of pituitary-adrenal axis.

Table 20.1: Relative activity of systemic corticosteroids

		Compound	Glucocorticoid	Mineralocorticoid	Equiv. dose (antiinflammatory)
GLUCOCORTICOIDS	Short acting, (Biological $t_{1/2} < 12$ hr)	1. Hydrocortisone (cortisol)	1	1	20 mg
	Intermediate acting, (Biological $t_{1/2}$ 12–36 hr)	2. Prednisolone	4	0.8	5 mg
		3. Methylprednisolone	5	0.5	4 mg
		4. Triamcinolone	5	0	4 mg
	Long acting, (Biological $t_{1/2} > 36$ hr)	5. Dexamethasone	25	0	0.75 mg
		6. Betamethasone	25	0	0.75 mg
MINERALOCORTICOIDS		7. Desoxycorticosterone acetate (DOCA)	0	100	<i>Equiv. salt retaining dose</i> 2.5 mg (sublingual)
		8. Fludrocortisone	10	150	0.2 mg
		9. Aldosterone	0.3	3000	not used clinically

SOLU-MEDROL Methylprednisolone (as sod. succinate) 40 mg, 125 mg, 0.5 g (8 ml) and 1.0 g (16 ml) inj, for i.m. or slow i.v. inj.

The initial effect of methylprednisolone pulse therapy (MPPT) is probably due to its antiinflammatory action, while long term benefit may be due to temporary switching off of the immunodamaging processes as a consequence of lymphopenia and decreased Ig synthesis.

4. Triamcinolone Slightly more potent than prednisolone but highly selective glucocorticoid: 4–32 mg/day oral, 5–40 mg i.m., intraarticular injection. Also used topically.

KENACORT, TRICORT 1, 4, 8 mg tab., 10 mg/ml, 40 mg/ml (as acetone) for i.m., intraarticular inj., **LEDERCORT** 4 mg tab.

5. Dexamethasone Very potent and highly selective glucocorticoid. Long acting, causes marked pituitary-adrenal suppression, but fluid retention and hypertension are not a problem.

It is used for inflammatory and allergic conditions 0.5–5 mg/day oral. Shock, cerebral edema, etc. 4–20 mg/day i.v. infusion or i.m. injection. Also used topically.

DECADRON, DEXONA 0.5 mg tab, 4 mg/ml (as sod. phosphate) for i.v., i.m. inj., 0.5 mg/ml oral drops; **WYMESONE, DECDAN** 0.5 mg tab, 4 mg/ml inj.

6. Betamethasone Similar to dexamethasone, 0.5–5 mg/day oral, 4–20 mg i.m., i.v. injection or infusion, also topical.

BETNESOL, BETACORTIL, CELESTONE 0.5 mg, 1 mg tab, 4 mg/ml (as sod. phosphate) for i.v., i.m. inj., 0.5 mg/ml oral drops. **BETNELAN** 0.5 mg, 1 mg tabs.

Dexamethasone or betamethasone are preferred in cerebral edema and other states in which fluid retention must be avoided.

7. Desoxycorticosterone acetate (DOCA) It has only mineralocorticoid activity. Used occasionally for replacement therapy in Addison's disease: 2–5 mg sublingual, 10–20 mg i.m. once or twice weekly.

In **DOCABOLIN** 10 mg/ml inj (along with nandrolone).

8. Fludrocortisone A potent mineralocorticoid having some glucocorticoid activity as well, orally active, used for:

Replacement therapy in Addison's disease 50–200 µg daily. Congenital adrenal hyperplasia in patients with salt wasting 50–200 µg/day.

Idiopathic postural hypotension 100–200 µg/day.

FLORICORT 100 µg tab.

9. Aldosterone The most potent mineralocorticoid. Not used clinically because of low oral bioavailability and difficulties in regulating doses.

In addition a number of *topically* active glucocorticoids have been developed.

Beclomethasone dipropionate, budesonide, etc. are used by inhalation in asthma, as spray in nasal allergy, as well as for skin and mucous membrane lesions (*see* Ch. 16).

Fluocinolone acetonide, fluocortolone, clobetasol propionate and esters of betamethasone, dexamethasone, triamcinolone are described in Ch. 64.

USES

A. Replacement therapy

1. **Acute adrenal insufficiency** It is an emergency. Hydrocortisone or dexamethasone are given i.v., first as a bolus injection and then as infusion, along with isotonic saline and glucose solution. Amount of fluid infused i.v. is guided by monitoring central venous pressure, because these patients have reduced capacity to excrete water load. Short-term i.v. infusion of a vasopressor (dopamine) may be needed.

2. **Chronic adrenal insufficiency (Addison's disease)** Hydrocortisone given orally is the most commonly used drug along with adequate salt and water allowance. Some patients in addition need a mineralocorticoid: fludrocortisone is added.

3. **Congenital adrenal hyperplasia (Adrenogenital syndrome)** It is a familial disorder due to genetic deficiency of steroidogenic enzymes, mostly 21-hydroxylase. As a result the synthesis of hydrocortisone and aldosterone suffers. There is compensatory increase in ACTH secretion—adrenals hypertrophy; enzyme deficiency being only partial in most cases, normal amounts of gluco- and mineralocorticoids are produced along with excessive amounts of weak androgens → virilization/precocious sexual development. If deficiency is severe, salt wasting also occurs.

Treatment is to give hydrocortisone 0.6 mg/kg daily in divided doses round the clock to maintain feed back suppression of pituitary. If

salt wasting persists—fludrocortisone 10–20 µg/kg daily may be added.

B. Pharmacotherapy (for nonendocrine diseases)

Systemic as well as topical corticosteroids have one of the widest spectrum of medicinal uses for their antiinflammatory and immunosuppressive properties. Steroids are powerful drugs. They have the potential to cause dramatic improvement in many severe diseases as well as produce equally dramatic adverse effects if not properly used. The use in nonendocrine diseases is empirical and palliative, but may be life saving. The following *general principles* must be observed.

(a) A single dose (even excessive) is not harmful: can be used to tide over mortal crisis, even when benefit is not certain.

(b) Short courses (even high dose) are not likely to be harmful in the absence of contraindications; starting doses can be high in severe illness.

(c) Long-term use is potentially hazardous: keep the duration of treatment and dose to minimum, which is found by trial and error; even partial relief may have to be tolerated.

(d) Initial dose depends on severity of the disease; start with a high dose in severe illness—reduce gradually as symptoms subside, while in mild cases start with the lowest dose and titrate upwards to find the correct dose.

(e) No abrupt withdrawal after a corticoid has been given for > 2 to 3 weeks: may precipitate adrenal insufficiency.

(f) Infection, severe trauma or any stress during corticoid therapy—*increase the dose*.

(g) Use local therapy (cutaneous, inhaled, intranasal, etc) wherever possible.

1. Arthritides

(i) **Rheumatoid arthritis:** Corticosteroids are indicated only in severe cases as adjuvants to NSAIDs when distress and disability persists despite other measures, or when there are systemic manifestations (*see* Ch. 15).

(ii) *Osteoarthritis*: It is generally treated with analgesics and NSAIDs: systemic use of corticoids is rare. Intraarticular injection of a steroid may be used to control an acute exacerbation. Injections may be repeated 2–3 times a year, but have the potential to cause joint destruction.

(iii) *Rheumatic fever*: Corticoids are used only in severe cases with carditis and CHF, because they afford faster relief than aspirin, or in patients not responding to aspirin. Aspirin is given in addition and is continued after corticoids have been withdrawn.

(iv) *Gout*: Corticoids (short course) should only be used in *acute gouty arthritis* when NSAIDs have failed to afford relief and colchicine is not tolerated. Intraarticular injection of a soluble glucocorticoid is preferable to systemic therapy (*see p. 207*).

Though they are uricosuric—use in chronic gout is not recommended.

2. Collagen diseases Most cases of systemic lupus erythematosus, polyarteritis nodosa, dermatomyositis, nephrotic syndrome, glomerulonephritis and related diseases need corticoids. They may be life saving. Therapy is generally started with high doses which are tapered to maintenance dose when remission occurs.

3. Severe allergic reactions Corticoids may be used for short periods in anaphylaxis, angioneurotic edema, urticaria and serum sickness. However, even i.v. injection of steroid takes 1–2 hours to act and is not a substitute for Adr (which acts immediately) in anaphylactic shock and angioedema of larynx. Topical use is made in allergic conjunctivitis and rhinitis.

4. Autoimmune diseases Autoimmune haemolytic anaemia, idiopathic thrombocytopenic purpura, active chronic hepatitis respond to corticoids. Prednisolone 1–2 mg/kg/day is given till remission, followed by gradual withdrawal or low-dose maintenance depending on the response. Remission may also be induced in severe cases of myasthenia gravis, in which their use is adjunctive to neostigmine.

5. Bronchial asthma Early institution of inhaled glucocorticoid therapy is now recommended in most cases needing inhaled β_2 agonists almost daily (*see Ch. 16*). Systemic corticosteroids are used only for:

- Status asthmaticus: give i.v. glucocorticoid; withdraw when emergency is over.
- Acute asthma exacerbation: short-course of high dose oral corticoid, followed by gradual withdrawal.
- Severe chronic asthma not controlled by inhaled steroids and bronchodilators: add low dose prednisolone daily or on alternate days.

6. Other lung diseases Corticosteroids benefit aspiration pneumonia and pulmonary edema from drowning. Given during late pregnancy, corticoids accelerate lung maturation and surfactant production in the foetus and prevent respiratory distress syndrome at birth. Two doses of betamethasone 12 mg i.m. at 24 hour interval may be administered to the mother if premature delivery is contemplated.

7. Infective diseases Administered under effective chemotherapeutic cover, corticosteroids are indicated only in serious infective diseases to tideover crisis or to prevent complications. They are indicated in conditions like severe forms of tuberculosis, severe lepra reaction, certain forms of bacterial meningitis and *Pneumocystis carinii* pneumonia with hypoxia in AIDS patients.

8. Eye diseases Corticoids are used in a large number of inflammatory ocular diseases—may prevent blindness. Topical instillation as eye drops or ointment is effective in diseases of the anterior chamber—allergic conjunctivitis, iritis, iridocyclitis, keratitis, etc. Ordinarily, steroids should not be used in infective conditions. But if inflammation is severe, they may be applied in conjunction with an effective antibiotic. Steroids are contraindicated in herpes simplex keratitis and in ocular injuries. Posterior segment afflictions like retinitis, optic neuritis, uveitis require systemic steroid therapy. Retrobulbar injection is occasionally given to avoid systemic side effects.

9. Skin diseases (see Ch. 64) Topical corticosteroids are widely employed and are highly effective in many eczematous skin diseases. Systemic therapy is needed (may be life-saving) in pemphigus vulgaris, exfoliative dermatitis, Stevens-Johnson syndrome and other severe afflictions.

10. Intestinal diseases Ulcerative colitis, Crohn's disease, coeliac disease are chronic inflammatory intestinal diseases with remissions and exacerbations. Corticoids are indicated during acute phases—may be used orally or as retention enema, if not responding to 5-amino salicylic acid compounds and other measures. Some advocate small maintenance doses to prevent relapses.

11. Cerebral edema due to tumours, tubercular meningitis, etc., responds to corticoids. Dexamethasone are preferred because they do not have Na⁺ retaining activity. Their value in traumatic and poststroke cerebral edema is questionable. Large doses given soon after spinal injury may reduce the resulting neurological sequelae.

A short course of 2–4 week oral prednisolone can hasten recovery from Bell's palsy and acute exacerbation of multiple sclerosis. In the latter, methyl prednisolone 1 g i.v. daily for 2–3 days may be given in the beginning.

Neurocysticercosis: when albendazole/praziquantel is used to kill cysticerci, prednisolone 40 mg/day or equivalent is given for 2–4 weeks to suppress the reaction to the dying larvae.

12. Malignancies Corticoids are an essential component of combined chemotherapy of acute lymphatic leukaemia, Hodgkin's and other lymphomas, because of their marked lympholytic action in these conditions. They have a secondary place in hormone responsive breast carcinoma—act probably by causing pituitary-adrenal suppression—decreasing production of adrenal androgens which are converted to estrogens in the body (see Ch. 62).

Corticoids also afford symptomatic relief in other advanced malignancies by improving appetite and controlling secondary hypercalcaemia.

For the latter, however, bisphosphonates are more effective and have superseded corticosteroids.

13. Organ transplantation and skin allograft High dose corticoids are given along with other immunosuppressants to prevent rejection reaction followed by low maintenance doses (see Ch. 63).

14. Septic shock High-dose corticosteroid therapy for septic shock has been abandoned, because it worsens the outcome. However, many such patients have relative adrenal insufficiency. Recent studies have documented beneficial effects of low-dose (hydrocortisone 100 mg TDS i.v. infusion for 5–7 days) therapy in patients who are adrenal deficient and require vasopressor drug despite adequate fluid replacement.

15. Thyroid storm Many patients in thyroid storm have concomitant adrenal insufficiency. Moreover, corticosteroids reduce peripheral T₄ to T₃ conversion. Hydrocortisone 100 mg TDS may improve outcome.

16. To test adrenal-pituitary axis function Dexamethasone suppresses adrenal-pituitary axis at doses which do not contribute to steroid metabolites in urine—responsiveness of the axis can be tested by measuring daily urinary steroid metabolite excretion.

ADVERSE EFFECTS

These are extension of the pharmacological action occurring with prolonged therapy, and are a great limitation to the use of corticoids in chronic diseases.

A. Mineralocorticoid Sodium and water retention, edema, hypokalaemic alkalosis and a progressive rise in BP. These are now rare due to availability of highly selective glucocorticoids.

Gradual rise in BP occurs due to excess glucocorticoid action as well.

B. Glucocorticoid

1. Cushing's habitus: characteristic appearance with rounded face, narrow mouth, supraclavicular hump, obesity of trunk with relatively thin limbs.

2. Fragile skin, purple striae—typically on thighs and lower abdomen, easy bruising, telangiectasis, hirsutism. Cutaneous atrophy occurs with topical use also.
3. Hyperglycaemia, may be glycosuria, precipitation of diabetes.
4. Muscular weakness: proximal (shoulder, arm, pelvis, thigh) myopathy occurs occasionally—withdraw corticoids.
5. Susceptibility to infection: this is nonspecific; latent tuberculosis may flare; opportunistic infections with low grade pathogens (*Candida*, etc.).
6. Delayed healing: of wounds and surgical incisions.
7. Peptic ulceration: risk is doubled; bleeding and silent perforation of ulcers may occur. Dyspeptic symptoms are frequent with high dose therapy.
8. Osteoporosis: Specially involving vertebrae and other flat spongy bones. Compression fractures of vertebrae and spontaneous fracture of long bones can occur, especially in the elderly. Radiological evidence of osteoporosis is an indication for withdrawal of corticoid therapy. Corticosteroid induced osteoporosis can be prevented/arrested by calcium supplements + vit D, bisphosphonates and by estrogen/androgen replacement therapy in females/males respectively.

 Avascular necrosis of head of femur, humerus, or knee joint is an occasional abrupt onset complication of high dose corticosteroid therapy.
9. Posterior subcapsular cataract may develop after several years of use, especially in children.
10. Glaucoma: may develop in susceptible individuals after prolonged topical therapy.
11. Growth retardation: in children occurs even with small doses if given for long periods. Large doses do inhibit GH secretion, but this may in addition be a direct cellular effect of corticoids.
12. Foetal abnormalities: Cleft palate and other defects are produced in animals, but have not been encountered on clinical use in pregnant women. The risk of abortion, still-birth or neonatal death is not increased, but intrauterine growth retardation can occur after prolonged therapy, and neurological/behavioral disturbances in the offspring are feared. Prednisolone appears safer than dexamethasone, because it is metabolized by placenta, reducing foetal exposure.

 Prolonged corticosteroid therapy during pregnancy increases the risk of gestational diabetes, pregnancy induced hypertension and preeclampsia.
13. Psychiatric disturbances: mild euphoria frequently accompanies high dose steroid treatment. This may rarely progress to manic psychosis. Nervousness, decreased sleep and mood changes are noted by few. Rarely a depressive illness occurs after long-term use.
14. Suppression of hypothalamo-pituitary-adrenal (HPA) axis: occurs depending both on dose and duration of therapy. In time, adrenal cortex atrophies and stoppage of exogenous steroid precipitates a withdrawal syndrome—malaise, fever, anorexia, nausea, postural hypotension, weakness, pain in muscles and joints and reactivation of the disease. Subjected to stress, these patients may go into acute adrenal insufficiency.

 Any patient who has received > 20–25 mg/day hydrocortisone or equivalent for longer than 2–3 weeks should be put on a scheme of gradual withdrawal: 20 mg hydrocortisone/day reduction every week and then still smaller fractions once this level has been achieved. Such patients may need protection with steroids if a stressful situation develops up to one year after withdrawal. Administration of ACTH during withdrawal does not hasten recovery because it has been found that adrenals recover earlier than pituitary and hypothalamus.

If a patient on steroid therapy develops an infection—the *steroid should not be discontinued* despite its propensity to weaken host defence. Rather, the dose may have to be increased to meet the stress of infection.

Measures that minimise HPA axis suppression are:

- (a) Use shorter acting steroids (hydrocortisone, prednisolone) at the lowest possible dose.
- (b) Use steroids for the shortest period of time possible.
- (c) Give the entire daily dose at one time in the morning.
- (d) Switch to alternate-day therapy if possible.

It has been found that moderate dose of a short acting steroid (e.g. prednisolone) given at 48 hr interval did not cause HPA suppression, whereas the same total amount given in 4 divided 12 hourly doses produced marked HPA suppression. Alternate-day therapy also resulted in less immunological suppression—lower risk of infection. The longer acting steroids (dexamethasone, etc.) are not suitable for alternate-day therapy. Only problem with alternate-day therapy is that many steroid dependent patients are incapacitated on the 'off day'.

- (e) If appropriate, use local (dermal, inhaled, ocular, nasal, rectal, intrasynovial) preparations of a steroid with poor systemic availability (beclomethasone, triamcinolone acetonide, fluticasone, etc.)

CONTRAINDICATIONS

The following diseases are aggravated by corticosteroids. Since steroids may have to be used as

a life-saving measure, all of these are relative contraindications:

1. Peptic ulcer
2. Diabetes mellitus
3. Hypertension
4. Viral and fungal infections
5. Tuberculosis and other infections
6. Osteoporosis
7. Herpes simplex keratitis
8. Psychosis
9. Epilepsy
10. CHF
11. Renal failure

Combination of any drug with corticosteroids in fixed dose formulation for internal use is banned.

Metyrapone Inhibits 11- β hydroxylase in adrenal cortex and prevents synthesis of hydrocortisone \rightarrow increased ACTH release \rightarrow increased excretion of 11-desoxycortisol in urine. Thus, it is used to test the responsiveness of pituitary and its ACTH producing capacity.

Aminoglutethimide, trilostane and high doses of the anti-fungal drug **Ketoconazole** also inhibit steroidogenic enzymes—occasionally used to treat Cushing's disease. Ketoconazole reduces gonadal steroid synthesis as well.

Glucocorticoid antagonist The antiprogestin **mifepristone** (see p. 310) acts as a glucocorticoid receptor antagonist as well. In Cushing's syndrome, it can suppress the manifestations of corticosteroid excess, but blockade of feedback ACTH inhibition leads to oversecretion of ACTH \rightarrow more hydrocortisone is produced, which tends to annul the GR blocking action of mifepristone. It is indicated only for inoperable cases of adrenal carcinoma and in patients with ectopic ACTH secretion.

CHAPTER 21

Androgens and Drugs for Erectile Dysfunction

ANDROGENS (Male Sex Hormones)

These are substances which cause development of secondary sex characters in the castrated male. That testes are responsible for the male characters is known since prehistoric times. Its endocrine function was established by Berthold in 1849. *Testosterone* was isolated, its structure worked out and synthesized by the year 1935.

Natural androgens Testes of adult male produce 5–12 mg of *testosterone* daily, a part of which is converted in extraglandular tissues to the more active *dihydrotestosterone*; by the enzyme steroid 5 α -reductase; cholesterol is the starting material and the same pathway depicted in Fig. 20.1 is utilized. Adrenal cortex produces small quantities of *dehydroepiandrosterone* and *androstenedione* which are called 'weak androgens' (potency 1/20 to 1/30), but are in fact inactive as such and derive their weak activity from partial conversion to testosterone by peripheral tissues. Adrenals themselves do not produce significant quantity of testosterone. In women ovary produces small quantity of testosterone; this together with that derived indirectly from adrenals amounts to 0.25–0.5 mg/day.

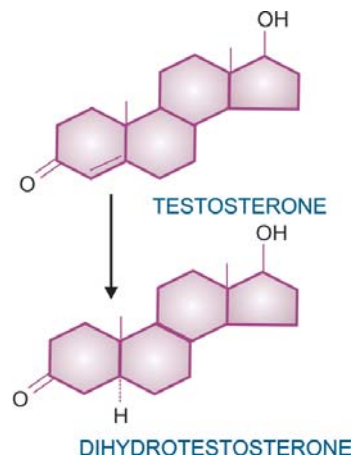

Androsterone It is a metabolite of testosterone which is excreted in urine. It has 1/10 the activity of testosterone.

Synthetic androgens *Methyltestosterone* and *fluoxymesterone* are 17-alkyl substituted derivatives of testosterone which are orally active because of resistance to first pass metabolism, but have submaximal androgenic efficacy and potential to cause cholestatic jaundice. Other orally active compounds are *testosterone undecanoate* which administered as oily solution is absorbed through lymphatics bypassing the liver, and

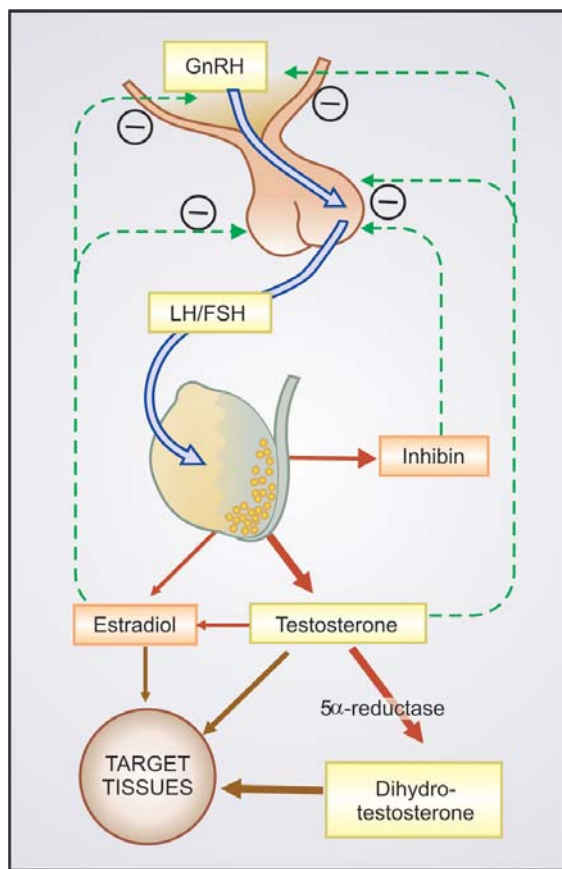

Fig. 21.1: Regulation and production of sex steroids in the male. In liver and many target cells 5α -reductase enzyme converts testosterone to the more potent androgen dihydrotestosterone. The aromatase enzyme in testes, liver and adipose tissue converts androgen to estrogen which exert minor action, but probably is important for feedback inhibition of gonadotropin.

mesterolone. A number of lipid-soluble esters of testosterone have been produced, suitable for injection in oily vehicle, from which they are absorbed slowly and exert prolonged action after deesterification in the body.

Regulation of secretion

Testosterone is secreted by the interstitial (Leydig) cells of the testes under the influence of pulsatile secretion of LH from pituitary. FSH is mainly responsible for promotion of spermatogenesis in

tubular (Sertoli) cells. The mediator of feedback relationship with pituitary is uncertain. While relatively high concentration of testosterone inhibits LH secretion and in time causes atrophy of interstitial cells, it has only weak inhibitory action on FSH secretion. Estrogens are more potent inhibitors of Gn secretion even in males and it is believed that the small amount of estradiol produced by testes and that resulting from conversion of testosterone to estradiol plays a role in feedback inhibition. *Inhibin*, (a protein) produced by Sertoli cells, has strong FSH inhibitory action and may be mediating the feedback inhibition. Testosterone and estradiol act on hypothalamus to reduce GnRH as well as act directly on pituitary. The plasma level of testosterone in adult males ranges from 0.3 to 1 $\mu\text{g}/\text{dl}$ and in females from 20 to 60 ng/dl .

ACTIONS

1. Sex organs and secondary sex characters (Androgenic)

Testosterone is responsible for all the changes that occur in a boy at puberty:

Growth of genitals—penis, scrotum, seminal vesicles, prostate.

Growth of hair—pubic, axillary, beard, moustache, body hair and male pattern of its distribution. Thickening of skin which becomes greasy due to proliferation and increased activity of sebaceous glands—especially on the face—frequently the duct gets blocked, infection occurs resulting in acne. Subcutaneous fat is lost and veins look prominent.

Larynx grows and voice deepens.

Behavioral effects are—increased physical vigour, aggressiveness, penile erections. Male libido appears to be activated by testosterone directly as well as by estradiol produced from testosterone. Testosterone is also important for the intrauterine development of the male phenotype; relatively large amounts are produced by the foetal testes during the first half of intrauterine life.

2. Testes Moderately large doses cause testicular atrophy by inhibiting Gn secretion from

pituitary. Still larger doses have a direct sustaining effect and atrophy is less marked. Testosterone is needed for normal spermatogenesis and maturation of spermatozoa. High concentration of testosterone attained locally in the spermatogenic tubules by diffusion from the neighbouring Leydig cells stimulates spermatogenesis.

3. Skeleton and skeletal muscles (Anabolic)

Testosterone is responsible for the pubertal spurt of growth in boys and to a smaller extent in girls. There is rapid bone growth, both in thickness as well as in length. After puberty, the epiphyses fuse and linear growth comes to a halt. There is evidence now that estradiol produced from testosterone, and not testosterone itself, is responsible for fusion of epiphyses in boys as well as girls. Moreover, estradiol appears to supplement the effect of testosterone on bone mineralization. Testosterone also promotes muscle building, especially if aided by exercise. There is accretion of nitrogen, minerals (Na, K, Ca, P, S) and water—body weight increases rapidly, more protoplasm is built. Appetite is improved and a sense of well being prevails. Testosterone given to patients prone to salt and water retention may develop edema.

4. Erythropoiesis Testosterone also accelerates erythropoiesis by increasing erythropoietin production and probably direct action on haeme synthesis.

Mechanism of action

Testosterone can largely be regarded as the circulating prohormone. In most target cells, the 4–5

double bond is reduced → *dihydrotestosterone*—which binds more avidly with the cytoplasmic receptor, and this complex is more active than testosterone-receptor complex in combining with DNA. After combining with androgen response elements of the target genes, DNA transcription is enhanced and effects are expressed through modification of protein synthesis.

The 5 α -reductase enzyme exists in two isoforms: 5 α -reductase-1 and 5 α -reductase-2. The genital skin of both sexes and urogenital tract of male contains 5 α -reductase-2 which is more sensitive to inhibition by finasteride. Genetic deficiency of this isoenzyme causes male pseudohermaphroditism because of inability of male genitalia to produce the active hormone dihydrotestosterone from circulating testosterone. 5 α -reductase-1 has a wider distribution in the body including nongenital skin and liver; it is less inhibited by finasteride.

Testosterone itself appears to be the active hormone at certain sites—foetal genital rudiments, hypothalamus/pituitary site involved in feedback regulation, erythropoietic cells and spermatogenic cells in testes.

PHARMACOKINETICS

Testosterone is inactive orally due to high first pass metabolism in liver. The duration of action after i.m. injection is also very short, therefore, slowly absorbed esters of testosterone are used by this route—are hydrolysed to the active free form. Testosterone in circulation is 98% bound to sex hormone binding globulin (SHBG) and to albumin.

The major metabolic products of testosterone are androsterone and etiocholanolone which are excreted in urine, mostly as conjugates with

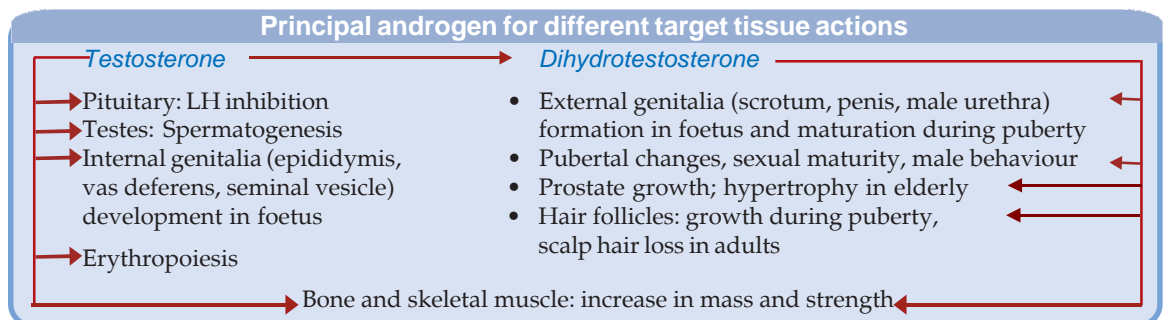

glucuronic acid and sulfate. Small quantities of estradiol are also produced from testosterone by aromatization of A ring in extraglandular tissues (liver, fat, hypothalamus). Plasma $t_{1/2}$ of testosterone is 10–20 min.

Methyltestosterone and fluoxymesterone are metabolized slowly and have a longer duration of action. Estrogens are not produced from fluoxymesterone and dihydrotestosterone.

Preparations and Dose

1. Testosterone (free): 25 mg i.m. daily to twice weekly; **AQUAVIRON 25 mg in 1 ml inj.**
2. Testosterone propionate: 25–50 mg i.m. daily to twice weekly; **TESTOVIRON, PARENDREN, TESTANON 25, 50 mg/ml inj.**
3. **TESTOVIRON DEPOT 100:** testo. propionate 25 mg + testo. enanthate 100 mg in 1 ml amp; 1 ml i.m. weekly.
4. **TESTOVIRON DEPOT 250:** testo. propionate 250 mg + testo. enanthate 250 mg in 1 ml amp; i.m. every 2–4 weeks.
5. **SUSTANON '100':** testo. propionate 20 mg + testo. phenyl propionate 40 mg + testo. isocaproate 40 mg in 1 ml amp; 1 ml i.m. every 2–3 weeks.
6. **SUSTANON '250':** testo. propionate 30 mg + testo. phenylpropionate 60 mg + testo. isocaproate 60 mg + testo. decanoate 100 mg in 1 ml amp; 1 ml i.m. every 3–4 weeks.
7. **NUVIR:** Testosterone undecanoate 40 mg cap, 1–3 cap daily for male hypogonadism, osteoporosis.
8. Mesterolone: Causes less feedback inhibition of Gn secretion and spermatogenesis; **PROVIRONUM, MESTILON 25 mg tab; 1–3 tab daily for androgen deficiency.**

Transdermal androgen Recently delivery of androgen across skin has been achieved by developing suitable solvents and absorption facilitators. By cutaneous delivery, testosterone/dihydrotestosterone circumvent hepatic first pass metabolism; uniform blood levels are produced round the clock. A gel formulation has been marketed for once daily application in hypogonadism and impotence. **ANDRACTIM: Dihydrotestosterone 25 mg/g gel (100 g tube);** 5–10 g gel to be applied over nonscrotal skin once daily.

Fixed dose combinations of testosterone with yohimbine, strychnine and vitamins are banned in India.

SIDE EFFECTS

1. Virilization, excess body hair and menstrual irregularities in women; many effects, e.g. voice change may be permanent after prolonged therapy.

2. Acne: in males and females.
3. Frequent, sustained and often painful erections in males in the beginning of therapy, subside spontaneously after sometime.
4. Oligozoospermia with moderate doses given for a few weeks.
5. Precocious puberty and shortening of stature due to early closure of epiphysis—if given to children for more than a few weeks.
6. Edema: especially when large doses are used in patients with heart or kidney disease. It is rare with the doses used for hypogonadism.
7. Cholestatic jaundice: occurs with methyltestosterone and other 17-alkyl substituted derivatives (fluoxymesterone and some anabolic steroids like oxymetholone, stanozolol) in a dose dependent manner, but not with parenterally used esters of testosterone. For this reason, the latter are preferred, especially for prolonged therapy. However, jaundice is reversible on discontinuation.
8. Hepatic carcinoma: incidence is higher in patients who have received long-term methyltestosterone or other oral androgens.
9. Gynaecomastia: may occur, especially in children and in patients with liver disease. This is due to peripheral conversion of testosterone to estrogens. Dihydrotestosterone does not cause gynaecomastia because it is not converted to estradiol.
10. Lowering of HDL and rise in LDL levels, especially with 17 α -alkylated analogues.

Contraindications Androgens are contraindicated in carcinoma of prostate and male breast, liver and kidney disease and during pregnancy (masculinization of female foetus). They should be used cautiously in patients who may be adversely affected by fluid retention—such as CHF, epilepsy, migraine.

USES

1. **Testicular failure** It may be primary—in children, resulting in delayed puberty. Treatment with parenteral testosterone esters or transdermal

testosterone/dihydrotestosterone in courses of 4–6 months at a time is highly satisfactory. Secondary testicular failure occurring later in life manifests mainly as loss of libido and impotence. These are corrected by androgen treatment. However, impotence due to psychological and other factors, and not testosterone deficiency, does not respond.

2. Hypopituitarism Hypogonadism is one of the features of hypopituitarism. Androgens are added at the time of puberty to other hormonal replacement.

3. AIDS related muscle wasting Testosterone therapy has been shown to improve weakness and muscle wasting in AIDS patients with low testosterone levels.

4. Hereditary angioneurotic edema This is a genetic disorder; attacks can be prevented by 17 α -alkylated androgens (methyltestosterone, stanozolol, danazol) but not by testosterone. They act by increasing synthesis of complement (C1) esterase inhibitor.

5. Ageing Because testosterone levels decline in old age, it has been administered to elderly males and found to improve bone mineralization and muscle mass. However, safety of such therapy in terms of metabolic, cardiovascular and prostatic complications is not known.

The use of androgens in cancer breast is rare as is their addition to postmenopausal hormone replacement.

ANABOLIC STEROIDS

These are synthetic androgens with supposedly higher anabolic and lower androgenic activity. Drugs are *Nandrolone*, *Oxymetholone*, *Stanozolol* and *Methandienone*.

The anabolic : androgenic activity ratio is determined by injecting the drug in castrated rats and measuring the increase in weight of levator ani muscles to that of ventral prostate. The anabolic : androgenic ratio of testosterone is considered as 1; The anabolic selectivity of these steroids is modest with ratios between 1 to 3 in

the rat model, and probably still lower in man. The anabolic effects are similar to that of testosterone and are mediated through the same receptor as the androgenic effects; for all practical purposes, they are androgens.

Preparations and dose

1. Methandienone: 2–5 mg OD–BD oral; children 0.04 mg/kg/day, 25 mg i.m. weekly; **ANABOLEX 2, 5 mg tab, 2 mg/ml drops, 25 mg/ml inj.**
2. Nandrolone phenyl propionate: 10–50 mg; children 10 mg; i.m. once or twice weekly; **DURABOLIN 10, 25 mg/ml inj.**
3. Nandrolone decanoate: 25–100 mg i.m. every 3 weeks, **DECADURABOLIN, 25, 100 mg/ml inj.**
4. Oxymetholone: 5–10 mg, children 0.1 mg/kg, OD; **ADROYD 5 mg tab.**
5. Stanozolol: 2–6 mg/day, **MENABOL, NEURABOL, TANZOL 2 mg tab.**

Combination of anabolic steroids with any other drug is banned in India.

Side effects Anabolic steroids were developed with the idea of avoiding the virilizing side effects of androgens while retaining the anabolic effects. But the same side effect profile applies to these compounds.

The 17-alkyl substituted compounds oxymetholone, stanozolol, can produce jaundice and worsen lipid profile.

Contraindications are same as for testosterone.

Uses

1. Catabolic states Acute illness, severe trauma, major surgery, etc. are associated with negative N balance. Anabolic steroids can reduce N₂ loss over short periods, but long-term benefits are questionable. They may cause a transient response in the elderly, under-nourished or debilitated individuals, but controlled studies have failed to demonstrate a difference in the total weight gained. However, short-term use may be made during convalescence for the sense of wellbeing and improvement in appetite caused by such treatment.

2. Renal insufficiency Anabolic steroids reduce urea production—frequency of dialysis needed in renal failure

can decrease. However, because this effect is short lasting, only transient improvement is seen in chronic renal failure.

3. **Osteoporosis** In elderly males and that occurring due to prolonged immobilization may respond to anabolic steroids, but bisphosphonates are preferred now.

4. **Suboptimal growth in boys** Use is controversial; somatropin is a better option. Brief spurts in linear growth can be induced by anabolic steroids, but this probably does not make a difference in the final stature, except in hypogonadism. Use for more than 6 months is not recommended—premature closure of epiphyses and shortening of ultimate stature may result.

5. **Hypoplastic, haemolytic and malignancy associated anaemia** Majority of properly selected patients respond with an increase in RBC count and Hb%. However, erythropoietin therapy is more effective.

6. **To enhance physical ability in athletes** When administered during the period of training, anabolic steroids can increase the strength of exercised muscles. However, effects are transient and contrary to popular belief, there is no scientific evidence that performance is enhanced except in women. This is considered an abuse and anabolic steroids are included in the list of 'dope test' performed on athletes before competitive games.

IMPEDED ANDROGENS / ANTIANDROGENS

Superactive GnRH agonists are the most potent inhibitors of gonadal function. Administered over a few days, they markedly inhibit LH and FSH release, resulting in loss of androgen secretion.

Ketoconazole at high doses inhibits steroidogenic CYP 450 enzymes: testosterone as well as adrenal steroid production is interfered. Plasma protein binding of testosterone is also reduced. However, toxicity of high doses precludes its use to suppress androgens.

Cimetidine and **spironolactone** have weak antiandrogenic action which manifests as side effects. **Progesterone** has weak androgen receptor blocking action.

Drugs that have been clinically used to modify androgen action are:

Danazol It is an orally active ethisterone derivative having weak androgenic, anabolic and progestational activities. Though labelled as an impeded/attenuated androgen, because it binds to the androgen receptor and induces some androgen-specific mRNA production, the most prominent action is suppression of Gn secretion from pituitary in both men and women → inhibition of testicular/ovarian function. It

suppresses gonadal function directly as well by inhibiting steroidogenic enzymes. Endometrial atrophy occurs over few a weeks and amenorrhoea may supervene. Danazol is metabolized with a $t_{1/2}$ of 12–18 hours.

Dose: 200–600 mg/day; **DANAZOL**, **LADOGAL**, **DANOGEN**, **GONABLOK** 50, 100, 200 mg cap.

Uses are:

1. **Endometriosis** Danazol causes marked improvement in ~75% cases. Relief of dysmenorrhoea is prompt. Pain, dyspareunia and excessive bleeding regress slowly. After a 3–6 month course, prolonged relief occurs in over half of the patients. Severe cases derive incomplete relief. Androgenic side effects are the limiting feature, because of which use has declined.

2. **Menorrhagia** It reduces menstrual blood loss. Usually complete amenorrhoea does not occur with 200 mg/day. When withdrawn after 3 months therapy—blood loss continues to be smaller than previously in many cases.

3. **Fibrocystic breast disease** (chronic cystic mastitis): 3–6 months treatment causes improvement with decrease in pain, nodularity and engorgement in 75% cases.

4. **Hereditary angioneurotic edema** (see above)

5. **Infertility** Withdrawal of danazol after 3 month treatment results in resumption of ovulation and rebound fertility in some women; pregnancy rate is increased in the subsequent 6 months.

Side effects are frequent and dose related.

Complete amenorrhoea occurs with higher doses as long as drug is given. Occasional spotting may be seen in some.

Androgenic side effects are acne, hirsutism, decreased breast size, deepening of voice, edema and weight gain. Loss of libido in men, hot flashes in women and night sweats, muscle cramps, g.i. upset, elevation of hepatic enzymes are the other side effects.

Cyproterone acetate It is chemically related to progesterone—has progestational activity which inhibits LH release augmenting the direct antiandrogenic action. More importantly, it competes with dihydrotestosterone for the

intracellular androgen receptor and inhibits its binding. Larger doses prevent pubertal changes while in the adult libido and androgenic anabolism are lost, gynaecomastia can occur.

Cyproterone has been clinically tested in precocious puberty in boys, inappropriate sexual behaviour in men, acne and virilization in women, but is not marketed.

Flutamide A nonsteroidal drug having specific antiandrogenic, but no other hormonal activity. Its active metabolite 2-hydroxyflutamide competitively blocks androgen action on accessory sex organs as well as on pituitary—increases LH secretion by blocking feedback inhibition. Plasma testosterone levels increase in males which partially overcome the direct antiandrogenic action. Palliative effect may occur in metastatic prostatic carcinoma, but it is better used in conjunction with a GnRH agonist (to suppress LH and testosterone secretion) or after castration to block residual action of adrenal androgens. Along with oral contraceptives it has been tried in female hirsutism. Though gynaecomastia and breast tenderness occur frequently, libido and potency are largely preserved. Reports of liver damage have restricted its use.

Dose: 250 mg TDS; **PROSTAMID, FLUTIDE, CYTOMID** 250 mg tab.

Bicalutamide This more potent and longer acting congener of flutamide is suitable for once daily administration in metastatic carcinoma of prostate. When used along with a GnRH agonist or castration, 50 mg OD affords marked relief in bone pain and other symptoms due to the metastasis. Side effects are hot flashes, chills, edema and loose stools, but it is better tolerated and less hepatotoxic than flutamide. Elevation of hepatic transaminase above twice normal is a signal for stopping the drug.

BIPROSTA, CALUTIDE, TABI 50 mg tab.

5 α -REDUCTASE INHIBITOR

Finasteride A competitive inhibitor of the enzyme 5 α -reductase which converts testosterone into more active dihydrotestosterone responsible for androgen action in many tissues including prostate gland and hair follicles. It is relatively

selective for 5 α -reductase type 2 isoenzyme which predominates in male urogenital tract. Circulating and prostatic dihydrotestosterone concentration are lowered but plasma LH and testosterone levels are unchanged because testosterone itself mediates feedback pituitary LH inhibition.

Treatment with finasteride has resulted in decreased prostate size and increased peak urinary flow rate in ~50% patients with symptomatic benign hypertrophy of prostate (BHP). The beneficial effects are typically delayed needing ~6 months for maximum symptomatic relief. Patients with large prostate (volume > 40 ml) obtain greater relief than those with smaller gland; but it is the only drug which can retard disease progression.

Withdrawal of the drug results in regrowth of prostate, but with continued therapy benefit is maintained for 3 years or more. The relief of obstructive symptoms, however, is less marked compared to surgery and α_1 blockers (*see* p. 136). It primarily reduces the static component of obstruction, while α_1 blockers overcome the dynamic component. Concurrent treatment with both produces greater symptomatic relief.

Finasteride has also been found effective in male pattern baldness. In such subjects it promotes hair growth and prevents further hair loss. Observable response takes 3 or more months therapy and benefit is reversed within 1 year of treatment cessation. However, 20–30% cases do not improve.

Finasteride is effective orally, extensively metabolized in liver—metabolites are excreted in urine and faeces; plasma $t_{1/2}$ 4–8 hours (elderly 6–15 hours). It is well tolerated by most patients; side effects are decreased libido, impotence and decreased volume of ejaculate (each in 3–4% patients), skin rashes, swelling of lips.

Dose for BHP 5 mg OD, review after 6 months; for male pattern baldness 1 mg/day.

FINCAR, FINAST, FINARA 5 mg tab; **FINPECIA, ASTIFINE** 1 mg tab.

Dutasteride This newer congener of finasteride inhibits both type 1 and type 2 5 α -reductase and reduces dihydrotestosterone levels. It is

metabolized by CYP3A4 and is very long-acting ($t_{1/2}$ is ~ 9 weeks). It is approved for use in BHP and is being tested in baldness and for prevention of prostate carcinoma. Interactions with CYP3A4 inducers and inhibitors are possible.

Dose: 0.5 mg OD; DUPROST, DURIZE 0.5 mg tab.

DRUGS FOR ERECTILE DYSFUNCTION

Erectile dysfunction (ED) refers to the inability of men to attain and maintain an erect penis with sufficient rigidity to allow sexual intercourse. It occurs mainly past middle-age and is common after the age of 65 years. A variety of vascular, neurogenic, hormonal, pharmacologic or psychogenic causes may underlie the disorder.

Sexual arousal increases blood flow to the penis and relaxes the cavernosal sinusoids so that they fill up with blood, making the penis rigid, elongated and erect. Nitric oxide (NO) released from parasympathetic nonadrenergic noncholinergic (NANC) nerves and vascular endothelium is the major transmitter causing relaxation of smooth muscle in corpus cavernosum and blood vessels supplying it; ACh and PGs also play a role. A variety of mechanical/prosthetic devices and surgery have been used for ED, but drug therapy has made a big impact recently.

1. Androgens

Parenteral testosterone esters or transdermal testosterone therapy is effective only when androgen deficiency is demonstrated to be responsible for the loss of libido and ED.

2. Phosphodiesterase-5 (PDE-5) inhibitors

Nitric oxide causes smooth muscle relaxation by generating cGMP intracellularly which then promotes dephosphorylation of myosin light chain kinase (MLCK) so that myosin fails to interact with actin (see Fig. 39.3). Inhibition of PDE-5, the cGMP degrading isoenzyme in cavernosal and vascular smooth muscle, results in accumulation of cGMP and marked potentiation of NO action. *Sildenafil*, *Tadalafil* and *vardenafile* are selective PDE-5 inhibitors developed

in the past decade and found effective in a majority of patients with ED.

Sildenafil: It is an orally active drug, marketed in the USA in 1998 and 2 years later in India, for treatment of ED. It became an instant hit, but the enthusiasm has passed off now. Sildenafil acts by selectively inhibiting PDE-5 and enhancing NO action in corpus cavernosum. Penile tumescence during sexual arousal is improved, but it has no effect on penile tumescence in the absence of sexual activity. It does not cause priapism in most recipients.

Oral bioavailability of sildenafil is ~40%, peak blood levels are attained in 1–2 hr; it is metabolized largely by CYP3A4 and an active metabolite is produced; $t_{1/2}$ in men <65 years averages 4 hours. It is recommended in a dose of 50 mg (for men > 65 years 25 mg), if not effective then 100 mg 1 hour before intercourse. Duration and degree of penile erection is increased in 74–82% men with ED including diabetic neuropathy cases. Over 20 controlled trials involving >3000 men have demonstrated improved erection with sildenafil compared to placebo. However, sildenafil is ineffective in men who have lost libido or when ED is due to cord injury or damaged nervi eregantis.

Since NO is an important regulator of pulmonary vascular resistance, PDE-5 inhibitors lower pulmonary arterial pressure. Sildenafil is more selective for pulmonary circulation than vardenafil, and is the only PDE-5 inhibitor shown to improve arterial oxygenation in pulmonary hypertension. It has now become the drug of choice for this condition.

Adverse effects Side effects are mainly due to PDE-5 inhibition related vasodilatation—headache, nasal congestion, dizziness, flushing and fall in BP, loose motions. Sildenafil, in addition, weakly inhibits the isoenzyme PDE-6 which is involved in photoreceptor transduction in the retina. As such, impairment of colour vision, especially blue-green discrimination, occurs in some recipients. Few cases of sudden loss of vision due to nonarteritic ischaemic optic

neuropathy (NAION) among users of PDE-5 inhibitors have been reported, but no causal relationship has been established.

Sildenafil markedly potentiates the vasodilator action of nitrates; precipitous fall in BP and MI can occur. After >6 million prescriptions dispensed in USA, the FDA received reports of 130 deaths related to sildenafil use by the year 2002. Most deaths occurred in patients with known risk factors, drug interactions or contraindications, and were timed either during or within 4–5 hours of sex. Sildenafil is contraindicated in patients of coronary heart disease and those taking nitrates. Though sildenafil remains effective for <8 hours, it is advised that nitrates be avoided for 24 hours. Caution is advised in presence of liver or kidney disease, peptic ulcer, bleeding disorders. Inhibitors of CYP3A4 like erythromycin, ketoconazole, verapamil, cimetidine potentiate its action. Caution is required also in patients of leukaemia, sickle cell anaemia, myeloma which predispose to priapism.

Sildenafil is erroneously perceived as an aphrodisiac. Men even without ED are going for it to enhance sexual satisfaction.

PENEGRA, CAVERTA, EDEGRA 25, 50, 100 mg tabs.

Tadalafil It is a more potent and longer acting congener of sildenafil; $t_{1/2}$ 18 hours and duration of action 24–36 hours. It is claimed to act faster, though peak plasma levels are attained between 30–120 min. Side effects, risks, contraindications and drug interactions are similar to sildenafil.

Because of its longer lasting action, nitrates are contraindicated for 36–48 hours after tadalafil. Due to its lower affinity for PDE-6, visual disturbances occur less frequently.

Dose: 10 mg at least 30 min before intercourse (max. 20 mg) **MEGALIS, TADARICH 10, 20 mg tabs, MANFORCE 10 mg tab.**

Vardenafil Another congener of sildenafil with similar time-course of action; peak levels in 30–120 min and $t_{1/2}$ 4–5 hours. Side effects, contraindications and interactions are also the same. A weaker inhibition of PDE-6 is claimed, but photosensitivity is reported. It prolongs Q-T interval; should be avoided in hyperkalaemia and in patients with long Q-T or those receiving class IA and class III antiarrhythmics.

Dose: 10 mg (elderly 5 mg), max 20 mg.

3. Papaverine/Phentolamine induced penile erection (PIPE) therapy

Injection of papaverine (3–20 mg) with or without phentolamine (0.5–1 mg) in the corpus cavernosum produces penile tumescence to permit intercourse. However, the procedure requires skill and training. Priapism occurs in 2–15% cases, which if not promptly treated leads to permanent damage. This is reversed by aspirating blood from the corpus cavernosum or by injecting phenylephrine locally. Repeated injections can cause penile fibrosis. Other complications are—local haematoma, infection, paresthesia and penile deviation. In view of the availability of PDE-5 inhibitors, it is rarely used now; only in cases not responding to sildenafil and alprostadil.

4. Prostaglandin E₁

Alprostadil (PGE₁) injected directly into the corpus cavernosum using a fine needle, or introduced into the urethra as a small pellet, produces erection lasting 1–2 hours to permit intercourse. Alprostadil injections are less painful than papaverine, but local tenderness may occur. Penile fibrosis and priapism are rare. It is now the most commonly used drug in patients not responding to PDE-5 inhibitors.



ESTROGENS (Female Sex Hormones)

These are substances which can induce estrus in spayed animals.

It was established in the year 1900 that ovaries control female reproductive function through a hormonal mechanism. Allen and Doisy (1923) found that an alcoholic extract of ovaries was capable of producing estrus and devised a simple bioassay method. The active principle was obtained in pure form in 1929 and soon its chemical structure was worked out.

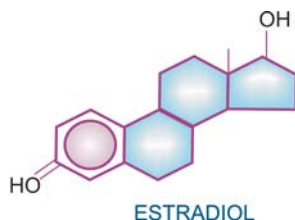

Natural estrogens *Estradiol* is the major estrogen secreted by the ovary. It is synthesized in the graafian follicle, corpus luteum and placenta from cholesterol. Steps depicted on the right hand side in Fig. 20.1 are carried out. Further steps are shown below.



Estradiol is rapidly oxidized in liver to *estrone* which is hydroxylated to form *estriol*. All three are found in blood, but estradiol is the most potent estrogen. Small quantity (2–20 µg/day) of estradiol is derived in human males also from aromatization of testosterone in the testes and extraglandular tissues. In mare, large quantity of *equilin* is produced which has 1/5 estrogenic potency of estradiol.

Synthetic estrogens Natural estrogens are inactive orally and have a short duration of action due to rapid metabolism in liver. To overcome this, synthetic compounds have been produced:

- | | |
|---------------------|--|
| <i>Steroidal</i> | Ethinylestradiol, Mestranol, Tibolone. |
| <i>Nonsteroidal</i> | Diethylstilbestrol (stilbestrol) Hexestrol, Dienestrol |

The nonsteroidal compounds assume a trans configuration as depicted below and sterically resemble natural estrogens.



Regulation of secretion The daily secretion of estrogens in menstruating women varies from 10–100 µg depending on the phase of the cycle. Secretion starts from the graafian follicle under the influence of FSH and the blood level rises gradually during the follicular phase. Due to the modest preovulatory FSH surge, estrogens further rise transiently. After ovulation, corpus luteum continues to secrete estrogens till about two days before menstruation. Estrogens exercise feedback inhibition of FSH (also LH at higher concentrations) by direct action on pituitary as well as through hypothalamus (*see p. 237*).

During pregnancy, placenta secretes large quantities of estrogens, reaching a peak of upto 30 mg/day at term. Their level declines sharply after delivery. In the postmenopausal women, daily production of estrogen has been estimated as 2–10 µg—derived primarily by extraglandular aromatization of adrenal androgens.

ACTIONS

1. Sex organs The estrogens bring about pubertal changes in the female including growth of uterus, fallopian tubes and vagina. Vaginal epithelium gets thickened, stratified and cornified. They are responsible for the proliferation of endometrium in the preovulatory phase and it is only in concert with estrogens that progesterone brings about secretory changes.

In the absence of progesterone (anovulatory cycles) withdrawal of estrogens alone produces menstruation. If modest doses of estrogen are given continuously without added progesterone—menstruation is delayed but breakthrough

bleeding occurs at irregular intervals. However, the normal event which triggers menstruation is progesterone withdrawal—such bleeding cannot be suppressed even by high doses of estrogens.

Estrogens increase rhythmic contractions of the fallopian tubes and uterus, and induce a watery alkaline secretion from the cervix—favourable to sperm penetration. They also sensitize the uterus to oxytocin. Deficiency of estrogens is responsible for atrophic changes in the female reproductive tract that occur after menopause.

2. Secondary sex characters Estrogens produced at puberty cause growth of breasts—proliferation of ducts and stroma, accumulation of fat. The pubic and axillary hair appear, feminine body contours and behaviour are influenced.

Acne is common in girls at puberty as it is in boys—probably due to small amount of androgens produced simultaneously; administration of estrogens to suppress pituitary-gonadal axis causes regression of acne.

3. Metabolic effects Estrogens are anabolic, similar to but weaker than testosterone. Therefore, small amount of androgen may be contributing to the pubertal growth spurt even in females. Continued action of estrogen promotes fusion of epiphyses.

Estrogen is important in maintaining bone mass primarily by retarding bone resorption. Osteoclast pit formation is inhibited and there is increased expression of bone matrix proteins such as osteonectin, osteocalcin, collagen and alkaline phosphatase. It promotes positive calcium balance, partly by inducing renal hydroxylase enzyme which generates active form of Vit D₃.

Both osteoblasts and osteoclasts express estrogen receptors (ERs). The major action of estrogens is to reduce maturation and activity of osteoclasts by modifying regulatory cytokine signals from osteoblasts. The direct action on osteoclasts is to accelerate their apoptosis.

Pharmacological doses of estrogens can cause mild salt and water retention—edema occurs in predisposed patients, but it can be treated with diuretics. BP may rise after prolonged use. Combination contraceptives containing higher

doses of estrogens and progestins impair glucose tolerance: normal blood sugar is not affected but diabetes may be precipitated or its control vitiated. However, amounts used for HRT and low dose contraception do not affect carbohydrate metabolism.

Estrogens decrease plasma LDL cholesterol while HDL and triglyceride levels are raised. The raised HDL : LDL ratio is probably responsible for rarity of atherosclerosis in premenopausal women. However, blood coagulability is increased due to induction of synthesis of clotting factors (factors II, VII, IX and X). Fibrinolytic activity in plasma also tends to increase. Estrogens have been shown to induce nitric oxide synthase in vascular endothelium. The increased availability of nitric oxide could promote vasodilatation. They increase lithogenicity of bile by increasing cholesterol secretion and reducing bile salt secretion. Plasma levels of sex hormone binding globulin (SHBG), thyroxine binding globulin (TBG) and cortisol binding globulin (CBG) are elevated—but without any change in hormonal status.

Mechanism of action

Estrogens bind to specific nuclear receptors in target cells and produce effects by regulating protein synthesis. Estrogen receptors (ERs) have been demonstrated in female sex organs, breast, pituitary, liver, bone, blood vessels, heart, CNS and in certain hormone responsive breast carcinoma cells. The ER is analogous to other steroid receptors: agonist binding to the ligand binding domain brings about receptor dimerization and interaction with 'estrogen response elements' (EREs) of target genes. Gene transcription is promoted through certain *coactivator proteins*. On binding an estrogen antagonist the receptor assumes a different conformation and interacts with other *corepressor proteins* inhibiting gene transcription.

Two ERs designated ER α and ER β have been identified, cloned and structurally characterized. Most tissues express both subtypes but ER α predominates in uterus, vagina, breast, hypo-

thalamus and blood vessels, while ER β predominates in prostate gland of males and ovaries in females. Estradiol binds to both ER α and ER β with equal affinity, but certain ligands may have differing affinities. More importantly ER α and ER β may have a different pattern of interaction with coactivators and corepressors.

Few nongenomic rapid actions of estrogens in certain tissues mediated through the same ER have also been observed.

PHARMACOKINETICS

Estrogens are well absorbed orally and transdermally, but natural estrogens are inactive by the oral route due to rapid metabolism in liver. Estradiol esters injected i.m. are slowly absorbed and exert prolonged action. Natural estrogens in circulation are largely plasma protein bound—to SHBG as well as to albumin.

Estradiol is converted to estrone and *vice versa* in liver. Estriol is derived from estrone. All three are conjugated with glucuronic acid and sulfate—excreted in urine and bile. Considerable enterohepatic circulation occurs due to deconjugation in intestines and reabsorption—ultimate disposal occurs mostly in urine.

Ethinylestradiol is metabolized very slowly ($t_{1/2}$ 12–24 hours)—orally active and more potent.

Preparations and dose

All estrogen preparations have similar action. Their equivalent *parenteral* doses are—
Estradiol 0.1 mg = Ethinylestradiol 0.1 mg = Mestranol 0.15 mg = Conjugated estrogens 10 mg = Estriol succinate 16 mg = Diethylstilbestrol 10 mg.

The *oral* potencies differ from the above due to differing extents of first pass metabolism. Estradiol is inactive orally, conjugated estrogens and estriol succinate undergo partial presystemic metabolism, while in case of ethinylestradiol, mestranol and diethylstilbestrol the oral and parenteral doses are practically the same.

The preferred route of administration of estrogens is oral. Intramuscular injection is resorted to only when large doses have to be given, especially for carcinoma prostate.
1. Estradiol benzoate/cypionate/enanthate/valerate: 2.5–10 mg i.m.; **OVOCYCLIN-P 5 mg inj**, **PROGYNON DEPOT 10 mg/ml inj**.

2. Conjugated estrogens: 0.625–1.25 mg/day oral; **PREMARIN** 0.625 mg, 1.25 mg tab, 25 mg inj (for dysfunctional uterine bleeding).
3. Ethinylestradiol: for menopausal syndrome 0.02–0.2 mg/day oral; **LYNORAL** 0.01, 0.05, 1.0 mg tab, **PROGYNON-C** 0.02 mg tab.
4. Mestranol: acts by getting converted to ethinylestradiol in the body: 0.1–0.2 mg/day oral; in **OVULEN** 0.1 mg tab, with ethynodiol diacetate 1 mg.
5. Estriol succinate: 4–8 mg/day initially, maintenance dose in menopause 1–2 mg/day oral: **EVALON** 1, 2 mg tab, 1 mg/g cream for vaginal application in atrophic vaginitis 1–3 times daily.
6. Fosfestrol tetrasodium: initially 600–1200 mg slow i.v. inj for 5 days, maintenance 120–240 mg/day oral or 300 mg 1–3 times a week i.v. **HONVAN** 120 mg tab, 60 mg/ml inj 5 ml amp.
7. Dienestrol: 0.01% topically in vagina: **DIENESTROL** 0.01% vaginal cream.

Transdermal estradiol A transdermal patch (Estradiol-TTS) has become available in 3 sizes, *viz.* 5, 10 and 20 cm² delivering 0.025 mg, 0.05 mg and 0.1 mg respectively in 24 hr for 3–4 days. The usual dose in menopause is 0.05 mg/day which produces plasma estradiol levels seen in premenopausal women in the early or mid follicular phase. Cyclic therapy (3 weeks on, 1 week off) with estradiol-TTS is advised with an oral progestin added for the last 10–12 days. Beneficial effects of estradiol-TTS on menopausal symptoms, bone density, vaginal epithelium and plasma Gn levels are comparable to those of oral therapy, but improvement in serum lipid profile is less marked.

Systemic side effects of estradiol-TTS are the same as with oral estrogens, but are milder. Oral therapy delivers high dose of the hormone to the liver and increases synthesis of several proteins. Estradiol-TTS avoids high hepatic delivery: consequently plasma levels of TBG, CBG, angiotensinogen and clotting factors are not elevated—risk of thromboembolic phenomena may not be increased.

ESTRADERM-MX: Estradiol 25, 50 or 100 µg per 24 hr transdermal patches; apply to nonhairy skin below waist, replace every 3–4 days using a different site; add an oral progestin for last 10–12 days every month.

Recently a combined estradiol 50 µg + norethisterone acetate 0.25 mg patch has become available in some

countries (**ESTRAGEST-TTS**). Two weeks of estraderm-TTS followed by 2 weeks estragest-TTS with patches changed twice weekly is used for total transdermal HRT.

A gel formulation of estradiol for application over skin is also available. **OESTRAGEL** 3 mg/5 g in 80 g tube; apply over the arms once daily for HRT.

ADVERSE EFFECTS

Most of the adverse effects of estrogens are described with oral contraceptives and with HRT (*see p.* 315).

In addition, dose dependent adverse effects noted when use is made for other indications are—

1. Suppression of libido, gynaecomastia and feminization when given to males.
2. Fusion of epiphyses and reduction of adult stature when given to children.
3. Stilbestrol given to pregnant women, especially during first trimester (as test of pregnancy or otherwise)—increased the incidence of vaginal and cervical carcinoma in the female offspring in childhood or early adulthood. Other genital abnormalities are possible in the female as well as male offspring. Estrogens are contraindicated during pregnancy.
4. In postmenopausal women, estrogens can increase the risk of irregular bleeding and endometrial carcinoma (5–15 fold). A progestin given concurrently blocks the risk.
5. Estrogens can accelerate the growth of existing breast cancer, but low-dose estrogen only HRT does not appear to increase the risk of developing new breast cancer (*see p.* 302).
6. Long-term estrogen therapy doubles the incidence of gallstones. Benign hepatomas are more common in women taking estrogens in their teens and twenties.
7. Migraine, epilepsy and endometriosis may be worsened by estrogens.

USES

Currently, the two most common uses of estrogens are as contraceptives and for hormone replacement therapy in postmenopausal women, but there are some other indications as well.

Hormone replacement therapy (HRT)

Due to cessation of ovarian function at menopause women suffer a number of physical, psychological and emotional consequences.

Medical problems related to menopause are:

- *Vasomotor disturbances* Hot flushes, chilly sensation, inappropriate sweating, faintness, paresthesias, aches and pains.
- *Urogenital atrophy* Change in vaginal cytology and pH, vaginal dryness, vulval shrinkage, dyspareunia, vaginitis, itching, urinary urgency, predisposition to urinary tract infection.
- *Osteoporosis* Loss of osteoid as well as calcium → thinning and weakening of bone → minimal trauma fractures especially of femur, hip, radius, vertebrae.
- *Dermatological changes* Thinning, drying and loss of elasticity of skin, wrinkles, thin and listless hairs.
- *Psychological/Cognitive disturbances* Irritability, depressed mood, loss of libido and self confidence, anxiety and dementia.
- *Increased risk of cardiovascular diseases* Coronary artery disease, myocardial infarction, stroke.

The vasomotor symptoms tend to subside over a few years, but the other changes progress continuously.

Estrogen ±progestin HRT or 'menopausal hormone therapy' (MHT) is highly efficacious in suppressing the perimenopausal syndrome of vasomotor instability, psychological disturbances and atrophic changes, but several recent findings have emphasized a number of risks and limitations of long-term HRT, so that the whole outlook has changed.

The dose of estrogen used in HRT is substantially lower than that for contraception. Typically conjugated estrogens are used 0.625 mg/day (equivalent to ethinylestradiol 10 µg) either cyclically (3 weeks treatment 1 week gap) or continuously, but there is a trend now to use lower doses (0.3–0.45 mg/day). A progestin (medroxy progesterone acetate/norethisterone 2.5 mg daily) is added for 10–12 days each month. Though the progestin may attenuate the metabolic and cardiovascular benefits of estrogen, it is needed to block the increased risk of dysfunctional uterine bleeding and endometrial carcinoma due to continuous estrogenic stimulation of endometrium. Estrogen alone is used in hysterectomised women and when a progestin is not tolerated or is contraindicated. Transdermal

estradiol (with oral or transdermal progestin) appears to have certain advantages (*see above*) and is preferred by some.

The benefits and risks of HRT are considered below:

a. Menopausal symptoms and atrophic changes The vasomotor symptoms respond promptly and almost completely. They are the primary indication for using HRT which improves general physical, mental and sexual well being as well. Genital and dermal atrophic changes are arrested; vulval and urinary problems resolve. Vaginal application of estrogen is effective in relieving local symptoms.

b. Osteoporosis and fractures HRT restores Ca²⁺ balance; further bone loss is prevented and the excess fracture risk is nullified. When used for this purpose, HRT should be initiated before significant bone loss has occurred, because reversal of osteoporosis is none or slight. Calcium + vit D supplements and exercise aid the beneficial effect of HRT. However, accelerated bone loss starts again on cessation of HRT. The 'Women's health, osteoporosis, progestin-estrogen' trial (2002) has shown that even lower doses of conjugated estrogens (0.3, 0.45 mg/day) increased bone mineral density in postmenopausal women, though 0.625 mg/day was more effective.

Notwithstanding the above, appreciation of the other risks of HRT (*see below*) has dislodged estrogen from its prime position in the treatment of osteoporosis compared to raloxifen and bisphosphonates.

c. Cardiovascular events Since hypertension and cardiovascular disease are rare in premenopausal women, and estrogens improve HDL:LDL ratio, retard atherogenesis, reduce arterial impedance, increase NO and PGI₂ production and prevent hyperinsulinaemia, it was believed that estrogen therapy in postmenopausal women will have a protective cardiovascular influence. This was supported by early reports relying mainly on retrospective/epidemiological studies and those using surrogate markers to indicate that HRT in otherwise healthy women reduced risk of coronary artery disease (CAD), myocardial infarction (MI) and stroke. This led to the extensive use of HRT; a segment of doctors contended that menopausal women should take HRT for the rest of their lives.

In the past decade many large scale placebo controlled randomized interventional trials and cohort studies have yielded opposite results. The 'Heart and estrogen/progestin replacement study' (HERS and HERS II) conducted in older women with preexisting cardiovascular disease found that HRT triples the risk of venous thromboembolism, initially increases risk of MI and affords no secondary prophylaxis of CAD in the long-term. The larger 'women's health initiative' (WHI) study conducted in over 16000 younger women without CAD found 24% increase in CAD, 40% increase in stroke and doubling of

venous thromboembolism with the use of combined HRT. It was terminated prematurely in 2002. The increased risk of MI was attributed to the progestin component, since women who took estrogen alone had no increase in the incidence of MI. The committee on safety of medicines (CSM) of UK has estimated that ~20 out of 1000 women aged 60–69 years and not using HRT develop venous thromboembolism over 5 years; 4 extra cases occur in those taking estrogen alone, while 9 extra cases occur in those taking combined HRT. Thus, progestin use adds to the risk.

d. Cognitive function and dementia: Contrary to earlier belief, the 'women's health initiative memory study' (WHIMS) conducted among older women (65–79 years) has failed to detect any protection against cognitive decline by either estrogen alone or combined HRT. There was in fact a slight global deterioration. Surprisingly, the incidence of dementia (Alzheimer's) was doubled.

e. Cancer: That estrogens enhance the growth of *breast cancer* has been well recognized. However, it was contended that small replacement doses of estrogens will not induce new cancer. This appears to be supported by the estrogen alone arm of WHI study in hysterectomized women, as the occurrence of breast cancer was actually lower (but insignificantly). However, in the combined HRT group, a significantly higher incidence of cancer breast occurred, indicating that medroxyprogesterone was the culprit. The prospective observational cohort 'Million women study' (MWS) in the UK found a marginally higher incidence of breast cancer with estrogen alone, but a clearly higher one with estrogen + progestin. Some other studies have also implicated the progestin, and the CSM of UK has drawn similar conclusions. Thus, the protective effect of progestin on endometrial cancer appears to be counter balanced by the procarcinogenic effect on the breast.

Progestin is well known to induce endometrial hyperplasia and its continuous use unopposed by progestin

results in irregular uterine bleeding. In the long-term it predisposes to *endometrial carcinoma*. The MWS has supported this contention. The standard practice is to give combined HRT to women with an intact uterus. However, a Cochrane Database Review has concluded that lower dose unopposed estrogen does not increase endometrial carcinoma risk; may be used in women with intact uterus when a progestin is contraindicated.

A small protective effect of combined HRT on *colorectal carcinoma* has been detected by the WHI study, but this needs to be confirmed.

f. Gallstone, migraine: Estrogens slightly increase the risk of developing gallstones, while progestins may trigger migraine.

Tibolone It is a 19-norsteroid developed specifically to be used for HRT, which combines estrogenic and progestational properties with weak androgenic activity. In a dose of 2.5 mg daily, it suppresses menopausal symptoms and lowers the raised Gn levels. No endometrial stimulation has been noted. Urogenital atrophy, psychological symptoms, libido and osteoporosis are improved similar to other forms of HRT. Contraindications are the same as for conventional HRT, but increase in breast cancer risk appears to be less than with combined HRT.

Weight gain, increased facial hair and occasional vaginal spotting may be noted.

LIVIAL 2.5 mg tab, one tab daily without interruption; institute therapy only after the women has been menopausal for atleast 12 months.

Current conclusions regarding HRT

1. The main indication of HRT is vasomotor and other symptoms in the perimenopausal period. It should be used at the smallest effective dose and for the shortest duration.
2. Young women with premature menopause clearly deserve HRT.
3. Hysterectomized women should receive estrogen alone, while those with intact uterus be given estrogen + progestin.
4. Perimenopausal women should be given cyclic HRT rather than continuous HRT.
5. HRT is not the best option to prevent osteoporosis and fractures.
6. HRT affords no protection against cardiovascular disease; conventional dose combined HRT may even increase the risk of venous thromboembolism, MI and stroke.
7. HRT does not protect against cognitive decline; may increase the risk of dementia.
8. Combined HRT increases the risk of breast cancer, gallstones and migraine.
9. Transdermal HRT may have certain advantages over oral HRT.
10. The need for HRT should be assessed in individual women, and not prescribed routinely.

2. **Senile vaginitis** Estrogens change vaginal cytology to the premenopausal pattern and are effective in preventing as well as treating atrophic vaginitis that occurs in elderly women. Oral therapy may be given but more commonly a topical preparation is used; an antibacterial may be combined. They help in overcoming infection and relieve symptoms of *Kraurosis vulvae*.

3. **Delayed puberty in girls** It may be due to ovarian agenesis (Turner's syndrome) or hypopituitarism. In both, pubertal changes are brought about by estrogen treatment, except the rapid gain in height for which growth hormone and/or a small dose of androgen may be added. Usually cyclic treatment is given; some prefer to start with a lower dose and gradually attain the full replacement dose.

4. **Dysmenorrhoea** While PG synthesis inhibitors are the first line drugs, cyclic estrogen therapy (often with added progestin to ensure withdrawal bleeding) benefits by inhibiting ovulation (anovular cycles are painless) and decreasing prostaglandin synthesis in endometrium; but this should be reserved for severe cases.

5. **Acne** It occurs at puberty due to increased androgen secretion in both boys and girls. Estrogens benefit by suppressing ovarian production of androgen by inhibiting Gn release from pituitary; cyclic treatment (with added progestin) is quite effective. Use in boys is out of question. Even in girls, topical therapy with antimicrobials, tretinoin and other drugs is preferred (see Ch. 64).

6. **Dysfunctional uterine bleeding** A progestin given cyclically is the rational and effective therapy. Estrogens have adjuvant value.

7. **Carcinoma prostate** Estrogens are palliative; produce relief in primary as well as metastatic carcinoma prostate by suppressing androgen production (through pituitary). Fosfestrol is preferred by some as it is concentrated in the prostate where it may antagonise androgen. High doses are needed. GnRH agonists with or without androgen antagonist are preferred.

ANTIESTROGENS AND SELECTIVE ESTROGEN RECEPTOR MODULATORS (SERMs)

Two nonsteroidal compounds *clomiphene citrate* and *tamoxifen citrate* previously grouped as estrogen antagonists have been in use since 1970s,

but their differing antagonistic and agonistic actions depending on species, target organ and hormonal background could not be explained. The recent discovery of two estrogen receptors (ERs) and that ligand binding could change their configuration in multiple ways allowing interaction with different coactivators and corepressors in a tissue specific manner has paved the way for development of compounds with unique profile of agonistic and antagonistic actions in different tissues. These drugs have been designated '*selective estrogen receptor modulators*' and two new compounds *Raloxifene* and *Ormeloxifene* have been marketed. It has been demonstrated that the conformation of ER after binding tamoxifen or raloxifene is different from that after binding estradiol.

Antiestrogens

1. **Clomiphene citrate** It binds to both ER α and ER β and acts as a pure estrogen antagonist in all human tissues, but the recemate displays weak agonistic action in rats. It induces Gn secretion in women by blocking estrogenic feedback inhibition of pituitary. The amount of LH/FSH released at each secretory pulse is increased. In response, the ovaries enlarge and ovulation occurs if the ovaries are responsive to Gn. Antagonism of peripheral actions of estrogen results in hot flushes. Endometrium and cervical mucus may be modified.

The chief use of clomiphene is in sterility due to failure of ovulation: 50 mg once daily for 5 days starting from 5th day of cycle. Treatment is given monthly. Conception occurs in many women who previously were amenorrhoeic or had anovular cycles. If 1–2 months treatment does not result in conception—the daily dose may be doubled for 2–3 cycles (max 200 mg/day). The antiestrogenic effect of clomiphene on developing follicle, endometrium or cervical mucus can be counterproductive. Luteal phase dysfunction has also been blamed for therapeutic failures. Addition of menotropins or chorionic gonadotropin on the last 2 days of the course improves the success rate.

Clomiphene is well absorbed orally, gets deposited in adipose tissue and has long $t_{1/2}$ of ~6 days. It is largely metabolized and excreted in bile.

Adverse effects Polycystic ovaries, multiple pregnancy, hot flushes, gastric upset, vertigo, allergic dermatitis. Risk of ovarian tumour may be increased.

Other uses *To aid in vitro fertilization* Clomiphene given with Gn causes synchronous maturation of several ova—improves their harvesting for *in vitro* fertilization.

Oligozoospermia: In men also clomiphene increases Gn secretion → promotes spermatogenesis and testosterone secretion. For male infertility—25 mg daily given for 24 days in a month with 6 days rest for upto 6 months has been recommended. However, success rates are low.

CLOMID, FERTOMID, 25, 50 mg tab. CLOFERT, CLOME 25, 50, 100 mg tab.

Fulvestrant It is the first member of a distinct class of ER ligands called ‘selective estrogen receptor down regulators’ (SERDs) or ‘pure estrogen antagonists’ that has been introduced for the treatment of metastatic ER positive breast cancer in postmenopausal women which has stopped responding to tamoxifen. In contrast to tamoxifen, it inhibits ER dimerization so that ER interaction with DNA is prevented and receptor degradation is enhanced. The ER is thus down regulated resulting in more complete suppression of ER responsive gene function. This along with its higher affinity for the ER probably accounts for its efficacy in tamoxifen resistant cases.

Fulvestrant is administered as monthly i.m. injections; is slowly absorbed and has an elimination $t_{1/2}$ of more than a month.

Selective estrogen receptor modulators (SERMs)

Tamoxifen citrate Though chemically related to clomiphene, it has complex actions; acts as potent estrogen antagonist in breast carcinoma cells, blood vessels and at some peripheral sites, but as partial agonist in uterus, bone, liver and pituitary. Inhibition of human breast cancer cells and hot flushes reflect antiestrogenic action, while the weak estrogen agonistic action manifests as stimulation of endometrial proliferation,

lowering of Gn and prolactin levels in postmenopausal women as well as improvement in their bone density.

A decrease in total and LDL cholesterol without any change in HDL and triglyceride level reflects estrogenic action. Similar to estrogen HRT, it increases the risk of deep vein thrombosis by 2–3 times.

Tamoxifen is the standard hormonal treatment of breast cancer in both pre- and postmenopausal women, though aromatase inhibitors are gaining prominence. In early cases it is given as postmastectomy adjuvant therapy, while in advanced cases it is a constituent of palliative treatment. Response rates are high in ER-positive breast carcinomas, but some ER-negative tumours also respond suggesting additional nonhormonal mechanism of action. It is also effective following surgery in cancer of male breast.

Based on large epidemiological studies which have shown 45% reduction in the incidence of ER-positive breast cancer, it has been approved for primary prophylaxis of breast cancer in high-risk women. Recurrence rate in ipsilateral as well as contralateral breasts is reduced by tamoxifen, but benefits of prophylactic therapy beyond 5 years are not proven; outcomes may even be worse.

Improvement in bone mass due to anti-resorptive effect, and in lipid profile are the other benefits of tamoxifen therapy. However, endometrial thickening occurs and risk of endometrial carcinoma is increased 2–3 fold.

Tamoxifen is effective orally; has a biphasic plasma $t_{1/2}$ (10 hours and 7 days) and a long duration of action. Some metabolites of tamoxifen are more potent antiestrogens. The drug is excreted primarily in bile.

Dose 10–20 mg BD. **TAMOXIFEN, MAMOFEN, TAMODEX 10, 20 mg tabs.**

Male infertility: May be used as alternative to clomiphene.

Side effects Hot flushes, vomiting, vaginal bleeding, vaginal discharge, menstrual irregularity, increased risk of venous thromboembolism.

Dermatitis, anorexia, depression, mild leucopenia and ocular changes are infrequent.

It is much less toxic than other anticancer drugs.

Toremifene It is a newer congener of tamoxifen with similar actions, uses and adverse effects.

Raloxifene This SERM is an estrogen partial agonist in bone and cardiovascular system, but an antagonist in endometrium and breast. It has high affinity for both ER α and ER β , and has a distinct DNA target the 'raloxifene response element' (RRE).

Several long term multicentric studies have convincingly shown that raloxifene prevents bone loss in postmenopausal women; bone mineral density (BMD) may even increase by 0.9–3.4% over years in different bones, particularly the lumbar vertebrae. The risk of vertebral fracture is reduced to half, but not that of long bones except ankle.

In postmenopausal women raloxifene reduces LDL cholesterol, probably by upregulating hepatic LDL receptors. In contrast to estrogen HRT there is no increase in HDL and triglyceride levels. Follow up studies have shown that raloxifene reduces the risk of breast cancer by 65%, though the protection was confined to ER-positive breast cancer.

Raloxifene does not stimulate endometrial proliferation and there is no increase in the risk of endometrial carcinoma. It does not relieve vasomotor symptoms of menopause; rather hot flushes may be induced in some women.

Raloxifene is absorbed orally but has low bioavailability due to extensive first pass glucuronidation. The $t_{1/2}$ is 28 hours and major route of excretion is faeces.

Side effects Hot flushes, leg cramps are generally mild; vaginal bleeding is occasional. The only serious concern is 3-fold increase in risk of deep vein thrombosis and pulmonary embolism. However, similar risk attends estrogen HRT.

Raloxifene is a first line drug for prevention and treatment of osteoporosis in postmenopausal women; Ca²⁺ and vit D supplements enhance the

benefit; bisphosphonates are the other first line drugs. It has no use in men.

Dose: 60 mg/day;

BONMAX, RALOTAB, ESSERM 60 mg tab.

Ormeloxifene A distinct new SERM which acts as estrogen antagonist in breast and uterus. It suppresses endometrial proliferation by regulating their ER. Excessive uterine bleeding with anovular cycles occurring near menopause is normalized. However, vaginal epithelium and cervical mucus are not altered. It may have contraceptive property.

Ormeloxifene is approved for treatment of dysfunctional uterine bleeding. Side effects are nausea, headache, fluid retention, weight gain, rise in BP and prolongation of menstrual cycles.

Dose: 120 mg twice weekly for 2–3 months, followed by 60 mg weekly for another 3 months. SEVISTA 60 mg tab.

AROMATASE INHIBITORS

Aromatization of 'A' ring of testosterone and androstenedione is the final and key step in the production of estrogens (estradiol/estrone) in the body. In addition to the circulating hormone, locally produced estrogens appear to play an important role in the development of breast cancer. Though some aromatase inhibitors (AIs) were produced in the past, three recent 'third generation' AIs *Letrozole*, *Anastrozole* and *Exemestane* have demonstrated clinical superiority in the treatment of breast cancer.

Letrozole It is an orally active nonsteroidal compound that reversibly inhibits aromatization all over the body, including that within the breast cancer cells, resulting in nearly total estrogen deprivation. Proliferation of estrogen dependent breast carcinoma cells is suppressed to a greater extent than with tamoxifen. Letrozole is rapidly absorbed with 100% oral bioavailability, large volume of distribution, slow metabolism and a $t_{1/2}$ of ~40 hours. Randomized clinical trials have established its utility in:

(a) Early breast cancer: as adjuvant therapy after mastectomy in ER+ive cases. Extension of

prophylaxis with letrozole beyond the standard 5 year tamoxifen treatment continues to afford protection, whereas continuation of tamoxifen is not useful. Survival is prolonged in patients who have positive axillary lymph nodes.

(b) Advanced breast cancer: Current guidelines recommend letrozole as first line therapy because of longer time to disease progression and higher response rate obtained with it compared to tamoxifen. It is also effective as second line treatment when tamoxifen has failed.

Adverse effects Hot flushes, nausea, diarrhoea, dyspepsia and thinning of hair are the side effects. Joint pain is common and it can accelerate bone loss, but there is no endometrial hyperplasia or increased risk of endometrial carcinoma. Risk of venous thromboembolism is also not increased, and there is no deterioration of lipid profile.

Dose: 2.5 mg BD oral.

LETOVAL, LETROZ, FEMARA, ONCOLET 2.5 mg tab. Though contraindicated in premenopausal women, letrozole was clandestinely promoted and tested as an ovulation inducing fertility drug. This was stopped after media outcry.

Anastrozole Another nonsteroidal and reversible (Type 2) AI, more potent than letrozole and suitable for single daily dosing. It accumulates in the body to produce peak effect after 7–10 days. Anastrozole is useful as adjuvant therapy in early ER+ive breast cancer as well as for palliation of advanced cases in postmenopausal women. In early cases, tumor recurrence time was found to be longer than with tamoxifen. Risk of new tumor appearing in the contralateral breast was also lower with anastrozole. A longer time to disease progression compared to tamoxifen has been obtained in advanced ER+ive breast cancer. Many tamoxifen resistant cases responded with increased survival. Side effects are hot flushes, vaginal dryness, vaginal bleeding, nausea, diarrhoea, thinning of hair. Arthralgia and acceleration of osteoporosis are prominent. However, it does not predispose to endometrial carcinoma or to venous thromboembolism.

Dose: 1 mg OD; **ALTRAZ, ARMOTRAZ 1 mg tab.**

Exemestane: This steroidal and irreversible (Type 1) inhibitor of aromatase acts like a suicide substrate by covalent binding to the enzyme. As a result >90% suppression of estradiol production is obtained. However, like androstenedione, it has weak androgenic activity. Exemestane has been found beneficial in early breast cancer by reducing the risk of disease progression when it was substituted for tamoxifen as adjuvant therapy. In advanced breast cancer, longer survival, increased time to disease progression and fewer treatment failures have been obtained with exemestane. It is administered orally and is well tolerated. Adverse effects are similar to other AIs.

PROGESTINS

These are substances which convert the estrogen primed endometrium to secretory and maintain pregnancy in animals spayed after conception (*Progestin* = favouring pregnancy).

At the turn of the last century it became apparent that ovaries secrete two hormones, and that corpus luteum was essential for maintenance of pregnancy. Progesterone was isolated in 1929, but its full therapeutic potential has been exploited only after the 1950s when a large number of orally active synthetic progestins were developed.

Natural progestin Progesterone, a 21 carbon steroid, is the natural progestin and is derived from cholesterol. It is secreted by the corpus luteum (10–20 mg/day) in the later half of menstrual cycle under the influence of LH. Its production declines a few days before the next menstrual flow. If the ovum gets fertilized and implants—the blastocyst immediately starts producing chorionic gonadotropin which is absorbed and sustains the corpus luteum in early pregnancy. Placenta starts secreting lots of estrogens and progesterone from 2nd trimester till term. Men produce 1–5 mg progesterone per day from adrenals and testes—its role if any, in males is not known.

Synthetic progestins A number of synthetic progestins with high oral activity have been produced. These are either progesterone derivatives (21 C) or 19-nortestosterone derivatives (18 C).

The progesterone derivatives are almost pure progestins, have weaker antioviulatory action

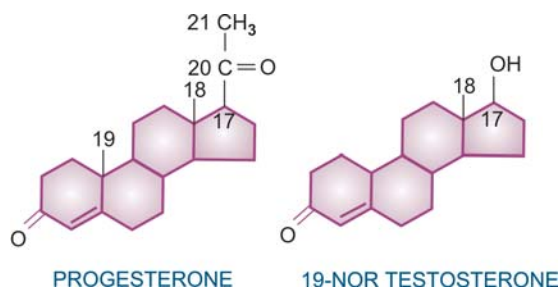

and are used primarily as adjuvants to estrogens for HRT in postmenopausal women, threatened abortion, endometriosis, etc. for selective progestational effect. The older 19-nortestosterone derivatives developed in the 1950-60s have additional weak estrogenic, weak androgenic, anabolic and potent antiovarian action: are used primarily in combined contraceptive pills. *Norgestrel* has a 13-ethyl substitution (termed gonane)—is more potent (especially its levo isomer *levonorgestrel*).

In the 1980-90s a number of other gonane 19-nortestosterone compounds were introduced, of which *desogestrel* has been marketed in India. *Desogestrel* and *norgestimate* are prodrugs. In addition to being very potent progestins they have strong antiovarian action (*gestodene* inhibits

ovulation at as low as 40 µg/day dose), and little or no androgenic property. Therefore, they do not antagonise the beneficial action of estrogens on lipid profile and are preferable in women with hyperandrogenemia. High antiovarian potency allows reduction of ethinylestradiol dose when these are combined in oral contraceptives.

The newer 19-norprogesterone derivative *nomegestrol* has antiandrogenic property, is less antiovarian, but has strong effect on endometrium.

ACTIONS

The main function of progesterone is preparation of the uterus for nidation and maintenance of pregnancy. The latter is due to prevention of endometrial shedding, decreased uterine motility and inhibition of immunological rejection of the foetus: progesterone depresses T-cell function and cell-mediated immunity (CMI).

1. Uterus Progesterone brings about secretory changes in the estrogen primed endometrium: hyperemia, tortuosity of glands and increased secretion occurs while epithelial proliferation is suppressed. It is lack of progestational support which causes mucosal shedding during menstruation.

Continued action of progesterone (as when pregnancy occurs) brings about decidual changes in endometrium—stroma enlarges and becomes spongy, glands atrophy. It also decreases sensitivity of myometrium to oxytocin.

2. Cervix Progesterone converts the watery cervical secretion induced by estrogens to viscid, scanty and cellular secretion which is hostile to sperm penetration.

3. Vagina Progesterone induces pregnancy like changes in the vaginal mucosa—leukocyte infiltration of cornified epithelium.

4. Breast Progesterone causes proliferation of acini in the mammary glands. Cyclic epithelial proliferation occurs during luteal phase, but continuous exposure to progesterone during

PROGESTERONE DERIVATIVES

Medroxyprogesterone acetate
 Megestrol acetate
 Dydrogesterone
 Hydroxyprogesterone caproate

Newer compound

Nomegestrol acetate

19-NORTESTOSTERONE DERIVATIVES

Older compounds

Norethindrone
 (Norethisterone)
 Lynestrenol
 (Ethinylestrenol)
 Allylestrenol
 Levonorgestrel (*Gonane*)

Newer compounds

(*Gonanes*)
 Desogestrel
 Norgestimate
 Gestodene

pregnancy halts mitotic activity and stabilizes mammary cells. Acting in concert with estrogens, it prepares breast for lactation. Withdrawal of these hormones after delivery causes release of prolactin from pituitary and milk secretion starts.

5. CNS High circulating concentration of progesterone (during pregnancy) appears to have a sedative effect.

6. Body temperature It causes a slight (0.5°C) rise in body temperature by resetting the hypothalamic thermostat and increasing heat production. This is responsible for the higher body temperature seen during the luteal phase.

7. Respiration Progestins in relatively higher doses stimulate respiration, as occurs during pregnancy.

8. Metabolism Prolonged use of oral contraceptives impairs glucose tolerance in some women. This has been ascribed to the progestational component. Progestins, especially those with androgenic activity (19-nortestosterone derivatives) tend to raise LDL and lower HDL levels. This may reduce the beneficial effect of estrogen used concurrently in HRT or in contraceptives. Micronized oral progesterone formulation (referred to as '*natural progesterone*') introduced recently has been shown not to counteract the beneficial effect of estrogen on LDL and HDL.

9. Pituitary Progesterone is a weak inhibitor of Gn secretion from pituitary. It decreases the frequency of LH pulses by action on hypothalamic pulse generator but increases the amount of LH secreted per pulse. Administration of progestin during follicular phase suppresses the preovulatory LH surge and prevents ovulation; synergises with estrogen for this action. The gonane 19-nortestosterone derivatives are potent antiovarian drugs.

Mechanism of action

Unlike other steroid receptors, the progesterone receptor (PR) has a limited distribution in the

body: confined mostly to the female genital tract, breast, CNS and pituitary. The PR is normally present in the nucleus of target cells. Analogous to ER, upon binding the hormone PR undergoes dimerization, attaches to progesterone response element (PRE) of target genes and regulates transcription through coactivators. The anti-progestins also bind to PR, but the conformation assumed is different from agonist bound receptor and opposite effects are produced by interaction with corepressors.

The PR exists in a short (PR-A) and a longer (PR-B) isoforms. The two have differing activities, but because the ligand binding domain of both is identical, all agonists and antagonists display similar binding properties for them. Tissue selective modulation of PR has not yet been possible, as has been in the case of ER. Progesterone also acts on cell membrane receptors in certain tissues and produces rapid effects, but they are probably not important physiologically.

Estrogens have been shown to increase PR density, whereas progesterone represses ER and enhances local degradation of estradiol.

PHARMACOKINETICS

Progesterone, unless specially formulated, is inactive orally because of high first-pass metabolism in liver. It is mostly injected i.m. in oily solution. Even after an i.m. dose it is rapidly cleared from plasma, has a short $t_{1/2}$ (5–7 min). It is nearly completely degraded in the liver—major product is pregnanediol which is excreted in urine as glucuronide and sulfate conjugates. However, effects of progesterone last longer than the hormone itself.

A micronized formulation of progesterone has been developed for oral administration. Microfine particles of the drug are suspended in oil and dispensed in gelatin capsules. Absorption occurs through lymphatics. Though bioavailability is low, effective concentrations are attained in the body.

Most of the synthetic progestins are orally active and are metabolized slowly; have plasma $t_{1/2}$ ranging from 8–24 hours.

Preparations and dose

1. Progesterone: 10–100 mg i.m. (as oily solution) OD; **PROGEST**, **PROLUTON**, **GESTONE 50 mg/ml inj.**, 1 and 2 ml amp; 100–400 mg OD oral; **NATUROGEST**, **OGEST 100, 200, 400 mg caps** containing micronized oily suspension.
2. Hydroxyprogesterone caproate: 250–500 mg i.m. at 2–14 days intervals; **PROLUTON DEPOT**, **MAINTANE INJ**, **PROCAPRIN 250 mg/ml** in 1 and 2 ml amp.
3. Medroxyprogesterone acetate: 5–20 mg OD–BD oral, 50–150 mg i.m. at 1–3 month interval; **FARLUTAL 2.5, 5, 10 mg tab.**, **PROVERA**, **MEPRATE**, **MODUS 2.5, 10 mg tab**, **DEPOT-PROVERA 150 mg** in 1 ml inj. (as contraceptive). Has weak androgenic and antiestrogenic property.
4. Dydrogesterone: 5–10 mg OD/TDS oral; **DUPHASTON 5 mg tab**. It has poor antioviulatory action: may be preferred when contraceptive effect is not required.
5. Norethindrone (Norethisterone): 5–10 mg OD–BD oral; **PRIMOLUT-N**, **STYPTIN**, **REGESTRONE**, **NORGEST 5 mg tab**; **REGESTRONE HRT**, **NORETA HRT 1 mg tab** (for HRT); **NORISTERAT 200 mg/ml inj** (as enanthate) for contraception 1 ml i.m every 2 months; has androgenic, anabolic and antiestrogenic activity.
6. Lynestrenol (Ethinylestrenol): 5–10 mg OD oral; **ORGAMETRIL 5 mg tab**. Has additional androgenic, anabolic and estrogenic activity.
7. Allylestrenol: 10–40 mg/day; **GESTANIN**, **FETUGARD**, **MAINTANE 5 mg tab**. Has been especially used for threatened/habitual abortion, **PROFAR 25 mg tab**.
8. Levonorgestrel: 0.1–0.5 mg/day; **DUOLUTON-L**, **OVRAL 0.25 mg+ ethinylestradiol 0.05 mg tab**. Has androgenic, anabolic and antiestrogenic property.
9. Desogestrel 150 µg + ethinylestradiol 30 µg (**NOVELON**) tab, 1 tab OD 3 week on 1 week off cyclic therapy. (Other preparations are given with oral contraceptives).

ADVERSE EFFECTS

- Breast engorgement, headache, rise in body temperature, edema, esophageal reflux, acne and mood swings may occur with higher doses.
- Irregular bleeding or amenorrhoea can occur if a progestin is given continuously.
- The 19-nortestosterone derivatives lower plasma HDL levels—may promote atherogenesis, but progesterone and its derivatives have no such effect.
- Long-term use of progestin in HRT may increase the risk of breast cancer.
- Blood sugar may rise and diabetes may be precipitated by long-term use of potent agents like levonorgestrel.

- Intramuscular injection of progesterone is painful.
- Given in early pregnancy, progestins can cause masculinization of female foetus and other congenital abnormalities.

Their use for diagnosis of pregnancy is now contraindicated.

USES

1. **As contraceptive** Most common use (*see later*).
2. **Hormone replacement therapy (HRT)** In non-hysterectomised postmenopausal women estrogen therapy is supplemented with a progestin for 10–12 days each month to counteract the risk of inducing endometrial carcinoma. A progesterone derivative lacking androgenic activity is preferred.
3. **Dysfunctional uterine bleeding** It is often associated with anovular cycles. Continued estrogenic action on endometrium (causing hyperplasia) without progesterone induction and withdrawal resulting in incomplete sloughing leads to irregular, often profuse bleeding. A progestin in relatively large doses (norethindrone 20–40 mg/day or equivalent) promptly stops bleeding and keeps it in abeyance as long as given. Subsequently cyclic treatment regularizes and normalizes menstrual flow. A progestin with inherent estrogenic action is preferred; often supplemental dose of estrogen is combined.
4. **Endometriosis** It is due to the presence of ectopic endometrium; manifestations are dysmenorrhoea, painful pelvic swellings and infertility. Continued administration of progestins induces an ovulatory, hypoestrogenic state by suppressing Gn release. The direct action on endometrium prevents bleeding in the ectopic sites by suppressing menstruation. Treatment for a few months causes atrophy and regression of the ectopic masses; therapy can be withdrawn in many cases after 6 months without reactivation. Fertility returns in a good percentage. Progestin treatment of endometriosis is cheap and generally well tolerated, but not all cases respond and recurrences

are frequent. Danazol is an effective alternative. Other drugs used are GnRH agonists and antiprogestins.

5. Premenstrual syndrome/tension Some women develop headache, irritability, fluid retention, distention and breast tenderness a few days preceding menstruation. When depression predominates, it has been labelled 'premenstrual dysphoric disorder'. Fluoxetine and other SSRIs given daily on symptom days dampen irritability and mood changes in majority of women. If severe, premenstrual syndrome requires suppression of ovulation by combined estrogen-progesterone treatment given cyclically. Relatively higher dose of progestin is generally used. Progestins are added to estrogen when it is used for severe dysmenorrhoea.

6. Threatened/habitual abortion In most such patients there is no progesterone deficiency; administration of excess hormone is of no benefit. Progestin therapy may be considered in those patients who have established deficiency. However, progestins are briskly promoted and almost routinely prescribed in India. There is some recent evidence of its efficacy in preventing premature delivery in high risk pregnancy. If such use is made—a pure progestin without estrogenic or androgenic activity should be employed.

7. Endometrial carcinoma Progestins are palliative in about 50% cases of advanced/ metastatic endometrial carcinoma. High doses are needed.

ANTIPROGESTIN

Mifepristone It is a 19-norsteroid with potent competitive antiprogestational and significant antiglucocorticoid as well as antiandrogenic activity.

Given during the follicular phase, its antiprogesterone action results in attenuation of midcycle Gn surge from pituitary → slowing of follicular development and delay/failure of ovulation. During the luteal phase, it prevents secretory changes normally brought about by progesterone.

Later in the cycle, it blocks progesterone support to the endometrium, unrestrains PG release from it—this stimulates uterine contractions. Mifepristone also sensitizes the myometrium to PGs and induces menstruation. If implantation has occurred, it blocks decidualization, conceptus is dislodged, HCG production falls, secondary luteolysis occurs—progesterone secretion decreases and cervix is softened.

Mifepristone is a partial agonist and competitive antagonist at both A and B forms of PR. In the absence of progesterone (anovulatory cycles, after menopause) it exerts weak progestational activity—induces predecidual changes. The weak agonistic action is not manifest in the presence of progesterone.

The antiglucocorticoid action of usual doses is also not manifest in normal individuals because blockade of negative feedback at hypothalamic-pituitary level elicits ACTH release → plasma cortisol rises and overcomes the direct antiglucocorticoid action. Amelioration of Cushing's symptoms has been obtained with large doses (*see p. 287*).

Pharmacokinetics Mifepristone is active orally, but bioavailability is only 25%. It is largely metabolized in liver by CYP 3A4 and excreted in bile; some enterohepatic circulation occurs; $t_{1/2}$ 20–36 hr.

Interaction with CYP 3A4 inhibitors (erythromycin, ketoconazole) and inducers (rifampin, anticonvulsants) has been reported.

Uses

1. Termination of pregnancy of up to 7 weeks: 600 mg as single oral dose causes complete abortion in 60–85% cases. To improve the success rate, current recommendation is to follow it up 48 hours later by a single 400 mg oral dose of misoprostol. This achieves >90% success rate and is the accepted nonsurgical method of early first trimester abortion. In place of oral misoprostol, a 1 mg gemeprost pessary can be inserted intravaginally. Mifepristone administered within 10

days of a missed period results in an apparent late heavy period (with dislodged blastocyst) in upto 90% cases.

This procedure is generally safe, but prolonged bleeding and failed abortion are the problems in some cases. Anorexia, nausea, tiredness, abdominal discomfort, uterine cramps, loose motions are the other side effects.

2. Cervical ripening 24–30 hours before attempting surgical abortion or induction of labour, mifepristone 600 mg results in softening of cervix; the procedure is facilitated.

3. Postcoital contraceptive Mifepristone 600 mg given within 72 hr of intercourse interferes with implantation and is a highly effective method of emergency contraception. The menstrual cycle, however, is disturbed.

4. Once-a-month contraceptive A single 200 mg dose of mifepristone given 2 days after mid-cycle each month prevents conception on most occasions. Administering mifepristone in late luteal phase to dislodge the embryo (if present) and to ensure menstruation irrespective of conception, has also been tried. These alternative methods of contraception, though attractive, may prolong/disrupt the next menstrual cycle and thus be difficult to use continuously. There is little experience with these methods and they are not popular.

5. Induction of labour By blocking the relaxant action of progesterone on uterus of late pregnancy, mifepristone can induce labour. It may be tried in cases with intrauterine foetal death and to deliver abnormal foetuses.

6. Cushing's syndrome Mifepristone has palliative effect due to glucocorticoid receptor blocking property. May be used for inoperable cases. Other uses under evaluation are—in endometriosis, uterine fibroid, certain breast cancers and meningioma.

MIFEGEST, MIFEPRIN 200 mg tab.

T-PILL + MISO: Mifepristone 200 mg (3 tabs) + Misoprostol 200 µg (2 tabs); for medical termination of pregnancy of upto 49 days: take 3 tablets of T-PILL on day 1, followed on day 3 by 2 tablets of MISO.

Other recently developed antiprogestins are *Onapristone* (a pure antagonist) and *Gestinone* (more efficacious in endometriosis).

HORMONAL CONTRACEPTIVES

These are hormonal preparations used for reversible suppression of fertility. Because of our alarming population trends, antifertility drugs are the need of the day. In developing countries particularly, the mortality rate has declined and birth rate has increased due to urbanization. In the earlier part of 20th century, methods of contraception used (condoms, diaphragms, spermicidal creams, foam tablets, etc.) were intimately related to sexual intercourse, therefore, despised by most couples. These also have higher failure rate. Rock and Pincus (1955) announced the successful use of an oral progestin for contraception, separating fertility control from coitus.

It was soon discovered that addition of a small quantity of an estrogen enhanced their efficacy; combined pills have become the most popular method of contraception, particularly because the hormone content of the pills has been reduced, minimizing the potential harm and affording other health benefits.

FEMALE CONTRACEPTION

Over 100 million women worldwide are currently using hormonal contraceptives. With these drugs, fertility can be suppressed at will, for as long as desired, with almost 100% confidence and complete return of fertility on discontinuation. The efficacy, convenience, low cost and overall safety of oral contraceptives (OCs) has allowed women to decide if and when they will become pregnant and to plan their activities. A variety of oral and parenteral preparations are now available offering individual choices.

TYPES OF METHODS

Oral

1. Combined pill It contains an estrogen and a progestin. With accumulated experience, it has

been possible to reduce the amount of estrogen and progestin in the 'second generation' OC pills without compromising efficacy, but reducing side effects and complications. 'Third generation' pills containing newer progestins like desogestrel with improved profile of action have been introduced in the 1990s. Ethinylestradiol 30 µg daily is considered threshold but can be reduced to 20 µg/day if a progestin with potent antiovarian action is included. The progestin is a 19-nortestosterone because these have potent antiovarian action. Used alone the ovulation inhibitory dose (per day) of the currently used progestins is estimated to be—levonorgestrel 60 µg, desogestrel 60 µg, norgestimate 200 µg, gestodene 40 µg, but the amount in the pill is 2–3 times higher to attain 100% certainty. While both estrogens and progestins synergise to inhibit ovulation, the progestin ensures prompt bleeding at the end of a cycle and blocks the risk of developing endometrial carcinoma due to the estrogen. One tablet is taken daily for 21 days, starting on the 5th day of menstruation. The next course is started after a gap of 7 days in which bleeding occurs. Thus, a cycle of 28 days is maintained. Calendar packs of pills are available. This is the most popular and most efficacious method.

2. Phased regimens These have been introduced to permit reduction in total steroid dose without compromising efficacy. These are biphasic or triphasic. The estrogen dose is kept constant (or varied slightly between 30–40 µg), while the amount of progestin is low in the first phase and progressively higher in the second and third phases.

Phasic pills are particularly recommended for women over 35 years of age or when other risk factors are present.

3. Minipill (progestin only pill) It has been devised to eliminate the estrogen, because many of the long-term risks have been ascribed to this component. A low-dose progestin only pill is taken daily continuously without any gap. The menstrual cycle tends to become irregular and ovulation occurs in 20–30% women, but other

mechanisms contribute to the contraceptive action. The efficacy is lower (96–98%) compared to 98–99.9% with combined pill—look for pregnancy if amenorrhoea of more than 2 months occurs. This method is less popular.

4. Postcoital (emergency) contraception Currently 3 regimens are available:

(a) Levonorgestrel 0.5 mg + ethinylestradiol 0.1 mg (2 **OVRAL** tablets) taken as early as possible but within 72 hours of unprotected intercourse and repeated after 12 hours. Till recently, this regimen called the 'Yuzpe method' has been the most popular. It is estimated to prevent 3 out of 4 possible pregnancies, but nearly 50% women experience nausea and 20% vomit.

(b) Levonorgestrel alone 0.75 mg taken twice with 12 hour gap within 72 hours of intercourse.

Trials conducted globally by the WHO taskforce on postovulatory methods of fertility control have found this regimen to be 2–3 times more effective and better tolerated. Incidence of vomiting is only 6% and other side effects are also less. However, the next period may be somewhat delayed. The WHO essential drug list (2001) recommended replacement of Yuzpe method by this regimen.

(c) Mifepristone 600 mg single dose taken within 72 hours of intercourse has been used in China, Europe and few other countries with high success and fewer side effects than Yuzpe method.

Emergency postcoital contraception should be reserved for unexpected or accidental exposure (rape, condom rupture) only, because all regimens have higher failure rate and side effects than regular low-dose combined pill.

Injectable

These have been developed to obviate need for daily ingestion of pills. They are given i.m. as oily solution; are highly effective; over 50 million women have used them so far. Their major limitations are:

(a) Animal data has indicated carcinogenic potential but there is no proof yet from human studies despite 30 years of experience. No increase

Table 22.1: Oral contraceptive preparations

PROGESTIN		ESTROGEN		TRADE NAME
COMBINED PILLS				
1. Norgestrel	0.3 mg	Ethinyl estradiol	30 µg	MALA-D (21 tabs + 7 ferrous sulfate 60 mg tabs.)
2. Norgestrel	0.5 mg	Ethinyl estradiol	50 µg	OVRAL-G
3. Levonorgestrel	0.25 mg	Ethinyl estradiol	50 µg	OVRAL, DUOLUTON-L
4. Levonorgestrel	0.15 mg	Ethinyl estradiol	30 µg	OVRAL-L, BANDHAN
5. Desogestrel	0.15 mg	Ethinyl estradiol	30 µg	NOVELON
6. Desogestrel	0.15 mg	Ethinyl estradiol	20 µg	FEMILON
PHASED PILL				
1. Levonorgestrel	50–75 –125 µg	Ethinyl estradiol	30–40 –30 µg	TRIQUILAR (6 + 5 + 10 tablets)
2. Norethindrone	0.5–0.75 –1.0 mg	Ethinyl estradiol	35–35 –35 µg	ORTHONOVUM 7/7/7 (7+7+7 tabs)
POSTCOITAL PILL				
1. Levonorgestrel	0.25 mg	Ethinyl estradiol	50 µg	OVRAL, DUOLUTON-L (2+2 tabs)
2. Levonorgestrel	0.75 mg 1.5 mg	-Nil- -Nil-	— —	NORLEVO, ECCEE2 (1+1 tab) iPILL (1 tab)
MINI PILLS				
1. Norethindrone	0.35 mg	-Nil-	—	MICRONOR*, NOR-QD*
2. Norgestrel	75 µg	-Nil-	—	OVRETTE*

*Not marketed in India.

in overall risk of cervical, ovarian or hepatic cancer has been noted by a WHO sponsored study. Breast cancer risk may be slightly increased in younger women (< 35 yr). The logistics of administration and supervision for mass use are considered inadequate in developing countries. Use effectiveness in field conditions is low. In India approval has been granted for use only under close supervision, but not on mass scale under the National Programme.

(b) Menstrual irregularities, excessive bleeding or amenorrhoea are very common; incidence of amenorrhoea increases with increasing duration of use. Return of fertility may take 6–30 months after discontinuation; permanent sterility may occur in some women. Weight gain and headache occur in >5% subjects. Bone mineral density may decrease in long-term users due to low estrogen levels caused by Gn suppression. This may also produce menopause-like symptoms (hot flushes, vaginal dryness, reduced libido).

Two types of preparations have been tested:

(i) *Long acting progestin alone*—injected once in 2–3 months depending on the steroid and its amount. Two compounds have been marketed:

(a) Depot medroxyprogesterone acetate (DMPA) 150 mg at 3-month intervals. After i.m. injection peak blood levels are reached in 3 weeks and decline with a $t_{1/2}$ of ~ 50 days.

DEPOT-PROVERA 150 mg in 1 ml vial for deep i.m. injection during first 5 days of menstrual cycle. Repeat every 3 months.

(b) Norethindrone (Norethisterone) enanthate (NEE) 200 mg at 2-month intervals.

NORISTERAT 200 mg in 1 ml vial for deep i.m. injection during first 5 days of menstrual cycle. Repeat every 2 months.

The most important undesirable property is complete disruption of menstrual bleeding pattern and total amenorrhoea (more common with DMPA). It is not suitable for adolescent girls and lactating mothers. Use of DMPA is generally

restricted to women who are unlikely to use other contraceptives effectively. NEE is shorter acting and failure rates have been higher than with DMPA.

(ii) *Long acting progestin + long acting estrogen* — once a month. These have been tested to a more limited extent, but a combination of MPA + estradiol cypionate has been approved by USFDA for i.m. injection every month. Main advantage is that they allow a reasonable menstrual bleeding pattern in most cases. Their obvious disadvantage is that they contain a long acting estrogen which has potential to harm.

All fixed dose combination injectable preparations of synthetic estrogens and progestins are not allowed in India.

Implants These are drug delivery systems implanted under the skin, from which the steroid is released slowly over a period of 1–5 years. They consist of either—

(a) Biodegradable polymeric matrices—do not need to be removed on expiry.

(b) Non-biodegradable rubber membranes—have to be removed on expiry.

NORPLANT: A set of 6 capsules each containing 36 mg levonorgestrel (total 216 mg) for subcutaneous implantation is available in some countries, but has been discontinued in the USA. Works for up to 5 years.

A progesterone impregnated intrauterine insert (**PROGESTASERT**) has been introduced in some countries. It contains lesser quantity of progestin which primarily acts locally on endometrium. The device is to be replaced yearly and efficacy is rated lower.

MECHANISM OF ACTION

Hormonal contraceptives interfere with fertility in many ways; the relative importance depends on the type of method. This is summarized in Table 22.2.

1. Inhibition of Gn release from pituitary by reinforcement of normal feedback inhibition. The progestin reduces frequency of LH secretory pulses (an optimum pulse frequency is required for triggering ovulation) while the estrogen primarily reduces FSH secretion. Both synergise to inhibit midcycle LH surge. When the combined pill is taken both FSH and LH are reduced and the midcycle surge is abolished. As a result, follicles fail to develop and fail to rupture—*ovulation does not occur*.

The minipill and progestin only injectable regimen also attenuate LH surge but less consistently—ovulation occurs in ~ 1/3 cycles. However, pregnancy is still prevented by direct actions on the genital tract.

2. Thick *cervical mucus secretion hostile to sperm penetration* is evoked by progestin action. As such, this mechanism can operate with all methods except postcoital pill.

3. Even if ovulation and fertilization occur, the blastocyst may fail to implant because *endometrium* is either hyperproliferative or hypersecre-

Table 22.2: Effects of different forms of hormonal contraception

	Oral pills			Injections	
	Combined E + P	Minipill P only	Postcoital E+P/ only P	Combined E + P	Progestin only
1. FSH inhibition	++	–	–	+++	+
2. LH inhibition	+++	+	–	+++	+++
3. Antiovulatory effect	+++	+	–	+++	++
4. Hostile cervical mucus	+++	+++	–	+++	+++
5. Endometrium	Hypersecretory	Out of phase	Unfavourable	Hypersecretory	Atrophic
6. Failure rate (pregnancy/100 women years)	0.1–0.3	2–3	5–10	0	< 0.5
7. Contraceptive efficacy	++++	+++	++	++++	++++

E—Estrogen; P—Progestin

tory or atrophic and in any case *out of phase* with fertilization—not suitable for nidation. This action appears to be most important in case of minipills and postcoital pill.

4. *Uterine and tubal contractions* may be modified to disfavour fertilization. This action is uncertain but probably contributes to the efficacy of minipills and postcoital pill.

5. The postcoital pill may *dislodge* a just implanted blastocyst or may interfere with fertilization/implantation.

Practical considerations

1. Discontinuation of all OCs results in full return of fertility within 1–2 months. There may even be a rebound increase in fertility—chances of multiple pregnancy are more if conception occurs within 2–3 cycles. With injectable preparations, return of fertility is delayed. The cycles take several months to normalize or may not do so at all. They are to be used only if the risk of permanent infertility is acceptable.

2. If a woman on combined pills misses to take a tablet, she should be advised to take two tablets the next day and continue as usual. If more than 2 tablets are missed, then the course should be interrupted, an alternative method of contraception used and next course started on the 5th day of bleeding.

3. If pregnancy occurs during use of hormonal contraceptives—it should be terminated by suction-aspiration, because the risk of malformations, genital carcinoma in female offspring and undescended testes in male offspring is increased.

4. While for most women a pill containing 30 µg ethinylestradiol is sufficient, the obese may require one containing 50 µg, while those above 40 yr age may do with 20 µg.

5. If breakthrough bleeding occurs—switch over to a pill containing higher estrogen dose.

6. In women with contraindications for estrogen (*see below*), a progestin only contraceptive may be used.

7. For women who develop weight gain, acne or raised LDL cholesterol due to the androgenic

action of the older 19-nortestosterone progestin—a newer progestin (e.g. desogestrel) lacking androgenic action may be preferable.

ADVERSE EFFECTS

Since contraceptives are used in otherwise healthy and young women, adverse effects, especially long-term consequences assume great significance. The adverse effects are dose dependent; most of the past data with high-dose preparations cannot be directly extrapolated to the present-day low-dose preparations which carry relatively minor risk. The following applies primarily to combined oral pill which has been most extensively used.

A. Nonserious side effects These are frequent, specially in the first 1–3 cycles and then disappear gradually.

1. Nausea and vomiting: similar to morning sickness of pregnancy.
2. Headache is generally mild; migraine may be precipitated or worsened.
3. Breakthrough bleeding or spotting: specially with progestin only preparations. Amenorrhoea may occur in few, or the cycles may get disrupted: especially with injectables and minipill.
4. Breast discomfort.

B. Side effects that appear later

1. Weight gain, acne and increased body hair may be noted due to androgenic action of older 19-nortestosterone progestins. The newer ones like desogestrel lack this effect.
2. Chloasma: pigmentation of cheeks, nose and forehead, similar to that occurring in pregnancy.
3. Pruritus vulvae is infrequent.
4. Carbohydrate intolerance and precipitation of diabetes in few subjects taking high dose preparations; but this is unlikely with the present pills. Many large studies have found no link between OC use and development of diabetes.
5. Mood swings, abdominal distention are occasional; especially reported with progesterone only contraceptives.

C. Serious complications

1. *Leg vein and pulmonary thrombosis*: The older preparations increased the incidence of venous thromboembolism, but this is found to be only marginal with the newer reduced steroid content pills. However, even these pose significant risk in women >35 years of age, diabetics, hypertensives and those who smoke. The risk normalizes shortly after stopping the OC.

2. *Coronary and cerebral thrombosis* resulting in *myocardial infarction or stroke*: A 2 to 6-fold increase in risk was estimated earlier, but recent studies have found no increased incidence with the low dose pills in the absence of other risk factors.

The estrogen component of OC has been mainly held responsible for venous thromboembolism, while both estrogen and progestin have been blamed for the arterial phenomena. The mechanisms involved may be:

- Increase in blood clotting factors (coagulability is enhanced).
- Decreased antithrombin III.
- Decreased plasminogen activator in endothelium.
- Increased platelet aggregation.

3. *Rise in BP*: occurred in 5–10% women taking the earlier pills. This again is less frequent and smaller in magnitude with the low-dose pills of today. If the BP rises, best is to stop OCs—BP normalizes in the next 3–6 months. Both the estrogen and progestin components are responsible for this effect, probably by increasing plasma angiotensinogen level and renin activity which induces salt and water retention.

4. Estrogen tends to raise plasma HDL/LDL ratio (beneficial), but the progestin nullifies this benefit: lipid profile is not significantly altered by low dose OCs, except that triglyceride level may rise marginally which poses no excess risk.

5. *Genital carcinoma*: an increased incidence of vaginal, cervical, and breast cancers was feared on the basis of animal data, but extensive epidemiological data over the past 30 years has repeatedly shown that oral as well as injected contraceptives do not increase the occurrence of these cancers in the general population. How-

ever, risk is increased in predisposed individuals. Growth of already existing hormone dependent tumour may be hastened.

Epidemiological data has recorded minor increase in breast cancer incidence among current OC users, but not among past users. Since breast cancer is rare in young women, this finding is considered inconsequential.

A protective effect against endometrial carcinoma has been shown for the progestin component. Prolonged suppression of gonadotropic stimulation of ovary may account for the lower incidence of ovarian malignancy noted in contraceptive users.

6. *Benign hepatomas*: which may rupture or turn malignant; incidence of this rare tumour appears to be slightly higher in OC users.

7. *Gallstones*: Estrogens increase biliary cholesterol excretion; incidence of gallstones is slightly higher in women who are taking OCs, or after long-term use.

Contraindications

The combined oral contraceptive pill is absolutely contraindicated in:

1. Thromboembolic, coronary and cerebrovascular disease or a history of it.
2. Moderate-to-severe hypertension; hyperlipidaemia.
3. Active liver disease, hepatoma or h/o jaundice during past pregnancy.
4. Suspected/overt malignancy of genitals/breast.
5. Prophyria.
6. Impending major surgery—to avoid post-operative thromboembolism.

Relative contraindications (requiring avoidance/cautious use under supervision)

1. Diabetes: control may be vitiated.
2. Obesity
3. Smoking
4. Undiagnosed vaginal bleeding
5. Uterine leiomyoma: may enlarge with estrogenic preparations; progestin only pills can be used.
6. Mentally ill

7. Age above 35 years
8. Mild hypertension
9. Migraine
10. Gallbladder disease

Interactions Contraceptive failure may occur if the following drugs are used concurrently:

(a) *Enzyme inducers*: phenytoin, phenobarbitone, primidone, carbamazepine, rifampin. Metabolism of estrogenic as well as progestational component is increased.

(b) *Suppression of intestinal microflora*: tetracyclines, ampicillin, etc. No deconjugation of estrogens excreted in bile → their enterohepatic circulation is interrupted → blood levels fall.

With both types of interacting drugs, it is wise to switch over to a preparation containing 50–80 µg of ethinylestradiol or to use alternative method of contraception.

Other health benefits Apart from benefits due to prevention of unwanted pregnancy and the risks during delivery, use of oral contraceptives affords certain other beneficial effects as a bonus:

- Lower probability of developing endometrial and ovarian carcinoma; probably colorectal cancer as well.
- Reduced menstrual blood loss and associated anaemia; cycles if irregular become regular; premenstrual tension and dysmenorrhoea are ameliorated.
- Endometriosis and pelvic inflammatory disease are improved.
- Reduced incidence of fibrocystic breast disease and ovarian cysts.

Centchroman It is a nonsteroidal estrogen antagonist or SERM developed at CDRI, India and introduced in the National Family Welfare Programme as an oral contraceptive. It probably acts as an antiimplantation agent by inducing embryo-uterine asynchrony, accelerated tubal transport and suppression of decidualization. It prevents conception as long as taken, with return of fertility on withdrawal. Failure rate of 1–3% has been recorded. Pituitary, ovarian and other endocrine functions do not appear to be affected.

The menstrual cycle is not disturbed in most women, but in 6–10% it may be lengthened irregularly.

The usual side effects of hormonal contraceptives have not been noted. No derangement of laboratory tests including blood sugar and lipid profile have been detected. No teratogenic, mutagenic or carcinogenic effect has been observed so far. However, if pregnancy occurs centchroman should be discontinued immediately.

Centchroman has a long plasma $t_{1/2}$ (about 1 week). The recommended dose is 30 mg twice weekly for 12 weeks followed by once a week as long as fertility is to be suppressed. More experience has to be gained to decide its role as a contraceptive.

CENTRON, SAHELI 30 mg tab.

MALE CONTRACEPTIVE

The only way to suppress male fertility by drugs is to inhibit spermatogenesis. Though considerable effort has been made in this direction and effective drugs have been found, no satisfactory/acceptable solution is yet tangible. Reasons are—

1. Complete suppression of spermatogenesis is relatively difficult without affecting other tissues: millions of spermatozoa are released at each ejaculation *vs* a single ovum per month in women.
2. Spermatogenesis takes 64 days. A drug which even completely inhibited spermatogenesis will take a long latent period to produce infertility. Similarly, return of fertility will be slow.
3. Gonadotropin suppression inhibits testosterone secretion as well, resulting in loss of libido and impotence: unacceptable to all men and to most spouses.
4. Risk of adverse effects.
5. Most importantly—men don't get pregnant: few would be ready to bear the contingency of regular medication so that their sexual partners do not become pregnant.

Drugs and approaches tried are—

1. *Antiandrogens* Act by direct action on testes; cause unacceptable loss of libido.

2. *Estrogens and progestins* Act by suppressing Gns—cause unacceptable feminization.
3. *Androgens* They inhibit Gns but have poor efficacy; combination with progestin is more efficacious, preserves libido, but is still not reliable.
4. *Superactive Gn RH analogues* They inhibit Gn release after continued action; also inhibit testosterone secretion—produce impotence, loss of libido.
5. *Cytotoxic drugs* Cadmium, nitrofurans and indoles suppress spermatogenesis, but are toxic, often produce irreversible action.
6. *Gossypol* It is a nonsteroidal compound, obtained from cotton seed; has been studied in China. It is effective orally—causes suppression of spermatogenesis in 99%

men and reduces sperm motility—infertility develops after a couple of months; fertility is restored several months after discontinuation. However, about 10% men remain oligozoospermic for long periods after discontinuation. During treatment serum LH and testosterone levels do not change; libido and potency are not affected. It has no hormonal or antihormonal activity: mechanism of action is uncertain; probably involves direct toxicity on seminiferous epithelium.

Suggested dose is 20 mg/day for 2–3 months, followed by 40–60 mg/week.

Most important adverse effect is hypokalaemia (due to renal loss of K^+) with its attendant muscular weakness (even paralysis). Other side effects are—edema, diarrhoea, breathlessness and neuritis.



Drugs acting on uterus can primarily affect the endometrium or the myometrium. The most important drugs affecting endometrium are estrogens, progestins and their antagonists. Myometrium receives both sympathetic and parasympathetic innervation: autonomic drugs can affect its motility. However, directly acting drugs are more important and have more selective action. The responsiveness of myometrium to drugs is markedly affected by the hormonal and gestational status.

UTERINE STIMULANTS (Oxytocics, Abortifacients)

These drugs increase uterine motility, especially at term.

1. *Posterior pituitary hormone* Oxytocin, Desamino oxytocin
2. *Ergot alkaloids* Ergometrine (Ergonovine), Methylergometrine
3. *Prostaglandins* PGE₂, PGF_{2α}, 15-methyl PGF_{2α}, Misoprostol
4. *Miscellaneous* Ethacridine, Quinine.

OXYTOCIN

Oxytocin is a nonapeptide secreted by the posterior pituitary along with vasopressin (ADH). Pituitary extract was first used in labour in 1909.

Controversy as to whether the antidiuretic and uterine stimulating activities were due to one substance or two separate principles was finally resolved by du Vigneaud in 1953 when he separated *Oxytocin* and *Vasopressin*, determined their chemical structure and synthesized them. Both are nonapeptides which differ at positions 3 and 8.

Both oxytocin and ADH are synthesized within the nerve cell bodies in supraoptic and paraventricular nuclei of hypothalamus; are transported down the axon and stored in the nerve endings within the neurohypophysis. They are stored in separate neurones as complexes with their specific binding proteins (neurophysins). Both are released by stimuli appropriate for oxytocin—coitus, parturition, suckling; or for ADH—hypertonic saline infusion, water deprivation, haemorrhage, etc., or nonspecific—pain and apprehension. However, the proportion of oxytocin to ADH can vary depending upon the nature of the stimulus.

ACTIONS

1. **Uterus** Oxytocin increases the force and frequency of uterine contractions. With low doses, full relaxation occurs inbetween contractions; basal tone increases only with high doses.

Increased contractility is due to heightened electrical activity of the myometrial cell membrane—burst discharges are initiated and accentuated. Estrogens sensitize the uterus to oxytocin; increase oxytocin receptors. Nonpregnant uterus and that during early pregnancy is rather resistant to oxytocin; sensitivity increases progressively in the third trimester; there is a sharp increase near term and quick fall during puerperium. Progestins decrease the sensitivity, but this effect is not marked *in vivo*.

The increased contractility is restricted to the fundus and body; lower segment is not contracted, may even be relaxed at term.

Mechanism of action Action of oxytocin on myometrium is independent of innervation. There are specific G-protein coupled oxytocin receptors which mediate the response mainly by depolarization of muscle fibres and influx of Ca^{2+} ions as well as through phosphoinositide hydrolysis and IP_3 mediated intracellular release of Ca^{2+} ions. The number of oxytocin receptors increases markedly during later part of pregnancy. Oxytocin increases PG synthesis and release by the endometrium which may contribute to the contractile response. Distinct subtypes of oxytocin receptors have been shown on the myometrium and the endometrium.

2. Breast Oxytocin contracts myoepithelium of mammary alveoli and forces milk into the bigger milk sinusoids—'milk ejection reflex' (milk letdown in cattle) is initiated by suckling so that it may be easily sucked by the infant. It has been used in milch cattle to facilitate milking.

3. CVS Conventional doses used in obstetrics have no effect on BP but higher doses cause vasodilatation → brief fall in BP, reflex tachycardia and flushing. This action is most marked in chicken—used for bioassay. The umbilical vessels are markedly constricted; oxytocin may help in their closure at birth.

4. Kidney Oxytocin in high doses exerts an ADH-like action—urine output is decreased:

pulmonary edema can occur if large amounts of i.v. fluids and oxytocin are infused together. Conventional doses are without any effect.

Physiological role

1. Labour Oxytocin is released during labour and the uterus is highly sensitive to it at this time. However, it does not appear to be obligatory for initiating parturition—delivery occurs in hypophysectomized animals and humans, though labour may be prolonged in its absence. A facilitatory role is more plausible. PGs and PAF are complementary to oxytocin.

2. Milk ejection reflex It is mediated by oxytocin. The myoepithelial cells in breast are more sensitive than myometrium to oxytocin; milk ejection reflex is absent in the hypophysectomized.

3. Neurotransmission Oxytocin appears to function as a peptide neurotransmitter in the hypothalamus and brainstem to regulate autonomic neurones.

PHARMACOKINETICS

Being a peptide, oxytocin is inactive orally and is generally administered by i.m. or i.v. routes, rarely by intranasal spray. It is rapidly degraded in liver and kidney; plasma $t_{1/2}$ ~6 min, and is still shortened at term. Pregnant uterus and placenta elaborate a specific aminopeptidase called *oxytocinase*—which can be detected in maternal plasma.

Unitage and preparations 1 IU of oxytocin = 2 µg of pure hormone. Commercially available oxytocin is produced synthetically.

OXYTOCIN, SYNTOCINON 2 IU/2 ml and 5 IU/ml inj., PITOCIN 5 IU/0.5 ml inj.

USE

1. Induction of labour Labour needs to be induced in case of postmaturity or prematurely in toxemia of pregnancy, diabetic mother, erythroblastosis, ruptured membranes or

placental insufficiency. For this purpose oxytocin is given by slow i.v. infusion: 5 IU is diluted in 500 ml of glucose or saline solution (10 milli IU/ml)—infusion is started at a low rate and progressively accelerated according to response (0.2–2.0 ml/min). Before starting infusion, confirm that presentation is correct, foetal lungs are adequately mature, there is no cephalopelvic disproportion, no placenta previa, no foetal distress and no uterine scar (due to previous surgery). Uterine contractions are then closely monitored: the drug is discontinued when they are strong enough. Usually a total of 2–4 IU is needed.

2. Uterine inertia When uterine contractions are feeble and labour is not progressing satisfactorily—oxytocin can be infused i.v. (as described above) to augment contractions. It should not be used to hasten normally progressing labour. Too strong contraction can be catastrophic: use should only be made in selected cases and by experienced people.

Oxytocin is the drug of choice and is preferred over ergometrine/PGs for the above two purposes:

- Because of its short $t_{1/2}$ and slow i.v. infusion, intensity of action can be controlled and action can be quickly terminated.
- Low concentrations allow normal relaxation in between contractions—foetal oxygenation does not suffer.
- Lower segment is not contracted: foetal descent is not compromised.
- Uterine contractions are consistently augmented.

3. Postpartum haemorrhage, Cesarean section Oxytocin 5 IU may be injected i.m. or by i.v. infusion for an immediate response, especially in hypertensive women in whom ergometrine is contraindicated. It acts by forcefully contracting the uterine muscle which compresses the blood vessels passing through it to arrest haemorrhage from the inner surface exposed by placental separation.

4. Breast engorgement It may occur due to inefficient milk ejection reflex—oxytocin is effec-

tive only in such cases: an intranasal spray may be given few minutes before suckling. It does not increase milk production.

5. Oxytocin challenge test It is performed to determine utero-placental adequacy in high risk pregnancies. Oxytocin is infused i.v. at very low concentrations till uterine contractions are elicited every 3–4 mins. A marked increase in foetal heart rate indicates utero-placental inadequacy. The test is risky.

Adverse effects

- Injudicious use of oxytocin during labour can produce too strong uterine contractions forcing the presenting part through incompletely dilated birth canal, causing maternal and foetal soft tissue injury, rupture of uterus, foetal asphyxia and death.
- Water intoxication: because of ADH like action of large doses given along with i.v. fluids, especially in toxæmia of pregnancy and renal insufficiency. It is a serious (may be fatal) complication.

Desamino-oxytocin It has been developed as a buccal formulation; action is similar to injected oxytocin, but less consistent. Its indications are:

Induction of labour: 50 IU buccal tablet repeated every 30 min, max 10 tabs.

Uterine inertia: 25 IU every 30 min.

Promotion of uterine involution 25–50 IU 5 times daily for 7 days.

Breast engorgement 25–50 IU just before breast feeding.

BUCTOCIN 50 IU tab

ERGOMETRINE, METHYLERGOMETRINE

The pharmacology of ergot alkaloids is described in Ch. 12. Only the amine ergot alkaloid ergometrine (ergonovine) and its derivative methyl-ergometrine are used in obstetrics. Both have similar pharmacological property.

1. Uterus They increase force, frequency and duration of uterine contractions. At low doses, contractions are phasic with normal relaxation in between, but only moderate increase in dose raises the basal tone, contracture occurs with high doses. Gravid uterus is more sensitive, especially at term and in early puerperium. Their stimulant

action involves the lower segment also. The uterotonic action is believed to result from partial agonistic action on 5-HT₂ and α adrenergic receptors.

2. CVS Ergometrine and methylergometrine are much weaker vasoconstrictors than ergotamine and have low propensity to cause endothelial damage. Though they can raise BP, this is not significant at doses used in obstetrics.

3. CNS No overt effects occur at usual doses. However, high doses produce complex actions—partial agonistic/antagonistic interaction with adrenergic, serotonergic and dopaminergic receptors in the brain have been shown.

4. GIT High doses can increase peristalsis.

Methylergometrine is 1½ times more potent than ergometrine on the uterus, but other actions are less marked. It has thus replaced ergometrine at many obstetric units.

Pharmacokinetics In contrast to the amino acid ergot alkaloids, ergometrine and methylergometrine are rapidly and nearly completely absorbed from the oral route. The onset of uterine action is: Oral—15 min; i.m.—5 min; i.v.—almost immediate.

They are partly metabolized in liver and excreted in urine. Plasma $t_{1/2}$ is 1–2 hours. Effects of a single dose last 3–4 hours.

Adverse effects Ergometrine and methylergometrine are less toxic than ergotamine. When correctly used in obstetrics—hardly any complications arise, especially with methylergometrine. Nausea, vomiting and rise in BP occur occasionally. It can decrease milk secretion if higher doses are used for many days postpartum; this is due to inhibition of prolactin release (dopaminergic action).

Ergometrine should be avoided in—

- (i) patients with vascular disease, hypertension, toxæmia.
- (ii) presence of sepsis—may cause gangrene.
- (iii) liver and kidney disease.

They are contraindicated during pregnancy and before 3rd stage of labour.

Use

1. The primary indication for ergometrine/methylergometrine is to control and prevent postpartum haemorrhage (PPH): 0.2–0.3 mg i.m. at delivery of anterior shoulder reduces postpartal blood loss and prevents PPH. However, routine use in all cases is not justified—only in those expected to bleed more, e.g. grand multipara, uterine inertia. Multiple pregnancy should be excluded before injecting.

If PPH is occurring—0.5 mg i.v. is recommended.

These drugs produce sustained tonic uterine contraction: perforating uterine arteries are compressed by the myometrial meshwork—bleeding stops.

2. After cesarean section/instrumental delivery—to prevent uterine atony.

3. To ensure normal involution: A firm and active uterus involutes rapidly. To ensure this: 0.125 mg of ergometrine or methylergometrine has been given TDS orally for 7 days. However, routine use in all cases is not justified because normal involution is not hastened. Multipara and others in whom slow involution is feared—may be given prophylactically.

4. Diagnosis of variant angina: A small dose of ergometrine injected i.v. during coronary angiography causes prompt constriction of reactive segments of coronary artery that are responsible for variant angina.

ERGOMETRINE 0.25, 0.5 mg tab, 0.5 mg/ml inj.

Methylergometrine: **METHERGIN**, **METHERONE**, **ERGOMET** 0.125 mg tab, 0.2 mg/ml inj.

PROSTAGLANDINS

PGE₂, PGF_{2 α} and 15-methyl PGF_{2 α} are potent uterine stimulants, especially in the later part of pregnancy and cause ripening of cervix. Their actions and use in obstetrics is described in Ch. 13. Since misoprostol (a PG analogue used for peptic ulcer) produces less side effects, it is being used for obstetric indications also.

Ethacridine Available as 50 mg/50 ml solution (**EMCREDIL**, **VECREDIL**) for extra-amniotic infusion: 150 ml (containing 150 mg) is injected slowly for medical

termination of pregnancy in the 2nd trimester. This is an alternative method used occasionally.

UTERINE RELAXANTS (Tocolytics)

These are drugs which decrease uterine motility. They have been used to delay or postpone labour, arrest threatened abortion and in dysmenorrhoea. Suppression of labour may be needed to allow foetus to mature, to initiate glucocorticoid therapy for foetal lung maturation or to transfer the mother in labour to a centre with proper facilities, but no clearly satisfactory drug is available yet. An attempt to delay premature labour is likely to succeed only if cervical dilatation is < 4 cm and 'taking up' of lower segment is minimal. It should not be undertaken if membranes have ruptured, antepartum haemorrhage is occurring, in severe toxæmia of pregnancy, intrauterine infection or foetal death.

1. Adrenergic agonists (*see* Ch. 9) Ritodrine, the β_2 selective agonist having major uterine relaxant action is preferred to suppress premature labour and to delay delivery in case of some exigency or acute foetal distress. For dependable action it is started as 50 $\mu\text{g}/\text{min}$ i.v. infusion, the rate is increased every 10 min till uterine contractions cease or maternal HR rises to 120/min. Contractions are kept suppressed by continuing i.v. infusion or by 10 mg i.m. 4–6 hourly followed by 10 mg oral 4–6 hourly. Delivery can be postponed in about 70% cases by few hours to few weeks. However, cardiovascular (hypotension, tachycardia, arrhythmia, pulmonary edema) and metabolic (hyperglycaemia, hyperinsulinaemia, hypokalaemia) complications and anxiety, restlessness, headache occur frequently. Use of ritodrine to arrest labour has been found to increase maternal morbidity. The neonate may develop hypoglycaemia and ileus. It should not be used if mother is diabetic, having heart disease, or receiving β blockers or steroids.

YUTOPAR, RITROD 10 mg/ml inj (5 ml amp), 10 mg tab. RITODINE 10 mg tab, 10 mg in 1 ml inj.

Isosuprine oral/i.m. has been used to stop threatened abortion, but efficacy is uncertain.

2. Calcium channel blockers Because influx of Ca^{2+} ions plays an important role in uterine contractions, Ca^{2+} channel blockers (*see* Ch. 39) reduce the tone of myometrium and oppose contractions. These drugs, especially nifedipine, which has prominent smooth muscle relaxant action, can postpone labour if used early enough. Efficacy comparable to β_2 adrenergic agonists has been shown in some reports. Oral nifedipine 10 mg every 20–30 min till uterine contractions subside, followed by 10 mg 6 hourly has been used. Tachycardia and hypotension are prominent at doses which suppress uterine contractions. Reduced placental perfusion causing foetal hypoxia is apprehended. However, in one multicentric trial, its use in preterm labour was found to produce fewer maternal side effects than ritodrine. Also, fewer babies delivered after nifedipine needed intensive care.

3. Magnesium sulfate Given by i.v. infusion, it has been used for long to control convulsions and to reduce BP in toxæmia of pregnancy. As per WHO, it is the drug of choice for prevention and treatment of seizures in pre-eclampsia and eclampsia. An i.v. bolus (2–4 g over 10–20 min) is followed by 1 g/hr i.v. infusion regulated by the response. The international 'Magpie trial' (2002) among >10,000 preeclamptic women found that it halved the risk of developing eclampsia and reduced maternal mortality. Adverse effects were minor both in the mother and the baby.

Magnesium sulfate (i.v.) also suppresses uterine contractions and has been used to delay preterm labour. The efficacy is rated similar to β_2 agonists. However, a recent review (2002) has concluded that it is ineffective in preventing preterm birth. Higher infant mortality was noted in one trial after the use of mag. sulfate. It appears to increase perinatal mortality in low birth-weight offsprings, though it may be safer at term. Toxicity of i.v. mag. sulfate includes cardiac arrhythmias, muscular paralysis, CNS and respiratory depression in the mother as well as the neonate. Thus, its use as a tocolytic appears risky.

4. Oxytocin antagonist *Atosiban* is a peptide analogue of oxytocin that acts as antagonist at the oxytocin receptors. In clinical trials, it has been found to suppress premature uterine contractions and postpone preterm

delivery with fewer cardiovascular and metabolic complications than β_2 adrenergic agonists. However, benefit in terms of infant survival is uncertain, because in one trial higher neonatal mortality was recorded in the group treated with atosiban compared to placebo.

5. Miscellaneous drugs Ethyl alcohol, nitrates, progesterone, general anaesthetics and PG synthesis inhibitors

are the other drugs, which can depress uterine contractions. However, their effect is not dependable and they are rarely used clinically as tocolytics. Progesterone has been found to prevent miscarriage in some high risk cases.

Halothane is an efficacious uterine relaxant that has been used as the anaesthetic when external or internal version is attempted.



CALCIUM

After C, O, H and N, calcium is the most abundant body constituent, making up about 2% of body weight: 1–1.5 kg in an adult. Over 99% of this is stored in bones, the rest being distributed in plasma and all tissues and cells. Calcium serves important physiological roles.

Physiological roles

1. Calcium controls excitability of nerves and muscles and regulates permeability of cell membranes. It also maintains integrity of cell membranes and regulates cell adhesion.
2. Ca^{2+} ions are essential for excitation-contraction coupling in all types of muscle and excitation-secretion coupling in exocrine and endocrine glands, release of transmitters from nerve ending and other release reactions.
3. Intracellular messenger for hormones, autacoids and transmitters.
4. Impulse generation in heart—determines level of automaticity and A-V conduction.
5. Coagulation of blood.
6. Structural function in bone and teeth.

Plasma calcium level It is precisely regulated by 3 hormones almost exclusively devoted to this function, viz. *parathormone* (PTH), *calcitonin* and

calcitriol (active form of vit D). These regulators control its intestinal absorption, exchange with bone and renal excretion as summarized in Fig. 24.1. In addition, several other hormones, metabolites and drugs influence calcium homeostasis (see box).

Influences affecting bone turnover	
↑ Resorption	↓ Resorption
Corticosteroids	Androgens/Estrogens
Parathormone	Calcitonin
Thyroxine (excess)	Growth hormone
Hypervitaminosis D	Bisphosphonates
Prostaglandin E_2	Fluoride
Interleukin 1 & 6	Gallium nitrate
Alcoholism	Mithramycin
Loop diuretics	Thiazide diuretics

Normal plasma calcium is 9–11 mg/dl. Of this about 40% is bound to plasma proteins—chiefly albumin; 10% is complexed with citrate, phosphate and carbonate in an undissociable form; the remaining (about 50%) is ionized and physiologically important. For example, in hypoalbuminemia, total plasma calcium may be low but the concentration of Ca^{2+} ion is usually normal. Acidosis favours and alkalosis disfavours ionization of calcium: hyperventilation precipitates tetany and laryngospasm in calcium deficiency by reducing ionization.

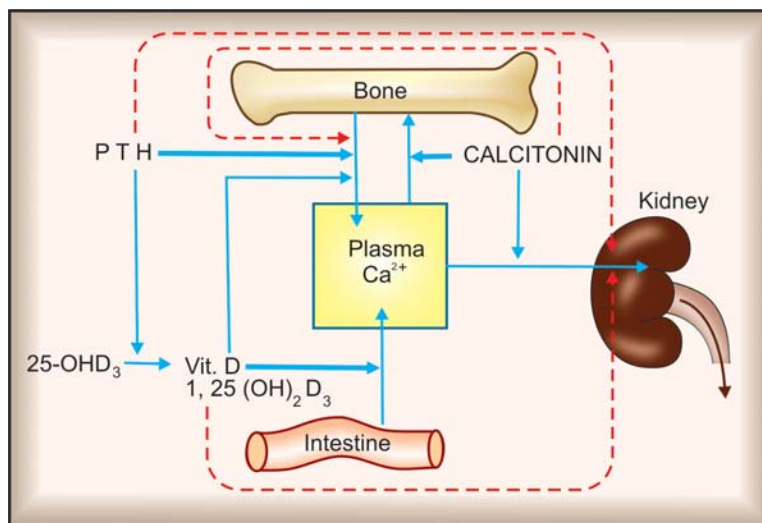

Fig. 24.1: Regulation of plasma level of calcium.

—→ stimulation, - - - - -→ Inhibition; Bold arrow indicates—major action.
 PTH—Parathormone; 25-OHD₃—Calcifediol; 1,25(OH)₂D₃—Calcitriol.

Calcium turnover Major fraction of calcium in the bone is stored as crystalline hydroxyapatite deposited on the organic bone matrix *osteoid*, while a small labile pool is in dynamic equilibrium with plasma. Even the fully laid down parts of the bone undergo constant *remodeling* by way of two closely coupled but directionally opposite processes of resorption and new bone formation (Fig. 24.2). Millions of tiny remodeling units are working on the surface of bone trabeculae and Haversian canals to dig micropits by osteoclastic activity and then repair by osteoblastic activity in which first collagen and other proteins (osteoid) are deposited followed by mineralization; the full cycle taking 4–6 months. Diet, exercise, several hormones and drugs regulate the number and efficiency of bone remodeling units at any given time. Remodeling deficits accumulate over life-time to account for age related bone loss, the pace of which can be retarded or accelerated by modulating the above listed influences. Estrogen lack after menopause mainly causes loss of trabecular bone, particularly affecting vertebrae, wrist bones and femoral neck. Minimal trauma/compression fractures are most common at these sites.

Absorption and excretion Calcium is absorbed by facilitated diffusion from the entire small intestine as well as from duodenum by a carrier-mediated active transport under the influence of vit D. Phytates, phosphates, oxalates and tetracyclines complex Ca²⁺ in an insoluble form in the intestines and interfere with absorption.

Glucocorticoids and phenytoin also reduce calcium absorption.

All ionized calcium is filtered at the glomerulus and most of it is reabsorbed in the tubules. Vit D increases and calcitonin decreases proximal tubular reabsorption, while PTH increases distal tubular reabsorption of Ca²⁺. About 300 mg of endogenous calcium is excreted daily: half in urine and half in faeces. To maintain calcium balance, the same amount has to be absorbed in the small intestine from the diet. Because normally only 1/3rd of ingested calcium is absorbed, the dietary allowance for calcium is 0.8–1.5 g per day. However, calcium deficiency and low dietary calcium increases fractional calcium absorption.

Thiazide diuretics impede calcium excretion by facilitating tubular reabsorption.

Preparations

1. Calcium chloride (27% Ca): is freely water soluble but highly irritating—tissue necrosis occurs if it is injected i.m. or extravasation takes place during i.v. injection. Orally also the solution irritates.
2. Calcium gluconate (9% Ca): is available as 0.5 g and 1 g tablets and 10% injection (5 ml amp.) It is nonirritating to g.i.t. and the vascular endothelium—a sense of warmth

is produced on i.v. injection; extravasation should be guarded. It is the preferred injectable salt.

3. Calcium lactate (13% Ca): is given orally, nonirritating and well tolerated.
4. Calcium dibasic phosphate (23% Ca): is insoluble, reacts with HCl to form soluble chloride in the stomach. It is bland; used orally as antacid and to supplement calcium.
5. Calcium carbonate (40% Ca): insoluble, tasteless and nonirritating. It has been used as an antacid—reacts with HCl to form chloride which may be absorbed from the intestines.

Side effects Calcium supplements are usually well tolerated; only g.i. side effects like constipation, bloating and excess gas (especially with cal. carbonate) have been reported.

Some combined formulations

CALCINOL-RB: Cal. carb 0.375 g, Cal. Phos 75 mg + vit D₃ 250 IU tab.

CALCIUM-SANDOZ: Cal. gluco-bionate 137.5 mg/ml inj. 10 ml amp., also tabs containing cal. carbonate 650 mg. **KALZANA:** Cal. dibasic phos 430 mg + Vit C and D₃ 200 IU tab, also syrup: Cal. gluconate 300 mg, Cal. lactobionate 1.1 g, Cal. phos. 75 mg per 5 ml, containing Vit A, C, niacinamide and D₃ 200 IU.

OSTOCALCIUM: Cal. phos 380 mg + Vit D₃ 400 IU tab, also syrup: Cal. phos 240 mg per 5 ml containing Vit D₃ 200 IU and B12.

SHELCAL: Cal. carb. 625 mg (eq 250 mg elemental cal), Vit D₃ 125 IU tab and per 5 ml syr.

MACALVIT: Cal. carb. 1.25 g, cholecalciferol 250 IU tab; Cal. gluconate 1.18 g, Cal. lactobionate 260 mg + Vit D₃ 100 IU per 5 ml syr.

CALCIMAX: Cal. carb. (150 mg cal), dibasic cal. phos. (23.3 mg cal) with magnesium, zinc and vit D₃ 200 IU tab.; also syrup cal. carb. (150 mg cal) with magnesium, zinc and vit D₃ 200 IU per 5 ml syrup.

Use

1. **Tetany** For immediate treatment of severe cases 10–20 ml of Cal. gluconate (elemental calcium 90–180 mg) is injected i.v. over 10 min, followed by slow i.v. infusion. A total of 0.45–0.9 g calcium (50 to 100 ml of cal. gluconate solution) over 6 hours is needed for completely reversing the muscle spasms. Supportive treatment with i.v. fluids and oxygen inhalation may be required. Long-term oral treatment to provide 1–1.5 g of calcium daily is instituted along with vit. D. Milder cases need oral therapy only.

2. **As dietary supplement** especially in growing children, pregnant, lactating and menopausal

women. The dietary allowance recommended by National Institute of Health (1994) is—

- Children 1–10 yr : 0.8–1.2 g
- Young adult 11–24 yr, pregnant and lactating women : 1.2–1.5 g
- Men 25–65 yr, women 25–50 yr and 51–65 yr if taking HRT : 1.0 g
- Women 51–65 yr not taking HRT, every one > 65 yr : 1.5 g

Calcium supplement can reduce bone loss in predisposed women as well as men. It is often given to fracture patients, but if diet is adequate this does not accelerate healing.

3. **Osteoporosis** In the prevention and treatment of osteoporosis with HRT/raloxifene/alendronate, it is important to ensure that calcium deficiency does not occur. Calcium + vit D₃ have adjuvant role to HRT/raloxifene/bisphosphonates in prevention and treatment of osteoporosis.

However, the efficacy of calcium ± vit D supplements alone in increasing bone mass or preventing fractures among menopausal women/elderly men is controversial. While several studies have reported a reduction in fracture risk, others have found no benefit. In the recently concluded 7 year prospective WHI study involving >36000 postmenopausal women (51–79 years), the overall risk of fractures was the same in the calcium (1 g/day) + vit D (400 IU/day) group as in the placebo group, though the bone mineral density at the hip was 1% higher in the treated group. Certain subgroups of osteoporotic subjects may benefit from calcium supplements, but the benefit appears to be marginal and limited to cortical bone loss only.

4. Empirically, Cal. gluconate i.v. has been used in dermatoses, paresthesias, weakness and other vague complaints. Any benefit is probably psychological due to warmth and other subjective effects produced by the injection.

5. As antacid (*see* Ch. 46).

PARATHYROID HORMONE (Parathormone)

Vassale and Generali (1900) were the first to perform selective parathyroidectomy (without removing thyroids) and found that it produced tetany and death. MacCallum

and Voegtlin in 1909 established this to be due to decrease in plasma calcium levels; parathormone (PTH) was isolated in 1925.

PTH is a single chain 84 amino acid polypeptide, MW 9500. It is synthesized as prepro-PTH, the excess amino acids are split off in two steps and it is then stored in intracellular vesicles. Secretion of PTH is regulated by plasma Ca^{2+} concentration through a calcium-sensing receptor (CaSR), that is a G-protein coupled receptor on the surface of parathyroid cells. There is no trophic hormone for it. Fall in plasma Ca^{2+} induces PTH release and rise inhibits secretion by decreasing cAMP in the parathyroid cells. Agents that increase cAMP cause PTH release, but direct activation of protein kinase C by fall in Ca^{2+} concentration is more important physiologically. Prolonged hypocalcaemia causes hypertrophy and hyperplasia of parathyroids, while sustained hypercalcaemia has the opposite effect. Changes in phosphate concentration in plasma affect PTH secretion indirectly by altering Ca^{2+} concentration. The active form of vit. D calcitriol inhibits expression of PTH gene in parathyroid cells. PTH is rapidly degraded in liver and kidney; its plasma $t_{1/2}$ is 2–5 min.

Actions

PTH increases plasma calcium levels by:

1. **Bone** PTH promptly increases resorption of calcium from bone. This is the most prominent action of PTH—exerted by increasing the number of bone remodeling units and activating osteoclasts when high concentrations are present continuously. Since bone resorption is followed by new bone deposition, this is also promoted by PTH: increased bone formation occurs when PTH is given intermittently and in low doses.
2. **Kidney** PTH increases calcium reabsorption in the distal tubule and provides moment to moment regulation of calcium excretion. It also promotes phosphate excretion which tends to supplement the hypercalcaemic effect. However, grossly increased plasma calcium level occurring in hyperparathyroidism overrides the direct

action on tubules and calcium excretion in urine is actually increased. The converse occurs in hypoparathyroidism.

3. **Intestines** PTH has no direct effect on calcium absorption but increases it indirectly by enhancing the formation of calcitriol (active form of vit D) in the kidney by activating 1α -hydroxylase. Calcitriol then promotes intestinal absorption of calcium.

4. PTH decreases calcium levels in milk, saliva and ocular lens—may be responsible for development of cataract in hypoparathyroidism.

Mechanism of action The PTH receptor is a G protein coupled receptor which on activation increases cAMP formation and intracellular Ca^{2+} in target cells. In bone, the target cell is the osteoblast because PTH receptors are not expressed on the surface of osteoclasts. Acting on the osteoblast, PTH induces a factor 'Receptor for activation of nuclear factor- κ B-ligand' (RANKL) which diffuses and combines with RANK on osteoclast precursors and transforms them into osteoclasts as well as activates osteoclasts (Fig. 24.2). Moreover, birth rate of bone remodeling units into which osteoclasts are recruited is enhanced. Formation of the remodeling pit is followed by osteoblastic deposition of new bone into it. PTH enhances proliferation and differentiation of preosteoblasts and deposition of osteoid as well. Bone resorption predominates when high concentrations of PTH are present continuously, but intermittent exposure to low concentrations has the opposite effect.

Hypoparathyroidism Manifestations are:

Low plasma calcium levels, tetany, convulsions, laryngospasm, paresthesias, cataract and psychiatric changes. Pseudohypoparathyroidism occurs due to reduced sensitivity of target cells to PTH caused by a mutant G protein that couples PTH receptor activation to cAMP generation in target cells.

Hyperparathyroidism It is mostly due to parathyroid tumour. It produces—

Hypercalcaemia, decalcification of bone—deformities and fractures (osteitis fibrosa generalisata), metastatic calcification, renal stones, muscle weakness, constipation and anorexia.

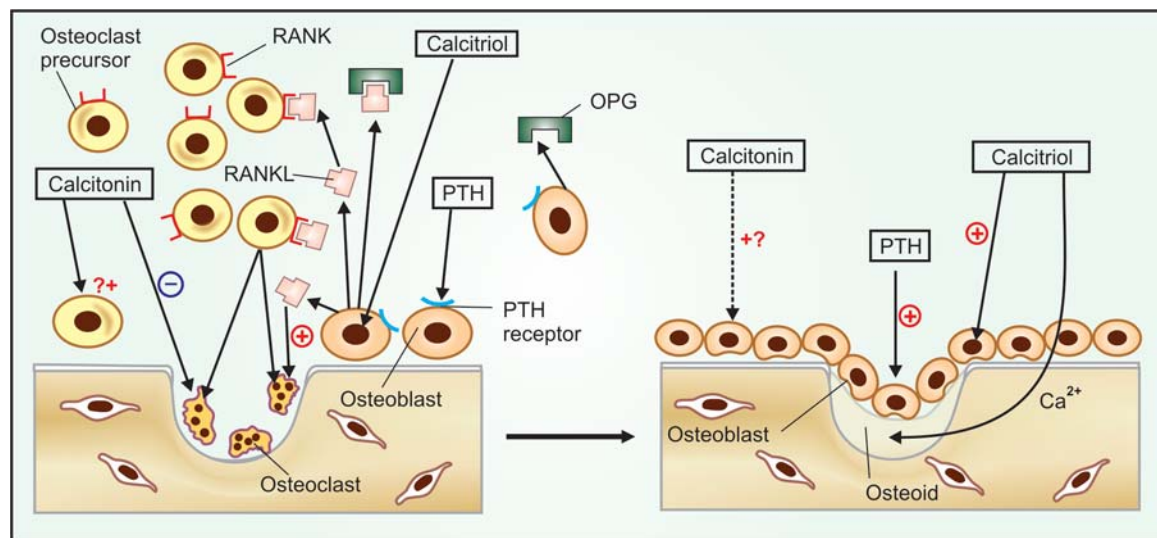

Fig. 24.2: Hormonal regulation of bone remodeling unit

The monocyte osteoclast precursor cells in the marrow near the bony surface are activated to proliferate and fuse to form multinucleated osteoclasts. The osteoclast-precursors express a 'receptor for activation of nuclear factor- κ B' (RANK) on their surface. The osteoblasts on activation release a protein RANK-ligand (RANKL). When RANKL is bound to RANK on the surface of osteoclast-precursors they are transformed into mature osteoclasts and develop bone lysing ruffled surface. A bone resorption pit is dug out by secretion of acid and proteolytic acid hydrolases.

Osteoblasts produce another protein osteoprotegerin (OPG) as well, which can bind RANKL and prevent it from combining with RANK to activate osteoclasts. Thus, osteoblasts by producing RANKL and OPG regulate bone resorption.

After formation of the remodeling pit, preosteoblasts from bone marrow stem cells proliferate, migrate to the base of the pit, transform into mature osteoblasts and laydown new osteoid, which is later mineralized.

Parathormone (PTH) acts on PTH-receptor located on the osteoblast membrane and induces RANKL production—indirectly activating osteoclast differentiation and function. Subsequently PTH promotes new bone formation as well.

Calcitriol also induces RANKL in osteoblasts to indirectly activate osteoclasts. Similarly, it promotes laying of osteoid as well as bone mineralization.

Calcitonin directly inhibits osteoclast function and probably enhances osteoblastic new bone formation.

Treatment is surgical removal of the parathyroid tumour. When this is not possible—low calcium, high phosphate diet with plenty of fluids is advised.

Cinacalcet It activates the Ca^{2+} sensing receptor (CaR) in the parathyroids and blocks PTH secretion. It is indicated in secondary hyperparathyroidism due to renal disease and in parathyroid tumour.

Use PTH is not used in hypoparathyroidism because plasma calcium can be elevated and kept in the normal range more conveniently by vit D therapy. PTH has to be given parenterally, while vit D can be given orally. Vit D is cheap. However, recombinant human PTH (1–84 amino acid) has been produced and is being clinically tested.

Teriparatide This recombinant preparation of 1–34 residues of amino terminal of human PTH has been recently approved for the treatment of severe osteoporosis. It

duplicates all the actions of long (1–84) PTH. Injected s.c. once daily, it has been found to increase bone mineral density in osteoporotic women. The effect was faster and more marked than that produced by estrogens and bisphosphonates (BPNs). Teriparatide is the only agent which stimulates bone formation, whereas the other two only check bone resorption. In clinical trials it was found to be equally or more effective than estrogens and BPNs in reducing risk of vertebral as well as non-vertebral fractures. Its plasma $t_{1/2}$ is 1 hr; given once daily only intermittent action is produced and bone forming action predominates over bone resorbing action. High cost and need for daily s.c. injections are the limitations.

Diagnostic use To differentiate pseudo from true hypoparathyroidism: teriparatide is given i.v.: if plasma calcium level fails to rise, then it is pseudohypoparathyroidism.

CALCITONIN

Calcitonin is the hypocalcaemic hormone discovered by Copp in 1962. It is a 32 amino acid single chain polypeptide (MW 3600) produced by parafollicular 'C' cells of thyroid. Parathyroids, thymus and cells of medullary carcinoma of thyroid also contain calcitonin.

Synthesis and secretion of calcitonin is regulated by plasma Ca^{2+} concentration itself: rise in plasma Ca^{2+} increases, while fall in plasma Ca^{2+} decreases calcitonin release. However, the physiological role of calcitonin in regulating plasma Ca^{2+} appears to be minor. The plasma $t_{1/2}$ of calcitonin is 10 min, but its action lasts for several hours.

Actions

The actions of calcitonin are generally opposite to that of PTH. It inhibits bone resorption by direct action on osteoclasts—decreasing their ruffled surface which forms contact with the resorptive pit. Whether it also promotes calcium deposition by osteoblasts is not certain. The hypocalcaemic action of calcitonin lasts ~8 hours.

Calcitonin inhibits proximal tubular calcium and phosphate reabsorption by direct action on kidney. However, hypocalcaemia overrides the direct action by decreasing the total calcium filtered at the glomerulus—urinary Ca^{2+} is actually reduced.

The actions of calcitonin are mediated through a G-protein coupled receptor and increase in cAMP formation, but its target cells are different from that of PTH.

Preparation and unitage Synthetic salmon calcitonin is used clinically, because it is more potent due to slower metabolism. Human calcitonin has also been produced. 1 IU = 4 μg of standard preparation.

CALSYNAR, ZYCALCIT: Synthetic salmon calcitonin 100 IU/ml amp. for i.m. or s.c. injection.

Adverse effects experienced are nausea, flushing, tingling of fingers, bad taste and allergic reaction. By lowering plasma Ca^{2+} calcitonin may interfere with the action of digoxin.

Uses

1. *Hypercalcaemic states* Hyperparathyroidism, hyper-vitaminosis D, osteolytic bony metastasis and hypercalcaemia of malignancy; 4–8 IU/kg i.m. 6–12 hourly only for 2 days. It acts rapidly within 4 hours, the response peaks at 48 hours and then refractoriness develops. Calcitonin is a relatively weak hypocalcaemic drug. Therefore, used only to supplement BPNs initially, because they take 24–48 hours to act.

2. *Postmenopausal osteoporosis:* 100 IU s.c. or i.m. daily along with calcium and vit D supplements.

A nasal spray formulation delivering 200 IU per actuation has become available (**MIACALCIN NASAL SPRAY 2200 IU in 2 ml**). One spray in one nostril daily has been shown to increase bone mineral density in menopausal women. It is less effective than HRT/BPNs. Calcitonin is indicated only when other drugs cannot be given and in women who are menopausal for at least 5 years with definite evidence of osteoporosis. Rhinitis, epistaxis, nasal ulceration and headache are the side effects.

3. *Paget's disease* 100 U daily or on alternate days produces improvement for few months. Later, resistance usually develops due to production of antibodies. Bisphosphonates are preferred; calcitonin may be used as adjuvant or 2nd line drug.

VITAMIN D

Vitamin D is the collective name given to antirachitic substances synthesized in the body and found in foods activated by UV radiation.

D3: cholecalciferol — synthesized in the skin under the influence of UV rays.

D2: calciferol—present in irradiated food—yeasts, fungi, bread, milk.

D1: mixture of antirachitic substances found in food—only of historic interest.

In 1919 it was established that rickets was due to deficiency of a dietary factor as well as lack of exposure to sunlight. McCollum (1922) showed that this fat soluble dietary factor was different from vit A and its structure was determined in 1935. The interrelation between calciferol and cholecalciferol and their activation in the body has been fully understood only in the 1970s.

Activation of vit D It takes place in the following manner—

Ergosterol differs from 7-dehydrocholesterol in having an extra double bond between C22–23 and a methyl group at C24. In man vit D₂ and D₃ are equally active and *calcitriol* (active form of D₃) is

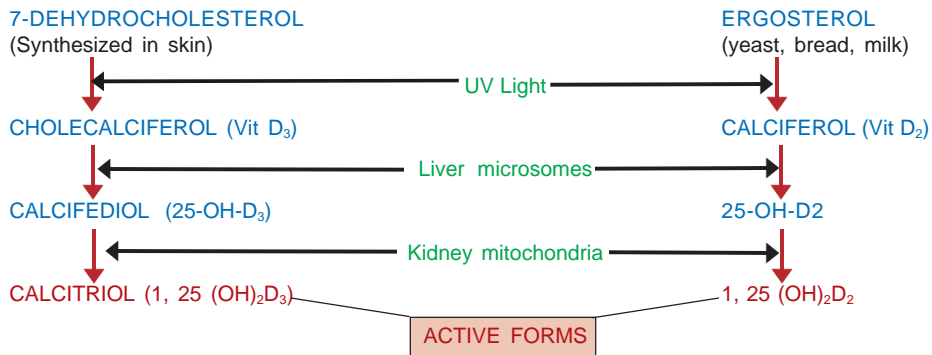

more important physiologically; 25-OH D₃ is released in blood from the liver and binds loosely to a specific vit D binding globulin. The final hydroxylation in kidney is rate limiting and is controlled by many factors. This step is activated or induced by calcium/vit D deficiency as well as by PTH, estrogens and prolactin, while calcitriol inhibits it in a feedback manner.

Thus, vit D should be considered a hormone because:

- It is synthesized in the body (skin); under ideal conditions it is not required in the diet.
- It is transported by blood, activated and then acts on specific receptors in the target tissues.
- Feedback regulation of vit D activation occurs by plasma Ca²⁺ level and by the active form itself.

Actions

- Calcitriol enhances absorption of calcium and phosphate from *intestine*. This is brought about by increasing the synthesis of calcium channels and a carrier protein for Ca²⁺ called 'calcium binding protein' (Ca BP) or *Calbindin*. The action of calcitriol is analogous to that of steroid hormones. It binds to a cytoplasmic vitamin D receptor (VDR) → translocate to the nucleus → increase synthesis of specific mRNA → regulation of protein synthesis. Another line of evidence suggests that activation of VDR promotes endocytotic capture of calcium and transports it across the duodenal mucosal cell in vesicular form. At least part of vit D action is quick (within

minutes) and, therefore, appears to be exerted by mechanisms not involving gene regulation.

- Calcitriol enhances resorption of calcium and phosphate from *bone* by promoting recruitment and differentiation of osteoclast precursors in the bone remodeling units, but mature osteoclasts lack VDR. Like PTH, calcitriol induces RANKL in osteoblasts which may then activate the osteoclasts. Osteoblastic cells express VDR and respond to calcitriol by laying down osteoid, but it mainly appears to help bone mineralization indirectly by maintaining normal plasma calcium and phosphate concentration. Its action is independent of but facilitated by PTH.

- Calcitriol enhances tubular reabsorption of calcium and phosphate in the *kidney*, but the action is less marked than that of PTH. However, in hypervitaminosis D, influence of hypercalcaemia overrides the direct action and more calcium is excreted in urine.

- Other actions* Actions of calcitriol on immunological cells, lymphokine production, proliferation and differentiation of epidermal and certain malignant cells, neuronal and skeletal muscle function have also been demonstrated.

Vit D deficiency Plasma calcium and phosphate tend to fall due to inadequate intestinal absorption. As a consequence, PTH is secreted → calcium is mobilized from bone in order to restore plasma Ca²⁺. The bone fails to mineralize normally in the newly laid area, becomes soft → rickets in children and osteomalacia in adults. However, in contrast to *osteoporosis*, the organic matrix (osteoid) is normal in these conditions.

Hypervitaminosis D It may occur due to chronic ingestion of large doses (~50,000 IU/day) or due to increased sensitivity of tissues to vit D. Manifestations are due to elevated plasma calcium and its ectopic deposition.

Hypercalcaemia, weakness, fatigue, vomiting, diarrhoea, sluggishness, polyuria, albuminuria, ectopic Ca^{2+} deposition (in soft tissues, blood vessels, parenchymal organs), renal stones or nephrocalcinosis, hypertension, growth retardation in children. Even coma has been reported. *Treatment:* consists of withholding the vitamin, low calcium diet, plenty of fluids and corticosteroids. Recovery may be incomplete in many cases.

Pharmacokinetics

Vit D is well absorbed from the intestines in the presence of bile salts, mainly through lymphatics. Absorption of D_3 form is somewhat better than that of D_2 . Malabsorption and steatorrhoea interfere with its absorption.

In the circulation, it is bound to a specific α globulin and is stored in the body, mostly in adipose tissues, for many months. It is hydroxylated in the liver to active and inactive metabolites. The $t_{1/2}$ of different forms varies from 1–18 days: 25-OHD₃, having the longest $t_{1/2}$, constitutes the primary circulating form. Calcitriol is cleared rapidly.

Metabolites of vit D are excreted mainly in bile.

Unitage and preparations

1 μg of cholecalciferol = 40 IU of vit D.

The daily requirement varies, depending on exposure to sunlight. It is estimated that if no vit D₃ is synthesized in the body, a dietary allowance of 400 IU/day will prevent deficiency symptoms. The forms in which vit D is supplied are—

1. *Calciferol (Ergocalciferol, vit D₂)* As solution in oil, filled in gelatin capsules 25,000 and 50,000 IU caps.

2. *Cholecalciferol (vit D₃)* As granules for oral ingestion and oily solution for i.m. injection.

ARACHITOL 300,000 IU (7.5 mg) and 600,000 IU (15 mg) per ml inj.

CALCIROL 60,000 IU in 1 g granules—given at 3–4 weeks intervals, and then every 2–6 months.

3. *Calcitriol* 0.25–1 μg orally daily or on alternate days; CALTROL, ROLSICAL, ROCALTROL 0.25 μg cap. CALCI-BEST 1 μg in 1 ml aqueous inj; 0.5–1 μg i.v. on alternate days.

Hypercalcaemia is the main adverse effect; must be watched for and therapy promptly stopped if plasma Ca^{2+} rises.

4. *Alfacalcidol* It is 1 α -OHD₃—a prodrug that is rapidly hydroxylated in the liver to 1, 25 (OH)₂ D₃ or calcitriol. Therefore, it does not require hydroxylation at position 1 which is the limiting step in the generation of the active form of vit D, and which takes place in the kidney. As such, it is effective in renal bone disease, vit D dependent rickets, vit D resistant rickets, hypoparathyroidism, etc.—indications for which calcitriol is needed. It is also being used in osteoporosis.

Alfacalcidol is orally active and clinically equally effective on long term basis to calcitriol. Its metabolic activation in liver does not pose a problem even in severe liver disease.

Dose: 1–2 μg /day, children < 20 kg 0.5 μg /day. Repeated serum calcium measurements are essential for regulation of maintenance dose. Hypercalcaemia should be watched for and therapy promptly interrupted for few days when it develops.

ONE ALPHA, ALPHA D₃, ALPHADOL 0.25 and 1 μg caps, ALFACAL 0.25, 0.5 μg caps.

5. *Dihydrotachysterol (DHT)* A synthetic analogue of vit D₂—less active in antirachitic tests, but directly mobilizes calcium from bone: does not require PTH dependent activation in the kidney—particularly useful in hypoparathyroidism and renal bone disease.

Dose: 0.25–0.5 mg/day.

Combination preparations of vit D are listed in Table 67.2.

Use

1. *Prophylaxis* (400 IU/day) and treatment (3000–4000 IU/day) of nutritional vit D deficiency which causes rickets in children and osteomalacia in adults. Alternatively 300,000–600,000 IU can be given orally or i.m. once in 2–6 months. Prophylactic treatment may be given in obstructive jaundice, steatorrhoea and other conditions which predispose to vit D deficiency.

2. *Metabolic rickets* These are a group of conditions in which tissues do not respond to normal doses of vit D.

(a) *Vit D resistant rickets:* X-linked hereditary disease in which vit D metabolism is normal but calcium and phosphate metabolism is deranged. Administration of phosphate with high dose of calcitriol or alfacalcidol is beneficial.

(b) *Vit D dependent rickets:* Another genetic disorder due to deficiency of renal hydroxylating mechanism which converts 25-OHD₃ into calcitriol. Administration of calcitriol or alfacalcidol is effective in normal doses.

(c) *Renal rickets*: Conversion of 25-OHD₃ into calcitriol does not occur due to chronic renal disease. Calcitriol/alfacalcidol or dihydrotachysterol are needed in usual doses.

3. *Senile or postmenopausal osteoporosis* Age-related decrease in calcium absorption from gut has been noted. Vit D₃ + calcium have been shown to improve calcium balance in osteoporotic females and elderly males. However, benefit in terms of improved bone mass or reduced fracture risk is controversial or marginal (*see p. 327*). But this does not apply to active therapy with calcitriol/alfacalcidol for patients with established osteoporosis, because it suppresses parathyroids and reduces bone remodeling. Vit D deficiency results in secondary hyperparathyroidism which contributes to osteoporosis. Though bone mineral density may be improved, calcitriol therapy carries the risk of hypercalcaemia, calcium stones and metastatic calcification.

4. *Hypoparathyroidism* Dihydrotachysterol or calcitriol/alfacalcidol are more effective than vit D₂ or D₃ because they act quickly and directly without the need for hydroxylation in kidney which needs PTH. Alternatively, conventional preparations of vit D₃ may be given in high doses (25000-100,000 IU/day).

5. *Fanconi syndrome* Vit D can raise the lowered phosphate levels that occur in this condition.

6. A nonhypercalcaemic analogue of vit D *Calcipotriol* (DAIVONEX 0.005% oint) is used locally in plaque type psoriasis, and has yielded good results (*see Ch. 64*). Systemically it has been tried in skin cancer and immunological disorders.

Interactions

1. Cholestyramine and chronic use of liquid paraffine can reduce vit D absorption.
2. Phenytoin and phenobarbitone reduce the responsiveness of target tissues to calcitriol; their prolonged use (for epilepsy) can cause rickets/osteomalacia. It was believed earlier that these drugs enhance degradation of vit D. However, now it has been shown that plasma level of

calcitriol is normal, but its effect on intestine and bone is diminished.

BISPHOSPHONATES

Bisphosphonates (BPNs) are analogues of pyrophosphate: carbon atom replacing oxygen in the P-O-P skeleton. They inhibit bone resorption and have recently attracted considerable attention because of their ability to prevent osteoporosis in addition to their usefulness in metabolic bone diseases and hypercalcaemia. They are the most effective antiresorptive drugs. Chronologically and according to potency, the BPNs can be grouped into 3 generations (*see box*). The first generation compounds have simpler side chains, are the least potent and seldom used now. The second and third generation compounds have an amino or nitrogenous ring substitution in the side chain, are more potent, have higher efficacy and additional mode of action.

Bisphosphonate	Relative potency
<i>First generation BPNs</i>	
Etidronate	1
*Tiludronate	10
<i>Second generation BPNs</i>	
Pamidronate	100
Alendronate	100–500
*Ibandronate	500–1000
<i>Third generation BPNs</i>	
Risedronate	1000
Zoledronate	5000

* Not marketed in India

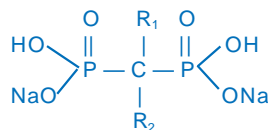

Bisphosphonate

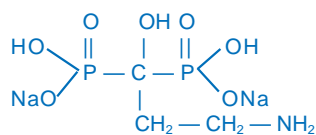

Pamidronate

The mechanism of action of BPNs is not fully understood, but two facets of action have been delineated:

(a) BPNs have strong affinity for calcium phosphate: have selective action in calcified tissue. The two main components of bone are protein matrix and the solid mineral phase (hydroxyapatite). On the surface of resorptive pits the mineral phase is solubilized in the clear acidic zone created at the ruffled border of osteoclasts, followed by resorption of protein matrix in this area by acid hydrolases secreted from osteoclasts. BPNs localise in the acidic zone under the osteoclasts due to their high affinity for Ca^{2+} ions. When Ca^{2+} ions are released from the bone surface due to high acidity, the BPNs are also released and are internalized into osteoclasts by endocytosis. This results in:

- Accelerated apoptosis of osteoclasts reducing their number.
- Disruption of cytoskeleton and ruffled border of osteoclasts.

In addition, BPNs appear to affect osteoclast precursors and inhibit their differentiation by suppressing IL-6.

(b) It has been shown recently that BPNs, especially the second and third generation potent amino-derivatives like alendronate, zoledronate, have important metabolic effects in the mevalonate pathway for isoprenoid lipid synthesis. They inhibit prenylation of certain GTP-binding proteins involved in cytoskeletal organization, membrane ruffling and vesicle movement. The net result is inactivation of osteoclasts, impaired vesicle fusion and enhanced apoptosis. Interference with mevalonate pathway may also impart antitumor action on bony metastasis.

All oral BPNs are poorly absorbed, and produce gastric irritation, esophagitis as the major side effect. They are contraindicated in gastroesophageal reflux, peptic ulcer and renal impairment.

The BPNs are useful in conditions characterized by enhanced bone turnover.

1. Osteoporosis The second and third generation BPNs (e.g. alendronate, risedronate)

are effective in preventing and treating postmenopausal osteoporosis in women as well as age related, idiopathic and steroid-induced osteoporosis in both men and women. Alendronate has been found equally or more effective than HRT or raloxifene in conserving bone mineral density and has reduced the risk of vertebral as well as hip fracture by 47–56%.

Estrogens prevent vertebral but not other fractures. BPNs are more effective than calcitonin and continue to afford protection for at least 5 years of continuous use.

2. Paget's disease This disease due to abnormal osteoclast function producing disordered bone remodeling and honeycomb-like bone architecture is benefited by BPNs. They arrest osteolytic lesions, reduce bone pain and improve secondary symptoms. Long-lasting remissions may be induced. Alendronate, risedronate, pamidronate and zoledronate are used now. They are more convenient, more effective and cheaper than calcitonin. Combined use of BPNs and calcitonin further increases efficacy. Treatment with BPNs should not exceed 6 months; but courses may be repeated after a gap.

3. Hypercalcaemia of malignancy Severe hypercalcaemia, a common complication of malignancy, is a medical emergency with altered consciousness. Pamidronate (60–90 mg i.v. over 2–4 hours) or zoledronate (4 mg i.v. over 15 min) are the most effective drugs, but take 24–48 hours to act. They may be supplemented by i.m. calcitonin 6–12 hourly for 2 days for rapid action. Vigorous i.v. hydration along with furosemide to prevent volume overload is started before BPN infusion. It reduces serum calcium within few hours and corrects the attending dehydration. Oral BPNs are not useful.

4. Osteolytic bone metastasis Parenteral pamidronate/zoledronate arrests osteolytic lesions and reduces bone pain.

Etidronate This is the first BPN to be used clinically, employed in hypercalcaemia and Paget's disease. However, it also interferes with bone mineralization: continuous

therapy produces osteomalacia. Therefore, it has been largely replaced by zoledronate for hypercalcaemia and alendronate/risedronate for Paget's disease. Etidronate is administered both orally and i.v., but is not preferred now. Adverse effects are gastric irritation, bone pain, headache, metallic taste, pyrexia and hypersensitivity.

Dose: 5–7.5 mg/kg/day; DRONATE-OS 200 mg tab, 300 mg inj; DISONATE, ETIFEM 200 mg tab.

Pamidronate A second generation potent BPN which is administered only by i.v. infusion in a dose of 60–90 mg over 2–4 hours weekly or monthly depending on the condition. It is used in Paget's disease, hypercalcaemia of malignancy and in bony metastasis. Adverse effects are thrombophlebitis of injected vein, bone pain, fever and leukopenia. A flue-like reaction may occur initially due to cytokine release.

AREDIA 15, 30, 60 mg inj; AREDRONET 30, 90 mg inj. BONAPAM 30, 60, 90 mg inj.

Alendronate This potent orally effective second generation amino-BPN is used primarily for prevention and treatment of osteoporosis both in women and men. It is to be taken on empty stomach in the morning with a full glass of water and patient is instructed not to lie down or take food for at least 30 min. These measures are needed to prevent contact with esophageal mucosa which results in esophagitis. Calcium, iron, antacids, mineral water, tea, coffee, fruit juice interfere with alendronate absorption. NSAIDs accentuate gastric irritation caused by alendronate. Other adverse effects are gastric erosion, retrosternal pain, flatulence, headache, bodyache and initial fall in serum Ca²⁺ level.

Dose: 5–10 mg OD; or 35–70 mg weekly; weekly treatment is as effective, more convenient and better tolerated. OSTEOPHOS, 5, 10, 35, 70 mg tab. DENFOS 5, 10 mg tab, RESTOFOS, DRONAL 10 mg tab.

Oral bioavailability of alendronate is ~1%. Up to 50% of the drug entering the body is sequestered in bone while the rest is excreted unchanged mainly by the kidney. The terminal elimination t_{1/2} of alendronate has been measured as 10.5 years.

Risedronate It is an oral 3rd generation BPN, more potent than alendronate, but equally efficacious. Oral bioavailability of 1% and other features are also similar to alendronate. It is indicated in the treatment of osteoporosis and Paget's disease.

Dose: 35 mg/week oral in the morning with a full glass of water.

RESTOFOS, GEMFOS, ACTONEL 35 mg tab.

Zoledronate This parenteral highly potent 3rd generation BPN is indicated for hypercalcaemia, bony metastasis and Paget's disease. Osteoclastic activity is markedly suppressed and an additional antitumor effect may be exerted by interference with mevalonate pathway. Proliferation of bony metastasis of prostate/breast cancer and multiple myeloma cells may be arrested. For hypercalcaemia, it is more effective, faster acting than pamidronate and therefore the drug of choice now. Another advantage is that it can be infused over 15 min (because of less venous irritation), whereas pamidronate needs 2–4 hours. Flue-like symptoms due to cytokine release attend the i.v. infusion. Renal toxicity has been encountered.

Dose: 4 mg diluted in 100 ml saline/glucose solution and infused i.v. over 15 min; may be repeated after 7 days and then at 3–4 week intervals.

ZOBONE, ZOLDRIA 4 mg/vial inj.

Other drugs for hypercalcaemia

1. **Gallium nitrate:** It is a potent inhibitor of bone resorption; acts by depressing ATP-dependent proton pump at the ruffled membrane of osteoclasts. Indicated in resistant cases of hypercalcaemia, it is given by continuous i.v. infusion daily for 5 days. It is nephrotoxic and only a reserve drug.

2. **Mithramycin (Plitamycin)** A cytotoxic drug which inhibits bone resorption in 10 times lower doses than for cancer. It is used only in non-responsive cases of hypercalcaemia and Paget's disease. Toxicity is high.

3. **Glucocorticoids:** High doses of prednisolone (and others) enhance calcium excretion, decrease calcium absorption and have adjuvant role in hypercalcaemia due to lymphoma, myeloma, leukaemia, carcinoma breast, etc.

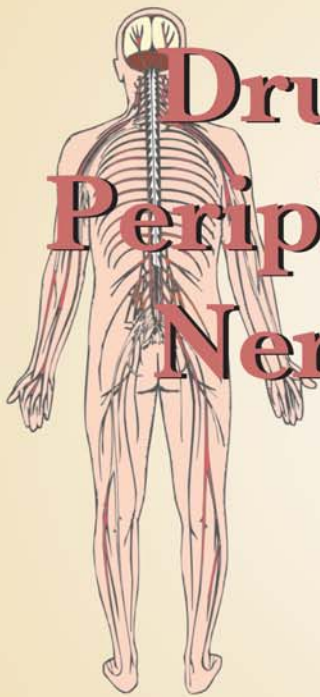

Drugs Acting on Peripheral (Somatic) Nervous System



SECTION
6

CHAPTER 25

Skeletal Muscle Relaxants

Skeletal muscle relaxants are drugs that act peripherally at neuromuscular junction/ muscle fibre itself or centrally in the cerebrospinal axis to reduce muscle tone and/or cause paralysis. The neuromuscular blocking agents are used primarily in conjunction with general anaesthetics to provide muscle relaxation for surgery, while centrally acting muscle relaxants are used mainly for painful muscle spasms and spastic neurological conditions.

PERIPHERALLY ACTING MUSCLE RELAXANTS

I. Neuromuscular blocking agents

A. Nondepolarizing (Competitive) blockers

1. *Long acting:* d-Tubocurarine, Pancuronium, Doxacurium, Pipecuronium
2. *Intermediate acting:* Vecuronium, Atracurium, Cisatracurium, Rocuronium, Rapacuronium
3. *Short acting:* Mivacurium

B. Depolarizing blockers

Succinylcholine (SCh., Suxamethonium), Decamethonium (C-10)

II. Directly acting agents

Dantrolene sodium

Quinine

Note: 1. Metocurine and Alcuronium are analogues of d-tubocurarine no longer in clinical use. Gallamine is also obsolete.

2. Aminoglycoside, tetracycline, polypeptide antibiotics interfere with neuromuscular transmission at high doses, but are not employed as muscle relaxants.

NEUROMUSCULAR BLOCKING AGENTS

Curare It is the generic name for certain plant extracts used by south American tribals as arrow poison for game hunting. The animals got paralysed even if not killed by the arrow. Natural sources of curare are *Strychnos toxifera*, *Chondrodendron tomentosum* and related plants. Muscle paralysing active principles of these are tubocurarine, toxiferins, etc.

Tubocurarine was first clinically used in 1930s; many synthetic compounds including *Succinylcholine* were introduced subsequently. Search has continued for neuromuscular blockers to provide greater cardiovascular stability during surgery and for drugs with differing onset and duration of action to suit specific requirements. The latest additions are *doxacurium*, *pipecuronium*, *rocuronium*, *mivacurium*, *rapacuronium* and *cisatracurium*.

MECHANISM OF ACTION

The site of action of both competitive and depolarizing blockers is the end plate of skeletal muscle fibres.

Competitive block (Nondepolarizing block)

This is produced by curare and related drugs. Claude Bernard (1856) precisely localized the site of action of curare to be the neuromuscular junction. He stimulated the sciatic nerve of pithed frog and recorded the contractions of gastrocnemius muscle. Injection of curare in the ventral lymph sac caused inhibition of muscle twitches but there was no effect if the blood supply of the hind limb was occluded. This showed that curare acted peripherally and not centrally. Soaking a portion of the sciatic nerve in curare solution did not affect the twitches and a curarized muscle still responded to direct stimulation—thus, nervous conduction and muscle contraction were intact. The only possible site of action could be the neuromuscular junction. This has now been confirmed by close iontophoretic application of d-TC to the muscle end plate and by other modern techniques.

The competitive blockers have affinity for the nicotinic (N_M) cholinergic receptors at the muscle end plate, but have no intrinsic activity. The N_M receptor has been isolated and studied in detail. It is a protein with 5 subunits (α 2 β ϵ or γ and δ) which are arranged like a rosette surrounding the Na^+ channel (see Fig. 4.4). The two α subunits carry two ACh binding sites; these have negatively charged groups which combine with the cationic head of ACh \rightarrow opening of Na^+ channel. Most of the competitive blockers have two or more quaternary N^+ atoms (Fig. 25.1) which provide the necessary attraction to the same site, but the bulk of the antagonist molecule does not allow conformational changes in the subunits needed for opening the channel. Competitive blockers generally have thick bulky molecules and were termed *Pachycurare* by Bovet (1951). ACh released from motor nerve endings is not able to combine with its receptors to generate end plate potential (EPP). d-TC thus reduces the frequency of channel opening but not its duration or the conductance of a channel once it has opened. When the magnitude of EPP falls below a critical level, it is unable to trigger propagated muscle action potential (MAP) and

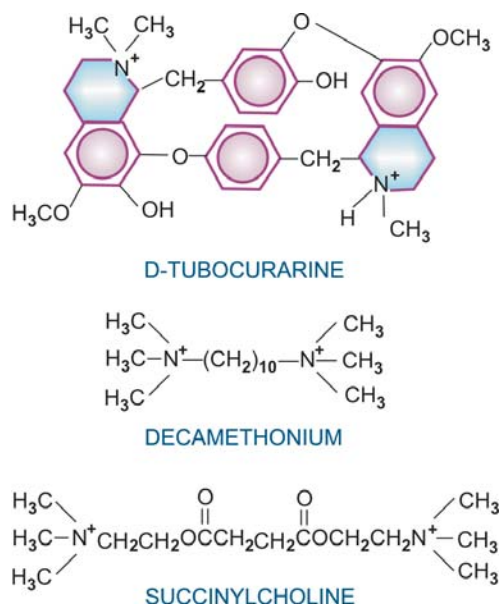

Fig. 25.1: Chemical structure of three neuromuscular blockers. Note the thick, bulky molecule of competitive blocker d-tubocurarine and slender, flexible molecules of depolarizing blockers decamethonium and succinylcholine

muscle fails to contract in response to nerve impulse. The antagonism is surmountable by increasing the concentration of ACh *in vitro* and by anticholinesterases *in vivo*. At very high concentrations, curare like drugs enter the Na^+ channels and directly block them to produce more intense noncompetitive neuromuscular block that is only partly reversed by neostigmine.

The competitive blockers also block prejunctional nicotinic receptors located on motor nerve endings. Since activation of these receptors by ACh normally facilitates mobilization of additional quanta of ACh from the axon to the motor nerve endings, their blockade contributes to depression of neuromuscular transmission. Accordingly, the competitive blockers exhibit the 'fade' phenomenon (Fig. 25.3), i.e. twitch responses during partial block are progressively depressed on repetitive stimulation.

Depolarizing block Decamethonium and SCh have affinity as well as submaximal intrinsic activity at the N_M cholinergic receptors. They depolarize

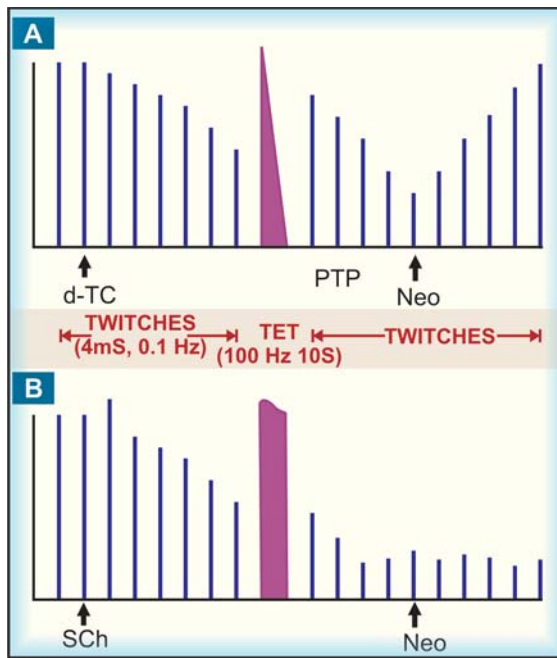

Fig. 25.2: Illustration of characteristics of competitive (A) and depolarizing (B) neuromuscular blockade in sciatic nerve-gastrocnemius muscle of cat

A. Tubocurarine (d-TC) produces progressive decrease in twitch tension; tetanic stimulation (TET) produces poorly sustained contracture, which is followed by post-tetanic potentiation (PTP); Neostigmine (Neo) restores the twitch contractions.

B. Succinylcholine (SCh) produces initial augmentation of twitches followed by progressive block; tetanus is well sustained, but there is no PTP; block is not reversed (rather worsened) by neostigmine.

size muscle end plates by opening Na^+ channels (just as ACh does) and initially produce twitching and fasciculations. Because in the focally innervated mammalian muscle, stimulation is transient; longer lasting depolarization of muscle end plate produces repetitive excitation of the fibre. In the multiply innervated contracture muscle (rectus abdominis of frog) stimulation is prolonged resulting in sustained contraction. These drugs do not dissociate rapidly from the receptor \rightarrow induce prolonged partial depolarization of the region around muscle end plate \rightarrow Na^+ channels get inactivated (because transmembrane

potential drops to about -50 mV) \rightarrow ACh released from motor nerve endings is unable to generate propagated MAP \rightarrow flaccid paralysis in mammals. In other words a zone of inexcitability is created round the end plate preventing activation of the muscle fibre. In birds, the area of depolarization is more extensive and spastic paralysis occurs.

Depolarizing blockers also have 2 quaternary N^+ atoms, but the molecule is long, slender and flexible—termed *Leptocurare* by Bovet. The features of classical depolarizing block differ markedly from that of nondepolarizing block (see Fig. 25.2 and Table 25.1).

However, in many species, e.g. dog, rabbit, rat, monkey, in slow contracting soleus muscle of cat, and under certain conditions in man the depolarizing agents produce dual mechanism neuromuscular blockade which can be divided into two phases:

Phase I block It is rapid in onset, results from persistent depolarization of muscle end plate and has features of classical depolarization blockade. This depolarization declines shortly afterwards and repolarization occurs gradually despite continued presence of the drug at the receptor, but neuromuscular transmission is not restored and phase II block supervenes.

Phase II block It is slow in onset and results from desensitization of the receptor to ACh. It, therefore, superficially resembles block produced by d-TC: membrane is nearly repolarized, recovery is slow, contraction is not sustained during tetanic stimulation and the block is partially reversed by anticholinesterases.

In man and fast contracting muscle (tibialis anterior) of cat, normally only phase I block is seen. Phase II block may be seen in man when fluorinated anaesthetics have been given or when SCh is injected in high dose or infused continuously. SCh readily produces phase II block in patients with atypical or deficient pseudocholinesterase.

Table 25.1: Features of competitive and typical depolarizing block

	<i>Competitive block (d-TC)</i>	<i>Depolarizing (phase I) block (SCh)</i>
1. Paralysis in man	Flaccid	Fasciculations → flaccid
2. Paralysis in chick	Flaccid	Spastic
3. Effect on isolated frog's rectus muscle	No contraction, antagonism of ACh	Contraction
4. Species sensitivity	Rat > rabbit > cat	Cat > rabbit > rat
5. Human neonates	More sensitive	Relatively resistant
6. Tetanic stimulation during partial block	Poorly sustained contraction	Well sustained contraction
7. Neostigmine	Antagonises block	No effect
8. Post tetanic potentiation	Present	Absent
9. Ether anaesthesia	Synergistic	No effect
10. Order of paralysis	Fingers, eyes → limbs → neck, face → trunk → respiratory	Neck, limbs → face, jaw, eyes, pharynx → trunk → respiratory
11. Effect of lowering temperature	Reduces block	Intensifies block
12. Effect of cathodal current to end plate	Lessens block	Enhances block

ACTIONS

1. Skeletal muscles Intravenous injection of nondepolarizing blockers rapidly produces muscle weakness followed by flaccid paralysis. Small fast response muscles (fingers, extraocular) are affected first; paralysis spreads to hands, feet—arm, leg, neck, face—trunk—intercostal muscles—finally diaphragm: respiration stops. The rate of attainment of peak effect and the duration for which it is maintained depends on the drug (Table 25.2), its dose, anaesthetic used, haemodynamic, renal and hepatic status of the patient and several other factors. Recovery occurs in the reverse sequence; diaphragmatic contractions resume first.

Depolarizing blockers typically produce fasciculations lasting a few seconds before inducing flaccid paralysis, but fasciculations are not prominent in well-anaesthetized patients. Though the sequence in which muscles are involved is somewhat different from the competitive blockers (Table 25.1), the action of SCh develops with such rapidity that this is not appreciated. Apnoea generally occurs within 45–90 sec, but lasts only 2–5 min; recovery is rapid.

Clinical monitoring of neuromuscular block

In anaesthetic practice neuromuscular block (especially during recovery) is monitored by recording contractile responses of thumb muscles to transcutaneous ulnar nerve stimulation. Since single twitch responses have to be interpreted in comparison to twitches before the blocker and are not reliable, the preferred method is 'train-of-four' (TOF) protocol. Four supramaximal electrical stimuli are applied at 2Hz and contractions of thumb muscle are recorded (Fig. 25.3). The TOF-ratio is obtained by dividing the strength of 4th contraction by that of the 1st. In the untreated subject all the 4 contractions remain equal and TOF-ratio is 1.0.

During partial competitive block (as during onset and recovery or reversal) the degree of block corresponds to the decrease in TOF-ratio, because competitive blockers exhibit 'fade' phenomenon. As the muscles recover, the TOF-ratio improves and becomes 1.0 at complete recovery.

On the other hand, classical or phase-I depolarizing block does not exhibit fade; the TOF-ratio remains 1.0, though all the 4 twitches are depressed equally depending on the degree of block. Fade is again seen when phase II or desensitization block occurs with prolonged use of a depolarizing agent and TOF-ratio is depressed as in the case of competitive block. However, SCh generally requires no monitoring.

Other protocols used in clinical monitoring of neuromuscular block are 'double burst', 'tetanic stimulation' and 'posttetanic count' methods.

2. Autonomic ganglia Because the cholinergic receptors in autonomic ganglia are nicotinic

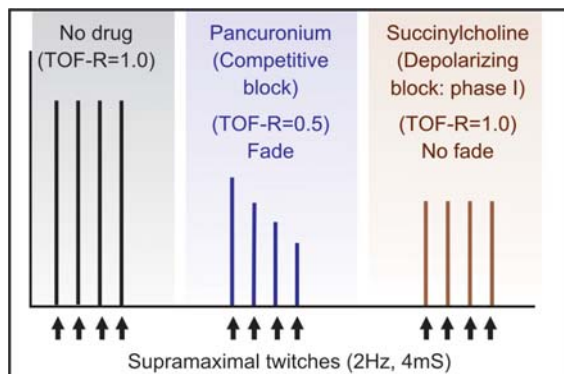

Fig. 25.3: Contractile responses of adductor pollicis muscle to transcutaneous stimulation with train-of-four (TOF) protocol of supramaximal electrical impulses to assess neuromuscular block with competitive and depolarizing (phase I) blocker during recovery.

TOF-R: Train-of-four-ratio (strength of 4th contraction divided by that of the 1st)

(though of a different subclass N_N), competitive neuromuscular blockers produce some degree of ganglionic blockade; d-TC has the maximum propensity in this regard, while the newer drugs

are practically devoid of it. SCh may cause ganglionic stimulation by its agonistic action on nicotinic receptors.

3. Histamine release d-TC releases histamine from mast cells. This does not involve immune system and is due to the bulky cationic nature of the molecule. Histamine release contributes to hypotension produced by d-TC; flushing, bronchospasm and increased respiratory secretions are other effects. Intradermal injection of d-TC produces a wheal similar to that produced by injecting histamine. Histamine releasing potential of other neuromuscular blockers is graded in Table 25.2.

Heparin may also be simultaneously released from mast cells.

4. C.V.S.

d-Tubocurarine produces significant fall in BP. This is due to—

- ganglionic blockade
- histamine release and

Table 25.2: Comparative properties of neuromuscular blocking drugs

Drug	Dose [£] (mg/kg)	Onset* (min)	Duration [@] (min)	Hist. release	Gang. block	Vagal block
LONG ACTING						
1. d-Tubocurarine	0.2–0.4	4–6	30–60	+++	++	±
2. Pancuronium	0.04–0.1	4–6	60–120	±	±	+
3. Doxacurium	0.03–0.08	4–8	60–120	+	–	–
4. Pipecuronium	0.05–0.08	2–4	50–100	±	–	–
INTERMEDIATE ACTING						
5. Vecuronium	0.08–0.1	2–4	30–60	±	–	±
6. Atracurium	0.3–0.6	2–4	20–35	+	–	–
7. Cisatracurium	0.15–0.2	3–6	20–40	–	–	–
8. Rocuronium	0.6–0.9	1–2	25–40	–	–	±
SHORT ACTING						
9. Mivacurium	0.07–0.15	2–4	12–20	+	–	–
10. Succinylcholine	0.5–0.8	1–1.5	3–6	++	St.	St.

[£]Initial paralyzing dose for opioid/nitrous oxide+oxygen anaesthesia. In patients anaesthetised with ether/halothane/isoflurane, the dose may be $\frac{1}{3}$ – $\frac{1}{2}$ of the figure given.

*Time to maximal block after i.v. injection.

[@]Duration of surgical grade relaxation after usual clinical doses; time to 95% recovery of muscle twitch is nearly double of the figure given (especially for long-acting drugs). Duration is dose dependent as well.

St.—Stimulation

(c) reduced venous return—a result of paralysis of limb and respiratory muscles.

Heart rate may increase due to vagal ganglionic blockade. Pancuronium and vecuronium also tend to cause tachycardia. All newer nondepolarizing drugs have negligible effects on BP and HR.

Cardiovascular effects of SCh are variable. Generally bradycardia occurs initially due to activation of vagal ganglia followed by tachycardia and rise in BP due to stimulation of sympathetic ganglia. BP occasionally falls on account of its muscarinic action causing vasodilatation. Prolonged administration of SCh has caused cardiac arrhythmias and even arrest in patients with burns, soft tissue injury and tetanus. Efflux of intracellular K^+ occurs in these conditions which is augmented by prolonged depolarization of skeletal muscles.

5. G.I.T. The ganglion blocking activity of competitive blockers may enhance postoperative paralytic ileus after abdominal operations.

6. C.N.S. All neuromuscular blockers are quaternary compounds—do not cross blood-brain barrier. Thus, on i.v. administration no central effects follow. However, d-TC applied to brain cortex or injected in the cerebral ventricles produces strychnine like effects.

PHARMACOKINETICS

All neuromuscular blockers are polar quaternary compounds—not absorbed orally, do not cross cell membranes, have low volumes of distribution and do not penetrate placental or blood-brain barrier. They are practically always given i.v., though i.m. administration is possible. Muscles with higher blood flow receive more drug and are affected earlier. Redistribution to non-muscular tissues plays a significant role in the termination of surgical grade muscle relaxation, but residual block may persist for a longer time depending on the elimination $t_{1/2}$. The duration of action of competitive blockers is directly dependent on the elimination $t_{1/2}$. Drugs that are primarily metabolized in the plasma/liver, e.g. vecuronium,

atracurium, rocuronium, and mivacurium have relatively shorter $t_{1/2}$ and duration of action (20–40 min), while those largely excreted by the kidney, e.g. pancuronium, d-TC, doxacurium and pipecuronium have longer $t_{1/2}$ and duration of action (>60 min). With repeated administration redistribution sites are filled up and duration of action is prolonged. The unchanged drug is excreted in urine as well as in bile.

SCh is rapidly hydrolysed by plasma pseudocholinesterase to succinylmonocholine and then succinic acid + choline (action lasts 3–5 min). Some patients have genetically determined abnormality (low affinity for SCh) or deficiency of pseudocholinesterase. In them, SCh causes dominant phase II blockade resulting in muscle paralysis and apnoea lasting hours, because SCh is a poor substrate for the more specific AChE found at the motor end plate.

NOTES ON INDIVIDUAL COMPOUNDS

1. d-Tubocurarine Because of its prominent histamine releasing, ganglion blocking and cardiovascular actions as well as long duration of paralysis needing pharmacological reversal, d-TC is not used now.

2. Succinylcholine Despite its propensity to cause muscle fasciculations and soreness, changes in BP and HR, arrhythmias, histamine release and K^+ efflux from muscles → hyperkalaemia and its complications, SCh is the most commonly used muscle relaxant for passing tracheal tube. It induces rapid, complete and predictable paralysis with spontaneous recovery in ~5 min. Excellent intubating condition *viz.* relaxed jaw, vocal cords apart and immobile with no diaphragmatic movements, is obtained within 1–1.5 min. Occasionally it is used by continuous i.v. infusion for producing controlled muscle relaxation of longer duration. It should be avoided in younger children unless absolutely necessary, because risk of hyperkalaemia and cardiac arrhythmia is higher. Risk of regurgitation and aspiration of gastric contents is increased by SCh in GERD patients and in the obese, especially if stomach is full. Infants require higher per kg dose.

MIDARINE, SCOLINE, MYORELEX, ENTUBATE 50 mg/ml inj, 2 ml amp.

3. Pancuronium A synthetic steroidal compound, ~5 times more potent than d-TC; provides good cardiovascular stability (little ganglionic blockade), seldom induces flushing, bronchospasm or cardiac arrhythmias because of lower histamine releasing potential. Rapid i.v. injection may cause rise in BP and tachycardia due to vagal blockade and NA release. It is primarily eliminated by renal excretion. Because of longer duration of action, frequently needing reversal, its use is now restricted to prolonged operations, especially neurosurgery.

PAVULON, PANURON, NEOCURON 2 mg/ml in 2 ml amp.

4. Doxacurium A bisquaternary muscle relaxant having the least rapid onset and the longest action: suitable for long duration surgeries. It is primarily eliminated by kidney, though hepatic metabolism also occurs. Cardiovascular changes are minimal.

5. Pipecuronium Another muscle relaxant with a slow onset and long duration of action; steroidal in nature; recommended for prolonged surgeries. It exerts little cardiovascular action, though transient hypotension and bradycardia can occur. Elimination occurs through both kidney and liver.

ARDUAN 4 mg/2 ml inj.

6. Vecuronium A close congener of pancuronium with a shorter duration of action due to rapid distribution and metabolism. Recovery is generally spontaneous not needing neostigmine reversal unless repeated doses have been given. Cardiovascular stability is still better due to lack of histamine releasing and ganglionic action; tachycardia sometimes occurs. Currently, it is the most commonly used muscle relaxant for routine surgery.

NORCURON 4 mg amp, dissolve in 1 ml solvent supplied.
NEOVEC 4 mg amp, 10 mg vial.

7. Atracurium A bisquaternary competitive blocker, 4 times less potent than pancuronium and shorter acting; reversal is mostly not

required. The unique feature of atracurium is inactivation in plasma by spontaneous non-enzymatic degradation (Hofmann elimination) in addition to that by cholinesterases. Consequently its duration of action is not altered in patients with hepatic/renal insufficiency or hypodynamic circulation. It is the preferred muscle relaxant for such patients as well as for neonates and the elderly. Hypotension may occur due to histamine release.

TRACRIUM 10 mg/ml inj in 2 ml vial.

8. Cisatracurium This *R-Cis*, *R-Cis* enantiomer of atracurium is nearly 4 times more potent, slower in onset, but similar in duration of action. Like atracurium it undergoes Hofmann elimination, but in contrast it is not hydrolysed by plasma cholinesterase. Most importantly, it does not provoke histamine release.

Side effects are fewer.

9. Rocuronium A new nondepolarizing blocker with a rapid onset and intermediate duration of action which can be used as alternative to SCh for tracheal intubation without the disadvantages of depolarizing block and cardiovascular changes. The same drug also serves as maintenance muscle relaxant, seldom needing reversal. The onset of action is dose-dependent; intubating conditions are attained in 90 sec with 0.6 mg/kg, but within 60 sec at 1.0 mg/kg. Within limits, the duration of paralysis is also dose-dependent. This neuromuscular blocker is gaining popularity for its versatility and more precisely timed onset and duration of action. Infused i.v. (0.3–0.6 mg/kg/hour), it is also being used to facilitate mechanical ventilation in intensive care units. It is eliminated mainly by liver. Mild vagolytic action increases HR somewhat.

CUROMID 50 mg/ml, 100 mg/10 ml vials.

10. Mivacurium It is the shortest acting competitive blocker; does not need reversal. Dose and speed of injection related transient cutaneous flushing can occur due to histamine release. Fall in BP is possible, but change in HR is minimal. It is metabolized rapidly by plasma cholinesterases: prolonged paralysis can occur in pseudocholinesterase deficiency.

INTERACTIONS

1. *Thiopentone sod* and SCh solutions should not be mixed in the same syringe—react chemically.

2. *General anaesthetics* potentiate competitive blockers; ether in particular as well as fluorinated hydrocarbons. Isoflurane potentiates more than halothane. Nitrous oxide potentiates the least. Ketamine also intensifies nondepolarizing block. Fluorinated anaesthetics predispose to phase II blockade by SCh. Malignant hyperthermia produced by halothane and isoflurane in rare individuals (genetically predisposed) is more common in patients receiving SCh as well.

3. *Anticholinesterases* reverse the action of competitive blockers. Neostigmine 0.5–2 mg i.v. is almost routinely used after pancuronium and other long acting blockers to hasten recovery at the end of operation. Though it also reverses ganglionic blockade to some extent, hypotension and bronchospasm can occur due to muscarinic action of neostigmine; this can be prevented by prior atropinization. Pretreatment with H_1 antihistamines reduces hypotension due to d-TC and others which release histamine.

4. *Antibiotics* Aminoglycoside antibiotics reduce ACh release from prejunctional nerve endings by competing with Ca^{2+} . They interfere with mobilization of ACh containing vesicles from a central location to near the terminal membrane, and have a weak stabilizing action on the postjunctional membrane. In clinically used doses, they do not by themselves produce muscle relaxation, but potentiate competitive blockers. The dose of competitive blocker should be reduced in patients receiving high doses of these antibiotics. Application of streptomycin powder locally at the end of bowel surgery has caused prolonged apnoea if a competitive blocker had been used during the operation. Tetracyclines (by chelating Ca^{2+}), polypeptide antibiotics, clindamycin and lincomycin also synergise with competitive blockers.

5. *Calcium channel blockers* Verapamil and others potentiate both competitive and depolarizing neuromuscular blockers.

6. *Diuretics* produce hypokalemia which enhances competitive block.

7. *Diazepam, propranolol* and *quinidine* intensify competitive block, while high dose of corticosteroids reduces it.

TOXICITY

1. Respiratory paralysis and prolonged apnoea is the most important problem.
2. Flushing is common with d-TC, can occasionally occur with atracurium and mivacurium, rare with others.
3. Fall in BP and cardiovascular collapse can occur, especially in hypovolemic patients. This is less likely with the newer drugs. Muscle relaxants should be used with great caution in patients with severe hepatic and renal disease.
4. Cardiac arrhythmias and even arrest have occurred, especially with SCh, particularly in digitalized patients. SCh releases K^+ from muscles: can cause dangerous hyperkalaemia, especially in patients with extensive burns and soft tissue injuries.
5. Precipitation of asthma with d-TC and other histamine releasing neuromuscular blockers.
6. Postoperative muscle soreness may be complained after SCh.

USES

1. The most important use of neuromuscular blockers is as adjuvants to general anaesthesia; adequate muscle relaxation can be achieved at lighter planes. Many surgical procedures are performed more safely and rapidly by employing muscle relaxants. Muscle relaxants also reduce reflex muscle contraction in the region undergoing surgery, and assist maintenance of controlled ventilation during anaesthesia. They are particularly helpful in abdominal and thoracic surgery, intubation and endoscopies, orthopedic manipulations, etc.

SCh is employed for brief procedures, e.g. endotracheal intubation, laryngoscopy, broncho-

scopy, esophagoscopy, reduction of fractures, dislocations, and to treat laryngospasm. For ocular surgery competitive blockers are preferred as they paralyse extraocular muscles at doses which have little effect on larger muscles. Other factors which should be considered in selecting the relaxant are—onset of action, duration of blockade required, cardiovascular effects of the drug as well as patient's hepatic, renal and haemodynamic status.

Advantages of newer neuromuscular blockers over the older ones

- No or minimal ganglionic, cardiac or vascular effects.
- No or minimal histamine release.
- Many are short acting: easy reversal.
- Some are rapid acting: provide alternative to SCh without the attendant complications.

2. Assisted ventilation: Critically ill patients in intensive care units often need ventilatory support. This can be facilitated by continuous infusion of a competitive neuromuscular blocker which reduces the chest wall resistance to inflation.

3. Convulsions and trauma from electroconvulsive therapy can be avoided by the use of muscle relaxants without decreasing the therapeutic benefit. SCh is most commonly used for this purpose. The short acting competitive blocker mivacurium is an alternative.

4. Severe cases of tetanus and status epilepticus, which are not controlled by diazepam or other drugs, may be paralysed by a neuromuscular blocker (repeated doses of a competitive blocker) and maintained on intermittent positive pressure respiration till the disease subsides.

DIRECTLY ACTING MUSCLE RELAXANTS

Dantrolene This muscle relaxant is chemically and pharmacologically entirely different from neuromuscular blockers: effect superficially resembles that of centrally acting muscle

relaxants. Neuromuscular transmission or MAP are not affected, but muscle contraction is uncoupled from depolarization of the membrane. Dantrolene acts on the RyR (Ryanodine Receptor) calcium channels in the sarcoplasmic reticulum of skeletal muscles and prevents their depolarization triggered opening. Intracellular release of Ca^{2+} needed for excitation-contraction coupling is interfered with. Fast contracting 'twitch' muscles are affected more than slow contracting 'antigravity' muscles.

Dantrolene is slowly but adequately absorbed from the g.i.t. It penetrates brain and produces some sedation, but has no selective effect on polysynaptic reflexes responsible for spasticity. It is metabolized in liver and excreted by kidney with a $t_{1/2}$ of 8–12 hours.

Used orally dantrolene (25–100 mg QID) reduces spasticity in upper motor neurone disorders, hemiplegia, paraplegia, cerebral palsy and multiple sclerosis. However, it also reduces voluntary power; the resulting weakness considerably neutralizes the benefit.

Used i.v. (1 mg/kg repeated as required) it is the drug of choice for malignant hyperthermia which is due to persistent release of Ca^{2+} from sarcoplasmic reticulum (induced by fluorinated anaesthetics and SCh in genetically susceptible individuals with abnormal RyR, *see* p. 372). Some benefit may also be obtained in neuroleptic malignant syndrome, though this reaction does not appear to be due to abnormal Ca^{2+} release in muscles.

Adverse effects Muscular weakness is the dose limiting side effect. Sedation, malaise, light headedness and other central effects occur, but are less pronounced than with centrally acting muscle relaxants. Troublesome diarrhoea is another problem. Long term use causes dose dependent serious liver toxicity in 0.1–0.5% patients. This has restricted its use in chronic disorders.

Quinine (*see* Ch. 59) It increases refractory period and decreases excitability of motor end

plates. Thus, responses to repetitive nerve stimulation are reduced. It decreases muscle tone in myotonia congenita. Taken at bed time (200–300 mg) it may abolish nocturnal leg cramps in some patients.

CENTRALLY ACTING MUSCLE RELAXANTS

These are drugs which reduce skeletal muscle tone by a selective action in the cerebrospinal axis, without altering consciousness. They selectively depress spinal and supraspinal polysynaptic reflexes involved in the regulation of muscle tone without significantly affecting monosynaptically mediated stretch reflex. Polysynaptic pathways in the ascending reticular formation which are involved in the maintenance of wakefulness are also depressed, though to a lesser extent. All centrally acting muscle relaxants do have some sedative property. They have no effect on neuromuscular transmission and on muscle fibres, but reduce decerebrate rigidity, upper motor neurone spasticity and hyperreflexia.

The prominent differences between peripherally and centrally acting muscle relaxants are listed in Table 25.3.

CLASSIFICATION

- (i) *Mephenesin congeners* Mephenesin, Carisoprodol, Chlorzoxazone, Chlormezanone, Methocarbamol.

- (ii) *Benzodiazepines* Diazepam and others.
 (iii) *GABA derivative* Baclofen.
 (iv) *Central α_2 agonist* Tizanidine

1. Mephenesin It was the first drug found to cause muscle relaxation in animals without producing unconsciousness and was called *internuncial neurone blocking agent* because its primary site of action is the spinal internuncial neurone which modulates reflexes maintaining muscle tone. It is not used clinically because it is gastric irritant, and injected i.v., it causes thrombophlebitis, haemolysis and marked fall in BP. It has been included in counterirritant ointments (*MEDICREME, RELAXYL*) where its irritant rather than muscle relaxant property could be affording relief.

2. Carisoprodol It has a favourable muscle relaxant: sedative activity ratio with weak analgesic, antipyretic and anticholinergic actions in addition. It is used in musculoskeletal disorders associated with muscle spasm.

CARISOMA 350 mg tab; one tab. TDS-QID, SOMAFLAM 175 mg + ibuprofen 400 mg tab.

3. Chlorzoxazone It is pharmacologically similar to mephenesin; has a longer duration of action and is better tolerated orally.

PARAFON DSC 500 mg tab; MOBIZOX 500 mg + diclofenac 50 mg + paracetamol 500 mg tab; PARAFON: 250 mg + paracetamol 300 mg tab, 1–2 tab TDS.

4. Chlormezanone It has antianxiety and hypnotic actions as well, and has been used for tension states associated with increased muscle tone.

WINTRAC 100 mg tab; 1–2 tab TDS-QID, DOLOBAK 100 mg + paracetamol 450 mg tab.

5. Methocarbamol It is less sedative and longer acting than mephenesin. Orally it has been

Table 25.3: Comparative features of central and peripheral muscle relaxants

<i>Centrally acting</i>	<i>Peripherally acting</i>
1. Decrease muscle tone without reducing voluntary power	Cause muscle paralysis, voluntary movements lost
2. Selectively inhibit polysynaptic reflexes in CNS	Block neuromuscular transmission
3. Cause some CNS depression	No effect on CNS
4. Given orally, sometimes parenterally	Practically always given i.v.
5. Used in chronic spastic conditions, acute muscle spasms, tetanus	Used for short-term purposes (surgical operations)

used in reflex muscle spasms and chronic neurological diseases. It can be injected i.v. without producing thrombophlebitis and haemolysis—used for orthopedic procedures and tetanus.

ROBINAX 0.5 g tab, 1 TDS: 100 mg/ml inj. for i.v. or i.m. use. ROBIFLAM 750 mg + ibuprofen 200 mg tab; FLEXINOL 400 mg + paracetamol 325 mg tab.

Clinical efficacy of none of the above drugs as muscle relaxant is well established. Gastric irritation and sedation are the most important side effects.

6. Diazepam (see Ch. 29) It is the prototype of benzodiazepines (BZDs) which act in the brain on specific receptors enhancing GABAergic transmission. Muscle tone is reduced by supraspinal rather than spinal action; muscle relaxant: sedative activity ratio is low. No gastric irritation occurs and it is very well tolerated, though sedation limits the dose which can be used for reducing muscle tone. It is particularly valuable in spinal injuries and tetanus. Combined with analgesics, it is popular for rheumatic disorders associated with muscle spasm.

Dose: 5 mg TDS orally, 10–40 mg i.v. (in tetanus).

7. Baclofen This analogue of the inhibitory transmitter GABA acts as a selective GABA_B receptor agonist. The GABA receptors have been divided into:

GABA_A receptor Intrinsic ion channel receptor—increases Cl⁻ conductance; blocked by bicuculline; facilitated by BZDs.

GABA_B receptor G-protein coupled receptor; hyperpolarizes neurones by increasing K⁺ conductance and altering Ca²⁺ flux; bicuculline insensitive; blocked by saclofen.

Baclofen does not affect Cl⁻ conductance and its actions are not antagonized by bicuculline.

The primary site of action of baclofen is considered to be in the spinal cord where it depresses both polysynaptic and monosynaptic reflexes. As such, it does produce muscle weakness, but is less sedative than diazepam. It reduces spasticity in many neurological disorders like multiple sclerosis, amyotrophic lateral sclerosis,

spinal injuries and flexor spasms, but is relatively ineffective in stroke, cerebral palsy, rheumatic and traumatic muscle spasms and parkinsonism.

Baclofen is well absorbed orally and is primarily excreted unchanged in urine with a t_{1/2} of 3–4 hours.

Side effects are drowsiness, mental confusion, weakness and ataxia; serum transaminases may rise. Sudden withdrawal after chronic use may cause hallucinations, tachycardia and seizures.

Dose: 10 mg BD to 25 mg TDS.

LIORESAL, LIOFEN 10 mg, 25 mg tab.

8. Tizanidine This recently introduced clonidine congener is a central α₂ adrenergic agonist—inhibits release of excitatory amino acids in the spinal interneurons. It may facilitate the inhibitory transmitter glycine as well. It inhibits polysynaptic reflexes; reduces muscle tone and frequency of muscle spasms without reducing muscle strength. Efficacy similar to baclofen or diazepam has been noted in multiple sclerosis, spinal injury and stroke, with fewer side effects.

Tizanidine is absorbed orally, undergoes first pass metabolism and is excreted by the kidney; t_{1/2} 2–3 hours. It is indicated in spasticity due to neurological disorders and in painful muscle spasms of spinal origin. Side effects are dry-mouth, drowsiness, night-time insomnia and hallucinations. Dose-dependent elevation of liver test values has been noted. Though no consistent effect on BP has been observed, it should be avoided in patients receiving antihypertensives, especially clonidine.

Dose: 2 mg TDS; max 24 mg/day.

SIRDALUD 2 mg tab, TIZAN 2, 4 mg tab; TIZAFEN 2 mg + ibuprofen 400 mg tab; TIZANAC 2 mg + diclofenac 50 mg tab, PROXIVON-MR 2 mg + nimesulide 100 mg cap.

Uses of centrally acting muscle relaxants

1. Acute muscle spasms Overstretching of a muscle, sprain, tearing of ligaments and tendons, dislocation, fibrositis, bursitis, rheumatic disorders, etc. cause painful spasm of muscles. The

mephenesin-like and BZD muscle relaxants, combined with analgesics, are commonly used, but efficacy is not impressive.

2. *Torticollis, lumbago, backache, neuralgias*

These are other conditions in which painful spasm of certain muscles is a prominent feature; respond in the same way as acute muscle spasms.

3. *Anxiety and tension* These states are often associated with increased tone of muscles. Diazepam group of drugs and chlormezanone benefit by their antianxiety as well as muscle relaxant actions.

4. *Spastic neurological diseases* Impairment of descending pathways in the cerebrospinal axis and withdrawal of inhibitory influence over the stretch reflex causes chronic increase in muscle tone or spasticity. Hemiplegia, paraplegia, spinal

injuries, multiple sclerosis, amyotrophic lateral sclerosis and cerebral palsy fall in this category. They are benefited by baclofen, diazepam, tizanidine and dantrolene but not by mephenesin group of drugs. However, therapy of these disorders is far from satisfactory.

5. *Tetanus* Most commonly diazepam is infused i.v. and the dose is titrated by the response. Methocarbamol is an alternative.

6. *Electroconvulsive therapy* Diazepam decreases the intensity of convulsions resulting from ECT, without diminishing its therapeutic effect. Often SCh is used in addition for total suppression of the muscular component of ECT.

7. *Orthopedic manipulations* These may be performed under the influence of diazepam or methocarbamol given i.v.

CHAPTER 26

Local Anaesthetics

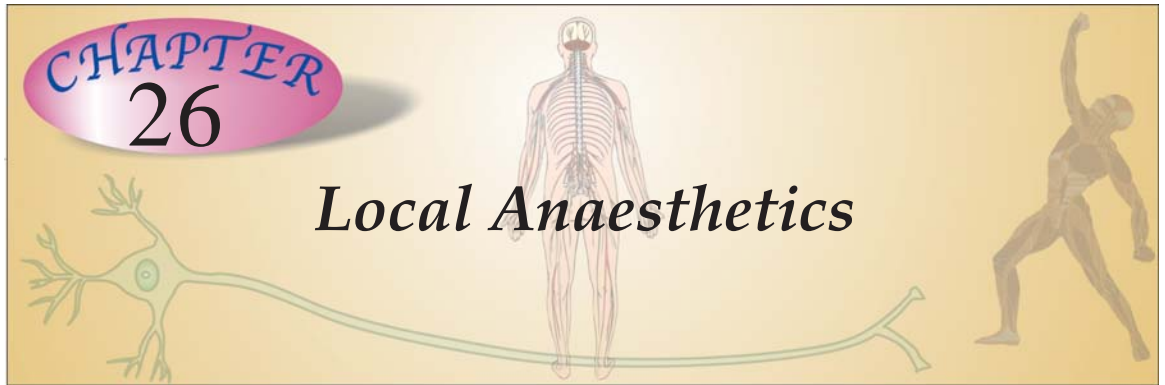

Local anaesthetics (LAs) are drugs which upon topical application or local injection cause reversible loss of sensory perception, especially of pain, in a restricted area of the body. They block generation and conduction of nerve impulse at all parts of the neurone where they come in contact, without causing any structural damage. Thus, not only sensory but also motor impulses are interrupted when a LA is applied to a mixed nerve, resulting in muscular paralysis and loss of autonomic control as well.

Important differences between general and local anaesthesia are tabulated in Table 26.1.

Table 26.1: Comparative features of general and local anaesthesia

	General anaesthesia	Local anaesthesia
1. Site of action	CNS	Peripheral nerves
2. Area of body involved	Whole body	Restricted area
3. Consciousness	Lost	Unaltered
4. Care of vital functions	Essential	Usually not needed
5. Physiological trespass	High	Low
6. Poor health patient	Risky	Safer
7. Use in non-cooperative patient	Possible	Not possible
8. Major surgery	Preferred	Cannot be used
9. Minor surgery	Not preferred	Preferred

CLASSIFICATION

Injectable anaesthetic

Low potency, short duration

Procaine
Chlorprocaine

Intermediate potency and duration

Lidocaine (Lignocaine)
Prilocaine

High potency, long duration

Tetracaine (Amethocaine)
Bupivacaine
Ropivacaine
Dibucaine (Cinchocaine)

Surface anaesthetic

Soluble

Cocaine
Lidocaine
Tetracaine
Benoxinate

Insoluble

Benzocaine
Butylaminobenzoate
(Butamben)
Oxethazaine

Mepivacaine, Etidocaine, Articaine, Dyclonine, Proparacaine are other local anaesthetics, occasionally used in some countries.

Some other drugs, e.g. propranolol, chlorpromazine, H₁ antihistaminics, quinine have significant LA activity, but are not used for this purpose because of local irritancy or other prominent systemic activity. Local anaesthesia can be produced by cooling as well, e.g. application of ice, CO₂ snow, ethylchloride spray.

CHEMISTRY

The clinically useful LAs are weak bases with amphiphilic property. A hydrophilic secondary or tertiary amine on one side and a lipophilic aromatic residue on the other are joined by an alkyl chain through an *ester* or *amide* linkage.

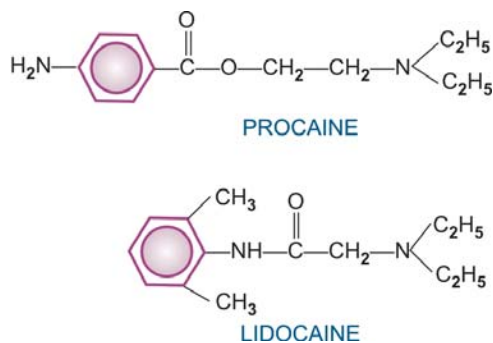

Ester-linked LAs Cocaine, procaine, chlorprocaine, tetracaine, benzocaine.

Amide-linked LAs Lidocaine, bupivacaine, dibucaine, prilocaine, ropivacaine.

Features of amide LAs
(compared to ester LAs)

- Produce more intense and longer lasting anaesthesia
- Bind to α_1 acid glycoprotein in plasma
- Not hydrolysed by plasma esterases
- Rarely cause hypersensitivity reactions; no cross sensitivity with ester LAs

Because of their short duration, less intense analgesia and higher risk of hypersensitivity, the ester-linked LAs are rarely used for infiltration or nerve block, but are still used topically on mucous membranes.

MECHANISM OF ACTION

The LAs block nerve conduction by decreasing the entry of Na^+ ions during upstroke of action potential (AP). As the concentration of the LA is increased, the rate of rise of AP and maximum

depolarization decreases (Fig. 26.1) causing slowing of conduction. Finally, local depolarization fails to reach the threshold potential and conduction block ensues.

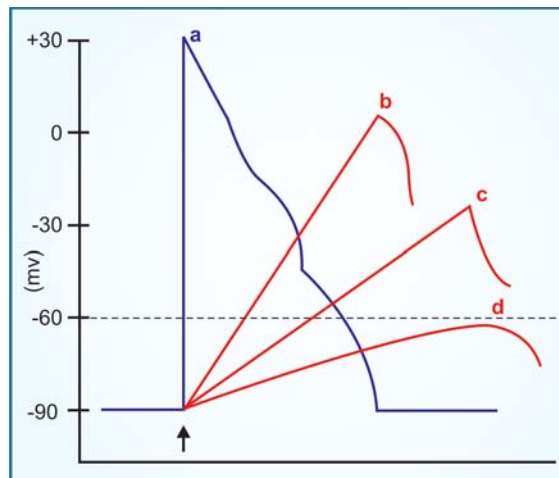

Fig. 26.1: Effect of progressively increasing concentrations (b,c,d) of a local anaesthetic on the generation of an action potential in a nerve fibre, (a) Untreated nerve fibre

The LAs interact with a receptor situated within the voltage sensitive Na^+ channel and raise the threshold of channel opening; Na^+ permeability fails to increase in response to an impulse or stimulus. Impulse conduction is interrupted when the Na^+ channels over a critical length of the fibre (2–3 nodes of Ranvier in case of myelinated fibres) are blocked. The details are explained in Fig. 26.2. At physiological pH, the LA molecule is partly ionized. The equilibrium between the unionized base form (B) and the ionized cationic form (BH^+) depends on the pKa of the LA.

The predominant active species (cationic form of LA) is able to approach its receptor only when the channel is open at the inner face and it binds more avidly to the inactive state of the channel, prolonging the inactive state. The channel takes longer to recover \rightarrow refractory period of the fibre is increased. A resting nerve is rather resistant to blockade, and blockade develops rapidly when the nerve is stimulated

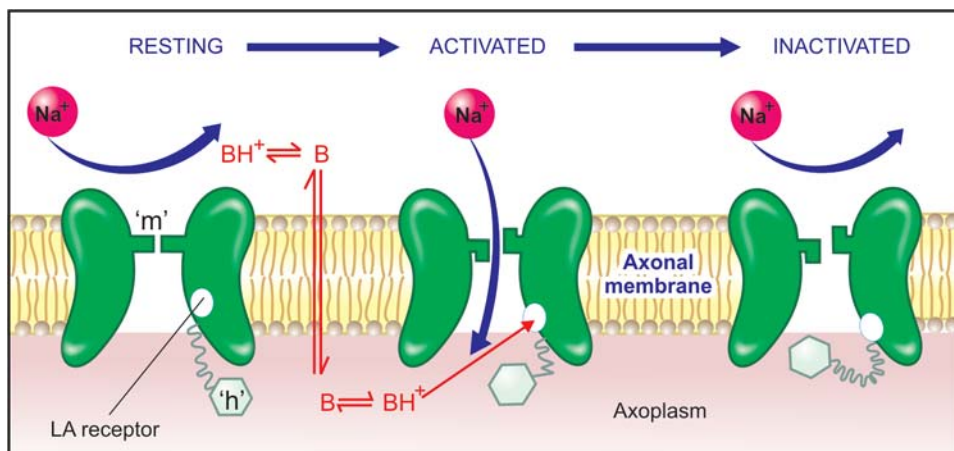

Fig. 26.2: A model of the axonal Na⁺ channel depicting the site and mechanism of action of local anaesthetics.

The Na⁺ channel has an activation gate ('m' gate) near its extracellular mouth and an inactivation gate ('h' gate) at the intracellular mouth. In the resting state the activation gate is closed. Threshold depolarization of the membrane opens the activation gate allowing Na⁺ ions to flow in along the concentration gradient. Within a few msec, the inactivation gate closes and ion flow ceases. The channel recovers to the resting state in a time-dependent manner.

The local anaesthetic (LA) receptor is located within the channel in its intracellular half. The LA traverses the membrane in its unionized lipophilic form (B), reionizes in the axoplasm and approaches the LA receptor through the intracellular mouth of the channel. It is the cationic form (BH⁺) of the LA which primarily binds to the receptor. The receptor has higher affinity or is more accessible to the LA in the activated state compared to the resting state. Binding of LA to its receptor stabilizes the channel in the inactive state and thus reduces the probability of channel opening.

The neuronal Na⁺ channel is a 300 KD glycoprotein composed of a large (α) and two small (β_1 , β_2) subunits. The α subunit encloses the Na⁺ selective pore within its 4 homologous domains (I to IV), each domain has 6 membrane spanning helical segments (S1 to S6) connected alternately by intracellular and extracellular loops. The wall of the pore is formed by all four S5-S6 segments, while the short nonhelical loops connecting S5-S6 on the extracellular surface fold into the pore and serve as the activation gate. Voltage sensors located in the S4 segments move vertically on depolarization and open the activation gate by allosteric conformational change. A few msec later, the short intracellular loop connecting domains III and IV folds into the inner mouth of the pore inactivating the channel. The LA receptor is located in the S6 segment of domain IV. Channel activation either transforms the LA receptor to a higher affinity conformation or exposes it on the wall of the pore, and this persists during the subsequent inactivation phase.

repeatedly. Degree of blockade is frequency dependent: greater blockade at higher frequency of stimulation. Moreover, exposure to higher concentration of Ca²⁺ reduces inactivation of Na⁺ channels and lessens the degree of block. Blockade of conduction by LA is not due to hyperpolarization; in fact, resting membrane potential is unaltered because K⁺ channels are blocked only at higher concentrations of LA.

The onset time of blockade is related primarily to the pKa of the LA. Those with lower pKa (7.6–7.8), e.g. lidocaine, mepivacaine are fast acting, because 30–40% LA is in the undissociated base form at pH 7.4 and it is this form which penetrates the axon. Procaine, tetracaine,

bupivacaine have higher pKa (8.1–8.9), only 15% or less is unionized at pH 7.4; these are slow acting. Chloroprocaine is an exception, having rapid onset despite high pKa (9.1).

LOCAL ACTIONS

The clinically used LAs have no/minimal local irritant action and block sensory nerve endings, nerve trunks, neuromuscular junction, ganglionic synapse and receptors (non-selectively), i.e. structures which function through increased Na⁺ permeability. They also reduce release of acetylcholine from motor nerve endings. Injected around a mixed nerve they cause anaesthesia of

skin and paralysis of the voluntary muscle supplied by that nerve.

Sensory and motor fibres are inherently equally sensitive. The sensitivity is determined by diameter of the fibres as well as by fibre type. Diameter remaining the same, myelinated nerves are blocked earlier than nonmyelinated. In general, smaller fibres are more sensitive than larger fibres. Fibres differ in the critical length of the axon that must be exposed to the LA for effective blockade. Smaller fibres tend to have shorter critical lengths, because in them voltage changes propagate passively for shorter distances. Also, more slender axons have shorter internodal distances and LAs easily enter the axon at the nodes of Ranvier. The density of Na⁺ channel is much higher at these nodes. Moreover, frequency dependence of blockade makes smaller sensory fibres more vulnerable since they generate high frequency longer lasting action potentials than the motor fibres.

Autonomic fibres are generally more susceptible than somatic fibres. Among the somatic afferents order of blockade is: pain—temperature sense—touch—deep pressure sense. Since pain is generally carried by smaller diameter fibres than those carrying other sensations or motor impulses, pain in the first modality to be affected. Applied to the tongue, bitter taste is lost first followed by sweet and sour, and salty taste last of all.

In general, fibres that are more susceptible to LA are the first to be blocked and the last to recover. Also, location of the fibre within a nerve trunk determines the latency, duration and often the depth of local anaesthesia. Nerve sheaths restrict diffusion of the LA into the nerve trunk so that fibres in the outer layers are blocked earlier than the inner or core fibres. As a result, the more proximal areas supplied by a nerve are affected earlier because axons supplying them are located more peripherally in the nerve than those supplying distal areas. The differential arrangement of various types of sensory and motor fibres in a mixed nerve may partly account for the differential blockade. Motor fibres are usually present

circumferentially; may be blocked earlier than the sensory fibres in the core of the nerve.

The LA often fails to afford adequate pain control in inflamed tissues (like infected tooth). The likely reasons are:

- Inflammation lowers pH of the tissue—greater fraction of the LA is in the ionized form hindering diffusion into the axolemma.
- Blood flow to the inflamed area is increased—the LA is removed more rapidly from the site.
- Effectiveness of Adr injected with the LA is reduced at the inflamed site.
- Inflammatory products may oppose LA action.

Addition of a vasoconstrictor, e.g. adrenaline (1:50,000 to 1:200,000):

- Prolongs duration of action of LAs by decreasing their rate of removal from the local site into the circulation.
- Enhances the intensity of nerve block.
- Reduces systemic toxicity of LAs: rate of absorption is reduced and metabolism keeps the plasma concentration lower.
- Makes the injection more painful.
- Provides a more bloodless field for surgery.
- Increases the chances of subsequent local tissue edema and necrosis as well as delays wound healing by reducing oxygen supply and enhancing oxygen consumption in the affected area.
- May raise BP and promote arrhythmia in susceptible individuals.

SYSTEMIC ACTIONS

Any LA injected or applied locally is ultimately absorbed and can produce systemic effects depending on the concentration attained in the plasma and tissues.

C.N.S.

All LAs are capable of producing a sequence of stimulation followed by depression. *Cocaine* is a powerful CNS stimulant causing in sequence euphoria—excitement—mental confusion—rest-

lessness—tremor and twitching of muscles—convulsions—unconsciousness—respiratory depression—death, in a dose-dependent manner.

Procaine and other synthetic LAs are much less potent in this regard. At safe clinical doses, they produce little apparent CNS effects. Higher dose or accidental i.v. injection produces CNS stimulation followed by depression.

Lidocaine, on the contrary, can initially cause drowsiness and lethargy, but higher doses produce excitation followed by depression like others.

The basic action of all LAs is neuronal inhibition; the apparent stimulation seen initially is due to inhibition of inhibitory neurones. At high doses, all neurones are inhibited and flattening of waves in EEG is seen.

C.V.S.

Heart LAs are cardiac depressants, but no significant effects are observed at conventional doses. At high doses or on inadvertent i.v. injection, they decrease automaticity, excitability, contractility, conductivity and increase effective refractory period (ERP). They have a quinidine-like antiarrhythmic action. *Procaine* is not used as antiarrhythmic because of short duration of action and propensity to cause CNS effects, but its amide derivative *procainamide* is a classical antiarrhythmic. At high plasma concentrations electrophysiological properties of heart may be markedly altered, QTc interval is prolonged and LAs can themselves induce cardiac arrhythmias. *Bupivacaine* is relatively more cardiotoxic and has produced ventricular tachycardia or fibrillation. *Lidocaine* has little effect on contractility and conductivity; it abbreviates ERP and is used as an antiarrhythmic (see Ch. 38).

Blood vessels LAs tend to produce fall in BP. This is primarily due to sympathetic blockade, but high concentrations, as obtained locally at the site of injection, do cause direct relaxation of arteriolar smooth muscle. *Bupivacaine* is more vasodilatory than *lidocaine*, while *prilocaine* is the least vasodilatory. Toxic doses of LAs

produce cardiovascular collapse. *Cocaine* has sympathomimetic property; causes local vasoconstriction, marked rise in BP and tachycardia.

Procaine and related drugs have weak anticholinergic, antihistaminic, ganglion blocking, neuromuscular blocking and smooth muscle relaxant properties, but these are clinically insignificant.

PHARMACOKINETICS

Soluble surface anaesthetics (*lidocaine*, *tetracaine*) are rapidly absorbed from mucous membranes and abraded areas, but absorption from intact skin is poor. Procaine does not significantly penetrate mucous membranes. Rate of absorption depends on the blood flow to the area of application or injection. The absorbed LA being lipophilic is widely distributed; rapidly enters highly perfused brain, heart, liver, and kidney, followed by muscle and other viscera.

Procaine is negligibly bound to plasma proteins, but amide LAs are bound to plasma α_1 acid glycoprotein. LAs are rapidly but temporarily bound to tissues, especially nerves, at the site of injection. Ester-linked LAs (*procaine*, etc.) are rapidly hydrolysed by plasma pseudocholinesterase and the remaining by esterases in the liver. Amide-linked LAs (*lidocaine*, etc.) are degraded only in the liver microsomes by dealkylation and hydrolysis. Metabolism of *lidocaine* is hepatic blood-flow dependent. The maximal safe dose of LAs is lower in patients with hepatic disease and in the elderly who have decreased liver function.

After oral ingestion both *procaine* and *lidocaine* have high first pass metabolism in the liver. Thus, they are not active orally for antiarrhythmic purposes.

ADVERSE EFFECTS

Systemic toxicity on rapid i.v. injection is related to the intrinsic anaesthetic potency of the LA. However, toxicity after topical application or regional injection is influenced by relative rates of absorption and metabolism, those rapidly absorbed but slowly metabolized are more toxic.

Table 26.2: Comparative properties of important local anaesthetics

	Potency			Concn. used	Safe max* dose (inj.) Total (mg)	Onset	Metabolism in		Duration of nerve block (min.)
	surface	injection	toxic				plasma	liver	
Cocaine	1	1	1	–	not injected	fast	–	+	–
Procaine	1/10	1/2	1/6	1–2%	400 (6)	slow	+	+	30–60
Lidocaine	1	2	1/6	0.5–2%	300 (4.5)	fast	–	+	60–120
Tetracaine	4	10	2	0.25–0.5%	80 (1.2)	slow	+	+	180–480
Bupivacaine	–	10	2	0.25–0.5%	100 (1.5)	interm.	–	+	180–360
Dibucaine	6	15	3	0.25–0.5%	50	slow	–	+	180–600

* Without adrenaline; addition of adrenaline may increase safe limit by upto 40%

(1) CNS effects are light-headedness, dizziness, auditory and visual disturbances, mental confusion, disorientation, shivering, twitchings, involuntary movements, finally convulsions and respiratory arrest. This can be prevented and treated by diazepam.

(2) Cardiovascular toxicity of LAs is manifested as bradycardia, hypotension, cardiac arrhythmias and vascular collapse.

(3) Injection of LAs may be painful, but local tissue toxicity of LAs is low. However, wound healing may be sometimes delayed. Addition of vasoconstrictors enhances the local tissue damage; rarely necrosis results. Vasoconstrictors should not be added for ring block of hands, feet, fingers, toes, penis and in pinna. Bupivacaine has the highest local tissue irritancy.

(4) Hypersensitivity reactions like rashes, angioedema, dermatitis, contact sensitization, asthma and rarely anaphylaxis occur. These are more common with ester-linked LAs, but rare with lidocaine or its congeners. Cross reactivity is frequent among ester compounds, but not with amide-linked LAs.

Precautions and interactions

1. Before injecting the LA, aspirate lightly to avoid intravascular injection.
2. Inject the LA slowly and take care not to exceed the maximum safe dose, especially in children.

3. Propranolol (probably other β blockers also) may reduce metabolism of lidocaine and other amide LAs by reducing hepatic blood flow.

4. Vasoconstrictor (adrenaline) containing LA should be avoided for patients with ischaemic heart disease, cardiac arrhythmia, thyrotoxicosis, uncontrolled hypertension, and those receiving β blockers (rise in BP due to unopposed α action) or tricyclic antidepressants (uptake blockade of Adr).

INDIVIDUAL COMPOUNDS

Important properties of local anaesthetics are compared in Table 26.2.

Cocaine It is a natural alkaloid from leaves of *Erythroxylon coca*, a south American plant growing on the foothills of the Andes. The natives of Peru and Bolivia habitually chew these leaves. Cocaine is a good surface anaesthetic and is rapidly absorbed from buccal mucous membrane. It was first used for ocular anaesthesia in 1884. Cocaine should never be injected; it is a protoplasmic poison and causes tissue necrosis. Cocaine produces prominent CNS stimulation with marked effect on mood and behaviour. It induces a sense of wellbeing, delays fatigue and increases power of endurance. In susceptible individuals it produces a state referred to as 'high' leading to strong psychological but little physical dependence. Cocaine is unique among drugs of abuse in not producing significant tolerance on repeated use; sometimes reverse tolerance is seen (behavioural effects are experienced at lower doses).

Cocaine also stimulates vagal centre \rightarrow bradycardia; vasomotor centre \rightarrow rise in BP; vomiting centre \rightarrow nausea and vomiting; temperature regulating centre \rightarrow pyrexia (also due to increased heat production as a result of enhanced muscular activity).

In the periphery, it blocks uptake of NA and Adr into adrenergic nerve endings, resulting in higher concentration of the transmitter around the receptors→sympathomimetic effect, potentiation of directly acting sympathomimetics and suppression of indirectly acting sympathomimetics. Local vasoconstriction, tachycardia, rise in BP and mydriasis are the reflection of its sympathomimetic action.

The only indication for cocaine is in ocular anaesthesia. However, it causes constriction of conjunctival vessels, clouding and rarely sloughing of cornea (due to drying and local tissue toxicity). Its use, therefore, is not warranted.

Procaine It is the first synthetic local anaesthetic introduced in 1905. Its popularity declined after the introduction of lidocaine: practically not used now. It is not a surface anaesthetic.

Procaine forms poorly soluble salt with benzyl penicillin; *procaine penicillin* injected i.m. acts for 24 hours due to slow absorption from the site of injection.

Lidocaine (Lignocaine) Introduced in 1948, it is currently the most widely used LA. It is a versatile LA, good both for surface application as well as injection and is available in a variety of forms. Injected around a nerve it blocks conduction within 3 min, whereas procaine may take 15 min; also anaesthesia is more intense and longer lasting. Vasodilatation occurs in the injected area. It is used for surface application, infiltration, nerve block, epidural, spinal and intravenous regional block anaesthesia. Cross sensitivity with ester LAs is not seen. In contrast to other LAs, early central effects of lidocaine are drowsiness, mental clouding, altered taste and tinnitus. Overdose causes muscle twitching, convulsions, cardiac arrhythmias, fall in BP, coma and respiratory arrest like other LAs. Lidocaine is a popular antiarrhythmic (*see* Ch. 38)

XYLOCAINE, GESICAIN 4% topical solution, 2% jelly, 2% viscous, 5% ointment, 1% and 2% injection (with or without adrenaline), 5% heavy (for spinal anaesthesia); 100 mg/ml spray (10 mg per actuation).

Prilocaine It is similar to lidocaine but does not cause vasodilatation at the site of infiltration and has lower CNS toxicity due to larger volume of distribution. One of its metabolites has potential to cause methaemoglobinemia. It has been used mainly for infiltration, nerve block and intravenous regional anaesthesia.

Eutectic lidocaine/prilocaine This is a unique preparation which can anaesthetise intact skin after surface application. Eutectic mixture refers to lowering of melting point of two solids when they are mixed. This happens when lidocaine and prilocaine are mixed in equal proportion at 25°C. The resulting oil is emulsified into water to form a cream that is applied under occlusive dressing for 1 hr before i.v. cannulation, split skin graft harvesting and other superficial procedures. Anaesthesia up to a depth of 5 mm lasts for 1–2 hr after removal. It has been used as an alternative to lidocaine infiltration.

PRILOX 5% cream.

Tetracaine (Amethocaine) A highly lipid-soluble PABA ester, more potent and more toxic due to slow hydrolysis by plasma pseudocholinesterase. It is both surface and conduction block anaesthetic, but its use is restricted to topical application to the eye, nose, throat, tracheobronchial tree and rarely for spinal or caudal anaesthesia of long duration. Though it is slow acting, absorption from tracheobronchial spray is very fast and blood concentrations approach those attained after i.v. injection.

ANETHANE powder for solution, 1% ointment.

Bupivacaine A potent and long-acting amide-linked LA: used for infiltration, nerve block, epidural and spinal anaesthesia of long duration. A 0.25–0.5% solution injected epidurally produces adequate analgesia without significant motor blockade. As a result, it has become very popular in obstetrics (mother can actively cooperate in vaginal delivery) and for postoperative pain relief by continuous epidural infusion. It has high lipid-solubility; distributes more in tissues than in blood after spinal/epidural injection—less likely to reach the foetus (when used during labour) to produce neonatal depression. Bupivacaine is more prone to prolong QTc interval and induce ventricular tachycardia or cardiac depression—should not be used for intravenous regional analgesia. Epidural anaesthesia with 0.75% bupivacaine during labour has caused few

fatalities due to cardiac arrest; use of this concentration is contraindicated.

MARCAIN 0.5%, 1% (hyperbaric for spinal anaesthesia).
SENSORCAINE 0.25%, 0.5% inj, 0.5% heavy inj.

The S(-) enantiomer *Levobupivacaine* is equally potent but less cardiotoxic and less prone to cause seizures (after inadvertant intravascular injection) than racemic bupivacaine. It has been introduced in some countries as a single enantiomer preparation.

Ropivacaine A newer bupivacaine congener, equally long acting but less cardiotoxic. It blocks A δ and C fibres (involved in pain transmission) more completely than A β fibres which control motor function. Though equi-effective concentrations of ropivacaine are higher than those of bupivacaine, a greater degree of separation between sensory and motor block has been obtained with epidural ropivacaine. Continuous epidural ropivacaine is being used for relief of postoperative and labour pain. It can also be employed for nerve blocks.

Dibucaine (Cinchocaine) It is the most potent, most toxic and longest acting LA. It is used as a surface anaesthetic on less delicate mucous membranes (anal canal). Use for spinal anaesthesia of long duration has declined after the availability of bupivacaine.

NUPERCAINE 0.5% inj., NUPERCAINAL 1% ointment, in OTOGESIC 1% ear drops.

Benoxinate It is a good surface anaesthetic for the eye; has little irritancy. A 0.4% solution rapidly produces corneal anaesthesia sufficient for tonometry without causing mydriasis or corneal damage.

BENDZON 0.4% eyedrops.

Benzocaine and Butylaminobenzoate (Butamben) Because of very low aqueous solubility, these LAs are not significantly absorbed from mucous membranes or abraded skin. They produce long-lasting anaesthesia without systemic toxicity. They are used as lozenges for stomatitis, sore throat; as dusting powder/ointment on wounds/ulcerated surfaces and as suppository for anorectal lesions. Both are PABA derivative—can antagonize sulfonamides locally.

PROCTOSEDYL-M: Butylaminobenzoate 1% oint with framycetin and hydrocortisone acetate: for piles.

PROCTOQUINOL 5% ointment of benzocaine.

Oxethazaine A potent topical anaesthetic, unique in ionizing to a very small extent even at low pH values. It is, therefore, effective in anaesthetising gastric mucosa despite acidity of the medium. Swallowed along with

antacids it affords symptomatic relief in gastritis, drug induced gastric irritation, gastroesophageal reflux and heartburn of pregnancy. Doses exceeding 100 mg/day may produce dizziness and drowsiness.

MUCAINE 0.2% in alumina gel + magnesium hydroxide suspension; 5–10 ml orally.

TRICAINE-MPS: Oxethazaine 10 mg with methyl polysiloxane 125 mg, alum. hydroxide gel 300 mg, mag. hydroxide 150 mg per 5 ml gel.

USES AND TECHNIQUES OF LOCAL ANAESTHESIA

1. Surface anaesthesia It is produced by topical application of a surface anaesthetics to mucous membranes and abraded skin. Only the superficial layer is anaesthetised. Onset and duration depends on the site, the drug, its concentration and form, e.g. lidocaine sprayed in the throat acts in 2–5 min and produces anaesthesia for 30–45 min. Addition of Adr does not affect duration of topical anaesthesia. Absorption of soluble LAs from mucous membranes is rapid; blood concentrations of lidocaine and tetracaine sprayed in throat/tracheobronchial tree approach those attained on i.v. injection—toxicity can occur. Except for eutectic lidocaine/prilocaine, no other LA is capable of anaesthetizing intact skin. The sites and purposes for which surface anaesthesia is used are given in Table 26.3.

2. Infiltration anaesthesia Dilute solution of LA is infiltrated under the skin in the area of operation—blocks sensory nerve endings. Onset of action is almost immediate and duration is shorter than that after nerve block, e.g. lidocaine 30–60 min, bupivacaine 120–180 min. Infiltration is used for minor operations, e.g. incisions, excisions, hydrocele, herniorrhaphy, etc. when the area to be anaesthetized is small. Relatively larger amount of LA is required compared to the area anaesthetised, but motor function is not affected.

3. Conduction block The LA is injected around nerve trunks so that the area distal to injection is anaesthetised and paralysed. Choice of the LA and its concentration is mainly dictated by the required duration of action; lidocaine

Table 26.3: Sites and uses of surface anaesthesia

Site	Drugs	Form	Purpose
1. Eye	Tetracaine 1–2% Benoxinate 0.4%	ointment, drops drops	tonometry, surgery tonometry
2. Nose, ear	Lidocaine 2–4% Tetracaine 1–2%	drops	painful lesions, polyps
3. Mouth, throat	Benzocaine	lozenges	stomatitis, sore throat
4. Pharynx, larynx, trachea, bronchi	Lidocaine 2–4% Tetracaine 1–2%	spray	tonsillectomy, endotracheal intubation, endoscopies
5. Esophagus, stomach	Oxethazaine 0.2%	suspension	gastritis, esophagitis, heartburn
6. Abraded skin	Tetracaine 1% Benzocaine 1–2% Butamben 1–2%	cream, ointment, dusting powder	ulcers, burns, itching dermatoses
7. Intact skin	Eutectic lidocaine/ prilocaine 5%	cream under occlusion	i.v. cannulation, skin surgery
8. Urethra	Lidocaine 2%	jelly	for dilatation, catheterisation
9. Anal canal, rectum	Lidocaine 4% Dibucaine 1% Benzocaine 5%	ointment, cream, suppository	fissure, painful piles, surgery, proctoscopy

(1–2%) with intermediate duration of action is most commonly used, but for longer lasting anaesthesia bupivacaine may be selected.

(a) Field block It is produced by injecting the LA subcutaneously in a manner that all nerves coming to a particular field are blocked—as is done for herniorrhaphy, appendicectomy, dental procedures, scalp stitching, operations on forearms and legs, etc. Larger area can be anaesthetised with lesser drug compared to infiltration. The same concentration of LA as for infiltration is used for field block.

(b) Nerve block It is produced by injecting the LA around the appropriate nerve trunks or plexuses. The area of resulting anaesthesia is still larger compared to the amount of drug used. Muscles supplied by the injected nerve/plexus are paralysed. The latency of anaesthesia depends on the drug and the area to be covered by diffusion, e.g. lidocaine anaesthetises intercostal nerves within 3 min, but brachial plexus block may take 15 min. For plexus block a

‘flooding’ technique is used and larger volumes are needed. Nerve block lasts longer than field block or infiltration anaesthesia. Frequently performed nerve blocks are—lingual, intercostal, ulnar, sciatic, femoral, brachial plexus, trigeminal, facial, phrenic, etc.—used for tooth extraction, operations on eye, limbs, abdominal wall, fracture setting, trauma to ribs, neuralgias, persistent hiccup, etc.

The primary purpose of nerve block anaesthesia is to abolish pain and other sensations. The accompanying motor paralysis may be advantageous by providing muscle relaxation during surgery, as well as disadvantageous if it interferes with breathing, ability to walk after the operation, or participation of the patient in labour or produces postural hypotension.

4. Spinal anaesthesia The LA is injected in the subarachnoid space between L2–3 or L3–4 i.e. below the lower end of spinal cord. The primary site of action is the nerve root in the cauda equina rather than the spinal cord. Lower abdomen and hind limbs are anaesthetised and paralysed. The level of anaesthesia depends on the volume and speed of injection, specific

gravity of drug solution and posture of the patient. The drug solution could be hyperbaric (in 10% glucose) or isobaric with CSF.

Nerve roots rapidly take up and retain the LA, therefore, its concentration in CSF falls quickly after injection. The level of anaesthesia does not change with change of posture (becomes fixed) after 10 min. Also, higher segments are exposed to progressively lower concentrations of the LA. Since autonomic preganglionic fibres are more sensitive and somatic motor fibres less sensitive than somatic sensory fibres, the level of sympathetic block is about 2 segments higher and the level of motor paralysis about 2 segments lower than the level of cutaneous analgesia.

The duration of spinal anaesthesia depends on the drug used and its concentration. Addition of 0.2–0.4 mg of adrenaline to the LA prolongs spinal anaesthesia by about 1/3rd when measured by the time taken for the level of sensory block to recede to L1. Adr may be enhancing spinal anaesthesia by reducing spinal cord blood flow or by its own analgesic effect exerted through spinal α_2 adrenoceptors (intrathecal clonidine, an α_2 agonist produces spinal analgesia by itself).

Women during late pregnancy require less drug for spinal anaesthesia, because inferior vena cava compression leads to engorgement of the vertebral system and a decrease in the capacity of subarachnoid space.

Spinal anaesthesia is used for operations on the lower limbs, pelvis, lower abdomen, prostatectomy, fracture setting, obstetric procedures, caesarean section, etc. Its advantages over general anaesthesia are—

Table 26.4: Drugs used for spinal anaesthesia and their duration of action

Drug	Concentration (%)	Volume (ml)	Total dose (mg)	Duration of action (min)
Lidocaine	1.5–5	1–2	25–100	60–90
Bupivacaine	0.5–0.75	2–3	10–25	90–150
Tetracaine	0.25–0.5	1–3	5–15	90–150
Dibucaine	0.25–0.5	1–2	2.5–10	120–180

- (i) It is safer.
- (ii) Produces good analgesia and muscle relaxation without loss of consciousness.
- (iii) Cardiac, pulmonary, renal disease and diabetes pose less problem.

Complications of spinal anaesthesia

1. **Respiratory paralysis** is rare; intercostal muscles may be paralysed, but diaphragm (supplied by phrenic nerve) maintains breathing. Hypotension and ischaemia of respiratory centre is more frequently the cause of respiratory failure than diffusion of the anaesthetic to higher centres. Due to paralysis of external abdominal and intercostal muscles, coughing and expectoration becomes less effective—pulmonary complications can occur.

2. **Hypotension** It is due to blockade of sympathetic vasoconstrictor outflow to blood vessels; venous pooling and decreased return to the heart contributes more to the fall in BP than arteriolar dilatation. Venous return is decreased due to paralysis of skeletal muscles of lower limb. Decreased sympathetic flow to heart and low venous return produce bradycardia. By promoting venous drainage, raising the foot end overcomes the hypotension. Sympathomimetics, especially those with prominent effect on veins (ephedrine, mephentermine) effectively prevent and counteract hypotension.

3. **Headache** is due to seepage of CSF; can be minimised by using smaller bore needle.

4. **Cauda equina syndrome** is a rare neurological complication resulting in prolonged loss of control over bladder and bowel sphincters. It may be due to traumatic damage to nerve roots or chronic arachnoiditis caused by inadvertent introduction of the antiseptic or particulate matter.

5. **Septic meningitis** due to infection introduced during lumbar puncture; incidence is very low.

6. **Nausea and vomiting** after abdominal operations is due to reflexes initiated by traction on

abdominal viscera. Premedication with opioid analgesics prevents it.

Contraindications to spinal anaesthesia

- Hypotension and hypovolemia.
- Uncooperative or mentally ill patients.
- Infants and children—control of level is difficult.
- Vertebral abnormalities e.g. kyphosis, lordosis, etc.
- Sepsis at injection site.

5. Epidural anaesthesia The spinal dural space is filled with semiliquid fat through which nerve roots travel. The LA injected in this space—acts primarily on nerve roots (in the epidural as well as subarachnoid spaces to which it diffuses) and small amount permeates through intervertebral foramina to produce multiple paravertebral blocks. Epidural anaesthesia can be divided into 3 categories depending on the site of injection.

(i) **Thoracic** Injection is made in the midthoracic region. The epidural space in this region is relatively narrow, smaller volume of drug is needed and a wide segmental band of analgesia involving the middle and lower thoracic dermatomes is produced—used generally for pain relief following thoracic/upper abdominal surgery.

(ii) **Lumbar** Relatively large volume of drug is needed because epidural space is wide. It produces anaesthesia of lower abdomen, pelvis and hind limbs—use is similar to spinal anaesthesia.

(iii) **Caudal** Injection is given in the sacral canal through the sacral hiatus—produces anaesthesia of pelvic and perineal region—used mostly for vaginal delivery, anorectal and genitourinary operations.

Lidocaine and bupivacaine are popular drugs for epidural anaesthesia. Duration of anaesthesia is longer with bupivacaine and

action of both the drugs is prolonged by addition of adrenaline. Technically epidural anaesthesia is more difficult than spinal anaesthesia and relatively larger volumes of drug are needed—blood concentrations of the LA are higher. Cardiovascular complications are similar to that after spinal anaesthesia, but headache and neurological complications are less because intrathecal space is not entered. The spread of the LA in the epidural space is governed by the volume injected: larger volume anaesthetizes more extensive area. Zone of differential sympathetic blockade is not evident after epidural injection but motor paralysis is 4–5 segments caudal, especially with lower concentrations of the drug. Greatest separation between sensory and motor block is obtained by use of 0.25% bupivacaine—especially valuable for obstetric purposes (mother can participate in labour without feeling pain) and for postoperative pain relief. Continuous epidural anaesthesia can be instituted by inserting a catheter and making repeated injections.

6. Intravenous regional anaesthesia (Intravascular infiltration anaesthesia) It consists of injection of LA in a vein of a tourniquet occluded limb such that the drug diffuses retrograde from the peripheral vascular bed to nonvascular tissues including nerve endings. The limb is first elevated to ensure venous drainage by gravity and then tightly wrapped in an elastic bandage for maximal exsanguination. Tourniquet is then applied proximally and inflated to above arterial BP. Elastic bandage is now removed and 20–40 ml of 0.5% lidocaine is injected i.v. under pressure distal to the tourniquet. Regional analgesia is produced within 2–5 min and lasts till 5–10 min after deflating the tourniquet which is kept inflated for 15–60 min. The safety of the procedure depends on the rapid uptake of LA by peripheral tissues; only 1/4 of the injected drug enters systemic circulation when the tourniquet is released. Bradycardia can occur.

It is mainly used for the upper limb and for orthopedic procedures. It is more difficult to obstruct the blood supply of lower limbs and larger volume of anaesthetic is needed (80 ml of 0.25% lidocaine may be required). Bupivacaine should not be employed because of its higher cardiotoxicity.

Drugs Acting on Central Nervous System

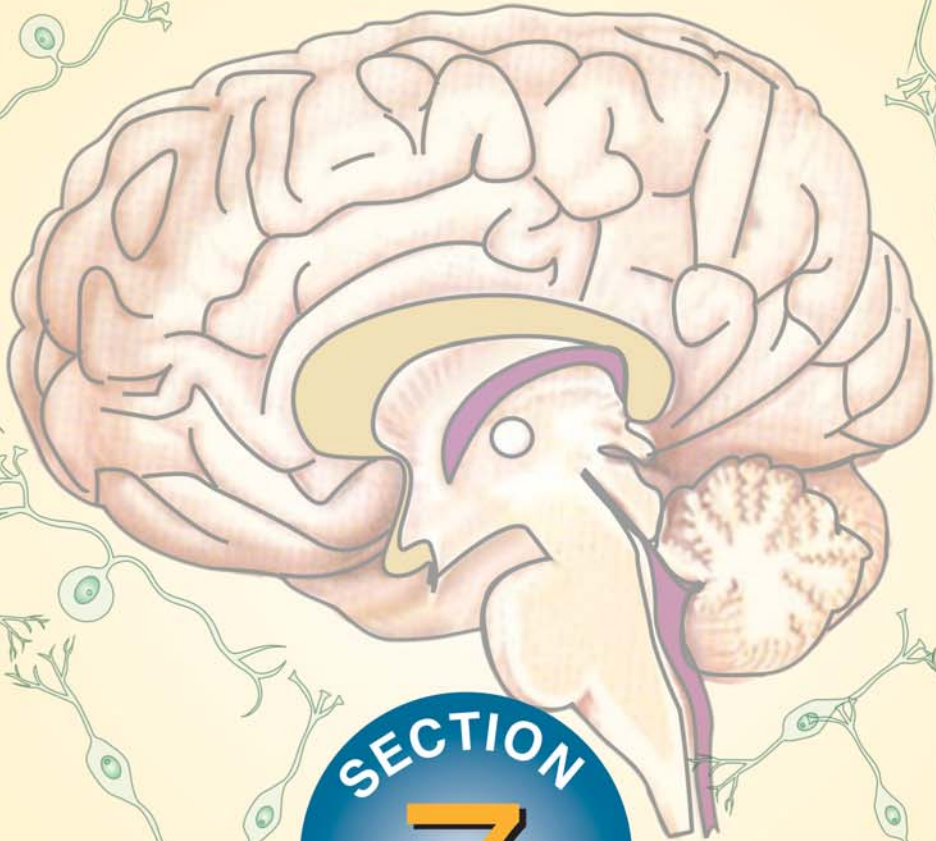

SECTION
7

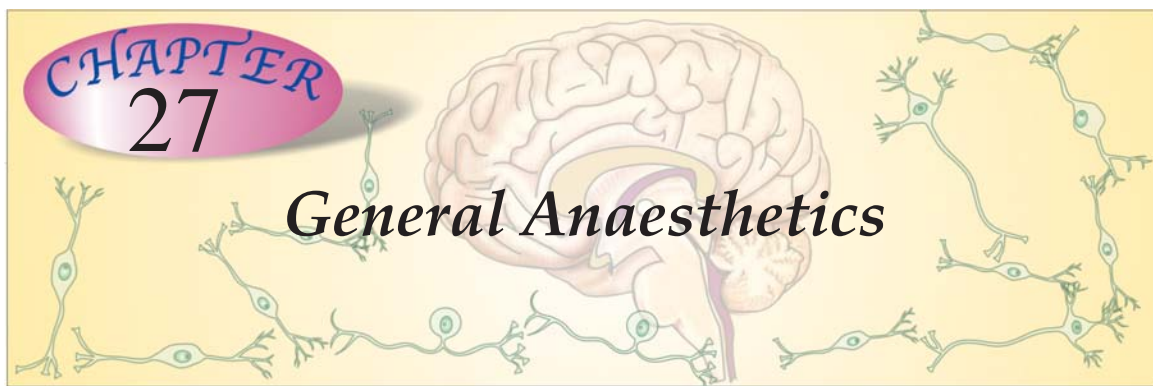

General anaesthetics (GAs) are drugs which produce reversible loss of all sensation and consciousness. The cardinal features of general anaesthesia are:

- Loss of all sensation, especially pain
- Sleep (unconsciousness) and amnesia
- Immobility and muscle relaxation
- Abolition of somatic and autonomic reflexes.

In the modern practice of balanced anaesthesia, these modalities are achieved by using combination of inhaled and i.v. drugs, each drug for a specific purpose; anaesthesia has developed as a highly specialized science in itself.

History Before the middle of 19th century a number of agents like alcohol, opium, cannabis, or even concussion and asphyxia were used to obtund surgical pain, but operations were horrible ordeals. Horace Wells, a dentist, picked up the idea of using *nitrous oxide* (N_2O) from a demonstration of laughing gas in 1844. However, he often failed to relieve dental pain completely and the use of N_2O had to wait till other advances were made. Morton, a dentist and medical student at Boston, after experimenting on animals, gave a demonstration of *ether* anaesthesia in 1846, and it soon became very popular. *Chloroform* was used by Simpson in Britain for obstetrical purpose in 1847, and despite its toxic potential, it became a very popular surgical anaesthetic. *Cyclopropane* was introduced in 1929, but the new generation of anaesthetics was heralded by *halothane* in 1956. The first i.v. anaesthetic *thiopentone* was introduced in 1935.

MECHANISM OF GENERAL ANAESTHESIA

The mechanism of action of GAs is not precisely known. A wide variety of chemical agents produce general anaesthesia. Therefore, GA action had been related to some common physicochemical property of the drugs. Mayer and Overton (1901) pointed out a direct parallelism between lipid/water partition coefficient of the GAs and their anaesthetic potency.

Minimal alveolar concentration (MAC) is the lowest concentration of the anaesthetic in pulmonary alveoli needed to produce immobility in response to a painful stimulus (surgical incision) in 50% individuals. It is accepted as a valid measure of potency of inhalational GAs because it remains fairly constant for a given species even under varying conditions.

The MAC of a number of GAs shows excellent correlation with their oil/gas partition coefficient. However, this only reflects capacity of the anaesthetic to enter into CNS and attain sufficient concentration in the neuronal membrane, but not the mechanism by which anaesthesia is produced.

Recent evidence favours a direct interaction of the GA molecules with hydrophobic domains of membrane proteins or the lipid-protein interface.

It has now been realised that different anaesthetics may be acting through different molecular mechanisms, and various components of the anaesthetic state involve action at discrete loci in the cerebrospinal axis. The principal locus of causation of unconsciousness appears to be in the thalamus or reticular activating system, amnesia may result from action in hippocampus, while spinal cord is the likely seat of immobility on surgical stimulation.

Recent findings show that ligand gated ion channels (but not voltage sensitive ion channels) are the major targets of anaesthetic action. The GABA_A receptor gated Cl⁻ channel is the most important of these. Many inhalational anaesthetics, barbiturates, benzodiazepines and propofol potentiate the action of inhibitory transmitter GABA to open Cl⁻ channels. Each of the above anaesthetics appears to interact with its own specific binding site on the GABA_A receptor-Cl⁻ channel complex, but none binds to the GABA binding site as such; though some inhaled anaesthetics and barbiturates (but not benzodiazepines) can directly activate Cl⁻ channels. Action of glycine (another inhibitory transmitter which also activates Cl⁻ channels) in the spinal cord and medulla is augmented by barbiturates, propofol and many inhalational anaesthetics. This action may block responsiveness to painful stimuli resulting in immobility of the anaesthetic state. Certain fluorinated anaesthetics and barbiturates, in addition, inhibit the neuronal cation channel gated by nicotinic cholinergic receptor which may mediate analgesia and amnesia.

On the other hand, N₂O and ketamine do not affect GABA or glycine gated Cl⁻ channels. Rather they selectively inhibit the excitatory NMDA type of glutamate receptor. This receptor gates mainly Ca²⁺ selective cation channels in the neurones, inhibition of which appears to be the primary mechanism of anaesthetic action of ketamine as well as N₂O. The volatile anaesthetics have little action on this receptor.

Neuronal hyperpolarization caused by GAs has been ascribed to activation of a specific type

of K⁺ channels, while inhibition of transmitter release from presynaptic neurones has been related to interaction with certain critical synaptic proteins. Thus, different facets of anaesthetic action may have distinct neuronal basis, as opposed to the earlier belief of a global neuronal depression.

Unlike local anaesthetics which act primarily by blocking axonal conduction, the GAs appear to act by depressing synaptic transmission.

STAGES OF ANAESTHESIA

GAs cause an irregularly descending depression of the CNS, i.e. the higher functions are lost first and progressively lower areas of the brain are involved, but in the spinal cord lower segments are affected somewhat earlier than the higher segments. The vital centres located in the medulla are paralysed the last as the depth of anaesthesia increases. Guedel (1920) described four stages with *ether* anaesthesia, dividing the III stage into 4 planes. These clear-cut stages are not seen now-a-days with the use of faster acting GAs, premedication and employment of many drugs together. The precise sequence of events differs somewhat with anaesthetics other than ether. However, ether continues to be used in India and description of these stages still serves to define the effects of light and deep anaesthesia. Important features of different stages are depicted in Fig. 27.1.

I. Stage of analgesia Starts from beginning of anaesthetic inhalation and lasts upto the loss of consciousness. Pain is progressively abolished. Patient remains conscious, can hear and see, and feels a dream like state; amnesia develops by the end of this stage. Reflexes and respiration remain normal.

Though some minor operations can be carried out during this stage, it is rather difficult to maintain—use is limited to short procedures.

II. Stage of delirium From loss of consciousness to beginning of regular respiration. Appa-











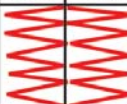
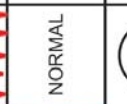













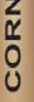
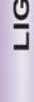



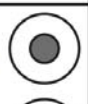





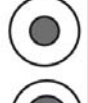

STAGE	Respiration		Ocular movem.	Pupil size	Reflexes	SK. mus. tone	B. P.	H. R.	USES
	Thor.	Abd.							
I ANALGESIA			NORMAL		 EYE LID  PHARYNGEAL  CORNEAL  LIGHT				Labour, Incisions & Minor ops.
II DELIRIUM			ROVING EYE BALLS		   				NIL
III SURGICAL ANAESTHESIA	1		FIXED EYES		   				Most of the surgical operations
	2								
	3								
	4								
IV MEDULLARY PARALYSIS									Never attempted

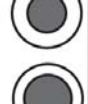
Fig. 27.1: Stages of general anaesthesia

rent excitement is seen—patient may shout, struggle and hold his breath; muscle tone increases, jaws are tightly closed, breathing is jerky; vomiting, involuntary micturition or defecation may occur. Heart rate and BP may rise and pupils dilate due to sympathetic stimulation.

No stimulus should be applied or operative procedure carried out during this stage. This stage is inconspicuous in modern anaesthesia.

III. Surgical anaesthesia Extends from onset of regular respiration to cessation of spontaneous breathing. This has been divided into 4 planes which may be distinguished as:

Plane 1 Roving eyeballs. This plane ends when eyes become fixed.

Plane 2 Loss of corneal and laryngeal reflexes.

Plane 3 Pupil starts dilating and light reflex is lost.

Plane 4 Intercostal paralysis, shallow abdominal respiration, dilated pupil.

As anaesthesia passes to deeper planes, progressively—muscle tone decreases, BP falls, HR increases with weak pulse, respiration decreases in depth and later in frequency also—thoracic lagging behind abdominal.

IV. Medullary paralysis Cessation of breathing to failure of circulation and death. Pupil is widely dilated, muscles are totally flabby, pulse is thready or imperceptible and BP is very low.

Many of the above indices have been robbed by the use of atropine (pupillary, heart rate), morphine (respiration, pupillary), muscle relaxants (muscle tone, respiration, eye movements, reflexes) etc. and the modern anaesthetist has to depend on several other observations to gauge the depth of anaesthesia.

- If eyelash reflex is present and patient is making swallowing movements—stage II has not been reached.
- Loss of response to painful stimulus (e.g. pressure on the upper nasal border of orbit) — stage III has been reached.
- Incision of the skin causes reflex increase in respiration, BP rise or other effects; insertion of endotracheal tube is resisted and induces coughing, vomiting, laryngospasm; tears appear in eye; passive inflation of lungs is resisted—anaesthesia is light.
- Fall in BP, cardiac and respiratory depression are signs of deep anaesthesia.

In the present day practice anaesthesia is generally kept light; adequate analgesia, amnesia and muscle relaxation are produced by the use of intravenous drugs. Premedication with CNS depressants and opioids or their concurrent use lowers MAC of the inhaled anaesthetic. When a combination of two inhalational anaesthetics (e.g. N₂O + isoflurane) is used, their MACs are additive: lower concentration of each is required. The dose-response relationship of inhaled anaesthetics is very steep; just 10% higher concentration (1.1 MAC) immobilizes >90% subjects. Concentrations of inhalational anaesthetics exceeding 1.2 MAC are rarely used, and 2–3 MAC is often lethal.

PHARMACOKINETICS OF INHALATIONAL ANAESTHETICS

Inhalational anaesthetics are gases or vapours that diffuse rapidly across pulmonary alveoli and tissue barriers. The depth of anaesthesia depends on the potency of the agent (MAC is an index of potency) and its partial pressure (PP) in the brain, while induction and recovery depend on the rate of change of PP in the brain. Transfer of the anaesthetic between lung and brain depends on a series of tension gradients which may be summarized as—



Factors affecting the PP of anaesthetic attained in the brain are—

1. *PP of anaesthetic in the inspired gas* This is proportional to its concentration in the inspired gas mixture. Higher the inspired tension more anaesthetic will be transferred to the blood. Thus, induction can be hastened by administering the GA at high concentration in the beginning.

2. *Pulmonary ventilation* It governs delivery of the GA to the alveoli. Hyperventilation will bring in more anaesthetic per minute and respiratory depression will have the opposite effect. Influence of minute volume on rate of induction is greatest in the case of agents which have high blood solubility because their PP in blood takes a long time to approach the PP in alveoli. However, it does not affect the terminal depth of anaesthesia attained with any concentration of a GA.

3. *Alveolar exchange* The GAs diffuse freely across alveoli, but if alveolar ventilation and perfusion are mismatched (as occurs in emphysema and other lung diseases) the attainment of equilibrium between alveoli and blood is delayed: well perfused alveoli may not be well ventilated—blood draining these alveoli carries less anaesthetic and dilutes the blood coming from well ventilated alveoli. Induction and recovery both are slowed.

4. *Solubility of anaesthetic in blood* This is the most important property determining induction and recovery. Large amount of an anaesthetic that is highly soluble in blood (ether) must dissolve before its PP is raised. The rise as well as fall of PP in blood and consequently induction as well as recovery are slow. Drugs with low blood solubility, e.g. N₂O, sevoflurane, desflurane induce quickly.

Blood: gas partition coefficient (λ) given by the ratio of the concentration of the anaesthetic in blood to that in the gas phase at equilibrium is the index of solubility of the GA in blood.

5. *Solubility of anaesthetic in tissues* Relative solubility of the anaesthetic in blood and tissue determines its concentration in that tissue at equilibrium. Most of GAs are equally soluble in

lean tissues as in blood, but more soluble in fatty tissue. Anaesthetics with higher lipid solubility (halothane) continue to enter adipose tissue for hours and also leave it slowly. The concentration of these agents is much higher in white matter than in grey matter.

6. Cerebral blood flow Brain is a highly perfused organ; as such GAs are quickly delivered to it. This can be hastened by CO₂ inhalation which causes cerebral vasodilatation—induction and recovery are accelerated. Carbon dioxide stimulates respiration and this also speeds up the transport.

Elimination When anaesthetic administration is discontinued, gradients are reversed and the channel of absorption (pulmonary epithelium) becomes the channel of elimination. All inhaled anaesthetics are mainly eliminated through lungs. The same factors which govern induction also govern recovery. Anaesthetics, in general, continue to enter and persist for long periods in adipose tissue because of their high lipid solubility and low blood flow to fatty tissues. Muscles occupy an intermediate position between brain and adipose tissue. Most GAs are eliminated unchanged. Metabolism is significant only for halothane which is >20% metabolized in liver. Others are practically not metabolized. Recovery may be delayed after prolonged anaesthesia, especially in case of more lipid-soluble anaesthetics (halothane, isoflurane), because large quantities of the anaesthetic have entered the muscle and fat, from which it is released slowly into blood.

Second gas effect and diffusion hypoxia In the initial part of induction, diffusion gradient from alveoli to blood is high and larger quantity of anaesthetic is entering blood. If the inhaled concentration of anaesthetic is high, substantial loss of alveolar gas volume will occur and the gas mixture will be sucked in, independent of ventilatory exchange—gas flow will be higher than tidal volume. This is significant only with N₂O, since it is given at 70–80% concentration;

though it has low solubility in blood, about 1 litre/min of N₂O enters blood in the first few minutes—gas flow is 1 litre/min higher than minute volume. If another potent anaesthetic, e.g. halothane (1–2%) is being given at the same time, it also will be delivered to blood at a rate 1 litre/min higher than minute volume and induction will be faster—*second gas effect*.

The reverse occurs when N₂O is discontinued after prolonged anaesthesia—N₂O having low blood solubility rapidly diffuses into alveoli and dilutes the alveolar air—PP of oxygen in alveoli is reduced. The resulting hypoxia, called *diffusion hypoxia*, is not of much consequence if cardiopulmonary reserve is normal, but may be dangerous if it is low. This can be prevented by continuing 100% O₂ inhalation for a few minutes after discontinuing N₂O, instead of straight away switching over to air. Diffusion hypoxia is not significant with other anaesthetics because they are administered at low concentrations (0.2–4%) and cannot dilute alveolar air by more than 1–2%.

TECHNIQUES OF INHALATION OF ANAESTHETICS

Different techniques are used according to facility available, agent used, condition of the patient, type and duration of operation.

1. Open drop method Liquid anaesthetic is poured over a mask with gauze and its vapour is inhaled with air. A lot of anaesthetic vapour escapes in the surroundings and the concentration of anaesthetic breathed by the patient cannot be determined. It is wasteful—can be used only for cheap anaesthetics. Some rebreathing does occur in this method. However, it is simple and requires no special apparatus. Ether is the only agent used by this method, especially in children.

2. Through anaesthetic machines Use is made of gas cylinders, specialized graduated vaporisers, flow meters, unidirectional valves, corrugated rubber tubing and reservoir bag.

The gases are delivered to the patient through a tightly fitting face mask or endotracheal tube. Administration of the anaesthetic can be more precisely controlled and in many situations its concentration determined. Respiration can be controlled and assisted by the anaesthetist.

(a) *Open system* The exhaled gases are allowed to escape through a valve and fresh anaesthetic mixture is drawn in each time. No rebreathing is allowed—flow rates are high—more drug is consumed. However, inhaled O₂ and anaesthetic concentration can be accurately delivered.

(b) *Closed system* The patient rebreathes the exhaled gas mixture after it has circulated through sodalime which absorbs CO₂. Only as much O₂ and anaesthetic as have been taken up by the patient are added to the circuit. The flow rates are low; especially useful for expensive and explosive agents (little anaesthetic escapes in the surrounding air) e.g. halothane, enflurane, isoflurane. However, control of inhaled anaesthetic concentration is difficult.

(c) *Semiclosed system* Partial rebreathing is allowed through a partially closed valve. Conditions are intermediate with moderate flow rates.

Properties of an ideal anaesthetic

A. For the patient It should be pleasant, non-irritating, should not cause nausea or vomiting. Induction and recovery should be fast with no after effects.

B. For the surgeon It should provide adequate analgesia, immobility and muscle relaxation. It should be noninflammable and nonexplosive so that cautery may be used.

C. For the anaesthetist Its administration should be easy, controllable and versatile.

Margin of safety should be wide—no fall in BP.

Heart, liver and other organs should not be affected.

It should be potent so that low concentrations are needed and oxygenation of the patient does not suffer.

Rapid adjustments in depth of anaesthesia should be possible.

It should be cheap, stable and easily stored.

It should not react with rubber tubing or soda lime.

The important physical and anaesthetic properties of inhalational anaesthetics are presented in Table 27.1.

CLASSIFICATION

Inhalational

Gas

Nitrous oxide

Volatile liquids

Ether

Halothane

Enflurane

Isoflurane

Desflurane

Sevoflurane

Intravenous

Inducing agents

Thiopentone sod.

Methohexitone sod.

Propofol

Etomidate

Slower acting drugs

Benzodiazepines

Diazepam

Lorazepam

Midazolam

Dissociative anaesthesia

Ketamine

Opioid analgesia

Fentanyl

Cyclopropane, trichloroethylene and methoxyflurane are no longer used.

INHALATIONAL ANAESTHETICS

1. Nitrous oxide (N₂O) It is a colourless, odourless, heavier than air, noninflammable gas supplied under pressure in steel cylinders. It is nonirritating, but low potency anaesthetic; unconsciousness cannot be produced in all individuals without concomitant hypoxia: MAC is 105% implying that even pure N₂O cannot produce adequate anaesthesia at 1 atmosphere pressure. Patients maintained on 70% N₂O + 30% O₂ along with muscle relaxants often recall the events during anaesthesia, but some lose awareness completely.

Nitrous oxide is a good analgesic; even 20% produces analgesia equivalent to that produced by conventional doses of morphine. It is a poor muscle relaxant; neuromuscular blockers are often required. Onset of N₂O action is quick and smooth (but thiopentone is often used for induction), recovery is rapid: both because of its low blood solubility. Second gas effect and

Table 27.1: Physical and anaesthetic properties of inhalational anaesthetics

Anaesthetic	Boiling point (°C)	Inflammability	Irritancy (odour)	Oil: Gas partition coefficient*	Blood: Gas partition coefficient*	MAC (%)	Induction	Muscle relaxation
1. Ether	35	Infl. + Explo.	+++ (Pungent)	65	12.1	1.9	Slow	V. good
2. Halothane	50	Noninfl.	– (Pleasant)	224	2.3	0.75	Interm.	Fair
3. Enflurane	56	Noninfl.	–	98	1.9	1.68	Interm.	Good
4. Isoflurane	48	Noninfl.	± (Not pleasant)	99	1.4	1.2	Fast	Good
5. Desflurane	24	Noninfl.	+ (Unpleasant)	19	0.42	6.0	Fast	Good
6. Sevoflurane	59	Noninfl.	– (Pleasant)	50	0.68	2.0	Fast	Good
7. Nitrous oxide	Gas	Noninfl.	–	1.4	0.47	105	Fast	Poor

*At 37°C

MAC—Minimal alveolar concentration; Infl.—Inflammable; Explo.—Explosive; Interm.—Intermediate

diffusion hypoxia occur with N₂O only. Post-anaesthetic nausea is not marked.

Nitrous oxide is generally used as a carrier and adjuvant to other anaesthetics. A mixture of 70% N₂O + 25–30% O₂ + 0.2–2% another potent anaesthetic is employed for most surgical procedures. In this way concentration of the other anaesthetic can be reduced to 1/3 for the same level of anaesthesia. Because N₂O has little effect on respiration, heart and BP: breathing and circulation are better maintained with the mixture than with the potent anaesthetic given alone in full doses. However, N₂O can expand pneumothorax and other abnormal air pockets in the body.

As the sole agent, N₂O (50%) has been used with O₂ for dental and obstetric analgesia. It is nontoxic to liver, kidney and brain. Metabolism of N₂O does not occur; it is quickly removed from body by lungs. It is cheap and very commonly used.

2. Ether (Diethyl ether) It is a highly volatile liquid, produces irritating vapours which are inflammable and explosive.



Ether is a potent anaesthetic, produces good analgesia and marked muscle relaxation by reducing ACh output from motor nerve endings—dose of competitive neuromuscular blockers should be reduced to about 1/3.

It is highly soluble in blood—induction is prolonged and unpleasant with struggling, breath-holding, salivation and marked respiratory secretions (atropine must be given as premedication to prevent the patient from drowning in his own secretions). Recovery is slow; post-anaesthetic nausea, vomiting and retching are marked.

BP and respiration are generally well maintained because of reflex stimulation and high sympathetic tone. It does not sensitize the heart to Adr, and is not hepatotoxic.

Ether is not used now in developed countries because of its unpleasant and inflammable properties. However, it is still used in developing countries, particularly in peripheral areas because it is—cheap, can be given by open drop method (though congestion of eye, soreness of trachea and ether burns on face can occur) without the need for any equipment, and is relatively safe even in inexperienced hands.

3. Halothane (FLUOTHANE) It is a volatile liquid with sweet odour, nonirritant and noninflammable. Solubility in blood is intermediate—induction is reasonably quick and pleasant.



HALOTHANE

It is a potent anaesthetic—precise control of administered concentration is essential. For induction 2-4% and for maintenance 0.5-1% is delivered by the use of a special vaporizer. It is not a good analgesic or muscle relaxant; however, it potentiates competitive neuromuscular blockers.

Halothane causes direct depression of myocardial contractility by reducing intracellular Ca^{2+} concentration. Moreover, sympathetic activity fails to increase (as occurs with ether). Cardiac output is reduced with deepening anaesthesia. BP starts falling early and parallels the depth. Many vascular beds dilate but total peripheral resistance is not significantly reduced. Heart rate is reduced by vagal stimulation, direct depression of SA nodal automaticity and lack of baroreceptor activation even when BP falls. It tends to sensitize the heart to the arrhythmogenic action of Adr. The electrophysiological effects are conducive to re-entry—tachyarrhythmias occur occasionally.

Halothane causes relatively greater depression of respiration; breathing is shallow and rapid—PP of CO_2 in blood rises if respiration is not assisted. Ventilatory support with added oxygen is frequently required. It tends to accentuate perfusion-ventilation mismatch in the lungs by causing vasodilatation in hypoxic alveoli.

Pharyngeal and laryngeal reflexes are abolished early and coughing is suppressed while bronchi dilate—preferred for asthmatics. It inhibits intestinal and uterine contractions. This property is utilized for assisting external or internal version during late pregnancy. However, its use during labour can prolong delivery and increase postpartal blood loss.

Urine formation is decreased during halothane anaesthesia—primarily due to low g.f.r. as a result of fall in BP.

Hepatitis occurs in susceptible individuals (approximately 1 in 10,000) especially after repeated use. A metabolite of halothane is probably involved—causes chemical or immunological injury.

A genetically determined reaction *malignant hyperthermia* occurs rarely. Many susceptible subjects have an abnormal RyR (Ryanodine receptor) calcium channel at the sarcoplasmic reticulum of the skeletal muscles, which is triggered by halothane to release massive amounts of Ca^{2+} intracellularly causing persistent muscle contraction and increased heat production. Succinylcholine accentuates the condition (*see* Ch. 25). Rapid external cooling, bicarbonate infusion, 100% O_2 inhalation and i.v. dantrolene are used to treat malignant hyperthermia.

About 20% of halothane that enters blood is metabolized in the liver, the rest is exhaled out. Elimination may continue for 24-48 hours after prolonged administration. Recovery from halothane anaesthesia is smooth and reasonably quick; shivering may occur but nausea and vomiting are rare. Psychomotor performance and mental ability remain depressed for several hours after regaining consciousness.

It is currently one of the most popular anaesthetics because of nonirritant, noninflammable, pleasant and rapid action, particularly suitable for induction and maintenance in children and as maintenance anaesthetic in adults. However, in affluent countries it has been largely replaced by the newer agents which are costly. Its deficiencies in terms of poor analgesia and muscle relaxation are compensated by concomitant use of N_2O or opioids and neuromuscular blockers.

4. Enflurane This faster acting substitute of halothane has similar actions, but is less soluble in blood and fat; accumulates in the body to a lesser extent. Because of its propensity to provoke seizures at deeper levels of anaesthesia, it has been superseded by isoflurane which has other desirable properties as well.

5. Isoflurane (SOFANE) It is a later introduced (1981) isomer of enflurane; has similar properties, but about 1½ times more potent, more volatile and less soluble in blood. It produces relatively rapid induction and recovery, and is administered through a special vaporizer; 1.5–3% induces anaesthesia in 7–10 min, and 1–2% is used for maintenance.

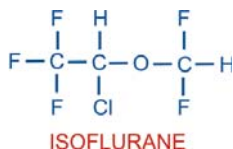

Magnitude of fall in BP is similar to halothane, but is primarily due to vasodilatation while cardiac output is well maintained. Heart rate is increased. These cardiovascular effects probably result from stimulation of β adrenergic receptors, but it does not sensitize the heart to adrenergic arrhythmias. Coronary circulation is maintained: safer in patients with myocardial ischaemia. Respiratory depression is prominent and assistance is usually needed to avoid hypercarbia. Secretions are slightly increased.

Uterine and skeletal muscle relaxation is similar to halothane.

Metabolism of isoflurane is negligible. Renal and hepatic toxicity has not been encountered. Post-anaesthetic nausea and vomiting is low.

Pupils do not dilate and light reflex is not lost even at deeper levels.

Though slightly irritant, isoflurane has many advantages, i.e. better adjustment of depth of anaesthesia and low toxicity. It is a good maintenance anaesthetic, but not preferred for induction. It does not provoke seizures and is preferred for neurosurgery. Isoflurane has become the routine anaesthetic, but use may be restricted due to cost.

6. Desflurane It is a newer all fluorinated congener of isoflurane which has gained popularity as an anaesthetic for out patient surgery in western countries. Though it is highly volatile, a thermostatically heated special vapo-

rizer is used to deliver a precise concentration of pure desflurane vapour in the carrier gas ($\text{N}_2\text{O} + \text{O}_2$) mixture. Its distinctive properties are lower oil: gas partition coefficient and very low solubility in blood as well as in tissues, because of which induction and recovery are very fast. Depth of anaesthesia changes rapidly with change in inhaled concentration. Postanaesthetic cognitive and motor impairment is shortlived—patient can be discharged a few hours after surgery.

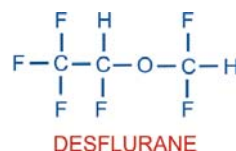

Desflurane is less potent than isoflurane; higher concentration has to be used for induction—irritates air passage—may induce coughing, breath-holding and laryngospasm because of somewhat pungent odour making it unsuitable for induction. Rapid induction sometimes causes brief sympathetic stimulation and tachycardia. Degree of respiratory depression, muscle relaxation, vasodilatation and fall in BP, as well as maintained cardiac contractility and coronary circulation are like isoflurane. Lack of seizure provoking potential or arrhythmogenicity and absence of liver as well as kidney toxicity are also similar to isoflurane. It is exhaled unchanged, but more rapidly. As such, desflurane can serve as a good alternative to isoflurane for routine surgery as well, especially prolonged operations.

7. Sevoflurane This new polyfluorinated anaesthetic has properties intermediate between isoflurane and desflurane. Solubility in blood and tissues as well as potency are less than isoflurane but more than desflurane.

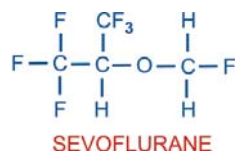

Induction and emergence from anaesthesia are fast and rapid changes in depth can be achieved. Absence of pungency makes it pleasant and administrable through face mask. Unlike desflurane, it poses no problem in induction; acceptability is good even by pediatric patients. Recovery is smooth; orientation, cognitive and motor functions are regained almost as quickly as with desflurane. Sevoflurane is suitable both for outpatient as well as inpatient surgery, but its high cost and need for high-flow open system makes it very expensive to use. In India, only high-end hospitals are using it.

Sevoflurane does not cause sympathetic stimulation and airway irritation even during rapid induction. Fall in BP is due to vasodilatation as well as modest cardiac depression. Respiratory depression, absence of seizure and arrhythmia precipitating propensity are similar to isoflurane. About 3% of absorbed sevoflurane is metabolized, but the amount of fluoride liberated is safe for kidney and liver. However, it is degraded by soda-lime—not recommended for use in closed circuit.

INTRAVENOUS ANAESTHETICS

INDUCING AGENTS

These are drugs which on i.v. injection produce loss of consciousness in one arm-brain circulation time (~11 sec); are generally used for induction because of rapidity of onset of action. Anaesthesia is then usually maintained by an inhalational agent. They also serve to reduce the amount of maintenance anaesthetic. Supplemented with analgesics and muscle relaxants, they can also be used as the sole anaesthetic.

1. Thiopentone sod. It is an ultrashort acting thiobarbiturate, highly soluble in water yielding a very alkaline solution, which must be prepared freshly before injection. Extravasation of the solution or inadvertent intraarterial injection produces intense pain—necrosis and gangrene may occur.

Injected i.v. (3–5 mg/kg) as a 2.5% solution, it produces unconsciousness in 15–20 sec. Its undissociated form has high lipid solubility—enters brain almost instantaneously. Initial distribution depends on organ blood flow—brain gets large amounts. However, as other less vascular tissues (muscle, fat) gradually take up the drug, blood concentration falls and it back diffuses from the brain: consciousness is regained in 6–10 min ($t_{1/2}$ of distribution phase is 3 min).

On repeated injection, the extracerebral sites are gradually filled up—lower doses produce anaesthesia which lasts longer. Its ultimate disposal occurs mainly by hepatic metabolism (elimination $t_{1/2}$ is 7–12 hr), but this is irrelevant for termination of action of a single dose. Residual CNS depression may persist for > 12 hr. The patient should not be allowed to leave the hospital without an attendant before this time.

Thiopentone is a poor analgesic. Painful procedures should not be carried out under its influence unless an opioid or N₂O has been given; otherwise, the patient may struggle, shout and show reflex changes in BP and respiration.

It is a weak muscle relaxant; does not irritate air passages. Respiratory depression with inducing doses of thiopentone is generally transient, but with large doses it can be severe. BP falls immediately after injection mainly due to vasodilatation, but recovers rapidly. Cardiovascular collapse may occur if hypovolemia, shock or sepsis are present. It does not sensitize the heart to Adr, arrhythmias are rare.

Thiopentone is a commonly used inducing agent. It can be employed as the sole anaesthetic for short operations that are not painful.

Adverse effects Laryngospasm occurs generally when respiratory secretions or other irritants are present, or when intubation is attempted while anaesthesia is light. It can be prevented by atropine premedication and administration of succinylcholine immediately after thiopentone. Succinylcholine and thiopen-

tone react chemically—should not be mixed in the same syringe.

Shivering and delirium may occur during recovery. Pain in the postoperative period is likely to induce restlessness; adequate analgesia should be provided. Postanaesthetic nausea and vomiting are uncommon.

It can precipitate acute intermittent porphyria in susceptible individuals—contraindicated.

Other uses Occasionally used for rapid control of convulsions.

Gradual i.v. infusion of subanaesthetic doses can be used to facilitate verbal communication with psychiatric patients and for 'narcoanalysis' of criminals; acts by knocking off guarding.

PENTOTHAL, INTRAVAL SODIUM 0.5, 1 g powder for making fresh injectable solution.

2. Methohexitone sod. It is similar to thiopentone, 3 times more potent, has a quicker and briefer (5–8 min) action. Excitement during induction and recovery is more common. It is more rapidly metabolized ($t_{1/2}$ 4 hr) than thiopentone: patient may be roadworthy more quickly.

3. Propofol Currently, propofol has superseded thiopentone as an i.v. anaesthetic, both for induction as well as maintenance. It is an oily liquid employed as a 1% emulsion. Unconsciousness after propofol injection occurs in 15–45 sec and lasts 5–10 min. Propofol distributes rapidly (distribution $t_{1/2}$ 2–4 min). Elimination $t_{1/2}$ (100 min) is much shorter than that of thiopentone due to rapid metabolism.

Intermittent injection or continuous infusion of propofol is frequently used for total i.v. anaesthesia when supplemented by fentanyl. It lacks airway irritancy and is particularly suited for outpatient surgery, because residual impairment is less marked and shorter-lasting. Incidence of postoperative nausea and vomiting is low; patient acceptability is very good. Excitatory effects and involuntary movements are noted in few patients. Induction apnoea lasting ~1 min is common. Fall in BP due primarily to vasodilatation with less marked cardiac depression occurs consistently, and is occasionally severe, but short lasting. Bradycardia is also

frequent. Maintenance anaesthesia with propofol produces dose-dependent respiratory depression which is more marked than with thiopentone. Pain during injection is also frequent; can be minimized by combining with lidocaine.

Dose: 2 mg/kg bolus i.v. for induction; 9 mg/kg/hr for maintenance.

PROPOVAN 10 mg/ml and 20 mg/ml in 10, 20 ml vials. In subanaesthetic doses (2.4 mg/kg/hr) it is the drug of choice for sedating intubated patients in intensive care units. However, it is not approved for such use in children; prolonged sedation with higher doses has caused severe metabolic effects and heart failure even in adults.

4. Etomidate It is another induction anaesthetic, which has a briefer duration of action (4–8 min) than thiopentone; produces little cardiovascular and respiratory depression, but motor restlessness and rigidity is more prominent as are pain on injection or nausea and vomiting on recovery. It is a poor analgesic and has not found much favour.

SLOWER ACTING DRUGS

1. Benzodiazepines (BZDs) In addition to preanaesthetic medication, BZDs are now frequently used for inducing, maintaining and supplementing anaesthesia as well as for 'conscious sedation'. Relatively large doses (diazepam 0.2–0.3 mg/kg or equivalent) injected i.v. produce sedation, amnesia and then unconsciousness in 5–10 min. If no other anaesthetic or opioid is given, the patient becomes responsive in 1 hr or so due to redistribution of the drug (distribution $t_{1/2}$ of diazepam is 15 min), but amnesia persists for 2–3 hr and sedation for 6 hr or more. Recovery is further delayed if larger doses are given. BZDs are poor analgesics: an opioid or N_2O is usually added if the procedure is painful.

By themselves, BZDs do not markedly depress respiration, cardiac contractility or BP, but when opioids are also given these functions are considerably compromised. BZDs decrease muscle tone by central action, but require neuromuscular blocking drugs for muscle relaxation of surgical grade. They do not provoke postoperative nausea

or vomiting. Involuntary movements are not stimulated.

BZDs are now the preferred drugs for endoscopies, cardiac catheterization, angiographies, conscious sedation during local/regional anaesthesia, fracture setting, ECT, etc. They are a frequent component of balanced anaesthesia employing several drugs. The anaesthetic action of BZDs can be rapidly reversed by flumazenil 0.5–2 mg i.v.

Diazepam 0.2–0.5 mg/kg by slow undiluted injection in a running i.v. drip: this technique reduces the burning sensation in the vein and incidence of thrombophlebitis.

VALIUM, CALMPOSE 10 mg/2 ml inj.

Lorazepam Three times more potent, slower acting and less irritating than diazepam. It distributes more gradually—awakening may be delayed. Amnesia is more profound.

Dose 2–4 mg (0.04 mg/kg) i.v. CALMESE 4 mg/2 ml inj.

Midazolam This BZD is water soluble, non-irritating to veins, faster and shorter acting and 3 times more potent than diazepam. It is being preferred over diazepam for anaesthetic use: 1–2.5 mg i.v. followed by 1/4th supplemental doses. Also used for sedation of intubated and mechanically ventilated patients and in other critical care anaesthesia as 0.02–0.1 mg/kg/hr continuous i.v. infusion.

FULSED, MEZOLAM, SHORTAL 1 mg/ml, 5 mg/ml inj.

2. Ketamine It is pharmacologically related to the hallucinogen phencyclidine; induces a so called '*dissociative anaesthesia*' characterized by profound analgesia, immobility, amnesia with light sleep and feeling of dissociation from ones own body and the surroundings. The primary site of action is in the cortex and subcortical areas; not in the reticular activating system (site of action of barbiturates).

Respiration is not depressed, airway reflexes are maintained, muscle tone increases; limb movements occur and eyes may remain open.

Heart rate, cardiac output and BP are elevated due to sympathetic stimulation. A dose of 1–3 (average 1.5) mg/kg i.v. or 5 mg/kg i.m. produces the above effects within a minute, and recovery starts after 10–15 min, but patient remains amnesic for 1–2 hr. Emergence delirium, hallucinations and involuntary movements occur in upto 50% patients during recovery; but the injection is not painful. Children tolerate the drug better. Ketamine is metabolized in the liver and has an elimination $t_{1/2}$ of 3–4 hr.

Ketamine has been used for operations on the head and neck, in patients who have bled, in asthmatics (relieves bronchospasm), in those who do not want to lose consciousness and for short operations. It is good for repeated use; particularly suitable for burn dressing. Combined with diazepam, it has found use in angiographies, cardiac catheterization and trauma surgery. It may be dangerous for hypertensives, in ischaemic heart disease and in those with raised intracranial pressure (it increases cerebral blood flow), but is good for hypovolemic patients.

KETMIN, KETAMAX, ANEKET 50 mg/ml in 2 ml amp, 10 ml vial.

3. Fentanyl This short acting (30–50 min) potent opioid analgesic related to pethidine is generally given i.v. at the beginning of painful surgical procedures. Reflex effects of painful stimuli are abolished. It is frequently used to supplement anaesthetics in balanced anaesthesia. This permits use of lower anaesthetic concentrations with better haemodynamic stability. Combined with BZDs, it can obviate the need for inhaled anaesthetics for diagnostic, endoscopic, angiographic and other minor procedures in poor risk patients, as well as for burn dressing. Anaesthetic awareness with dreadful recall is a risk.

After i.v. fentanyl (2–4 μ g/kg) the patient remains drowsy but conscious and his co-operation can be commanded. Respiratory depression is marked, but predictable; the patient may be encouraged to breathe and assistance

may be provided. Tone of chest muscles may increase with rapid fentanyl injection: a muscle relaxant is then required to facilitate mechanical ventilation. Heart rate decreases, because fentanyl stimulates vagus. Fall in BP is slight and heart is not sensitized to Adr. Supplemental doses of fentanyl are needed every 30 min or so, but recovery is prolonged after repeated doses.

Nausea, vomiting and itching often occurs during recovery. The opioid antagonist naloxone can be used to counteract persisting respiratory depression and mental clouding. Fentanyl is also employed as adjunct to spinal and nerve block anaesthesia, and to relieve postoperative pain. **TROFENTYL, FENT 50 µg/ml in 2 ml amp, 10 ml vial.**

In the past fentanyl was combined with the short acting neuroleptic droperidol to produce *neurolept analgesia*. Since the combination produces marked fall in BP, respiratory depression and occasionally cardiac arrhythmia, it is outmoded.

Alfentanil, Sufentanil and *remifentanil* are still shorter acting analogues which can be used in place of fentanyl.

4. Dexmedetomidine Activation of central α_2 adrenergic receptors has been known to cause sedation and analgesia. Clonidine (a selective α_2 agonist antihypertensive) given before surgery reduces anaesthetic requirement. Dexmedetomidine is a centrally active selective α_{2A} agonist that has been recently introduced for sedating critically ill/ventilated patients in intensive care units. Analgesia and sedation are produced with little respiratory depression, amnesia or anaesthesia. It is administered by i.v. infusion. Side effects are similar to those with clonidine, *viz.* hypotension, bradycardia and dry mouth.

CONSCIOUS SEDATION

'Conscious sedation' is a monitored state of altered consciousness that can be employed (supplemented with local/regional anaesthesia), to carryout diagnostic/short therapeutic/dental procedures in apprehensive subjects or medically compromised patients, in place of general anaesthesia. It allows the operative procedure to be performed with minimal physiologic and psychologic stress. In conscious sedation, drugs are used to produce a state of CNS depression (but not unconsciousness), sufficient to withstand the trespass of the procedure, while maintaining communication with the patient, who at the same time responds to commands and is able to maintain a patent airway. The difference between conscious sedation and anaesthesia is one of degree. The protective airway

and other reflexes are not lost, making it safer. Drugs used for conscious sedation are:

1. **Diazepam** It is injected i.v. in small (1–2 mg) repeated doses or by slow infusion until the desired level of sedation is produced indicated by relaxation, indifference, slurring of speech, ptosis, etc. Further injection is stopped, after which this state lasts for about 1 hour and psychomotor impairment persists for 6–24 hours; an escort is needed to take back the patient home. Flumazenil can be used to reverse the sedation, but repeated doses are needed.

Midazolam (i.v.) is a shorter acting alternative to diazepam. Oral diazepam administered 1 hr before is also used with the limitation that level of sedation cannot be titrated. The patient remains sedated (not roadworthy) for several hours.

2. **Propofol** Because of brief action, it has to be administered by continuous i.v. infusion regulated by infusion pump throughout the procedure. However, level of sedation can be altered during the procedure and recovery is relatively quick, permitting early discharge of the patient.

3. **Nitrous oxide** The patient is made to breathe 100% oxygen through a nose piece or hood and N_2O is added in 10% increments (to a maximum of 50%) till the desired level of sedation assessed by constant verbal contact is obtained. This is maintained till the procedure is performed. Thereafter, N_2O is switched off, but 100% O_2 is continued for next 5 min. The patient is generally roadworthy in 30–60 min.

4. **Fentanyl** Injected i.v. (1–2 µg/kg every 15–30 min), it can be used alone or in combination with midazolam/propofol.

COMPLICATIONS OF GENERAL ANAESTHESIA

A. During anaesthesia

1. Respiratory depression and hypercarbia.
2. Salivation, respiratory secretions—less now as nonirritant anaesthetics are mostly used.
3. Cardiac arrhythmias, asystole.
4. Fall in BP
5. Aspiration of gastric contents: acid pneumonitis.
6. Laryngospasm and asphyxia.
7. Awareness: dreadful perception and recall of events during surgery—by use of light anaesthesia + analgesics and muscle relaxants.
8. Delirium, convulsions and other excitatory effects are generally seen with i.v. anaesthetics—especially if phenothiazines or

- hyoscine have been given in premedication. These are suppressed by opioids.
9. Fire and explosion—rare now due to use of non-inflammable agents.

B. *After anaesthesia*

1. Nausea and vomiting.
2. Persisting sedation: impaired psychomotor function.
3. Pneumonia, atelectasis.
4. Organ toxicities: liver, kidney damage.
5. Nerve palsies—due to faulty positioning.
6. Emergence delirium.
7. Cognitive defects: prolonged excess cognitive decline has been observed in some patients, especially the elderly, who have undergone general anaesthesia, particularly of long duration.

DRUG INTERACTIONS

1. Patients on antihypertensives given general anaesthetics—BP may fall markedly.
2. Neuroleptics, opioids, clonidine and monoamine oxidase inhibitors potentiate anaesthetics.
3. Halothane sensitizes heart to Adr.
4. If a patient on corticosteroids is to be anaesthetized, give 100 mg hydrocortisone intraoperatively because anaesthesia is a stress—can precipitate adrenal insufficiency and cardiovascular collapse.
5. Insulin need of a diabetic is increased during GA: switch over to plain insulin even if the patient is on oral hypoglycaemics.

PREANAESTHETIC MEDICATION

Preanaesthetic medication refers to the use of drugs before anaesthesia to make it more pleasant and safe. The aims are:

1. Relief of anxiety and apprehension preoperatively and to facilitate smooth induction.
2. Amnesia for pre- and postoperative events.
3. Supplement analgesic action of anaesthetics and potentiate them so that less anaesthetic is needed.

4. Decrease secretions and vagal stimulation caused by anaesthetics.
5. Antiemetic effect extending to the postoperative period.
6. Decrease acidity and volume of gastric juice so that it is less damaging if aspirated.

Different drugs achieve different purposes. One or more drugs may be used in a patient depending on the needs.

1. Sedative-antianxiety drugs Benzodiazepines like diazepam (5–10 mg oral) or lorazepam (2 mg or 0.05 mg/kg i.m. 1 hour before) have become popular drugs for preanaesthetic medication because they produce tranquility and smoothen induction; there is loss of recall of perioperative events (especially with lorazepam) with little respiratory depression or accentuation of postoperative vomiting. They counteract CNS toxicity of local anaesthetics and are being used along with pethidine/fentanyl for a variety of minor surgical and endoscopic procedures.

Midazolam is a good amnesic with potent and shorter lasting action; it is also better suited for i.v. injection, due to water solubility.

Promethazine (50 mg i.m.) is an antihistaminic with sedative, antiemetic and anticholinergic properties. It causes little respiratory depression.

2. Opioids Morphine (10 mg) or pethidine (50–100 mg), i.m. allay anxiety and apprehension of the operation, produce pre- and postoperative analgesia, smoothen induction, reduce the dose of anaesthetic required and supplement poor analgesic (thiopentone, halothane) or weak anaesthetics (N₂O). Postoperative restlessness is also reduced.

Disadvantages They depress respiration, interfere with pupillary signs of anaesthesia, may cause fall in BP during anaesthesia, can precipitate asthma and tend to delay recovery. Other disadvantages are lack of amnesia, flushing, delayed gastric emptying and biliary spasm. Some patients experience dysphoria. Morphine particularly contributes to postoperative constipation, vomiting and urinary retention. Tachycardia sometimes occurs when pethidine has been used.

Use of opioids is now mostly restricted to those having preoperative pain. When indicated, fentanyl is mostly injected i.v. just before induction.

3. Anticholinergics Atropine or hyoscine (0.6 mg i.m./i.v.) have been used, primarily to reduce salivary and bronchial secretions. Need for their use is now less compelling because of the increasing employment of non-irritant anaesthetics. However, they must be given before hand when ether is used. The main aim of their use now is to prevent vagal bradycardia and hypotension (which occur reflexly due to certain surgical procedures), and prophylaxis of laryngospasm which is precipitated by respiratory secretions. Hyoscine, in addition, produces amnesia and antiemetic effect, but tends to delay recovery. Some patients get disoriented; emergence delirium is more common. They dilate pupils, abolish the pupillary signs and increase chances of gastric reflux by decreasing tone of lower esophageal sphincter (LES). They should not be used in febrile patients. Dryness of mouth in the pre- and postoperative period may be distressing.

Glycopyrrolate (0.1–0.3 mg i.m.) is a longer acting quaternary atropine substitute. It is a potent antisecretory and antibradycardiac drug; acts rapidly and is less likely to produce central effects (see Ch. 8).

4. Neuroleptics Chlorpromazine (25 mg), trifluorpromazine (10 mg) or haloperidol (2–4 mg) i.m. are infrequently used in premedication. They allay anxiety, smoothen induction and have antiemetic action. However, they potentiate respiratory depression and hypotension caused by the anaesthetics and delay recovery.

Involuntary movements and muscle dystonias can occur, especially in children.

5. H₂ blockers Patients undergoing prolonged operations, caesarian section and obese patients are at increased risk of gastric regurgitation and aspiration pneumonia. Ranitidine (150 mg) or famotidine (20 mg) given night before and in the morning benefit by raising pH of gastric juice; may also reduce its volume and thus chances of regurgitation. Prevention of stress ulcers is another advantage. They are now routinely used before prolonged surgery.

The proton pump inhibitor omeprazole/pantoprazole is an alternative.

6. Antiemetics *Metoclopramide* 10–20 mg i.m. preoperatively is effective in reducing postoperative vomiting. By enhancing gastric emptying and tone of LES, it reduces the chances of reflux and its aspiration. Extrapyramidal effects and motor restlessness can occur. Combined use of metoclopramide and H₂ blockers is more effective.

Domperidone is nearly as effective and does not produce extrapyramidal side effects.

After its success in cancer chemotherapy induced vomiting, the selective 5-HT₃ blocker *Ondansetron* (4–8 mg i.v.) has been found highly effective in reducing the incidence of post anaesthetic nausea and vomiting as well (see Ch. 47).

CHAPTER 28

Ethyl and Methyl Alcohols

ETHYL ALCOHOL (Ethanol)

Alcohols are hydroxy derivatives of aliphatic hydrocarbons. When unqualified, 'alcohol' refers to *ethyl alcohol* or *ethanol*. Pharmacology of alcohol is important for its presence in beverages (which have been used since recorded history) and for alcohol intoxication, rather than as a drug.

Alcohol is manufactured by fermentation of sugars:

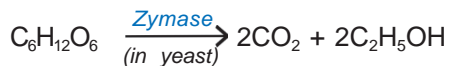

Fermentation proceeds till alcohol content reaches ~ 15%. Then the reaction is inhibited by alcohol itself. Starchy cereals, e.g. barley, when soaked produce malt:



which can then be fermented by yeast to produce alcohol. The major source of commercial alcohol is *mollases*, a byproduct of sugar industry.

ALCOHOLIC BEVERAGES

There are a large variety of alcoholic beverages.

A. Malted liquors Obtained by fermentation of germinating cereals; are undistilled—alcohol content is low (3–6%) e.g. Beers, Stout. Now strong beers (upto 10%) are also available.

B. Wines Produced by fermentation of natural sugars as present in grapes and other fruits. These are also undistilled.

Light wines Claret, Cider; alcohol content 9–12%, cannot exceed 15%.

Fortified wines Port, Sherry (alcohol 16–22%): distilled beverages are added from outside.

Effervescent wines Champagne (12–16% alcohol): bottled before fermentation is complete.

Wines are called 'dry' when all sugar present has been fermented and 'sweet' when some is left.

C. Spirits These are distilled after fermentation; e.g. Rum, Gin, Whiskey, Brandy, Vodka etc. Though the alcohol content of these can vary from 40–55%, in India (and almost internationally) for all licenced brands it is standardized to 42.8% v/v or 37% w/w.

The taste, flavour and value of alcoholic beverages depends not only on alcohol content but on the presence of higher ethers, higher alcohols, aldehydes, esters, polymers, and volatile oils; many of these are formed during 'maturation' of the beverage.

Other forms of alcohol

1. *Absolute alcohol* 99% w/w ethanol (dehydrated alcohol).
2. *Rectified spirit* 90% w/w ethyl alcohol—from mollases, by distillation.
3. *Proof spirit* It is an old term. If whisky is poured on gun powder and ignited and it explodes, then it was labelled to be of 'proof strength'. If water is mixed to it, gun powder will not ignite. 100% proof spirit is 49.29% w/w or 57.1% v/v alcohol.

PHARMACOLOGICAL ACTIONS

1. Local actions Ethanol is a mild rubefacient and counterirritant when rubbed on the skin. By evaporation it produces cooling. Applied to delicate skin (scrotum) or mucous membranes it produces irritation and burning sensation; should not be applied in the mouth, nose, etc. Injected s.c. it causes intense pain, inflammation and necrosis followed by fibrosis. Injected round a nerve it produces permanent damage.

Alcohol is an astringent—precipitates surface proteins and hardens skin. By precipitating bacterial proteins it acts as an antiseptic. The antiseptic action increases with concentration from 20 to 70%, remains constant from 70 to 90% and decreases above that. That 100% ethanol is more dehydrating but poorer antiseptic than 90% ethanol, shows that antibacterial action is not due to dehydration of bacterial protoplasm. Alcohol does not kill bacterial spores.

2. CNS Alcohol is a neuronal depressant. Since the highest areas are most easily deranged and these are primarily inhibitory—apparent excitation and euphoria are experienced at lower plasma concentrations (30–100 mg/dl). Hesitation, caution, self-criticism and restraint are lost first. Mood and feelings are altered; anxiety may be allayed. With increasing concentration (100–150 mg/dl) mental clouding, disorganization of thought, impairment of memory and other faculties, alteration of perception and drowsiness supervene. At 150–200 mg/dl the person is sloppy, ataxic and drunk; 200–300 mg/dl result in stupor and above this unconsciousness prevails, medullary centres are paralysed and death may occur. Though, alcohol can produce anaesthesia, margin of safety is narrow.

Any measurable concentration of alcohol produces a measurable slowing of reflexes; driving is dangerous. Performance is impaired,

fine discrimination and precise movements are obliterated; errors increase, except if fear of punishment and anxiety of failure has already impaired it—performance may be improved by allaying of anxiety and fear.

Effects of alcohol are more marked when the concentration is rising than when it is falling. Some consider it to be a reflection of acute tolerance.

Alcohol can induce sleep but is not a dependable hypnotic. Some individuals report poor quality of sleep and early morning awakening. Sleep architecture may be disorganized and sleep apnoea aggravated. Alcohol raises pain threshold and also alters reaction to it, but is not a dependable analgesic—severe pain can precipitate confusion and convulsions. During the time alcohol is acting on brain, it exerts anticonvulsant action, but this is followed by lowering of threshold: seizures may be precipitated in epileptics. Chronic alcohol abuse damages brain neurones.

The cortex and the reticular activating system are most sensitive to alcohol; other areas get depressed as concentration rises.

Mechanism of action Alcohol was believed to produce CNS depression by a generalized membrane action altering the state of membrane lipids. However, recently specific effect on multiple receptor operated ion channels has been demonstrated at concentrations attained during moderate drinking. Alcohol promotes GABA_A receptor mediated synaptic inhibition (through chloride channel opening) as well as inhibits NMDA and kainate type of excitatory amino acid receptors (operating through cation channels). Action of 5-HT on 5-HT₃ inhibitory autoreceptor (having an intrinsic ion channel) is augmented. Some studies suggest that cerebral nicotinic cholinergic receptors (operating through Na⁺ channel) may also be the targets of alcohol action. Ethanol can indirectly reduce neurotransmitter release by inhibiting voltage sensitive neuronal Ca²⁺ channels. Blockade of adenosine uptake by alcohol could also contribute to synaptic depression. Turnover of NA in brain is enhanced by alcohol through an opioid receptor dependent mechanism. This is

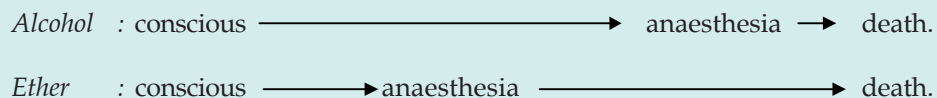

probably important in the pleasurable effects of alcohol and in the genesis of alcohol dependence. Activity of membrane bound enzymes like $\text{Na}^+ \text{K}^+$ ATPase and adenylyl cyclase is also altered. The activity and translocation of channel/enzyme proteins in the membrane could be affected by alcohol through protein kinase C (PKC) and protein kinase A (PKA) mediated alteration in the state of their phosphorylation.

3. CVS The effects are dependent on dose.

Small doses: produce only cutaneous (especially on the face) and gastric vasodilatation. Skin is warm and flushed and there may be conjunctival injection; BP is not affected.

Moderate doses: cause tachycardia and a mild rise in BP due to increased muscular activity and sympathetic stimulation.

Large doses: cause direct myocardial as well as vasomotor centre depression and there is fall in BP.

Epidemiological studies have confirmed that chronic alcoholism contributes to hypertension and can lead to cardiomyopathy. Atrial fibrillation and other cardiac arrhythmias may occur due to conduction defects and Q-T prolongation.

4. Blood Regular intake of small to moderate amounts of alcohol has been found to raise HDL-cholesterol levels and decrease LDL oxidation. This may be responsible for the 15–35% lower incidence of coronary artery disease in such individuals. Risk reduction is greatest in high risk subjects and protection is lost if ≥ 3 drinks are consumed daily. Megaloblastic anaemia has been seen in chronic alcoholism due to interference with folate metabolism.

5. Body temperature Alcohol is reputed to combat cold. It does produce a sense of warmth due to cutaneous and gastric vasodilatation, but heat loss is actually increased in cold surroundings. High doses depress temperature regulating centre.

6. Respiration Brandy or whiskey are reputed as respiratory stimulants in collapse. They irritate buccal and pharyngeal mucosa—may transiently stimulate respiration reflexly. However,

it is better not to depend on this, because the direct action of alcohol on respiratory centre is only a depressant one.

7. GIT Alcoholic beverages have variable effect on gastric secretion depending on the beverage itself and whether the individual likes it. However, dilute alcohol (optimum 10%) put in the stomach by Ryle's tube is a strong stimulant of gastric secretion (especially of acid). It acts directly as well as reflexly. Higher concentrations (above 20%) inhibit gastric secretion, cause vomiting, mucosal congestion and gastritis. Alcoholism is an important cause of chronic gastritis. Lower esophageal sphincter (LES) tone is reduced by alcohol—may accentuate reflux. Bowel movements may be altered in either direction. Acute pancreatitis is a complication of heavy drinking.

8. Liver Neither alcohol intoxication nor chronic use of moderate amounts cause significant liver damage, provided adequate nutrition is maintained. However, it does mobilize peripheral fat and increases fat synthesis in liver in a dose-dependent manner. Proteins may also accumulate in liver because their secretion is decreased. Chronic alcoholism subjects liver to oxidative stress and causes cellular necrosis followed by fibrosis. Acetaldehyde produced during metabolism of alcohol appears to damage the hepatocytes and induce inflammation, especially on chronic ingestion of large amounts. Increased lipid peroxidation and glutathione depletion occurs. These combined with vitamin and other nutritional deficiencies may be responsible for the so called *alcoholic cirrhosis*.

Regular alcohol intake induces microsomal enzymes.

9. Skeletal muscle Alcohol produces little direct effect. Fatigue is allayed by small doses, but muscle work is increased or decreased depending on the predominating central effect. Weakness and myopathy occurs in chronic alcoholism.

10. Kidney Diuresis is often noticed after alcohol intake. This is due to water ingested with drinks and alcohol induced inhibition of ADH secretion. It does not impair renal function.

11. Sex Alcohol is reputed as an aphrodisiac. Aggressive sexual behaviour is due to loss of restraint and inhibition. However, performance of the sexual act is often impaired. Chronic alcoholism can produce impotence, testicular atrophy, gynaecomastia and infertility.

12. Endocrine effects Moderate amounts of alcohol increase Adr release which can cause hyperglycaemia and other sympathetic effects. However, acute intoxication is often associated with hypoglycaemia and depletion of hepatic glycogen, because gluconeogenesis is inhibited. Glucagon, thus fails to reverse it and glucose must be given.

13. Uterine contractions are suppressed at moderate blood levels.

PHARMACOKINETICS

Rate of alcohol absorption from the stomach is dependent on its concentration, presence of food, and other factors, but is generally quite slow. Absorption from intestines is very fast; peak levels are attained after ~30 min. Thus, gastric emptying determines rate of absorption. Limited first pass metabolism occurs in stomach and liver. Absorption of alcohol from skin of adults is minimal but may be significant in infants given alcohol sponges.

Alcohol gets distributed widely in the body (vol of distribution 0.7 L/kg), crosses blood brain barrier efficiently: concentration in brain is very near blood concentration. It also crosses placenta freely. It is oxidized in liver to the extent of 98%. Even with high doses, not more than 10% escapes metabolism.

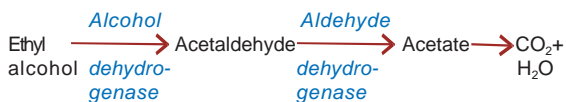

In addition to alcohol dehydrogenase, small amounts of alcohol are oxidized by hepatic microsomal enzymes as well. Metabolism of alcohol follows *zero order* kinetics, i.e. a constant amount (8–12 ml of absolute alcohol/ hour) is degraded in unit time, irrespective of blood concentration. Thus, rate of consuming drinks governs whether a person will get drunk.

Excretion of alcohol occurs through kidney and lungs, but neither is quantitatively significant. Concentration in exhaled air is about 0.05% of blood concentration: this is utilized for medicolegal determination of drunken state. The subject blows in a balloon and alcohol is measured by portable breath analyser.

INTERACTIONS

1. Alcohol synergises with anxiolytics, anti-depressants, antihistaminics, hypnotics, opioids → marked CNS depression with motor impairment can occur: Chances of accidents increase.
2. Individuals taking sulfonylureas (especially chlorpropamide), certain cephalosporins (cefoperazone, moxalactam, cefamandole) and metronidazole have experienced bizarre, somewhat disulfiram-like reactions when they consume alcohol.
3. Acute alcohol ingestion inhibits, while chronic intake induces tolbutamide, phenytoin (and many other drugs) metabolism.
4. Insulin and sulfonylureas: alcohol enhances hypoglycaemia acutely.
5. Aspirin and other NSAIDs cause more gastric bleeding when taken with alcohol.
6. Alcoholics are more prone to paracetamol toxicity due to enhanced generation of its toxic metabolite.

Food value

Alcohol requires no digestion and is metabolized rapidly. It is an energy yielding substrate: 7 Cal/g, but these cannot be stored. It also does not supply body building and other essential

constituents of food. Those who consume substantial part of their caloric intake as alcohol, often suffer from nutritional deficiencies. Thus, alcohol is an imperfect and expensive food.

CONTRAINDICATIONS

Alcohol is seldom prescribed medically. However, its consumption should be avoided by—

1. Peptic ulcer, hyperacidity and gastroesophageal reflux patients (alcohol increases gastric secretion and relaxes LES).
2. Epileptics: seizures may be precipitated.
3. Severe liver disease patients.
4. Unstable personalities: they are likely to abuse it and become excessive drinkers.
5. Pregnant women: Even moderate drinking during pregnancy can produce *foetal alcohol syndrome* resulting in intrauterine and post-natal growth retardation, low IQ, microcephaly, facial and other abnormalities, and immunological impairment→increased susceptibility to infections. Heavy drinking by mother in addition increases the incidence of miscarriage, stillbirths and low birth-weight babies.

Guidelines for safe drinking Physicians are often asked to advise on safe ways of drinking. Various official agencies, physician organizations and alcoholism experts have put forth guidelines in this regard, but they are not uniform. The following may be concluded:

- On an average 1–2 drinks per day is usually safe.
- Not more than 3 drinks on any one occasion.
- Consumption of >3 drinks per day is associated with documented adverse health effects.
- Do not drive or engage in hazardous activities after drinking.
- Do not drink if an interacting drug has been taken.
- Subjects with any contraindication should not drink.
- Safe limits are somewhat lower for women than for men, because metabolism of alcohol is slower and its bioavailability higher (due

to less first pass metabolism in stomach) in women than in men.

[Note: 1 drink = 50 ml of spirits = 150 ml of wines = 400 ml of beer; all have roughly 18 g alcohol, which taken in empty stomach produces a peak alcohol blood level of ~ 25 mg/dl in an adult male of average built.]

TOXICITY

A. Side effects of moderate drinking Nausea, vomiting, flushing, hangover, traffic accidents.

B. Acute alcoholic intoxication Hypotension, gastritis, hypoglycaemia, collapse, respiratory depression, coma and death.

Treatment: Gastric lavage is helpful only when the patient is brought soon after ingesting alcohol, which is rare. Since most patients are disoriented or comatose, the first priority is to maintain patent airway and prevent aspiration of vomitus. Tracheal intubation and positive pressure respiration may be needed if it is markedly depressed. Analeptics should not be used—may precipitate convulsions. Most patients will recover with supportive treatment, maintenance of fluid and electrolyte balance and correction of hypoglycaemia by glucose infusion till alcohol is metabolized. Thiamine (100 mg in 500 ml glucose solution infused i.v.) should be added. Recovery can be hastened by haemodialysis. Insulin + fructose drip has been found to accelerate alcohol metabolism. However, its clinical impact is not remarkable.

C. Chronic alcoholism On chronic intake, tolerance develops to subjective and behavioral effects of alcohol, but is generally of a low degree. It is both pharmacokinetic (reduced rate of absorption due to gastritis and faster metabolism due to enzyme induction) and cellular tolerance. Psychic dependence often occurs even with moderate drinking; depends a lot on individual's likings and attitudes.

Recent studies have confirmed that a genetic basis contributes to progression from social drinking to

alcoholism in about 50% individuals. Alcoholism is often a familial trait. Some differences in sensitivity of various neuronal systems to alcohol among 'predisposed' and 'not predisposed' individuals have been demonstrated.

There is no single explanation for why people drink. Diverse feelings and behaviours are provoked by alcohol in different individuals and in the same individual on different occasions. Alcohol can make people happy as well as sad, courteous as well as mean, talkative as well as silent, friendly as well as hostile. All this cannot be explained on the basis of pharmacological actions of alcohol alone. Attitudes, beliefs, peer groups, social setting and learned experiences all have a bearing. Alcohol is said to produce good mood, sense of wellbeing, self confidence, sociability, etc. But these in fact are learned behaviours. In some societies, alcoholic beverages have become an acceptable form of extending courtesy and of entertainment. Drinking is often related to 'celebration' and 'high living'. There is 'wine snobbery' in high social groups.

To some, excess drinking provides the excitement of risk taking. People often boast of their capacity to drink. To the young, drinking may be a symbol of rebellion against the oppressive older generation and rejection of the values of the establishment. 'Binge drinking' is a specific behavioural pattern of bouts of excessive drinking. Alcohol is often an excuse for bad behaviour. Society's view that intoxicated person is unaware of his actions—makes intoxication an attractive state, because there is increased freedom of what one can say or do after drinking. Thus, there are a variety of motivations for drinking.

Physical dependence occurs only on heavy and round-the-clock drinking (if alcohol is present in the body continuously). Heavy drinking is often associated with nutritional deficiencies, because food is neglected and malabsorption may occur. In addition to impaired mental and physical performance, neurological afflictions are common—polyneuritis, pellagra, tremors, seizures, loss of brain mass, Wernicke's encephalopathy, Korsakoff's psychosis and megaloblastic anaemia. Alcoholic cirrhosis of liver, hypertension, cardiomyopathy, CHF, arrhythmias, stroke, acute pancreatitis, impotence, gynaecomastia, infertility and skeletal myopathy are other complications. Incidence of oropharyngeal, esophageal and hepatic malignancy and respiratory infections is high; immune function is depressed.

Withdrawal syndrome consists of anxiety, sweating, tremor, impairment of sleep, confusion,

hallucinations, delirium tremens, convulsions and collapse.

Treatment Psychological and medical supportive measures are needed during withdrawal. Many CNS depressants like barbiturates, phenothiazines, chloral hydrate have been used as substitution therapy in the past (to suppress withdrawal syndrome) but benzodiazepines (chlordiazepoxide, diazepam) are the preferred drugs now. These have a long duration of action and can be gradually withdrawn later.

Naltrexone: Several studies have demonstrated involvement of opioid system in the pleasurable reinforcing effects of alcohol probably by blunting dopamine mediated reward function. Trials among post-addicts have shown that the long acting opioid antagonist *naltrexone* helps prevent relapse of alcoholism. It reduced alcohol craving, number of drinking days and chances of resumed heavy drinking. Naltrexone is approved by US-FDA for use as adjuvant in comprehensive treatment programmes for alcohol dependent subjects and is being used in India at most deaddiction centres, after the individual has undergone withdrawal and is motivated.

Acamprostate It is a weak NMDA-receptor antagonist with modest GABA_A receptor agonistic activity that is being used in Europe for maintenance therapy of alcohol abstinence. In conjunction with social and motivational therapy, it has been found to reduce relapse of the drinking behaviour. The efficacy of acamprostate in this regard is rated comparable to naltrexone.

The 5-HT₃ antagonist *ondansetron* and the antiepileptic *topiramate* have also shown some promise in treating alcoholism.

CLINICAL USES

Medicinal uses of ethanol are primarily restricted to external application and as a vehicle for liquid preparations used internally.

1. As antiseptic (*see* Ch. 65).
2. Rubefacient and counterirritant for sprains, joint pains, etc.
3. Rubbed into the skin to prevent bedsores. It should not be applied on already formed

- sores. Astringent action of alcohol is utilized in antiperspirant and aftershave lotions.
4. Alcoholic sponges to reduce body temperature in fever. However, cold water/ice may be better.
 5. Intractable neuralgias (trigeminal and others), severe cancer pain—injection of alcohol round the nerve causes permanent loss of transmission.
 6. To ward off cold—may benefit by causing vasodilatation of blanched mucosae; but further exposure after taking alcohol may be deleterious because alcohol increases heat loss due to cutaneous vasodilatation.
 7. As appetite stimulant and carminative: 30–50 ml of 7–10% alcohol may be taken as beverages or tinctures before meal.
 8. Reflex stimulation in fainting/hysteria: 1 drop in nose.
 9. To treat methanol poisoning.

Aldehyde dehydrogenase inhibitors

Disulfiram It inhibits the enzyme aldehyde dehydrogenase probably after conversion into active metabolites. When alcohol is ingested after taking disulfiram, the concentration of acetaldehyde in tissues and blood rises and a number of highly distressing symptoms (aldehyde syndrome) are produced promptly. These are—flushing, burning sensation, throbbing headache, perspiration, uneasiness, tightness in chest, dizziness, vomiting, visual disturbances, mental confusion, postural fainting and circulatory collapse. Duration of the syndrome (1–4 hours) depends on the amount of alcohol consumed. Because of risk of severe reaction, disulfiram is infrequently used.

Disulfiram has been used as an aversion technique in chronic alcoholics who are motivated and sincerely desire to leave the habit. After abstaining from alcohol overnight, disulfiram is given 1 g on 1st day, 0.75 g on 2nd day, 0.5 g on 3rd and 0.25 g subsequently. Sensitization to alcohol develops after 2–3 hours of first dose, reaches its peak at ~12 hours and lasts for 7–14

days after stopping it, because inhibition of aldehyde dehydrogenase with disulfiram is irreversible: synthesis of fresh enzyme is required for return of activity. Thus, the subject's resolve not to drink is reinforced by the distressing symptoms that occur if he drinks a little bit. It should not be used in patients who are physically dependent on alcohol.

Side effects of disulfiram (as such) are infrequent, include rashes, metallic taste, nervousness, malaise and abdominal upset. It inhibits a number of other enzymes as well including alcohol dehydrogenase, dopamine β hydroxylase and several cytochrome P450 isoenzymes. Thus, it prolongs $t\frac{1}{2}$ of many drugs.

ESPERAL, ANTADICT 250 mg tab. (internationally marketed as ANTABUSE)

METHYL ALCOHOL (Methanol, Wood alcohol)

Methyl alcohol is added to rectified spirit to render it unfit for drinking. It is only of toxicological importance. Unscrupulous mixing of methylated spirit with alcoholic beverages or its inadvertent ingestion results in methanol poisoning.

Methanol is metabolized to formaldehyde and formic acid by alcohol and aldehyde dehydrogenases respectively, but the rate is $\frac{1}{7}$ th that of ethanol. Like ethanol, it follows *zero order* kinetics and $t\frac{1}{2}$ of 20–60 hours has been measured.

Methanol also is a CNS depressant, but less potent than ethanol. Toxic effects of methanol are largely due to formic acid, since its further metabolism is slow and folate dependent. A blood level of >50 mg/dl methanol is associated with severe poisoning. Even 15 ml of methanol has caused blindness and 30 ml has caused death; fatal dose is regarded to be 75–100 ml.

Manifestations of methanol poisoning are vomiting, headache, epigastric pain, uneasiness, dyspnoea, bradycardia and hypotension. Delirium may occur and the patient may suddenly pass into coma. *Acidosis* is prominent and

entirely due to production of formic acid. The specific toxicity of formic acid is *retinal damage*. Blurring of vision, congestion of optic disc followed by blindness always precede death which is due to respiratory failure.

Treatment

1. Keep the patient in a quiet, dark room; protect the eyes from light.
2. Gastric lavage with sod. bicarbonate if the patient is brought within 2 hours of ingesting methanol. Supportive measures to maintain ventilation and BP should be instituted.
3. Combat acidosis by i.v. *Sod. bicarbonate* infusion—the most important measure; prevents retinal damage and other symptoms; large quantities may be needed.
4. Pot. chloride infusion is needed only when hypokalemia occurs due to alkali therapy.
5. *Ethanol* 100 mg/dl in blood saturates alcohol dehydrogenase and retards methanol metabolism. This helps by reducing the rate of generation of toxic metabolites. Ethanol (10% in water) is administered through a nasogastric tube; loading dose of 0.7 ml/kg is followed by 0.15 ml/kg/hour drip. Because pharmacokinetics of alcohol is unstable and no i.v. formulation is available, maintenance of effective concentration is difficult and needs to be repeatedly measured. Moreover,

the enzyme saturating concentration of ethanol itself produces intoxication and can cause hypoglycaemia. Treatment has to be continued for several days because the sojourn of methanol in body is long.

6. Haemodialysis: clears methanol as well as formate and hastens recovery.
7. *Fomepizole* (4-methylpyrazole) is a specific inhibitor of alcohol dehydrogenase—retards methanol metabolism. A loading dose of 15 mg/kg i.v. followed by 10 mg/kg every 12 hours till serum methanol falls below 20 mg/dl, has been found effective and safe. It has several advantages over ethanol, like longer $t_{1/2}$ and lack of inebriating action, but is not available commercially in India.
8. Folate therapy: Calcium leucovorin 50 mg injected 6 hourly has been shown to reduce blood formate levels by enhancing its oxidation. This is a promising adjuvant approach.

Ethylene glycol poisoning Ethylene glycol poisoning has occurred sporadically, especially among children. It is an industrial solvent, coolant and antifreeze. It is oxidized in the body by alcohol dehydrogenase to glycoaldehyde and then to glycolic acid—glyoxylic acid—oxylic acid in steps. Ethylene glycol itself can cause intoxication similar to ethanol, but generation of metabolites results in acidosis, cardiopulmonary complications and renal tubular necrosis.

Fomepizole used in the same manner as for methanol poisoning is the drug of choice. It is approved by US-FDA for this indication and has 'orphan drug status'. Ethanol is employed as an alternative.

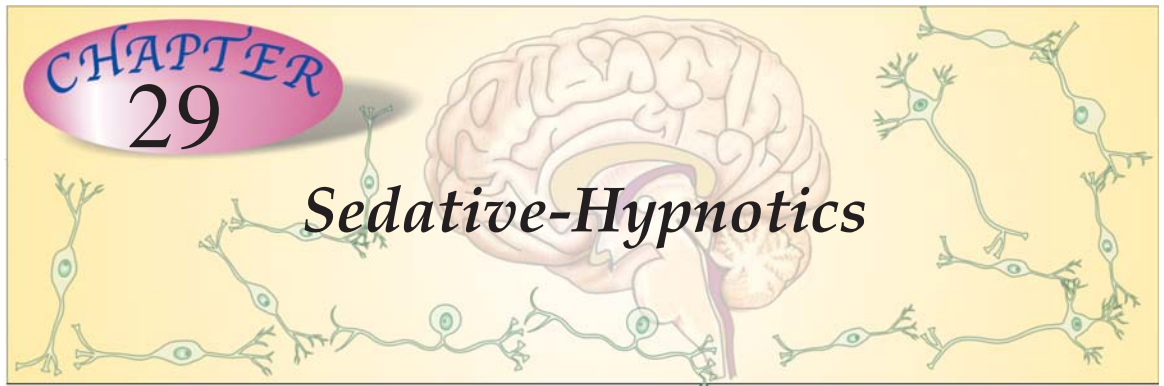

Sedative A drug that subdues excitement and calms the subject without inducing sleep, though drowsiness may be produced. Sedation refers to decreased responsiveness to any level of stimulation; is associated with some decrease in motor activity and ideation.

Hypnotic A drug that induces and/or maintains sleep, similar to normal arousable sleep. This is not to be confused with 'hypnosis' meaning a trans-like state in which the subject becomes passive and highly suggestible.

The sedatives and hypnotics are more or less general CNS depressants with somewhat differing time-action and dose-action relationships. Those with quicker onset, shorter duration and steeper dose-response curves are preferred as *hypnotics* while more slowly acting drugs with flatter dose-response curves are employed as *sedatives*. However, there is considerable overlap; a hypnotic at lower dose may act as sedative. Thus, sedation—hypnosis—general anaesthesia may be regarded as increasing grades of CNS depression. Hypnotics given in high doses can produce general anaesthesia. However, benzodiazepines (BZDs) cannot be considered nonselective or general CNS depressants like barbiturates and others.

Treatment of insomnia is the most important use of this class of drugs.

Alcohol and opium have been the oldest hypnotics and continue to be used for this purpose as self-medication by people. Bromides introduced in 1857 are now obsolete, so are chloral hydrate (1869) and paraldehyde (1882). Fischer and von Mering introduced barbitone in 1903 and phenobarbitone in 1912. Barbiturates reigned supreme till 1960s when benzodiazepines started eroding their position and have now totally replaced them. In the mean time, a number of other sedative-hypnotics were introduced but none was significantly different from barbiturates; all are redundant now. Some new non-BZD hypnotics have become available over the past decade.

Sleep

The duration and pattern of sleep varies considerably among individuals. Age has an important effect on quantity and depth of sleep. It has been recognized that sleep is an architected cyclic process (Fig. 29.1). The different phases of sleep and their characteristics are—

Stage 0 (awake) From lying down to falling asleep and occasional nocturnal awakenings; constitutes 1–2% of sleep time. EEG shows α activity when eyes are closed and β activity when eyes are open. Eye movements are irregular or slowly rolling.

Stage 1 (dozing) α activity is interspersed with θ waves. Eye movements are reduced but there may be bursts of rolling. Neck muscles relax. Occupies 3–6% of sleep time.

Stage 2 (unequivocal sleep) θ waves with interspersed spindles, K complexes can be evoked on sensory stimulation; little eye movement; subjects are easily arousable. This comprises 40–50% of sleep time.

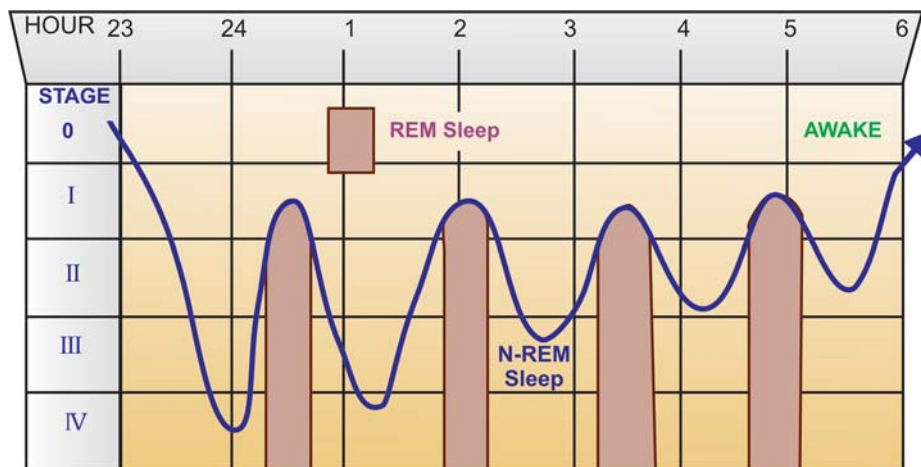

Fig. 29.1: A normal sleep cycle

Stage 3 (deep sleep transition) EEG shows θ , δ and spindle activity, K complexes can be evoked with strong stimuli only. Eye movements are few; subjects are not easily arousable; comprises 5–8% of sleep time.

Stage 4 (cerebral sleep) δ activity predominates in EEG, K complexes cannot be evoked. Eyes are practically fixed; subjects are difficult to arouse. Night terror may occur at this time. It comprises 10–20% of sleep time.

During stage 2, 3 and 4 heart rate, BP and respiration are steady and muscles are relaxed. Stages 3 and 4 together are called slow wave sleep (SWS).

REM sleep (paradoxical sleep) EEG has waves of all frequency, K complexes cannot be elicited. There are marked, irregular and darting eye movements; dreams and nightmares occur, which may be recalled if the subject is aroused. Heart rate and BP fluctuate; respiration is irregular. Muscles are fully relaxed, but irregular body movements occur occasionally. Erection occurs in males. About 20–30% of sleep time is spent in REM.

Normally stages 0 to 4 and REM occur in succession over a period of 80–100 min. Then stages 1–4–REM are repeated cyclically.

The EEG waves have been divided into—

- α : high amplitude, 8–14 c.p.s. (cycles per second)
- β : low amplitude, 15–35 c.p.s.
- θ : low amplitude, 4–7 c.p.s.
- δ : high amplitude, 0.5–3 c.p.s.

K complex: deep negative wave followed by positive wave and a few spindles.

CLASSIFICATION

1. Barbiturates

Long acting	Short acting	Ultra-short acting
Phenobarbitone	Butobarbitone	Thiopentone
	Pentobarbitone	Methohexitone

2. Benzodiazepines

Hypnotic	Antianxiety	Anticonvulsant
Diazepam	Diazepam	Diazepam
Flurazepam	Chlordiazepoxide	Lorazepam
Nitrazepam	Oxazepam	Clonazepam
Alprazolam	Lorazepam	Clobazam
Temazepam	Alprazolam	
Triazolam		

3. Newer nonbenzodiazepine hypnotics

Zopiclone,	Zolpidem	Zaleplon
------------	----------	----------

Chloral hydrate, Triclophos, Paraldehyde, Glutethimide, Methylprilone, Methaqualone and Meprobamate are historical sedative-hypnotics no longer used. They are described in earlier editions of this book.

In addition some antihistaminics (promethazine, diphenhydramine), some neuroleptic/antidepressants (chlorpromazine, amitriptyline), some anticholinergic (hyoscine) and opioids (morphine, pethidine) have significant sedative action, but are not reliable for treatment of insomnia.

BARBITURATES

Barbiturates have been popular hypnotics and sedatives of the last century upto 1960s, but are not used now to promote sleep or to calm patients. However, they are described first because they are the prototype of CNS depressants.

Barbiturates are substituted derivatives of barbituric acid (malonyl urea). Barbituric acid as such is not a hypnotic but compounds with alkyl or aryl substitution on C5 are. Replacement of O with S at C2 yields *thiobarbiturates* which are more lipid-soluble and more potent. Barbiturates have variable lipid solubility, the more soluble ones are more potent and shorter acting. They are insoluble in water but their sodium salts dissolve yielding highly alkaline solution.

PHARMACOLOGICAL ACTIONS

Barbiturates are general depressants for all excitable cells, the CNS is most sensitive where the effect is almost global, but certain areas are more susceptible.

1. CNS Barbiturates produce dose-dependent effects:

sedation → sleep → anaesthesia → coma.

Hypnotic dose (100–200 mg of a short acting barbiturate) shortens the time taken to fall asleep and increases sleep duration. The sleep is arousable, but the subject may feel confused and unsteady if waken early. Night awakenings are reduced. REM and stage 3, 4 sleep are decreased; REM-NREM sleep cycle is disrupted. The effects on sleep become progressively less marked if the drug is taken every night consecutively. A rebound increase in REM sleep and nightmares is often noted when the drug is discontinued after a few days of use and it takes several days for normal pattern to be restored (Fig. 29.2). Hang-over (dizziness, distortions of mood, irritability and lethargy) may occur in the morning after a nightly dose.

Sedative dose (smaller dose of a longer acting barbiturate) given at daytime can produce drowsiness, reduction in anxiety and excitability. However, barbiturates do not have selective anti-

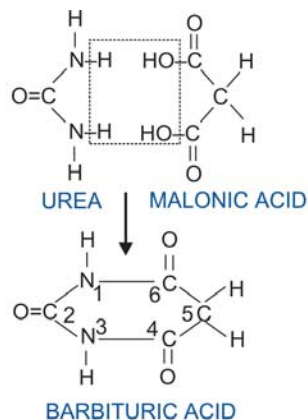

Condensation of malonic acid and urea to produce barbituric acid

anxiety action. Barbiturates can impair learning, short-term memory and judgement. They have no analgesic action; small doses may even cause hyperalgesia. Euphoria may be experienced by addicts.

Barbiturates have anticonvulsant property. The 5-phenyl substituted agents (phenobarbitone) have higher anticonvulsant : sedative ratio, i.e. they have specific anticonvulsant action independent of general CNS depression.

Higher dose of a barbiturate induces a predominance of slow, high voltage EEG activity. Progressive burst suppression occurs if dose is

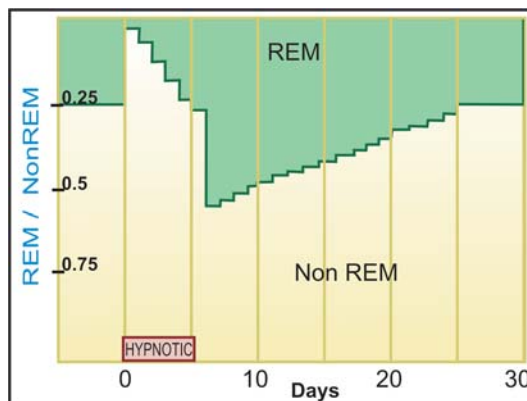

Fig. 29.2: Effect of hypnotic use for 6 consecutive nights on the ratio of REM / Non-REM sleep duration

increased further. Barbiturates depress all areas of the CNS, but the reticular activating system is most sensitive; its depression is primarily responsible for inability to maintain wakefulness.

Mechanism of action Barbiturates appear to act primarily at the GABA : BZD receptor-Cl⁻ channel complex (*see* Fig. 29.3) and potentiate GABAergic inhibition by increasing the lifetime of Cl⁻ channel opening induced by GABA. (contrast BZDs which enhance frequency of Cl⁻ channel opening). They do not bind to the BZD receptor, but bind to another site (probably the picrotoxin sensitive site) on the same macromolecular complex to exert the GABA-facilitatory action. The barbiturate site appears to be located on α or β subunit, because presence of only these subunits is sufficient for their response. They also enhance BZD binding to its receptor. At high concentrations, barbiturates directly increase Cl⁻ conductance (GABA-mimetic action; contrast BZDs which have only GABA-facilitatory action) and inhibit Ca²⁺ dependent release of neurotransmitters. In addition they depress glutamate induced neuronal depolarization through AMPA receptors. At very high concentrations, barbiturates depress voltage sensitive Na⁺ and K⁺ channels as well. A dose-dependent effect on multiple neuronal targets appears to confer the ability to produce any grade of CNS depression.

2. Other systems

Respiration is depressed by relatively higher doses. Neurogenic, hypercapneic and hypoxic drives to respiratory centre are depressed in succession. Barbiturates do not have selective antitussive action.

CVS Hypnotic doses of barbiturates produce a slight decrease in BP and heart rate: magnitude of change not differing from that during normal sleep. Toxic doses produce marked fall in BP due to ganglionic blockade, vasomotor centre depression and direct decrease in cardiac contractility. Reflex tachycardia can occur, though pressor reflexes are depressed. However, the dose

producing cardiac arrest is about 3 times larger than that causing respiratory failure.

Skeletal muscle Hypnotic doses have little effect but anaesthetic doses reduce muscle contraction by depressing excitability of neuromuscular junction.

Smooth muscles Tone and motility of bowel is decreased slightly by hypnotic doses; more profoundly during intoxication. Action on bronchial, ureteric, vesical and uterine muscles is not significant.

Kidney Barbiturates tend to reduce urine flow by decreasing BP and increasing ADH release. Oliguria attends barbiturate intoxication.

PHARMACOKINETICS

Barbiturates are well absorbed from the g.i. tract. They are widely distributed in the body. The rate of entry into CNS is dependent on lipid solubility. Highly-lipid soluble thiopentone has practically instantaneous entry, while less lipid-soluble ones (pentobarbitone) take longer; phenobarbitone enters very slowly. Plasma protein binding varies with the compound, e.g. thiopentone 75%, pentobarbitone 35%, phenobarbitone 20%. Barbiturates cross placenta and are secreted in milk; can produce effects on the foetus and suckling infant.

Three processes are involved in termination of action of barbiturates: the relative importance of each varies with the compound.

(a) **Redistribution** It is important in the case of highly lipid-soluble thiopentone and others. After their i.v. injection, consciousness is regained in 6–10 min due to redistribution (*see* Ch. 2) while the ultimate disposal occurs by metabolism ($t_{1/2}$ of elimination phase is 9 hours). Effect of single dose of short acting barbiturate may last just 6–10 hours due to redistribution, while elimination $t_{1/2}$ is 12–40 hours.

(b) **Metabolism** Drugs with intermediate lipid-solubility (short-acting barbiturates) are primarily metabolized in liver by oxidation, dealkylation and conjugation. Their plasma $t_{1/2}$ ranges from 12–40 hours.

(c) **Excretion** Barbiturates with low lipid-solubility (long-acting agents) are significantly excreted unchanged in urine. The $t_{1/2}$ of phenobarbitone is 80–120 hours. Alkalinization of urine increases ionization and excretion. This is most significant in the case of long-acting agents.

Barbiturates induce hepatic microsomal enzymes and increase the rate of their own metabolism as well as that of many other drugs.

USES

Except for phenobarbitone in epilepsy (Ch. 30) and thiopentone in anaesthesia (Ch. 27), barbiturates are seldom used now. As hypnotic and anxiolytic they have been superseded by BZDs. They are occasionally employed as adjuvants in psychosomatic disorders. The enzyme inducing property of phenobarbitone can be utilized to hasten clearance of congenital nonhaemolytic jaundice and kernicterus.

Phenobarbitone 30–60 mg oral OD–TDS; 100–200 mg i.m./i.v.

GARDENAL 30, 60 mg tab, 20 mg/5 ml syr; LUMINAL 30 mg tab; PHENOBARBITONE SOD 200 mg /ml inj

ADVERSE EFFECTS

Side effects Hangover was common after the use of barbiturates as hypnotic. On repeated use they accumulate in the body—produce tolerance and dependence. Mental confusion, impaired performance and traffic accidents may occur (also see Ch. 30).

Idiosyncrasy In an occasional patient barbiturates produce excitement. This is more common in the elderly. Precipitation of porphyria in susceptible individuals.

Hypersensitivity Rashes, swelling of eyelids, lips, etc.—more common in atopic individuals.

Tolerance and dependence Both cellular and pharmacokinetic (due to enzyme induction) tolerance develops on repeated use. However, fatal dose is not markedly increased: addicts may present with acute barbiturate intoxication. There is partial cross tolerance with other CNS depressants.

Psychological as well as physical dependence occurs and barbiturates have considerable abuse liability—one of their major disadvantages. Withdrawal symptoms are—excitement, hallucinations, delirium, convulsions; deaths have occurred.

Acute barbiturate poisoning Mostly suicidal, sometimes accidental; infrequently encountered now due to inavailability of barbiturates. However, the principles of treatment apply to any CNS depressant poisoning.

Manifestations are due to excessive CNS depression—patient is flabby and comatose with shallow and failing respiration, fall in BP and cardiovascular collapse, renal shut down, pulmonary complications, bullous eruptions.

Lethal dose depends on lipid solubility. It is 2–3 g for the more lipid-soluble agents (short-acting barbiturates) and 5–10 g for less lipid-soluble phenobarbitone.

Treatment

1. Gastric lavage; leave a suspension of activated charcoal in the stomach to prevent absorption of the drug from intestines.
2. Supportive measures: such as, patent airway, assisted respiration, oxygen, maintenance of blood volume by fluid infusion and use of vasopressors—dopamine may be preferred for its renal vasodilating action.
3. Alkaline diuresis: with sodium bicarbonate 1 meq/kg i.v. with or without mannitol is helpful only in the case of long-acting barbiturates which are eliminated primarily by renal excretion.
4. Haemodialysis and haemoperfusion (through a column of activated charcoal or other adsorbants) is highly effective in removing long-acting as well as short-acting barbiturates.

There is no specific antidote for barbiturates. In the past, analeptics like metrazol, bemegride, etc. have been used in an attempt to awaken the patient. This is dangerous, may precipitate convulsions while the patient is still comatose—mortality is increased. The emphasis now is on keeping the patient alive till the poison has been eliminated.

Contraindications

1. Acute intermittent porphyria—barbiturates exacerbate it by inducing microsomal enzymes (δ aminolevulinic acid synthetase) and increasing porphyrin synthesis.
2. Liver and kidney disease.
3. Severe pulmonary insufficiency, e.g. emphysema.
4. Obstructive sleep apnoea.

Interactions

1. Barbiturates induce the metabolism of many drugs and reduce their effectiveness—warfarin, steroids (including contraceptives), tolbutamide, griseofulvin, chloramphenicol, theophylline.
2. Additive action with other CNS depressants—alcohol, antihistamines, opioids, etc.
3. Sodium valproate increases plasma concentration of phenobarbitone.
4. Phenobarbitone competitively inhibits as well as induces phenytoin and imipramine metabolism: complex interaction.
5. Phenobarbitone decreases absorption of griseofulvin from the g.i.t.

BENZODIAZEPINES (BZDs)

Chlordiazepoxide and diazepam were introduced around 1960 as antianxiety drugs. Since then this class has proliferated and has gained popularity over barbiturates as hypnotic and sedative as well, because—

1. BZDs have a high therapeutic index. Ingestion of even 20 hypnotic doses does not usually endanger life—there is no loss of consciousness (though amnesia occurs) and patient can be aroused; respiration is not so depressed as to need assistance.

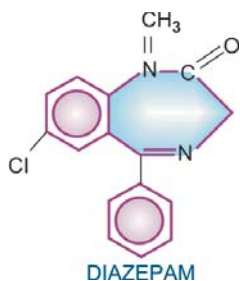

2. Hypnotic doses do not affect respiration or cardiovascular functions. Higher doses produce mild respiratory depression and hypotension which is problematic only in patients with respiratory insufficiency and cardiac/haemodynamic abnormality.

3. BZDs have practically no action on other body systems. Only on i.v. injection the BP falls (may be marked in an occasional patient) and cardiac contractility decreases. Fall in BP in case of diazepam and lorazepam is due to reduction in cardiac output while that due to midazolam is due to decrease in peripheral resistance. The coronary arteries dilate on i.v. injection of diazepam.

4. BZDs cause less distortion of sleep architecture; rebound phenomena on discontinuation of regular use are less marked.

5. BZDs do not alter disposition of other drugs by microsomal enzyme induction.

6. They have lower abuse liability: tolerance is mild, psychological and physical dependence and withdrawal syndrome are less marked.

7. A specific BZD antagonist *flumazenil* is available which can be used in case of poisoning.

CNS actions The overall action of all BZDs is qualitatively similar, but there are prominent differences in selectivity and time-course of action: different members are used for different purposes. In contrast to barbiturates, they are not general depressants, but exert relatively selective anxiolytic, hypnotic, muscle relaxant and anticonvulsant effects in different measures. Even when apparently anaesthetic dose of diazepam is administered i.v., some degree of awareness is maintained, though because of anterograde amnesia (interference with establishment of memory trace) the patient does not clearly recollect the events on recovery. The antianxiety action of BZDs is probably not dependent on their sedative property; with chronic administration relief of anxiety is maintained, but drowsiness wanes off due to development of tolerance.

While there are significant differences among different BZDs, in general, they hasten onset of sleep, reduce intermittent awakening and increase total sleep time (specially in those who have a short sleep span). Time spent in stage 2 is increased while that in stage 3 and 4 is decreased. They tend to shorten REM phase, but more REM cycles may occur so that overall effect on REM sleep is less marked than with barbiturates. Nitrazepam has been shown to actually increase REM sleep. Night terrors and body movements during sleep are reduced and stage shifts to stage 1 and 0 are lessened. Most subjects wake up with a feeling of refreshing sleep. Some degree of tolerance develops to the action of BZDs on sleep after repeated nightly use.

BZDs produce *centrally mediated skeletal muscle relaxation* without impairing voluntary activity. Clonazepam and diazepam have more marked muscle relaxant property. Very high doses depress neuromuscular transmission.

Clonazepam, diazepam, nitrazepam and flurazepam have more prominent *anticonvulsant* activity than other BZDs. However, their utility in epilepsy is limited by development of tolerance to the anticonvulsant action.

Given i.v., diazepam (but not others) causes analgesia. In contrast to barbiturates, BZDs do not produce hyperalgesia.

Other actions Diazepam decreases nocturnal gastric secretion and prevents stress ulcers. BZDs do not significantly affect bowel movement.

Short-lasting coronary dilatation is produced by i.v. diazepam.

Site and mechanism of action

Benzodiazepines act preferentially on midbrain ascending reticular formation (which maintains wakefulness) and on limbic system (thought and mental functions). Muscle relaxation is produced by a primary medullary site of action and ataxia is due to action on cerebellum.

BZDs act by enhancing presynaptic/post-synaptic inhibition through a specific BZD receptor which is an integral part of the GABA_A receptor-Cl⁻ channel complex. The subunits of this complex form a pentameric transmembrane anion channel (Fig. 29.3) gated by the primary ligand (GABA), and modulated by secondary ligands which include BZDs. Only the α and β subunits are required for GABA action, and most likely the binding site for GABA is located on the β subunit, while the α/γ subunit interface carries the BZD binding site. The modulatory BZD receptor increases the frequency of Cl⁻ channel opening induced by submaximal concentrations of GABA. The BZDs also enhance binding of GABA to GABA_A receptor. The GABA_A antagonist bicuculline antagonizes BZD action in a noncompetitive manner. It is noteworthy that the BZDs do not themselves increase Cl⁻ conductance; have only GABA facilitatory but no GABA mimetic action. This probably explains the lower ceiling CNS depressant effect of BZDs.

The BZD receptor exhibits a considerable degree of constitutive activation. As such, it is capable of fine tuning GABA action in either direction. While the BZD-agonists enhance GABA induced hyperpolarization (due to influx of Cl⁻ ions), and decrease firing rate of neurones,

other compounds called *BZD-inverse agonists* like dimethoxyethyl-carbomethoxy- β -carboline (DMCM) inhibit GABA action and are convulsants. The competitive BZD-antagonist flumazenil blocks the sedative action of BZDs as well as the convulsant action of DMCM.

The GABA_A-BZD receptor-Cl⁻ channel complex is composed of five α , β , γ , and in some cases δ , ϵ , θ or π subunits. Several isoforms of α , β and γ subunits have been cloned. The subunit composition of the complex differs at different sites, i.e. there are multiple subtypes of BZD receptor. The (α_1 2 β_2 2 γ_2) pentamer appears to be the most commonly occurring BZD receptor isoform. Based on studies conducted in genetically mutated mice, it has been suggested that BZD receptor isoforms containing the α_1 subunit are involved in mediating sedative, hypnotic, amnesic and possibly anticonvulsant actions of BZDs, while those containing α_2 subunits mediate anxiolytic and muscle relaxant actions. Diazepam has similar affinity for BZD receptor containing different (α_1 , α_2 , α_3 or α_5) subunits, and has broad spectrum action. Receptor inhomogeneity may provide an explanation for the pharmacological diversity of other BZDs. The newer non BZD hypnotics zaleplon, Zolpidem, etc. have high affinity for α_1 subunit isoform of BZD receptor and exert selective hypnotic-amnesic effect, but have little antiseizure or muscle relaxant property.

At high concentrations BZDs also potentiate the depressant action of adenosine by blocking its uptake. Certain actions of BZDs are countered by the adenosine antagonist theophylline. Thus, BZDs could be acting through other mechanisms as well.

PHARMACOKINETICS

There are marked pharmacokinetic differences among BZDs because they differ in lipid-solubility by > 50 fold. Oral absorption of some is rapid while that of others is slow. Absorption from i.m. sites is irregular except for lorazepam. Plasma protein binding also varies markedly (flurazepam 10% to diazepam 99%). BZDs are widely distributed in the body. The more lipid soluble members enter brain rapidly and have a two phase plasma concentration decay curve; first due to distribution and later due to elimination. A relatively short duration of action is obtained with single dose of a drug that is rapidly redistributed, even though it may have a long elimination $t_{1/2}$. Using the elimination $t_{1/2}$

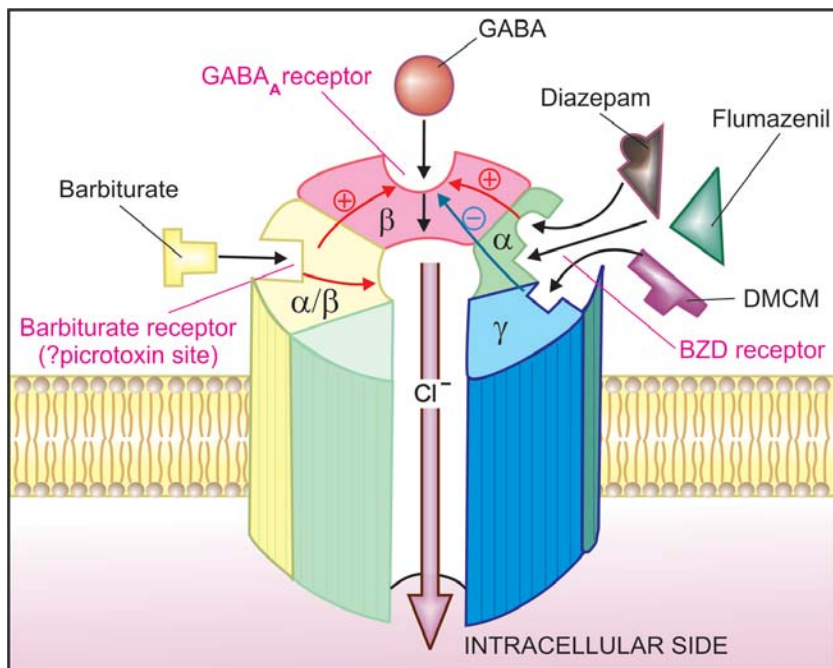

Fig. 29.3: Schematic depiction of GABA_A-benzodiazepine receptor-chloride channel complex

The chloride channel is gated by the primary ligand GABA acting on GABA_A receptor located on the β subunit. The benzodiazepine (BZD) receptor located on the interface of α and γ subunits modulates GABA_A receptor in either direction: agonists like diazepam facilitate, while inverse agonists like DMCM hinder GABA mediated Cl⁻ channel opening, and BZD antagonist flumazenil blocks the action of both. The barbiturate receptor, located either on α or β subunit also facilitates GABA and is capable of opening Cl⁻ channel directly as well. Bicuculline blocks GABA_A receptor, while picrotoxin blocks the Cl⁻ channel directly

Drugs affecting GABA_A-receptor gated chloride channel

- GABA : Endogenous agonist at GABA_A receptor → promotes Cl⁻ influx
- Muscimol : Agonist at GABA_A site
- Bicuculline : Competitive antagonist at GABA_A receptor
- Picrotoxin : Blocks Cl⁻ channel noncompetitively; acts on picrotoxin sensitive site
- Barbiturate : Agonist at an allosteric site (? picrotoxin site); prolong GABA action; open Cl⁻ channel
- Alcohol, Inhalational anaesthetics, Propofol : Open Cl⁻ channel directly; allosteric facilitation of GABA
- Benzodiazepine : Agonist at an allosteric BZD site → facilitate GABA action
- β -Carboline (DMCM) : Inverse agonist at BZD site → impede GABA action
- Flumazenil : Competitive antagonist at BZD site

Table 29.1: Some pharmacokinetic and clinical features of benzodiazepines used as hypnotics

Drug	$t_{1/2}$ (hr)*	Redistribution [§]	Hypnotic dose (mg)	Clinical indications
I. LONG ACTING				
Flurazepam	50–100	–	15–30	Chronic insomnia, short-term insomnia
Diazepam	30–60	+	5–10	with anxiety; Frequent nocturnal awakening;
Nitrazepam	30	±	5–10	Night before operation
II. SHORT ACTING				
Alprazolam	12	+	0.25–0.5	Individuals who react unfavourably to
Temazepam	8–12	+	10–20	unfamiliar surroundings or unusual timings
Triazolam	2–3	±	0.125–0.25	of sleep. Sleep onset difficulties.

* $t_{1/2}$ of elimination phase, including that of active metabolite

§ + indicates that redistribution contributes to termination of action of single dose

alone to predict duration of action may be misleading. However, elimination $t_{1/2}$ determines duration of action in case of drugs whose elimination is by far the dominant feature or when the drug is given repeatedly.

Benzodiazepines are metabolized in liver by dealkylation and hydroxylation to many metabolites, some of which may be active. The biological effect half-life of these drugs may be much longer than the plasma $t_{1/2}$ of the administered compound. Some BZDs (e.g. diazepam) undergo enterohepatic circulation. BZDs and their phase I metabolites are excreted in urine as glucuronide conjugates. BZDs cross placenta and are secreted in milk.

Drugs with a long $t_{1/2}$ or those which generate active metabolites cumulate on nightly use; their action may then extend into the next day. Some features of BZDs used as hypnotic are given in Table 29.1.

BZDs may be categorized according to their pharmacokinetic profile into:

I. *Slow elimination of parent drug or active metabolite*

Flurazepam Produces an active metabolite which has a long $t_{1/2}$, residual effects are likely next morning; cumulation occurs on daily ingestion peaking after 3–5 days; suitable for patients who have frequent nocturnal awaken-

ings and in whom some day time sedation is acceptable.

NINDRAL, FLURAZ 15 mg cap.

II. *Relatively slow elimination but marked redistribution*

Diazepam Generates active metabolites (desmethyl-diazepam, oxazepam). On occasional use it is free of residual effects. With regular use accumulation occurs and prolonged anxiolytic effect may be obtained. It is less likely to cause rebound insomnia on discontinuation of chronic use. Withdrawal phenomena are mild.

VALIUM 2, 5, 10 mg tab., 10 mg/2 ml inj., CALMPOSE 5, 10 mg tab, 2 mg/5 ml syr, 10 mg/2 ml inj.

Nitrazepam Accumulation and residual effects can be avoided only if ingestion is occasional. Good for patients with frequent nocturnal awakenings, when some day time sedation is acceptable.

SEDAMON, HYPNOTEX, NITRAVET 5 mg tab., 5, 10 mg cap.

III. *Relatively rapid elimination and marked redistribution*

Alprazolam The primary indication of this intermediate acting BZD is anxiety disorder (see Ch. 33), but is also being employed as night-time hypnotic with few residual effects the next day. Discontinuation after regular use has produced relatively marked withdrawal phenomena.

Temazepam It is an intermediate acting BZD. Absorption is slow in case of tablet but fast when used in soft gelatin capsule. Good for sleep onset difficulty, free of residual effects. Accumulation can occur on daily ingestion. Does not produce active metabolites.

IV. Ultrarapid elimination

Triazolam Very potent, peak effect occurs in < 1 hour; good for sleep induction but poor for maintaining it. Patient may wake up early in the morning and feel anxious. This may be a withdrawal phenomenon. Rebound insomnia may occur when it is discontinued after a few nights of use. It does not accumulate on repeated nightly use and no residual effects are noted in the morning. However, higher doses can alter sleep architecture, produce anterograde amnesia and anxiety the following day. Some cases of paranoia and other psychiatric disturbances have been noted—withdrawn from U.K., but is employed in other countries for elderly patients, shift workers, travellers, etc.

Midazolam Extremely rapid absorption—peak in 20 min. It can cause problems in the elderly (ataxia, blackouts); more liable for abuse. Therefore, it is not available now for oral use as a hypnotic. Mainly used as an i.m. premedicant or an i.v. anaesthetic (*see* p. 376).

ADVERSE EFFECTS

Benzodiazepines are relatively safe drugs. Side effects of hypnotic doses are dizziness, vertigo, ataxia, disorientation, amnesia, prolongation of reaction time—impairment of psychomotor skills (should not drive). Hangover is less common, but may be noted if larger doses are used, especially of longer acting drugs. Weakness, blurring of vision, dry mouth and urinary incontinence are sometimes complained. Older individuals are more susceptible to psychomotor side effects. Like any hypnotic, BZDs can aggravate sleep apnoea.

Paradoxical stimulation, irritability and sweating may occur in an occasional patient, especially with flurazepam. Some patients experience increase in nightmares and behavioural alterations, especially with nitrazepam.

Tolerance to the sedative effects develops gradually, but there is little tendency to increase the dose. Cross tolerance to alcohol and other CNS depressants occurs.

The dependence producing liability of BZDs is low. They are seldom abused alone. Drug abusers find them rather bland (except rapidly absorbed midazolam) and prefer other CNS depressants. Withdrawal syndrome is generally mild; may be more intense in case of ultrarapid elimination drugs. Drug-seeking behaviour is not prominent. Anxiety, insomnia, restlessness, malaise, loss of appetite, bad dreams is all that occurs in most cases. Agitation, panic reaction, tremors and delirium are occasional; convulsions are rare.

An earlier report of increased birth defects on use of diazepam during pregnancy has been disputed. Administration during labour may cause flaccidity and respiratory depression in the neonate.

INTERACTIONS

BZDs synergise with alcohol and other CNS depressants leading to excessive impairment. Concurrent use with sod. valproate has provoked psychotic symptoms.

Drug interactions due to displacement from protein binding or microsomal enzyme induction are not significant.

Since CYP 3A4 isoenzyme plays important role in metabolism of several BZDs, their action can be prolonged by CYP 3A4 inhibitors like ketoconazole, erythromycin and others. Cimetidine, isoniazid and oral contraceptives also retard BZD metabolism.

NON-BENZODIAZEPINE HYPNOTICS

Zopiclone This newer cyclopyrrolone hypnotic is an agonist at a subtype of BZD receptor involved in the hypnotic action. The effect on sleep resemble those of BZDs, but it does not alter REM sleep and tends to prolong stages 3 and 4. It is reported not to disturb sleep architecture or produce hangover or withdrawal phenomena on discontinuation; but some degree of next morning impairment can occur. Zopiclone has been used to weanoff insomniacs taking regular BZD medication. Its $t_{1/2}$ is 5–6 hours.

Zopiclone is indicated for short term (< 2 weeks) treatment of insomnia. Side effects are metallic or bitter after-taste, impaired judgement and alertness, psychological disturbances, dry mouth and rarely dependence. Safety in overdose is similar to BZDs.

ZOPITRAN, ZOPICON, ZOLIUM, 7.5 mg tab, one tab at bedtime for not more than 2–4 weeks (elderly 3.75 mg).

Zolpidem An imidazopyridine which preferentially acts on the α_1 subunit containing subtype of BZD receptors that are important in mediating the hypnotic effect. Hypnotic effect is pronounced: sleep latency is shortened, sleep duration is prolonged in insomniacs, but anticonvulsant, muscle relaxant and antianxiety effects are not evident. Its advantages are: relative lack of effect on sleep stages (REM suppression is slight); minimal residual day time sedation or fading of hypnotic action on repeated nightly use; no/little rebound insomnia on discontinuation; near absence of tolerance or physical dependence and low abuse potential combined with safety in overdose like BZDs.

Zolpidem is nearly completely metabolized in liver ($t_{1/2}$ 2 hr), and has short duration of action. It is indicated for short-term (1–2 weeks) sleep onset insomnia. Because the plasma $t_{1/2}$ is short, next day sedation is minimal, but morning sedation or prolongation of reaction-time can occur if it is taken late at night. Side effects are few. Even large doses do not markedly depress respiration. Currently, it is one of the most commonly prescribed hypnotics.

Dose: 5–10 mg (max 20 mg) at bedtime; $\frac{1}{2}$ dose in elderly and liver disease patients.

NITREST, ZOLDEM, DEM 5, 10 mg tabs.

Zaleplon This is the shortest acting of the newer non-BZD hypnotics that selectively act on a subset of BZD receptors containing the α_1 subunit which appear to mediate the hypnotic action. It is rapidly absorbed; oral bioavailability is ~30% due to first pass metabolism; is rapidly cleared by hepatic metabolism with a $t_{1/2}$ of 1 hour. No active metabolite is produced. As such it is effective only in sleep-onset insomnia; does

not prolong total sleep time or reduce the number of awakenings. Because of brevity of action, it can be taken late at night (> 4 hour before waking time) without causing morning sedation. Surprisingly, despite very short action, no daytime anxiety or rebound insomnia has been observed. No tolerance or dependence has been reported and hypnotic effect does not fade on nightly use. However, its use should be limited to 1–2 weeks. The hypnotic efficacy of zaleplon is rated similar to zolpidem. Like the latter, effect on sleep stages and REM sleep are less than that of BZDs.

Dose: 5–10 mg (max 20 mg) at bed time.

ZAPLON, ZALEP, ZASO 5, 10 mg tabs.

USES

Currently, BZDs are one of the most frequently prescribed drugs. They have also been combined with many other categories of drugs with a view to improve efficacy by relieving attendant anxiety.

1. As hypnotic A hypnotic should not be casually prescribed for every case of insomnia. Understanding the cause of insomnia and use of a variety of other measures can avoid unnecessary hypnotic medication. When indicated, BZDs or the newer non-BZDs like zolpidem, zaleplon, zopiclone are the hypnotic of choice. A wide range of compounds have been developed to suit specific requirements. Some important points are outlined below:

- A hypnotic may be used to shorten sleep latency, to reduce nocturnal awakenings, or to provide anxiolytic effect the next day when insomnia is accompanied with marked element of anxiety.
- In the use of hypnotics, consideration must be given to onset and duration of action of the drug. The most suitable pharmacokinetic profile drug should be chosen for a given case.
- Impaired performance the next day is largely related to the dose and pharmacokinetic profile of the drug. The next day effects are either due to prolonged sedation (longer acting

drugs) or rebound anxiety (shorter acting drugs).

- Any hypnotic (probably except zolpidem-like drugs) becomes useless after regular use for a few days; may actually be harmful.
- Though effect of drugs on the EEG stages of sleep, including REM sleep, could be physiologically relevant, most important is the subject's own assessment of having slept restfully and with no impairment the following day. This probably correlates more closely with effect of the hypnotic on the *cyclic alternating pattern (CAP)* of sleep.
- Insomnia arises under a variety of circumstances. It could be a long-term (months-years), short-term (weeks) or transient (a day or two, mostly situational) problem.

Chronic insomnia (> 3 weeks) Uncertainty exists about the use of hypnotics in this situation. The patient may have a personality disorder, but often there is no specific stress factor; may have used hypnotics for long periods, may be alcoholic or have some somatic disease—gastroesophageal reflux, pain, COPD, etc. Measures like aerobic exercise, training at mental relaxation, avoiding anxiety about past/future performance at bedtime, attempting sleep when sleepiness is maximum, avoiding napping at day-time, coffee/alcohol restriction, treatment of concurrent somatic illness, psychotherapy and controlled sleep curtailment may succeed. Good nightly sleep improves the quality of day-time wakefulness. Patients of obstructive sleep apnoea have poor sleep and feel sleepy during the day. All hypnotics aggravate apnoea and are contraindicated.

Intermittent use of a hypnotic, say once every 3 days, may be tried. Risk of tolerance and abuse are maximum among chronic insomniacs. A slowly eliminated drug is preferable because rebound insomnia and withdrawal symptoms are least marked with these drugs.

Short-term insomnia (3–21 days) Emotional problem (occupational stress, bereavement) and physical illness are the usual causes. Patient may

have induction difficulty or may be waking up early. Cautious use of low doses of an appropriate drug for the type of sleep disturbance may be made. Generally a hypnotic, free of residual effects should be selected, but when anxiety is a dominant feature, a BZD whose action extends into the next day may be better. Short acting drugs are preferable in the elderly. Intermittent hypnotic use should be limited to 2–3 weeks.

Transient insomnia (1–3 days) Due to alterations in the circumstances of sleep, e.g. on an overnight train, new place, unusual pattern of work, shift workers, intercontinental travel—jetlag, etc. A rapidly eliminated hypnotic or one with marked distribution is to be preferred to avoid residual effects the next morning. However, night before surgery—a long acting drug is better.

2. Other uses

- As anxiolytic and for day-time sedation (*see* Ch. 33).
- As anticonvulsant, especially emergency control of status epilepticus, febrile convulsions, tetanus, etc. (*see* Ch. 30).
- As centrally acting muscle relaxant (*see* Ch. 25).
- For preanaesthetic medication, i.v. anaesthesia and conscious sedation (*see* Ch. 27).
- Before ECT, electrical cardioversion of arrhythmias, cardiac catheterization, endoscopies, in obstetrics and many minor procedures—diazepam i.v. has gained popularity because of its calming-amnesic-analgesic and muscle relaxant properties and relative safety.
- Alcohol withdrawal in dependent subjects.
- Along with analgesics, NSAIDs, spasmolytics, antiulcer and many other drugs.

Fixed dose combinations of sedative/hypnotic/anxiolytic drugs with analgesic-antipyretics has been banned in India.

BENZODIAZEPINE ANTAGONIST

Flumazenil It is a BZD analogue which has little intrinsic activity (practically no effect on normal subjects), but competes with BZD agonists as well as inverse agonists for the BZD

receptor and reverses their depressant or stimulant effects respectively.

Flumazenil abolishes the hypnogenic, psychomotor, cognitive and EEG effects of BZDs. At higher doses it has some weak BZD agonist-like as well as inverse agonist-like activity in animal models, but these are of no clinical significance.

Flumazenil is absorbed orally; oral bioavailability is ~16%, but it is not used orally. On i.v. injection, action of flumazenil starts in seconds and lasts for 1–2 hr; elimination $t_{1/2}$ is 1 hr, due to rapid metabolism.

Uses

1. To reverse BZD anaesthesia Patients anaesthetized/sedated with a BZD wake up, get oriented and regain motor control within 1 min of an i.v. injection of 0.3–1 mg of flumazenil. Resedation generally occurs after 1–2 hr (more with diazepam than with midazolam): supplemental doses of flumazenil may be given. It allows early discharge of patients after diagnostic procedures and facilitates postanaesthetic management.

2. BZD overdose Majority of patients of BZD overdose require only supportive measures like patent airway, maintenance of BP, cardiac and renal function, etc. In addition, flumazenil 0.2 mg/min may be injected i.v. till the patient regains consciousness. Practically all patients intoxicated with a BZD alone respond within 5 min. However, reversal of respiratory depression is incomplete. Flumazenil blocks the hypnotic effect of zolpidem-like non-BZDs as well. In mixed CNS depressant poisoning, whatever sedation is not abolished by 5 mg of flumazenil should be taken to be due to a non-BZD/non-Zolpidem-like depressant. It thus helps in differential diagnosis of such patients.

Adverse effects Flumazenil is safe and well tolerated.

Agitation, discomfort, tearfulness, anxiety, coldness and withdrawal seizures are the occasional side effects.

Melatonin It is N-acetyl-5-methoxy tryptamine, the principal hormone of the pineal gland which is secreted at night and has been found to play an important role in entraining (synchronizing) the sleep-wakefulness cycle with the circadian rhythm. Though high doses (80 mg) of melatonin can induce sleep, low doses (2–10 mg) do not depress the CNS, but probably increase the propensity of falling asleep. Started before the flight it has been shown to reduce jet-lag symptoms and to hasten reentrainment with day-night cycle of the new place in intercontinental travellers. Beneficial effects in shift workers and in individuals with delayed sleep phase syndrome have also been reported. It has improved sleep quality in elderly insomniacs and has helped weaning off regular BZD users of their hypnotic. However, melatonin is not a dependable hypnotic; has little effect on latency and duration of sleep, especially in non-elderly insomniacs. Though it is unlikely to have the disadvantages of conventional hypnotics, its long-term safety is not known. Lowering of seizure threshold at night has been related to melatonin peak and psychiatric changes due to melatonin are apprehended. Use may therefore be restricted to treatment of jet-lag, shift workers and elderly hypnotic dependent insomniacs.

Since melatonin secretion declines with age, it has been argued that melatonin supplementation might retard ageing. Though there is no proof of benefit melatonin (2–5 mg/day) is being consumed as a health food in USA and some other countries. It has also been tried in cluster headache. In India it is marketed as a remedy for disturbed biorhythms and degenerative diseases.

MELOSET 3 mg tab, ZYTONIN, ETERNEX melatonin 3 mg + pyridoxine 10 mg tab; one tab at evening daily.

Ramelteon It is a melatonin receptor agonist introduced in some countries as a novel hypnotic for sleep onset insomnia, that does not produce the usual BZD-like side effects.

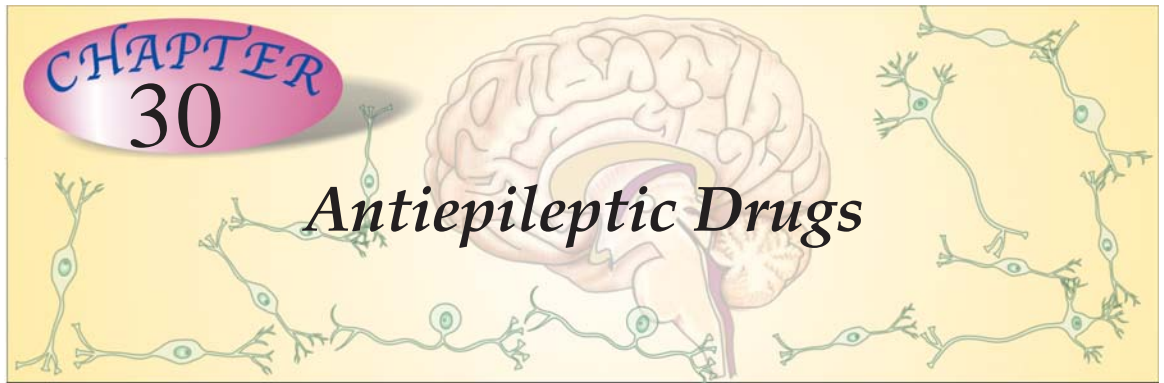

Epilepsies These are a group of disorders of the CNS characterized by paroxysmal cerebral dysrhythmia, manifesting as brief episodes (seizures) of loss or disturbance of consciousness, with or without characteristic body movements (convulsions), sensory or psychiatric phenomena. Epilepsy has a focal origin in the brain, manifestations depend on the site of the focus, regions into which the discharges spread and postictal depression of these regions. Recognised from the dawn of history as 'disease of lightening', it was correctly described by JH Jackson little over a century ago. Epilepsies have been classified variously; major types are described below.

I. Generalised seizures

1. **Generalised tonic-clonic seizures** (GTCS, major epilepsy, grand mal): commonest, lasts 1–2 min. The usual sequence is aura—cry—unconsciousness—tonic spasm of all body muscles—clonic jerking followed by prolonged sleep and depression of all CNS functions.
2. **Absence seizures** (minor epilepsy, petit mal): prevalent in children, lasts about 1/2 min. Momentary loss of consciousness, patient apparently freezes and stares in one direction, no muscular component or little bilateral jerking. EEG shows characteristic 3 cycles per second spike and wave pattern.
3. **Atonic seizures** (Akinetic epilepsy): Unconsciousness with relaxation of all muscles due to excessive inhibitory discharges. Patient may fall.

4. **Myoclonic seizures** Shock-like momentary contraction of muscles of a limb or the whole body.

5. **Infantile spasms (Hypsarrhythmia)** Seen in infants. Probably not a form of epilepsy. Intermittent muscle spasm and progressive mental deterioration. Diffuse changes in the interseizure EEG are noted.

II. Partial seizures

1. **Simple partial seizures** (SPS, cortical focal epilepsy): lasts 1/2–1 min. Often secondary. Convulsions are confined to a group of muscles or localized sensory disturbance depending on the area of cortex involved in the seizure, without loss of consciousness.

2. **Complex partial seizures** (CPS, temporal lobe epilepsy, psychomotor): attacks of bizarre and confused behaviour and purposeless movements, emotional changes lasting 1–2 min along with impairment of consciousness. An aura often precedes. The seizure focus is located in the temporal lobe.

3. **Simple partial or complex partial seizures secondarily generalized** The partial seizure occurs first and evolves into generalized tonic-clonic seizures with loss of consciousness.

Most of the cases are primary (idiopathic), some may be secondary to trauma/surgery on head, intracranial tumour, tuberculoma, cysticercosis, cerebral ischaemia, etc. Treatment is symptomatic and the same whether epilepsy is primary or secondary.

Experimental models These models for testing antiepileptic drugs have also shed light on the etiopathogenesis of epilepsy.

1. **Maximal electroshock seizures** Brief high intensity shock is applied to the head of a rodent (just as in ECT): produces tonic flexion—tonic extension—clonic convulsions. The tonic phase (especially extensor) is selectively abolished by drugs effective in GTCS. Activity in this model represents action on spread of seizure discharge.
2. **Pentylenetetrazol (PTZ) clonic seizures** Injection of PTZ in rats or mice produces clonic convulsions which are prevented by drugs effective in absence seizures. Activity in this model represents action on seizure focus itself.
3. **Chronic focal seizures** Produced by application of alumina cream on the motor cortex of monkey.
4. **Kindled seizures** Brief bursts of weak electrical impulses are applied to the brain (especially amygdala) intermittently over days. After-discharges increase progressively and tonic-clonic seizures are produced after 10–15 shocks; with time spontaneous seizures set in, usually after >100 shocks. This indicates that seizures have a self-perpetuating and reinforcing effect: more neuronal circuits are facilitated and recruited in the seizure process. Kindling is probably involved in the genesis of clinical epilepsy.

CLASSIFICATION

- | | |
|-------------------------------------|--|
| 1. Barbiturate | Phenobarbitone |
| 2. Deoxybarbiturate | Primidone |
| 3. Hydantoin | Phenytoin
Fosphenytoin |
| 4. Iminostilbene | Carbamazepine
Oxcarbazepine |
| 5. Succinimide | Ethosuximide |
| 6. Aliphatic carboxylic acid | Valproic acid
(sodium valproate)
Divalproex |
| 7. Benzodiazepines | Clonazepam
Diazepam
Lorazepam
Clobazam |
| 8. Phenyltriazine | Lamotrigine |
| 9. Cyclic GABA analogue | Gabapentin |
| 10. Newer drugs | Vigabatrin
Topiramate
Tiagabine
Zonisamide
Levetiracetam |

The oxazolinedione derivative *Trimethadione*, acetylurea *Phenacemide* and carbonic anhydrase inhibitor *Acetazolamide* are anticonvulsants no longer used due to their toxicity or relative inefficacy.

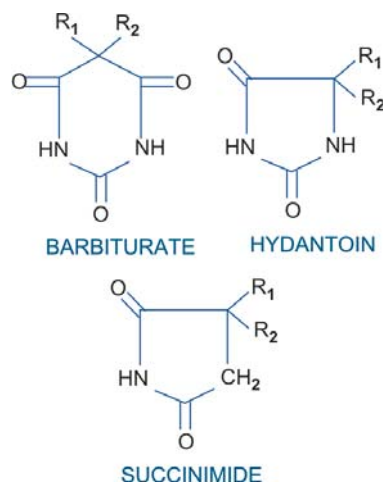

Fig. 30.1: Chemical structures of classical anticonvulsant drugs

Chemistry Most of the older anticonvulsants have close structural similarity. This is depicted in Fig. 30.1. However, benzodiazepines, carbamazepine, valproic acid and the newer drugs are chemically diverse. Presence of a phenyl substitution confers activity against tonic-clonic seizures.

Phenobarbitone (see Ch. 29)

Phenobarbitone was the first efficacious anti-epileptic introduced in 1912. The mechanism of CNS depressant action of barbiturates is described on p. 391. The same may apply to anticonvulsant action. GABA_A receptor mediated synaptic inhibition appears to be most important. However, phenobarbitone has specific anticonvulsant activity which is not entirely dependent on general CNS depression. Quantitative differences in the different facets of action (GABA-facilitatory, GABA-mimetic, ant glutamate, Ca²⁺ entry reduction) have been noted for phenobarbitone compared to hypnotic barbiturates. The higher anticonvulsant: hypnotic ratio of phenobarbitone may be due to its minimal effect on Ca²⁺ channels and glutamate release compared to hypnotic barbiturates. With continued use of phenobarbitone sedation wanes off but not anticonvulsant action. It has a wide spectrum of

anticonvulsant property—raises seizure threshold as well as limits spread and suppresses kindled seizures.

Phenobarbitone has slow oral absorption and a long plasma $t_{1/2}$ (80–120 hours), is metabolized in liver as well as excreted unchanged by kidney. Steady-state concentrations are reached after 2–3 weeks, and a single daily dose can be used for maintenance.

The major drawback of phenobarbitone as an antiepileptic is its sedative action. Long term administration (as needed in epilepsy) may produce additional side effects like—behavioral abnormalities, diminution of intelligence, impairment of learning and memory, hyperactivity in children, mental confusion in older people.

Rashes, megaloblastic anaemia and osteomalacia (similar to that with phenytoin) occur in some patients on prolonged use.

Uses Phenobarbitone is one of the cheapest and least toxic antiepileptics.

It has broad spectrum efficacy in generalized tonic-clonic (GTC), simple partial (SP) and complex partial (CP) seizures: 60 mg 1–3 times a day in adults; in children (3–6 mg/kg/day); However, it has become less popular than carbamazepine, phenytoin or valproate.

Status epilepticus: Phenobarbitone may be injected i.m. or i.v. but response is slow to develop.

It is not effective in absence seizures.

GARDENAL 30, 60 mg tabs, 20 mg/5 ml syr;
LUMINAL 30 mg tab, PHENOBARBITONE SODIUM
200 mg/ml inj.

Primidone A deoxybarbiturate, converted by liver to phenobarbitone and phenylethyl malonamide (PEMA). Activity is mainly due to these active metabolites because $t_{1/2}$ of primidone (6–14 hr) is less than that of its active metabolites. About 1/3 primidone is excreted unchanged by kidney. Dose to dose primidone is less potent, but antiepileptic efficacy is similar to phenobarbitone. It is infrequently used now in GTCs and partial epilepsy, mainly as an adjuvant to phenytoin or carbamazepine.

Some cases of myoclonic epilepsy respond. Adverse effects are similar to phenobarbitone. In addition, anaemia, leukopenia, psychotic reaction and lymph node enlargement occur rarely.

Dose: 250–500 mg BD, children 10–20 mg/kg/day.

MYSOLINE 250 mg tab.

Phenytoin (Diphenylhydantoin)

It was synthesized in 1908 as a barbiturate analogue, but shelved due to poor sedative property. Its anticonvulsant activity was specifically tested in 1938 and since then it is a major antiepileptic drug.

Phenytoin is not a CNS depressant; some sedation occurs at therapeutic doses, but this does not increase further with dose; rather toxic doses produce excitement and muscular rigidity. The most outstanding action is abolition of tonic phase of maximal electroshock seizures, with no effect on or prolongation of clonic phase. It limits spread of seizure activity. Threshold for PTZ convulsions is not raised. Tonic-clonic epilepsy is suppressed but paroxysmal focal EEG discharge and 'aura' persist.

Mechanism of action Phenytoin has a stabilizing influence on neuronal membrane—prevents repetitive detonation of normal brain cells during 'depolarization shift' that occurs in epileptic patients and consists of a synchronous and unusually large depolarization over which action potentials are superimposed. This is achieved by prolonging the inactivated state of voltage sensitive neuronal Na^+ channel (Fig. 30.2) that governs the refractory period of the neurone. As a result high frequency discharges are inhibited with little effect on normal low frequency discharges which allow Na^+ channels to recover even when inactivation is prolonged. This effect has been noted at therapeutic concentration of phenytoin, while other effects like reduction in Ca^{2+} influx, inhibition of glutamate and facilitation of GABA responses have been demonstrated at higher/toxic concentrations. Intracellular accumulation of Na^+ that occurs during repetitive firing is prevented.

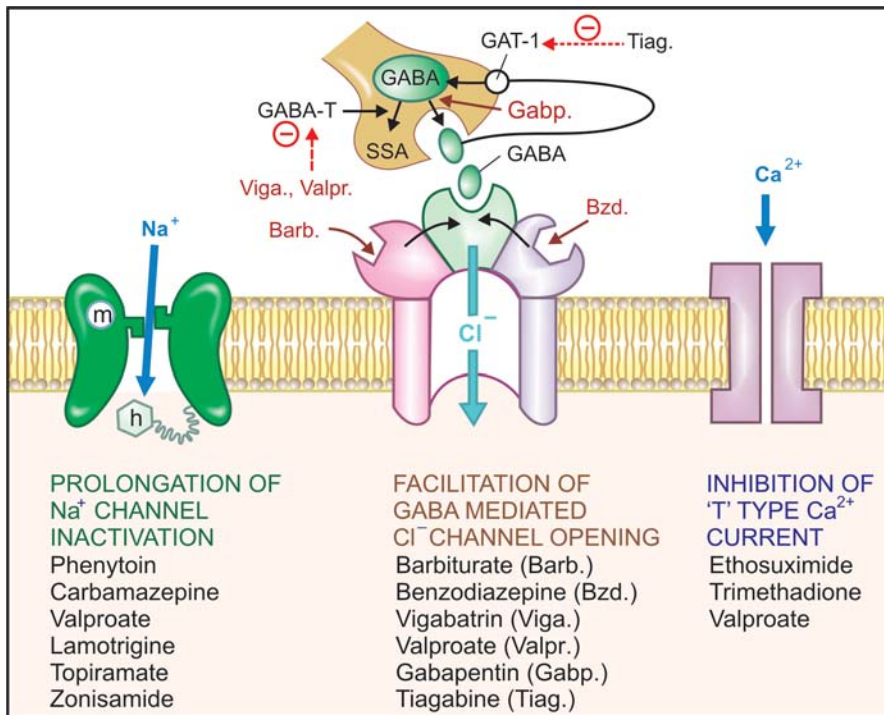

Fig. 30.2: Major mechanisms of anticonvulsant action
 m: Activation gate; h: Inactivation gate; GABA-T: GABA transaminase;
 SSA: Succinic semialdehyde; GAT-1: GABA transporter

Therapeutic concentrations have no effect on resting membrane potential: normal synaptic transmission is not impaired. Phenytoin, in contrast to phenobarbitone and valproate, does not interfere with kindling. Its ability to selectively inhibit high frequency firing confers efficacy in trigeminal neuralgia and cardiac arrhythmias as well.

Pharmacokinetics Absorption of phenytoin by oral route is slow, mainly because of its poor aqueous solubility. Bioavailability of different market preparations may differ. It is widely distributed in the body and is 80–90% bound to plasma proteins.

Phenytoin is metabolized in liver by hydroxylation and glucuronide conjugation. The kinetics of metabolism is *capacity limited*; changes from first order to zero order over the therapeutic range—small increments in dose produce dispropor-

tionately high plasma concentrations. The $t_{1/2}$ (12–24 hours) progressively increases (upto 60 hr) when plasma concentration rises above 10 $\mu\text{g}/\text{ml}$ as metabolizing enzymes get saturated. Monitoring of plasma concentration is very helpful in tailoring dosage. Only 5% unchanged phenytoin is excreted in urine.

Adverse effects These are numerous; some occur at therapeutic plasma concentration after prolonged use, while others are a manifestation of toxicity due to overdose.

At therapeutic levels

- Gum hypertrophy: Commonest (20% incidence), more in younger patients and is due to overgrowth of gingival collagen fibres. This can be minimized by maintaining oral hygiene.
- Hirsutism, coarsening of facial features (troublesome in young girls), acne.

- (c) Hypersensitivity reactions are—rashes, DLE, lymphadenopathy; neutropenia is rare but requires discontinuation of therapy.
- (d) Megaloblastic anaemia: phenytoin decreases folate absorption and increases its excretion.
- (e) Osteomalacia: phenytoin desensitizes target tissues to vit D and interferes with calcium metabolism.
- (f) It can inhibit insulin release and cause hyperglycaemia.
- (g) Used during pregnancy—can produce foetal hydantoin syndrome (hypoplastic phalanges, cleft palate, hare lip, microcephaly), which is probably caused by its areneoxide metabolite.

At high plasma levels (dose related toxicity)

- (a) Cerebellar and vestibular manifestations: ataxia, vertigo, diplopia, nystagmus are the most characteristic features.
- (b) Drowsiness, behavioral alterations, mental confusion, hallucinations, disorientation and rigidity.
- (c) Epigastric pain, nausea and vomiting: minimised by taking the drug with meals.
- (d) Intravenous injection can cause local vascular injury → intimal damage and thrombosis of the vein → edema and discolouration of the injected limb. Rate of injection should not exceed 50 mg/min.
- (e) Fall in BP and cardiac arrhythmias occur only on i.v. injection.

Interactions Phenobarbitone competitively inhibits phenytoin metabolism, while by enzyme induction both enhance each other's degradation—unpredictable overall interaction.

- Carbamazepine and phenytoin increase each other's metabolism.
- Valproate displaces protein bound phenytoin and decreases its metabolism: plasma level of unbound phenytoin increases.
- Chloramphenicol, isoniazid, cimetidine, dicumarol and warfarin inhibit phenytoin metabolism—can precipitate its toxicity.
- Phenytoin competitively inhibits warfarin metabolism.

- Phenytoin induces microsomal enzymes and increases degradation of steroids (failure of oral contraceptives), digitoxin, doxycycline, theophylline.
- A number of acidic drugs displace it from protein binding sites but this also enhances phenytoin clearance—concentration of free form does not change much.
- Sucralfate binds phenytoin in g.i. tract and decreases its absorption.

Uses Phenytoin is a first line antiepileptic drug for—

1. Generalized tonic-clonic, simple and complex partial seizures. It is ineffective in absence seizures.
2. Status epilepticus: occasionally used by slow i.v. injection (*see later*).
3. Trigeminal neuralgia: second choice drug to carbamazepine.

Dose: 100 mg BD, maximum 400 mg/day; Children 5–8 mg/kg/day.
 2. Status epilepticus: occasionally used by slow i.v. injection (*see later*).
 3. Trigeminal neuralgia: second choice drug to carbamazepine.

DILANTIN 25 mg, 100 mg cap., 100 mg/4 ml oral suspension, 100 mg/2 ml inj; **EPSOLIN** 100 mg tab, 100 mg/2 ml inj; **EPTON** 50, 100 mg tab, 25 mg/ml syr; **FENTOIN-ER** 100 mg extended release cap.

Fosphenytoin This water soluble prodrug of phenytoin has been introduced to overcome the difficulties in i.v. administration of phenytoin in status epilepticus. In the body, it is rapidly converted to phenytoin; its doses are expressed as phenytoin equivalents (PE). On i.v. injection it is less damaging to the intima; few vascular complications are produced; it can be injected at a faster rate (150 mg/min). While phenytoin cannot be injected in a drip of glucose solution, fosphenytoin can be injected with both saline and glucose.

FOSOLIN 50 mg/ml in 2 ml, 10 ml inj.

Carbamazepine

Chemically related to imipramine, it was introduced in the 1960s for trigeminal neuralgia; is now a first line antiepileptic drug. Its pharmacological actions resemble phenytoin, but important differences have been noted in experi-

mental studies. Carbamazepine modifies maximal electroshock seizures as well as raises threshold to PTZ and electroshock convulsions. It also inhibits kindling. Though its action on Na⁺ channels (prolongation of inactivated state) is similar to phenytoin, the profile of action on neuronal systems in brain is different.

Carbamazepine exerts a lithium-like therapeutic effect in mania and bipolar mood disorder. It also has antidiuretic action, probably by enhancing ADH action on renal tubules.

Pharmacokinetics Oral absorption of carbamazepine is slow and variable because of poor water solubility. It is 75% bound to plasma proteins and metabolized in liver by oxidation to an active metabolite (10-11 epoxy carbamazepine) as well as by hydroxylation and conjugation to inactive ones. It is a substrate as well as inducer of CYP3A4 and other drug metabolizing enzymes. Initially its plasma $t_{1/2}$ is 20–40 hours but, decreases to 10–20 hr on chronic medication due to autoinduction of metabolism.

Adverse effects Carbamazepine produces dose-related neurotoxicity—sedation, dizziness, vertigo, diplopia and ataxia. Vomiting, diarrhoea, worsening of seizures are also seen with higher doses. Acute intoxication causes coma, convulsions and cardiovascular collapse. Hypersensitivity reactions are rashes, photosensitivity, hepatitis, lupus like syndrome, rarely agranulocytosis and aplastic anaemia. Some degree of leucopenia due to hypersensitivity is more common.

Water retention and hyponatremia can occur in the elderly because it enhances ADH action. Increased incidence of minor foetal malformations has been reported. Its combination with valproate doubles teratogenic frequency.

Interactions Carbamazepine is an enzyme inducer; can reduce efficacy of haloperidol, oral contraceptives, lamotrigine and topiramate. Metabolism of carbamazepine is induced by phenobarbitone, phenytoin, valproate and *vice versa*.

Erythromycin, fluoxetine, isoniazid inhibit metabolism of carbamazepine.

Uses Carbamazepine is the most effective drug for CPS and shares first choice drug status with phenytoin for GTCS and SPS.

Trigeminal and related neuralgias: Carbamazepine is the drug of choice. These neuralgias are characterized by attacks of high intensity electric shock-like or stabbing pain set off by even trivial stimulation of certain trigger zones in the mouth or on the face. Drugs benefit by interrupting temporal summation of afferent impulses (by a selective action on high frequency nerve impulses). Carbamazepine is not an analgesic, but has a specific action (almost diagnostic) in these neuralgias. About 60% patients respond well. Phenytoin and baclofen are less efficacious alternatives.

Manic depressive illness and acute mania: as an alternative to lithium (*see* Ch. 32).

Dose: 200–400 mg TDS; Children 15–30 mg/kg/day. TEGRETOL, MAZETOL 100, 200, 400 mg tab, 100 mg/5 ml syr; CARBATOL 100, 200, 400 mg tab. MAZETOL SR, TEGRITAL CR 200, 400 mg sustained release/continuous release tabs. to avoid high peaks and low troughs in plasma concentration.

Oxcarbazepine This newer congener of carbamazepine is rapidly converted to an active metabolite that is only glucuronide conjugated but not oxidized. Toxic effects due to the epoxide metabolite are avoided. Drug interactions and autoinduction of own metabolism are less marked, because it is a weak enzyme inducer. Risk of hepatotoxicity is estimated to be lower than carbamazepine; but that of hyponatraemia is more. Indications are the same as for carbamazepine, but it may be better tolerated. Dose to dose it is 1½ times less potent.

OXETOL, OXCARB, OXEP 150, 300, 600 mg tabs.

Ethosuximide

The most prominent action of ethosuximide is antagonism of PTZ induced clonic seizures at doses which produce no other discernable

action. It raises seizure threshold but does not modify maximal electroshock seizures or inhibit kindling. Clinically it is effective only in absence seizures.

The primary action appears to be exerted on thalamocortical system which is involved in the generation of absence seizures. The EEG in absence seizures shows characteristic bilaterally synchronous 3 Hz spike and wave rhythm generated by oscillation of impulses between thalamus and neocortex through reverberatory synaptic connections. Thalamic neurones exhibit prominent 'T' (transient) current which is low threshold Ca^{2+} current (due to inward flow of Ca^{2+} through T type Ca^{2+} channels) that acts as the pacemaker and amplifies repetitive spikes. Ethosuximide selectively suppresses T current without affecting other types of Ca^{2+} or Na^{+} currents. It also does not potentiate GABA at therapeutic concentrations. This correlates well with its selective action in absence seizures.

Ethosuximide is rather slowly but completely absorbed, not protein bound, evenly distributed in body, and largely metabolized in liver by hydroxylation and glucuronidation, and excreted in urine—about 1/4th in the unchanged form. Plasma $t_{1/2}$ averages 48 hours in adults and 32 hours in children.

Adverse effects Dose-related side effects are gastrointestinal intolerance, tiredness, mood changes, agitation, headache, drowsiness and inability to concentrate. Hypersensitivity reactions like rashes, DLE and blood dyscrasias are rare. No liver or kidney damage.

Use The only indication for ethosuximide is absence seizures; in that also it has been superseded by valproate. *Dose:* 20–30 mg/kg/day; ZARONTIN 250 mg/5 ml syr.

Valproic acid (Sodium valproate)

It is a branched chain aliphatic carboxylic acid with a broad spectrum anticonvulsant action. It is more potent in blocking PTZ seizures than in modifying maximal electroshock. Establishment of chronic experimental seizure foci and kindling are also prevented. Remarkably, at anticonvulsant doses, valproate produces little sedation or other central effects. Likewise, it is effective in partial seizures and GTCS as well as absence seizures.

Valproate appears to act by multiple mechanisms:

- (i) A phenytoin-like frequency-dependent prolongation of Na^{+} channel inactivation.
- (ii) Weak attenuation of Ca^{2+} mediated 'T' current (ethosuximide like).
- (iii) Augmentation of release of inhibitory transmitter GABA by inhibiting its degradation (by GABA-transaminase) as well as probably by increasing its synthesis from glutamic acid. However, responses to exogenously applied GABA are not altered.

Pharmacokinetics Oral absorption of valproic acid is good. It is 90% bound to plasma proteins; completely metabolized in liver by oxidation (some metabolites are active) and glucuronide conjugation—excreted in urine. Plasma $t_{1/2}$ is 10–15 hours; but anticonvulsant effects are longer lasting.

Adverse effects The toxicity of valproate is low.

Anorexia, vomiting, heart burn are common. Drowsiness, ataxia and tremor are dose-related side effects. However, cognitive and behavioral effects are not prominent.

Alopecia, curling of hair and increased bleeding tendency have been observed.

Rashes and thrombocytopenia are infrequent hypersensitivity phenomena.

Asymptomatic rise in serum transaminase is common; monitoring of liver function is advised. A rare but serious adverse effect is fulminant hepatitis; occurs only in children (especially below 3 yr). Those with hepatic disease or who receive other anticonvulsant or hepatotoxic drug are at greater risk. Pancreatitis is also reported. Long-term use of valproate in young girls has been associated with higher incidence of polycystic ovarian disease and menstrual irregularities.

Used during pregnancy, it has produced spina bifida and other neural tube defects in the offspring; should be avoided.

Dose: Adults—start with 200 mg TDS, maximum 800 mg TDS; children—15–30 mg/kg/day.

VALPARIN CHRONO 200, 300, 500 mg tabs, 200 mg/5 ml syr; ENCORATE 200, 300, 500 mg regular and controlled release tabs, 200 mg/5 ml syr, 100 mg/ml inj.

Uses Valproic acid is the drug of choice for absence seizures.

It is an alternative/adjuvant drug for GTCS, SPS and CPS.

Myoclonic and atonic seizures—control is often incomplete, but valproate is the drug of choice. Mania and bipolar illness: as alternative to lithium.

Valproate has some prophylactic efficacy in migraine.

Interactions

- Valproate increases plasma levels of phenobarbitone by inhibiting its metabolism.
- It displaces phenytoin from protein binding site and decreases its metabolism → phenytoin toxicity.
- Valproate and carbamazepine induce each other's metabolism.
- Concurrent administration of clonazepam and valproate is contraindicated because absence status may be precipitated.
- Foetal abnormalities are more common if valproate and carbamazepine are given concurrently.

Divalproex (Semisodium valproate) It is the coordination compound of valproic acid with sodium valproate (1:1). Oral absorption is slower, but bioavailability is the same. Gastric tolerance may be better.

DIPROEX, VALANCE, 125, 250, 500 mg tabs; DEPAKOTE 250, 500 mg tabs.

Clonazepam

It is a benzodiazepine with prominent anticonvulsant properties: blocks PTZ seizures at doses which produce mild sedation. Efficacy in modifying maximal electroshock seizures is low. Though in experimental models of chronic epilepsy it inhibits spread rather than the focus itself, it is singularly ineffective in GTCS.

Production of generalized seizures by kindling is suppressed, but local after-discharges persist.

Benzodiazepines potentiate GABA induced Cl^- influx to produce sedation and the same mechanism has been held responsible for the anticonvulsant property, but the sites of action in the brain may be different. At large doses, high frequency discharges are inhibited akin to phenytoin.

Pharmacokinetics Oral absorption of clonazepam is good. It is 85% bound to plasma proteins, completely metabolized in liver and excreted in urine; $t_{1/2}$ averages 24 hours. It does not produce any active metabolite.

Adverse effects The most important side effect of clonazepam is sedation and dullness. This can be minimized by starting at low dose; some tolerance develops with chronic therapy. Lack of concentration, irritability, temper and other behavioral abnormalities may occur in children. Motor disturbances and ataxia are dose-related adverse effects.

Salivation and increased respiratory secretions may be complained of.

Uses Clonazepam has been primarily employed in absence seizures. It is also useful as an adjuvant in myoclonic and akinetic epilepsy and may afford some benefit in infantile spasms. However, its value is limited by development of tolerance to the therapeutic effect within six months or so.

Dose: adults 0.5–5 mg TDS, children 0.02–0.2 mg/kg/day.

LONAZEP, CLONAPAX, RIVOTRIL 0.5, 1.0, 2.0 mg tab.

Clobazam It is a 1,5 benzodiazepine (diazepam and others are 1,4 benzodiazepines) introduced first as anxiolytic and later found to possess useful antiepileptic efficacy in partial, secondarily generalized tonic-clonic as well as absence, myoclonic and atonic seizures, including some refractory cases. Sedation and psychomotor retardation are less prominent, but side effect profile is similar to other BZDs. It appears to act by facilitating GABA action.

Oral bioavailability of clobazam is ~90% and elimination $t_{1/2}$ 18 hrs, but an active metabolite is produced which has longer $t_{1/2}$ (>35 hr). It is generally used as adjuvant to other antiepileptic drugs like phenytoin, carbamazepine, valproate or phenobarbitone in refractory epilepsy. The above drugs may lower serum levels of clobazam.

Dose: start with 10–20 mg at bedtime, can be increased upto 60 mg/day; **FRISIUM, LOBAZAM, CLOZAM, 5, 10, 20 mg cap.**

Diazepam (see Ch. 29)

It has anticonvulsant activity in a variety of models but is not used for long term therapy of epilepsy because of prominent sedative action and rapid development of tolerance to the antiepileptic effect. However, it is the drug of choice for emergency control of convulsions, e.g. status epilepticus, tetanus, eclampsia, convulsant drug poisoning, etc.

For this purpose 0.2–0.5 mg/kg slow i.v. injection is followed by repeated doses as required; maximum 100 mg/day. Thrombophlebitis of injected vein is not uncommon. Marked fall in BP and respiratory depression can occur; resuscitative measures should be at hand before the drug is injected.

Rectal instillation of diazepam is now the preferred therapy for febrile convulsions in children.

Lorazepam 0.1 mg/kg injected i.v. at a rate not exceeding 2 mg/min is an alternative to diazepam in status epilepticus or for emergency control of convulsions of other etiology. The action of lorazepam after i.v. injection is more sustained than that of diazepam which is rapidly redistributed.

Lamotrigine A new anticonvulsant having carbamazepine-like action profile: modifies maximal electroshock and decreases electrically evoked as well as photic after-discharge duration. Prolongation of Na⁺ channel inactivation and suppression of high frequency firing has been demonstrated. In addition, it may directly block voltage sensitive Na⁺ channels, thus stabilizing the presynaptic membrane and preventing release of excitatory neurotransmitters, mainly glutamate and aspartate. This may account for its broader-spectrum of antiseizure efficacy. However, it does not antagonize PTZ seizures or block NMDA type of glutamate receptors.

Lamotrigine is a broad-spectrum antiepileptic. Initially found useful as add-on therapy in refractory cases of partial seizures and GTCS, it has now been shown effective as monotherapy as well. Absence and myoclonic or akinetic epilepsy cases have also been successfully treated. Reduction in seizure frequency or complete control is obtained as frequently as with carbamazepine.

Lamotrigine is well absorbed orally and metabolized completely in liver. Its $t_{1/2}$ is 24 hr, but is reduced to ~16 hr in patients receiving phenytoin, carbamazepine or phenobarbitone. On the contrary valproate inhibits glucuronidation of lamotrigine and doubles its blood level, but valproate levels are lowered by lamotrigine. Reduce the dose of lamotrigine to half in patients taking valproate. However, metabolism of other anticonvulsants and oral contraceptives is not altered.

Side effects are sleepiness, dizziness, diplopia, ataxia and vomiting. In some comparative trials lamotrigine has been found to be better tolerated than carbamazepine or phenytoin. Negative effect on cognitive function is not reported. Rash may be a severe reaction, particularly in children, requiring withdrawal. *Dose:* 50 mg/day initially, increase upto 300 mg/day as needed; not to be used in children. **LAMETEC, LAMITOR, LAMIDUS 25, 50, 100 mg tabs.**

Gabapentin This lipophilic GABA derivative crosses to the brain and enhances GABA release, but does not act as agonist at GABA_A receptor. It modifies maximal electroshock as well as inhibits PTZ induced clonic seizures. Added to a first line drug, it reduces seizure frequency in refractory partial seizures with or without generalization. Though gabapentin has been found effective as monotherapy as well in SPS and CPS, it is mostly employed as add-on drug. Gabapentin is considered to be a first line drug for pain due to diabetic neuropathy and postherpetic neuralgia; has some prophylactic effect in migraine also.

Gabapentin is well absorbed orally and excreted unchanged in urine with a $t_{1/2}$ of 6 hrs.

No change in dose of primary antiepileptic drug is required when gabapentin is added. Side effects are mild sedation, tiredness, dizziness and unsteadiness.

Dose: Start with 300 mg OD, increase to 300–600 mg TDS as required; **NEURONTIN 300 mg, 400 mg cap, GABANTIN, GABAPIN 100, 300, 400 mg cap.**

Vigabatrin (γ vinyl GABA) It is an inhibitor of GABA-transaminase, the enzyme which degrades GABA. Anticonvulsant action may be due to increase in synaptic GABA concentration. It suppresses maximal electroshock and kindled seizures, and is effective in many patients with refractory epilepsy, especially partial seizures with or without generalization. It is at present approved only for adjuvant medication.

Visual field contraction and production of behavioral changes, depression and psychosis in some patients is its most important drawback.

Dose: 2–4 g daily; children 40–100 mg/kg/day.

Topiramate This weak carbonic anhydrase inhibitor has broad spectrum anticonvulsant activity in maximal electroshock, PTZ induced clonic seizures and in kindling model. It appears to act by multiple mechanisms, *viz* phenytoin like prolongation of Na⁺ channel inactivation, GABA potentiation by a postsynaptic effect and antagonism of certain glutamate receptors.

Topiramate is indicated for supplementing primary antiepileptic drug in refractory SPS, CPS and GTCS. As monotherapy also its efficacy has been rated equivalent to valproate. Promising results have been obtained in myoclonic epilepsy. Topiramate is readily absorbed orally and primarily excreted unchanged in urine with an average $t_{1/2}$ of 24 hours. Adverse effects are impairment of attention, sedation, ataxia, word finding difficulties, psychiatric symptoms, weight loss, paresthesias and renal stones.

Recently, topiramate has been approved for prophylaxis of migraine; may be used when β blockers/other prophylactics are contraindicated or are not effective.

Dose: Initially 25 mg OD, increase weekly upto 100–200 mg BD as required.

TOPEX, EPITOP, TOPAMATE, 25, 50, 100 mg tabs.

Tiagabine This newer anticonvulsant potentiates GABA mediated neuronal inhibition by depressing GABA

transporter GAT-1 which removes synaptically released GABA into neurones and glial cells. Maximal electroshock and kindled seizures are suppressed. Currently it is approved only for add-on therapy of partial seizures with or without secondary generalization, when not adequately controlled by standard antiepileptic drugs alone. Side effects are mild sedation, nervousness, asthenia, amnesia and abdominal pain.

Zonisamide Another new anticonvulsant with weak carbonic anhydrase inhibitory action that modifies maximal electroshock seizures and inhibits kindling, but does not antagonize PTZ. Prolongation of Na⁺ channel inactivation resulting in suppression of repetitive neuronal firing has been observed. It is indicated as add-on drug in refractory partial seizures.

Levetiracetam A unique anticonvulsant which suppresses kindled seizures but is ineffective against maximal electroshock or PTZ. Clinical efficacy has been shown as adjuvant medication in refractory partial seizures with or without secondary generalization. None of the usual anticonvulsant mechanisms of action appear to be applicable to levetiracetam.

TREATMENT OF EPILEPSIES

Antiepileptic drugs suppress seizures, but do not cure the disorder; the disease may fade out though after years of successful control. The aim of drugs is to control and totally prevent all seizure activity at an acceptable level of side effects. With the currently available drugs, this can be achieved in about half of the patients. Another 20–30% attain partial control, while the rest remain resistant. The cause of epilepsy should be searched in the patient; if found and treatable, an attempt to remove it should be made. Some general principles of symptomatic treatment with antiepileptic drugs are:

- (i) Choice of drug (Table 30.1) and dose is according to the seizure type(s) and need of the individual patient.
- (ii) Initiate treatment early, because each seizure episode increases the propensity to further attacks, probably by a process akin to kindling. Start with a single drug, preferably at low dose—gradually increase dose till full control of seizures or side effects appear. If full control is not obtained at maximum tolerated dose of one

Table 30.1: Choice of antiseizure drugs

Type of seizure	First choice drugs	Second choice drugs	Alternative/Add-on drugs
1. Generalised tonic-clonic/ simple partial with or without generalization	Carbamazepine, Phenytoin	Valproate, Phenobarbitone	Lamotrigine, Gabapentin, Topiramate, Primidone
2. Complex partial with or without generalization	Carbamazepine, Valproate, Phenytoin	Gabapentin, Lamotrigine	Clobazam, Zonisamide Topiramate, Tiagabine
3. Absence	Valproate	Ethosuximide, Lamotrigine	Clobazam, Clonazepam
4. Myoclonic	Valproate	Topiramate, Lamotrigine	Primidone, Clonazepam
5. Atonic	Valproate	Clonazepam, Clobazam	Lamotrigine
6. Febrile seizures	Diazepam (rectal)	—	—
7. Status epilepticus	Diazepam (i.v.) Lorazepam (i.v.)	Fosphenytoin (i.v.) Phenobarbitone (i.v., i.m.)	Gen. anaesthetics

drug, substitute another drug. Use combinations when all reasonable monotherapy fails. Combining drugs with different mechanisms of action, such as those which prolong Na⁺ channel inactivation with those facilitating GABA appears more appropriate. Pharmacokinetic interactions among anticonvulsants are common; dose adjustments guided by therapeutic drug monitoring are warranted.

(iii) Therapy should be as simple as possible. A seizure diary should be maintained.

(iv) All drug withdrawals should be gradual (except in case of toxicity), abrupt stoppage of therapy without introducing another effective drug can precipitate status epilepticus. Prolonged therapy (may be life-long, or at least 3 years after the last seizure) is needed. Withdrawal may be attempted in selected cases. Factors favourable to withdrawal are—childhood epilepsy, absence of family history, primary generalized tonic-clonic epilepsy, recent onset at start of treatment, absence of cerebral disorder and normal EEG. Even then recurrence rates of 12–40% have been reported.

(v) Dose regulation may be facilitated by monitoring of steady-state plasma drug levels. Monitoring is useful because:

- Therapeutic range of concentrations has been defined for many drugs.
- There is marked individual variation in the plasma concentration attained with the same daily dose.
- Compliance among epileptic patients is often poor.

Plasma levels given in Table 30.2 are to serve as rough guides:

Table 30.2: Plasma half life, therapeutic and toxic plasma concentration range of some important antiepileptic drugs

Drug	Half life (hr)	Plasma concentration (µg/ml)	
		Therapeutic	Toxic
Phenobarbitone	80–120	10–30	> 30 mild > 60 severe
Phenytoin	12–36	10–20	> 20 mild > 35 severe
Carbamazepine	10–40	5–10	> 12
Ethosuximide	30–50	50–100*	>200
Valproate	10–15	40–100*	–
Clonazepam	20–40	0.01–0.1*	–

* Poorly correlated with response.

(vi) When women on antiepileptic therapy conceive, antiepileptic drugs should not be stopped. Though, most antiseizure drugs have been shown to increase the incidence of birth defects, discontinuation of therapy carries a high risk of status epilepticus. Fits occurring during pregnancy themselves increase birth defects and may cause mental retardation in the offspring (anoxia occurs during seizures). An attempt to reduce the dose of drugs should be cautiously made. It may be advisable to substitute valproate.

Prophylactic folic acid supplementation in 2nd and 3rd trimester along with vit. K in the last month of pregnancy is recommended, particularly in women receiving antiepileptic drugs to minimise neural tube defects and bleeding disorder respectively in the neonate.

(vii) Individual seizure episodes do not require any treatment. During an attack of tonic-clonic seizures, the first priority is to prevent injury due to fall or biting. The patient should be put in prone or lateral position and a gag should be placed between the teeth. The head should be turned and patency of airway ensured. The attack usually passes off in 2–3 min, but the patient may not be roadworthy for a couple of hours.

1. Generalised tonic-clonic and simple partial seizures In large comparative trials, considering both efficacy and toxicity, carbamazepine and phenytoin have scored highest, phenobarbitone was intermediate, while primidone was lowest. Carbamazepine was the best in partial seizures, while valproate was equally effective in secondarily GTCS. Valproate is a good second line drug but should be used cautiously in young children for fear of hepatic toxicity. Carbamazepine is preferred in young girls because of cosmetic side effects of phenytoin.

Lamotrigine, gabapentin and topiramate have emerged as good alternatives. Newer drugs are to be used as add-on therapy in cases with incomplete/poor response or even as mono-

therapy in selected patients to avoid drug interactions and side effects. The newer drugs are less sedating and produce fewer side effects.

Complete control can be obtained in upto 90% patients with generalized seizures, but in only 50% or less patients with partial seizures.

Phenobarbitone, phenytoin, valproate and carbamazepine have been used to treat early post head injury seizures. Phenobarbitone and phenytoin are often prescribed empirically for prophylaxis of late-onset (8 days to 2 yrs later) post-traumatic epilepsy, but risk/benefit ratio of such use is not clear. Decision has to be taken on individual basis.

2. Complex partial seizures This type of epilepsy is difficult to control completely; relapses are more common on withdrawal. Carbamazepine is the preferred drug, but phenytoin or valproate may have to be added to it. Phenobarbitone or primidone could be used with one of the above drugs. The newer drugs clobazam, lamotrigine, gabapentin and topiramate may be added in refractory cases.

3. Absence seizures Ethosuximide and valproate are equally efficacious, but the latter is more commonly used because it would also prevent kindling and emergence of GTCS. Valproate is clearly superior in mixed absence and GTCS, which is more common than pure absence seizures. Lamotrigine has emerged as a good alternative. Clonazepam is a second line drug limited by its sedative property and development of tolerance. Clobazam is an alternative with promise of more sustained response.

4. Myoclonic and atonic seizures Valproate is the preferred drug and lamotrigine is an effective alternative. Topiramate may be added in case of poor response. Primidone and clonazepam are occasionally used.

5. Febrile convulsions Some children, especially under 5 years age, develop convulsions during fever. These may recur every time with fever and few may become chronic epileptics. Every attempt should be made to see that they

do not develop fever, but when they do, the temperature should not be allowed to rise by using paracetamol and external cooling.

The best treatment of febrile convulsions is rectal diazepam 0.5 mg/kg given at the onset of convulsions. The i.v. preparation can be used; a rectal solution (5 mg in 2.5 ml) in tubes is available in the UK. Seizures generally stop in 5 min; if not another dose may be given. The drug is repeated 12 hourly for 4 doses. If fever is prolonged a gap of 24–48 hr is given before starting next series of doses.

In recurrent cases or those at particular risk of developing epilepsy—intermittent prophylaxis with diazepam (oral or rectal) started at the onset of fever is recommended. Chronic prophylaxis with phenobarbitone advocated earlier has been abandoned, because of poor efficacy and behavioral side effects.

6. Infantile spasms (hypsarrhythmia) Therapy is unsatisfactory, antiepileptic drugs are generally useless. Corticosteroids afford symptomatic relief. Valproate and clonazepam have adjuvant value. Vigabatrin has some efficacy.

7. Status epilepticus In status epilepticus seizure activity occurs for >30 min, or two or more seizures occur without recovery of consciousness. Recurrent tonic-clonic convulsions

without recovery of consciousness in between is an emergency; fits have to be controlled as quickly as possible to prevent death and permanent brain damage.

(a) Diazepam 10 mg i.v. bolus injection (2 mg/min) followed by fractional doses every 10 min or slow infusion titrated to control the fits has been the standard treatment. However, it redistributes rapidly so that anticonvulsant effect starts fading after 20 min. Lorazepam is less lipid soluble with slow redistribution: anticonvulsant effect of i.v. dose lasts for 6–12 hours. It is therefore preferred; 0.1 mg/kg (injected at 2 mg/min) is effective in 75–90% cases.

(b) Phenobarbitone (100–200 mg i.m./i.v.) or phenytoin (25–50 mg/min in a running saline i.v. line; not to be mixed with glucose solution because it precipitates. Fosphenytoin is used in its place now; maximum 1000 mg phenytoin equivalent). These drugs act more slowly; may be used alternatively to diazepam/lorazepam or substituted for them after the convulsions have been controlled.

(c) Refractory cases may be treated with i.v. midazolam/propofol/thiopentone anaesthesia, with or without curarization.

(d) General measures, including maintenance of airway (intubation if required), oxygenation, fluid and electrolyte balance, BP, normal cardiac rhythm, euglycaemia and care of the unconscious must be taken.



These are drugs that have a therapeutic effect in parkinsonism.

Parkinsonism It is an extrapyramidal motor disorder characterized by *rigidity*, *tremor* and *hypokinesia* with secondary manifestations like defective posture and gait, mask-like face and sialorrhoea; dementia may accompany. If untreated the symptoms progress over several years to end-stage disease in which the patient is rigid, unable to move, unable to breathe properly; succumbs mostly to chest infections/embolism.

Parkinson's disease (PD) is a progressive degenerative disorder, mostly affecting older people, first described by James Parkinson in 1817. Majority of the cases are idiopathic, some are arteriosclerotic while postencephalitic are now rare. Wilson's disease (hepatolenticular degeneration) due to chronic copper poisoning, is a rare cause.

The most consistent lesion in PD is degeneration of neurones in the substantia nigra pars compacta (SN-PC) and the nigrostriatal (dopaminergic) tract. This results in deficiency of dopamine (DA) in the striatum which controls muscle tone and coordinates movements. An imbalance between dopaminergic (inhibitory) and cholinergic (excitatory) system in the striatum occurs giving rise to the motor defect. Though the cholinergic system is not primarily affected, its suppression (by anticholinergics) tends to restore balance.

The cause of selective degeneration of nigrostriatal neurones is not precisely known, but appears to be multifactorial. Oxidation of DA by MAO-B and aldehyde dehydrogenase generates hydroxyl free radicals ($\cdot\text{OH}$) in the presence of ferrous iron (basal ganglia are rich in iron).

Normally these free radicals are quenched by glutathione and other protective mechanisms. Age-related and/or otherwise acquired defect in protective mechanism allows the free radicals to damage lipid membranes and DNA resulting in neuronal degeneration. Genetic predisposition may contribute to the high vulnerability of substantia nigra neurones.

Ageing induces defects in mitochondrial electron transport chain. Environmental toxins and/or genetic factors may accentuate these defects in specific areas. A synthetic toxin N-methyl-4-phenyl tetrahydropyridine (MPTP), which occurred as a contaminant of some illicit drugs, produces nigrostriatal degeneration and manifestations similar to PD by impairing energy metabolism in dopaminergic neurones. It has been proposed that MPTP-like chemicals may be present in the environment, small quantities of which accelerate age related or otherwise predisposed neuronal degeneration of parkinsonism, but there is no proof.

Excess of the excitatory transmitter glutamate can cause 'excitotoxic' neuronal death by inducing Ca^{2+} overload through NMDA receptors.

Drug-induced temporary parkinsonism due to neuroleptics, metoclopramide (dopaminergic blockers) is now fairly common, while that due to reserpine (DA depleter) is historical.

Belladonna alkaloids had been empirically used in PD. A breakthrough was made in 1967 when *levodopa* was found to produce dramatic improvement. Its use was based on sound scientific investigations made in the preceding 10 years that—DA is present in the brain; it (along with other monoamines) is depleted by reserpine; reserpine induced motor defect is reversed by

DOPA (the precursor of DA); striatum of patients dying of PD was deficient in DA. Thus, parkinsonism was characterized as a DA deficiency state and levodopa was used to make good this deficiency, because DA itself does not cross the blood-brain barrier. In the subsequent years, a number of levodopa potentiators and DA agonists have been developed as adjuvants/alternatives.

CLASSIFICATION

I. Drugs affecting brain dopaminergic system

- (a) *Dopamine precursor* : Levodopa (l-dopa)
- (b) *Peripheral decarboxylase inhibitors* :
Carbidopa, Benserazide.
- (c) *Dopaminergic agonists*: Bromocriptine, Ropinirole, Pramipexole
- (d) *MAO-B inhibitor*: Selegiline
- (e) *COMT inhibitors*: Entacapone, Tolcapone
- (f) *Dopamine facilitator*: Amantadine.

II. Drugs affecting brain cholinergic system

- (a) *Central anticholinergics*: Trihexyphenidyl (Benzhexol), Procyclidine, Biperiden.
- (b) *Antihistaminics* : Orphenadrine, Promethazine.

LEVODOPA

Levodopa has a specific salutary effect in PD: efficacy exceeding that of any other drug used alone. It is inactive by itself, but is the immediate precursor of the transmitter DA. More than 95% of an oral dose is decarboxylated in the peripheral tissues (mainly gut and liver). DA thus formed acts on heart, blood vessels, other peripheral organs and on CTZ (though located in the brain, i.e. floor of IV ventricle, it is not bound by blood-brain barrier). About 1–2% of administered levodopa crosses to the brain, is taken up by the surviving dopaminergic neurones, converted to DA which is stored and released as a transmitter. Brains of parkinsonian patients treated with levodopa till death had DA levels higher than those not so treated. Further, those patients who had responded well had higher DA levels than those who had responded poorly.

ACTIONS

1. CNS Levodopa hardly produces any effect in normal individuals or in patients with other neurological diseases. Marked symptomatic improvement occurs in parkinsonian patients. Hypokinesia and rigidity resolve first, later tremor as well. Secondary symptoms of posture, gait, handwriting, speech, facial expression, mood, self care and interest in life are gradually normalized.

The effect of levodopa on behaviour has been described as a 'general alerting response'. In some patients this progresses to excitement—frank psychosis may occur. Embarrassingly disproportionate increase in sexual activity has also been noted. Dementia, if present, does not improve; rather it predisposes to emergence of psychiatric symptoms.

Levodopa has been used to produce a non-specific 'awakening' effect in hepatic coma.

Two subtypes of DA receptors (D1, D2) were originally described. Three more (D3, D4, D5) have now been identified and cloned. All are G protein coupled receptors and are grouped into two families:

D1 like (D1, D5) Are excitatory: act by increasing cAMP formation and PIP₂ hydrolysis thereby mobilizing intracellular Ca²⁺ and activating protein kinase C through IP₃ and DAG.

D2 like (D2, D3, D4) Are inhibitory: act by inhibiting adenylyl cyclase/opening K⁺ channels/depressing voltage sensitive Ca²⁺ channels.

The various subtypes of DA receptors are differentially expressed in different areas of the brain, and appear to play distinct roles. Both D1 and D2 receptors are present in the striatum and are involved in the therapeutic response to levodopa. They respectively regulate the activity of two pathways having opposite effects on the thalamic input to the motor cortex (Fig. 31.1). Thus, stimulation of excitatory D1 as well as inhibitory D2 receptors in the striatum achieves the same net effect of smoothening movements and reducing muscle tone.

Dopamine receptor in SN-PC and in pituitary is also of D2 type. The D3 receptors predominate in nucleus accumbans and hypothalamus, but are sparse in caudate and putamen, while D4 and D5 are mostly distributed in neocortex, midbrain, medulla and hippocampus.

2. CVS The peripherally formed DA can cause tachycardia by acting on β adrenergic receptors.

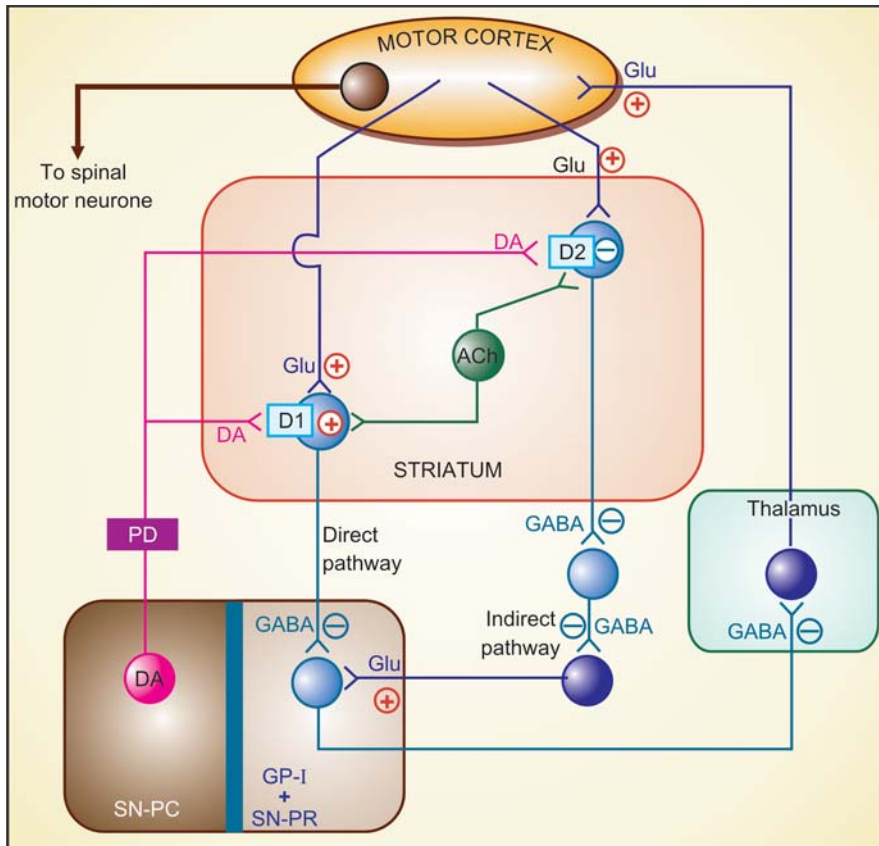

Fig. 31.1: Simplified scheme of side loop circuits in the basal ganglia that provide modulatory input to the motor cortex. The striatal GABAergic neurones receive side-loop excitatory glutamatergic (Glu) input from the motor cortex and modulatory dopaminergic (DA) projections from the substantia nigra pars compacta (SN-PC). There are also balancing cholinergic (ACh) interneurons. The striatal neurones express both excitatory D1 and inhibitory D2 receptors. The output from the striatum to substantia nigra pars reticulata (SN-PR) and internal globus pallidus (GP-I) follows a direct and an indirect pathway. The direct pathway modulated by D1 receptors releases inhibitory transmitter GABA, while the dominant indirect pathway modulated by D2 receptors has two inhibitory (GABAergic) relays and an excitatory (glutamatergic) terminal. Due to this arrangement, dopaminergic action in the striatum exerts inhibitory influence on SN-PR and GP-I via both the pathways. The output neurones from SN-PR and GP-I feedback on the motor cortex through the thalamus using an inhibitory GABAergic link and an excitatory glutamatergic terminal. The basal ganglia modulatory loop serves to smoothen output to the spinal motor neurone and reduce basal tone.

The degenerative lesion (in SN-PC) of Parkinson's disease (PD) decreases dopaminergic input to the striatum, producing an imbalance between DA and ACh, resulting in hypokinesia, rigidity and tremor.

Though DA can stimulate vascular adrenergic receptors as well, rise in BP is not seen. Instead, postural hypotension is quite common. This may be a central action—DA and NA formed in the brain decrease sympathetic outflow; also DA formed in autonomic ganglia can impede ganglionic transmission.

Gradual tolerance develops to both cardiac stimulant and hypotensive actions.

3. CTZ Dopaminergic receptors are present in this area and DA acts as an excitatory transmitter. The DA formed peripherally gains access to the CTZ without hindrance—elicits nausea and vomiting. Tolerance occurs gradually to this action.

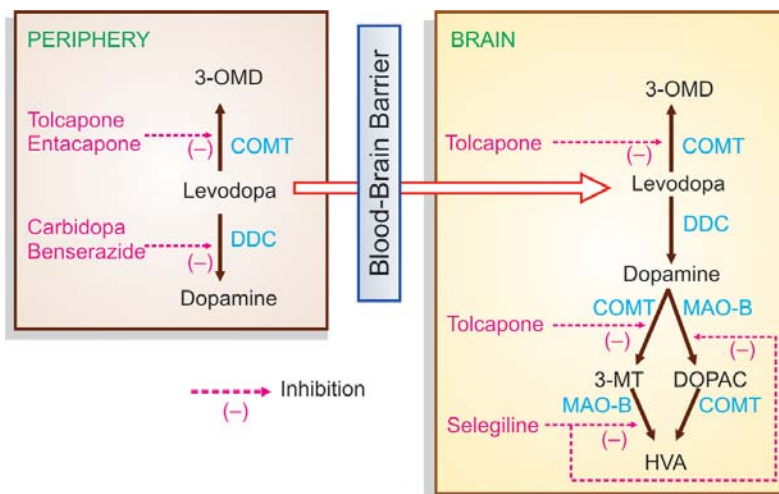

Fig. 31.2: Metabolic pathways of levodopa in the periphery and the brain.

3-OMD—3-O-methyldopa; COMT—Catechol-O-methyl transferase; MAO—monoamine oxidase; 3-MT—3-methoxytyramine; DOPAC—3,4 dihydroxy phenylacetic acid; HVA—Homovanillic acid (3-methoxy-4-hydroxy phenylacetic acid), DDC—Dopa decarboxylase

4. Endocrine DA acts on pituitary mammatropes to inhibit prolactin release and on somatotropes to increase GH release. Though prolactin levels in blood fall during levodopa therapy, increased GH levels are not noted in parkinsonian patients. Probably the mechanisms regulating GH secretion are altered in these patients.

PHARMACOKINETICS

Levodopa is rapidly absorbed from the small intestines by utilizing the active transport process meant for aromatic amino acids. Bioavailability of levodopa is affected by:

- (i) Gastric emptying: if slow, levodopa is exposed to degrading enzymes present in gut wall and liver for a longer time—less is available to penetrate blood-brain barrier.
- (ii) Amino acids present in food compete for the same carrier for absorption: blood levels are lower when taken with meals.

Levodopa undergoes high first pass metabolism in g.i. mucosa and liver. The peripheral and central pathway of metabolism of levodopa is depicted in Fig. 31.2.

About 1% of administered levodopa that enters brain, aided by amino acid carrier mediated active transport across brain capillaries, also undergoes the same transformation. The plasma $t_{1/2}$ of levodopa is 1–2 hours. Pyridoxal is a cofactor for the enzyme dopa-decarboxylase. The metabolites are excreted in urine mostly after conjugation.

ADVERSE EFFECTS

Side effects of levodopa therapy are frequent and often troublesome. Most are dose-related and limit the dose that can be administered, but are usually reversible. Some are prominent in the beginning of therapy while others appear late.

At the initiation of therapy These can be minimized by starting with a low dose.

1. *Nausea and vomiting* It occurs in almost every patient. Tolerance gradually develops and then the dose can be progressively increased.
2. *Postural hypotension* It occurs in about 1/3 of patients, but is mostly asymptomatic; some patients experience dizziness, few have fainting

attacks; more common in patients receiving antihypertensives. Tolerance develops with continued treatment and BP normalizes.

3. *Cardiac arrhythmias* } Due to β adrenergic action of peripherally formed DA;
4. *Exacerbation of angina* } more in patients with pre-existing heart disease.
5. *Alteration in taste sensation*

After prolonged therapy

1. *Abnormal movements* Facial tics, grimacing, tongue thrusting, choreoathetoid movements of limbs start appearing after a few months of use of levodopa at optimum therapeutic dose and progress with time to include practically all patients. No tolerance develops to this adverse effect, but dose reduction decreases severity. Abnormal movements may become as disabling as the original disease itself—are the most important dose-limiting side effects.

2. *Behavioral effects* Range from mild anxiety, nightmares, etc. to severe depression, mania, hallucinations, mental confusion or frank psychosis. Excessive DA action in the limbic system is probably responsible (antidopaminergic drugs are antipsychotic).

3. *Fluctuation in motor performance* After 2–5 years of therapy, the level of control of parkinsonian symptomatology starts showing fluctuation. ‘End of dose’ deterioration (wearing off) which is initially gradual, develops into rapid ‘switches’ or ‘on-off’ effect. With time ‘all or none’ response develops, i.e. the patient is alternately well and disabled. Abnormal movements may jeopardise even the ‘on’ phase. This is probably a reflection of progression of the disorder: with progressive degeneration of DA neurones the ability to regulate storage and release of DA may be largely lost: DA is then synthesized in the striatum on a moment to moment basis resulting in rapid and unpredictable fluctuations in motor control. Dose fractionation and more frequent administration tends to diminish these for a time.

Cautious use is needed in elderly; patients with ischaemic heart disease; cerebrovascular, psychiatric, hepatic and renal disease; peptic ulcer; glaucoma, gout.

Dose: Start with 0.25 g BD after meals, gradually increase till adequate response is obtained. Usual dose is 2–3 g/day.

LEVOPA, BIDOPAL 0.5 g tab.

Interactions

1. Pyridoxine: Abolishes therapeutic effect by enhancing peripheral decarboxylation of levodopa; less is available to cross to the brain.
2. Phenothiazines, butyrophenones, metoclopramide reverse therapeutic effect of levodopa by blocking DA receptors. The antidopaminergic domperidone blocks levodopa induced nausea and vomiting without abolishing its antiparkinsonian effect, because domperidone does not cross blood-brain barrier. Reserpine abolishes levodopa action by preventing entry of DA into synaptic vesicles.
3. Nonselective MAO inhibitors: prevent degradation of peripherally synthesized DA and NA—hypertensive crisis can occur.
4. Antihypertensives: postural hypotension is accentuated, reduce their dose if levodopa is started.
5. Atropine, and other anticholinergic drugs have additive antiparkinsonian action with low doses of levodopa, but retard its absorption—more time is available for peripheral degradation—efficacy of levodopa may be reduced.

PERIPHERAL DECARBOXYLASE INHIBITORS

Carbidopa and *benserazide* are extracerebral dopa decarboxylase inhibitors; they do not penetrate blood-brain barrier and do not inhibit conversion of levodopa to DA in the brain. Administered along with levodopa, they increase its $t_{1/2}$ in the periphery and make more of it available to cross blood-brain barrier to reach its site of action.

Benefits of the combination are—

1. The plasma $t_{1/2}$ of levodopa is prolonged and its dose is reduced to approximately 1/4th.

2. Systemic concentration of DA is reduced, nausea and vomiting are not prominent—therapeutic doses of levodopa can be attained quickly.
3. Cardiac complications are minimized.
4. Pyridoxine reversal of levodopa effect does not occur.
5. 'On-off' effect is minimized since cerebral DA levels are more sustained.
6. Degree of improvement may be higher; some patients, not responding adequately to levodopa alone, also improve.

Problems not resolved or accentuated are—

1. Involuntary movements
2. Behavioral abnormalities
3. Postural hypotension.

Currently, levodopa is practically always used along with a decarboxylase inhibitor, except in patients who develop marked involuntary movements with the combination.

Combination of levodopa with carbidopa has been given the name 'Co-careldopa'.

Preparations and dose

	Carbidopa	Levodopa
	(per tab/cap)	
TIDOMET-LS, SYNDOPA-110,	10 mg	+ 100 mg
SINEMET, DUODOPA-110	10 mg	+ 100 mg
TIDOMET PLUS, SYNDOPA PLUS	25 mg	+ 100 mg
TIDOMET FORTE, SYNDOPA-275	25 mg	+ 250 mg
BENSPAR, MADOPAR: Benserazide	25 mg	+ levodopa
	100 mg	cap.

Usual daily maintenance dose of levodopa is 0.4–0.8 g along with 75–100 mg carbidopa or 100–200 mg benserazide, given in 3–4 divided doses. Therapy is started at a low dose and suitable preparations are chosen according to the needs of individual patients, increasing the dose as required.

DOPAMINERGIC AGONISTS

The DA agonists can act on striatal DA receptors even in advanced patients who have largely lost the capacity to synthesize, store and release DA from levodopa. Moreover, they are longer acting, can exert subtype selective activation of DA

receptors involved in parkinsonism and not share the concern expressed about levodopa of contributing to dopaminergic neuronal damage by oxidative metabolism.

Bromocriptine (see Ch. 17) It is an ergot derivative which acts as potent agonist on D₂, but as partial agonist or antagonist on D₁ receptors. Improvement in parkinsonian symptoms occurs within ½–1 hr of an oral dose of bromocriptine and lasts for 6–10 hours. If used alone, doses needed in parkinsonism are high, expensive and often produce intolerable side effects—vomiting, hallucinations, hypotension, nasal stuffiness, conjunctival injection. Marked fall in BP with the 'first dose' has occurred in some patients, especially those on antihypertensive medication.

In parkinsonism, bromocriptine is used only in late cases as a supplement to levodopa: starting with low doses (1.25 mg once at night) and gradually increasing as needed upto 5–10 mg thrice daily. It serves to improve control and smoothen 'end of dose' and 'on-off' fluctuations. Dyskinesias are less prominent with bromocriptine compared to levodopa.

PROCTINAL, SICRIPTIN, PARLODEL, 1.25, 2.5 mg tabs, ENCRIPIT 2.5, 5 mg tabs.

Ropinirole and Pramipexole These are two recently developed nonergoline, selective D₂/D₃ receptor agonists with negligible affinity for D₁ and nondopaminergic receptors. Pramipexole has relatively greater affinity for D₃ receptors. Therapeutic effect as supplementary drugs to levodopa in advanced cases of PD as well as side effect profile is similar to bromocriptine, but they are better tolerated with fewer g.i. symptoms. Consequently dose titration for maximum improvement can be achieved in 1–2 weeks, while the same may take several months with bromocriptine.

Ropinirole and pramipexole are now frequently used as monotherapy for early PD as well. Trials have found them to afford symptom relief comparable to levodopa. Fewer cases treated with ropinirole needed supplemental

levodopa than those treated with bromocriptine. The Parkinson Study Group and other multicentric trials have noted lower incidence of dyskinesias and motor fluctuations among patients treated with these drugs than those treated with levodopa. There is some indirect evidence that use of these DA agonists may be associated with slower rate of neuronal degeneration. Such encouraging findings indicate that the newer DA agonists are effective alternatives to levodopa and afford longer symptom-free life to PD patients.

Ropinirole is rapidly absorbed orally, 40% plasma protein bound, extensively metabolized, mainly by hepatic CYP1A2, to inactive metabolites, and eliminated with a terminal $t_{1/2}$ of 6 hrs. It is thus longer acting than levodopa, useful in the management of motor fluctuations and reducing frequency of on-off effect.

Side-effects are nausea, dizziness, hallucinations, and postural hypotension. Episodes of day time sleep have been noted with ropinirole as well as pramipexole. The higher incidence of hallucinations and sleepiness may disfavour their use in the elderly.

Ropinirole has recently been approved for use in 'restless leg syndrome'.

Ropinirole: Starting dose is 0.25 mg TDS, titrated to a maximum of 4–8 mg TDS. Early cases generally require 1–2 mg TDS.

ROPITOR 0.25, 0.5, 1.0, 2.0 mg tabs. ROPITOR, ROPARK, ROPEWAY 0.25, 0.5, 1.0, 2.0 mg tabs.

Pramipexole: Starting dose 0.125 mg TDS, titrate to 0.5–1.5 mg TDS.

Pergolide (bromocriptine-like) and *Piribedil* (apomorphine-like) are other DA agonists used in parkinsonism.

MAO-B INHIBITOR

Selegiline (Deprenyl) It is a selective and irreversible MAO-B inhibitor. Two isoenzyme forms of MAO, termed MAO-A and MAO-B are recognized; both are present in peripheral adrenergic structures and intestinal mucosa, while the latter predominates in the brain and

blood platelets. Unlike nonselective MAO inhibitors, selegiline in low doses (10 mg/day) does not interfere with peripheral metabolism of dietary amines; CA accumulation and hypertensive reaction does not develop, while intracerebral degradation of DA is retarded. This is responsible for the therapeutic effect in parkinsonism. Higher doses can produce hypertensive interactions.

Selegiline alone has mild antiparkinsonian action in early cases. Administered with levodopa, it prolongs levodopa action, attenuates motor fluctuations and decreases 'wearing off' effect. As an adjuvant to levodopa, it is beneficial in 50–70% patients and permits 20–30% reduction in levodopa dose. However, advanced cases with 'on-off' effect are not improved and the peak dose levodopa side effects such as dyskinesias, mental confusion or hallucinations may be worsened. Moreover, clinical benefits derived from selegiline are short lived (6–26 months).

Based on the hypothesis that oxidation of DA and/or environmental toxins (MPTP-like) in the striatum by MAO to free radicals was causative in parkinsonism, it was proposed that early therapy with selegiline might delay progression of the disorder. However, no difference in the course of the disease has been detected on follow up of selegiline treated patients in large multicentric studies.

Adverse effects Postural hypotension, nausea, confusion, accentuation of levodopa induced involuntary movements and psychosis.

Contraindicated in patients with convulsive disorders.

Selegiline interacts with pethidine causing excitement, rigidity, hyperthermia, respiratory depression. It may also interact with tricyclic antidepressants and selective serotonin reuptake inhibitors.

ELDEPRYL 5, 10 mg tab; SELERIN, SELGIN 5 mg tab; Dose: 5 mg with breakfast and with lunch, either alone (in early cases) or with levodopa/carbidopa. Reduce by 1/4th levodopa dose after 2–3 days of adding selegiline.

COMT INHIBITORS

Two selective, potent and reversible COMT inhibitors *Entacapone* and *Tolcapone* have been introduced as adjuvants to levodopa-carbidopa for advanced PD. When peripheral decarboxylation of levodopa is blocked by carbidopa/benserazide, it is mainly metabolized by COMT to 3-O-methyldopa (see Fig. 31.2). Blockade of this pathway by entacapone/tolcapone prolongs the $t_{1/2}$ of levodopa and allows a larger fraction of administered dose to cross to brain. Since COMT plays a role in the degradation of DA in brain as well, COMT inhibitors could preserve DA formed in the striatum and supplement the peripheral effect. However, entacapone acts only in the periphery (probably because of short duration of action ~2 hr). For tolcapone also, the central action is less important.

Both entacapone and tolcapone enhance and prolong the therapeutic effect of levodopa-carbidopa in advanced and fluctuating PD. They may be used to smoothen 'wearing off', increase 'on' time, decrease 'off' time, improve activities of daily living and allow levodopa dose to be reduced. They are not indicated in early PD cases. *Entacapone*: 200 mg with each dose of levodopa-carbidopa.

Tolcapone: 100–200 mg BD or TDS.

Worsening of levodopa adverse effects such as nausea, vomiting, dyskinesia, postural hypotension, hallucinations, etc. occurs often when a COMT inhibitor is added. However, this can be minimised by adjustment of levodopa dose. Other prominent side effect is diarrhoea in 10–18% patients (less with entacapone) and yellow-orange discoloration of urine. Because of reports of acute fatal hepatitis and rhabdomyolysis, tolcapone has been suspended in Europe and Canada, while in USA its use is allowed only in those not responding to entacapone. Entacapone is not hepatotoxic.

DOPAMINE FACILITATOR

Amantadine Developed as an antiviral drug for prophylaxis of influenza A₂, it was found serendipitously to benefit parkinsonism. It acts rapidly but has lower efficacy than levodopa, though higher than anticholinergics. About 2/3rd patients derive some benefit. However, tolerance develops over months and the efficacy is lost. Amantadine appears to act by promoting presynaptic synthesis and release of DA in brain. Action on NMDA type of glutamate receptors, through which the striatal dopaminergic system exerts its influence is now considered to be more important.

Amantadine can be used in milder cases, or in short courses to supplement levodopa for advanced cases. In the latter situation, it serves to suppress motor fluctuations and abnormal movements. Fixed dose of 100 mg BD is used (not titrated according to response). Effect of a single dose lasts 8–12 hours;

AMANTREL, COMANTREL 100 mg tab.

Side effects These are generally not serious: insomnia, dizziness, confusion, nightmares, anticholinergic effects and rarely hallucinations. A characteristic side effect due to local release of CAs resulting in vasoconstriction is *livedo reticularis* and edema of ankles.

Side effects are accentuated when it is combined with anticholinergics.

CENTRAL ANTICHOLINERGICS

These are drugs having a higher central : peripheral anticholinergic action ratio than atropine, but the pharmacological profile is similar to it. In addition, certain H₁ antihistaminics have significant central anticholinergic property. There is little to choose clinically among these drugs, though individual preferences vary.

They act by reducing the unbalanced cholinergic activity in the striatum of parkinsonian patients. All anticholinergics produce 10–25% improvement in clinical features, lasting 4–8 hours after a single dose. Generally, tremor is benefited more than rigidity; hypokinesia is affected the least. Sialorrhoea is controlled by their peripheral action. The overall efficacy is much lower than levodopa. However, they are cheap and produce less side effects than levodopa. They may be used alone in mild cases and when levodopa is contraindicated. In others, they can be combined with levodopa in an attempt to lower its dose.

Anticholinergics are the only drugs effective in drug (phenothiazine) induced parkinsonism.

The side effect profile is similar to atropine. Impairment of memory and organic confusional states are more common in the elderly. The antihistaminics are less efficacious than

anticholinergics, but are better tolerated by older patients. Their sedative action also helps. Orphenadrine has mild euphoriant action.

Trihexyphenidyl It is the most commonly used drug. Start with the lowest dose in 2–3 divided portions per day and gradually increase till side effects are tolerated.

1. Trihexyphenidyl (benzhexol): 2–10 mg/day; **PACITANE, PARBENZ 2 mg tab.**
2. Procyclidine: 5–20 mg/day; **KEMADRIN 2.5, 5 mg tab.**
3. Biperiden: 2–10 mg/day oral, i.m. or i.v.: **DYSKINON 2 mg tab., 5 mg/ml inj.**
4. Orphenadrine: 100–300 mg/day; **DISIPAL, ORPHIPAL 50 mg tab.**
5. Promethazine: 25–75 mg/day; **PHENERGAN 10, 25 mg tab.**

Some general points

1. None of the above drugs alter the basic pathology of PD—the disease continues to progress. Drugs only provide symptomatic relief and give most patients an additional 3–6 years of happier and productive life.

Considering that oxidative metabolism of DA generates free radicals which may rather hasten degeneration of nigrostriatal neurones, it has been argued that levodopa therapy might accelerate progression of PD. There is no proof yet for such a happening, but nevertheless it may justify use of anticholinergics/selegiline or newer direct DA agonists in early/mild cases.

2. Initially, when disease is mild, only anticholinergics or selegiline may be sufficient. Monotherapy with newer DA agonists ropinirole or pramipexole is being increasingly employed for early cases. Selegiline may also be combined with levodopa during the deterioration phase of therapy to overcome ‘wearing off’ effect.

3. Combination of levodopa with a decarboxylase inhibitor is the standard therapy, and has replaced levodopa alone. Slow and careful initiation over 2–3 months, increasing the dose

as tolerance to early side effects develops and then maintenance at this level with frequent evaluation gives the best results. Full benefit lasts for about 2–3 years, then starts declining.

4. Subsequently the duration of benefit from a levodopa dose progressively shortens—end of dose ‘wearing off’ effect is seen. Dyskinesias appear, mostly coinciding with the peak of levodopa action after each dose. Relief of parkinsonian symptoms gets linked to the production of dyskinesias. Still later (4–8 years) the ‘on-off’ phenomena and marked dyskinesias may become so prominent that the patient is as incapacitated with the drug as without it. However, withdrawal of levodopa may precipitate marked rigidity, hampering even respiratory excursions.

5. Combination of levodopa with decarboxylase inhibitor increases efficacy and reduces early but not late complications.

6. Levodopa alone is now used only in those patients who develop intolerable dyskinesias with a levodopa-decarboxylase inhibitor combination.

7. Amantadine may be used with levodopa for brief periods during exacerbations.

8. The direct DA agonists bromocriptine or ropinirole/pramipexole are commonly used to supplement levodopa in late cases to smoothen ‘on off’ phenomenon, to reduce levodopa dose and possibly limit dyskinesias.

9. In advanced cases, the COMT inhibitor entacapone may be added to levodopa-carbidopa to prolong its action and subdue ‘on off’ fluctuation. It can be given to patients receiving selegiline or DA agonists as well.

10. Withdrawal of levodopa for 4–21 days (drug holiday) to reestablish striatal sensitivity to DA by increasing dopaminergic receptor population has now been given up.

CHAPTER 32

Drugs Used in Mental Illness: Antipsychotic and Antimanic Drugs



The psychopharmacological agents or psychotropic drugs are those having primary effects on *psyche* (mental processes) and are used for treatment of psychiatric disorders.

During the past 50 years psychiatric treatment has witnessed major changes due to advent of drugs which can have specific salutary effect in mental illnesses. The trend has turned from custodial care towards restoring the individual patient to his place in the community. All that could be done before 1952 was to dope and quieten agitated and violent patients. The introduction of *chlorpromazine* (CPZ) in that year has transformed the lives of schizophrenics; most can now be rehabilitated to productive life. *Reserpine* was discovered soon after. Though it is a powerful pharmacological tool to study monoaminergic systems in brain and periphery, its clinical use in psychiatry lasted only few years. Next came the *tricyclic* and *MAO inhibitor antidepressants* in 1957–58 and covered another group of psychiatric patients. Many novel and atypical antipsychotics and antidepressants have been introduced since the 1980s. Meproamate (1954) aroused the hope that anxiety could be tackled without producing marked sedation. This goal has been realised more completely by the development of *Chlordiazepoxide* (1957) and other *benzodiazepines* in the 1960s. *Buspirone* is a significant recent addition.

Little attention was paid to Cade's report in 1949 that *Lithium* could be used for excitement and mania: its effective use started in the 1960s and now it has a unique place in psychiatry. Interestingly some antiepileptics like carbamazepine, valproate and lamotrigine, etc. have shown promise in mania and bipolar disorders.

Psychiatric diagnostic categories are often imprecise. The criteria adopted overlap in individual patients. Nevertheless, broad divisions have to be made, primarily on the basis of predominant manifestations, to guide the use of drugs. It is important to make an attempt to characterise the primary abnormality, because specific drugs are now available for most categories. Principal types are:

Psychoses These are severe psychiatric illness with serious distortion of thought, behaviour, capacity to recognise reality and of perception (delusions and hallucinations). There is inexplicable misperception and misevaluation; the patient is unable to meet the ordinary demands of life.

(a) *Acute and chronic organic brain syndromes (cognitive disorders)* Such as delirium and dementia; some toxic or pathological basis can often be defined; prominent features are confusion, disorientation, defective memory and disorganized behaviour.

(b) *Functional disorders* No underlying cause can be defined; memory and orientation are mostly retained but emotion, thought, reasoning and behaviour are seriously altered.

(i) *Schizophrenia* (split mind), i.e. splitting of perception and interpretation from reality—hallucinations, inability to think coherently.

(ii) *Paranoid states* with marked persecutory or other kinds of fixed delusions (false beliefs) and loss of insight into the abnormality.

Affective disorders The primary symptom is change in mood state; may manifest as:

Mania—elation or irritable mood, reduced sleep, hyperactivity, uncontrollable thought and speech, may be associated with reckless or violent behaviour, or

Depression—sadness, loss of interest and pleasure, worthlessness, guilt, physical and mental slowing, melancholia, self-destructive ideation.

It may be bipolar (manic-depressive) with cyclically alternating manic and depressive phases or unipolar (mania or depression) with waxing and waning course.

Neuroses These are less serious; ability to comprehend reality is not lost, though the patient may undergo extreme suffering. Depending on the predominant feature, it may be labelled as:

(a) *Anxiety* An unpleasant emotional state associated with uneasiness, worry, tension and concern for the future.

(b) *Phobic states* Fear of the unknown or of some specific objects, person or situations.

(c) *Obsessive-compulsive* Limited abnormality of thought or behaviour; recurrent intrusive thoughts or ritual-like behaviours which the patient realizes are abnormal or stupid, but is not able to overcome even on voluntary effort.

(d) *Reactive depression* due to physical illness, loss, blow to self-esteem or bereavement, but is excessive or disproportionate.

(e) *Post-traumatic stress disorder* Varied symptoms following distressing experiences like war, riots, earthquakes, etc.

(f) *Hysterical* Dramatic symptoms resembling serious physical illness, but situational, and always in the presence of others; the patient does not feign but actually undergoes the symptoms, though the basis is only psychic and not physical.

Pathophysiology of mental illness is not clear, though some ideas have been formed, e.g. dopaminergic overactivity in the limbic system may be involved in schizophrenia and mania, while monoaminergic (NA, 5-HT) deficit may underlie depression. Treatment is empirical, symptom oriented and not disease specific. However, it is highly effective in many situations. Depending on the primary use, the psychotropic drugs may be grouped into:

1. **Antipsychotic** (neuroleptic, ataractic, major tranquillizer) useful in all types of functional psychosis, especially schizophrenia.

(The term 'Neuroleptic' is applied to chlorpromazine/haloperidol-like conventional antipsychotic drugs which have potent D2 receptor blocking activity and produce psychic indifference, emotional quietening with extrapyramidal symptoms, but without causing ataxia or cognitive impairment.)

2. **Antimanic** (mood stabiliser) used to control mania and to break into cyclic affective disorders.

3. **Antidepressants** used for minor as well as major depressive illness, phobic states, obsessive-compulsive behaviour, and certain anxiety disorders.

4. **Antianxiety** (anxiolytic-sedative, minor tranquillizer) used for anxiety and phobic states. Antidepressants and antimanic drugs are sometimes collectively referred as '*Drugs for Affective Disorders*'.

5. **Psychotomimetic** (psychedelic, psychodysleptic, hallucinogen). These are seldom used therapeutically, but produce psychosis-like states; majority are drugs of abuse, e.g. cannabis, LSD.

Tranquillizer It is an old term meaning "a drug which reduces mental tension and produces calmness without inducing sleep or depressing mental faculties." It was used to describe the effects of reserpine or chlorpromazine. However, it has been interpreted differently by different people; some extend it to cover both chlorpromazine-like and antianxiety drugs, others feel that it should be restricted to the antianxiety drugs only. Their division into *major* and *minor* tranquillizers is not justified, because the '*minor* tranquillizers' are not less important drugs: they are more frequently prescribed and carry higher abuse liability than the '*major* tranquillizers'. The term tranquillizer is, therefore, best avoided.

ANTIPSYCHOTIC DRUGS (Neuroleptics)

These are drugs having a salutary therapeutic effect in psychoses.

CLASSIFICATION

1. **Phenothiazines**

<i>Aliphatic side chain:</i>	Chlorpromazine Triflupromazine
<i>Piperidine side chain:</i>	Thioridazine
<i>Piperazine side chain:</i>	Trifluoperazine Fluphenazine

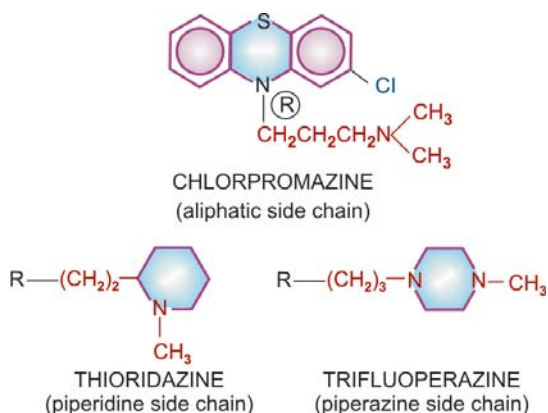

2. Butyrophenones

Haloperidol
Trifluoperidol
Penfluridol

3. Thioxanthenes

Flupenthixol

4. Other heterocyclics

Pimozide, Loxapine

5. Atypical

antipsychotics

Clozapine
Risperidone
Olanzapine
Quetiapine
Aripiprazole
Ziprasidone

Many more drugs have been marketed in other countries but do not deserve special mention. Pharmacology of chlorpromazine (CPZ) is described as prototype; others only as they differ from it. Their comparative features are presented in Table 32.1.

PHARMACOLOGICAL ACTIONS

1. CNS Effects differ in normal and psychotic individuals.

In normal individuals CPZ produces indifference to surroundings, paucity of thought, psychomotor slowing, emotional quietening, reduction in initiative and tendency to go off to sleep from which the subject is easily arousable. Spontaneous movements are minimized but slurring of speech, ataxia or motor incoordination does not occur. This has been referred to as the 'neuro-

leptic syndrome' and is quite different from the sedative action of barbiturates and other similar drugs. The effects are appreciated as 'neutral' or 'unpleasant' by most normal individuals.

In a psychotic CPZ reduces irrational behaviour, agitation and aggressiveness and controls psychotic symptomatology. Disturbed thought and behaviour are gradually normalized, anxiety is relieved. Hyperactivity, hallucinations and delusions are suppressed.

All phenothiazines, thioxanthenes and butyrophenones have the same antipsychotic efficacy, but potency differs in terms of equieffective doses. The aliphatic and piperidine side chain phenothiazines (CPZ, trifluoperazine, thioridazine) have low potency, produce more sedation and cause greater potentiation of hypnotics, opioids, etc. The sedative effect is produced promptly, while antipsychotic effect takes weeks to develop. Moreover, tolerance develops to the sedative but not to the antipsychotic effect. Thus, the two appear to be independent actions.

Performance and intelligence are relatively unaffected, but vigilance is impaired. Extrapyramidal motor disturbances (*see* adverse effects) are intimately linked to the antipsychotic effect, but are more prominent in the high potency compounds and least in thioridazine, clozapine and other atypical antipsychotics. A predominance of lower frequency waves occurs in EEG and arousal response is dampened. However, no consistent effect on sleep architecture has been noted. The disturbed sleep pattern in a psychotic is normalized.

Chlorpromazine lowers seizure threshold and can precipitate fits in untreated epileptics. The piperazine side chain compounds have a lower propensity for this action. Temperature control is knocked off at relatively higher doses rendering the individual poikilothermic—body temperature falls if surroundings are cold. The medullary respiratory and other vital centres are not affected, except at very high doses. It is very difficult to produce coma with these drugs. Neuroleptics, except thioridazine, have potent

antiemetic action exerted through the CTZ. However, they are ineffective in motion sickness.

In animals, neuroleptics selectively inhibit 'conditioned avoidance response' (CAR) without blocking the unconditioned response to a noxious stimulus. This action has shown good correlation with the antipsychotic potency of different compounds, though it may be based on a different facet of action. In animals, a state of rigidity and immobility (catalepsy) is produced which resembles the bradykinesia seen clinically.

Mechanism of action All antipsychotics (except clozapine-like atypical) have potent dopamine D2 receptor blocking action; antipsychotic potency has shown good correlation with their capacity to bind to D2 receptor. Phenothiazines and thioxanthenes also block D1, D3 and D4 receptors, but there is no correlation with antipsychotic potency. Blockade of dopaminergic projections to the temporal and prefrontal areas constituting the 'limbic system' and in mesocortical areas is probably responsible for the antipsychotic action. This along with the observation that drugs which increase DA activity (amphetamines, levodopa, bromocriptine) induce or exacerbate schizophrenia has given rise to the 'Dopamine theory of Schizophrenia' envisaging DA overactivity in limbic area to be responsible for the condition. As an adaptive change to blockade of D2 receptors, the firing of DA neurones and DA turnover increases initially. However, over a period of time this subsides and gives way to diminished activity, especially in the basal ganglia—corresponds to emergence of parkinsonian side effect. Tolerance to DA turnover enhancing effect of antipsychotics is not prominent in the limbic area—may account for the continued antipsychotic effect.

The above model fails to explain the antipsychotic activity of clozapine and other atypical antipsychotics which have weak D2 blocking action. However, they have significant 5-HT₂ and α_1 blocking action, and some are relatively selective for D4 receptors. Thus, antipsychotic property may depend on a specific profile of action of the drugs on several neurotransmitter receptors. Recent positron emission tomography (PET) studies of D2 and other receptor

occupancy in brains of antipsychotic treated patients have strengthened this concept.

Dopaminergic blockade in the basal ganglia appears to cause the extrapyramidal symptoms, while that in CTZ is responsible for antiemetic action.

2. ANS Neuroleptics have varying degrees of α adrenergic blocking activity which may be graded as:

CPZ = triflupromazine > thioridazine > clozapine > fluphenazine > haloperidol > trifluoperazine > pimozide, i.e. more potent compounds have lesser α blocking activity.

Anticholinergic property of neuroleptics is weak and may be graded as:

thioridazine > CPZ > triflupromazine > trifluoperazine = haloperidol.

The phenothiazines have weak H₁-antihistaminic and anti-5-HT actions as well.

3. Local anaesthetic Chlorpromazine is as potent a local anaesthetic as procaine. However, it is not used for this purpose because of its irritant action. Others have weaker membrane stabilizing action.

4. CVS Neuroleptics produce hypotension (primarily postural) by a central as well as peripheral action on sympathetic tone. The hypotensive action is more marked after parenteral administration and roughly parallels the α adrenergic blocking potency. Hypotension is not prominent in psychotic patients, but is accentuated by hypovolemia. Partial tolerance develops after chronic use. Reflex tachycardia accompanies hypotension.

High doses of CPZ directly depress the heart and produce ECG changes (Q-T prolongation and suppression of T wave). CPZ exerts some antiarrhythmic action, probably due to membrane stabilization. Arrhythmia may occur in overdose, especially with thioridazine.

5. Skeletal muscle Neuroleptics have no effect on muscle fibres or neuromuscular transmission. They reduce certain types of spasticity: the site of action being in the basal ganglia or

Table 32.1: Comparative properties and preparations of antipsychotic drugs

Drug	Antipsychotic dose (mg/day)	Relative activity			Preparations
		Extrapyramidal	Sedative	Hypotensive/Antiemetic	
1. Chlorpromazine	100–800	++	+++	++	CHLORPROMAZINE, LARGACTIL 10, 25, 50, 100 mg tab, 5 mg/5 ml (pediatric) & 25 mg/5 ml (adult) Syr., 50 mg/2 ml inj.
2. Triflupromazine	50–200	++±	+++	++	SIQUIL 10 mg tab; 10 mg/ml inj.
3. Thioridazine	100–400	+	+++	±	MELLERIL 25, 100 mg tab, THIORIL 10, 25, 50, 100 mg tab.
4. Trifluoperazine	2–20	+++	+	+++	TRINICALM 1, 5 mg tab, NEOCALM 5, 10 mg tab
5. Fluphenazine	1–10	+++	+	+++	ANATENSOL 1 mg tab, 0.5 mg/ml elixir.
6. Haloperidol	2–20	+++	+	+++	SERENACE 1.5, 5, 10, 20 mg tab; 2 mg/ml liq, 5 mg/ml inj., SENORM 1.5, 5, 10 mg tab, 5 mg/ml inj., HALOPIDOL 2, 5, 10, 20 mg tab, 2 mg/ml liq, 10 mg/ml drops
7. Trifluperidol	1–8	+++	+	+++	TRIPERIDOL 0.5 mg tab, 2.5 mg/ml inj.
8. Flupenthixol	3–15	+++	+	+	FLUANXOL 0.5, 1, 3 mg tab; FLUANXOL DEPOT 20 mg/ml in 1 and 2 ml amp.
9. Pimozide	2–6	+++	+	+	ORAP, NEURAP, PIMODAC 2, 4 mg tab.
10. Loxapine	20–100	++	+	+	LOXAPAC 10, 25, 50 mg caps, 25 mg/5 ml liquid
11. Clozapine	50–300	-	+++	-	LOZAPIN, SIZOPIN, SKIZORIL 25, 100 mg tabs
12. Risperidone	2–12	++	++	-	RESPIDON, SIZODON, RISPERDAL 1, 2, 3, 4 mg tabs.
13. Olanzapine	2.5–10	+	+	-	OLACE, OLANDUS 2.5, 5, 7.5, 10 mg tabs, OLZAP 5, 10 mg tab
14. Quetiapine	50–400	±	+++	-	QUEL, SOCALM, SEROQUIN 25, 100, 200 mg tabs
15. Aripiprazole	5–30	±	±	-	ARIPRA, ARILAN, BILIEF 10, 15 mg tabs; ARIVE 10, 15, 20, 30 mg tabs.
16. Ziprasidone	40–160	+	+	-	AZONA, ZIPSYDON 20, 40, 80 mg tabs.

medulla oblongata. Spinal reflexes are not affected.

6. Endocrine Neuroleptics consistently increase prolactin release by blocking the inhibitory action of DA on pituitary lactotropes. This may result in galactorrhoea and gynaecomastia.

They reduce gonadotropin secretion, but amenorrhoea and infertility occur only occasionally. ACTH release in response to stress is diminished—corticosteroid levels fail to increase under such circumstances. Release of GH is also reduced but this is not sufficient to cause growth retardation in children or to be beneficial in acromegaly. Decreased release of ADH may result in an increase in urine volume. A direct action on kidney tubules may add to it, but Na⁺ excretion is not affected.

Tolerance and dependence

Tolerance to the sedative and hypotensive actions develops within days or weeks, but maintenance doses in most psychotics remain fairly unchanged over years, despite increased DA turnover in the brain. The antipsychotic, extrapyramidal and other actions based on DA antagonism do not display tolerance.

Neuroleptics are hedonically (pleasurably) bland drugs. Physical dependence is probably absent, though some manifestations on discontinuation have been considered withdrawal phenomena. No drug seeking behaviour is exhibited.

PHARMACOKINETICS

Oral absorption of CPZ is somewhat unpredictable and bioavailability is low. More consistent effects are produced after i.m. or i.v. administration. It is highly bound to plasma as well as tissue proteins—brain concentration is higher than plasma concentration. Volume of distribution, therefore, is large (20 L/kg). It is metabolized in liver, mainly by CYP 2D6 into a number of metabolites.

The acute effects of a single dose generally last for 6–8 hours. The elimination $t_{1/2}$ is variable,

but mostly is in the range of 18–30 hours. The drug cumulates on chronic administration and it is possible to give the total maintenance dose once a day. Some metabolites are probably active. The intensity of antipsychotic action is poorly correlated with plasma concentration. Nevertheless, therapeutic effect may be seen at 30–200 ng/ml. The metabolites are excreted in urine and bile for months after discontinuing the drug.

The broad features of pharmacokinetics of other neuroleptics are similar.

DISTINCTIVE FEATURES OF NEUROLEPTICS

Antipsychotic drugs differ in potency and in their propensity to produce different effects. This is summarized in a comparative manner in Table 32.1.

1. Triflupromazine An aliphatic side chain phenothiazine, somewhat more potent than CPZ. Used mainly as antiemetic; it frequently produces acute muscle dystonias in children; especially when injected.

2. Thioridazine A low potency phenothiazine having marked central anticholinergic action. Incidence of extrapyramidal side effects is very low. Cardiac arrhythmias and interference with male sexual function are more common. Risk of eye damage limits long-term use.

3. Trifluoperazine, fluphenazine These are high potency piperazine side chain phenothiazines. They have minimum autonomic actions. Hypotension, sedation and lowering of seizure threshold are not significant. They are less likely to cause jaundice and hypersensitivity reactions. However, extrapyramidal side effects are marked.

Fluphenazine decanoate can be given as a depot i.m. injection every 2–4 weeks.

ANATENSOL DECANOATE, PROLINATE 25 mg/ml inj.

4. Haloperidol It is a potent antipsychotic with pharmacological profile resembling that of piperazine substituted phenothiazines. It produ-

ces few autonomic effects, is less epileptogenic, does not cause weight gain, jaundice is rare. It is the preferred drug for acute schizophrenia, Huntington's disease and Gilles de la Tourette's syndrome. Elimination $t_{1/2}$ averages 24 hours.

5. Trifluoperidol It is similar to but slightly more potent than haloperidol.

6. Penfluridol An exceptionally long acting neuroleptic, recommended for chronic schizophrenia, affective withdrawal and social maladjustment.

Dose: 20–60 mg (max 120 mg) once weekly; **SEMAP, FLUMAP, PENFLUR 20 mg tab.**

7. Flupenthixol It is less sedating than CPZ; indicated in schizophrenia and other psychoses, particularly in withdrawn and apathetic patients, but not in those with psychomotor agitation or mania. Infrequently used now.

8. Pimozide It is a specific DA antagonist with little α adrenergic or cholinergic blocking activity. Because of long duration of action (several days; elimination $t_{1/2}$ 48–60 hours) after a single oral dose, it is considered good for maintenance therapy but not when psychomotor agitation is prominent. Incidence of dystonic reactions is low, but it tends to prolong myocardial APD and carries risk of arrhythmias. It has been particularly used in Gilles de la Tourette's syndrome and ticks.

9. Loxapine A dibenzoxazepine having CPZ like DA blocking and antipsychotic activity. The actions are quick and short lasting ($t_{1/2}$ 8 hr). No clear cut advantage over other antipsychotics has emerged.

ATYPICAL ANTIPSYCHOTICS

These are newer (second generation) antipsychotics that have weak D2 blocking but potent 5-HT₂ antagonistic activity. Extrapyramidal side effects are minimal, and they may improve the impaired cognitive function in psychotics.

10. Clozapine An atypical antipsychotic; pharmacologically distinct from others in that it has

only weak D2 blocking action, produces few/no extrapyramidal symptoms; tardive dyskinesia is rare and prolactin level does not rise. It suppresses both positive and negative symptoms of schizophrenia and many patients refractory to typical neuroleptics respond. The differing pharmacological profile may be due to its relative selectivity for D4 receptors (which are sparse in basal ganglia) and additional 5-HT₂ as well as α blockade. It is quite sedating, moderately potent anticholinergic, but paradoxically induces hypersalivation. Significant H₁ blocking property is present.

Clozapine is metabolized primarily by CYP3A4 with an average $t_{1/2}$ of 12 hours. Its major limitation is higher incidence of agranulocytosis (0.8%) and other blood dyscrasias: weekly monitoring of leucocyte count is required. High dose can induce seizures even in nonepileptics. Other side effects are sedation, unstable BP, tachycardia, urinary incontinence, weight gain and precipitation of diabetes. Few cases of myocarditis have been reported which start like flu but may progress to death.

Clozapine is used as a reserve drug in resistant schizophrenia.

11. Risperidone Another compound whose antipsychotic activity has been ascribed to a combination of D2 + 5-HT₂ receptor blockade. In addition it has high affinity for α_1 , α_2 and H₁ receptors: blockade of these may contribute to efficacy as well as side effects like postural hypotension. However, BP can rise if it is used with selective serotonin reuptake inhibitors. Risperidone is more potent D2 blocker than clozapine; extrapyramidal side effects are less only at low doses (<6 mg/day). Prolactin levels rise during risperidone therapy, but it is less epileptogenic than clozapine, though frequently causes agitation. Caution has been issued about increased risk of stroke in the elderly.

12. Olanzapine This atypical antipsychotic; resembles clozapine in blocking multiple monoaminergic (D2, 5-HT₂, α_1 , α_2) as well as

muscarinic and H_1 receptors. Both positive and negative symptoms of schizophrenia appear to be benefited. A broader spectrum of efficacy covering schizo-affective disorders has been demonstrated, and it is approved for use in mania. Monotherapy with olanzapine may be as effective as a combination of lithium/valproate + benzodiazepines.

Olanzapine is a potent antimuscarinic, produces dry mouth and constipation. Weaker D2 blockade results in few extrapyramidal side effects and little rise in prolactin levels, but is more epileptogenic than high potency phenothiazines; causes weight gain and carries a higher risk of worsening diabetes. Incidence of stroke may be increased in the elderly. Agranulocytosis has not been reported with olanzapine. Olanzapine is metabolized by CYP1A2 and glucuronyl transferase. The $t_{1/2}$ is 24–30 hours.

13. Quetiapine This new short-acting ($t_{1/2}$ 6 hours) atypical antipsychotic requires twice daily dosing. It blocks 5-HT_{1A}, 5-HT₂, D2, α_1 , α_2 and H_1 receptors in the brain, but D2 blocking activity is low: extrapyramidal and hyperprolactinaemic side effects are minimal. However, it is quite sedating (sleepiness is a common side effect), and postural hypotension can occur, especially during dose titration. Urinary retention/incontinence are reported in few patients. Weight gain and rise in blood sugar are infrequent. Quetiapine has not been found to benefit negative symptoms of schizophrenia, but can be used in mania/bipolar disorder. It is metabolized mainly by CYP3A4; can interact with macrolides, antifungals, anticonvulsants, etc.

14. Aripiprazole This atypical antipsychotic is unique in being a partial agonist at D2 and 5-HT_{1A} receptor, but antagonist at 5-HT₂ receptor. It is minimally sedating, may even cause insomnia. Extrapyramidal side effects, hyperprolactinaemia, hypotension and Q-T prolongation are not significant. Little tendency to weight gain and rise in blood sugar has been noted. Frequent side effects are nausea, dyspepsia, constipation and light-headedness.

Aripiprazole is quite long-acting ($t_{1/2}$ ~ 3 days); dose adjustments should be done after 2 weeks treatment. It is metabolized by CYP3A4 as well as CYP2D6; dose needs to be halved in patients receiving ketoconazole or quinidine, and doubled in those taking carbamazepine. Aripiprazole is indicated in schizophrenia as well as mania and bipolar illness.

15. Ziprasidone It is the latest atypical antipsychotic with combined D2 + 5-HT_{2A/2C} + H_1 + α_1 blocking activity. Antagonistic action at 5-HT_{1D} + agonistic activity at 5-HT_{1A} receptors along with moderately potent inhibition of 5-HT and NA reuptake indicates some anxiolytic and antidepressant property as well. Like other atypical antipsychotics, ziprasidone has low propensity to cause extrapyramidal side effects or hyperprolactinaemia. It is mildly sedating, causes modest hypotension and little weight gain or blood sugar elevation. Nausea and vomiting are the common side effects. More importantly, a dose-related prolongation of Q-T interval occurs. It has the potential to induce serious cardiac arrhythmias, especially in the presence of predisposing factors/drugs.

The $t_{1/2}$ of ziprasidone is ~8 hours; needs twice daily dosing. In comparative trials, its efficacy in schizophrenia has been rated equivalent to haloperidol. It is also indicated in mania.

ADVERSE EFFECTS

Neuroleptics are very safe drugs in single or infrequent doses: deaths from overdose are almost unknown. However, side effects are common.

I. Based on pharmacological actions (dose related)

1. CNS Drowsiness, lethargy, mental confusion: more with low potency agents; tolerance develops; increased appetite and weight gain (not with haloperidol); aggravation of seizures in epileptics; even nonepileptics may develop seizures with high doses of some antipsychotics

like clozapine and olanzapine. However, potent phenothiazines risperidone, quetiapine, aripiprazole and ziprasidone have little effect on seizure threshold.

2. CVS Postural hypotension, palpitation, inhibition of ejaculation (especially with thioridazine) are due to α adrenergic blockade; more common with low potency phenothiazines. Q-T prolongation and cardiac arrhythmias are a risk of overdose with thioridazine, pimozide and ziprasidone.

3. Anticholinergic Dry mouth, blurring of vision, constipation, urinary hesitancy in elderly males (thioridazine has the highest propensity); absent in high potency agents. Some like clozapine induce hypersalivation despite anticholinergic property, probably due to central action.

4. Endocrine Hyperprolactinemia (due to D2 blockade) is common with typical neuroleptics and risperidone. This can lower Gn levels, but amenorrhoea, infertility, galactorrhoea and gynaecomastia occur infrequently after prolonged treatment. The atypical antipsychotics do not appreciably raise prolactin levels.

5. Extrapyramidal disturbances These are the major dose limiting side effects; more prominent with high potency drugs like fluphenazine, haloperidol, pimozide, etc., least with thioridazine, clozapine, and all other atypical antipsychotics, except high doses of risperidone. These are of following types.

(a) *Parkinsonism* with typical manifestations—rigidity, tremor, hypokinesia, mask like facies, shuffling gait; appears between 1–4 weeks of therapy and persists unless dose is reduced. If that is not possible, one of the anticholinergic antiparkinsonian drugs may be given concurrently. Though quite effective, routine combination of the anticholinergic from the start of therapy in all cases is not justified. Levodopa is not effective.

A rare form of extrapyramidal side effect is perioral tremors 'rabbit syndrome' that generally occurs after a few years of therapy. It often responds to central anticholinergic drugs.

(b) *Acute muscular dystonias* Bizarre muscle spasms, mostly involving linguo-facial muscles—grimacing, tongue thrusting, torticollis, locked jaw; occurs within a few hours of a single dose or at the most in the first week of therapy. It is more common in children below 10 years and in girls, particularly after parenteral administration; overall incidence is 2%. It lasts for one to few hours and then resolves spontaneously. One of the central anticholinergics, promethazine or hydroxyzine injected i.m. clears the reaction within 10–15 min.

(c) *Akathisia* Restlessness, feeling of discomfort, apparent agitation manifested as a compelling desire to move about, but without anxiety, is seen in some patients between 1–8 weeks of therapy: upto 20% incidence. It may be mistaken for exacerbation of psychosis. Mechanism of this complication is not understood; no specific antidote is available. A central anticholinergic may reduce the intensity in some cases; propranolol is more effective, but most cases require reduction of dose or an alternative antipsychotic. Addition of diazepam may help.

(d) *Malignant neuroleptic syndrome* It occurs rarely with high doses of potent agents; the patient develops marked rigidity, immobility, tremor, fever, semiconsciousness, fluctuating BP and heart rate; myoglobin may be present in blood—lasts 5–10 days after drug withdrawal and may be fatal. The neuroleptic must be stopped promptly and symptomatic treatment given. Though, antidopaminergic action of the neuroleptic may be involved in the causation of this syndrome; anticholinergics are of no help. Intravenous dantrolene may benefit. Bromocriptine in large doses has been found useful.

(e) *Tardive dyskinesia* It occurs late in therapy, sometimes even after withdrawal of the neuroleptic: manifests as purposeless involuntary facial and limb movements like constant chewing, pouting, puffing of cheeks, lip licking, choreoathetoid movements. It is more common in elderly women; probably a manifestation of

progressive neuronal degeneration along with supersensitivity to DA. It is accentuated by anticholinergics and temporarily suppressed by high doses of the neuroleptic (this should not be tried except in exceptional circumstances). An incidence of 10–20% has been reported after long term treatment; uncommon with clozapine and all other atypical antipsychotics. The dyskinesia may subside months or years after withdrawal of therapy or may be lifelong. There is no satisfactory solution of the problem.

6. Miscellaneous *Weight gain* often occurs with long term antipsychotic therapy; blood sugar and lipids may tend to rise. Risk of worsening of diabetes is more with clozapine and olanzapine, but minimal with haloperidol, aripiprazole and ziprasidone. *Blue pigmentation* of exposed skin, *corneal and lenticular opacities*, *retinal degeneration* (more with thioridazine) occur rarely after long-term use of high doses of phenothiazines.

II. Hypersensitivity reactions These are not dose related.

1. *Cholestatic jaundice* with portal infiltration; 2–4% incidence; occurs between 2–4 weeks of starting therapy. It calls for withdrawal of the drug—resolves slowly. More common with low potency phenothiazines; rare with haloperidol.

2. *Skin rashes, urticaria, contact dermatitis, photosensitivity* (more with CPZ).

3. *Agranulocytosis* is rare; more common with clozapine.

4. *Myocarditis* Few cases have occurred with clozapine.

INTERACTIONS

1. Neuroleptics potentiate all CNS depressants—hypnotics, anxiolytics, alcohol, opioids, antihistaminics and analgesics. Overdose symptoms may occur.

2. Neuroleptics block the actions of levodopa and direct DA agonists in parkinsonism.

3. Antihypertensive action of clonidine and methyl dopa is reduced, probably due to central α_2 adrenergic blockade.

4. Phenothiazines and others are poor enzyme inducers—no significant pharmacokinetic interactions. Enzyme inducers (barbiturates, anticonvulsants) can reduce blood levels of neuroleptics.

USES

1. Psychoses

Schizophrenia The antipsychotics are used primarily in functional psychoses: have indefinable but definite therapeutic effect in all forms: produce a wide range of symptom relief. They control positive symptoms (hallucinations, delusions, disorganized thought, restlessness, insomnia, anxiety, fighting, aggression) better than negative symptoms (apathy, loss of insight and volition, affective flattening, poverty of speech, social withdrawal). However, they tend to restore cognitive, affective and motor disturbances and help upto 90% patients to lead a near normal life in the society. But, some patients do not respond, and virtually none responds completely. They are only symptomatic treatment, do not remove the cause of illness; long-term (even life-long) treatment may be required. They cause little improvement in judgement, memory and orientation. Patients with recent onset of illness and acute exacerbations respond better.

Choice of drug is largely empirical, guided by the presenting symptoms (it is the target symptoms which respond rather than the illness as a whole), associated features and mood state, and on the type of side effect that is more acceptable in a particular patient. Individual patients differ in their response to different antipsychotics; there is no way to predict which patient will respond better to which drug. The following may help drug selection:

- Agitated, combative and violent—CPZ, thioridazine, haloperidol, quetiapine.
- Withdrawn and apathetic—trifluoperazine, fluphenazine, aripiprazole, ziprasidone.

- Patient with mainly negative symptoms and resistant cases—clozapine, olanzapine, risperidone, aripiprazole, ziprasidone (evidence of their higher efficacy is not firm).
- Patient with mood elevation, hypomania—haloperidol, fluphenazine, olanzapine.
- If extrapyramidal side effects must be avoided—thioridazine, clozapine or any other atypical antipsychotic.
- Elderly patients who are more prone to sedation, mental confusion and hypotension—a high potency phenothiazine, haloperidol, aripiprazole or ziprasidone.

Currently, the newer atypical antipsychotics are being more commonly prescribed. Though, there is no convincing evidence of higher efficacy, they produce fewer side effects and neurological complications. They are preferable for long-term use in chronic schizophrenia due to lower risk of tardive dyskinesia. Of the standard neuroleptics, the high potency agents are preferable over the older low potency ones.

Mania Antipsychotics are required for rapid control; CPZ or haloperidol may be given i.m.—act in 1–3 days; lithium or valproate may be started simultaneously or after the acute phase. After 1–3 weeks when lithium has taken effect, the neuroleptic may be withdrawn gradually. Recently, oral therapy with one of the atypical antipsychotics olanzapine/risperidone/aripiprazole/quetiapine is being preferred for cases not requiring urgent control.

Organic brain syndromes Neuroleptics are not very effective. May be used on a short-term basis—one of the potent drugs is preferred to avoid mental confusion, hypotension and precipitation of seizures.

The dose of antipsychotic drugs should be individualized by titration with the symptoms and kept at minimum. In chronic schizophrenia maximal therapeutic effect is seen after 2–4 months therapy. However, injected neuroleptics

control aggressive symptoms of acute schizophrenia over hours or a few days. Combination of 2 or more neuroleptics is not advantageous. However, a patient on maintenance therapy with a non-sedative drug may be given additional CPZ or haloperidol by i.m. injection to control exacerbations or violent behaviour.

In a depressed psychotic, a tricyclic anti-depressant may be combined. Benzodiazepines may be added for brief periods in the beginning.

Low dose maintenance or intermittent regimens of antipsychotics have been tried in relapsing cases. Depot injections, e.g. fluphenazine/haloperidol decanoate given at 2–4 week intervals are preferable in many cases.

2. Anxiety Neuroleptics relieve anxiety but should not be used for simple anxiety because of autonomic and extrapyramidal side effects: benzodiazepines are preferable. However, those not responding or having a psychotic basis for anxiety may be treated with a neuroleptic.

3. As antiemetic Neuroleptics are potent antiemetics—control a wide range of drug and disease induced vomiting at doses much lower than those needed in psychosis. However, they should not be given unless the cause of vomiting has been identified. They are effective in morning sickness but should not be used for this purpose. They are ineffective in motion sickness: probably because dopaminergic pathway through the CTZ is not involved in this condition.

4. Other uses

- (a) *To potentiate hypnotics, analgesics and anaesthetics* Justified only in anaesthetic practice.
- (b) *Intractable hiccough* may respond to parenteral CPZ.
- (c) *Tetanus* CPZ is a secondary drug to achieve skeletal muscle relaxation.
- (d) *Alcoholic hallucinosis, Huntington's disease and Gilles de la Tourette's syndrome* are rare indications.

ANTIMANIC (MOOD STABILIZING) DRUGS**LITHIUM CARBONATE**

Lithium is a small monovalent cation. In 1949, it was found to be sedative in animals and to exert beneficial effects in manic patients.

In the 1960s and 1970s the importance of maintaining a narrow range of serum lithium concentration was realized and unequivocal evidence of its efficacy was obtained. Lithium is a drug of its own kind to suppress mania and to exert a prophylactic effect in bipolar manic depressive illness (MDI) at doses which have no overt CNS effects. Lithium is established as the standard antimanic and mood stabilizing drug. Over the past 2 decades, several anticonvulsants and anti-psychotics have emerged as alternatives to lithium with comparable efficacy.

Actions and mechanism

1. **CNS** Lithium has practically no acute effects in normal individuals as well as in MDI patients. It is neither sedative nor euphoriant; but on prolonged administration, it acts as a mood

stabiliser in bipolar disorder. Given to patients in acute mania, it gradually suppresses the episode taking 1–2 weeks; continued treatment prevents cyclic mood changes. The markedly reduced sleep time in manic patients is normalized.

The mechanism of antimanic and mood stabilizing action of lithium is not known. It has been argued that:

(a) Li^+ partly replaces body Na^+ and is nearly equally distributed inside and outside the cells (contrast Na^+ and K^+); this may affect ionic fluxes across brain cells or modify the property of cellular membranes.

(b) Lithium has been found to decrease the release of NA and DA in the brain of treated animals without affecting 5-HT release. This may correct any imbalance in the turnover of brain monoamines.

(c) The above hypothesis cannot explain why Li^+ has no effect on people not suffering from mania.

An attractive hypothesis has been put forward based on the finding that lithium inhibits hydrolysis of inositol-1-phosphate by

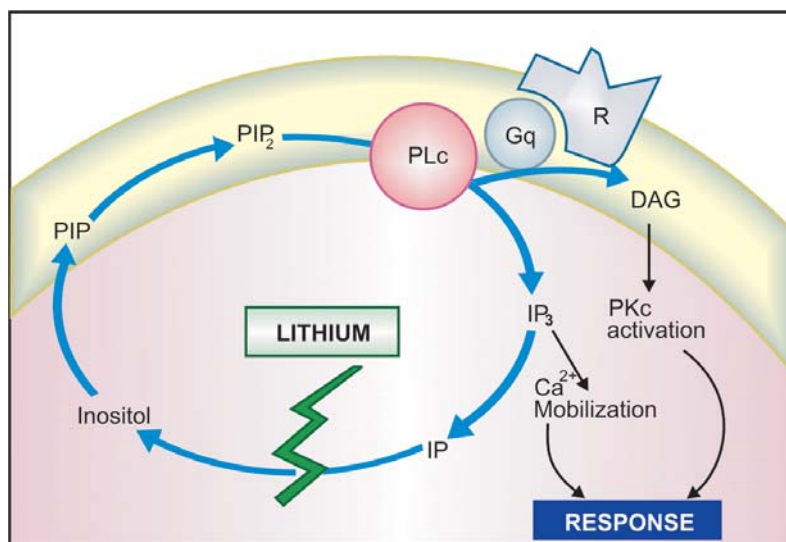

Fig. 32.1: Proposed mechanism of antimanic action of lithium

PIP—Phosphatidylinositol phosphate; PIP₂—Phosphatidylinositol bisphosphate; IP₃—Inositol trisphosphate; IP—Inositol-1-phosphate; PLc—Phospholipase C; DAG—Diacylglycerol; PKc—Protein Kinase C; Gq—Coupling Gq protein; R—Neurotransmitter receptor

inositol monophosphatase. As a result, the supply of free inositol for regeneration of membrane phosphatidyl-inositides, which are the source of IP_3 and DAG, is reduced (Fig. 32.1). The hyperactive neurones involved in the manic state may be preferentially affected, because supply of inositol from extracellular sources is meagre. Thus, lithium may ignore normally operating receptors, but 'search out' and selectively, though indirectly, dampen signal transduction in the overactive ones.

2. Other actions Lithium inhibits the action of ADH on distal tubules and causes a diabetes insipidus like state.

It has some insulin-like action on glucose metabolism.

Leukocyte count is increased by lithium therapy. Lithium reduces thyroxine synthesis by interfering with iodination of tyrosine.

Pharmacokinetics and control of therapy

Lithium is slowly but well absorbed orally and is neither protein bound nor metabolized. It first distributes in the extracellular water and then gradually enters cells and slowly penetrates into the CNS, ultimately attaining a rather uniform distribution in total body water; apparent volume of distribution at steady-state averages 0.8 L/kg.

Lithium is handled by the kidney in much the same way as Na^+ . Most of the filtered Li^+ is reabsorbed in the proximal convoluted tubule. When Na^+ is restricted, a larger fraction of filtered Na^+ is reabsorbed, so is Li^+ . After a single dose of Li^+ urinary excretion is rapid for 10–12 hours, followed by a much slower phase lasting several days. The $t_{1/2}$ of the latter phase is 16–30 hours. Renal clearance of lithium is 1/5 of creatinine clearance. On repeated medication steady-state plasma concentration is achieved in 5–7 days. Levels are higher in older patients and in those with renal insufficiency.

There is marked individual variation in the rate of lithium excretion. Thus, with the same daily dose, different individuals attain widely different

plasma concentrations. However, in an individual the clearance remains fairly constant. Since the margin of safety is narrow, monitoring of serum lithium concentration is essential for optimal therapy. Serum lithium level is measured 12 hours after the last dose to reflect the steady-state concentration; 0.5–0.8 mEq/L is considered optimum for maintenance therapy in bipolar disorder, while 0.8–1.1 mEq/L is required for episodes of mania. Toxicity symptoms occur frequently when serum levels exceed 1.5 mEq/L.

Peaks in plasma lithium level over and above the steady-state level occur after every dose. Divided daily dosing in 2–4 portions is needed to avoid high peaks. Lithium is excreted in sweat and saliva also. Lithium is secreted in breast milk. Mothers on lithium should not breastfeed.

Adverse effects Side effects are common, but are mostly tolerable. Toxicity occurs at levels only marginally higher than therapeutic levels.

1. Nausea, vomiting and mild diarrhoea occur initially, can be minimized by starting at lower doses.
2. Thirst and polyuria are experienced by most, some fluid retention may occur initially, but clears later.
3. Fine tremors and rarely seizures are seen even at therapeutic concentrations.
4. CNS toxicity manifests as plasma concentration rises—coarse tremors, giddiness, ataxia, motor incoordination, nystagmus, mental confusion, slurred speech, hyper-reflexia. Overdose symptoms are regularly seen at plasma concentration above 2 mEq/L. In acute intoxication these symptoms progress to muscle twitchings, drowsiness, delirium, coma and convulsions. Vomiting, severe diarrhoea, albuminuria, hypotension and cardiac arrhythmias are the other features.

Treatment It is symptomatic. There is no specific antidote. Osmotic diuretics and sod. bicarbonate infusion promote Li^+ excretion. Haemodialysis is indicated if serum levels are > 4 mEq/L.

5. On long-term use, some patients develop renal diabetes insipidus. Goiter has been reported in about 4%. This is due to interference with iodination of tyrosine → decreased thyroxine synthesis. However, hypothyroidism is rare. Thyroxine administration inhibits TSH and reverses thyroid enlargement.
6. Lithium is contraindicated during pregnancy: foetal goiter and other congenital abnormalities, especially cardiac, can occur; the newborn is often hypotonic.
7. Lithium is contraindicated in sick sinus syndrome.

Interactions

1. Diuretics (thiazide, furosemide) by causing Na^+ loss promote proximal tubular reabsorption of Na^+ as well as Li^+ → plasma levels of lithium rise.
2. Tetracyclines, NSAIDs and ACE inhibitors can also cause lithium retention.
3. Lithium reduces pressor response to NA.
4. Lithium tends to enhance insulin/sulfonylurea induced hypoglycaemia.
5. Succinylcholine and pancuronium have produced prolonged paralysis in lithium treated patients.
6. Neuroleptics, including haloperidol, have been frequently used along with lithium without problem; sometimes, the combination of haloperidol and lithium produces marked tremor and rigidity. The neuroleptic action appears to be potentiated by lithium.

Use

Lithium is used as its carbonate salt because this is less hygroscopic and less gastric irritant than LiCl or other salts. It is converted into chloride in the stomach.

LICAB, LITHOSUN 300 mg tab, 400 mg SR tab.

It is generally started at 600 mg/day and gradually increased to yield therapeutic plasma levels; mostly 600–1200 mg/day is required.

1. **Acute mania** (inappropriate cheerfulness or irritability, motor restlessness, nonstop

talking, flight of ideas, little need for sleep and progressive loss of contact with reality; sometimes violent behaviour): though lithium is effective, response is slow and control of plasma levels is difficult during the acute phase. Most prefer to use a neuroleptic, generally by i.m. route, with or without a potent BZD like clonazepam/lorazepam, and start lithium after the episode is under control. Maintenance lithium therapy is generally given for 6–12 months to prevent recurrences.

2. **Prophylaxis in bipolar disorder** Lithium has proven efficacy in bipolar disorder: is gradually introduced and maintained at plasma concentration between 0.5–0.8 mEq/L. Such treatment lengthens the interval between cycles of mood swings: episodes of mania as well as depression are attenuated, if not totally prevented. Bipolar disorder is the most common and definite indication of lithium. Risks and benefits of prolonged (almost indefinite) lithium therapy are to be weighed in individual cases. Patients have been maintained on lithium therapy for over a decade. Most cases relapse when lithium is discontinued. Withdrawal, when attempted should be gradual over months.

Recurrent *unipolar depression* also responds to lithium therapy. Combination of antidepressant + lithium is often used initially, and lithium alone is continued in the maintenance phase.

3. Lithium is being sporadically used in many other *recurrent neuropsychiatric illness*, cluster headache and as adjuvant to antidepressants in resistant nonbipolar *major depression*.

4. Cancer chemotherapy induced *leukopenia* and *agranulocytosis*: Lithium may hasten the recovery of leukocyte count.

5. *Inappropriate ADH secretion syndrome*: Lithium tends to counteract water retention, but is not dependable.

ALTERNATIVES TO LITHIUM

Approximately 50% patients of mania and bipolar disorder (especially rapidly cycling cases) show incomplete or poor response to lithium. Many do not tolerate it, or are at special risk of toxicity. Alternatives are:

1. **Carbamazepine** Soon after its introduction as antiepileptic, carbamazepine (CBZ) was found to prolong remission in bipolar disorder. Its efficacy in mania and bipolar disorder has now been confirmed and is rated almost equal to lithium. Patients who relapse on lithium therapy or those prone to rapid cycling of mood state do better on combined lithium + CBZ treatment. Since CBZ therapy is easier to manage and better tolerated than lithium, it is being increasingly used as firstline/adjunctive treatment for acute mania as well as bipolar illness. The dose and effective plasma concentration range is the same as for treatment of epilepsy. However, its efficacy in long-term prophylaxis of bipolar illness and suicides is less well established.

2. **Sodium valproate** A reduction in manic relapses is noted when valproate is used in bipolar disorder. It is now a first line treatment of acute mania in which high dose valproate acts faster and is an alternative to antipsychotic ± benzodiazepine. It can be useful in those not responding to lithium or not tolerating it. Patients with rapid cycling pattern may particularly benefit from valproate therapy. A combination of lithium and valproate may succeed in cases resistant to monotherapy with either drug. Valproate has a favourable tolerability profile. Dosage guidelines are the same as for epilepsy.

3. **Lamotrigine** This newer anticonvulsant is now an approved drug for bipolar disorder, but is not recommended for acute mania. It is especially useful in rapidly cycling bipolar depression. Randomized trials have demonstrated its efficacy, both as monotherapy as well as adjunctive to lithium. It carries minimal risk of inducing mania. The tolerability profile of lamotrigine is favourable.

4. **Topiramate** Few open studies have found it to be useful as adjunctive therapy of bipolar disorder, but efficacy needs to be established.

Gabapentin also has shown some prophylactic effect in bipolar disorder.

5. **Atypical antipsychotics:** Olanzapine, risperidone and newer atypical antipsychotics aripri-

prazole, quetiapine, with or without a BZD, are now the first line drugs for control of acute mania, except cases requiring urgent parenteral therapy, for which the older neuroleptics are still the most effective.

Olanzapine is also approved for maintenance therapy of bipolar disorder. Because it carries a low risk of inducing extrapyramidal side effects or agranulocytosis, it is being increasingly used as adjuvant/alternative to lithium for prophylaxis of cyclic mood swings. The usefulness of other atypical antipsychotics as prophylactic in bipolar illness is not established, but there are reports of beneficial effect.

HALLUCINOGENS

(Psychotomimetics, Psychedelics, Psychodysleptics, Psychotogens)

These are drugs which alter mood, behaviour, thought and perception in a manner similar to that seen in psychosis. Many natural products having hallucinogenic property have been discovered and used by man since prehistoric times. A number of synthetic compounds have also been produced. The important ones are briefly described below.

INDOLE AMINES

1. **Lysergic acid diethylamide (LSD)** Synthesized by Hofmann (1938) who was working on chemistry of ergot alkaloids, and himself experienced its hallucinogenic effect. It is the most potent psychedelic, 25–50 µg produces all the effects. In addition to the mental effects, it produces pronounced central sympathetic stimulation. Its action appears to involve serotonergic neuronal systems in brain.

2. **Lysergic acid amide** A close relative of LSD but 10 times less potent; found in morning glory (*Ipomoea violacea*) seeds.

3. **Psilocybin** Found in a Mexican mushroom *Psilocybe mexicana*; it has been used by Red Indian tribals during religious rituals.

4. **Harmine** It is present in a vine *Banisteriopsis caapi*, found in the Amazon region. The Brazilian natives have used it as a snuff.

5. Bufotenin Isolated from skin of a toad (*Bufo marinus*). It is also found in 'Cohaba Snuff' and in the mushroom *Amanita muscaria*.

The above are all *Indolealkylamines* related chemically to 5-HT. A number of other synthetic derivatives like Dimethyltryptamine (DMT) are also hallucinogenic.

PHENYLALKYLAMINES

Mescaline From Mexican 'Peyote cactus' *Lophophora williamsi*. It is a low potency hallucinogen used by natives during rituals. It is a phenylalkylamine but does not have marked sympathomimetic effects.

Ecstasy Methylene dioxy methamphetamine (MDMA) is an amphetamine-like synthetic compound with stimulant and hallucinogenic properties, that has been abused as a recreational and euphoriant drug, especially by college students under the name 'Ecstasy'. Fear of neurotoxicity has reduced its popularity.

Other synthetic phenylalkylamines with hallucinogenic property are—Dimethoxymethyl amphetamine (DOM) and Methylene dioxyamphetamine (MDA). High doses and repeated use of amphetamine can also cause psychosis.

ARYLCYCLOHEXYL AMINES

Phencyclidine It is an anticholinergic, which activates σ receptors in brain causing disorientation, distortion of body image, hallucinations and an anaesthetic like state: ketamine is a closely related compound with lower hallucinogenic potential and is used in anaesthesia.

CANNABINOIDS

$^9\Delta$ Tetrahydrocannabinol ($^9\Delta$ THC) It is the active principle of *Cannabis indica* (Marijuana). It has been the most popular recreational and ritualistic intoxicant used for millennia. Its use has spread world wide. The following are the various forms in which it is used.

Bhang the dried leaves—is generally taken by oral route, acts slowly.

Ganja the dried female inflorescence—is more potent and is smoked: effects are produced almost instantaneously.

Charas is the dried resinous extract from the flowering tops and leaves—most potent, smoked with tobacco; also called 'hashish'.

Cannabis is the drug of abuse having lowest acute toxicity.

Considerable insight has been obtained recently in cannabinoid pharmacology. Since 1990 two *cannabinoid*

receptors CB1 (in CNS) and CB2 (in peripheral tissues) have been identified and cloned. A host of endogenous ligands for the cannabinoid receptors have also been isolated. *Anandamide* the ethanolamide of arachidonic acid is the principal endocannabinoid synthesized in the brain. Endocannabinoids are released by macrophages during haemorrhagic shock and cause fall in BP. However, all actions of cannabis are not mimicked by anandamide.

Cannabis produces potent analgesic, antiemetic, anti-inflammatory and many other pharmacological actions. The crude herb, its active constituents and some synthetic analogues have been tried in a variety of conditions and many potential clinical applications are proposed.

- To ameliorate muscle spasm and pain in multiple sclerosis, and certain dystonias.
- Cancer chemotherapy induced vomiting: the synthetic cannabinoids nabilone and dronabinol are licenced for this use.
- As a neuronal protective after head injury and cerebral ischaemia.
- To relieve anxiety; migraine.
- To reduce i.o.t. in glaucoma.
- As appetite stimulant.
- As bronchodilator in asthma.

However, the hallucinogenic and psychomotor effects are a limitation; nonhallucinogenic congeners are being investigated.

The hallucinogens, in general, produce a dream-like state with disorientation, loss of contact with reality, field of vision may appear to sway and objects distorted like images in a curved mirror, faces may appear grotesque. On closing the eyes an unending series of colourful, very realistic and fantastic images appear to surge; time sense is altered, music appears tangible. Ability to concentrate is impaired, one can read but does not know what he is reading; however, ataxia is not prominent. Many feel relaxed and supremely happy, may laugh uncontrollably or may become sad and weep. With higher doses—panic reactions and sinking sensation are common.

Some degree of tolerance occurs, but *reverse tolerance* is not unusual.

Psychological dependence on hallucinogens may be mild (occasional trips) to marked (compulsive abuse), but physical dependence does not occur. All are drugs of abuse.

Hallucinogens have been rarely used in psychiatry to facilitate conversation and for opening up the inner self in case of withdrawn patients.

CHAPTER 33

Drugs Used in Mental Illness: Antidepressant and Antianxiety Drugs

Major depression and mania are two extremes of *affective disorders* which refer to a pathological change in mood state. *Major depression* is characterized by symptoms like sad mood, loss of interest and pleasure, low energy, worthlessness, guilt, psychomotor retardation or agitation, change in appetite and/or sleep, melancholia, suicidal thoughts, etc. In *bipolar disorder* cycles of mood swings from mania to depression occur over time. The mood change may have a psychotic basis with delusional thinking or occur in isolation and induce anxiety. On the other hand, pathological anxiety may lead to depression.

ANTIDEPRESSANTS

These are drugs which can elevate mood in depressive illness. Practically all antidepressants affect monoaminergic transmission in the brain in one way or the other and many of them have other associated properties. Particularly over the past two decades, a large number of antidepressants with an assortment of effects on reuptake/metabolism of biogenic amines and on pre/post-junctional aminergic/cholinergic receptors have become available so that a cogent classification is difficult. The following working classification may be adopted.

CLASSIFICATION

- I. *Reversible inhibitors of MAO-A (RIMAs)*
Moclobemide, Clorgyline
- II. *Tricyclic antidepressants (TCAs)*
 - A. *NA + 5-HT reuptake inhibitors*
Imipramine, Amitriptyline, Trimipramine, Doxepin, Dothiepin, Clomipramine
 - B. *Predominantly NA reuptake inhibitors*
Desipramine, Nortriptyline, Amoxapine, Reboxetine
- III. *Selective serotonin reuptake inhibitors (SSRIs)*
Fluoxetine, Fluvoxamine, Paroxetine, Sertraline, Citalopram, Escitalopram
- IV. *Atypical antidepressants*
Trazodone, Mianserin, Mirtazapine, Venlafaxine, Duloxetine, Tianeptine, Amineptine, Bupropion

Many other drugs like Protriptyline, Maprotiline, Nafazodone are marketed in other countries.

MAO INHIBITORS

MAO is a mitochondrial enzyme involved in the oxidative deamination of biogenic amines (Adr, NA, DA, 5-HT). Two isoenzyme forms of MAO have been identified.

MAO-A: Preferentially deaminates 5-HT and NA, and is inhibited by clorgyline, moclobemide.

MAO-B: Preferentially deaminates phenylethylamine and is inhibited by selegiline.

Dopamine is degraded equally by both isoenzymes.

Their distribution also differs. Peripheral adrenergic nerve endings, intestinal mucosa and human placenta contain predominantly MAO-A, while MAO-B predominates in certain areas (mainly serotonergic) of brain and in platelets. Liver contains both isoenzymes.

Two hydrazine drugs—*isoniazid* and *iproniazid* were used for tuberculosis in 1951; the latter was especially found to cause disproportionate elevation of mood. Its capacity to inhibit degradation of biogenic amines was soon discovered and was believed to be responsible for the mood elevating action. Its less hepatotoxic congeners like *phenelzine* and *isocarboxazid* and some nonhydrazine MAO inhibitors (related to amphetamine) like *tranlycypromine* were used as antidepressants in the 1960s. They inhibited MAO irreversibly and were nonselective for the two isoforms. Because of high toxicity and interactions with foods and other drugs, they have become obsolete.

The selective MAO-A inhibitors possess antidepressant property. Selegiline selectively inhibits MAO-B at lower doses (5–10 mg/day), but these are not effective in depression. It is metabolized to amphetamine and at higher doses it becomes nonselective MAO inhibitor—exhibits antidepressant and excitant properties.

Nonselective MAO Inhibitors

The nonselective MAO inhibitors elevate the mood of depressed patients; in some cases it may progress to hypomania and mania. Excitement and hypomania may be produced even in nondepressed individuals.

The active metabolites of nonselective MAO inhibitors inactivate the enzyme irreversibly. The drugs themselves stay in the body for relatively short periods, but their effects last for 2–3 weeks after discontinuation: they are 'hit and run' drugs—return of MAO activity depends on synthesis of fresh enzyme; tissue monoamine levels remain elevated long after the drug has been largely eliminated.

Interactions These drugs inhibit a number of other enzymes as well, and interact with many food constituents and drugs.

(i) **Cheese reaction** Certain varieties of cheese, beer, wines, pickled meat and fish, yeast extract contain large quantities of tyramine, dopa, etc. In MAO inhibited patients these indirectly acting sympathomimetic amines escape degradation in the intestinal wall and liver → reaching into systemic circulation they displace large amounts of NA from transmitter loaded adrenergic nerve endings → *hypertensive crisis*, cerebrovascular accidents. When such a reaction occurs, it can be treated by i.v. injection of a rapidly acting α blocker, e.g. phentolamine. Prazosin or chlorpromazine are alternatives.

(ii) **Cold and cough remedies** They contain ephedrine or other sympathomimetics—hypertensive reaction can occur.

(iii) **Reserpine, guanethidine, tricyclic antidepressants** Excitement, rise in BP and body temperature can occur when these drugs are given to a patient on MAO inhibitors. This is due to their initial NA releasing or uptake blocking action.

(iv) **Levodopa** Excitement and hypertension occur due to increase in biological $\frac{1}{2}$ of DA and NA that are produced from levodopa.

(v) **Antiparkinsonian anticholinergics** Hallucinations and symptoms similar to those of atropine poisoning occur.

(vi) **Barbiturates, alcohol, opioids, antihistamines** Action of these drugs is intensified and prolonged. Respiration may fail.

(vii) **Pethidine** High fever, sweating, excitation, delirium, convulsions and severe respiratory depression have occurred. The most accepted explanation is—MAO inhibitors retard hydrolysis of pethidine but not its demethylation. Thus, excess of *norpethidine* (normally a minor metabolite—see p. 459) is produced which has excitatory actions.

Reversible inhibitors of MAO-A (RIMAs)

Moclobemide It is a reversible and selective MAO-A inhibitor with short duration of action; full MAO activity is restored within 1–2 days of stopping the drug. Because of competitive enzyme inhibition, tyramine is able to displace it—potentiation of pressor response to ingested amines is weak, dietary restrictions are not required. Clinical trials have shown moclobemide to be an efficacious antidepressant, comparable to TCAs, except in severe cases. It lacks the anticholinergic, sedative, cognitive, psychomotor and cardiovascular adverse effects of typical TCAs and is safer in overdose. This makes it a particularly good option in elderly patients and in those with heart disease.

Dose: 150 mg BDS–TDS (max 600 mg/day)

RIMAREX 150, 300 mg tabs.

Adverse effects are nausea, dizziness, headache, insomnia, rarely excitement and liver damage. Chances of interaction with other drugs and alcohol are little, but caution is advised while coprescribing pethidine, SSRIs and TCAs.

Moclobemide has emerged as a well tolerated alternative to TCAs in mild to moderate depression and in social phobia.

TRICYCLIC ANTIDEPRESSANTS (TCAs)

Imipramine, an analogue of CPZ was found during clinical trials (1958) to selectively benefit depressed but not agitated psychotics. In contrast to CPZ, it inhibited NA and 5-HT reuptake into neurones. A large number of congeners were soon added and are collectively called *tricyclic antidepressants (TCAs)*.



PHARMACOLOGICAL ACTIONS

The most prominent action of TCAs is their ability to inhibit norepinephrine transporter (NET) and serotonin transporter (SERT) located at neuronal/platelet membrane at low and therapeutically attained concentrations.

The TCAs inhibit monoamine reuptake and interact with a variety of receptors *viz.* muscarinic, α adrenergic, histamine H_1 , 5-HT $_1$, 5-HT $_2$ and occasionally dopamine D2. However, relative potencies at these sites differ among different compounds. The newer selective serotonin reuptake inhibitors (SSRIs) and atypical antidepressants interact with fewer receptors and have more limited spectrum of action (produce fewer side effects). The actions of imipramine are described as prototype.

1. CNS Effects differ in normal individuals and the depressed.

In normal individuals It induces a peculiar clumsy feeling, tiredness, light-headedness, sleepiness, difficulty in concentrating and thinking, unsteady gait. These effects tend to provoke anxiety. There is no mood elevation or euphoria; effects are rather unpleasant and may become more so on repeated administration.

In depressed patients Little acute effects are produced, except sedation (in the case of drugs

which have sedative property). After 2–3 weeks of continuous treatment, the mood is gradually elevated, patients become more communicative and start taking interest in self and surroundings. Thus, TCAs are not euphorients but only antidepressants. In depressed patients who have preponderance of REM sleep, this phase is suppressed and awakenings during night are reduced. The EEG effects of low doses are similar to hypnotics but high doses cause desynchronization. Sedative property varies among different compounds: (*see* Table 33.1). The more sedative ones are suitable for depressed patients showing anxiety and agitation. The less sedative or stimulant ones are better for withdrawn and retarded patients.

The TCAs lower seizure threshold and produce convulsions in overdose. Clomipramine, maprotiline and bupropion have the highest seizure precipitating potential. Amitriptyline and imipramine depress respiration in overdose only.

Mechanism of action The TCAs and related drugs inhibit active reuptake of biogenic amines NA and 5-HT into their respective neurones and thus potentiate them. They, however, differ markedly in their selectivity and potency for different amines (*see* classification above).

Most of the compounds do not inhibit DA uptake, except bupropion. Moreover, amphetamine and cocaine (which are not antidepressants but CNS stimulants) are strong inhibitors of DA uptake. However, it has been proposed that TCAs indirectly facilitate dopaminergic transmission in forebrain that may add to the mood elevating action.

Reuptake inhibition results in increased concentration of the amines in the synaptic cleft in the CNS and periphery. Tentative conclusions drawn are:

- Inhibition of DA uptake correlates with stimulant action; but is not primarily involved in antidepressant action.
- Inhibition of NA and 5-HT uptake is associated with antidepressant action.

Table 33.1: Comparative properties and preparations of tricyclic and related antidepressants

Drug	Sedation	Anti-muscarinic	Hypotension	Cardiac arrhythmia	Seizure precipitation	Daily dose (mg)	Preparations
Tricyclic antidepressants							
1. Imipramine	+	++	++	+++	++	50–200	DEPSONIL, ANTIDEP 25 mg tab, 75 mg SR cap.
2. Amitriptyline	+++	+++	+++	+++	++	50–200	AMLINE, SAROTENA, TRYPTOMER, 10, 25, 75 mg tabs.
3. Trimipramine	+++	+++	++	+++	++	50–150	SURMONTIL 10, 25 mg tab.
4. Doxepin	+++	++	++	++	++	50–150	SPECTRA, DOXIN, DOXETAR 10, 25, 75 mg tab/cap.
5. Clomipramine	++	+++	++	+++	+++	50–150	CLOFRANIL, 10, 25, 50 mg tab, 75 mg SR tab. CLONIL, ANAFRANIL 10, 25 mg tab.
6. Dothiepin (Dosalpin)	++	++	++	++	++	50–150	PROTHIADEN, DOTHIN 25, 75 mg tab.
7. Nortriptyline	+	++	+	++	+	50–150	SENSIVAL, PRIMOX 25 mg tab.
8. Amoxapine	+	+	++	++	++	100–300	DEMOLOX 50, 100 mg tab.
Selective 5-HT reuptake inhibitors							
1. Fluoxetine	±	—	—	—	±	20–50	FLUDAC 20 mg cap, 20 mg/5 ml susp. FLUNIL 10, 20 mg caps; FLUPAR, PRODAC 20 mg cap.
2. Fluvoxamine	±	—	—	—	—	50–200	FLUVOXIN 50, 100 mg tab.
3. Paroxetine	±	±	—	—	—	20–50	XET 10, 20, 30, 40 mg tabs.
4. Sertraline	±	—	—	—	—	50–200	SERENATA, SERLIN, SERTIL 50, 100 mg tabs.
5. Citalopram	—	—	—	—	—	20–40	CELICA 10, 20, 40 mg tabs.
6. Escitalopram	—	—	—	—	—	10–20	ESDEP, FELIZ-S 5, 10, 20 mg tabs.
Atypical antidepressants							
1. Trazodone	+++	—	±	±	—	50–200	TRAZODAC 25, 50 mg tab, TRAZONIL, TRAZALON 25, 50, 100 mg tabs.
2. Mianserin	++	+	++	+	++	30–100	TETRADEP 10, 20, 30 mg tab, SERIDAC 10, 30 mg tab.
3. Bupropion	–, ↑	—	—	—	+++	150–300	SMOQUIT 150 mg tab.
4. Mirtazapine	+++	—	±	—	—	15–45	MIRT 15, 30, 45 mg tabs, MIRTAZ 15, 30 mg tab.
5. Venlafaxine	—	—	—	±	—	75–150	VENLOR 25, 37.5, 75 mg tabs, VENIZ-XR 37.5, 75, 150 mg ER caps.
6. Duloxetine	—	—	—	—	—	30–80	DELOK, DULANE, DUZAC, 20, 30, 40 mg caps.

Several findings indicate that uptake blockade is not directly responsible for antidepressant action, e.g. uptake blockade occurs quickly but antidepressant action develops after weeks; mianserin is antidepressant but has no uptake blocking action. Initially the presynaptic α_2 and 5-HT_{1A} autoreceptors are activated by the increased amount of NA/5-HT in the synaptic cleft resulting in decreased firing of locus coeruleus (noradrenergic) and raphe (serotonergic) neurones. However, on long-term administration, antidepressants desensitise presynaptic α_2 , 5-HT_{1A}, 5-HT_{1D} autoreceptors and induce other adaptive changes in the number and sensitivity of pre and post synaptic NA and/or 5-HT receptors as well as in amine turnover of brain, the net effect of which is enhanced nor-adrenergic and serotonergic transmission. Thus, uptake blockade appears to initiate a series of time-dependent changes that culminate in antidepressant effect.

Trimipramine is a weak NA/5-HT reuptake blocker, but an equally effective antidepressant. None of these compounds, except amoxapine and to some extent maprotiline, block DA receptors or possess antipsychotic activity.

2. ANS Most TCAs are potent anticholinergics—cause dry mouth, blurring of vision, constipation and urinary hesitancy as side effect. The anticholinergic potency is graded in Table 33.1.

They potentiate exogenous and endogenous NA by blocking uptake, but also have weak α_1 adrenergic blocking action. Some, e.g. amitriptyline, doxepin, trimipramine have slight H₁ antihistaminic action as well.

3. CVS Effects on cardiovascular function are prominent, occur at therapeutic concentrations and may be dangerous in overdose.

Tachycardia: due to anticholinergic and NA potentiating actions.

Postural hypotension: due to inhibition of cardiovascular reflexes and α_1 blockade.

ECG changes and cardiac arrhythmias: T wave suppression or inversion is the most consistent

change. Arrhythmias occur in overdose due to interference with intraventricular conduction, combination of NA potentiating + ACh blocking actions and direct myocardial depression. Older patients are more susceptible. The SSRIs and atypical antidepressants are safer in this regard.

Tolerance and dependence

Tolerance to the anticholinergic and hypotensive effects of imipramine-like drugs develops gradually, though antidepressant action is sustained.

Psychological dependence on these drugs is rare, because their acute effects are not pleasant.

There is some evidence of physical dependence occurring when high doses are used for long periods—malaise, chills, muscle pain may occur on discontinuation and have been considered withdrawal phenomena. Gradual withdrawal is recommended, but antidepressants do not carry abuse potential.

PHARMACOKINETICS

The oral absorption of TCAs is good, though often slow. They are highly bound to plasma and tissue proteins—have large volumes of distribution (~20 L/kg). They are extensively metabolized in liver; the major route for imipramine and amitriptyline is demethylation whereby active metabolites—desipramine and nortriptyline respectively are formed. Few others also produce active metabolites. Inactivation occurs by oxidation and glucuronide conjugation. Various CYP isoenzymes like CYP2D6, CYP3A4, CYP1A2 and others metabolise tricyclic and related antidepressants. Metabolites are excreted in urine over 1–2 weeks. The plasma $t_{1/2}$ of amitriptyline, imipramine and doxepin range between 16–24 hours. The $t_{1/2}$ is longer for some of their active metabolites. Because of relatively long $t_{1/2}$ s, once daily dosing (at bed time) is practicable in the maintenance phase.

An unusual *therapeutic window* phenomenon has been observed, i.e. optimal antidepressant effect is exerted at a narrow band of plasma concentrations (between 50–200 ng/ml of

imipramine, amitriptyline, nortriptyline). Both below and above this range, beneficial effects are suboptimal.

Wide variation in the plasma concentration attained by different individuals given the same dose has been noted. Thus, doses need to be individualized and titrated, but plasma concentrations are not a reliable guide for adjusting the dose of TCAs.

ADVERSE EFFECTS Side effects are common with tricyclic antidepressants.

1. Anticholinergic: dry mouth, bad taste, constipation, epigastric distress, urinary retention (especially in males with enlarged prostate), blurred vision, palpitation.
2. Sedation, mental confusion and weakness, especially with amitriptyline and more sedative congeners.
3. Increased appetite and weight gain is noted with most TCAs and trazodone, but not with SSRIs and bupropion.
4. Some patients receiving any antidepressant may abruptly switch over to a dysphoric-agitated state or to mania. Most likely, these are cases of bipolar depression, the other pole being unmasked by the antidepressant. Patients receiving higher doses and TCAs are at greater risk than those receiving lower doses and SSRIs or bupropion.
5. Sweating and fine tremors are relatively common.
6. Seizure threshold is lowered—fits may be precipitated, especially in children. Bupropion, maprotiline, clomipramine, amoxapine have greater propensity, while desipramine and SSRIs are safer in this regard.
7. Postural hypotension, especially in older patients; less severe with desipramine-like drugs and insignificant with SSRIs.
8. Cardiac arrhythmias, especially in patients with ischaemic heart disease—may be responsible for sudden death in these patients. Amitriptyline and dosulpin are particularly dangerous in overdose; higher incidence of arrhythmias is reported.

9. Rashes and jaundice due to hypersensitivity are rare. Mianserin is more hepatotoxic.

Acute poisoning It is frequent; usually self-attempted by the depressed patients, and may endanger life. Manifestations are:

Excitement, delirium and other anticholinergic symptoms as seen in atropine poisoning, followed by muscle spasms, convulsions and coma. Respiration is depressed, body temperature may fall, BP is low, tachycardia is prominent. ECG changes and ventricular arrhythmias are common.

Treatment is primarily supportive with gastric lavage, respiratory support, fluid infusion, maintenance of BP and body temperature. Acidosis must be corrected by bicarbonate infusion.

Diazepam may be injected i.v. to control convulsions and delirium. Most important is the treatment of cardiac arrhythmias, for which propranolol/lidocaine may be used; class IA and IC antiarrhythmics and digoxin prolong cardiac conduction—are contraindicated.

Physostigmine (0.5–2 mg i.v.) reverses many central and peripheral anticholinergic and sometimes cardiac effects. However, it is seldom used since arrhythmias are occasionally worsened and hypotension accentuated by this treatment.

INTERACTIONS

1. TCAs potentiate directly acting *sympathomimetic amines* (in cold/asthma remedies). Adrenaline containing local anaesthetic should be avoided. However TCAs attenuate the actions of indirect sympathomimetics (ephedrine, tyramine).
2. TCAs abolish the antihypertensive action of *guanethidine* and *clonidine* by preventing their transport into adrenergic neurones.
3. TCAs potentiate *CNS depressants*, including alcohol and antihistaminics.
4. *Phenytoin*, *phenylbutazone*, *aspirin* and *CPZ* can displace TCAs from protein binding sites and cause toxicity.
5. *Phenobarbitone* induces as well as competitively inhibits imipramine metabolism.

- Carbamazepine and other enzyme inducers enhance metabolism of TCAs.
6. SSRIs inhibit metabolism of several drugs (see later) including TCAs—dangerous toxicity can occur if the two are given concurrently.
 7. By their anticholinergic property, TCAs delay gastric emptying and retard their own as well as other drug's absorption. However, *digoxin* and *tetracyclines* may be more completely absorbed. When used together, the anticholinergic action of neuroleptics and TCAs may add up.
 8. MAO inhibitors—dangerous hypertensive crisis with excitement and hallucinations has occurred when given with TCAs.

Amoxapine This tetracyclic compound is unusual in that it blocks dopamine D2 receptors in addition to inhibiting NA reuptake. It is chemically related to the antipsychotic drug loxapine and has mixed antidepressant + neuroleptic properties—offers advantage for patients with psychotic depression. Risk of extrapyramidal side effects is also there. Seizures (including status epilepticus) occur in its overdose.

Reboxetine This is a newer selective NA reuptake blocker with weak effect on 5-HT reuptake. Antimuscarinic and sedative actions are minimal. It appears to produce fewer side effects and may be safer in overdose than the older TCAs. Usual side effects are insomnia, dry mouth, constipation, sexual distress and urinary symptoms.

Dose: 4 mg BD or 8 mg OD.
NAREBOX 4, 8 mg tab.

SELECTIVE SEROTONIN REUPTAKE INHIBITORS (SSRIs)

The major limitations of conventional TCAs are:

- Frequent anticholinergic, cardiovascular and neurological side effects.
- Relatively low safety margin, hazardous in overdose; fatalities common.

- Lag time of 2–4 weeks before antidepressant action manifests.
- Significant number of patients respond incompletely and some do not respond.

To overcome these shortcomings, a large number of newer antidepressants have been developed since 1980s. The most significant of these are the SSRIs which selectively inhibit membrane associated SERT. Though, none of the newer drugs has surpassed older TCAs in overall efficacy, some patients not responding to one type of drug may respond to the other. More importantly the newer drugs have improved tolerability, both in therapeutic use as well as in overdose. It has been claimed that certain drugs (bupropion, venlafaxine, mirtazapine) have faster onset of antidepressant action, this has not been unequivocally established.

The relative safety and better acceptability of SSRIs has made them 1st line drugs in depression and allowed their extensive use in anxiety, phobias, OCD and related disorders. The SSRIs produce little or no sedation, do not interfere with cognitive and psychomotor function or produce anticholinergic side effects. They are devoid of α adrenergic blocking action—postural hypotension does not occur—suitable for elderly patients. They have practically no seizure precipitating propensity and do not inhibit cardiac conduction—overdose arrhythmias are not a problem. Prominent side effects are gastrointestinal; all SSRIs frequently produce nausea (due to 5-HT₃ receptor stimulation), but tolerance develops over time. Weight gain is not a problem with SSRIs, but they more commonly interfere with ejaculation or orgasm. A new constellation of mild side effects, *viz.* nervousness, restlessness, insomnia, anorexia, dyskinesia, headache and diarrhoea is associated with them, but patient acceptability is good. Increased incidence of epistaxis and ecchymosis has been reported, probably due to impairment of platelet function. Gastric blood loss due to NSAIDs may be increased by SSRIs.

The SSRIs inhibit drug metabolizing isoenzymes CYP2D6 and CYP3A4: elevate plasma levels of TCAs, haloperidol, clozapine, terfenadine, astemizole, warfarin, β blockers, some BZDs and carbamazepine. 'Serotonin syndrome' manifesting as agitation, restlessness, sweating, twitches followed by convulsions can be precipitated when any serotonergic drug is taken by a patient receiving SSRIs. Some degree of tolerance to antidepressant action of SSRIs has been noted in few patients after months of use. Discontinuation reaction consisting of paresthesias, bodyache, bowel upset, agitation and sleep disturbances occurs in some patients. However, risk of switching over to hypomania during treatment is less with SSRIs than with TCAs.

The overall antidepressant efficacy of SSRIs is similar to that of TCAs, though some patients not responding to one may respond to the other. Because of freedom from psychomotor and cognitive impairment, SSRIs are preferred for prophylaxis of recurrent depression.

In severe depression, however, TCAs appear to be more efficacious. Metaanalysis of comparative trials has shown no significant difference in efficacy among individual SSRIs, but there are pharmacokinetic differences and incidence of particular side effects differs somewhat.

Fluoxetine A bicyclic compound, prototype of the SSRIs and the longest acting; plasma $t_{1/2}$ is 2 days and that of its active demethylated metabolite is 7–10 days. It has been approved for use in children 7 years or older for depression and OCD on the basis of similar efficacy and side effect profile as in adults, but should be given to children only when psychotherapy fails. It has caused more agitation and dermatological reactions than other SSRIs. Because of slower onset of antidepressant effect, it is considered less suitable for patients needing rapid effect, but is more appropriate for poorly compliant patients. Its stimulant effect could worsen patients showing agitation.

Fluvoxamine It is a shorter-acting SSRI with a $t_{1/2}$ of 18 hours and no active metabolite.

Relatively more nausea, agitation and discontinuation reactions have been reported with fluvoxamine. However, it has been more commonly used in hospitalized patients and in some anxiety disorders or OCD.

Paroxetine Another short acting SSRI ($t_{1/2}$ 20 hours) which does not produce active metabolite. A higher incidence of g.i. side effects and discontinuation reaction than with other SSRIs has been noted.

Sertraline This SSRI has gained popularity, since in clinical trials fewer patients stopped sertraline due to side effects. Efficacy in juvenile depression has been demonstrated. Drug interactions due to inhibition of CYP isoenzymes are less likely to occur with it. Its plasma $t_{1/2}$ is 26 hours and it produces a longer-lasting active metabolite.

Citalopram This SSRI shares with sertraline a lower propensity to cause drug interactions. Its $t_{1/2}$ is 33 hours and no active metabolite is known. However, few deaths due to overdose of citalopram are on record, because of which it is to be avoided in patients likely to attempt suicide.

Escitalopram It is the active S(+) enantiomer of citalopram, effective at half the dose, with similar properties. Side effects are milder and safety is improved.

Other uses of SSRIs The SSRIs are now 1st choice drugs for OCD, panic disorder, social phobia, eating disorders, premenstrual dysphoric disorder and post traumatic stress disorder. They are also being increasingly used for many anxiety disorders, body dysmorphic disorder, compulsive buying and kleptomania. Elevation of mood and increased work capacity has been reported in postmyocardial infarction and other chronic somatic illness patients. Thus, SSRIs are being used to improve outlook on life and to feel good, even in apparently nondepressed patients. Wisdom of such use though is questionable.

ATYPICAL ANTIDEPRESSANTS

1. Trazodone It is the first atypical antidepressant; selectively but less efficiently blocks 5-HT uptake and has prominent α blocking as well as weak 5-HT₂ antagonistic action. The latter may contribute to its antidepressant effect. It is sedative but not anticholinergic, causes bradycardia rather than tachycardia, does not interfere with intracardiac conduction—less prone to cause arrhythmia—better suited for the elderly. Nausea is felt, especially in the beginning. Mild anxiolytic effect has been noted and it has benefited cases of OCD. Inappropriate, prolonged and painful penile erection (priapism) occurs in few recipients resulting in impotence in a fraction of these. The α_1 adrenergic blocking property has been held responsible for this effect as well as for postural hypotension. In general, trazodone is well tolerated and relatively safe in overdose: seizures do not occur. Its t_{1/2} is short (~6 hr).

2. Mianserin It is unique in not inhibiting either NA or 5-HT uptake; but blocks pre-synaptic α_2 receptors—increases release and turnover of NA in brain which may be responsible for antidepressant effect. Antagonistic action at 5-HT₂, 5-HT_{1c} as well as H₁ receptors has also been shown. It is a sedative—relieves associated anxiety and suppresses panic attacks. While anticholinergic and cardiac side effects are less prominent, it has caused seizures in overdose—but fatality is low. Blood dyscrasias and liver dysfunction have been reported—have restricted its use.

3. Tianeptine This antidepressant is reported to increase rather than inhibit 5-HT uptake, and is neither sedative nor stimulant. It has shown efficacy in anxiodepressive states, particularly with psychosomatic symptoms, as well as in endogenous depression. Side effects are dry mouth, epigastric pain, flatulence, drowsiness/insomnia, tremor and bodyache.

Dose: 12.5 mg BD-TDS; **STABLON 12.5 mg tab.**

4. Amineptine Like tianeptine it enhances 5-HT uptake, but has antidepressant property.

It produces anticholinergic side effects including tachycardia, confusion and delirium. Postural hypotension, conduction disturbances and arrhythmias can occur, especially in patients with heart disease.

Dose: 100 mg BD at breakfast and lunch.

SURVECTOR 100 mg tab.

5. Venlafaxine A novel antidepressant referred to as 'serotonin and noradrenaline reuptake inhibitor' (SNRI), because it inhibits uptake of both these amines but, in contrast to older TCAs, does not interact with cholinergic, adrenergic or histaminergic receptors or have sedative property. Trials have shown it to be as effective antidepressant as TCAs and may work in some resistant cases. A faster onset of action has also been indicated. Venlafaxine does not produce the usual side effects of TCAs; tends to raise rather than depress BP and is safer in overdose. Prominent side effects are nausea, sweating, anxiety, dizziness and impotence.

6. Duloxetine A newer SNRI similar to venlafaxine. It is neither sedative, nor anticholinergic, nor antihistaminic, nor α blocker. Side effects, including g.i. and sexual problems are milder, but some agitation, insomnia and rise in BP can occur. Antidepressant efficacy is comparable to TCAs and duloxetine is also indicated in panic attacks, diabetic neuropathic pain and stress urinary incontinence in women (because it increases urethral tone).

7. Mirtazapine This antidepressant acts by a novel mechanism, *viz.* blocks α_2 auto- (on NA neurones) and hetero- (on 5-HT neurones) receptors enhancing both NA and 5-HT release. The augmented NA further increases firing of serotonergic raphe neurones *via* α_1 receptors. Selective enhancement of antidepressive 5-HT₁ receptor action is achieved by concurrent blockade of 5-HT₂ and 5-HT₃ receptors which are held responsible for some of the adverse effects of high serotonergic tone. Accordingly, it has been labelled as "noradrenergic and specific serotonergic antidepressant" (NaSSA). It is a H₁

blocker and quite sedative, but not anticholinergic or antidopaminergic. Efficacy in mild as well as severe depression is reported to be comparable to TCAs and benefit may start earlier.

8. Bupropion This inhibitor of DA and NA uptake has excitant rather than sedative property. It is metabolized into an amphetamine like compound. It has been marketed in a sustained release formulation as an aid to smoking cessation. In clinical trials it has been found to yield higher smoking abstinence and quitting rates than placebo. Bupropion may be acting by augmenting the dopaminergic reward function. Better results have been obtained when it is combined with nicotine patch. The nicotine withdrawal symptoms were less severe in bupropion recipients. However, long-term efficacy is not known, and it can cause insomnia, agitation, dry mouth and nausea, but not sexual side effects. Seizures occur in over dose; the dose of 150 mg BD should not be exceeded.

USES

1. Endogenous (major) depression: The aim is to relieve symptoms of depression and restore normal social behaviour. The tricyclic and related antidepressants are of proven value. Response takes at least 2–3 weeks to appear, full benefits take still longer. Choice of a particular drug for an individual patient depends on the secondary properties (sedative, anticholinergic, hypotensive, cardiotoxic, seizure precipitating, etc.) as described above. The SSRIs are currently used as first choice for their tolerability and safety. The newer atypical agents also offer some advantages. The only antidepressants clearly shown to be effective in juvenile depression are fluoxetine and sertraline. The TCAs are mostly used as alternatives in non-responsive cases, and are still the most effective in severely depressed adults. Moclobemide is a better tolerated option for mild to moderate depression, especially suited for elderly and cardiac patients. However, antidepressants are not the answer to every grief, loss, set back and other sad events that are part of life,

but the less toxic and more patient-friendly SSRIs/newer atypical antidepressants are now more readily prescribed for depressive illness. After a depressive episode has been controlled, continued treatment at maintenance doses (about 100 mg imipramine/day or equivalent) for months is recommended to prevent relapse. Therapy is generally not continued beyond one year. ECT may be given in the severely depressed, especially initially while the effect of antidepressants is developing, because no antidepressant has been clearly demonstrated to act fast enough. The TCAs or SSRIs must be combined with lithium / valproate / lamotrigine for bipolar depression, and not used alone due to risk of switching over to mania.

Combination of a SSRI with an atypical antipsychotic (such as olanzapine for its antimanic property) is also accepted as a treatment option of bipolar depression.

2. Obsessive-compulsive and phobic states:

The SSRIs are the drugs of choice due to better patient acceptability. TCAs, especially clomipramine, are highly effective in OCD and panic disorders: more than 25% improvement occurs in OCD rating scale and panic attacks are reduced in >75% patients. SSRIs and TCAs also reduce compulsive eating in *bulimia*, and help patients with *body dysmorphic disorder*, *compulsive buying* and *kleptomania*, though these habits may not completely die.

3. Anxiety disorders: Antidepressants, especially SSRIs, exert a delayed but sustained beneficial effect in many patients of *generalized anxiety disorder*; may be used along with a short course of BZDs to cover exacerbations. SSRIs have also proven helpful in *post-traumatic stress disorder*.

4. Neuropathic pain: Imipramine affords considerable relief in diabetic and some other types of chronic pain. Amitriptyline reduces intensity of post-herpetic neuralgia in ~50% patients.

5. Attention deficit-hyperactivity disorder in children: TCAs with less depressant properties like imipramine, nortriptyline and amoxapine

are now first line drugs in this disorder, comparable in efficacy to amphetamine-like drugs, with the advantage of less fluctuating action and fewer behavioral side effects.

6. **Enuresis:** In children above 5 years, imipramine 25 mg at bedtime is effective, but bed wetting may again start when the drug is stopped. Elderly subjects with bed wetting have also benefited.

7. **Migraine:** Amitriptyline has some prophylactic value, especially in patients with mixed headaches.

8. **Pruritus:** Some tricyclics have antipruritic action. Topical doxepin has been used to relieve itching in atopic dermatitis, lichen simplex, etc.

NOCTADERM 5% cream.

ANTIANSXIETY DRUGS

Anxiety It is an emotional state, unpleasant in nature, associated with uneasiness, discomfort and concern or fear about some defined or undefined future threat. Some degree of anxiety is a part of normal life. Treatment is needed when it is disproportionate to the situation and excessive. Some psychotics and depressed patients also exhibit pathological anxiety.

Cardiac neurosis (unfounded fear of heart disease—palpitation, functional precordial pain); g.i. neurosis (fixation on bowel movement, distention, eructation, reflux, acidity); social anxiety (fear of being observed and evaluated by others); obsessive-compulsive disorder (OCD), post-traumatic stress disorder and various forms of phobias are some specific types of anxiety disorders.

Antianxiety drugs These are an ill-defined group of drugs, mostly mild CNS depressants, which are aimed to control the symptoms of anxiety, produce a restful state of mind without interfering with normal mental or physical functions. The anxiolytic-sedative drugs differ markedly from antipsychotics, and more closely resemble sedative-hypnotics. They:

1. Have no therapeutic effect to control thought disorder of schizophrenia.
2. Do not produce extrapyramidal side effects.

3. Have anticonvulsant property.
4. Produce physical dependence and carry abuse liability.
5. Do not selectively block conditioned avoidance response in animals.

CLASSIFICATION

1. **Benzodiazepines** Diazepam
Chlordiazepoxide
Oxazepam
Lorazepam, Alprazolam
2. **Azapirones** Buspirone, Gepirone, Ispapirone
3. **Sedative antihistaminic** Hydroxyzine
4. **β blocker** Propranolol

In addition to the above drugs, antidepressants, especially the selective serotonin reuptake inhibitors (SSRIs) are effective in obsessive-compulsive disorder (OCD), phobias, panic and many types of severe generalized anxiety disorders.

BENZODIAZEPINES

The pharmacology of benzodiazepines (BZDs) as a class is described in Ch. 29.

Some members have a slow and prolonged action, relieve anxiety at low doses without producing global CNS depression. They have a selective taming effect on aggressive animals and suppress induced aggression. They also suppress the performance impairing effect of punishment. In contrast to barbiturates, they are more selective for limbic system and have proven clinically better in both quality and quantity of improvement in anxiety and stress-related symptoms.

At antianxiety doses, cardiovascular and respiratory depression is minor.

Because anxiety is a common complaint and is a part of most physical and mental illness, and because the BZDs—

- (i) have little effect on other body systems,

(ii) have lower dependence producing liability: withdrawal syndrome is milder and delayed due to their long half lives,
(iii) are relatively safe even in gross overdosage, they are presently one of the most widely used class of drugs. Potent BZDs like lorazepam and clonazepam injected i.m. have adjuvant role in the management of acutely psychotic and manic patients.

BZDs act primarily by facilitating inhibitory GABAergic transmission, but other additional mechanisms of action have been suggested. Higher doses induce sleep and impair performance.

Adverse effects of BZDs noted in their use as hypnotics are described in Ch. 29. **Side effects** that occur in their use to relieve anxiety are—sedation, light-headedness, psychomotor and cognitive impairment, vertigo, confusional state (especially in the elderly), increased appetite and weight gain, alterations in sexual function. Rashes are uncommon. Some women fail to ovulate while on regular use of BZDs. The major constraint in their long-term use for anxiety disorders is their potential to produce dependence.

Differences between individual BZDs recommended for anxiety are primarily pharmacokinetic: choice of one over the other is largely empirical.

1. Chlordiazepoxide It was the first BZD to be used clinically. Oral absorption is slow: produces a smooth long lasting effect; preferred in chronic anxiety states; often combined with other drugs in psychosomatic diseases. Its $t_{1/2}$ is 5–15 hours but active metabolites are produced which extend the duration of action. It has poor anticonvulsant action.

Daily dose: 20–100 mg; **LIBRIUM 10, 25 mg tabs; EQUILIBRIUM 10 mg tab.**

2. Diazepam It is quickly absorbed; produces a brief initial phase of strong action followed by prolonged milder effect due to a two phase plasma concentration decay curve (distributive phase $t_{1/2}$ 1 hr, elimination phase $t_{1/2}$ 20–30

hours). The biological effect $t_{1/2}$ is still longer due to production of active metabolites. It is preferred in acute panic states and anxiety associated with organic disease.

Daily dose: 5–30 mg; **VALIUM, PLACIDOX 2, 5, 10 mg tabs; CALMPOSE 5, 10 mg tab, 2 mg/5 ml Syr.**

3. Oxazepam It is slowly absorbed; being relatively polar, its penetration in brain is also slow. The plasma $t_{1/2}$ is about 10 hours; no active metabolite is produced—duration of action is relatively shorter. It may be preferred in the elderly and in those with liver disease, because its hepatic metabolism is not significant and duration of action is short. It has been used mainly in short lasting anxiety states.

Daily dose: 30–60 mg in 2–3 divided portions; **SEREPAX 15, 30 mg tab.**

4. Lorazepam Has slow oral absorption. Being less lipid-soluble than diazepam, its rate of entry in brain is slower. The plasma $t_{1/2}$ is shorter (10–20 hours); no active metabolite is produced. However, it is quite sedative and capable of producing marked amnesia when injected i.v. Injection site complications are few—is the only BZD recommended for i.m. use. It has been preferred for short lasting anxiety states, panic, obsessive-compulsive neurosis and tension syndromes, as well as psychosomatic diseases.

Daily dose: 1–6 mg; **LARPOSE, ATIVAN 1, 2 mg tab. CALMESE 1, 2 mg tabs, 4 mg/2 ml inj.**

5. Alprazolam A high potency anxiolytic BZD which in addition has some mood elevating action in mild depression: is particularly useful in anxiety associated with depression. Good response has been obtained in panic disorders with severe anxiety and autonomic symptoms. Its plasma $t_{1/2}$ is about 12 hours, but an active metabolite is produced. Alprazolam is claimed to cause less drowsiness, but some patients experience anxiety in between doses.

Dose: 0.25–1.0 mg TDS; upto 6 mg/day in panic disorder; **ALPRAX 0.25, 0.5, 1.0 mg tabs., 0.5, 1.0, 1.5**

mg SR tabs; ALZOLAM 0.25, 0.5, 1.0 mg tabs; 1.5 mg SR tab, ALPROCONTIN 0.5, 1.0, 1.5 mg CR tabs. RESTYL 0.25, 0.5, 1.0 mg tabs, RESTYL-SR 0.5, 1.0, 1.5 mg SR tabs.

OTHER ANTIANXIETY DRUGS

Buspirone It is the first azapirone, a new class of antianxiety drugs, distinctly different from BZDs.

- Does not produce significant sedation or cognitive/functional impairment.
- Does not interact with BZD receptor or modify GABAergic transmission.
- Does not produce tolerance or physical dependence.
- Does not suppress BZD or barbiturate withdrawal syndrome.
- Has no muscle relaxant or anticonvulsant activity.

Buspirone relieves mild-to-moderate generalized anxiety, but is ineffective in severe cases, in those showing panic reaction and in OCD. The therapeutic effect develops slowly: maximum benefit may be delayed up to 2 weeks. The mechanism of anxiolytic action is not clearly known, but may be dependent on its selective partial agonistic action on 5-HT_{1A} receptors. By stimulating presynaptic 5-HT_{1A} autoreceptors, it reduces the activity of dorsal raphe serotonergic neurones. Antagonism at certain postsynaptic 5-HT_{1A} receptors has also been demonstrated. After chronic treatment, adaptive reduction in cortical 5-HT₂ receptors may occur. Buspirone has weak dopamine D₂ blocking action but no antipsychotic or extrapyramidal effects. A mild mood elevating action has been noted occasionally—may be due to facilitation of central noradrenergic system.

Buspirone is rapidly absorbed; undergoes extensive first pass metabolism; (bioavailability <5%), one metabolite is active and excretion occurs both in urine and faeces; *t*_{1/2} is 2–3.5 hrs. Side effects are minor: dizziness, nausea, headache, light-headedness, rarely excitement. It may cause rise in BP in patients on MAO inhibitors,

but does not potentiate CNS depressants. Though most patients on buspirone remain alert, those operating machinery/motor vehicles should be cautioned.

Dose: 5–15 mg OD–TDS: ANXIPAR, BUSPIN, BUSCALM 5, 10 mg tab.

Hydroxyzine An H₁ antihistaminic with sedative, antiemetic, antimuscarinic and spasmolytic properties. It is claimed to have selective anxiolytic action, but accompanying sedation is quite marked; may be used in reactive anxiety or that associated with marked autonomic symptoms. Due to antihistaminic and sedative property, it is effective in pruritus and urticaria.

Daily dose 50–200 mg; ATARAX 10, 25 mg tab, 10 mg/5 ml syr, 25 mg/2 ml inj.

β Blockers (see Ch. 10)

Many symptoms of anxiety (palpitation, rise in BP, shaking, tremor, gastrointestinal hurrying, etc.) are due to sympathetic overactivity, and these symptoms reinforce anxiety. Propranolol and other nonselective β blockers help anxious patients troubled by these symptoms, by cutting the vicious cycle and provide symptomatic relief. They do not affect psychological symptoms such as worry, tension and fear, but are valuable in acutely stressful situations (examination fear, unaccustomed public appearance, etc.). They may be used for performance/situational anxiety or as adjuvant to BZDs.

TREATMENT OF ANXIETY

Anxiety is a universal phenomenon, and to experience it in appropriate circumstances is the normal response. It may serve to enhance vigilance and drive. However, if anxiety symptoms are frequent and persist in a severe form, they are a cause of distress/suffering and markedly impair performance. It should be treated with drugs only when excessive and disabling in its own right.

The established drugs are BZDs which should be used in the smallest possible dose. The dose has to be found out for each patient by titration with symptoms of anxiety. Acute anxiety states generally respond better. The drug should be withdrawn as soon as it is no longer

required. But when large doses have been used for longer periods—withdrawal should be gradual. Long-term use of BZDs is of questionable value.

The usual practice is to give $\frac{1}{2}$ to $\frac{2}{3}$ of the daily dose at bed time to ensure good nightly rest; the remaining is divided in 2–3 doses given at day time. Though the $t_{1/2}$ of BZDs used in anxiety are longer, divided day time doses are required to avoid high peaks.

Buspirone is a non-sedating alternative to BZDs for less severe forms of generalized anxiety. The SSRI and some atypical antidepressants are now being increasingly used in many forms of

severe anxiety disorders, but are not good for acute anxiety. They produce a delayed but often gratifying response and can be combined with BZDs. The SSRIs are now drugs of choice for social anxiety in which BZDs, though effective, carry abuse potential on long-term use.

Patients with hypertension, peptic ulcer, ulcerative colitis, irritable bowel, gastroesophageal reflux, thyrotoxicosis, angina pectoris are often given low doses of BZD in addition to specific therapy, though anxiety may not be a prominent manifestation.

Fixed dose combination of tranquilizers with vitamins has been banned.

CHAPTER 34

Opioid Analgesics and Antagonists

Algesia (pain) is an ill-defined, unpleasant sensation, usually evoked by an external or internal noxious stimulus.

Analgesic A drug that selectively relieves pain by acting in the CNS or on peripheral pain mechanisms, without significantly altering consciousness.

Pain is a warning signal, primarily protective in nature, but causes discomfort and suffering; may even be unbearable and incapacitating. It is the most important symptom that brings the patient to the physician. Excessive pain may produce other effects—sinking sensation, apprehension, sweating, nausea, palpitation, rise or fall in BP, tachypnoea. Analgesics relieve pain as a symptom, without affecting its cause. They are used when the noxious stimulus (evoking the pain) cannot be removed or as adjuvants to more etiological approach to pain. Analgesics are divided into two groups, *viz.*

- A. Opioid/narcotic/morphine-like analgesics.
- B. Nonopioid/non-narcotic/aspirin-like/antipyretic or antiinflammatory analgesics (Ch. 14).

OPIOID ANALGESICS

Opium A dark brown, resinous material obtained from poppy (*Papaver somniferum*) capsule. It contains two types of alkaloids.

Phenanthrene derivatives

Morphine (10% in opium)

Codeine (0.5% in opium)

Thebaine (0.2% in opium), (Nonanalgesic)

Benzoisoquinoline derivatives

Papaverine (1%)

Noscapine (6%)

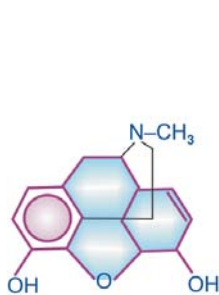

MORPHINE

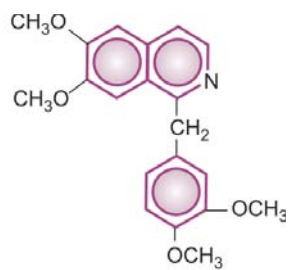

PAPAVERINE

Opium has been known from the earliest times. It is mentioned in the Eber's papyrus (1500 BC), in the writings of Theophrastus (300 BC) and Galen (2nd century AD). Opium eating became a social custom in China in the 18th century. Serturmer, a pharmacist, isolated the active principle of opium in 1806 and named it 'morphine' after the Greek god of dreams *Morpheus*. In the last century a large number of semisynthetic and synthetic compounds have been developed with morphine-like, antagonistic and mixed agonistic-antagonistic properties.

MORPHINE

Morphine is the principal alkaloid in opium and still widely used. Therefore, it is described as prototype.

PHARMACOLOGICAL ACTIONS

1. CNS Morphine has site specific depressant and stimulant actions in the CNS by interacting primarily with the μ opioid receptor as a full agonist. The depressant actions are:

(a) **Analgesia** Morphine is a strong analgesic. Though dull, poorly localized visceral pain is relieved better than sharply defined somatic pain; higher doses can mitigate even severe pain—degree of analgesia increasing with dose. Nociceptive pain arising from stimulation of peripheral pain receptors is relieved better than neuretic pain (such as trigeminal neuralgia) due to inflammation of or damage to neural structures. The associated reactions to intense pain (apprehension, fear, autonomic effects) are also dampened. Suppression of pain perception is selective, without affecting other sensations or producing proportionate generalized CNS depression (contrast general anaesthetics).

Perception of pain and its emotional or suffering component are both altered so that pain is no longer as unpleasant or distressing, i.e. the patient tolerates pain better. The analgesic action of morphine has spinal and supraspinal components. Intrathecal injection has been shown to cause segmental analgesia without affecting other modalities. It acts in the substantia gelatinosa of dorsal horn to inhibit release of excitatory transmitters from primary afferents carrying pain impulses. The action appears to be exerted through interneurons which are involved in the 'gating' of pain impulses. Release of glutamate from primary pain afferents in the spinal cord and its postsynaptic action on dorsal horn neurones is inhibited by morphine. Action at supraspinal sites in medulla, midbrain, limbic and cortical areas may alter processing and interpretation of

pain impulses as well as send inhibitory impulses through descending pathways to the spinal cord. Several aminergic and other neuronal systems appear to be involved in the action of morphine. Simultaneous action at spinal and supraspinal sites greatly amplifies the analgesia.

(b) **Sedation** which is different from that produced by hypnotics is seen. Drowsiness and indifference to surroundings as well as to own body occurs without motor incoordination, ataxia or apparent excitement (contrast alcohol). Higher doses progressively induce sleep and coma. Morphine has no anticonvulsant action, rather, fits may be precipitated.

(c) **Mood and subjective effects** These are prominent. Morphine has a calming effect; there is loss of apprehension, feeling of detachment, lack of initiative, limbs feel heavy and body warm, mental clouding and inability to concentrate occurs. In the absence of pain or apprehension, these are generally appreciated as unpleasant by normal people. However, patients in pain or anxiety, and especially addicts, perceive it as pleasurable floating sensation: refer it as 'high'. Rapid i.v. injection by addicts gives them a 'kick' or 'rush' which is intensely pleasurable—akin to orgasm. Thus, one has to learn to perceive the *euphoric* effect of morphine.

The pleasurable and reinforcing effects of μ opioid agonists (morphine-like) appear to involve a separate set of neuronal mechanisms than those involved in analgesia and sedation. The euphoric effects are most likely mediated by DA release in nucleus accumbens, whereas κ agonists (nalorphine like) inhibit DA release and produce aversion. Inhibition of NA release in locus ceruleus by opioids is implicated in their action to allay apprehension and fear.

(d) **Respiratory centre** Morphine depresses respiratory centre in a dose dependent manner; rate and tidal volume are both decreased: death in poisoning is due to respiratory failure. Neurogenic, hypercapnoeic and later hypoxic drives to the respiratory centre are suppressed in succession. In addition, there is indifference to breathing: apnoeic patient may breath if commanded.

(e) **Cough centre** It is depressed; more sensitive to morphine than respiratory centre.

(f) **Temperature regulating centre** It is depressed; hypothermia occurs in cold surroundings.

(g) **Vasomotor centre** It is depressed at higher doses and contributes to the fall in BP.

Morphine stimulates:

(a) **CTZ** Nausea and vomiting occur as side effects, especially if stomach is full and the patient stands or moves about. Thus, morphine appears to sensitize the CTZ to vestibular and other impulses. Larger doses depress vomiting centre directly: emetics should not be tried in morphine poisoning.

(b) **Edinger Westphal nucleus** of III nerve is stimulated producing miosis. This is a central action; no miosis occurs on topical application of morphine to the eye. Mydriasis occurs in some species like cats. Other ocular effect is a decrease in intraocular tension.

(c) **Vagal centre** It is stimulated → bradycardia is the usual response.

(d) **Certain cortical areas and hippocampal cells** are stimulated. Excitation is seen in an occasional individual. Muscular rigidity and immobility is consistently manifested at high doses (especially on i.v. injection): resembles catalepsy seen in rats and mice. Convulsions may occur in morphine poisoning. The proconvulsant action has been ascribed to inhibition of GABA release by hippocampal interneurons. Species like cat, lion, horse, sheep and cow are uniformly excited and show hyperthermia.

2. Neuro-endocrine Hypothalamic activation by afferent collaterals is dampened. Hypothalamic influence on pituitary is reduced. As a result FSH, LH, ACTH levels are lowered, while prolactin and GH levels are raised (these are under predominant inhibitory control). The sex hormone and corticosteroid levels are lowered in the short term, but tolerance develops in the long term. Only few chronic abusers suffer

from infertility; hypocorticism is not a problem in them. Morphine can release ADH and reduce urine volume.

3. CVS Morphine causes vasodilatation due to:

(a) histamine release.

(b) depression of vasomotor centre.

(c) direct action decreasing tone of blood vessels.

There is a shift of blood from pulmonary to systemic circuit due to greater vasodilatation in the latter. Therapeutic doses cause little change in the BP of recumbent normovolaemic patient. Postural hypotension and fainting do occur due to impairment of vascular reflexes. Morphine has little direct effect on heart; rate generally decreases due to stimulation of vagal centre, but may increase reflexly if the BP falls. Cardiac work is consistently reduced due to decrease in peripheral resistance. Intracranial tension tends to rise as a consequence of CO₂ retention leading to cerebral vasodilatation.

4. GIT Constipation is a prominent feature of morphine action. Several factors contribute:

(a) Action directly on intestines and in CNS increases tone and segmentation but decreases propulsive movements. Tone of duodenum and colon may be increased to the level of spasm.

(b) Spasm of pyloric, ileocaecal and anal sphincters.

(c) Decrease in all gastrointestinal secretions: reduction in transfer of water and electrolytes from mucosa to the lumen. Absorption of fluid is increased due to stasis.

(d) Central action causing inattention to defecation reflex.

No tolerance develops to this action: addicts remain chronically constipated.

5. Other smooth muscles

(a) **Biliary tract** Morphine causes spasm of sphincter of Oddi → intrabiliary pressure is increased → may cause biliary colic. This action is only partly counteracted by atropine but more completely by opioid antagonist naloxone and direct smooth muscle relaxants like nitrates.

(b) **Urinary bladder** Tone of both detrusor and sphincter is increased → urinary urgency and difficulty in micturition. Contractions of ureter are also increased.

(c) **Uterus** The action is clinically insignificant, may slightly prolong labour.

(d) **Bronchi** Morphine releases histamine which can cause bronchoconstriction. This is of no consequence in normal individuals, but can be dangerous in asthmatics.

6. ANS Morphine causes mild hyperglycaemia due to central sympathetic stimulation. It has weak anticholinesterase action.

PHARMACOKINETICS

The oral absorption of morphine is unreliable because of high and variable first pass metabolism; oral bioavailability is 1/6th to 1/4th of parenterally administered drug. About 30% is bound to plasma proteins. Distribution is wide; concentration in liver, spleen and kidney is higher than that in plasma. Only a small fraction enters brain rather slowly. Morphine freely crosses placenta and can affect the foetus more than the mother. It is primarily metabolized in liver by glucuronide conjugation. Morphine-6-glucuronide is an active metabolite (inherently more potent than morphine) which accumulates during chronic dosing and contributes to analgesia, despite its restricted passage across blood-brain barrier. Another metabolite morphine-3-glucuronide has neuroexcitatory property. Plasma $t_{1/2}$ of morphine averages 2–3 hours. Effect of a parenteral dose lasts 4–6 hours. Elimination is almost complete in 24 hours and morphine is noncumulative. Small amounts may persist due to enterohepatic circulation.

ADVERSE EFFECTS

1. Side effects Sedation, mental clouding, lethargy and other subjective effects which may even be dysphoric in some subjects; vomiting is occasional in recumbent patient; constipation is

common. Respiratory depression, blurring of vision, urinary retention (especially in elderly male) are other side effects. BP may fall, especially in hypovolaemic patient and if he/she walks about.

2. Idiosyncrasy and allergy Allergy is uncommon and anaphylactoid reaction is rare. Urticaria, itch, swelling of lips are the manifestations. A local reaction at injection site may occur due to histamine release.

3. Apnoea This may occur in the newborn when morphine is given to the mother during labour. The blood-brain barrier of foetus is undeveloped, morphine attains higher concentration in foetal brain than in that of mother. Naloxone 10 $\mu\text{g}/\text{kg}$ injected in the umbilical cord is the treatment of choice.

4. Acute morphine poisoning It is accidental, suicidal or seen in drug abusers. In the non-tolerant adult, 50 mg of morphine i.m. produces serious toxicity. The human lethal dose is estimated to be about 250 mg. Manifestations are extensions of the pharmacological action.

Stupor or coma, flaccidity, shallow and occasional breathing, cyanosis, pinpoint pupil, fall in BP and shock; convulsions may be seen in few, pulmonary edema occurs at terminal stages, death is due to respiratory failure.

Treatment: consists of respiratory support (positive pressure respiration also decreases pulmonary edema formation) and maintenance of BP (i.v. fluids, vasoconstrictors). Gastric lavage should be done with pot. permanganate to remove unabsorbed drug. Lavage is indicated even when morphine has been injected; being a basic drug it is partitioned to the acid gastric juice, ionizes there and does not diffuse back into blood.

Specific antidote: Naloxone 0.4–0.8 mg i.v. repeated every 2–3 min till respiration picks up, is the preferred specific antagonist because it does not have any agonistic action and does not *per se* depress respiration. It has a short duration of

action. Injection should be repeated every 1–4 hours later on, according to the response. Nalorphine is no longer used.

5. Tolerance and dependence High degree of tolerance can be developed to morphine and related opioids if the drug is used repeatedly. It is partly pharmacokinetic (enhanced rate of metabolism), but mainly pharmacodynamic (cellular tolerance). Tolerance is exhibited to most actions, but not to constipating and miotic actions. Addicts tolerate morphine in grams: lethal dose is markedly increased. Patients in intense pain are relatively tolerant to depressant effects. Cross tolerance among opioids is of high degree. Morphine tolerant subjects are partially cross tolerant to other CNS depressants as well.

Morphine produces pronounced psychological and physical dependence, its abuse liability is rated high. Recently the NMDA antagonists and nitric oxide synthase inhibitors have been found to block morphine tolerance and dependence in animals. Thus, analgesic action of morphine can be dissociated from tolerance and dependence which contribute to its abuse. Concern about abuse has been a major limitation in the use of morphine, but appropriate medical use of morphine seldom progresses to dependence and abuse. Morphine abuse is higher among medical and paramedical personnel. Earlier, morphine addicts tended to be from the middle age group, but now younger individuals are also opting for it. Opium eating has been prevalent among natives in the orient.

Withdrawal of morphine is associated with marked drug-seeking behaviour. Physical manifestations are—lacrimation, sweating, yawning, anxiety, fear, restlessness, gooseflesh, mydriasis, tremor, insomnia, abdominal colic, diarrhoea, dehydration, rise in BP, palpitation and rapid weight loss. Delirium and convulsions are not a characteristic feature (contrast barbiturates) and are seen only occasionally. Cardiovascular collapse and fatality are rare if supportive measures are instituted.

Opioid antagonists (naloxone, nalorphine) precipitate acute withdrawal syndrome in the

dependent subject. In the more severely dependent, even 0.2 mg of naloxone can precipitate marked withdrawal.

Treatment: consists of withdrawal of morphine and substitution with oral methadone (long-acting, orally effective) followed by gradual withdrawal of methadone. However, relapse rate among postaddicts is high. Long-term methadone maintenance and other techniques using agonist-antagonistic drugs are also employed.

PRECAUTIONS AND CONTRAINDICATIONS

Morphine is a drug of emergency, but due care has to be taken in its use.

1. Infants and the elderly are more susceptible to the respiratory depressant action of morphine.
2. It is dangerous in patients with respiratory insufficiency (emphysema, pulmonary fibrosis, cor pulmonale), sudden deaths have occurred.
3. Bronchial asthma: Morphine can precipitate an attack by its histamine releasing action.
4. Head injury: morphine is contraindicated in patients with head injury. Reasons are—
 - (a) By retaining CO_2 , it increases intracranial tension which will add to that caused by head injury itself.
 - (b) Even therapeutic doses can cause marked respiratory depression in these patients.
 - (c) Vomiting, miosis and altered mentation produced by morphine interfere with assessment of progress in head injury cases.
5. Hypotensive states and hypovolaemia exaggerate fall in BP due to morphine.
6. Undiagnosed acute abdominal pain: morphine can aggravate certain conditions, e.g. diverticulitis, biliary colic, pancreatitis. Inflamed appendix may rupture. Morphine can be given after the diagnosis is established. Pentazocine, buprenorphine are less likely to aggravate biliary spasm.
7. Elderly male: chances of urinary retention are high.
8. Hypothyroidism, liver and kidney disease patients are more sensitive to morphine.

9. Unstable personalities: are liable to continue with its use and become addicted.

Interactions

Phenothiazines, tricyclic antidepressants, MAO inhibitors, amphetamine and neostigmine potentiate morphine and other opioids, either by retarding its metabolism or by a pharmacodynamic interaction at the level of central neurotransmitters.

Morphine retards absorption of many orally administered drugs by delaying gastric emptying.

Dose: 10–50 mg oral, 10–15 mg i.m. or s.c. or 2–6 mg i.v.; 2–3 mg epidural/intrathecal; children 0.1–0.2 mg/kg.

MORPHINE SULPHATE 10 mg/ml inj; **MORCONTIN** 10, 30, 60, 100 mg continuous release tabs; 30–100 mg BD; **RILIMORF** 10, 20 mg tabs, 60 mg SR tab.

CLASSIFICATION OF OPIOIDS

1. **Natural opium alkaloids:** Morphine, Codeine

2. **Semisynthetic opiates:** Diacetylmorphine (Heroin), Pholcodeine.

Many others like—Hydromorphone, Oxymorphone, Hydrocodone, Oxycodone, are not used in India.

3. **Synthetic opioids:** Pethidine (Meperidine), Fentanyl, Methadone, Dextropropoxyphene, Tramadol.

Many others like—Levorphanol, Dextromoramide, Dipipanone, Alfentanil, Sufentanil, Remifentanil are not available in India.

1. Codeine It is methyl-morphine, occurs naturally in opium, and is partly converted in the body to morphine. It is less potent than morphine (1/10th as analgesic), also less efficacious; is a partial agonist at μ opioid receptor with a low ceiling effect. The degree of analgesia is comparable to aspirin (60 mg codeine ~ 600 mg aspirin); can relieve mild to moderate pain only.

However, it is more selective cough suppressant (only 1/3rd as potent as morphine); subanalgesic doses (10–30 mg) suppress cough (*see* p. 214). Codeine has very low affinity for opioid receptors. The analgesic action has been

ascribed to morphine generated by its demethylation by CYP2D6; codeine fails to produce analgesia in subjects with polymorphic CYP2D6. However, receptors involved in antitussive action appear to be distinct, because they bind codeine as well as morphine.

Codeine has good activity by the oral route (oral: parenteral ratio 1:2). A single oral dose acts for 4–6 hours. Constipation is a prominent side effect when it is used as analgesic. Codeine has been used to control diarrhoea (*see* Ch. 48). Other side effects are milder. The abuse liability is low. Though codeine phosphate is water soluble and can be injected, parenteral preparation is not available.

2. Pholcodeine It has codeine like properties and has been used mainly as antitussive (*see* p. 215); claimed to be less constipating.

3. Heroin (Diamorphine, Diacetylmorphine) It is about 3 times more potent than morphine; more lipid soluble: enters brain more rapidly but duration of action is similar. It is considered to be more euphoriant (especially on i.v. injection) and highly addicting. Because of its high potency, it has been favoured in illicit drug trafficking. The sedative, emetic and hypotensive actions are said to be less prominent. However, it has no outstanding therapeutic advantage over morphine and has been banned in most countries except U.K.

4. Pethidine (Meperidine)

Pethidine was synthesized as an atropine substitute in 1939, and has some actions like it. Though chemically unrelated to morphine, it interacts with opioid receptors and its actions are blocked by naloxone. Important differences in comparison to morphine are:

1. Dose to dose 1/10th in analgesic potency; however, analgesic efficacy approaches near to morphine and is greater than codeine.
2. After i.m. injection, the onset of action is more rapid but duration is shorter (2–3 hours).
3. It does not effectively suppress cough.
4. Spasmodic action on smooth muscles is less marked—miosis, constipation and urinary retention are less prominent.

Pethidine is believed to induce less biliary spasm than morphine; traditionally preferred in cholecystitis/biliary colic. However, there is no objective evidence to support

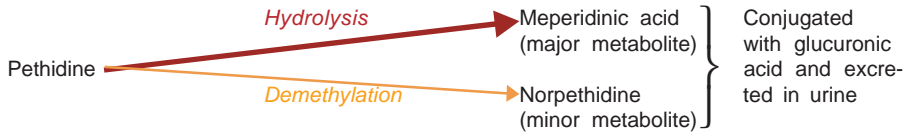

this belief. One study* in patients undergoing cholecystectomy found pethidine to raise common bile duct pressure 14% more than equianalgesic dose of morphine.

5. It is equally sedative and euphoriant, has similar abuse potential. The degree of respiratory depression seen at equianalgesic doses is equivalent to morphine.
6. Tachycardia (due to antimuscarinic action) occurs instead of bradycardia.
7. It causes less histamine release and is safer in asthmatics.
8. It has local anaesthetic action: corneal anaesthesia is seen after systemic doses.
9. It is well absorbed, oral: parenteral activity ratio is high (1/3 to 1/2). Pethidine is nearly completely metabolized in liver. The plasma $t_{1/2}$ of pethidine is 2–3 hours. Acidification of urine increases excretion of unchanged pethidine.

Side effects These are similar to morphine except those mentioned above. Some atropinic effects (dry mouth, blurred vision, tachycardia) may be noted in addition.

Overdose of pethidine produces many excitatory effects—tremors, mydriasis, hyperreflexia, delirium, myoclonus and convulsions. This is due to accumulation of *norpethidine* which has excitant effects. Renal failure patients given repeated doses of pethidine may also experience similar effects.

Nonselective MAO inhibitors interfere with hydrolysis but not with demethylation of pethidine—*norpethidine* is produced in excess and excitement occurs.

Tolerance and physical dependence develop slowly with pethidine. Probably due to its shorter duration of action, body functions get time to recover. For the same reason withdrawal syndrome develops more rapidly. Autonomic

disturbances are less marked during pethidine withdrawal, than after morphine withdrawal.

Use Pethidine is primarily used as an analgesic (substitute of morphine) and in preanaesthetic medication, but not for cough or diarrhoea. It has also been used to control shivering during recovery from anaesthesia or that attending i.v. infusions. Potential adverse effects due to accumulation of *norpethidine* limit its utility in patients who require repeated dosing. It is the preferred opioid analgesic during labour—at equianalgesic doses neonatal respiratory depression is less marked, but still significant. *Dose:* 50–100 mg i.m., s.c. (may cause irritation, local fibrosis on repeated injection), occasionally given orally or i.v.

PETHIDINE HCL 100 mg/2 ml inj; 50, 100 mg tab.

5. Fentanyl A pethidine congener, 80–100 times more potent than morphine, both in analgesia and respiratory depression. In analgesic doses it produces few cardiovascular effects; has little propensity to release histamine. Because of high lipid solubility, it enters brain rapidly and produces peak analgesia in 5 min after i.v. injection. The duration of action is short: starts wearing off after 30–40 min due to redistribution, while elimination $t_{1/2}$ is ~4 hr. In the injectable form it is almost exclusively used in anaesthesia (*see p. 376*). Transdermal fentanyl has become available for use in cancer or other types of chronic pain for patients requiring opioid analgesia.

DUROGESIC transdermal patch delivering 25 $\mu\text{g/hr}$, 50 $\mu\text{g/hr}$ or 75 μg per hour; the patch is changed every 2–3 days.

6. Methadone A synthetic opioid, chemically dissimilar but pharmacologically very similar to morphine—has analgesic, respiratory depressant, emetic, antitussive, constipating and biliary actions similar to morphine.

* See Lee F and Cundiff D; *Arch Intern. Med.* 158, (1998), 2399.

The most important feature of methadone is high oral: parenteral activity ratio (1 : 2) and its firm binding to tissue proteins. In single doses it is only slightly more potent than morphine and has comparable duration of action (4–6 hours on i.m. injection), but it cumulates in tissues on repeated administration—duration of action is progressively lengthened due to gradual release from these sites; plasma $t_{1/2}$ on chronic use is 24–36 hours. Plasma protein binding is 90% and it is metabolized in liver, primarily by demethylation and cyclization—metabolites are excreted in urine. Rifampin and phenytoin can cause withdrawal symptoms to appear in methadone dependent subjects by inducing its metabolism.

Because of slow and persistent nature of action, sedative and subjective effects are less intense. It is probably incapable of giving a 'kick'. The abuse potential is rated lower than morphine. Tolerance develops more slowly, probably due to progressive filling of tissue stores. Withdrawal syndrome is of gradual onset, taking 1–2 days after discontinuation, is prolonged and less severe.

Methadone has been used primarily as substitution therapy of opioid dependence: 1 mg of oral methadone can be substituted for 4 mg of morphine, 2 mg of heroin and 20 mg of pethidine. Another technique is *methadone maintenance* therapy in opioid addicts—sufficient dose of methadone is given orally to produce high degree of tolerance so that pleasurable effects of i.v. doses of morphine or heroin are not perceived and the subject gives up the habit.

It can also be used as an analgesic for the same conditions as morphine; dose 2.5–10 mg oral or i.m. but not s.c. It is occasionally employed as antitussive.

PHYSEPTONE 10 mg inj, 2 mg/5 ml linctus.

7. Dextropropoxyphene It is chemically related to methadone but is quite similar in analgesic action and in side effects to codeine, except that it is a poor antitussive and probably less constipating. It is nearly $\frac{1}{2}$ as potent as codeine and has a lower oral: parenteral activity ratio. It is metabolized in liver; $t_{1/2}$ is variable

(4–12 hours). Delirium and convulsions have occurred in overdose. The demethylated metabolite of propoxyphene is cardiotoxic. The abuse liability is similar to or lower than codeine.

Dextropropoxyphene (60–120 mg) is used as a mild oral analgesic. It is marketed only in combination with paracetamol \pm other drugs; but the contribution of dextropropoxyphene to the analgesic effect of the combination is questionable. The cardiac toxicity of its demethylated metabolite and seizures are dangerous in overdose; only partly antagonized by naloxone. Because of reported fatalities and no clear advantage of the combinations over paracetamol alone, such preparations have been withdrawn in the UK, but are quite popular in India, USA, etc, probably due to the perceived addictive potential of codeine.

PARVODEX 60 mg cap; PARVON, PROXYVON, WALAGESIC: dextropropoxyphene 65 mg + paracetamol 400 mg cap; WYGESIC, SUDHINOL 65 mg + paracetamol 650 mg cap.

8. Tramadol This centrally acting analgesic relieves pain by opioid as well as additional mechanisms. Its affinity for μ opioid receptor is low, while that for κ and δ is very low. Unlike other opioids, it inhibits reuptake of NA and 5-HT, and thus activates monoaminergic spinal inhibition of pain. Its analgesic action is only partially reversed by the opioid antagonist naloxone.

Injected i.v. 100 mg tramadol is equianalgesic to 10 mg i.m. morphine; oral bioavailability is good (oral: parenteral dose ratio is 1.4). The $t_{1/2}$ is 5 hours and effects last for 4–6 hrs. Tramadol causes less respiratory depression, sedation, constipation, urinary retention and rise in intrabiliary pressure than morphine. It is well tolerated; side effects are dizziness, nausea, sleepiness, dry mouth, sweating and lowering of seizure threshold. Haemodynamic effects are minimal.

Tramadol is indicated for mild-to-moderate short-lasting pain due to diagnostic procedures, injury, surgery, etc, as well as for chronic pain including cancer pain, but is not effective in

severe pain. Little tendency to dose escalation is seen and abuse potential is low.

Dose: 50–100 mg oral/i.m./slow i.v. infusion (children 1–2 mg/kg) 4–6 hourly.

CONTRAMAL, DOMADOL, TRAMAZAC 50 mg cap, 100 mg SR tab; 50 mg/ml inj in 1 and 2 ml amps.

USES (Of Morphine and its congeners).

1. *As analgesic* Opioid analgesics are indicated in severe pain of any type. However, they only provide symptomatic relief without affecting the cause. Pain may be valuable for diagnosis: should not be relieved by analgesic unless proper assessment of the patient has been done. Indiscriminate use of opioids can be hazardous. On the other hand, inadequate dose or reluctance to use these drugs in a patient in distress is equally deplorable.

Morphine or one of its parenteral congeners is indicated especially in traumatic, visceral, ischaemic (myocardial infarction), postoperative, burn, cancer pain and the like. It should be given promptly in myocardial infarction to allay apprehension and reflex sympathetic stimulation. Opioids, especially pethidine, have been extensively used for obstetric analgesia, but one must be prepared to deal with the foetal and maternal complications.

Adequate use of morphine (even i.v.) is indicated in an emergency. It may prevent neurogenic shock and other autonomic effects of excruciating pain. Opioids should not be restricted in case of pain of terminal illness (cancer pain), but for other chronic conditions, due consideration must be given to their addicting liabilities. Neuropathic pain responds less predictably to opioid analgesics.

Epidural (2–3 mg) or intrathecal (0.2 mg) injection of morphine produces segmental analgesia lasting ~12 hour without affecting other sensory, motor or autonomic modalities. It is being used for surgical analgesia in abdominal, lower limb and pelvic operations as well as for labour, postoperative, cancer and other intractable pain. Respiratory depression occurs after a delay due to ascent of the opioid through the subarachnoid space to the respiratory centre. Use of fentanyl in place of morphine produces faster analgesia and reduces the risk of respiratory depression because of greater uptake by nerves at the site of injection.

Patient controlled analgesia (PCA) is an attractive technique of postoperative pain control in which the patient himself regulates the rate of i.v. fentanyl infusion according to intensity of pain felt.

Transdermal fentanyl is a suitable option for chronic cancer and other terminal illness pain. The patch produces analgesia after ~12 hr, but then blood levels of fentanyl and intensity of analgesia remain fairly uniform if the patch is changed every 2–3 days.

For milder pain, e.g. toothache, headache, neuralgias, etc., aspirin-like analgesics are preferred. When they are not effective—codeine/dextropropoxyphene may be used orally, either alone or in combination with aspirin-like drug. The combination enhances the ceiling analgesia. For majority of painful conditions, especially more severe and longerlasting pain, a NSAID should be combined with the opioid; helps to enhance analgesia while keeping the opioid dose low.

2. *Preanaesthetic medication* Morphine and pethidine are used in few selected patients (*see* p. 378).

3. *Balanced anaesthesia and surgical analgesia* Fentanyl, morphine, pethidine, alfentanil or sufentanil are an important component of anaesthetic techniques (*see* p. 376-77).

4. *Relief of anxiety and apprehension* Especially in myocardial infarction, internal bleeding (haematemesis, threatened abortion, etc.) morphine or pethidine have been employed. However, they should not be used as anxiolytics or to induce sleep.

5. *Acute left ventricular failure (cardiac asthma)* Morphine (i.v.) affords dramatic relief by—

- (a) Reducing preload on heart due to vasodilatation and peripheral pooling of blood.
- (b) Tending to shift blood from pulmonary to systemic circuit; relieves pulmonary congestion and edema.
- (c) Allays air hunger by depressing respiratory centre.

- (d) Cuts down sympathetic stimulation by calming the patient, reduces cardiac work.

It is also indicated to relieve pulmonary edema due to infarction of lung and other causes, but not due to irritant gases. It is contraindicated in bronchial asthma.

6. Cough Codeine or its substitutes are widely used for suppressing dry, irritating cough (see Ch. 16).

7. Diarrhoea The constipating action of codeine has been used to check diarrhoea and to increase the consistency of stools in colostomy. Synthetic opioids exclusively used as anti-diarrhoeals are diphenoxylate and loperamide. The risk and benefits of their use are detailed in Ch. 48.

OPIOID RECEPTORS

Morphine and other opioids exert their actions by interacting with specific receptors present on neurones in the CNS and in peripheral tissues. Chemical modification of morphine structure has yielded a number of compounds which have a complex pattern of morphine-like and other agonistic and antagonistic actions that cannot be explained on the basis of a single opioid receptor. Radioligand binding studies have divided the opioid receptors into three types (μ , κ , δ); which have been cloned. Each has a specific pharmacological profile and pattern of anatomical distribution in the brain, spinal cord and peripheral tissues. Subtypes of μ and κ receptor have been identified. The proposed functional

role of the 3 types of opioid receptors is listed in Table 34.1.

Opioid ligands can interact with different opioid receptors as agonists, partial agonists or competitive antagonists. The overall pattern of effect of a particular agent depends not only on the nature of its interaction with different opioid receptors, but also on its relative affinity for these, e.g. morphine is an agonist on μ , κ and δ receptors, but its affinity for μ receptors is much higher than that for the other two. The effects, therefore, are primarily the result of μ receptor activation.

The nature and intensity of action of complex action opioids and antagonists are summarized in Table 34.2.

μ receptor The μ receptor is characterized by its high affinity for morphine. It is the major receptor mediating actions of morphine and its congeners. Endogenous ligands for μ receptor—peptides called *Endomorphins 1 and 2*—have only recently been found in mammalian brain—produce biological effects ascribed to this receptor. Other opioid peptides *viz.* β -endorphin, enkephalins and dynorphins bind to μ receptor with lower affinity. *β -funaltrexamine* is a relatively selective but irreversible μ antagonist. High density of μ receptors has been detected in periaqueductal gray, thalamus, nucleus tractus solitarius, nucleus ambiguus and area postrema.

Two subtypes of μ receptor have been proposed:

- μ_1 : Has higher affinity for morphine, mediates supraspinal analgesia and is selectively blocked by naloxonazine.
- μ_2 : Has lower affinity for morphine, mediates spinal analgesia, respiratory depression and constipating action.

Table 34.1: Actions ascribed to different types of opioid receptors

μ (<i>mu</i>)	κ (<i>kappa</i>)	δ (<i>delta</i>)
Analgesia (supraspinal μ_1 + spinal μ_2)	Analgesia (spinal κ_1) (Supraspinal- κ_2)	Analgesia (Spinal + Affective component of supraspinal)
Respiratory depression (μ_2)	Respiratory depression (lower ceiling)	Respiratory depression
Sedation	Dysphoria, psychotomimetic	Affective behaviour
Euphoria	Miosis (lower ceiling)	Reinforcing actions
Miosis	Sedation	Reduced g.i. motility
Reduced g.i. motility (μ_2)	Physical dependence (nalorphine type)	
Physical dependence (morphine type)	Reduced g.i. motility	

Table 34.2: Nature of interaction of opioid ligands with the three major types of opioid receptors, along with equivalent analgesic doses

Ligand	μ (<i>mu</i>)	κ (<i>kappa</i>)	δ (<i>delta</i>)	Analgesic* dose (mg)
1. Morphine	Ago. (St)	Ago. (W)	Ago. (W)	10
2. Nalorphine	Anta. (St)	Ago. (M)	—	—
3. Pentazocine	P.Ago., Anta. (W)	Ago. (M)	—	30–60
4. Butorphanol	P.Ago (W)	Ago. (St)	—	1–3
5. Buprenorphine	P.Ago	Anta. (M)	—	0.3–0.4
6. Naloxone	Anta. (St)	Anta. (M)	Anta. (W)	—
7. Naltrexone	Anta. (St)	Anta. (St)	Anta. (W)	—
8. Met/Leu enkephalin	Ago. (M)	—	Ago. (St)	—
9. β -Endorphin	Ago. (St)	—	Ago. (St)	—
10. Dynorphin A, B	Ago. (W)	Ago. (St)	Ago. (W)	—

* Equivalent single parenteral analgesic dose.

Ago—Agonist; Anta.—Antagonist

P. Ago—Partial agonist: have lower efficacy, though affinity (potency) may be high.

St—Strong action; M—Moderate action; W—Weak action (low affinity).

κ receptor This receptor is defined by its high affinity for ketocyclazocine and dynorphin A; the latter is considered to be its endogenous ligand. *Norbinaltorphimine* is a selective κ antagonist. Two subtypes of κ receptor κ_1 and κ_3 are functionally important. Analgesia caused by κ agonists is primarily spinal (through κ_1 receptor). However, κ_3 receptors mediate lower ceiling supraspinal analgesia. Other κ actions are listed in Table 34.1.

δ receptor This receptor has high affinity for leu/met enkephalins which are its endogenous ligands. The δ mediated analgesia is again mainly spinal (δ receptors are present in dorsal horn of spinal cord), but the affective component of supraspinal analgesia appears to involve δ receptors because these receptors are present in limbic areas—also responsible for dependence and reinforcing actions. The proconvulsant action is more prominent in δ agonists. Myenteric plexus neurones express high density of δ receptors—mediate reduced g.i. motility. *Naltrindole* is a selective δ antagonist.

It thus appears that μ and δ receptor responses are quite similar, but those exerted through κ receptor are distinct. In certain areas κ actions are antagonistic to μ actions.

The σ (sigma) receptor is no longer considered an opioid receptor, because it is neither activated by morphine nor blocked by naloxone. However, certain opioids, e.g. pentazocine, butorphanol and many unrelated compounds (including some hallucinogens) bind to σ receptors. Certain naloxone insensitive effects of pentazocine like drugs, e.g. dysphoria, psychotomimetic action, tachycardia, mydriasis are believed to be mediated by σ receptors.

Opioid receptor transducer mechanisms All 3 types of opioid receptors (μ , κ , δ) have been cloned; all are G-protein coupled receptors located mostly on prejunctional neurones. They generally exercise inhibitory modulation by decreasing release of the junctional transmitter (Fig. 34.1). As such, various monoaminergic (NA, DA, 5-HT), GABA, glutamate (NMDA/AMPA) pathways are intricately involved in opioid actions.

Opioid receptor activation reduces intracellular cAMP formation and opens K^+ channels (mainly through μ and δ receptors) or suppresses voltage gated N type Ca^{2+} channels (mainly κ receptor). These actions result in neuronal hyperpolarization and reduced availability of intracellular Ca^{2+} \rightarrow decreased neurotransmitter release by CNS and myenteric neurones (e.g. glutamate from primary nociceptive afferents).

However, other mechanisms and second messengers may also be involved, particularly in the long-term.

COMPLEX ACTION OPIOIDS AND OPIOID ANTAGONISTS

1. Agonist-antagonists (κ analgesics)

Nalorphine, Pentazocine, Butorphanol

2. Partial/weak μ agonist + κ antagonist

Buprenorphine

3. Pure antagonists

Naloxone, Naltrexone, Nalmefene

Clinically, the agonist-antagonist (agonist at one opioid receptor, antagonist at another) and partial/weak agonist (low intrinsic activity) opioids are analgesics of comparable efficacy to low doses of morphine, but with a limited dose range. They cause low ceiling respiratory depression and have lower abuse potential. However, in only few situations they have proven to be advantageous over the full μ receptor agonists.

1. Nalorphine It is N-allyl-normorphine; was the first opioid antagonist introduced in 1951 which could reverse morphine action. Later it was found to have agonistic actions as well. Nalorphine is a κ agonist and μ antagonist; has analgesic action with a lower ceiling, but is not used clinically because of dysphoric and psychotomimetic effects. Naloxone has replaced it as a morphine antidote.

2. Pentazocine It is the first agonist-antagonist to be used as an analgesic. It has weak μ antagonistic and more marked κ agonistic actions. The profile of action is similar to morphine; important differences are:

(a) Analgesia caused by pentazocine is primarily spinal (κ_1) and has a different character than that caused by morphine. Parenterally 30 mg pentazocine = 10 mg morphine; but ceiling effect is lower, i.e. at higher doses proportionate increase in analgesia does not occur.

(b) Sedation and respiratory depression is 1/3 to 1/2 of morphine at lower doses, and has a lower ceiling, does not increase much beyond 60 mg dose.

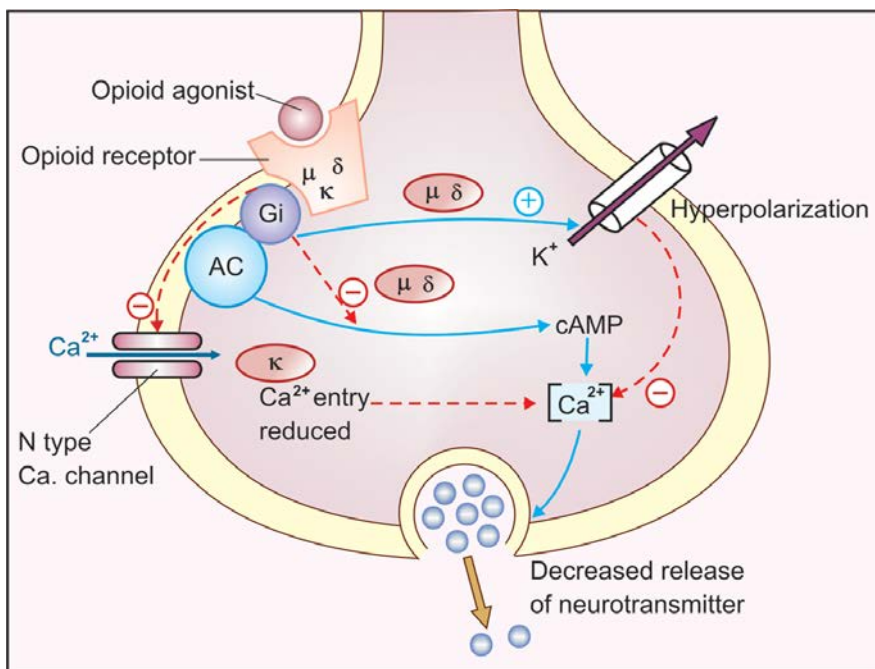

Fig. 34.1: Opioid receptor transducer mechanisms
AC-Adenylate cyclase; Gi-coupling protein; cAMP-Cyclic AMP

(c) Tachycardia and rise in BP are produced due to sympathetic stimulation. This may increase cardiac work; better avoided in coronary ischaemia and myocardial infarction.

(d) Biliary spasm and constipation are less severe.

(e) Vomiting is less frequent. Other side effects are sweating and lightheadedness.

(f) Subjective effects are pleasurable (morphine-like) at lower doses: recognised by post-addicts as an opiate. However, as dose is increased, these become unpleasant (nalorphine-like at > 60 mg i.m.) and psychotomimetic effects (κ , σ mediated) appear.

Tolerance, psychological and physical dependence to pentazocine develops on repeated use. Withdrawal syndrome has features of both morphine and nalorphine abstinence, but is milder in intensity. 'Drug seeking' occurs. Abuse liability is rated lower than morphine.

Injected in morphine dependent subjects, it precipitates withdrawal. Antagonistic action is 1/5th as potent as nalorphine: not enough to be useful in morphine poisoning. In pentazocine dependent subjects, high dose of naloxone precipitates withdrawal.

Pharmacokinetics and use Pentazocine is effective orally, though considerable first pass metabolism occurs; oral: parenteral ratio is 1 : 3. It is oxidized and glucuronide conjugated in liver and excreted in urine. Plasma $t_{1/2}$ is 3–4 hours, duration of action of a single dose is 4–6 hours. *Oral dose:* 50–100 mg, efficacy like codeine.

Parenteral dose: 30–60 mg i.m., s.c., may cause local fibrosis on repeated injection due to irritant property. **FORTWIN 25 mg tab., 30 mg/ml inj., PENTAWIN, SUSEVIN 30 mg/ml inj.**

Pentazocine is indicated for postoperative and moderately severe pain in burns, trauma, fracture, cancer, etc. Though abuse liability is low, frequent side effects and potential for dysphoric/psychotomimetic effect limits its utility in chronic (cancer) pain.

3. Butorphanol It is a κ analgesic, similar to but more potent than pentazocine (butorphanol

2 mg = pentazocine 30 mg). Likewise, analgesia and respiratory depression have a lower ceiling than morphine. Sedation, nausea, cardiac stimulation and other side effects are similar to pentazocine, but subjective effects are less dysphoric. Psychotomimetic effects are less marked (it is a weaker σ agonist at higher doses). BP is not increased.

Postaddicts recognize it as a barbiturate rather than opiate and mostly dislike it. However, it produces physical dependence; withdrawal can be precipitated by high dose of naloxone, but the syndrome is mild. The abuse potential of butorphanol is low. The most outstanding feature is that butorphanol can neither substitute for nor antagonize morphine. This shows its very weak interaction with μ receptors.

It has been used in a dose of 1–4 mg i.m. or i.v. for postoperative and other short-lasting (e.g. renal colic) painful conditions, but should be avoided in patients with cardiac ischaemia. The duration of action is similar to morphine.

BUTRUM 1 mg/ml, 2 mg/ml inj.

4. Buprenorphine It is a synthetic thebaine congener, highly lipid-soluble μ analgesic that is 25 times more potent than morphine. It has a slower onset and longer duration of action. After a single dose, analgesia lasts for 6–8 hours; but with repeated use, duration of action increases to ~24 hours. Certain other effects last still longer.

Sedation, vomiting, miosis, subjective and cardiovascular effects are similar to morphine, but constipation is less marked. Postural hypotension is prominent. Respiratory depression (and analgesia) exhibit ceiling effect. It substitutes for morphine at low levels of dependence but precipitates withdrawal in highly dependent subjects, reflecting its partial agonistic action at μ receptors. Antagonistic action on κ receptor has also been described.

Lower degree of tolerance and physical as well as psychological dependence develops with buprenorphine on chronic use. Its withdrawal syndrome resembles that of morphine, but is delayed for several days, is milder and longer

lasting. 'Drug seeking' is present. Abuse liability is rated lower than morphine.

Even naloxone (at high dose) only partially reverses buprenorphine effects and does not precipitate its withdrawal; probably because of more tight binding of buprenorphine to opioid receptors.

Buprenorphine has good efficacy by sublingual route, is highly plasma protein bound and remains in tissues for several days; $t_{1/2}$ is 40 hours. It is mostly excreted unchanged in bile and finds its way out of the body in faeces.

Dose: 0.3–0.6 mg i.m., s.c. or slow i.v., also sublingual 0.2–0.4 mg 6–8 hourly.

NORPHIN, TIDIGESIC 0.3 mg/ml inj. 1 and 2 ml amps. 0.2 mg sublingual tab; **BUPRIGESIC, PENTOREL** 0.3 mg/ml inj in 1, 2 ml amp.

Use: Buprenorphine is indicated for long-lasting painful conditions requiring an opioid analgesic, e.g. cancer pain. It has also been recommended for premedication, postoperative pain, in myocardial infarction and in the treatment of morphine dependence.

Buprenorphine is not suitable for use during labour, because if respiratory depression occurs in the neonate, it cannot be effectively reversed by naloxone.

Nalbuphine, Meptazinol and Dezocine are other agonist-antagonist opioids introduced in some countries.

PURE OPIOID ANTAGONISTS

1. Naloxone It is N-allylnor-oxymorphone and a competitive antagonist on all types of opioid receptors. However, it blocks μ receptors at much lower doses than those needed to block κ or δ receptors. It is devoid of any kind of agonistic activity even at high doses (20 times μ blocking dose). No subjective or autonomic effects are produced in individuals who have not received an opioid. No physical/psychological dependence or abstinence syndrome has been observed.

Injected intravenously (0.4–0.8 mg) it promptly antagonizes all actions of morphine: analgesia is gone, respiration is not only normalized but stimulated—probably due to sudden sensitization

of respiratory centre to retained CO_2 , or it is a manifestation of acute withdrawal, pupils dilate. However, sedation is less completely reversed.

At 4–10 mg dose it also antagonizes the agonistic actions of nalorphine, pentazocine, etc., but the dysphoric and psychotomimetic effects of some of them are incompletely suppressed: the naloxone insensitive component is believed to be mediated through σ receptors.

Actions of buprenorphine are prevented but not effectively reversed by naloxone, because it fails to displace buprenorphine that has already bound to the opioid receptors.

Naloxone 0.4 mg i.v. precipitates morphine withdrawal in dependent subjects: the syndrome lasts for 2–3 hours; 5 mg or more is required to precipitate nalorphine and pentazocine withdrawal.

Naloxone also blocks the actions of endogenous opioid peptides (*see* below). These peptides have been implicated in a variety of physiological functions; it is surprising that naloxone does not produce hyperalgesia or other effects in normal individuals. However, it has been found to render those individuals more susceptible to pain who normally have high tolerance. It blocks *placebo, acupuncture* and *stress* induced analgesia: showing involvement of endogenous opioid peptides in these. Naloxone partly antagonizes respiratory depression produced by certain nonopioids also, e.g. N_2O , diazepam.

Naloxone is inactive orally because of high first pass metabolism in liver. Injected i.v. it acts in 2–3 min. The primary pathway of metabolism is glucuronidation. Plasma $t_{1/2}$ is 1 hour in adults and 3 hours in newborns.

Adverse effects of naloxone are uncommon; may include rise in BP and pulmonary edema. **NARCOTAN** 0.4 mg in 1 ml (adult) and 0.04 mg in 2 ml (infant) amps; **NALOX, NEX** 0.4 mg inj.

Use Naloxone is the drug of choice for morphine poisoning (0.4–0.8 mg i.v. every 2–3 min: max 10 mg) and for reversing neonatal asphyxia due to opioid use during labour

(10 µg/kg in the cord). It is also used to treat overdose with other opioids and agonist-antagonists (except buprenorphine).

Other possible clinical applications of naloxone are:

- To reverse respiratory depression due to intraoperative use of opioids: 0.1–0.2 mg i.v. (this dose usually preserves analgesia in the postoperative period).
- It has also been tried as an adjunct to intraspinal opioid analgesia: reverses respiratory depression without abolishing pain relief.
- Diagnosis of opioid dependence—precipitates withdrawal in dependent subjects.
- It also partially reverses alcohol intoxication.
- Naloxone has been found to elevate BP in endotoxic or hypovolaemic shock, stroke and spinal injury. In these conditions injection of morphine worsens cardiovascular status and opioid peptides are believed to be involved in the pathogenesis. However, the value of naloxone compared to conventional therapy is uncertain.

2. Naltrexone It is chemically related to naloxone and is another pure opioid antagonist, that is devoid of subjective and other agonistic effects, but very high doses have caused unpleasant feelings in some individuals. It is more potent than naloxone. Naltrexone differs from naloxone in being orally active and having a long duration of action (1–2 days) which makes it suitable for ‘opioid blockade’ therapy of postaddicts: 50 mg/day is given orally so that if the subject takes his/her usual shot of the opioid, no subjective effects are produced and the craving subsides. Alcohol craving is also reduced by naltrexone; it is being used to prevent relapse of heavy drinking (*see p. 385*). Side effects are nausea and headache; high doses can cause hepatotoxicity.

NALTIMA 50 mg tab.

3. Nalmefene This pure opioid antagonist lacks hepatotoxicity of naltrexone, has higher oral bioavailability and is longer acting.

ENDOGENOUS OPIOID PEPTIDES

In the mid 1970s, with herculean efforts, a number of peptides having morphine-like actions were isolated from mammalian brain, pituitary, spinal cord and g.i.t. These are active in very small amounts, their actions are blocked by naloxone, and they bind with high affinity to

the opioid receptors. There are 3 distinct families of opioid peptides. Each is derived from a specific large precursor polypeptide.

1. Endorphins β-endorphin (β-END) having 31 amino acids is the most important of the endorphins. It is derived from Pro-opiomelanocortin (POMC) which also gives rise to γ-MSH, ACTH and two lipotropins. β-END is primarily μ agonist, but also has δ action.

2. Enkephalins Methionine-enkephalin (met-ENK) and leucine-enkephalin (leu-ENK) are the most important. Both are pentapeptides. The large precursor peptide *proenkephalin* has 4 met-ENK and 1 leu-ENK residues. The two ENKs have a slightly different spectrum of activity; while met-ENK has equal affinity for μ and δ sites, leu-ENK prefers δ receptors.

3. Dynorphins Dynorphin A and B (DYN-A, DYN-B) are 8–17 amino acid peptides derived from *prodynorphin* which contains 3 leu-ENK residues also. DYNs are more potent on κ receptors, but also activate μ and δ receptors.

Distribution of the 3 families of peptides is summarized below:

- 1. POMC** (limited distribution)
 - Arcuate nucleus which sends projections to limbic areas and medulla.
 - Anterior pituitary (modulates hormone release).
 - Pancreatic islets (modulates insulin, glucagon release).
- 2. Proenkephalin** (wide distribution)
 - Pain areas in spinal cord, trigeminal nucleus, periaqueductal grey matter.
 - Affective areas in limbic system, locus coeruleus and cortex.
 - Medulla (autonomic functions).
 - Median eminence of hypothalamus (neuro-endocrine control).
 - Adrenal medulla, gastric and intestinal glands.
- 3. Prodynorphin**
 - Wide distribution roughly parallel to proenkephalin, but in distinct neurones of the same area.

The opioid peptides constitute an endogenous opioid system which normally modulates pain perception, mood, hedonic (pleasure related) and

motor behaviour, emesis, pituitary hormone release and g.i.t. motility, etc.

β -END injected directly into the brain is 20–40 times more potent analgesic than morphine. Its primary localization in hypothalamus and pituitary and its long $t_{1/2}$ ascribes it a *neurohormone* function which modulates the release of other hormones. It decreases LH, FSH release and increases GH and prolactin release. Naloxone has opposite effects on the levels of these hormones—suggesting that the system is constitutively active.

The wide distribution of ENKs and DYNs and their short $t_{1/2}$ suggests function as *neuromodulator* or *neurotransmitter*. They appear to regulate pain responsiveness at spinal and supraspinal levels. Naloxone blocks placebo, acupuncture and stress-induced analgesias, suggesting the involvement of opioid peptides in

these responses. Opioid peptides also appear to participate in regulation of affective behaviour and autonomic function.

Recently a novel opioid peptide Nociceptin/orphanin FQ (N/OFQ) has been isolated from mammalian brain. It is localized in cortex, hippocampus, spinal cord and certain sensory sites; is believed to play a role in stress response, reward and reinforcing actions, learning and memory. The N/OFQ receptor, also labelled 'Opioid-receptor-like-1' (ORL-1) receptor, is thus the 4th opioid receptor to be identified. At certain sites, N/OFQ can act as an 'antioioid' through the ORL-1 receptor. In the pain control mechanisms, N/OFQ appears to play both opioid-like as well as antagonistic roles, depending on the site and the basal state of pain.

Morphine and other opioids act as exogenous agonists on some of the receptors for these peptides. This has given an explanation for the existence of specific receptors in the body for exogenous substances like morphine. Morphine itself has now been detected in mammalian brain.

CHAPTER 35

CNS Stimulants and Cognition Enhancers

CNS STIMULANTS

These are drugs whose primary action is to stimulate the CNS globally or to improve specific brain functions.

The CNS stimulants mostly produce a generalized action which may, at high doses, result in convulsions. Given below is a working classification based primarily on the clinical use, because clearcut differences do not exist.

CLASSIFICATION

1. **Convulsants** Strychnine, Picrotoxin, Bicuculline, Pentylentetrazol (PTZ).
2. **Analeptics** Doxapram
3. **Psychostimulants** Amphetamines, Methylphenidate, Modafinil, Pemoline, Cocaine, Caffeine.

Many other drugs are capable of causing CNS stimulation as side effect or at high doses.

I. CONVULSANTS

1. **Strychnine** It is an alkaloid from the seeds of *Strychnos nux-vomica*, and a potent convulsant. The convulsions are reflex, tonic-clonic and symmetrical. It has been labelled as a spinal convulsant because the dose producing convulsions is the same in spinal and intact animals; actually it stimulates the whole cerebrospinal axis.

Strychnine acts by blocking post-synaptic inhibition produced by the inhibitory transmitter glycine. One of the sites that has been clearly demonstrated is the Renshaw cell-motoneurone junction in the spinal cord through which inhibition of antagonistic muscles is achieved. Due to loss of synaptic inhibition, any nerve impulse becomes generalized, resulting in apparent excitation and convulsions.

There are no valid uses of strychnine now. Tonics containing strychnine are banned in India. It is only of toxicological importance. Accidental poisonings, especially in children, do occur. Treatment of poisoning is similar to that of status epilepticus (see Ch. 30).

2. **Picrotoxin** Obtained from 'fish berries' of East Indies *Anamirta cocculus*. It is a potent convulsant—convulsions are clonic, spontaneous and asymmetrical. The convulsions are accompanied by vomiting, respiratory and vasomotor stimulation. Though regarded as a medullary stimulant, it has little selectivity in site of action.

Picrotoxin acts by blocking presynaptic inhibition mediated through GABA. However, it is not a competitive antagonist: does not act on GABA receptor itself, but on a distinct site and prevents Cl^- channel opening (see p. 395). Diazepam, which facilitates GABAergic transmission, is the drug of choice for picrotoxin poisoning. Picrotoxin has no therapeutic indication now.

3. **Bicuculline** This synthetic convulsant has picrotoxin-like actions. It is a competitive GABA_A receptor (intrinsic Cl^- channel receptor) antagonist, while GABA_B receptor (G-protein coupled receptor) is insensitive to it. It is used only as a research tool.

4. **Pentylentetrazol (PTZ, Metrazol, Leptazol)** It is a powerful CNS stimulant, believed to be acting by direct

depolarization of central neurones. However, it has also been shown to interfere with GABAergic inhibition—may be acting in a manner analogous to picrotoxin.

Low doses cause excitation, larger doses produce convulsions which are similar in pattern to those caused by picrotoxin. It is the most commonly used convulsant for testing anticonvulsant drugs in laboratory animals (see Ch. 30), but there is no clinical use.

II. ANALEPTICS (Respiratory stimulants)

These are drugs which stimulate respiration and can have resuscitative value in coma or fainting. They do stimulate respiration in subconvulsive doses, but margin of safety is narrow; the patient may get convulsions while still in coma. Mechanical support to respiration and other measures to improve circulation are more effective and safe.

The role of analeptics in therapeutics is very limited. Situations in which they may be employed are:

- (a) As an expedient measure in hypnotic drug poisoning until mechanical ventilation is instituted.
- (b) Suffocation on drowning, acute respiratory insufficiency.
- (c) Apnoea in premature infant.
- (d) Failure to ventilate spontaneously after general anaesthesia.

The overall utility of analeptics is dubious; given in coma they are not active except in near convulsive doses.

Doxapram It acts by promoting excitation of central neurones. At low doses it is more selective for the respiratory centre than other analeptics. Respiration is stimulated through carotid and aortic body chemoreceptors as well. Falling BP rises. Continuous i.v. infusion of doxapram has been found to abolish episodes of apnoea in the premature infant not responding to theophylline. Other uses: see above.

Dose: 40–80 mg i.m. or i.v.; 0.5–2 mg/kg/hr i.v. infusion. **CAROPRAM 20 mg/ml in 5 ml amp.**

Reflex stimulation Smelling ammonia or a drop of alcohol in the nose may be enough for hysterical fainting; analeptics should not be used.

III. PSYCHOSTIMULANTS

These drugs have predominant cortical action; their psychic effects are more important than those on medullary vital centres.

1. Amphetamines These are central sympathomimetics. Compared to amphetamine, higher central: peripheral activity ratio is exhibited by dextroamphetamine and methamphetamine. They stimulate mental rather than motor activity;

convulsive doses are much higher. Their pharmacology and uses are described in Ch. 9.

2. Methylphenidate It is chemically and pharmacologically similar to amphetamine. Both act primarily by releasing NA and DA in the brain. Both produce increase in mental activity at doses which have little action on other central and peripheral functions. Methylphenidate is considered superior to amphetamine for hyperkinetic children (attention deficit hyperkinetic disorder) because it causes lesser tachycardia and growth retardation. Behaviour and learning ability are improved in 3 out of 4 treated children. It can also be used for concentration and attention defect in adults, and for narcolepsy, but should not be employed to treat depression, dementia, obesity or to keep awake.

Methylphenidate is well absorbed orally, metabolized and excreted in urine, plasma $t_{1/2}$ is 4–6 hours, but central effect lasts much longer. Twice daily dosing (morning and afternoon) is enough.

Side effects are anorexia, insomnia, abdominal discomfort and bowel upset.

Dose: Adults 5–10 mg BD; children 0.25 mg/kg/day initially, increased up to 1 mg/kg/day if needed. **RETALIN 5, 10 mg tab.**

3. Modafinil It is a recently introduced psychostimulant that is getting popular with night-shift (call centre) workers and other professionals who want to improve alertness and keep awake. It is claimed to increase attention span and improve accuracy compromised by fatigue and sleepiness. The approved indications are day-time sleepiness due to narcolepsy, sleep-apnoea syndrome and shift-work sleep disorder. It has also been found to reduce euphoria produced by cocaine and to suppress cocaine withdrawal symptoms; is being evaluated as a drug to reduce relapse of cocaine dependence.

The most common side effects are insomnia and headache. Others are nausea, dyspepsia, dizziness, confusion, amnesia, personality disorders, tremors and hypertension. Dependence is a possibility on long-term use.

Modafinil is absorbed within 2–4 hours of oral administration, and is eliminated with a $t_{1/2}$ of 15 hours.

Dose: 100–200 mg morning and afternoon for day-time sleepiness due to narcolepsy or sleep-apnoea syndrome; or 200 mg 1 hour before starting night-shift work.

MODALERT 100, 200 mg tabs.

4. Pemoline Though chemically unrelated, pemoline has CNS stimulant actions similar to those of methylphenidate. Sympathomimetic and CVS actions are insignificant. It probably activates dopaminergic mechanisms in the brain. Pemoline has been used in attention deficit-hyperkinetic disorder, narcolepsy and excessive day-time sleepiness, with benefits and side effects similar to methylphenidate. However, therapeutic effect develops gradually over 3–4 weeks and a single morning dose is enough because of its longer $t_{1/2}$ (8–12 hrs). Reports of hepatotoxicity have limited its use.

5. Cocaine (*see* Ch. 26)

6. Caffeine Out of the three naturally occurring methylxanthines, only caffeine is used as a CNS stimulant. Its pharmacological actions are described in Ch. 16 along with those of theophylline.

Pharmacokinetics Caffeine has poor water solubility; is rapidly but irregularly absorbed after oral administration. It is < 50% bound to plasma proteins, distributed all over the body; volume of distribution is 0.5 L/kg. It is nearly completely metabolized in liver by demethylation and oxidation, and excreted in urine; plasma $t_{1/2}$ is 3–6 hours in adults.

Adverse effects Toxic effects of caffeine are extensions of its pharmacological actions. Caffeine poisoning is rare, and it is less toxic than theophylline.

Gastric irritation, nausea and vomiting may occur as side effects.

Excitatory and motor effects are produced at toxic doses—nervousness, insomnia, agitation, muscular twitching, rigidity, rise in body temperature, delirium and convulsions.

Tachycardia, occasionally extrasystoles.

Caffeine is to be avoided in peptic ulcer patients. It is not contraindicated in gout because it is not converted in the body to uric acid. Moderate coffee drinking does not contribute to development of hypertension.

Uses

1. In analgesic mixture: caffeine benefits headache probably by allaying fatigue and boredom. It has no analgesic action of its own.
2. Migraine: Caffeine is used in combination with ergotamine for treatment of an attack. It appears to benefit by augmenting constriction of cranial vessels by its direct action and by enhancing absorption of ergotamine from the g.i.t.
3. Apnoea in premature infants: as alternative to theophylline (*see* Ch. 16).

Caffeine is available only in combined formulations with ergotamine or analgesics in tablets.

CAFERGOT: Caffeine 100 mg + ergotamine 1 mg tab.

MICROPYRIN: Caffeine 20 mg + aspirin 350 mg tab.

Tonics containing caffeine are banned in India.

COGNITION ENHANCERS (Cerebroactive drugs)

These are a heterogenous group of drugs developed for use in dementia and other cerebral disorders. They do elicit pharmacological effects, but widely different mechanisms of action are claimed and therapeutic benefits are uncertain.

Dementia Refers to acquired global impairment of intellect, memory and personality (cognitive functions) in the absence of gross clouding of consciousness or motor involvement. Memory, capacity to solve problems of day to day living, performance of learned motor skills, social skills and control of emotions are primarily affected.

Alzheimer's disease (AD) A progressive neurodegenerative disorder which affects older individuals and is the most common cause of dementia. It may progress to a totally vegetative state. Atrophy of cortical and subcortical areas is associated with deposition of β -amyloid protein in the form of senile plaques, and formation of neurofibrillary tangles. There is marked cholinergic deficiency in the brain, though other neurotransmitter systems are also affected.

The indications of cognition enhancers include:

1. Senile dementia of Alzheimer type (DAT) and multi infarct dementia (MID).
2. 'Common symptoms' of the elderly; dizziness and memory disturbances.
3. Mental retardation in children, learning defects, attention deficit disorder.

4. Transient ischaemic attacks (TIAs), cerebrovascular accidents—stroke.
5. Organic psychosyndromes and sequelae of head injury, ECT, brain surgery.

The above therapeutic field is barren and commercially highly profitable. A variety of drugs have been briskly promoted by manufacturers and wishfully prescribed by physicians. The mechanism by which they are believed to act are:

1. Increasing global/regional cerebral blood flow (CBF)
2. Direct support of neuronal metabolism.
3. Enhancement of neurotransmission.
4. Improvement of discrete cerebral functions, e.g. memory.

All cerebroactive drugs are tested for their vasodilator activity. The basic assumption has been that improvement in cerebral circulation is possible, real and therapeutically useful. However, precise measurements have shown that in many cases such claims are merely expectations. In stroke a global vasodilator effect may even be harmful—may worsen cerebral edema; and induce ‘steal’ phenomenon, i.e. diversion of blood flow to non-ischaemic areas to the detriment of ischaemic area. Cerebral blood flow is reduced in AD, but this is probably a consequence of loss of neurones and not its cause.

The cerebroactive drugs may be grouped into:

- a. **Cholinergic activators:**
Tacrine, Rivastigmine, Donepezil, Galantamine
- b. **Glutamate (NMDA) antagonist:**
Memantine
- c. **Miscellaneous cerebroactive drugs:**
Piracetam, Pyritinol (Pyrithioxine), Dihydroergotoxine (Codergocrine), Piribedil, Ginkgo biloba

1. Cholinergic activators Since brain ACh levels are markedly reduced and cholinergic neurotransmission is the major sufferer in AD, various approaches to augment brain ACh have been tried. Precursor loading with choline or

lecithin have failed because there is no shortage of these substrates in the brain. Cholinergic agonists (arecoline, bethanechol, oxotremorine) and conventional anticholinesterases (anti-ChEs) like physostigmine produce symptom improvement, but at the cost of marked peripheral side effects. Over the past decade 4 cerebrosselective antiChEs have been introduced for use in AD.

Tacrine It is the first centrally acting anti-ChE to be introduced for AD. In clinical trials tacrine produced significant improvement in memory, attention, praxis, reason and language. However, it does not alter course of the underlying disease process. Frequent side effects and hepatotoxicity have restricted its use.

Rivastigmine This carbamate derivative of physostigmine inhibits both AChE and BuChE, but is more selective for the G1 isoform of AChE that predominates in certain areas of the brain. Rivastigmine is highly lipid-soluble—enters brain easily. Greater augmentation of cholinergic transmission in brain is obtained with mild peripheral effect. The carbamyl residue introduced by rivastigmine into AChE dissociates slowly resulting in inhibition of cerebral AChE for upto 10 hours despite the 2 hr plasma $t_{1/2}$ of the drug.

In clinical trials an average of 3.8 point improvement in Alzheimer’s Disease Assessment Scale (ADAS-cog) has been obtained compared to placebo. Other symptoms like apathy, delusions, hallucinations and agitation also improve, though disease progression is not affected. Peripheral cholinergic side effects are mild. It has not produced liver damage.

Dose: Initially 1.5 mg BD, increase every 2 weeks by 1.5 mg/day upto 6 mg/BD.

EXELON, RIVAMER 1.5, 3, 4.5, 6.0 mg caps.

Donepezil This cerebrosselective and reversible anti-AChE produces measurable improvement in several cognitive as well as non-cognitive (activities of daily living) scores in AD, which is maintained at least upto 2 years. The benefit is ascribed to elevation of ACh level in the cortex, especially in the surviving neurones that project from basal forebrain to cerebral cortex and

hippocampus. Therapeutic doses produce only weak peripheral AChE inhibition: cholinergic side effects are mild. Because of long $t_{1/2}$ (~70 hr), donepezil is administered once daily at bed time; a distinct advantage over rivastigmine and galantamine which need twice daily dosing. It is generally well tolerated and is not hepatotoxic.

Dose: 5 mg OD HS (max 10 mg OD);

DONECEPT, DOPEZIL 5, 10 mg tabs.

Galantamine It is a natural alkaloid which selectively inhibits cerebral AChE and has some direct agonistic action on nicotinic receptors as well. Galantamine has produced cognitive and behavioural benefits in AD which are comparable to rivastigmine and donepezil. It is well tolerated, but needs twice daily dosing.

Dose: 4 mg BD (max 12 mg BD)

GALAMER 4, 8, 12 mg tabs.

There is now firm evidence that rivastigmine, donepezil and galantamine afford similar, but modest symptomatic benefit in AD. Cognitive decline is slowed, but not prevented. Their side effects are also comparable. However, role of these drugs in non-Alzheimer dementia is not clear.

2. Memantine This new NMDA receptor antagonist, related to amantadine (also a NMDA antagonist), has been found to slow the functional decline in moderate-to-severe AD, but benefit in milder disease are unclear. It appears to block excitotoxicity of the transmitter glutamate in a noncompetitive and use-dependent manner. Beneficial effects have also been noted in parkinsonism.

Memantine is better tolerated than anti-AChEs used in AD. Side effects are constipation, tiredness, headache and drowsiness. It is indicated in moderate-to-severe AD.

Dose: Initially 5 mg OD, increase gradually upto 10 mg BD; stop if no clinical benefit in 6 months.

ADMENTA 5, 10 mg tabs.

3. Piracetam This cyclic GABA derivative has no GABA-like activity and has been called 'nootropic' meaning a drug that selectively improves efficiency of higher telencephalic integrative activities purportedly by:

- Enhancement of learning and memory.

- Facilitation of synaptic transmission and inter-hemisphere information transfer.

- Increased tonic cortical control on subcortical areas.

Piracetam is not a vasodilator, does not affect total/regional CBF, but may reduce blood viscosity. In India and some other countries it has been promoted for cognitive impairment and dementia in the elderly as well as for mental retardation in children for nearly 30 years. However, a recent (2004) Cochrane Database review has concluded that published data does not support such use. In the UK, it is approved for adjunctive treatment of cortical myoclonus, and is not recommended for children. It is not approved in the USA.

Side effects are minor: gastric discomfort, nervousness, excitement, insomnia, dizziness and skin rash.

Dose: 0.8–1 g TDS oral; children 20 mg/kg BD–TDS; 1–3 g i.m. 6 hourly in stroke/head injury.

NORMABRAIN, NEURO CETAM, NOOTROPIL 400, 800 mg cap, 500 mg/5 ml syr., 300 mg/ml inj.

4. Pyritinol (Pyrithioxine) Pyritinol consists of two pyridoxine molecules joined through a disulfide bridge, but has no vit B₆ activity. It is claimed to activate cerebral metabolism by selectively increasing glucose transport across blood-brain barrier and improving regional blood flow in ischaemic brain areas. It has been promoted for:

- Sequelae of cerebrovascular accidents, head injury, prolonged anaesthesia.
- Infants and children with developmental disorders of CNS, delayed milestones.
- Concentration and memory defects, senility, organic brain syndromes.

However, therapeutic benefit, if any, is uncertain.

ENCEPHABOL 100, 200 mg tab. 100 mg/5 ml suspension; 200 mg dry powder with 2 ml solvent for i.v. infusion.

Dose: 100–200 mg TDS, children 50–100 mg TDS orally; 200–400 mg every 4–6 hours (max. 1 g/day) has been given i.v. for recovery from cerebral hypoxia due to cardiac arrest, anaesthesia, brain operations and stroke.

Side effects: Only mild g.i. upset was reported initially. Later skin rashes, itching and taste disturbances (attributable to the disulfide moiety) have been reported. It has been withdrawn in some countries.

5. Dihydroergotoxine (Codergocrine): It is a semi-synthetic ergot alkaloid having adrenergic blocking property; claimed to increase cerebral blood flow selectively. It is believed to act by protecting altered brain metabolism. In a dose of 1.0–1.5 mg TDS oral/sublingual or 0.3 mg i.m. OD, it has been recommended for DAT, MID and in the elderly with mild to moderate dementic symptoms, but therapeutic value is not established.

HYDERGINE 1 mg tab, 0.3 mg/ml inj. CERELOID 1 mg tab.

Side effects: flushing, headache, nasal congestion, postural hypotension, g.i. disturbances and rashes.

6. Piribedil: It is a dopaminergic agonist claimed to improve memory, concentration, vigilance, giddiness and tinnitus in the elderly, but benefit is unsubstantiated. Mild efficacy in parkinsonism has also been reported. Side effects are mild g.i. complaints.

Dose: 50 mg OD, BD; **TRIVASTAL LA 50 mg tab.**

7. Ginkgo biloba The dried extract of this Chinese plant contains a mixture of ginkgoflavon glycosides (e.g. ginkgolide B) which have PAF antagonistic action. Since

PAF has been implicated in cerebral thrombosis and infarcts, it is argued that *G. biloba* will prevent cerebral impairment in MID. It has been promoted for a variety of cognitive and behavioral disorders in the elderly, but a controlled trial has failed to detect improvement in age-related memory impairment or dementia.

Side effects are mild upper g.i.t. symptoms, but i.v. infusion has caused fever, shock and arrhythmia.

Dose: 40 mg TDS for a minimum period of 4 weeks; **GINKOCER, BILOVAS, GINKOBA 40 mg tab.**

Cardiovascular Drugs

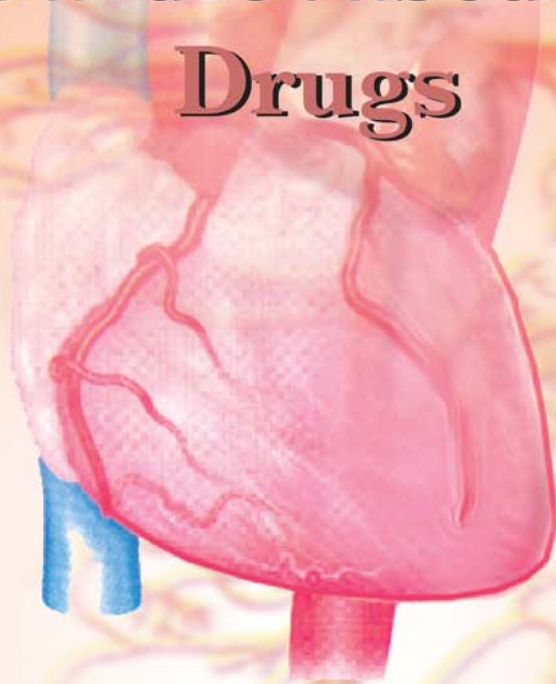

SECTION
8

Cardiac Electrophysiological Considerations

Drugs having their major action on heart or blood vessels, or those used primarily for cardiovascular disorders are designated cardiovascular drugs. They can act directly on the cardiovascular structures or through the autonomic/central nervous system, kidney, autacoids or hormones which regulate cardiovascular function.

CARDIAC ELECTROPHYSIOLOGY

The properties which are especially important for understanding drug action on heart are:

1. Impulse generation Electrophysiologically, two types of myocardial fibres can be distinguished (Fig. VIII.1).

(a) **Nonautomatic fibres** These are the ordinary working myocardial fibres; cannot generate an impulse of their own. During diastole, the resting membrane potential remains stable (approximately 90 mV negative inside). When stimulated, they depolarize very rapidly (fast 0 phase) with considerable overshoot (+30 mV) → rapid return to near isoelectric level (phase-1) → maintenance of membrane potential at this level for a considerable

period (phase-2, plateau phase) during which Ca^{2+} ions flow in and bring about contraction → relatively rapid repolarization (phase-3) during which membrane Na^+K^+ pump gets activated and tends to restore ionic distribution to the resting pattern. Resting membrane potential, once attained, does not decay (stable phase-4).

(b) **Automatic fibres** These are present in the sinoatrial (SA) and atrioventricular (A-V) nodes, and in the His-Purkinje system, i.e. specialized conducting tissue. In addition, patches of automatic tissue are present in the interatrial septum, A-V ring and around openings of the great veins. The most characteristic feature of these fibres is *phase-4 or slow diastolic depolarization*, i.e. after repolarizing to the maximum value, the membrane potential decays spontaneously. When it reaches a critical threshold value—sudden depolarization occurs automatically. Thus, they are capable of generating their own impulse. The rate of impulse generation by a particular fibre depends on the value of maximal diastolic potential, the slope of phase-4 depolarization and the value of threshold potential.

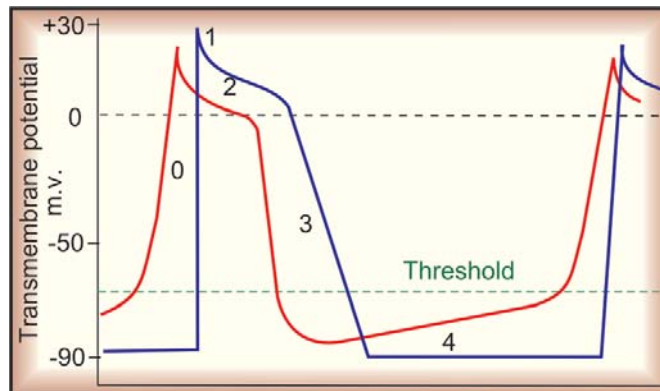

Fig. VIII.1: Transmembrane potential of automatic (Red) and nonautomatic (Purple) myocardial fibres recorded through intracellular electrodes

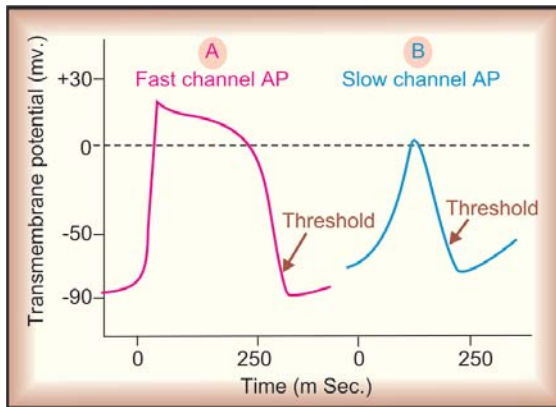

Fig. VIII.2: (A) Fast channel action potential (AP) in a Purkinje fibre, (B) Slow channel action potential in a SA node fibre

Normally, the SA node has the steepest phase-4 depolarization, undergoes self-excitation and propagates the impulse to the rest of the heart—acts as the *pacemaker*. Other fibres which are also undergoing phase-4 depolarization, but at a slower rate, receive the propagated impulse before reaching threshold value and remain as *latent pacemakers*.

Two types of action potential (AP) are possible. These are depicted in Fig. VIII.2. Their characteristics are given in Table VIII. 1.

The slow channel AP is characterised by:

- (a) Initiation at a higher threshold (less negative level).
- (b) Slow depolarization during 0 phase.

- (c) Less overshoot, low amplitude.
- (d) Very slow propagation, decremental conduction and a low safety factor for conduction.
- (e) Can arise and propagate in fibres too depolarized to support fast channel responses.

Slow channel AP in SA node, A-V node, etc. has a shorter duration and phases 1–3 are not clearly demarkated. Slow channel AP can occur in Purkinje fibres (PF) also, but this has a much longer duration with a prominent plateau phase.

2. Conduction The rate of conduction through a fibre is a function of its *membrane responsiveness*, which is defined by rate of rise of AP (dv/dt) as a function of membrane potential at which activation occurs (Fig. VIII.3); a more completely polarized membrane depolarizes faster. This type of relationship is seen in atrial, ventricular and Purkinje fibres (fast channel fibres which depolarize by Na^+ current), but not in SA and A-V nodal cells which remain refractory for some time even after attainment of maximal resting potential.

The Na^+ channels get progressively inactivated as the resting membrane potential (RMP) drops over the -80 to -60 mV range. Consequently, less negative the RMP at which activation occurs, fewer are the Na^+ channels available for activation—slope of '0' phase depolarization, AP amplitude and conduction velocity are reduced.

A drug which reduces the slope of 0 phase (at any given resting membrane potential) will shift the membrane responsiveness curve to the right and impede conduction. The reverse occurs with

Table VIII.1: Characteristics of fast channel and slow channel action potentials

	Fast channel AP	Slow channel AP
1. Sites of occurrence	Atria, ventricles, Purkinje fibres	SA and A-V nodes, round A-V ring, coronary sinus opening
2. Predominant ion moving in 0 phase	Na^+	Ca^{2+}
3. Activation-inactivation kinetics	Fast	Slow
4. Activation potential (threshold voltage)	-60 to -70 mV	-45 to -55 mV
5. Conduction velocity	0.5–5 m/sec	0.01–0.1 m/sec
6. ERP–APD* relationship	ERP < APD	ERP > APD
7. Selective channel blocker	Tetrodotoxin, Local anaesthetics	Verapamil, Diltiazem, Mn^{2+}

*ERP—Effective refractory period; APD—Action potential duration.

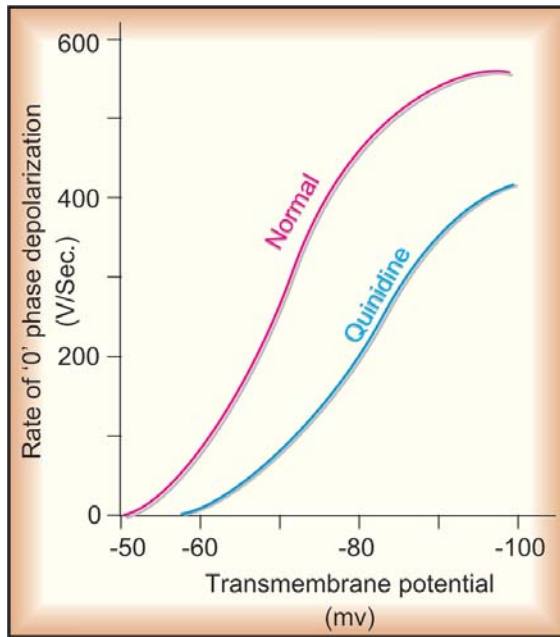

VIII.3: Membrane responsiveness curve of a myocardial fibre showing the relationship between membrane polarization and dv/dt of 0 phase. Note the depressant action of quinidine

a drug that shifts the curve to the left. Membrane responsiveness curve can also be altered by disease.

Small cells at the upper margin of A-V node have very low conduction velocity (20 mm/sec). Normally Purkinje fibres (PFs) have the highest conduction velocity (4000 mm/sec) except near their junction with the ventricular fibres 'gate region', or if they change over from fast channel to slow channel response.

3. Excitability This property of a fibre is defined by the strength of stimulus required to elicit a response or to produce an AP. Hyperpolarization decreases excitability while small reductions in resting membrane potential increase excitability by respectively increasing and decreasing the gap between it and the threshold potential. Thus, in fast channel fibres excitability

is generally super-normal during the end of phase-3. However, when the resting membrane potential is reduced to a value below the threshold potential, the fibre becomes inexcitable.

4. Refractory period Pharmacologically, the effective refractory period (ERP) which is the minimum interval between two propagating APs, is the most important. It is closely related to the AP duration (APD). An AP can be evoked in fast channel fibres even before complete repolarization, because Na^+ channels recover in a voltage-dependent manner above the threshold potential. As such $ERP/APD < 1$. By contrast, the Ca^{2+} channels recover in a time-dependent manner progressively after the fibre has fully repolarized. Thus, in slow channel fibres $ERP/APD > 1$. Most antiarrhythmic drugs increase ERP/APD ratio.

Autonomic influences on cardiac electrophysiology and contractility

It would be profitable to recapitulate the influence of sympathetic and parasympathetic stimulation on variables of cardiac function, because many cardiovascular drugs have indirect/secondary autonomic effects (Table VIII.2).

Table VIII.2: Autonomic influences on cardiac electrophysiology and contractility

Parameter	Effect of stimulation	
	Parasympathetic (ACh)	Sympathetic (Adr)
1. Automaticity		
SA node	Bradycardia	Tachycardia
Ectopic ventricular	—	Enhanced
2. Refractory period		
Atria	Shortened (inhomogeneous)	Shortened
Conducting tissue	Prolonged	Shortened
3. Conductivity	Decreased	Enhanced
4. Contractility	Decreased (little effect on ventricle)	Increased

CHAPTER 36

Drugs Affecting Renin-Angiotensin System and Plasma Kinins

ANGIOTENSIN

Angiotensin-II (A-II) is an octapeptide generated in the plasma from a precursor plasma α_2 globulin, and is involved in electrolyte, blood volume and pressure homeostasis. Pressor action of kidney extracts was known since the turn of the 19th century. The active material was termed 'Renin'. In the 1940s renin was shown to be an enzyme which acted indirectly by producing a pressor principle from plasma protein. Subsequently, it became clear that the product of renin action was an inactive decapeptide *angiotensin-I* (A-I) which was converted to the active octapeptide A-II by an angiotensin converting enzyme (ACE). The renin-angiotensin system (RAS) has attracted considerable attention in the recent years, particularly after the development of ACE inhibitor *captopril*.

Circulating renin-angiotensin system The generation and metabolism of A-II in circulation is depicted in Fig. 36.1. Normally, the amount of renin in plasma acts as the limiting factor for A-II generation. The plasma $t_{1/2}$ of renin is 15 min. The biological potency of A-I is only 1/100 that of A-II, but it is rapidly converted into the latter by ACE which is a *dipeptidyl carboxypeptidase* located primarily on the luminal surface of vascular endothelial cells (especially in lungs). Circulating

A-II also has a very short $t_{1/2}$ (1 min); the first degradation product termed *Angiotensin-III* (A-III) is 2–10 times less potent than A-II, except in stimulating aldosterone secretion, in which it is equipotent. A-III is further acted upon by a variety of peptidases, collectively termed *angiotensinases*, to inactive fragments.

Tissue (local) renin-angiotensin systems Apart from the A-II generated in circulation as described above, blood vessels capture circulating renin and angiotensinogen and produce A-II within or at the surface of their wall (*extrinsic local RAS*). Many tissues, especially heart, blood vessels, brain, kidneys, adrenals possess all components of the renin-angiotensin system and generate A-II inside their cells (*intrinsic local RAS*). Thus, local renin-angiotensin systems appear to operate in several organs in addition to the circulating one.

ACTIONS

1. CVS The most prominent action of A-II is vasoconstriction—produced directly as well as by enhancing Adr/NA release from adrenal medulla/adrenergic nerve endings and by increasing central sympathetic outflow. Vasoconstriction involves arterioles and venules and occurs in all vascular beds. However, it is less marked in cerebral, skeletal muscle, pulmonary and

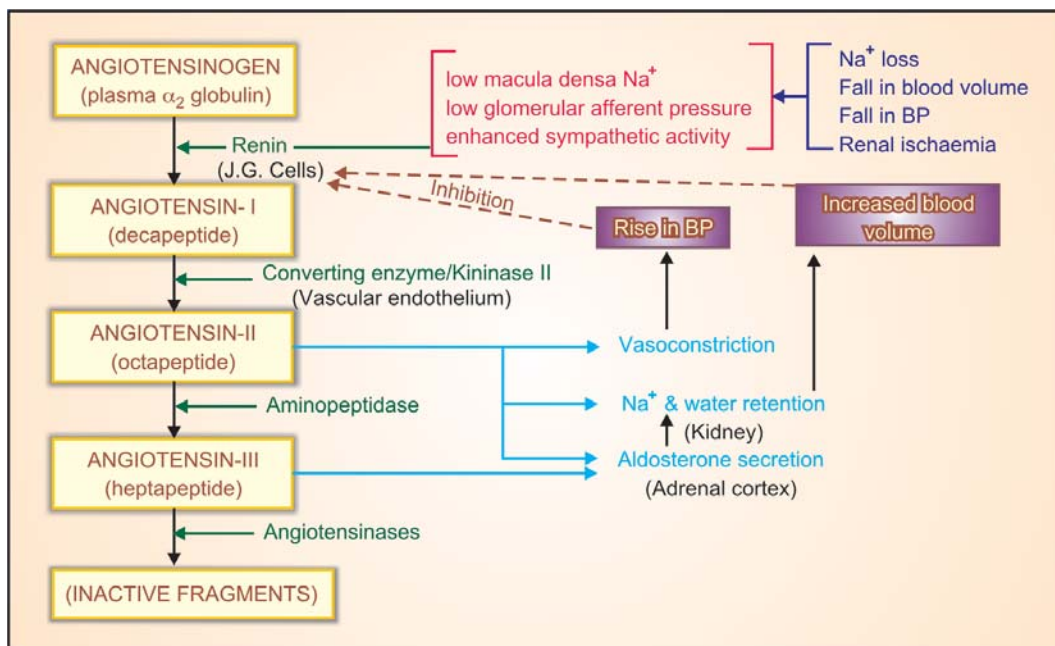

Fig. 36.1: Physiological regulation of electrolyte balance, plasma volume and blood pressure by the renin-angiotensin system

coronary vessels. A-II induced vasoconstriction promotes movement of fluid from vascular to extravascular compartment. BP rises acutely. As a pressor agent, A-II is much more potent than NA. No tachyphylaxis is seen in the pressor action of A-II; rather long-term infusion of low concentration of A-II produces sustained rise in BP by its renal effects promoting salt and water reabsorption, as well as by enhancing endothelin generation.

A-II increases force of myocardial contraction by promoting Ca^{2+} influx. Though, it can increase heart rate by enhancing sympathetic activity, reflex bradycardia predominates in the intact animal. Cardiac output is often reduced and cardiac work is increased (due to rise in peripheral resistance). In contrast to NA, A-II does not activate latent pacemakers—little arrhythmogenic propensity.

A-II acting on a chronic basis induces hypertrophy, hyperplasia and increased intercellular matrix production in the myocardium and

vascular smooth muscle by direct cellular effects involving expression of proto-oncogenes and transcription of several growth factors. Indirectly, volume overload and increased t.p.r. caused by A-II contributes to the hypertrophy and remodeling (abnormal redistribution of muscle mass) in heart and blood vessels. Long standing hypertension increases vessel wall + intimal thickness and causes ventricular hypertrophy. Fibrosis and dilatation of infarcted area with hypertrophy of the noninfarcted ventricular wall is seen after myocardial infarction. Progressive cardiac myocyte death and fibrotic transformation occurs in CHF. These changes are important risk factors for cardiovascular morbidity and mortality. ACE inhibitor therapy retards/reverses many of these changes imparting a pivotal role to A-II in vascular and ventricular hypertrophy, apoptosis and remodeling.

2. Smooth muscles A-II contracts many visceral smooth muscles *in vitro*, but *in vivo* effects are insignificant.

3. Adrenal cortex A-II and A-III are trophic to the zona glomerulosa of the adrenal cortex—enhance synthesis and release of aldosterone which acts on distal tubule to promote Na^+ reabsorption and K^+/H^+ excretion. These effects are exerted at concentrations lower than those required to cause vasoconstriction.

4. Kidney In addition to exerting indirect effect on kidney through aldosterone, A-II promotes Na^+/H^+ exchange in proximal tubule \rightarrow increased Na^+ , Cl^- and HCO_3^- reabsorption. Further, it reduces renal blood flow and produces intrarenal haemodynamic effects which normally result in Na^+ and water retention. However, an opposite effect has been observed in cirrhotics and renovascular disease patients.

5. CNS It has been noted that systemically administered A-II can gain access to certain periventricular areas of the brain to induce drinking behaviour and ADH release—both of which would be conducive to plasma volume expansion. It also increases central sympathetic outflow—contributes to the pressor response.

6. Peripheral sympathetic structures A-II enhances sympathetic activity by peripheral action as well. It releases Adr from adrenal medulla, stimulates autonomic ganglia and increases the output of NA from adrenergic nerve endings.

Angiotensin receptors and transducer mechanisms Specific angiotensin receptors are present on the surface of target cells. Two subtypes (AT_1 and AT_2) have been differentiated pharmacologically: *Losartan* is a selective AT_1 antagonist, while PD 123177 is a selective AT_2 antagonist. Both subtypes are G-protein coupled receptors. However, all known effects of A-II appear to be mediated by AT_1 receptor.

The AT_2 receptor is abundantly expressed in foetal tissues. In adults, it has been demonstrated in vascular endothelium, adrenal medulla, kidney and some brain areas. The functional role of AT_2 receptor is not clearly defined, but is generally opposite to that of AT_1 receptor. Activation of AT_2 receptor causes NO-dependent vasodilatation, promotes apoptosis, myocardial fibrosis and inhibits cell proliferation.

The AT_1 receptor utilizes different transducer mechanisms in different tissues. The phospholipase C- IP_3 /DAG-intracellular Ca^{2+} release mechanism underlies vascular and visceral smooth muscle contraction by activating myosin light chain kinase (MLCK). In addition, membrane Ca^{2+} channels are activated. Enhanced Ca^{2+} movement also induces aldosterone synthesis/release, cardiac inotropy, depolarization of adrenal medullary/autonomic ganglionic cell resulting in CA release/sympathetic discharge. DAG activates protein kinase C (PKC) which phosphorylates several intracellular proteins and augments the above responses as well as participates in promotion of cell growth. In liver and kidney, A-II inhibits adenylyl cyclase. The intrarenal homeostatic action involves phospholipase A_2 activation and PG/LT production.

In many tissues, especially myocardium, vascular smooth muscle and fibroblasts, AT_1 receptor also mediates long-term effects of A-II on cell growth. A-II activates MAP kinase, TAK2 tyrosine protein kinase and PKC which together enhance expression of proto-oncogenes, transcription factors and growth factors. As a result, cell growth is promoted and more intercellular matrix is synthesized.

PATHOPHYSIOLOGICAL ROLES

1. Mineralocorticoid secretion There is no doubt that A-II (also A-III) is the physiological stimulus for aldosterone secretion from adrenal cortex. It also exerts trophic influence on the glomerulosa cells so that effects are augmented under conditions which persistently raise A-II levels.

2. Electrolyte, blood volume and pressure homeostasis The RAS plays an important role in maintaining electrolyte composition and volume of extracellular fluid (see Fig. 36.1). Changes that lower blood volume or pressure, or decrease Na^+ content induce renin release by—

- (i) Decreasing tension in the afferent glomerular arterioles: *the intrarenal baroreceptor pathway*: possibly operates through increasing local production of prostaglandins (PGs).

- (ii) Low Na^+ concentration in the tubular fluid sensed by macula densa cells: *the macula densa pathway*. It has been found that COX-2 and neuronal nitric oxide synthase (nNOS) are induced in macula densa cells by Na^+ depletion \rightarrow release of PGE_2 and PGI_2 is enhanced both due to increased amount of COX-2 as well as its activation by NO. The locally released PGs act on juxtaglomerular cells to promote renin secretion.
- (iii) Baroreceptor and other reflexes which increase sympathetic impulses to JG cells—activated through β_1 receptors: *the β adrenoceptor pathway*.

Increased renin is translated into increased plasma A-II which produces acute rise in BP by vasoconstriction, and more long-lasting effects by directly as well as indirectly increasing Na^+ and water reabsorption in the kidney. Rise in BP in turn inhibits renin release: *the long-loop negative feedback mechanism*. It has been recently shown that A-II can be formed within the kidney and exerts important local regulatory effects. A *short-loop negative feedback mechanism* operates within the kidney: activation of AT_1 receptors on JG cells inhibits renin release. Long-term stabilization of BP despite varying salt and water intake appears to be achieved through these mechanisms.

The mechanisms of regulation of renin release have important pharmacological implications:

- ACE inhibitors and AT_1 antagonists enhance renin release by interfering with both the short-loop and long-loop negative feedback mechanisms.
- Vasodilators and diuretics stimulate renin release by lowering BP.
- Loop diuretics increase renin production by reducing entry of Na^+ into macula densa cells.
- Central sympatholytics and β blockers decrease renin release by depressing the β adrenoceptor pathway.
- NSAIDs, including selective COX-2 inhibitors, and nNOS inhibitors decrease renin release

by inhibiting PG production \rightarrow cause Na^+ and water retention.

3. Development of hypertension The RAS is directly involved in renovascular hypertension: plasma renin activity (PRA) is raised in most patients. In essential hypertension also it appears to have a permissive role, though PRA may be raised or low. Since ACE inhibitors consistently lower BP in hypertensives, the involvement of this system appears to be more widespread. A positive correlation between circulating angiotensinogen levels and essential hypertension has also been found. Several genetic evidences point to causation of pregnancy-induced hypertension (preeclampsia) by production of AT_1 receptor agonistic autoantibodies. The role of A-II in hypertrophy/remodeling of heart and blood vessels is now well recognized (*see above*).

4. Secondary hyperaldosteronism The RAS is instrumental in the development of secondary hyperaldosteronism.

5. CNS A-II can be formed locally in the brain and may function as transmitter or modulator. Regulation of thirst, hormone release and sympathetic flow may be the responses mediated.

A-II is not available commercially, and not used clinically.

Inhibition of renin-angiotensin system It can be achieved by:

1. Sympathetic blockers (β blockers, adrenergic neurone blockers, central sympatholytics)—decrease renin release.
2. Renin inhibitory peptides and renin specific antibodies block renin action—interfere with generation of A-I from angiotensinogen (rate limiting step).
3. Angiotensin converting enzyme inhibitors—prevent generation of the active principle A-II.
4. Angiotensin receptor (AT_1) antagonists—block the action of A-II on target cells.
5. Aldosterone antagonists—block mineralocorticoid receptors.

ANGIOTENSIN CONVERTING ENZYME INHIBITORS

Teprotide was the first ACE inhibitor to be synthesized taking a lead from the bradykinin potentiating factor (BPF) found in pit viper venom and the finding that the kininase II was also ACE. Teprotide, a nonapeptide inhibited generation of A-II from A-I and lowered BP. However, it had limitations of parenteral administration and brief duration of action.

Captopril, an orally active dipeptide analogue was introduced in 1977 and quickly gained wide usage. A multitude of ACE inhibitors have since been added, of which—*captopril, enalapril, lisinopril, benazepril, ramipril, fosinopril, trandolapril, imidapril* and *perindopril* are available in India. Some others like quinapril, cilazapril zofenopril, etc. are marketed in other countries. The pharmacology of captopril is described as prototype, since most of its effects are class effects common to all ACE inhibitors.

Captopril

It is a sulfhydryl containing dipeptide surrogate of proline which abolishes the pressor action of A-I but not that of A-II: does not block A-II receptors.

Captopril can also increase plasma kinin levels and potentiate the hypotensive action of exogenously administered bradykinin. Pretreatment with B₂ kinin receptor antagonist has shown that kinins do contribute to the acute vasodepressor action of ACE inhibitors, but they appear to have little role in the long-term hypotensive effect, probably because kinins play only a minor role, if at all, in BP regulation, and another enzyme 'Kininase I' (which also degrades bradykinin) is not inhibited. Nevertheless, elevated kinins (and PGs whose synthesis is enhanced by kinins) may be responsible for cough and angioedema induced by ACE inhibitors in susceptible individuals. ACE inhibitors interfere with degradation of substance P also.

Captopril lowers BP, but in the short-term, magnitude of response is dependent on Na⁺ status and the level of renin-angiotensin activity. In normotensive Na⁺ replete individuals, the fall in

BP attending initial few doses of ACE inhibitors is modest. This is more marked when Na⁺ has been depleted by dietary restriction or diuretics. A greater fall in BP occurs in renovascular, accelerated and malignant hypertension. In essential hypertension it has been found that RAS is overactive in 20%, normal in 60% and hypoactive in the rest. Thus, it contributes to maintenance of vascular tone in over 80% cases and its inhibition results in lowering of BP. However, in the long-term no correlation has been observed between plasma renin activity (PRA) and magnitude of fall in BP due to captopril.

Captopril induced hypotension is a result of decrease in total peripheral resistance. The arterioles dilate and compliance of larger arteries is increased. Both systolic and diastolic BP fall. It has no effect on cardiac output. Cardiovascular reflexes are not interfered with and there is little dilatation of capacitance vessels. As such, postural hypotension is not a problem. Reflex sympathetic stimulation does not occur despite vasodilatation. They can be safely used in patients with ischaemic heart disease. The renal blood flow is not compromised even when BP falls substantially. This is due to greater dilatation of renal vessels (A-II markedly constricts them). Cerebral and coronary blood flow are also not compromised.

Reflex (postural) changes in plasma aldosterone are abolished and basal levels are decreased as a consequence of loss of its regulation by A-II. However, physiologically sufficient mineralocorticoid is still secreted under the influence of ACTH and plasma K⁺. Levels of plasma renin and A-I are increased as a compensatory measure, but the physiological significance of this appears to be minor (most actions are exerted through generation of A-II).

Pharmacokinetics About 70% of orally administered captopril is absorbed. Presence of food in stomach reduces its bioavailability. Penetration in brain is poor. It is partly metabolized and partly excreted unchanged in urine. The plasma t_{1/2} is ~2 hours, but actions last for 6–12 hours.

Adverse effects The adverse effect profile of all ACE inhibitors is similar. Captopril is well tolerated by most patients, especially if daily dose is kept below 150 mg.

- *Hypotension*: an initial sharp fall in BP occurs especially in diuretic treated and CHF patients; persistent hypotension may be troublesome in MI patients.
- *Hyperkalaemia*: more likely in patients with impaired renal function and in those taking K^+ sparing diuretics, NSAIDs or β blockers. In others significant rise in plasma K^+ is rare.
- *Cough*: a persistent brassy cough occurs in 4–16% patients within 1–8 weeks, often requires discontinuation of the drug—subsides 4–6 days thereafter. It is not dose related and appears to be caused by inhibition of bradykinin/substance P breakdown in the lungs of susceptible individuals.
- *Rashes, urticaria*: occur in 1–4% recipients; does not usually warrant drug discontinuation.
- *Angioedema*: resulting in swelling of lips, mouth, nose, larynx may develop within hours to few days in 0.06–0.5% patients; may cause airway obstruction; treat with Adr, antihistaminics, corticosteroids according to need.
- *Dysgeusia*: reversible loss or alteration of taste sensation due to captopril has an incidence of 0.5–3%; lower incidence with other ACE inhibitors has been noted.
- *Foetopathic*: foetal growth retardation, hypoplasia of organs and foetal death may occur if

ACE inhibitors are given during later half of pregnancy. A recent report indicates 2.7-fold higher malformation rate in foetuses exposed to ACE inhibitors in the first trimester. ACE inhibitors must be stopped when the woman conceives.

- *Headache, dizziness, nausea and bowel upset*: each reported in 1–4% patients.
- *Granulocytopenia and proteinuria*: are rare, but warrant withdrawal. Renal disease predisposes to these adverse effects. However, ACE inhibitors retard diabetic nephropathy, reduce attendant proteinuria, and are renoprotective.
- *Acute renal failure*: is precipitated by ACE inhibitors in patients with bilateral renal artery stenosis due to dilatation of efferent arterioles and fall in glomerular filtration pressure. ACE inhibitors are contraindicated in such patients.

Interactions Indomethacin (and other NSAIDs) attenuate the hypotensive action. Incidents of renal failure have been reported when a NSAID was given to patients (especially elderly) receiving ACE inhibitor + diuretic. Hyperkalaemia can occur if K^+ supplements/ K^+ sparing diuretics are given with captopril. Antacids reduce bioavailability of captopril, while ACE inhibitors reduce Li^+ clearance and predispose to its toxicity.

Dose 25 mg BD, increased gradually upto 50 mg TDS according to response. In patients on diuretics and in CHF patients it is wise to start with 6.25 mg BD to avoid marked fall in BP initially. Tablets should be taken 1 hr before or 2 hr after a meal. It has become less popular due

Table 36.1: Comparative features of some ACE inhibitors

	Captopril	Enalapril	Lisinopril	Fosinopril	Perindopril	Ramipril
1. Chemical nature	Sulphydryl	Carboxyl	Carboxyl	Phosphinate	Carboxyl	Carboxyl
2. Activity status	Active	Prodrug	Active	Prodrug	Prodrug	Prodrug
3. Bioavailability (as active form)	70%	50%	25%	30%	20%	60%
4. Time to peak action	1 hr	4–6 hr	6–8 hr	3–5 hr	6 hr	3–6 hr
5. Elimination $t_{1/2}$ *	2 hr	11 hr	12 hr	12 hr	25–30 hr	8–48 hr
6. Mode of excretion	Renal	Renal	Renal	Renal/hepatic	Renal	Renal
7. Duration of action	6–12 hr	24 hr	\geq 24 hr	24 hr	> 24 hr	>24 hr
8. Daily dose (mg)	25–150	2.5–40	5–40	10–40	2–8	1.25–10

* $t_{1/2}$ including that of active metabolite

to need for twice/thrice daily dosing and possibly higher incidence of side effects compared to other ACE inhibitors. **ANGIOPRIL 25 mg tab, ACETEN, CAPOTRIL 12.5, 25 mg tab.**

OTHER ACE INHIBITORS

Differences among ACE inhibitors are primarily pharmacokinetic reflected in time course of their action; no single drug is superior to others.

Enalapril This is the second ACE inhibitor to be introduced. It is a prodrug—converted in the body to *enalaprilat* (a tripeptide analogue), which is not used as such orally because of poor absorption, but is marketed as injectable preparation in some countries. Enalapril has the same pharmacological, therapeutic and adverse effect profile as captopril, but may offer certain advantages:

1. More potent, effective dose 5–20 mg OD or BD.
2. Its absorption is not affected by food.
3. Onset of action is slower (due to need for conversion to active metabolite), less liable to cause abrupt first dose hypotension.
4. Has a longer duration of action: most hypertensives can be treated with single daily dose.
5. Rashes and loss of taste are probably less frequent.

ENAPRIL, ENVAS, ENAM 2.5, 5, 10, 20 mg tab.

Lisinopril It is the lysine derivative of enalaprilat: does not require hydrolysis to become active ACE inhibitor. Its oral absorption is slow (making first dose hypotension less likely) and incomplete, but unaffected by food. The duration of action is considerably longer, permitting single daily dose and ensuring uniform hypotensive action round the clock. A reduction in venous return, cardiac contractility and cardiac output has been noted after few weeks of lisinopril use.

LINVAS, LISTRIL, LIPRIL 2.5, 5, 10 mg tab, LISORIL 2.5, 5, 10, 20 mg tab.

Perindopril Another long-acting ACE inhibitor with a slow onset of action: less chance of first dose hypotension. Though 66–95% of orally administered perindopril is absorbed, only about 20% is converted to the active metabolite *perindo-*

prilat. Extensive metabolism to other inactive products occurs. Efficacy and tolerance of perindopril are similar to other ACE inhibitors.

COVERSYL 2, 4 mg tab.

Fosinopril This ACE inhibitor is unique in being a phosphinate compound that is glucuronide conjugated and eliminated both by liver and kidney. The $t_{1/2}$ is not altered by renal impairment; dose remains the same. However, like most others, it is a prodrug suitable for once daily administration. First dose hypotension is more likely.

Dose: Initially 10 mg (elderly 5 mg) OD; maximum 40 mg/day.

FOSINACE, FOVAS 10, 20 mg tabs.

Trandolapril It is a carboxyl prodrug that is 40–60% bioavailable in the active form. Absorption is delayed but not decreased by food. The peak effect occurs at 4–6 hours. It is partly metabolized and eliminated both in urine and faeces. The plasma $t_{1/2}$ of active metabolite is 16–24 hours, suitable for once daily dosing.

Dose: 2–4 mg (max 8 mg) OD; **ZETPRIL 1, 2 mg tabs.**

Ramipril The distinctive feature of this long-acting ACE inhibitor is its extensive tissue distribution. It may thus inhibit local RAS to a greater extent. Whether this confers any therapeutic advantage is not known. The plasma $t_{1/2}$ of its active metabolite ramiprilat is 8–18 hours, but terminal $t_{1/2}$ is longer due to slow release of tissue bound drug.

CARDACE, RAMIRIL, CORPRIL, R.PRIL 1.25, 2.5, 5 mg caps.

Imidapril The oral bioavailability of this long-acting prodrug ACE inhibitor is 40%, that is reduced by taking with meals. The peak effect occurs at 6–8 hours and plasma $t_{1/2}$ is >24 hours.

Dose: Initially 5 mg OD taken 1 hour before food; usual maintenance dose 10 mg OD.

TANATRIL 5, 10 mg tabs.

Benazepril Another nonsulfhydryl prodrug ACE inhibitor; has a bioavailability of 37% and is excreted by kidney with a $t_{1/2}$ of 10–12 hr.

Dose: 10 mg initially, max 20–40 mg/day;

BENACE 5, 10, 20 mg tab.

USES

1. Hypertension The ACE inhibitors are now first line drugs in all grades of hypertension. About 50% patients of essential hypertension respond to monotherapy with ACE inhibitors and majority of the rest to their combination with diuretics or β blockers. The hypotensive effect of lower doses develops gradually over 2–3 weeks. They offer the following advantages:

- Lack of postural hypotension, electrolyte disturbances, feeling of weakness and CNS effects.
- Safety in asthmatics, diabetics and peripheral vascular disease patients.
- Recent evidence indicates that long-term ACE inhibitor therapy has the potential to reduce incidence of type 2 diabetes in high risk subjects.
- Prevention of secondary hyperaldosteronism and K^+ loss due to diuretics.
- Renal blood flow is well maintained.
- They reverse left ventricular hypertrophy and the increased wall-to-lumen ratio of blood vessels that occurs in hypertensive patients.
- No hyperuricaemia, no deleterious effect on plasma lipid profile.
- No rebound hypertension on withdrawal.
- Minimum worsening of quality of life parameters like general wellbeing, work performance, sleep, sexual performance, etc.

Large multicentric trials have confirmed that ACE inhibitors reduce cardiovascular morbidity and increase life expectancy of hypertensive patients. It appears that by their specific effect on myocardial and vascular cell growth/remodeling, they have greater protective potential than other classes of antihypertensive drugs.

ACE inhibitors are highly effective and first choice drugs in renovascular and resistant hypertension. They are particularly suitable for diabetic hypertensives in whom they reduce cardiovascular complications more than other antihypertensive drugs, probably by improving endothelial function.

2. CHF ACE inhibitors cause both arteriolar and venodilatation in CHF patients: reduce after-load as well as preload. Haemodynamic measurements in severe CHF patients have shown reduction in right atrial pressure, pulmonary arterial pressure, pulmonary capillary wedge pressure, systemic vascular resistance, systolic wall stress and systemic BP. Though they have no direct myocardial action, stroke volume and cardiac output are increased, while heart rate is reduced. Accumulated salt and water are lost due to improved renal perfusion and abolition of mineralocorticoid mediated Na^+ retention. Cardiac work as measured by heart rate \times pressure product is reduced; thereby, exercise capacity of CHF patients is enhanced. Beneficial effects are well sustained with chronic therapy and the NYHA functional class of most patients is improved.

Robust multicentric trials have shown that ACE inhibitors retard the progression of left ventricular systolic dysfunction and prolong survival of CHF patients of all grades (I to IV). Unless contraindicated, ACE inhibitors are now advocated by several professional bodies, including American Heart Association and American College of Cardiology, as first line drugs in all patients with symptomatic as well as asymptomatic left ventricular inadequacy. A diuretic, β blocker with or without digitalis may be added according to need. ACE inhibitors reduce episodes of decompensation, myocardial infarction and sudden death. In addition to improved haemodynamics, long-term benefits of ACE inhibitors accrue from withdrawal of A-II mediated ventricular hypertrophy, remodeling, accelerated myocyte apoptosis and fibrosis. Indirect benefits occur due to reduction in sympathetic activation and aldosterone levels.

The Assessment of Treatment with Lisinopril and Survival (ATLAS) trial on 3164 heart failure patients (NYHA class II to IV) has shown that high dose lisinopril (32.5–35 mg/day) given for 39–58 months was more effective in reducing all cause mortality, hospitalization for heart failure and risk of MI than lower dose (2.5–5 mg/day). To afford maximum protection against progression of heart failure, the dose of ACE inhibitors needs to be titrated to nearly

the upper limit of recommended dose range, as shown in other mega trials like GISSI-3, SOLVD, AIRE, etc. as well. ACE inhibitors are effective in reducing development of ventricular dysfunction, heart failure and related mortality in post-MI patients also (SAVE, TRACE, AIRE trials).

3. Myocardial infarction (MI) Several mega-trials have established that oral ACE inhibitors administered while MI is evolving (within 24 hr of an attack) and continued for 6 weeks reduce early as well as long-term mortality, irrespective of presence or absence of systolic dysfunction, provided hypotension is avoided. In high risk patients and those with latent or overt ventricular dysfunction (CHF) extension of therapy continues to afford survival benefit over years. In unstable angina/non-ST segment elevation MI, long-term ACE inhibitor therapy reduces recurrent MI and need for coronary angioplasty (SAVE and SOLVD trials), though no benefit was apparent in the short-term (ISIS-4 study). Current evidence shows that if there are no contraindications, all MI patients stand to gain from ACE inhibitor therapy, though magnitude of benefit is greatest in those having associated hypertension and/or diabetes.

4. Prophylaxis in high cardiovascular risk subjects The results of Heart Outcomes Prevention Evaluation (HOPE) study in 9297 post-MI and other high risk subjects, but having no left ventricular dysfunction or heart failure have shown that ramipril reduced cardiac death and MI or stroke by 22% over a period of 4.5 years. Risk of developing heart failure or diabetes was also reduced. These results have been confirmed by the EUROPA trial and appear to hold true even for patients who have undergone coronary revascularization (APRES trial). Thus, ACE inhibitors are protective in high cardiovascular risk subjects even when there is no associated hypertension or left ventricular dysfunction. Protective effect is exerted both on myocardium as well as vasculature, may involve improved endothelial function, and is independent of hypotensive action.

5. Diabetic nephropathy Prolonged ACE inhibitor therapy has been found to prevent or delay end-stage renal disease in type I as well as

type II diabetics. Albuminuria (an index of glomerulopathy) remains stable in those treated with ACE inhibitor, but aggravates in untreated diabetics. Treated patients have higher creatinine clearance, require less dialysis and have longer life expectancy. Benefits appear to be due to haemodynamic (systemic and intrarenal) as well as abnormal mesangial cell growth attenuating effects of ACE inhibitors. They reduce intraglomerular pressure and hyperfiltration. ACE inhibitors arrest/partly reverse any degree of albuminuria, but benefits are restricted after macroalbuminuria in type 2 diabetes has set in. The RAS seems to accentuate micro- and macrovascular complications in diabetics, and ACE inhibitors have specific organ protective effect by attenuating the same. Deterioration of retinopathy in diabetics also appears to be retarded by ACE inhibitors. All patients with diabetic nephropathy, whether hypertensive or normotensive, deserve ACE inhibitor therapy.

Nondiabetic nephropathy There is evidence now that chronic renal failure due to nondiabetic causes may also be improved by ACE inhibitors. They reduce proteinuria by decreasing pressure gradient across glomerular capillaries as well as by altering membrane permeability. This retards disease progression. Among hypertensive nephropathy patients the incidence of doubling of serum creatinine or end stage renal failure is significantly lower in those treated with ACE inhibitors than those treated with other anti-hypertensives.

6. Scleroderma crisis The marked rise in BP and deterioration of renal function in scleroderma crisis is mediated by A-II. ACE inhibitors produce dramatic improvement and are life saving in this condition.

Captopril test This test has been devised to obviate the need for renal angiography for diagnosis of renovascular hypertension. The basis of the test is—acute blockade of A-II formation by captopril results in a reactive increase in PRA which is much higher in renovascular compared to essential hypertension. However, this test is only of adjunctive value.

ANGIOTENSIN ANTAGONISTS (Angiotensin receptor blockers or ARBs)

Over the past 2 decades, several nonpeptide orally active AT₁ receptor antagonists have been developed as alternatives to ACE inhibitors. These include *losartan*, *candesartan*, *valsartan*, *telmisartan* and *irbesartan*. Selective antagonists of AT₂ receptors as well as combined AT₁ + AT₂ antagonists have also been produced.

Losartan It is a competitive antagonist and inverse agonist of A-II, 10,000 times more selective for AT₁ than AT₂ receptor; does not block any other receptor or ion channel, except thromboxane A₂ receptor (has some platelet antiaggregatory property). It blocks all overt actions of A-II, *viz.* vasoconstriction, central and peripheral sympathetic stimulation, release of aldosterone and Adr from adrenals, renal actions promoting salt and water reabsorption, central actions like thirst, vasopressin release and growth-promoting actions on heart and blood vessels. No inhibition of ACE has been noted.

Pharmacologically, AT₁ receptor antagonists differ from ACE inhibitors in the following ways:

- They do not interfere with degradation of bradykinin and other ACE substrates: no rise in level or potentiation of bradykinin occurs. Consequently, ACE inhibitor related cough is rare.
- They result in more complete inhibition of AT₁ receptor activation, because alternative pathway of A-II generation and consequent AT₁ receptor activation remain intact with ACE inhibitors.
- They result in indirect AT₂ receptor activation. Due to blockade of AT₁ receptor mediated feedback inhibition—more A-II is produced which acts on AT₂ receptors that remain unblocked. ACE inhibitors result in depression of both AT₁ and AT₂ activation.

The impact of these differences on clinical efficacy and therapeutic value of the two classes of RAS inhibitors is not known.

Losartan causes fall in BP in hypertensive patients which lasts for 24 hours, while HR remains unchanged and cardiovascular reflexes are not interfered. No significant effect on plasma lipid profile, carbohydrate tolerance, insulin sensitivity has been noted. It is also a mild uricosuric.

Pharmacokinetics Oral absorption of losartan is not affected by food, but bioavailability is only 33% due to first pass metabolism. It is partially carboxylated in liver to an active metabolite (E3174) which is a 10–30 times more potent noncompetitive AT₁ receptor antagonist. After oral ingestion peak plasma levels are attained at 1 hr for losartan and at 3–4 hours for E3174. Both compounds are 98% plasma protein bound, do not enter brain and are excreted by the kidney. The plasma *t*_{1/2} of losartan is 2 hr, but that of E3174 is 6–9 hr. No dose adjustment is required in renal insufficiency, but dose should be reduced in presence of hepatic dysfunction.

Adverse effects Losartan is well tolerated; has side effect profile similar to placebo. Like ACE inhibitors it can cause hypotension and hyperkalemia, but first dose hypotension is uncommon. Though, a few reports of dry cough have appeared, losartan is considered to be free of cough and dysgeusia inducing potential. Patients with a history of ACE inhibitor related cough have taken losartan without recurrence. Angioedema is reported in fewer cases. Headache, dizziness, weakness and upper g.i. side effects are mild and occasional. However, losartan has fetopathic potential like ACE inhibitors—not to be administered during pregnancy.

Dose: 50 mg OD, rarely BD; in liver disease or volume depletion 25 mg OD; addition of hydrochlorothiazide 12.5–25 mg enhances its effectiveness.

LOSACAR, TOZAAR, ALSARTAN 25, 50 mg tabs.

Candesartan It has the highest affinity for the AT₁ receptor and produces largely unsurmountable antagonism, probably due to slow dissociation from the receptors or receptor desensitization. Elimination occurs by both

hepatic metabolism and renal excretion with a $t_{1/2}$ of 8–12 hours: action lasts 24 hours.

Dose: 8 mg OD (max 8 mg BD), liver/kidney impairment 4 mg OD.

CANDESAR 4, 8, 10 mg tab., CANDILONG, CANDESTAN 4, 8 mg tabs.

Irbesartan The oral bioavailability of this AT₁ antagonist is relatively high. It is partly metabolized and excreted mainly in bile. The $t_{1/2}$ is ~12 hours.

Dose: 150–300 mg OD.

IROVEL, IRBEST 150, 300 mg tabs.

Valsartan The AT₁ receptor affinity of valsartan is similar to that of losartan. Its oral bioavailability averages 23% and food interferes with its absorption. Elimination occurs mainly by the liver in unchanged form with a $t_{1/2}$ of 6–9 hours; action lasts 24 hours.

Dose: 80–160 mg OD 1 hour before meal (initial dose in liver disease 40 mg).

DIOVAN, STARVAL, VALZAAR 40, 80, 160 mg tabs.

Telmisartan The AT₁ receptor blocking action of telmisartan is similar to losartan, but it does not produce any active metabolite. After an oral dose, peak action occurs in 3 hours and action lasts > 24 hours. It is largely excreted unchanged in bile; dose reduction is needed in liver disease.

Dose: 20–80 mg OD.

TELMA, TELSAR, TELVAS 20, 40, 80 mg tabs.

Uses of AT₁ receptor antagonists (ARBs)

The ARBs have the same overall range of clinical utility as ACE inhibitors, but the suitability/efficacy of one over the other is not clearly defined; may depend on the condition being treated and/or specific features of the patient. The value of their combination *versus* monotherapy is also still unsettled.

Hypertension Losartan and other ARBs are now first line drugs, comparable in efficacy and desirable features to ACE inhibitors, with the advantage of not inducing cough and a lower incidence of angioedema, rashes and dysgeusia. As such, their popularity has increased. Like ACE inhibitors, the maximum antihypertensive effect

is reached in 2–4 weeks and ventricular/vascular hypertrophy/remodeling is arrested/reversed.

The Losartan intervention for endpoint reduction in hypertension (LIFE, 2002) study has found losartan to be more effective than β -blockers in reducing stroke among > 9000 hypertensive patients with left ventricular hypertrophy.

CHF The ARBs afford clear-cut symptomatic relief as well as survival benefit in CHF. However, their relative value compared to ACE inhibitors, especially in long-term morbidity and mortality reduction, is still uncertain.

A number of large randomized endpoint trials like Evaluation of losartan in the elderly (ELITE, 1997), ELITE-II (2000), OPTIMAAL (2002), Valsartan in acute MI (VALIANT, 2003) have produced contradictory results. Some find ACE inhibitors more effective, others find ARBs more effective, while still others find them equieffective. For CHF, the current consensus is to use ACE inhibitors as the first choice drugs and to reserve ARBs for those who fail to respond well or who develop cough/angioedema/other intolerance to ACE inhibitors.

Myocardial infarction The evidence so far indicates that utility of ARBs in MI, including long-term survival, is comparable to ACE inhibitors. However, the latter are generally used first, since there is greater experience with them.

Diabetic nephropathy Several studies have confirmed that ARBs are renoprotective in type 2 diabetes mellitus, independent of BP lowering. The magnitude of benefit is comparable to ACE inhibitors, but because of better tolerability profile, many consider ARBs to be the first choice now.

Combination of ACE inhibitors with ARBs There are theoretical reasons to combine an ACE inhibitor with an ARB to obtain more complete suppression of RAS and achieve added cardioprotection in CHF or renoprotection in diabetic nephropathy. These are:

- A-II is generated in several tissues (especially heart and kidney) by non-ACE mechanisms, whose effect can be blocked by ARBs.
- ACE inhibitors produce bradykinin related vasodilatation and other effects that are not produced by ARBs.
- ARBs cause compensatory increase in A-II production that is checked by ACE inhibitors.

- ARBs enhance unblocked AT₂ receptor mediated effects that can be prevented by concurrent ACE inhibition.

Additional haemodynamic and symptomatic improvement over short-term has been obtained in CHF with addition of an ARB to existing ACE inhibitor therapy. However, several large randomized trials including Randomized evaluation of strategies for left ventricular dysfunction (RESOLVD, 1999), Valsartan heart failure trial (VAL-He FT, 2001), CHARM-added trial (2003) of combinations of ARBs and ACE inhibitors Vs their monotherapy in affording mortality and other end point benefits in CHF have yielded controversial results. The Ongoing Telmisartan alone and in combination with ramipril global endpoint trial (ON TARGET) may clarify whether long-term use of ARB + ACE inhibitor combination is advisable or not.

In non-diabetic renal disease, the Combination treatment of ARB and ACE inhibitor randomized trial (COOPERATE, 2003) has concluded that ARB + ACE inhibitor combination therapy retards progression of non-diabetic renal disease to a greater extent compared with their monotherapy.

PLASMA KININS (Bradykinin and Kallidin)

Plasma kinins are polypeptides split off from a plasma globulin *Kininogen* by the action of specific enzymes *Kallikreins*. The two important plasma kinins, *Kallidin* (decapeptide) and *Bradykinin* (nonapeptide) were discovered around 1950 by two independent lines of investigation into the hypotensive activity of urine and certain snake venoms. These and other biological fluids were found to act indirectly: they contained enzymes which generated active substances in the plasma.

Generation and metabolism Kininogens are α_2 globulins present in plasma which also contains inactive kininogenase *prekallikrein*.

Prekallikrein is activated by Hageman factor (factor XII) which itself is activated by tissue injury and contact with surfaces having negative charge, e.g. collagen, basement membrane, bacterial liposaccharides, urate crystals, etc. *Plasmin* facilitates contact activation of Hageman

factor. Kinins are also generated by trypsin, proteolytic enzymes in snake and wasp venoms and by kallikrein present in kidney, pancreas and other tissues. Bradykinin is generated from high molecular weight (HMW) kininogen by the action of plasma kallikrein, because HMW-kininogen does not cross the capillaries. On the other hand, kallidin can be produced from both low molecular weight (LMW) kininogen as well as HMW-kininogen by the action of tissue kallikreins. Bradykinin can also be generated from kallidin on the removal of lysine residue by an aminopeptidase.

Plasma and tissues also contain kininogenase inhibitory factors of which *complement (C1) esterase inhibitor* is the most important. Moreover, kallikreins are normally present in their inactive forms. Thus, physiologically only small amounts of kinins are generated in plasma and tissues.

Kinins are very rapidly degraded, primarily in lungs, but also in other tissues and have a $t_{1/2}$ of < 1 min. The principal degrading enzyme is *Kininase II*, also known as 'angiotensin-II converting enzyme' (ACE) which splits off 2 amino acids from the carboxyterminal of the peptide chain. Another carboxypeptidase *Kininase I* removes only one amino acid (arginine) producing selective B1 receptor agonistic metabolites (desArg bradykinin and desArg kallidin) which are further degraded by other peptidases.

ACTIONS

Bradykinin and kallidin have similar actions.

1. CVS Kinins are more potent vasodilators than ACh and histamine. The dilatation is mediated through endothelial NO and PGI₂ generation, and involves mainly the arterioles. Larger arteries, most veins and vessels with damaged endothelium are constricted through direct action on the smooth muscle. In addition, they can release histamine and other mediators from mast cells. Injected i.v. kinins cause flushing, throbbing headache and fall in BP. They markedly increase capillary permeability due to separation of endothelial cells → exudation and inflammation occurs if they are injected in a tissue. Intradermal injection produces wheal and flare (similar to histamine).

Kinins have no direct action on heart; reflex stimulation occurs due to fall in BP.

2. Smooth muscle Kinin induced contraction of intestine is slow (*bradys*—slow, *kinein*—to move). They cause marked bronchoconstriction in guineapigs and in asthmatic patients. Action

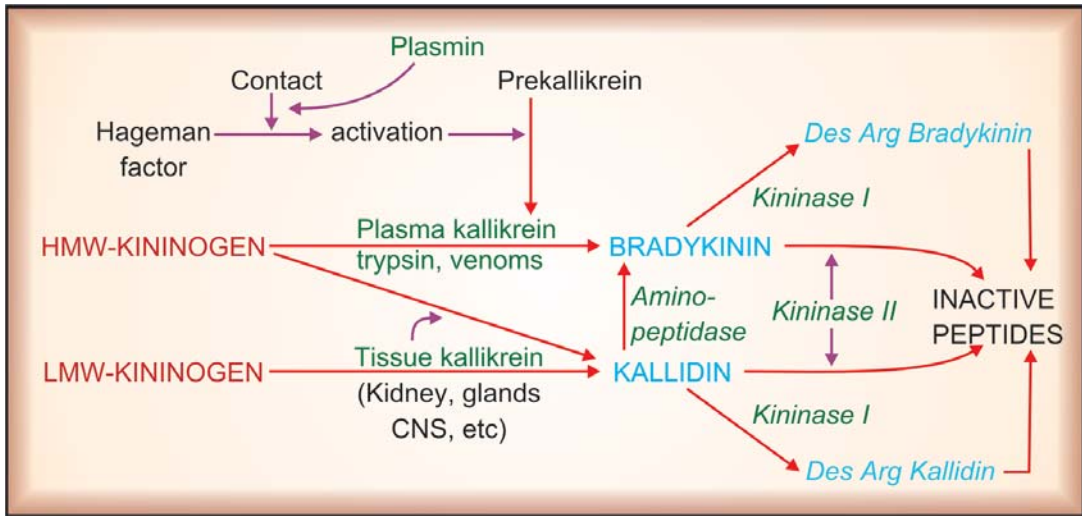

Fig. 36.2: Generation and degradation of plasma kinins
 HMW—High molecular weight; LMW—Low molecular weight

on other smooth muscles is not prominent, some may be relaxed also.

3. Neurones Kinins strongly stimulate nerve endings that transmit pain and produce a burning sensation. Applied to blister base/injected intraperitoneally or in the brachial artery, bradykinin produces intense, transient pain and has been used in analgesic testing.

Kinins release CAs from adrenal medulla. Injected directly in brain they produce a variety of effects including enhanced sympathetic discharge. They increase permeability of the blood-brain barrier.

4. Kidney Kinins increase renal blood flow as well as facilitate salt and water excretion by action on tubules. The diuretic effect of furosemide is reduced by kinin B₂ receptor antagonists, indicating participation of locally generated kinins in this response.

Kinin receptors Existence of two types of kinin receptors (B₁, B₂) has been established. Most kinin actions in noninflamed tissues are mediated by B₂ receptors which are constitutively present on:

- (i) Visceral smooth muscle—contraction of intestine, uterus, airway.

- (ii) Vascular endothelium—NO release, vasodilatation, increased permeability.
- (iii) Sensory nerves—acute pain.

The B₂ receptor is a G-protein coupled receptor which utilizes the phospholipaseC—IP₃/DAG—intracellular Ca²⁺ mobilization transducer mechanism. Certain responses to kinins, e.g. bronchoconstriction and renal vasodilatation are attenuated by pretreatment with PG synthesis inhibitors (aspirin). Aspirin injected i.p. before bradykinin through the same cannula blocks its algescic action. These responses are mediated by phospholipase A activation—release of arachidonic acid and generation of PGs.

The B₁ receptor is located on the smooth muscle of large arteries and veins—mediates contraction of these vessels, but is expressed minimally in normal tissues. Inflammation induces synthesis of B₁ receptors, so that they might play a major role at inflamed sites.

Bradykinin has higher affinity for B₂ than for B₁ receptors, while Kallidin is equipotent on both. The des-Arg metabolites of bradykinin and kallidin are the natural selective agonists of B₁ receptor.

PATHOPHYSIOLOGICAL ROLES

1. *Mediation of inflammation* Kinins produce all the signs of inflammation—redness, exudation, pain and leukocyte mobilization. Tissue injury can cause local kinin production which then sets in motion the above defensive and reparative processes. Activation of B₁ receptors on macrophages induces production of IL-1, TNF- α and other inflammatory mediators.

2. *Mediation of pain* By directly stimulating nerve endings and by increasing PG production kinins appear to serve as mediators of pain. The B₂ antagonists block acute pain produced by bradykinin, but induced B₁ receptors appear to mediate pain of chronic inflammation.

3. *Functional hyperemia* (in glands during secretion) and *regulation of microcirculation*—especially in kidney may be occurring through local kinin production.

4. Production of kinins is integrated with *clotting*, *fibrinolysin* and *complement* systems. Kallikreins may have roles in these systems which are independent of kinin production.

5. Kinins appear to play no significant role in regulation of normal BP. However, they may serve to oppose overactive RAS and exert antiproliferative influence on vascular smooth muscle in hypertensive states.

6. Kinins cause closure of ductus arteriosus, dilatation of foetal pulmonary artery and constriction of umbilical vessels—they may be involved in adjusting from foetal to neonatal circulation.

7. Kinins play a major role in the development of angioedema. They also appear to be involved in *shock*, *rhinitis*, *asthma*, *ACE inhibitor induced cough*, *carcinoid*, *postgastrectomy dumping syndrome*, fluid secretion in *diarrhoea*, *acute pancreatitis* and certain *immunological* reactions.

Because of evanescent and unpleasant actions, kinins have no clinical use.

Bradykinin antagonists

After characterization of B₁ and B₂ kinin receptors, several peptide and nonpeptide kinin antagonists have been produced. The synthetic peptide HOE 140 is a selective B₂ antagonist resistant to kinin degrading enzymes and having longer t_{1/2}, while *Icatibant*, *FR 173657* and some others are orally active nonpeptide B₂ antagonists that have helped in defining the pathophysiological roles of kinins and have undergone limited trials as analgesic, antiinflammatory drugs and in pancreatitis, head injury, etc.

CHAPTER 37

Cardiac Glycosides and Drugs for Heart Failure

CARDIAC GLYCOSIDES

These are glycosidic drugs having *cardiac inotropic* property. They increase myocardial contractility and output in a hypodynamic heart without a proportionate increase in O₂ consumption. Thus, efficiency of failing heart is increased. In contrast, 'cardiac stimulants' (Adr, theophylline) increase O₂ consumption rather disproportionately and tend to decrease myocardial efficiency, i.e. increase in O₂ consumption is more than increase in contractility. Further, cardiac stimulants also increase heart rate and have a shortlived action, while cardiac glycosides do not increase heart rate and have a prolonged action.

William Withering, a Birmingham physician, learnt that a decoction containing 'foxglove' (*Digitalis*) with other herbals, prepared by an old lady, relieved dropsy. He tried extract of foxglove alone and found it to be remarkably effective in some cases. He published his classic monograph 'An account of the Foxglove and some of its medicinal uses: with practical remarks on dropsy and other diseases' in 1785 and ascribed the beneficial effect to an action on the kidney. Later *Digitalis* was used indiscriminately, disregarding the precautions mentioned by Withering; was found to be toxic and fell into disrepute. Cushney and Mackenzie, in the beginning of 20th century, established its action on the heart and its use in congestive heart failure (CHF). *Strophanthus* was used as an arrow poison in Africa. Fraser discovered its digitalis like action in 1890. The use of *Squill* has come from Egyptian medicine, *Toad skin* from Chinese medicine and *Thevetin* from Unani medicine. Cases

of poisoning with *Thevetia* and *Convallaria* are occasionally seen.

Sources of cardiac glycosides

Source	Glycosides
1. <i>Digitalis purpurea</i> (leaf)	- Digitoxin*, Gitoxin, Gitalin
2. <i>Digitalis lanata</i> (leaf)	- Digitoxin, Gitoxin, Digoxin*
3. <i>Strophanthus gratus</i> (seed)	- Strophanthin-G (Ouabain)
4. <i>Urginea (Scilla) maritima</i> (bulb)	- Proscillaridin-A
5. <i>Thevetia neriifolia</i> (nut)	- Thevetin
6. <i>Convallaria majalis</i>	- Convallotoxin
7. <i>Bufo vulgaris</i> (Toad-skin)	- Bufotoxin

*used clinically

By convention, 'Digitalis' is applied as a collective term for the whole group and has come to mean 'a cardiac glycoside'.

CHEMISTRY

All are glycosides; consist of an *aglycone* (*genin*) to which are attached one or more *sugar* (glucose or digitoxose) moieties. The pharmacological activity resides in the aglycone, but attached sugars modify solubility and cell permeability. In general, aglycones have shortlived and less potent action.

The aglycone consists of a cyclopentanoperhydrophenanthrene (steroid) ring to which is attached a 5 or 6 membered unsaturated lactone ring. One or more hydroxyl and other substitutions are present on the aglycone and determine its polarity, e.g. *digoxigenin* has an additional OH group than *digitoxigenin* and is more polar.

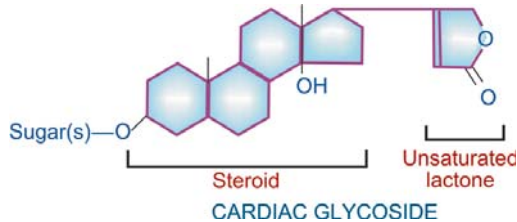

Generic structure of a cardiac glycoside depicting its important features

PHARMACOLOGICAL ACTIONS

All digitalis glycosides have qualitatively similar action; there are only quantitative and pharmacokinetic differences. Digoxin is described as prototype.

1. Heart Digitalis has direct effects on myocardial contractility and electrophysiological properties. In addition, it has vagomimetic action, reflex effects due to alteration in haemodynamics and direct CNS effects altering sympathetic activity.

Force of contraction Digitalis causes a dose dependent increase in force of contraction of heart—a positive inotropic action. This is especially seen in the failing heart which is exquisitely sensitive. There is increased velocity of tension development and higher peak tension can be generated. Systole is shortened, diastole is prolonged. When a normal heart is subjected to increased impedance to outflow, it generates increased tension so that stroke volume is maintained upto considerably higher values of impedance (Fig. 37.1), while the failing heart is not able to do so and the stroke volume progressively decreases. The digitalized failing heart regains some of its capacity to contract more

forcefully when subjected to increased resistance to ejection. There is more complete emptying of failing and dilated ventricles—cardiac output is increased.

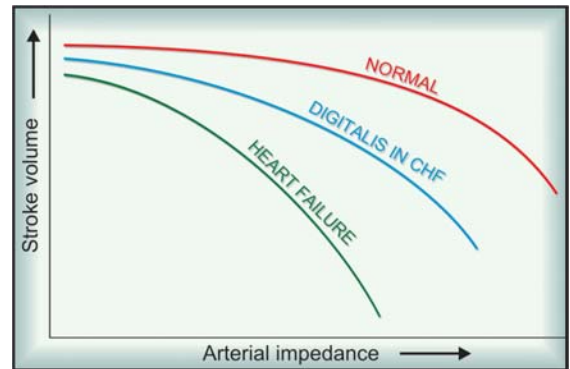

Fig. 37.1: Relationship between peripheral resistance and stroke output in normal and failing heart, and the action of digitalis on failing heart

Digitalis increases force of contraction in normal heart as well, but this is not translated into increased output, because the normal heart empties nearly completely even otherwise and reduction of end diastolic volume is counterproductive.

Tone It is defined by the maximum length of the fibre at a given filling pressure, or the resting tension in the muscle fibre. This is not affected by therapeutic doses of digitalis. However, digitalis does decrease end diastolic size of a failing ventricle, but this is a consequence of better ventricular emptying and a reduction in filling pressure.

Rate Heart rate is decreased by digitalis. Bradycardia is more marked in CHF patients: improved circulation (due to positive inotropic action) restores the diminished vagal tone and abolishes sympathetic overactivity. In addition, digitalis slows the heart by vagal and extravagal actions.

Vagal tone is increased:

- Reflexly through nodose ganglion and sensitization of baroreceptors.
- Direct stimulation of vagal centre.
- Sensitization of SA node to ACh.

Extravagal: A direct depressant action on SA and A-V nodes.

The vagal action manifests early and can be blocked by atropine, whereas the extravagal action becomes prominent later and cannot be reversed by atropine.

Electrophysiological properties The electrophysiological effects of digitalis on different types of cardiac fibres differ quantitatively and qualitatively. The Purkinje fibres, automatic and conducting tissues are more sensitive. In addition to direct effects, the indirect autonomic influences are important in the *in situ* heart.

(a) **Action potential (AP)**: The effects are illustrated diagrammatically in Fig. 37.2. The resting membrane potential (RMP), is progressively decreased (shifted towards isoelectric level) with increasing doses—excitability is enhanced at low doses (due to reduction of gap between RMP and threshold potential) but depressed at toxic doses (depolarization to below the level of critical potential which inactivates the fast channels).

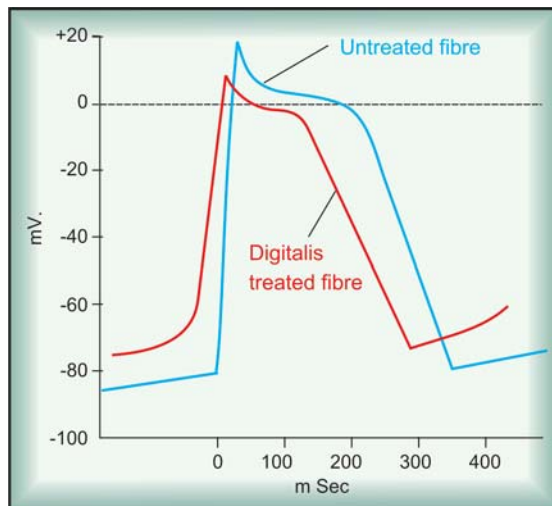

Fig. 37.2: Effect of digitalis on Purkinje fibre action potential

The rate of 0 phase depolarization is reduced. This action is most marked in A-V node and bundle of His.

The slope of phase-4 depolarization is increased in the PFs—ectopic automaticity is

enhanced—latent pacemakers become overt at high doses → extrasystoles. High doses of digitalis produce coupled beats by another mechanism: the RMP shows oscillations during phase-4; when their magnitude is sufficient enough, delayed after-depolarizations result (see Fig. 38.1). The SA and A-V node automaticity is reduced at therapeutic concentrations by vagal action which hyperpolarizes these cells and reduces their phase-4 slope. Toxic doses markedly reduce RMP of SA nodal cells by direct action and stop impulse generation.

The action potential duration (APD) is reduced (primarily at phase-2) and amplitude of AP is diminished.

(b) **Effective refractory period (ERP)**:

Atrium	}	decreased by vagal action	Vagal action normally predominates, causes inhomogeneity; allows the atria to respond at a higher rate and in an asynchronous manner.
		increased by direct action	

A-V node and bundle of His	}	Increased by direct, vagomimetic and antiadrenergic actions; the maximum rate at which impulses can be transmitted is reduced.
----------------------------	---	--

Ventricle—ERP is abbreviated by direct action.

(c) **Excitability**: Enhanced at low doses but depressed at high doses as explained above.

(d) **Conduction**: A-V conduction is demonstrably slowed by therapeutic doses due to a reduction in the rate of 0 phase depolarization. At high doses, intraventricular conduction in PFs is also depressed by uncoupling of gap junctions.

(e) **ECG**: Therapeutic doses of digitalis produce changes in the ECG. These are accentuated at high doses—may also produce arrhythmias. The changes are:

- Decreased amplitude or inversion of T wave.
- Increased P-R interval (slowing of A-V conduction), A-V block at toxic doses.
- Shortening of Q-T interval (reflecting shortening of systole).

- Depression of ST segment (at high doses—due to interference with repolarization). The abnormal QRS of Wolff-Parkinson-White (WPW) syndrome is widened because conduction through the normal A-V bundle is slowed but not that through the aberrant pathway.

Mechanism of action Digitalis increases force of cardiac contraction by a direct action independent of innervation. It selectively binds to extracellular face of the membrane associated Na^+K^+ ATPase of myocardial fibres and inhibits this enzyme (Fig. 37.3). Inhibition of this cation pump results in progressive accumulation of Na^+ intracellularly. This indirectly results in intracellular Ca^{2+} accumulation.

During depolarization Ca^{2+} ions enter the cell driven by the steep Ca^{2+} gradient (>1 mM extracellular to <100 nM cytosolic during diastole) through voltage sensitive Ca^{2+} channels. This triggers release of Ca^{2+} stored in sarcoplasmic

reticulum (SR) \rightarrow cytosolic Ca^{2+} increases transiently to about 500 nM (calcium transients) \rightarrow triggers contraction. Ca^{2+} is then actively taken up by SR and a fraction (equal to that which entered from outside during depolarization) is extruded mainly by $3\text{Na}^+ / 1\text{Ca}^{2+}$ exchange transporter (NCX-antiporter) as well as by sarcolemmal Ca^{2+} pump (Ca^{2+} ATPase). During phase 3 of AP membrane Na^+K^+ ATPase moves 3 intracellular Na^+ ions for 2 extracellular K^+ ions. The slight (1–1.5 mM) increase in cytosolic Na^+ over normal (8–10 mM) due to partial inhibition of Na^+K^+ ATPase by digitalis reduces transmembrane gradient of Na^+ which drives the extrusion of Ca^{2+} . The excess Ca^{2+} remaining in cytosol is taken up into SR which progressively get loaded with more Ca^{2+} \rightarrow subsequent calcium transients are augmented.

The relationship of cytosolic $[\text{Na}^+]$ and $[\text{Ca}^{2+}]$ is such that a small percentage increase in Na^+ concentration leads to a large percentage increase in Ca^{2+} concentration.

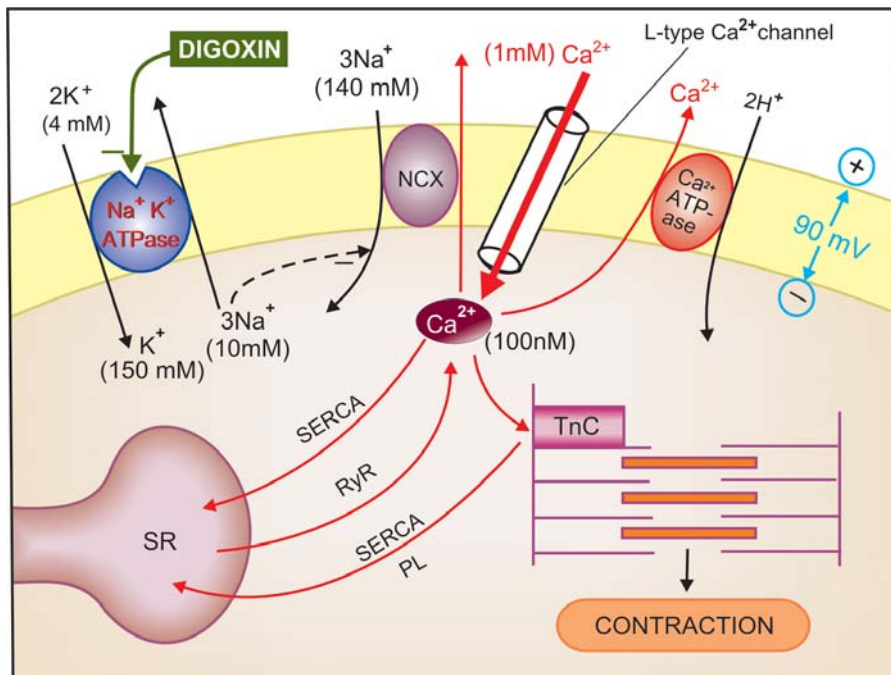

Fig. 37.3: Mechanism of positive inotropic action of cardiac glycosides. SR—Sarcoplasmic reticulum; TnC—Troponin C; NCX— $\text{Na}^+\text{-Ca}^{2+}$ exchanger; RyR—Ryanodine receptor calcium channel; PL—Phospholamban; SERCA—Sarcoplasmic-endoplasmic reticulum calcium ATPase

Moreover, raised cytosolic Ca^{2+} induces greater entry of Ca^{2+} through voltage sensitive Ca^{2+} channels during the plateau phase. It has been shown that 1 mM rise in cytosolic $[\text{Na}^+]$ results in 20–30% increase in the tension developed by ventricular fibres.

Binding of glycoside to $\text{Na}^+\text{K}^+\text{ATPase}$ is slow. Moreover, after $\text{Na}^+\text{K}^+\text{ATPase}$ inhibition, Ca^{2+} loading occurs gradually. As such, inotropic effect of digitalis takes hours to develop, even after i.v. administration.

Inhibition of $\text{Na}^+\text{K}^+\text{ATPase}$ is clearly involved in the toxic actions of digitalis. At high doses, there is depletion of intracellular K^+ ; toxicity is partially reversed by infusing K^+ . Excessive Ca^{2+} loading of SR results in spontaneous cycles of Ca^{2+} release and uptake producing oscillatory after-depolarizations and after-contractions. Since both therapeutic and toxic effects of digitalis are due to myocardial Ca^{2+} loading, these are inseparable and therapeutic index is low.

2. Blood vessels Digitalis has mild direct vasoconstrictor action—peripheral resistance is increased in normal individuals. However, in CHF patients this is more than compensated by the indirect effect of improvement in circulation, i.e. reflex sympathetic overactivity is withdrawn and a net decrease in peripheral resistance occurs. Venous tone is improved in normal individuals as well as in CHF patients.

Digitalis has no prominent effect on BP: systolic BP may increase and diastolic may fall in CHF patients—pulse pressure increases. Hypertension is no contraindication to the use of digitalis.

Despite a weak direct coronary constrictor action, therapeutic doses of digitalis have no significant effect on coronary circulation—coronary insufficiency is no contraindication to its use. Coronary debt may even decrease if ventricles were in a dilated state.

3. Kidney Diuresis is seen promptly in CHF patients, secondary to improvement in circulation and renal perfusion. The retained salt and water is gradually excreted. No diuresis occurs in normal individuals or in patients with edema due to other causes.

4. CNS Digitalis has little apparent CNS effect in therapeutic dose. Higher doses cause CTZ activation → nausea and vomiting. Still higher doses produce hyperapnoea, central sympathetic stimulation, mental confusion, disorientation and visual disturbances.

PHARMACOKINETICS

The pharmacokinetic properties of digoxin and digitoxin are presented in Table 37.1.

Digitoxin is the most lipid soluble, digoxin is relatively polar, while ouabain has the highest polar character. Bioavailability of digoxin tablets from different manufacturers may differ. Presence of food in stomach delays absorption of digoxin as well as digitoxin.

The volume of distribution of cardiac glycosides is large, e.g. 6–8 L/Kg in case of digoxin. All are concentrated in the heart (~20 times than plasma), skeletal muscle, liver and kidney.

Table 37.1: Pharmacokinetic properties of digoxin and digitoxin

	DIGITOXIN	DIGOXIN
1. Oral absorption	V. good (90–100%)	Good (60–80%)
2. Plasma protein binding	95%	25%
3. Time course of action*		
–Onset	½–2 hr	15–30 min
–Peak	6–12 hr	2–5 hr
–Duration	2–3 weeks	2–6 days
4. Plasma $t_{1/2}$	5–7 days	40 hr
5. Plasma concentration		
–Therapeutic	15–30 ng/ml	0.5–1.4 ng/ml
–Toxic	> 35 ng/ml	> 2 ng/ml
6. Daily maintenance dose	0.05–0.2 mg	0.125–0.5 mg
7. Daily elimination**	10–15%	35%
8. Route of elimination (predominant)	Hepatic metabolism	Renal excretion
9. Administration	Oral	Oral, i.v.
10. Generally used for	Maintenance	Routine treatment and emergency

* Of full digitalizing dose given i.v.; ** fraction of total amount present in the body.

Digitoxin is primarily metabolized in liver, partly to digoxin, and undergoes some enterohepatic circulation. Digoxin is primarily excreted unchanged by the kidney: mainly by glomerular filtration; rate of excretion is altered parallel to creatinine clearance. Its $t_{1/2}$ is prolonged in elderly patients and in those with renal insufficiency: dose has to be reduced. Dose of digitoxin is not greatly altered in renal failure.

Cardiac glycosides are cumulative drugs. When maintenance doses are given from the beginning, steady state levels and full therapeutic effect are attained after $4 \times t_{1/2}$, i.e. 6–7 days for digoxin and 4 weeks for digitoxin.

Preparations

1. Digoxin: DIGOXIN 0.25 mg tab., 0.05 mg/ml pediatric elixir, 0.5 mg/2 ml inj. LANOXIN 0.25 mg tab, CARDIOXIN, DIXIN 0.25 mg tab, 0.5 mg/2 ml inj.
2. Digitoxin: DIGITOXIN 0.1 mg tab.

All glycosides have the same safety margin; choice of preparation depends on kinetic properties. *Digoxin* is well absorbed orally, has reasonably quick action, intermediate $t_{1/2}$, dose adjustments are possible in 2–3 days, can be used for routine treatment as well as emergency; in case of toxicity—discontinuation of the drug produces reasonably rapid disappearance of manifestations. Thus, it is an all purpose and most commonly used glycoside.

Digitoxin may be used for maintenance; because of its long $t_{1/2}$, diurnal fluctuations in blood level are low. However, any dose adjustment takes weeks and toxic effects are more persistent. Therefore, most physicians prefer digoxin for maintenance therapy also.

ADVERSE EFFECTS

Toxicity of digitalis is high, margin of safety is low (therapeutic index 1.5–3). Higher cardiac mortality has been reported among patients with steady-state plasma digoxin levels > 1.1 ng/ml during maintenance therapy. About 25% patients develop one or other toxic symptom. The manifestations are:

Extracardiac Anorexia, nausea, vomiting and abdominal pain are usually reported first: are due to gastric irritation, mesenteric vasoconstriction and CTZ stimulation. Fatigue, no desire to walk or lift an arm, malaise, headache, mental confusion, restlessness, hyperapnoea, disorienta-

tion, psychosis and visual disturbances are the other complaints. Diarrhoea occurs occasionally. Skin rashes and gynaecomastia are rare.

Cardiac Almost every type of arrhythmia can be produced by digitalis: pulsus bigeminus, nodal and ventricular extrasystoles, ventricular tachycardia and terminally fibrillation. Partial to complete A-V block may be the sole cardiac toxicity or it may accompany other arrhythmias. Severe bradycardia, atrial extrasystoles, AF or AFL have also been noted. In about 2/3 patients showing toxicity, extracardiac symptoms precede cardiac; in the rest serious cardiac arrhythmias are the first manifestation. The central actions of digitalis appear to contribute to the development of arrhythmias by inducing fast and irregular activity in the cardiac sympathetic and vagus nerves.

Treatment Further doses of digitalis must be stopped at the earliest sign of toxicity; nothing more needs to be done in many patients, especially if the manifestations are only extracardiac.

(a) **For tachyarrhythmias** When they are caused by chronic use of digitalis and diuretics (both induce K^+ depletion)—infuse KCl 20 m.mol/hour (max. 100 m. mol) i.v. or give orally in milder cases. K^+ tends to antagonize digitalis induced enhanced automaticity and decreases binding of the glycosides to $Na^+K^+ATPase$ by favouring a conformation of the enzyme that has lower affinity for cardiac glycosides. When toxicity is due to acute ingestion of large doses of digitalis, plasma K^+ may be high; it should not be given from outside. In any case, it is desirable to measure serum K^+ to guide KCl therapy. K^+ is contra-indicated if higher degree of A-V block is present: complete A-V block and ventricular asystole can be precipitated.

(b) **For ventricular arrhythmias** Lidocaine i.v. repeated as required is the drug of choice. It suppresses the excessive automaticity, but does not accentuate A-V block. Phenytoin is also effective but seldom used now, because sudden

deaths have occurred when it was injected i.v. in digitalis intoxicated patients. Quinidine and procainamide are contraindicated.

(c) *For supraventricular arrhythmias* Propranolol may be given i.v. or orally depending on the urgency.

(d) *For A-V block and bradycardia* Atropine 0.6–1.2 mg i.m. may help; otherwise cardiac pacing is recommended.

Cardioversion by DC shock is contraindicated because severe conduction defects may be unmasked in the digitalis intoxicated heart. Attempts to enhance the elimination of digitalis by diuretics or haemodialysis are not very effective.

Digoxin antibody Developed for measuring plasma concentration of digoxin by radioimmunoassay, it has been found effective in treating toxicity as well. Digoxin specific antibody crossreacts with digitoxin also. The Fab fragment has been marketed in Europe as **DIGIBIND** (38 mg vial). It is nonimmunogenic because it lacks the Fc fragment. Given by i.v. infusion it has markedly improved the survival of seriously digitalis intoxicated patients. The digoxin-Fab complex is rapidly excreted by kidney.

PRECAUTIONS AND CONTRAINDICATIONS

(a) *Hypokalemia*: enhances digitalis toxicity by increasing its binding to Na^+K^+ ATPase.

(b) *Elderly, renal or severe hepatic disease*: patients are more sensitive.

(c) *Myocardial infarction*: severe arrhythmias are more likely. Digitalis should be used after MI only when heart failure is accompanied with AF and rapid ventricular rate.

(d) *Thyrotoxicosis*: reduces responsiveness to digitalis, but these patients are more prone to develop digitalis arrhythmias.

(e) *Myxoedema*: these patients eliminate digoxin more slowly; cumulative toxicity can occur.

(f) *Ventricular tachycardia*: digitalis is contraindicated—may precipitate ventricular fibrillation.

(g) *Partial A-V block*: may be converted to complete A-V block.

(h) *Acute myocarditis*: Diphtheria, acute rheumatic carditis, toxic carditis—inotropic response is poor, more prone to arrhythmias.

(i) *Wolff-Parkinson-White syndrome*: Digitalis is contraindicated—decreases the ERP of bypass tract in 1/3 patients. In them rapid atrial impulses may be transmitted to ventricles → VF may occur. Digitalis can increase the chances of reentry by slowing conduction in the normal A-V bundle and accelerating it in the aberrant pathway.

INTERACTIONS

1. *Diuretics*: cause hypokalemia which can precipitate digitalis arrhythmias; potassium supplements may be given prophylactically.

2. *Calcium*: synergises with digitalis → precipitates toxicity.

3. *Quinidine*: reduces binding of digoxin to tissue proteins as well as its renal and biliary clearance by inhibiting efflux transporter P-glycoprotein → plasma concentration is doubled → toxicity can occur. *Verapamil, diltiazem, captopril* and *amiodarone*: increase plasma concentration of digoxin to variable extents.

4. *Adrenergic drugs*: can induce arrhythmias in digitalized patients; both increase ectopic automaticity.

5. Digoxin absorption can be reduced by *metoclopramide* (gastrointestinal hurrying) and *sucralfate* which adsorbs digoxin. *Antacids, neomycin, sulfasalazine* also can reduce digoxin absorption; stagger their administration. Absorption is increased by atropinic drugs, including tricyclic antidepressants, by delaying gastric emptying. Erythromycin, omeprazole and tetracycline increase bioavailability of digoxin.

6. *Propranolol, verapamil, diltiazem and disopyramide*: may additively depress A-V conduction and oppose positive inotropic action.

7. *Phenobarbitone* and other enzyme inducers expedite digitoxin metabolism and decrease its $t_{1/2}$; no effect on digoxin $t_{1/2}$ as it is not metabolized significantly.

8. *Succinylcholine*: causes arrhythmias in digitalized patients.

USES

The two main indications of digitalis are CHF and control of ventricular rate in atrial fibrillation/flutter.

1. Congestive heart failure

CHF occurs when cardiac output is insufficient to meet the demands of tissue perfusion. Heart failure may primarily be due to systolic dysfunction or diastolic dysfunction.

Systolic dysfunction The ventricles are dilated and unable to develop sufficient wall tension to eject adequate quantity of blood. This occurs in ischaemic heart disease, valvular incompetence, dilated cardiomyopathy, myocarditis, tachyarrhythmias.

Diastolic dysfunction The ventricular wall is thickened and unable to relax properly during diastole; ventricular filling is impaired because of which output is low. It occurs in sustained hypertension, aortic stenosis, congenital heart disease, A-V shunts, hypertrophic cardiomyopathy.

However, most patients, especially long-standing CHF, have both systolic and diastolic dysfunction. Cardiac glycosides primarily mitigate systolic dysfunction. Best results are obtained when myocardium is not primarily deranged, e.g. in hypertension, valvular defects or that due to rapid heart rate in atrial fibrillation. Poor response and more toxicity is likely when the myocardium has been damaged by ischaemia, inflammation or degenerative changes and in thiamine deficiency, as well as in high output failure (in anaemia).

Cardiac glycosides are incapable of reversing the pathological changes of CHF or even arresting their progress. Associated with hypertrophy, cardiac muscle undergoes remodeling which may involve shift of isoforms of various functional proteins such as myosin, creatine kinase, $\text{Na}^+\text{K}^+\text{ATPase}$, etc. Cardiac glycosides do not affect remodeling.

Because of lower inotropic state, the failing heart is able to pump much less blood at the

normal filling pressure (Fig. 37.4), more blood remains in the ventricles at the end of systole. The normal venous return is added to it and Frank-Starling compensation is utilized to increase filling pressure: the heart may be able to achieve normal stroke volume, but at a filling pressure which produces congestive symptoms (venous engorgement, edema, enlargement of liver, pulmonary congestion → dyspnoea, renal congestion → oliguria).

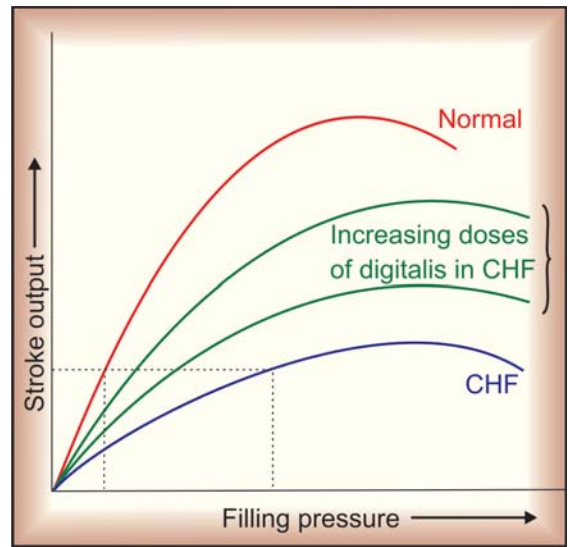

Fig. 37.4: Relationship between filling pressure and cardiac output in normal and failing heart. Digitalis tends to shift the curve towards normal

Digitalis induced enhancement of contractility increases ventricular ejection and shifts the curve relating stroke output to filling pressure towards normal, so that adequate output may be obtained at a filling pressure that does not produce congestive symptoms. Improved tissue perfusion results in withdrawal of sympathetic overactivity → heart rate and central venous pressure (CVP) are reduced. Compensatory mechanisms retaining Na^+ and water are inactivated → diuresis → edema is cleared. Liver regresses, pulmonary congestion is reduced → dyspnoea abates, cyanosis disappears. Low output symptoms like decreased capacity for muscular work are mitigated.

A dilated ventricle automatically becomes inefficient according to Laplace equation.

$$\text{Wall tension} = \frac{\text{Intraventricular pressure} \times \text{ventricular radius}}{\text{ventricular radius}}$$

i.e. to generate the same ejection pressure a dilated ventricle has to develop higher wall tension. By reducing end diastolic volume (due to better emptying), digitalis restores efficiency of translation of cardiac work into cardiac output. That is why O₂ consumption does not increase proportionately.

Dosage The dosing schedule and route depend on the desired speed of action and the factors which govern individual susceptibility. Generally, higher dose is needed for more severe CHF.

There is some recent evidence that maintenance therapy with sub-maximal inotropic doses (producing steady-stage digoxin levels < 1 ng/ml) may benefit by counteracting neurohumoral activation of CHF without risk of toxicity.

(a) *Slow digitalization* In most mild to moderate cases, maintenance dose of digoxin (0.125–0.25 mg/day) is given from the beginning. Full response takes 5–7 days to develop, but the procedure is much safer. In case adequate response is not seen after 1 week, increase the dose to 0.375 and then to 0.5 mg after another week. Evaluation of adequate response is primarily clinical. Relief of signs and symptoms of failure, reduction of heart rate and body weight to normal are the best guide. Bradycardia (HR < 60/min) is an indication for stopping further medication. ECG changes are not valuable in quantitation of doses unless arrhythmias occur.

(b) *Rapid oral digitalization* Digoxin 0.5–1.0 mg *stat* followed by 0.25 mg every 6 hours with careful monitoring and watch for toxicity till response occurs—generally takes 6–24 hours (total dose 0.75–1.5 mg). This is seldom practised now.

(c) *Emergent i.v. digitalization* It is practised rarely now, only as a desperate measure in CHF or in atrial fibrillation. Digoxin 0.25 mg followed by 0.1 mg hourly is given by slow i.v. injection with close ECG, BP and CVP monitoring till response occurs (2–6 hours, total dose 0.5–1.0 mg).

Current status of digitalis Before the introduction of high ceiling diuretics and ACE inhibitors, digitalis was considered an indispensable part of anti-CHF treatment. It is not so now. Many mild-to-moderate cases can be

managed without digitalis, i.e. with diuretics and vasodilators, especially an ACE inhibitor. Lately, β blockers have got added to the standard therapy. Emergency i.v. use of digoxin for CHF is practically extinct. However, digitalis is still the most effective drug capable of restoring cardiac compensation, especially in patients with dilated heart and low ejection fraction; all patients not controlled by ACE inhibitor/AT₁ receptor blocker, β blocker and diuretic should be treated with digitalis. Uncertainty exists in the area of maintenance therapy, i.e. after decompensation has been corrected in patients not having atrial fibrillation (AF). There has been a trend to discontinue digitalis once compensation has been restored, especially in mild-to-moderate cases.

Two large randomized trials—Randomized assessment of digoxin on inhibition of angiotensin converting enzyme (RADIANCE, 1993) and Prospective randomized study of ventricular failure and efficacy of digoxin (PROVED, 1993) on CHF patients in sinus rhythm showed that discontinuation of digitalis resulted in reduced exercise capacity and haemodynamic deterioration in a significant number of cases despite continued use of diuretic with or without ACE inhibitor. A trend has emerged in favour of maintenance ACE inhibitor and digitalis therapy with intermittent symptom based use of diuretics. However, the trials referred above also showed that digitalis can be withdrawn without haemodynamic deterioration in 60% (not receiving ACE inhibitor) and in 72% (receiving ACE inhibitor) patients.

If stable clinical state has been maintained for 2–3 months, withdrawal of digitalis may be attempted. Early reinstatement of digitalis is recommended if cardiac status declines. Continued digitalis therapy is the best course in CHF patients with atrial fibrillation.

Large studies including those by Digoxin Investigation Group (DIG) have found no evidence that digitalis decreases overall mortality in CHF patients, though episodes of decompensation and heart failure deaths are reduced. The two major limitations in the use of cardiac glycosides are low margin of safety and inability to reverse/retard the processes which cause the heart to fail.

2. Cardiac arrhythmias

Atrial fibrillation (AF) Digitalis is the drug of choice for controlling ventricular rate in AF, whether associated with CHF or not. However, it is incapable of curing AF, i.e. does not revert it to sinus rhythm, even perpetuates it.

Digitalis reduces ventricular rate in AF by decreasing the number of impulses that are able to pass down the A-V node and bundle of His.

(a) It increases ERP of A-V node by direct, vagomimetic and antiadrenergic actions: the minimum interval between consecutive impulses that can successfully traverse the conducting tissue is increased.

(b) A degree of A-V block is naturally established in AF. Because of the relatively long ERP of A-V node, many of the atrial impulses (~500/min) impinge on it while it is still refractory; others falling early in the relative refractory period get extinguished by decremental conduction. These concealed impulses, nevertheless, leave the upper margin of A-V node refractory for a further period. Thus, any influence which increases rate of AF, by itself reduces ventricular rate. Digitalis decreases average atrial ERP and temporally disperses it (vagal action), thereby increasing fibrillation frequency and indirectly prolonging the interval between any two impulses that are successfully conducted to the ventricle.

When digitalis is given in AF, average ventricular rate decreases in a dose-dependent manner and pulse deficit is abolished because ventricle does not receive an impulse very early in diastole before it has had time to fill up reasonably. The therapeutic endpoint can be clearly defined: the dose should be adjusted to a ventricular rate of 70–80/min at rest. If this is not possible with digitalis alone, a β blocker or verapamil may be added.

Atrial flutter (AFI) The atrial rate is 200–350/min (less than that in AF), but atrial contractions are regular and synchronous. A variable degree of A-V block, depending on the mean ERP of A-V node, is naturally established. Digitalis enhances

this A-V block, reduces ventricular rate and prevents sudden shift of A-V block to a lower degree (as may occur during exercise or sympathetic stimulation). Digitalis may convert AFI to AF by reducing atrial ERP and making it inhomogeneous. This is a welcome response because control of ventricular rate is easier in AF (graded response occurs) than in AFI (A-V block shifts in steps). In nearly $\frac{1}{2}$ of the patients when digitalis is stopped, this induced AF reverts to sinus rhythm since the cause of atrial inhomogeneity is gone. Alternatively, AFI may be terminated by cardioversion/radiofrequency ablation and its recurrence prevented by subsequent digitalis treatment.

Paroxysmal supraventricular tachycardia (PSVT)

It is a common arrhythmia with a rate 150–200/min and 1 : 1 A-V conduction. It is mostly due to reentry involving the SA or A-V node. Rigidly circumscribed magnitudes of ERP and conduction velocity are required for its persistence. A parenteral glycoside may be injected i.v.—increases vagal tone and depresses the path through the SA/A-V node, or the ectopic focus, and terminates the arrhythmia (success in 1/3 cases). Verapamil/adenosine are more effective, less toxic and act faster. Digitalis is now reserved for preventing recurrences in selected cases.

TREATMENT OF CHF

There are two distinct goals of drug therapy in CHF:

- (a) Relief of congestive/low output symptoms and restoration of cardiac performance:
 - Inotropic drugs*—digoxin, dobutamine/dopamine, amrinone/milrinone
 - Diuretics*—furosemide, thiazides
 - Vasodilators*—ACE inhibitors/AT₁ antagonists, hydralazine, nitrate, nitroprusside
 - β blocker*—Metoprolol, bisoprolol, carvedilol
- (b) Arrest/reversal of disease progression and prolongation of survival:
 - ACE inhibitors/AT₁ antagonists (ARBs)*
 - β blockers*
 - Aldosterone antagonist*—Spironolactone

Important nonpharmacological measures are rest and salt restriction.

Rest reduces peripheral needs, but should be advised only till compensation is restored, beyond that it may lower myocardial reserve and be counterproductive. Salt restriction limits edema formation and is advised in all grades of CHF. The underlying cause of CHF, if treatable like hypertension, myocardial ischaemia, valvular defects, A-V shunts, arrhythmias, thyrotoxicosis, anaemia, should be corrected.

The pathophysiological mechanisms that perpetuate heart failure and contribute to disease progression, along with site of drug action are depicted in Fig. 37.5. The current pattern of use of drugs in various stages of heart failure is summarized in Fig. 37.6.

Diuretics

Almost all cases of symptomatic CHF are treated with a diuretic. *High ceiling diuretics* (furosemide, bumetanide) are the diuretics of choice for mobilizing edema fluid; later they may be continued in low doses. In advanced CHF after chronic use, resistance may develop to even high ceiling diuretics: a thiazide/metolazone/spiro-

nolactone may be combined to overcome it. Thiazide alone has very limited role in CHF. Diuretics:

- (a) Decrease preload and improve ventricular efficiency by reducing circulating volume.
- (b) Remove peripheral edema and pulmonary congestion.

Intravenous furosemide promptly increases systemic venous capacitance and produces rapid symptomatic relief. It has, in conjunction with vasodilators, virtually obviated the need for i.v. digitalization. Further, most mild cases can be maintained on diuretics without recourse to chronic digitalis therapy. However, diuretics do not influence the primary disease process in CHF, though they may dramatically improve symptoms. Despite decades of experience, no prognostic benefit has been demonstrated for diuretics. On the other hand, they may cause activation of renin-angiotensin system (RAS) which has adverse cardiovascular consequences. Chronic diuretic therapy tends to cause hypokalaemia, alkalosis and carbohydrate intolerance. Current opinion is to treat mild heart failure with ACE

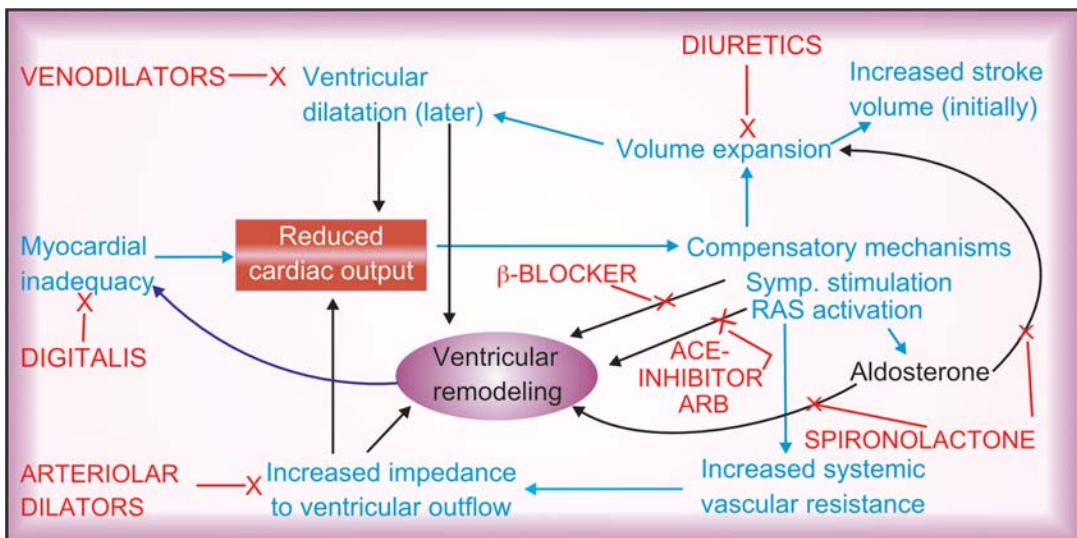

Fig. 37.5: The vicious cycle in CHF: compensatory mechanisms evoked in response to reduced cardiac output themselves perpetuate failure and contribute to remodeling responsible for disease progression. The parameter which is improved by different therapeutic measures is indicated

inhibitors/ARBs \pm β blockers only, because they afford survival benefit, while diuretics may be added intermittently as needed. Chronic diuretic therapy should be reserved for relatively advanced cases with tendency to fluid retention when diuretic is stopped. Dose should be titrated to the lowest that will check fluid retention, but not cause volume depletion to activate RAS.

Vasodilators

Vasodilators are used i.v. to treat acute heart failure that occurs in advanced cases, as well as orally for long-term therapy of chronic CHF, and have become the mainstay of anti-CHF measures. Vasodilators with differing profiles of arteriolar and venodilator action are available (*see box*).

(i) **Preload reduction:** Nitrates cause pooling of blood in systemic capacitance vessels and reduce ventricular end-diastolic pressure and volume. With reduction in size of ventricles, effectiveness of myocardial fibre shortening in causing ejection of blood during systole improves (Laplace relationship). Controlled i.v. infusion of glyceryl trinitrate affords rapid relief in acute left ventricular failure. However, a marked lowering of preload (by vasodilators + strong diuretics) may reduce output of a failing heart whose performance is dependent upon elevated filling pressure. Occurrence of nitrate tolerance limits their utility in routine treatment of CHF.

(ii) **Afterload reduction** Hydralazine dilates resistance vessels and reduces aortic impedance so that even weaker ventricular contraction is able to pump more blood; systolic wall stress is reduced. It is effective in forward failure when cardiac index (CI = min output/body surface area) is low ($< 2.5 \text{ L/min/m}^2$) without a marked increase in central venous pressure ($< 18 \text{ mm Hg}$). Marked tachycardia and fluid retention limit long-term use of hydralazine monotherapy.

Trials of the three prototype calcium channel blockers verapamil, diltiazem and nifedipine in systolic dysfunction have been disappointing, even negative with occasional worsening of symptoms and increase in mortality. This may be due to reflex sympathetic activation (nifedipine) or negative inotropic property (verapamil, diltiazem).

Venodilators (primarily \downarrow preload)

Glyceryl trinitrate
Isosorbide dinitrate

Arteriolar dilators (primarily \downarrow after load)

Hydralazine
Minoxidil
Ca²⁺ channel blockers (Nifedipine)
Pot. channel openers (Nicorandil)

Mixed dilators (\downarrow pre- and after load)

ACE Inhibitors
AT₁ antagonists (ARBs)
Prazosin (α_1 blocker)
Amrinone, Milrinone
Nitroprusside

Verapamil, however, is useful in diastolic dysfunction due to hypertrophic cardiomyopathy. Trials with long-acting and more vasoselective dihydropyridines (felodipine, amlodipine) have reported neither increase nor decrease in heart failure mortality; may be used for symptomatic relief in selected patients.

(iii) **Pre- and after load reduction** ACE inhibitors/ARBs are orally active medium efficacy non-selective arterio-venous dilators, while *Sod. nitroprusside* is high efficacy i.v. dilator with equal action on the two types of vessels. These drugs act by both the above mechanisms. Titrated i.v. infusion of nitroprusside is employed in conjunction with a loop diuretic + i.v. inotropic drug to tideover crisis in severely decompensated patients. For symptomatic treatment of acute heart failure, choice of i.v. vasodilator (glyceryl trinitrate or hydralazine or nitroprusside) depends on the primary haemodynamic abnormality in individual patients.

In the long-term, survival benefit has been obtained only with a combination of hydralazine + isosorbide dinitrate or with ACE inhibitors/ARBs; the latter performing better than the former. Only ACE inhibitors/ARBs alter the course of pathological changes in CHF (*see Ch. 36*); afford

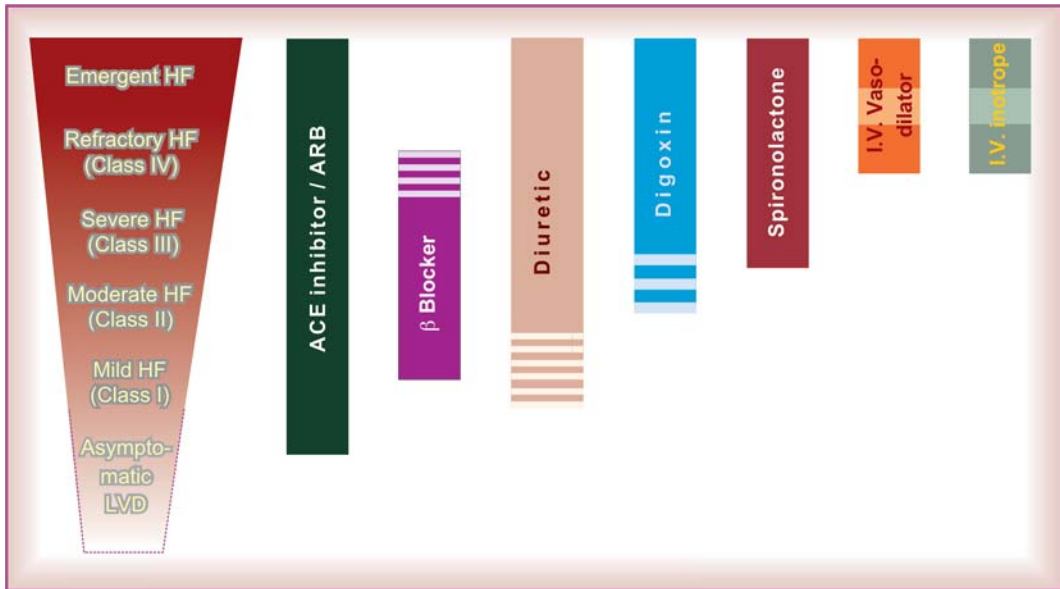

Fig. 37.6: Current pattern of clinical use of various classes of drugs in different stages of heart failure (HF) LVD—Left ventricular dysfunction; ACE—Angiotensin converting enzyme; ARB—Angiotensin receptor blocker

symptomatic as well as disease modifying benefits by retarding/reversing ventricular hypertrophy, myocardial cell apoptosis and remodeling. Prognostic benefits of ACE inhibitors/ARBs have been established in mild to severe (NYHA class I to IV) CHF as well as in patients with asymptomatic systolic dysfunction. They are thus recommended for all grades of CHF, unless contraindicated, or if renal function deteriorates.

Hydralazine causes more marked renal vasodilatation; may be selected for patients with renal insufficiency who cannot tolerate ACE inhibitors. Severe CHF patients already receiving ACE inhibitors + digoxin + diuretic have obtained extra benefit from addition of hydralazine with or without a nitrate.

For reasons not known, the α_1 blocker *prazosin* has not been able to afford prognostic benefit.

β -Adrenergic blockers Extensive studies over the past 25 years have now established the utility of β_1 blockers (mainly metoprolol and bisoprolol) and the nonselective β + selective α_1 blocker

carvedilol in mild to moderate CHF treated with ACE inhibitor \pm diuretic/digitalis.

A large number of randomized trials including Metoprolol in dilated cardiomyopathy trial (1993), US carvedilol trial (1996), MERIT-HF trial (1999), CIBIS-II trial (1999), CAPRICORN trial (2001), COPERNICUS trial (2002) have demonstrated subjective, objective, prognostic and mortality benefits of the above 3 β blockers over and above that afforded by ACE inhibitors + diuretic \pm digitalis.

Though the immediate hemodynamic action of β blockers is to depress cardiac contractility and ejection fraction, these parameters gradually improve over weeks. After a couple of months ejection fraction is generally higher than baseline, and slow upward titration of dose further improves cardiac performance. The hemodynamic benefit is maintained over long-term and hospitalization/mortality due to worsening cardiac failure, as well as all cause mortality is reduced. The benefits appear to be due to antagonism of ventricular wall stress enhancing, apoptosis promoting and pathological remodeling effects of excess sympathetic activity in CHF, as well as due to prevention of sinister arrhythmias. β blockers decrease plasma markers

of activation of sympathetic, renin-angiotensin systems and endothelin-1.

However, β blocker therapy in CHF requires caution, proper patient selection and observance of several guidelines:

- Greatest utility of β blockers has been shown in mild to moderate (NYHA class II, III) cases of dilated cardiomyopathy with systolic dysfunction in which they are now routinely coprescribed unless contraindicated.
- Encouraging results (upto 35% decrease in mortality) have been obtained in class IV cases as well, but use in severe failure could be risky and needs constant monitoring.
- There is no place for β blockers in decompensated patients. β blockers should be stopped during an episode of acute heart failure and recommenced at lower doses followed by uptitration after compensation is restored. Conventional therapy should be continued along with them.
- Starting dose should be very low—then titrated upward as tolerated to target level (carvedilol 50 mg/day, bisoprolol 10 mg/day, metoprolol 200 mg/day) or near it for maximum protection.
- A long-acting preparation (e.g. sustained release metoprolol) or 2–3 times daily dosing to produce round-the-clock β blockade should be selected.
- There is no evidence of benefit in asymptomatic left ventricular dysfunction.

Aldosterone antagonist (Spironolactone) Over the past 2 decades it has been realized that rise in plasma aldosterone in CHF, in addition to its well known Na^+ and water retaining action, is an important contributor to disease progression by direct and indirect effects:

- (a) Expansion of e.c.f. volume \rightarrow increased cardiac preload.
- (b) Fibrotic change in myocardium \rightarrow worsening systolic dysfunction and pathological remodeling.
- (c) Hypokalemia and hypomagnesemia \rightarrow increased risk of ventricular arrhythmias and sudden cardiac death.

(d) Enhancement of cardiotoxic effect of sympathetic overactivity.

The aldosterone antagonist spironolactone is a weak diuretic (*see* Ch. 41), but can benefit CHF by antagonizing the above effects of aldosterone.

In addition to several small studies, a large Randomised aldactone evaluation study (RALES, 1999) conducted on 1663 NYHA class III and IV patients having left ventricular ejection fraction $\leq 35\%$ has confirmed the additional survival benefit (30%) of spironolactone when added to conventional therapy with ACE inhibitors + other drugs. A subsequent trial (EPHESUS, 2003) using another aldosterone antagonist *eplerenone* in post acute MI heart failure has further substantiated the mortality and anti-remodeling benefit over and above that of ACE inhibitors $\pm \beta$ blockers.

Though ACE inhibitors themselves lower aldosterone levels, this effect is incomplete and short lasting. Current evidence suggests the following regarding spironolactone therapy in CHF:

- It is indicated as add-on therapy to ACE inhibitors + other drugs in moderate-to-severe CHF.
- It can retard disease progression, reduce episodes of decompensation and death due to heart failure as well as sudden cardiac deaths, over and above the protection afforded by ACE inhibitors/ARBs $\pm \beta$ blockers.
- Only low doses (12.5–25 mg/day) of spironolactone should be used to avoid hyperkalaemia; particularly because of concurrent ACE inhibitor/ARB therapy.
- It may help restoration of diuretic response to furosemide when refractoriness has developed.

The onset of benefit of spironolactone in CHF is slow. It is contraindicated in renal insufficiency: carries risk of hyperkalemia—requires serum K^+ monitoring. Gynaecomastia occurs in a number of male patients. However, spironolactone is a significant additional therapeutic measure in moderate-severe CHF with prognostic benefits.

Sympathomimetic inotropic drugs (*see* Ch. 9)

Drugs with β adrenergic and dopaminergic D1 agonistic actions have positive inotropic and vasodilator properties through activation of

adenylyl cyclase which may be utilized to combat emergency pump failure.

Dobutamine (2–8 µg/kg/min) a relatively selective β₁ agonist with prominent inotropic action is the preferred drug for i.v. infusion in acute heart failure accompanying myocardial infarction (MI), cardiac surgery as well as to tide over crisis in advanced decompensated CHF.

Dopamine (3–10 µg/kg/min by i.v. infusion) has been used in cardiogenic shock due to MI and other causes. While dobutamine does not raise (may lower) systemic vascular resistance and is preferred in heart failure, dopamine tends to increase afterload, especially at higher rates of infusion (>5 µg/kg/min) and has limited utility in patients who are not in shock. Low rates of dopamine infusion cause selective renal vasodilatation (D1 agonistic action)—improve renal perfusion and g.f.r. This can restore diuretic response to i.v. furosemide in refractory CHF. These drugs afford additional haemodynamic support over and above vasodilators, digitalis and diuretics, but benefits are short-lasting. Due to development of tolerance, these drugs have no role in the long-term management of CHF.

Phosphodiesterase III inhibitors

Theophylline is a phosphodiesterase inhibitor that is non-selective for different isoforms of this enzyme which degrades intracellular cAMP and cGMP. Intravenous aminophylline had been used in past for acute left ventricular failure with limited benefits, but unacceptable toxicity.

Amrinone (Inamrinone) It is chemically and pharmacologically distinct from digitalis and catecholamines. This bipyridine derivative is a selective phosphodiesterase III (PDE III) inhibitor. The PDE III isoenzyme is specific for intracellular degradation of cAMP in heart, blood vessels and bronchial smooth muscles. Amrinone increases myocardial cAMP and transmembrane influx of Ca²⁺. It does not inhibit Na⁺K⁺ATPase, and its action is independent of tissue catecholamines and adrenergic receptors.

The two most important actions of amrinone are *positive inotropy* and direct *vasodilatation*: has

been called an 'inodilator'. Compared to dobutamine, proportionately greater decrease in systemic vascular resistance is noted.

In CHF patients i.v. amrinone action starts in 5 min and lasts 2–3 hours; elimination t_{1/2} is 2–5 hours. It increases cardiac index, left ventricular ejection fraction and decreases peripheral vascular resistance, CVP, left ventricular end diastolic volume and pressure accompanied by mild tachycardia and slight fall in BP.

Adverse effects Thrombocytopenia is the most prominent and dose related side effect, but is mostly transient and asymptomatic. Nausea, diarrhoea, abdominal pain, liver damage, fever and arrhythmias are the other adverse effects.

Use Though amrinone is active orally, its oral use in maintenance therapy of CHF has been abandoned, because efficacy was lost and mortality was increased in comparison to placebo.

It is indicated only for short-term i.v. use in severe and refractory CHF, as an additional drug to conventional therapy with digitalis, diuretics and vasodilators.

Dose: 0.5 mg/kg bolus injection followed by 5–10 µg/kg/min i.v. infusion (max. 10 mg/kg in 24 hours). **AMICOR, CARDIOTONE** 5 mg/ml (as lactate) 20 ml amp.

Milrinone Related to amrinone; has similar action but is more selective for PDE III, and is at least 10 times more potent. It is shorter-acting with a t_{1/2} of 40–80 min.

Thrombocytopenia is not significant. In long term prospective trials, increased mortality has been reported with oral milrinone also. Milrinone is preferred over amrinone for short-term use.

Dose: 50 µg/kg i.v. bolus followed by 0.4–1.0 µg/kg/min infusion.

PRIMACOR IV 10 mg/10 ml inj.

Nisiritide This recombinant brain natriuretic peptide (BNP) has been approved recently for i.v. use to relieve dyspnoea and other symptoms in refractory CHF, especially in patients prone to develop cardiac arrhythmias. It enhances salt and water excretion as well as produces vasodilatation. Additional haemodynamic and symptomatic improvement can be obtained for short-periods.

CHAPTER 38

Antiarrhythmic Drugs



These are drugs used to prevent or treat irregularities of cardiac rhythm.

Nearly 3 out of 4 patients of acute myocardial infarction (MI) and about half of those given a general anaesthetic exhibit at least some irregularity of cardiac rhythm. Arrhythmias are the most important cause of sudden cardiac death. However, only few arrhythmias need to be treated with antiarrhythmic drugs.

Abnormal automaticity or impaired conduction or both underlie cardiac arrhythmias. The generation and propagation of cardiac impulse and properties of excitability and refractoriness are described on p. 476 to 478. Ischaemia,

electrolyte and pH imbalance, mechanical injury, stretching, neurogenic and drug influences, including antiarrhythmics themselves, can cause arrhythmias by altering electrophysiological properties of cardiac fibres.

Important mechanisms of cardiac arrhythmias are:

A. Enhanced/ectopic pacemaker activity The slope of phase-4 depolarization may be increased pathologically in the automatic fibres or such activity may appear in ordinary fibres. Ectopic impulse may result from current of injury. Myocardial cells damaged by ischaemia become partially depolarized: a current may flow between these and normally polarized fibres (injury current) and initiate an impulse.

B. After-depolarizations These are secondary depolarizations accompanying a normal or premature action potential (AP), Fig. 38.1.

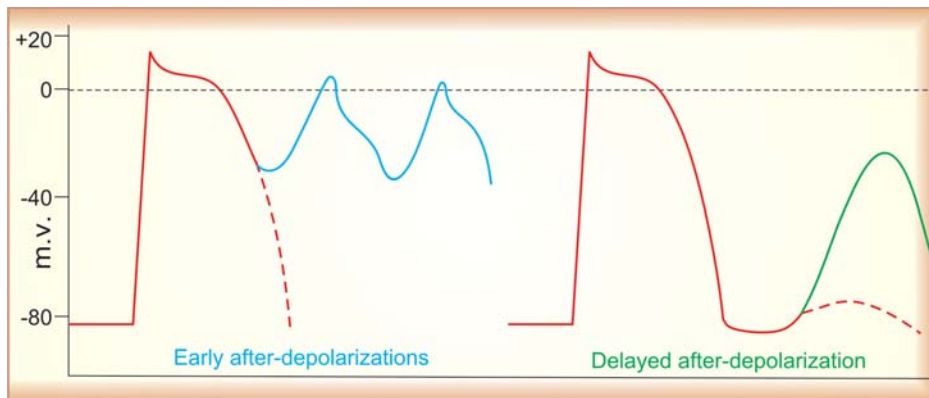

Fig. 38.1: Early and delayed after-depolarizations in a nonautomatic myocardial fibre

Early after-depolarization (EAD) Repolarization during phase-3 is interrupted and membrane potential oscillates. If the amplitude of oscillations is sufficiently large, neighbouring tissue is activated and a series of impulses are propagated. EADs are frequently associated with long Q-T interval due to slow repolarization and prolonged APs. They result from depression of delayed rectifier K^+ current.

Delayed after-depolarization (DAD) After attaining resting membrane potential (RMP) a secondary deflection occurs which may reach threshold potential and initiate a single premature AP. Generally result from Ca^{2+} overload (digitalis toxicity, ischaemia-reperfusion).

Because an AP is needed to trigger after-depolarizations, arrhythmias based on these have been called *triggered arrhythmias*.

C. Reentry Due primarily to abnormality of conduction, an impulse may recirculate in the heart and cause repetitive activation without the need for any new impulse to be generated. These are called *reentrant arrhythmias*.

(i) **Circus movement type** It occurs in an anatomically defined circuit. A premature impulse, temporarily blocked in one direction by refractory tissue, makes a one-way transit around an obstacle (natural orifices in heart, infarcted or refractory myocardium), finds the original spot in an advanced state of recovery and reexcites it, setting up recurrent activation of adjacent myocardium (Fig. 38.2).

Reentry occurring in an anatomically fixed circuit can be permanently cured by high radiofrequency catheter ablation of the defined pathway.

(ii) **Microreentry circuit** It may form at the junction of a Purkinje fibre (PF) with ordinary ventricular fibre (gate region). One of the branches of the PF may get sufficiently depolarized to cause unidirectional block (Fig. 38.3). Extremely slow conduction at this site due to slow channel depolarization and markedly abbreviated action potential duration (APD) and effective refractory period (ERP) makes reentry possible in a short loop of tissue.

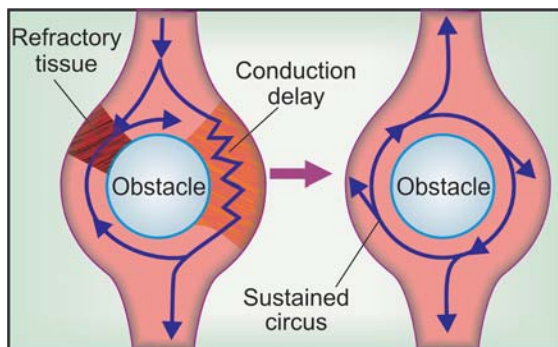

Fig. 38.2: Diagrammatic depiction of circus movement reentry in atrium

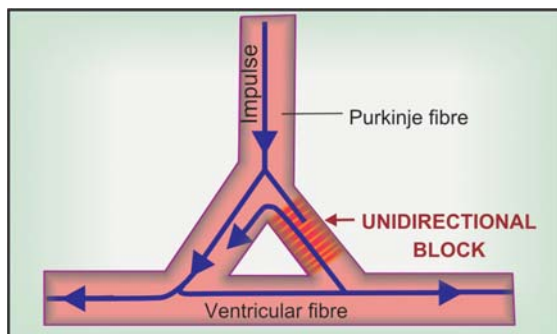

Fig. 38.3: Diagrammatic depiction of microreentry circuit in ventricle

For reentry to occur, the path length of the circuit should be greater than the wave length ($ERP \times$ conduction velocity) of the impulse. Slow conduction in the reentrant circuit may be caused by:

- Partial depolarization of the membrane—decreased slope of phase 0 depolarization, i.e. depressed fast channel response.
- Cells changing over from fast channel to slow channel depolarization which conducts extremely slowly. When a fibre is depolarized to a RMP of about -60 mv, the Na^+ (fast) channels are inactivated, but it can still develop Ca^{2+} (slow) channel response.

Reentry can be abolished both by marked slowing of conduction (converting unidirectional block to bidirectional block) as well as by acceleration of impulse (retrograde impulse reaches so early as to meet refractory tissue).

D. Fractionation of impulse When atrial ERP is brief and inhomogeneous (under vagal overactivity), an impulse generated early in diastole gets conducted irregularly over the atrium, i.e. it moves rapidly through fibres with short ERP (which have completely recovered) slowly through fibres with longer ERP (partially recovered) and not at all through those still refractory. Thus, asynchronous activation of atrial fibres occurs \rightarrow atrial fibrillation (AF). This arrhythmia must be initiated by a premature depolarization, but is self sustaining, because passage of an irregular impulse leaves a more irregular refractory trace and perpetuates the inhomogeneity of ERPs.

The important cardiac arrhythmias are:

- Extrasystoles (ES)** are premature beats due to abnormal automaticity or after-depolarization arising from an ectopic focus in the atrium (AES), A-V node (nodal ES) or ventricle (VES). The QRS complex in VES is broader and abnormal in shape.
- Paroxysmal supraventricular tachycardia (PSVT)** is sudden onset episodes of atrial tachycardia (rate 150–200/min) with 1:1

atrioventricular conduction: mostly due to circus movement type of re-entry occurring within or around the A-V node or using an accessory pathway between atria and ventricle (Wolff-Parkinson-White syndrome).

3. **Atrial flutter (AFI)** Atria beat at a rate of 200–350/min and there is a physiological 2:1 to 4:1 or higher A-V block (because A-V node cannot transmit impulses faster than 200/min). This is mostly due to a stable re-entrant circuit in the right atrium, but some cases may be due to rapid discharge of an atrial focus.
4. **Atrial fibrillation (AF)** Atrial fibres are activated asynchronously at a rate of 350–550/min (due to electrophysiological inhomogeneity of atrial fibres), associated with grossly irregular and often fast (100–160/min) ventricular response. Atria remain dilated and quiver like a bag of worms.
5. **Ventricular tachycardia** is a run of 4 or more consecutive ventricular extrasystoles. It may be a sustained or nonsustained arrhythmia, and is due either to discharges from an ectopic focus, after-depolarizations or single site (monomorphic) or multiple site (polymorphic) reentry circuits.
6. **Torsades de pointes** (French: twisting of points) is a life-threatening form of polymorphic ventricular tachycardia with rapid asynchronous complexes and an undulating baseline on ECG. It is generally associated with long Q-T interval.
7. **Ventricular fibrillation (VF)** is grossly irregular, rapid and fractionated activation of ventricles resulting in incoordinated contraction of its fibres with loss of pumping function. It is fatal unless reverted within 2–5 min; is the most common cause of sudden cardiac death.
8. **Atrio-ventricular (A-V) block** is due to depression of impulse conduction through the A-V node and bundle of His, mostly due to vagal influence or ischaemia.

First degree A-V block: Slowed conduction resulting in prolonged P-R interval.

Second degree A-V block: Some supraventricular complexes are not conducted: drop beats.

Third degree A-V block: No supraventricular complexes are conducted; ventricle generates its own impulse; complete heart block.

Arrhythmogenic potential of antiarrhythmics Most antiarrhythmics can themselves precipitate serious arrhythmias, especially during long-term prophylactic use. Two multicentric trials 'Cardiac Arrhythmia Suppression Trial I and II' (CAST I, II, 1991, 1992) have shown that post-MI patients randomized to receive on a long-term basis encainide, flecainide, moricizine had higher incidence of sudden death, though initially the same drugs had suppressed VES in these patients. It is possible that during transient episodes of ischaemia, the intraventricular conduction slowing action of these drugs gets markedly accentuated resulting in VT and VF. It is therefore not prudent to try and suppress all extrasystoles/arrhythmias with drugs.

Drugs that prolong Q-T interval (have potential to precipitate Torsades de pointes)

- | | |
|---------------------------|--|
| 1. <i>Antiarrhythmics</i> | : Quinidine, procainamide, disopyramide, propafenone, amiodarone |
| 2. <i>Antimicrobials</i> | : Quinine, mefloquine, artemisinin, halofantrine, sparfloxacin, gatifloxacin |
| 3. <i>Antihistaminics</i> | : Terfenadine, astemizole, ebastine |
| 4. <i>Antidepressants</i> | : Amitriptyline and other tricyclics |
| 5. <i>Antipsychotics</i> | : Thioridazine, risperidone |
| 6. <i>Prokinetic</i> | : Cisapride |

CLASSIFICATION

Antiarrhythmic drugs act by blocking myocardial Na⁺, K⁺ or Ca²⁺ channels. Some have additional or even primary autonomic effects. Classification of antiarrhythmic drugs has been unsatisfactory, because many drugs have more than one action. Vaughan Williams and Singh (1969) proposed a 4 class system which takes into account the most important property of a drug which is apparently responsible for its antiarrhythmic action in the clinical setting. This system, though arbitrary, is widely accepted.

CLASS I

The primary action of drugs in this class is to limit the conductance of Na⁺ (and K⁺) across cell membrane—a local anaesthetic action. They also

Antiarrhythmic drugs

Class	Actions	Drugs
I.	Membrane stabilizing agents (Na^+ channel blockers)	
	A. Moderately decrease dv/dt of 0 phase	Quinidine, Procainamide Disopyramide, Moricizine
	B. Little decrease in dv/dt of 0 phase	Lidocaine, Mexiletine
	C. Marked decrease in dv/dt of 0 phase	Propafenone, Flecainide
II.	Antiadrenergic agents (β blockers)	Propranolol, Esmolol Sotalol (also class III)
III.	Agents widening AP (prolong repolarization and ERP)	Amiodarone, Bretylium (also class II) Dofetilide, Ibutilide
IV.	Calcium channel blockers	Verapamil, Diltiazem

Note: Class IA agents also have Class III property; Propranolol has Class I action as well; sotalol and bretylium have both Class II and Class III actions.

In addition

- For PSVT : Adenosine, Digitalis.
- For A-V block : Sympathomimetics—Isoprenaline, etc.
Anticholinergics—Atropine.
- Digitalis is used in AF, AFl and PSVT to control ventricular rate.

reduce rate of phase-4 depolarization in automatic cells.

SUBCLASS IA

The subclass IA containing the oldest antiarrhythmic drugs *quinidine* and *procainamide* are open state Na^+ channel blockers which also moderately delay channel recovery (1–10s), suppress A-V conduction and prolong refractoriness. The Na^+ channel blockade is greater at higher frequency (premature depolarization is affected more). These actions serve to extinguish ectopic pacemakers that are often responsible for triggered arrhythmias and abolish re-entry by converting unidirectional block into bidirectional block.

Quinidine

It is the dextro isomer of the antimalarial alkaloid quinine found in cinchona bark. In addition to Na^+ channel

blockade, quinidine has cardiac antivagal action which augments prolongation of atrial ERP and minimizes RP disparity of atrial fibres. A-V node ERP is increased by direct action of quinidine, but decreased by its antivagal action; overall effect is inconsistent. Quinidine depresses myocardial contractility; failure may be precipitated in damaged hearts.

ECG: It increases P-R and Q-T intervals and tends to broaden QRS complex. Changes in the shape of T wave may be seen reflecting effect on repolarization.

Mechanism of action: Quinidine blocks myocardial Na^+ channels in the open state—reduces automaticity and maximal rate of 0 phase depolarization in a frequency dependent manner. Prolongation of APD is due to K^+ channel block, while lengthening of ERP is caused by its moderate effect on recovery of Na^+ and K^+ channels. At high concentrations it also inhibits L type Ca^{2+} channels. Quinidine decreases the availability of Na^+ channels as well as delays their reactivation.

The other actions of quinidine are fall in BP (weak α adrenergic blockade and cardiac depression), decreased skeletal muscle contractility, uterine contractions, vomiting, diarrhoea and neurological effects like ringing in ears, vertigo, deafness, visual disturbances and mental changes

(Cinchonism). Like its levo isomer, it has antimalarial action, and has been used as a parenteral alternative to quinine for falciparum malaria. The important drug interactions of quinidine are:

- Rise in blood levels and toxicity of digoxin due to displacement from tissue binding and inhibition of P-glycoprotein mediated renal and biliary clearance of digoxin.
- Marked fall in BP in patients receiving vasodilators.
- Risk of *torsades de pointes* is increased by hypokalaemia caused by diuretics.
- Synergistic cardiac depression with β -blockers, verapamil, K^+ salts.
- Quinidine inhibits CYP2D6: prolongs $t_{1/2}$ of propafenone and inhibits conversion of codeine to morphine.

Use: Though quinidine is effective in many atrial and ventricular arrhythmias, it is not used to terminate them because of risk of adverse effects, including that of *torsades de pointes*, sudden cardiac arrest or VF; idiosyncratic angioedema, vascular collapse, thrombocytopenia. It is occasionally used in a dose of 100–200 mg TDS to maintain sinus rhythm after termination of AF or AFL, and rarely in ventricular arrhythmias.

QUINIDINE SULPHATE 200 mg tab; QUININGA 300 mg tab, 600 mg/2 ml inj; NATCARDINE 100 mg tab.

Procainamide

It is the orally active amide derivative of the local anaesthetic procaine, with cardiac electrophysiological actions almost identical to those of quinidine, *viz.* slowing of 0 phase and impulse conduction, prolongation of APD, ERP, QRS complex and Q-T interval. Significant differences between the two are:

- It is less effective in suppressing ectopic automaticity.
- It causes somewhat less marked depression of contractility and A-V conduction.
- Antivagal action is minimal.
- It is not an α blocker: causes less fall in BP; at high doses, fall in BP is due to ganglionic blockade.

Pharmacokinetics Oral bioavailability of procainamide is about 75%, peak plasma concentration occurs in 1 hour. It is metabolized in liver, primarily by acetylation to N-acetyl-procainamide (NAPA) which has no Na^+ channel blocking property but blocks K^+ channels and prolongs

repolarization: APD is lengthened. There are fast and slow acetylators of procainamide (as there are for isoniazid). More than half of procainamide is excreted unchanged in urine; plasma $t_{1/2}$ is relatively short (3–4 hours). Thus, more frequent dosing than quinidine is required.

Dose: For abolition of arrhythmia—0.5–1 g oral or i.m. followed by 0.25–0.5 g every 2 hours; or 500 mg i.v. loading dose (25 mg/min injection) followed by 2 mg/kg/hour. Maintenance dose—0.5 g every 4–6 hours.

PRONESTYL 250 mg tab., 1 g/10 ml inj.

Adverse effects Gastrointestinal tolerance of procainamide is better than quinidine, but nausea and vomiting do occur.

CNS: weakness, mental confusion and hallucinations are noted at higher doses.

Flushing and hypotension are seen on rapid i.v. injection. Cardiac toxicity, ability to cause *torsades de pointes* are similar to quinidine.

Hypersensitivity reactions are rashes, fever, angioedema. Agranulocytosis and aplastic anaemia is rare.

More than half of patients given chronic high dose procainamide therapy develop antinuclear antibodies and about 1/5 develop systemic lupus erythematosus (SLE). It is more common in slow acetylators.

Use Procainamide (i.v.) can terminate monomorphic VT in upto 80–90% patients, but is less effective in preventing recurrences. Many WPW reciprocal VTs respond and it has been used to prevent recurrences of VF. However, procainamide is not suitable for prolonged oral therapy because of inconveniently frequent dosing and high risk of lupus.

Disopyramide

It is a quinidine like Class IA drug that has prominent cardiac depressant and anticholinergic actions, but no α adrenergic blocking property. Disopyramide usually has no effect on sinus rate because of opposing direct depressant and antivagal actions. Prolongation of P-R interval and QRS broadening are less marked.

Pharmacokinetics Bioavailability of oral disopyramide is about 80%. It is partly metabolized in liver by dealkylation, nearly half is excreted unchanged in urine; plasma $t_{1/2}$ is 6–8 hrs. The $t_{1/2}$ is increased in patients of MI and in renal insufficiency.

Dose: 100–150 mg 6–8 hourly oral.

NORPACE 100, 150 mg cap, REGUBEAT 100 mg tab.

Adverse effects Disopyramide is better tolerated than quinidine, less g.i. effects.

Anticholinergic side effects are the most prominent: dry mouth, constipation, urinary retention (especially in elderly males) and blurred vision. It can cause greater depression of cardiac contractility. Cardiac decompensation and hypotension may occur in patients with damaged hearts because it also increases peripheral resistance, so that cardiac output may be markedly decreased.

Contraindications are—sick sinus, cardiac failure and prostate hypertrophy.

Use The primary indication of disopyramide is as a second line drug for prevention of recurrences of ventricular arrhythmia. It may also be used for maintenance therapy after cardioversion of AF or AFL.

Moricizine This Class IA drug delays Na^+ channel recovery to a greater extent (also classified as Class IC), but cardiodepressant and CNS effects are less marked. It has been used to suppress VES and WPW arrhythmias, but the CAST II study has found it to increase mortality in post-MI patients.

SUBCLASS IB

These drugs block Na^+ channels more in the inactivated than in the open state, but do not delay channel recovery (channel recovery time < 1S). They do not depress A-V conduction or prolong (even shorten) APD, ERP and Q-T.

Lidocaine (Lignocaine)

It is the most commonly used local anaesthetic. In addition, it is a popular antiarrhythmic in intensive care units.

The most prominent cardiac action of lidocaine is suppression of automaticity in ectopic foci. Enhanced phase-4 depolarization in partially depolarized or stretched PFs, and after-depolarizations are antagonized, but SA node automaticity is not depressed.

The rate of 0 phase depolarization and conduction velocity in A-V bundle or ventricles is not decreased. Lidocaine decreases APD in PF and ventricular muscle, but has practically no effect on APD and ERP of atrial fibres. Atrial reentry is not affected. However, it can suppress reentrant ventricular arrhythmias either by abolishing one-way block or by producing two way block.

Lidocaine is a blocker of inactivated Na^+ channels more than that of open state. As such, it is relatively selective for partially depolarized cells and those with longer APD (whose Na^+ channels remain inactivated for longer period). While normal ventricular and conducting fibres are minimally affected, depolarized/damaged fibres are significantly depressed. Brevity of atrial AP and lack of lidocaine effect on channel recovery might explain its inefficacy in atrial arrhythmias.

Lidocaine has minimal effect on normal ECG; QT interval may decrease. It causes little depression of cardiac contractility or arterial BP. There are no significant autonomic actions: all cardiac effects are direct actions.

Pharmacokinetics Lidocaine is inactive orally due to high first pass metabolism in liver. Action of an i.v. bolus lasts only 10–20 min because of rapid redistribution. It is hydrolysed, deethylated and conjugated; metabolites are excreted in urine. Metabolism of lidocaine is hepatic blood flow dependent.

The $t_{1/2}$ of early distribution phase is 8 min while that of later elimination phase is nearly 2 hours. Its $t_{1/2}$ is prolonged in CHF, because of decrease in volume of distribution and hepatic blood flow.

Dose and preparations Lidocaine is given only by i.v. route: 50–100 mg bolus followed by 20–40 mg every 10–20 min or 1–3 mg/min infusion.

XYLOCARD, GESICARD 20 mg/ml inj. (5, 50 ml vials).

These preparations for cardiac use contain no preservative. The local anaesthetic preparations should not be used for this purpose.

Ventricular ectopic activity can be titrated with the rate of administration. Propranolol prolongs $t_{1/2}$ of lidocaine by reducing hepatic blood flow. Cimetidine also increases plasma levels of lidocaine.

Adverse effects The main toxicity is dose related neurological effects:

Drowsiness, nausea, paresthesias, blurred vision, disorientation, nystagmus, twitchings and fits.

Lidocaine has practically no proarrhythmic potential and is the least cardiotoxic antiarrhythmic. Only excessive doses cause cardiac depression and hypotension.

Use Lidocaine is used only in ventricular tachyarrhythmias. It is ineffective in atrial arrhythmias. Because of rapidly developing and titratable action it is a good drug in the emergency setting, e.g. arrhythmias following acute MI, during cardiac surgery, etc. Given prophylactically by infusion in acute MI, it reduces occurrence of VF. However, metaanalysis has shown that lidocaine fails to improve survival; may even increase short term mortality. Therefore, it is no longer administered routinely to all MI patients.

Efficacy of lidocaine in chronic ventricular arrhythmia is low, but it is useful in digitalis toxicity because it does not worsen A-V block.

Mexiletine

It is a local anaesthetic and an active antiarrhythmic by the oral route; chemically and pharmacologically similar to lidocaine. It reduces automaticity in PF, both by decreasing phase-4 slope and by increasing threshold voltage. By reducing the rate of 0 phase depolarization in ischaemic PF it may convert one-way block to two-way block.

Mexiletine is almost completely absorbed orally, 90% metabolized in liver and excreted in urine; plasma $t_{1/2}$ 9–12 hours.

Bradycardia, hypotension and accentuation of A-V block may attend i.v. injection of mexiletine. Neurological—tremor, nausea and vomiting are common; dizziness, confusion, blurred vision, ataxia can occur.

Dose: 100–200 mg i.v. over 10 min., 1 mg/min infusion.

Oral: 150–200 mg TDS with meals.

MEXITIL 50, 150 mg caps, 250 mg/10 ml inj.

Use Parenteral mexiletine is effective in post-infarction ventricular arrhythmias as alternative to lidocaine in resistant cases. Orally it is used to keep VES and VT suppressed over long-term.

SUBCLASS IC

These are the most potent Na⁺ channel blockers with more prominent action on open state and the longest recovery times (> 10S). They markedly delay conduction, prolong P-R, broaden QRS complex, but have variable effect on APD. Drugs of this subclass have high proarrhythmic potential—sudden deaths have occurred.

They have profound effect on His-Purkinje as well as accessory pathway conduction; markedly retard anterograde as well as retrograde conduction in the bypass tract of WPW syndrome.

Propafenone By blocking Na⁺ channels propafenone markedly depresses conduction and has β adrenergic blocking property—can precipitate CHF and bronchospasm. Sino-atrial block has occurred occasionally. Propafenone is absorbed orally and undergoes variable first pass metabolism; there being *extensive* or *poor* metabolizers. Bioavailability and $t_{1/2}$ differs considerably among individuals. Some metabolites are active. Side effects are nausea, vomiting, bitter taste, constipation and blurred vision.

Propafenone is a reserve drug for ventricular arrhythmias, reentrant tachycardias involving AV node/accessory pathway and to maintain sinus rhythm in AF.

Dose: 150 mg BD–300 mg TDS;

RHYTHMONORM 150 mg tab.

Flecainide It suppresses VES, VT, WPW tachycardia and prevents recurrences of AF and PSVT. But in the

CAST study it was found to increase mortality in patients recovering from MI; can itself provoke arrhythmias during chronic therapy. It is reserved for resistant cases of recurrent AF, and WPW rhythms in patients not having associated CHF.

CLASS II

The primary action of drugs in this class is to suppress adrenergically mediated ectopic activity.

Propranolol (see Ch. 10) Some β blockers, e.g. propranolol have quinidine like direct membrane stabilizing action at high doses, but in the clinically used dose range—antiarrhythmic action is exerted primarily because of cardiac adrenergic blockade. Propranolol decreases the slope of phase-4 depolarization and automaticity in SA node, PF and other ectopic foci when this has been increased under adrenergic influence; little action otherwise. The other most important action is to prolong the ERP of A-V node (an antiadrenergic action). This impedes A-V conduction (no paradoxical tachycardia can occur when atrial rate in AF or AFL is reduced).

Slow channel responses and after-depolarizations that have been induced by catecholamines (CAs) are suppressed. Reentrant arrhythmias that involve A-V node (many PSVTs) or that are dependent on slow channel/depressed fast channel response may be abolished by its marked depressant action on these modalities.

The most prominent ECG change is prolongation of PR interval. Depression of cardiac contractility and BP are less marked than with quinidine.

Administration For rapid action, propranolol may be injected i.v. 1 mg/min (max. 5 mg) under close monitoring. The usual oral antiarrhythmic dose is 40–80 mg 2–4 times a day.

Use Propranolol is very useful in treating inappropriate sinus tachycardia, atrial and nodal ESs provoked by emotion or exercise. It is less effective than adenosine and verapamil for PSVT—conversion rate is about 60%.

Propranolol rarely abolishes AF or AFL, but can be used to control ventricular rate. It is highly

effective in sympathetically mediated arrhythmias seen in pheochromocytoma and during anaesthesia with halothane. Digitalis induced tachyarrhythmias may be suppressed.

Efficacy in chronic ventricular arrhythmias is low, but its antiischaemic action may be protective. Prophylactic treatment with β blockers reduces mortality in post-MI patients. Propranolol has also been used for WPW, but in some cases severe bradycardia may be precipitated.

Sotalol (see p. 140) It is a nonselective β blocker having prominent Class III action of prolonging repolarization by blocking cardiac K^+ channels. It is not a Na^+ channel blocker—does not depress conduction in fast response tissue, but delays A-V conduction and prolongs its ERP. Sotalol is effective in polymorphic VT and for maintaining sinus rhythm in AF/AFL. Due to prolongation of APD and Q-T, risk of dose-dependent *torsades de pointes* is the major limitation. It is contraindicated in patients with long Q-T interval.

Esmolol (see p. 141) This quick and short acting β_1 blocker administered i.v. is very useful for emergency control of ventricular rate in AF/AFL. It can terminate supraventricular tachycardia, and is mainly used for arrhythmias associated with anaesthesia.

MINIBLOCK 100 mg/10 ml, 250 mg/10 ml inj.; 0.5 mg/kg in 1 min followed by 0.05–0.2 mg/kg/min i.v. infusion.

CLASS III

The characteristic action of this class is prolongation of repolarization; AP is widened and ERP is increased. The tissue remains refractory even after full repolarization: reentrant arrhythmias are terminated.

Amiodarone

This unusual iodine containing highly lipophilic long-acting antiarrhythmic exerts multiple actions:

- Prolongs APD and Q-T interval attributable to block of myocardial delayed rectifier K^+ channels. This also appears to reduce

nonuniformity of refractoriness among different fibres.

- Preferentially blocks inactivated Na⁺ channels (like lidocaine) with relatively rapid rate of channel recovery: more effective in depressing conduction in cells that are partially depolarized or have longer APD.
- Inhibits myocardial Ca²⁺ channels and has noncompetitive β adrenergic blocking property.

Conduction is slowed and ectopic automaticity is markedly depressed, but that of SA node is affected only slightly. Effect of oral doses on cardiac contractility and BP are minimal, but i.v. injection frequently causes myocardial depression and hypotension.

Despite prolongation of APD, the arrhythmia (*torsades de pointes*) provoking potential of amiodarone is low, probably because it does not exhibit 'reverse use-dependence' of APD prolongation or because of its multiple antiarrhythmic mechanisms. The prolongation of APD by most class III drugs is more marked at slower rates of activation (encouraging EAD) than at higher rates (reverse use-dependence), while with amiodarone it is independent of rate of activation.

Pharmacokinetics Amiodarone is incompletely and slowly absorbed from the g.i.t. On daily oral ingestion the action develops over several days, even weeks. However, on i.v. injection, action develops rapidly. It accumulates in muscle and fat from which it is slowly released and then metabolized in liver mainly by CYP3A4. One metabolite is active. The duration of action is exceptionally long; t_{1/2} 3–8 weeks.

Dose: Amiodarone is mainly used orally 400–600 mg/day for few weeks, followed by 100–200 mg OD for maintenance therapy. 100–300 mg (5 mg/kg) slow i.v. injection over 30–60 min.

CORDARONE, ALDARONE, EURYTHMIC 100, 200 mg tabs, 150 mg/3 ml inj.

Use Amiodarone has been found effective in a wide range of ventricular and supraventricular arrhythmias. Resistant VT and recurrent VF are the most important indications. It is also used to maintain sinus rhythm in AF when other drugs have failed. Rapid termination of ventricular and supraventricular arrhythmias can be obtained by

i.v. injection. WPW tachyarrhythmia is terminated by suppression of both normal and aberrant pathways.

Its long duration of action makes it suitable for long-term prophylactic therapy; has been found to reduce sudden cardiac death. Because of high and broad spectrum efficacy and relatively low proarrhythmic potential, amiodarone is a commonly used antiarrhythmic, despite its organ toxicity in the long-term.

Adverse effects These are dose-related and increase with duration of therapy. Fall in BP, bradycardia and myocardial depression occurs on i.v. injection and on drug cumulation.

Nausea, gastrointestinal upset may attend oral medication, especially during the loading phase. Photosensitization and skin pigmentation occurs in about 10% patients. Corneal microdeposits are common with long-term use, but are reversible on discontinuation.

Pulmonary alveolitis and fibrosis is the most serious toxicity of prolonged use, but is rare if daily dose is kept below 200 mg.

Peripheral neuropathy generally manifests as weakness of shoulder and pelvic muscles. Liver damage is rare. Amiodarone interferes with thyroid function in many ways including inhibition of peripheral conversion of T₄ to T₃: goiter, hypothyroidism and rarely hyperthyroidism may develop on chronic use.

Interactions Amiodarone can increase digoxin and warfarin levels by reducing their renal clearance. Additive A-V block can occur in patients receiving β blockers or calcium channel blockers. Inducers and inhibitors of CYP3A4 respectively decrease and increase amiodarone levels.

Bretylium It is an adrenergic neurone blocking drug (*see* Ch. 10) introduced in 1960 as antihypertensive, but was soon withdrawn. It was reintroduced for parenteral use to facilitate reversal of VF, but is not available in India or the USA, and is rarely used elsewhere.

Bretylium has complex electrophysiological effects which are partly a result of initial NA release from adrenergic terminals in heart, and later blockade of NA release, but major direct action is prolongation of APD and ERP, due to K⁺ channel blockade.

Dofetilide This newer antiarrhythmic prolongs APD and ERP by selectively blocking rapid component of delayed rectifier K⁺ current without affecting other channels or receptors; has no autonomic or peripheral actions. It is therefore labelled as *pure* class III antiarrhythmic.

Oral dofetilide can convert AF or AFL to sinus rhythm in ~30% cases, but is more effective in maintaining sinus rhythm in converted patients—its primary indication. Significantly, chronic therapy with dofetilide in patients with high risk of sudden cardiac death/post MI cases has not increased mortality, despite provoking *torsades de pointes* in some recipients. It is mainly excreted unchanged in urine and produces few side effects.

Ibutilide is another new class III antiarrhythmic used i.v. for pharmacological conversion of AFL and AF to sinus rhythm.

CLASS IV

The primary action of this class of drugs is to inhibit Ca²⁺ mediated slow channel inward current.

Verapamil

Of the many Ca²⁺ channel blockers, verapamil has the most prominent cardiac electrophysiological action (Table 38.1). It blocks L type Ca²⁺ channels and delays their recovery. Its antiarrhythmic aspects are described here, while other aspects are covered in Ch. 39 and 40.

Table 38.1: Electrophysiological actions of calcium channel blockers

	Verapamil	Diltiazem	Nifedipine
1. SA node automaticity	↓	↓,-	—
2. Ventricular automaticity	↓,-	—	—
3. ERP :			
atrial	—	—	—
A-V nodal	↑↑	↑	↑↓
ventricular	—	—	—
bypass tract	↑	↑,-	—
4. ECG :			
R-R interval	↑	↑↓	↓
P-R interval	↑	↑	—

The basic action of verapamil is to depress Ca²⁺ mediated depolarization. This suppresses automaticity or reentry dependent on slow response. Phase-4 depolarization in SA node and

PFs is reduced resulting in bradycardia and extinction of latent pacemakers. Reflex sympathetic stimulation due to vasodilatation partly counteracts the direct bradycardia producing action. Delayed after-depolarizations in PFs are dampened.

The most consistent action of verapamil is prolongation of A-V nodal ERP. As a result A-V conduction is markedly slowed and reentry involving A-V node is terminated. Intraventricular conduction, however, is not affected. Verapamil has negative inotropic action due to interference with Ca²⁺ mediated excitation-contraction coupling in myocardium.

Uses and precautions

1. PSVT—Verapamil can terminate attacks of PSVT; 5 mg i.v. over 2–3 min is effective in 80% cases, but marked bradycardia, A-V block, cardiac arrest and hypotension can occur. Verapamil should not be used if PSVT is accompanied with hypotension or CHF. It is also useful for preventing recurrences: 60 to 120 mg TDS orally.
2. To control ventricular rate in AF or AFL; it may be used as an alternative to, or in addition to digitalis: 40–80 mg TDS oral. In few cases the AF or AFL may revert to sinus rhythm, but this is an unusual happening.

Reentrant supraventricular and nodal arrhythmias (WPW) are susceptible to verapamil, but it should not be used because of risk of increased ventricular rate due to reflex sympathetic stimulation and reduction of ERP of the bypass tract in some cases.

Verapamil has poor efficacy in ventricular arrhythmias. In contrast to β blockers, verapamil prophylaxis does not reduce mortality in post-MI patients. In some patients of VT, i.v. injection of verapamil has precipitated VF: therefore contraindicated. It is also not recommended for digitalis toxicity, because additive A-V block may occur. It is contraindicated in partial heart block and sick sinus.

CALAPTIN 40, 80 mg tab; 120, 240 mg SR tab, 5 mg/2 ml inj.

Diltiazem The direct cardiac actions of diltiazem are similar to those of verapamil. However, they are less marked. It is an alternative to verapamil for PSVT.

For rapid control of ventricular rate in AF or AFL, i.v. diltiazem is preferred over verapamil, because it can be more easily titrated to the target heart rate, causes less hypotension and myocardial depression—can be used even in the presence of mild-to-moderate CHF.

DILZEM 30, 60, 90 mg tabs, 25 mg/5 ml inj.

Drugs for PSVT

An attack of PSVT can be terminated by i.v. injection of verapamil, diltiazem, esmolol or digoxin; but most cardiologists now prefer adenosine. Maintenance therapy with oral digoxin/verapamil/ β blockers can prevent recurrences.

Adenosine

Administered by rapid i.v. injection (over 1–3 sec) either as the free base (6–12 mg) or as ATP (10–20 mg), adenosine terminates within 30 sec. more than 90% episodes of PSVT involving the A-V node. It activates ACh sensitive K^+ channels and causes membrane hyperpolarization through interaction with A1 type of G protein coupled adenosine receptors on SA node (pacemaker depression \rightarrow bradycardia), A-V node (prolongation of ERP \rightarrow slowing of conduction) and atrium (shortening of AP, reduced excitability). It indirectly reduces Ca^{2+} current in A-V node; depression of the reentrant circuit through A-V node is responsible for termination of PSVT. Adrenergically induced DADs in ventricle are also suppressed. Coronary dilatation occurs transiently.

ADENOJECT, ADENOCOR 3 mg adenosine (base) per ml in 2 ml and 10 ml amp.

Adenosine has a very short $t_{1/2}$ in blood (~10 sec) due to uptake into RBCs and endothelial cells where it is converted to 5-AMP and inosine. Almost complete elimination occurs in a single passage through coronary circulation. Injected ATP is rapidly converted to adenosine.

Dipyridamole potentiates its action by inhibiting uptake, while theophylline/ caffeine antagonize its action by blocking adenosine receptors. Higher doses may be required in heavy tea/coffee drinkers. Patients on carbamazepine are at greater risk of developing heart block. Advantages of adenosine for termination of PSVT are:

- Efficacy equivalent to or better than verapamil.
- Action lasts < 1 min; adverse effects (even cardiac arrest, if it occurs) are transient.
- No haemodynamic deterioration; can be given to patients with hypotension, CHF or those receiving β blockers. Verapamil is contraindicated in these situations.
- Safe in wide QRS tachycardia (verapamil is unsafe).
- Effective in patients not responding to verapamil.

However, adenosine produces transient dyspnoea, chest pain, fall in BP and flushing in 30–60% patients; ventricular standstill for few sec or VF occurs in some patients. Bronchospasm may be precipitated in asthmatics. Adenosine has to be rapidly injected in a large vein and has brief action, not suitable for recurrent cases. It is expensive and cannot be used to prevent recurrences.

Other uses of adenosine

- (a) Diagnosis of tachycardias dependent on A-V node.
- (b) To induce brief coronary vasodilatation during certain diagnostic/interventional procedures.
- (c) To produce controlled hypotension during surgery.

Drugs for A-V Block

Atropine: When A-V block is due to vagal overactivity, e.g. digitalis toxicity, some cases of MI; it can be improved by atropine 0.6–1.2 mg i.m. Atropine abbreviates A-V node ERP and increases conduction velocity in bundle of His.

Sympathomimetics (Adr, isoprenaline): These drugs may overcome partial heart block by facilitating A-V conduction and shortening ERP of conducting tissues.

Table 38.2: Choice of drugs for cardiac arrhythmias

Arrhythmia		Acute therapy		Chronic therapy and prophylaxis	
		First choice	Alternatives	First choice	Alternatives
1. Atrial extrasystole (AES)	—	No drug	—	No drug	Disopyramide Propranolol
2. Paroxysmal supraventricular tachycardia (PSVT)		Adenosine	Esmolol Diltiazem Verapamil	Digoxin Verapamil, Propranolol	Propafenone
3. Atrial Flutter (AFL)	Conversion	Cardioversion	Overdrive pacing	Amiodarone Quinidine	Propafenone Disopyramide
	Control of vent. rate	Esmolol	Verapamil	Digoxin	Verapamil Dofetilide
4. Atrial Fibrillation (AF)	Conversion	Cardioversion	—	Amiodarone Quinidine	Disopyramide Propafenone
	Control of vent. rate	Esmolol	Verapamil	Digoxin	Verapamil Dofetilide
5. Ventricular extrasystoles (VES)	Acute MI	Lidocaine	Procainamide Disopyramide Mexiletine	—	—
	Chronic ischaemia	No drug	—	Amiodarone Mexiletine	Quinidine Disopyramide Propranolol
	Digitalis induced	Lidocaine Pot. chlor.	Propranolol	—	—
6. Ventricular tachycardia (VT)		Lidocaine Cardioversion	Procainamide Mexiletine Amiodarone	Amiodarone Dofetilide	Mexiletine Propranolol Propafenone
7. <i>Torsades de pointes</i>		Pacing	Isoprenaline Magnesium	Propranolol	Pacing
8. Ventricular fibrillation (VF)		Electrical defibrillation	Lidocaine Amiodarone	Amiodarone	Procainamide Dofetilide
9. Wolff-Parkinson-White syndrome (WPW)		Cardioversion	Amiodarone Propafenone Procainamide	Amiodarone Propranolol	Quinidine Propafenone

They may also be used in complete (3rd degree) heart block to maintain a sufficient idioventricular rate (by increasing automaticity of ventricular pacemakers) till external pacemaker can be implanted.

Choice of antiarrhythmics

Asymptomatic arrhythmias and those which do not jeopardize haemodynamics, e.g. most AES and occasional VES, first degree A-V block,

bundle branch block, etc. in an otherwise normal heart, do not require antiarrhythmic treatment. Chronic prophylactic therapy with class I and class IV antiarrhythmics does not appear to afford survival benefit, except in few selected cases. On the other hand, vigorous therapy is indicated when:

- Arrhythmia is life-threatening, e.g. sustained VT, *torsades de pointes*, VF.
- Arrhythmia is causing hypotension, breathlessness or cardiac failure.

- Palpitation is marked, e.g. in PSVT, sustained VT, AF, *torsades de pointes*.
- When simple arrhythmia may lead to more serious ones, e.g. after MI (warning arrhythmias).

In the above situations antiarrhythmics are mostly needed for short periods. The choice of an antiarrhythmic in a patient depends on:

- (a) ECG diagnosis
- (b) Possible mechanism underlying the arrhythmia
- (c) Mechanism of action and range of antiarrhythmic activity of the drug

- (d) Pharmacokinetic profile of the drug
- (e) Haemodynamic effects of the drug

The aim is to improve cardiovascular function either by restoring sinus rhythm, or by controlling ventricular rate, or by conversion to a more desirable pattern of electrical and mechanical activity.

Despite extensive investigation, choice of an antiarrhythmic is still largely empirical. Current guidelines are summarised in Table 38.2.

CHAPTER 39

Antianginal and Other Anti-ischaemic Drugs

ANTIANGINAL DRUGS

Antianginal drugs are those that prevent, abort or terminate attacks of angina pectoris.

Angina pectoris Is a pain syndrome due to induction of an adverse oxygen supply/ demand situation in a portion of the myocardium. Two principal forms are recognized:

(a) **Classical angina** (common form) Attacks are predictably provoked (stable angina) by exercise, emotion, eating or coitus and subside when the increased energy demand is withdrawn. The underlying pathology is—severe arteriosclerotic affliction of larger coronary arteries (conducting vessels) which run epicardially and send perforating branches to supply the deeper tissue (Fig. 39.1). The coronary obstruction is 'fixed'; blood flow fails to increase during increased demand despite local factors mediated dilatation of resistance vessels (Fig. 39.2) and ischaemic pain is felt. Due to inadequacy of ischaemic left ventricle, the end diastolic left ventricular pressure rises from 5 to about 25 mm Hg—produces subendocardial 'crunch' during diastole (blood flow to the subendocardial region occurs only during diastole) and aggravates the ischaemia in this region. Thus, a form of acutely developing and rapidly reversible left ventricular failure

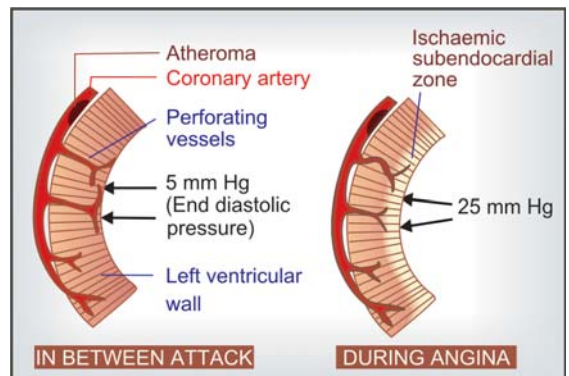

Fig. 39.1: Diagrammatic representation of subendocardial 'crunch' during an attack of angina

results which is relieved by taking rest and reducing the myocardial workload.

Drugs that are useful, primarily reduce cardiac work (directly by acting on heart or indirectly by reducing preload hence end diastolic pressure, and afterload). They may also cause favourable redistribution of blood flow to the ischaemic areas.

(b) **Variant/Prinzmetal's angina** (uncommon form) Attacks occur at rest or during sleep and are unpredictable. They are due to recurrent localized (occasionally diffuse) coronary vasospasm (Fig. 39.2) which may be superimposed on arteriosclerotic coronary artery disease.

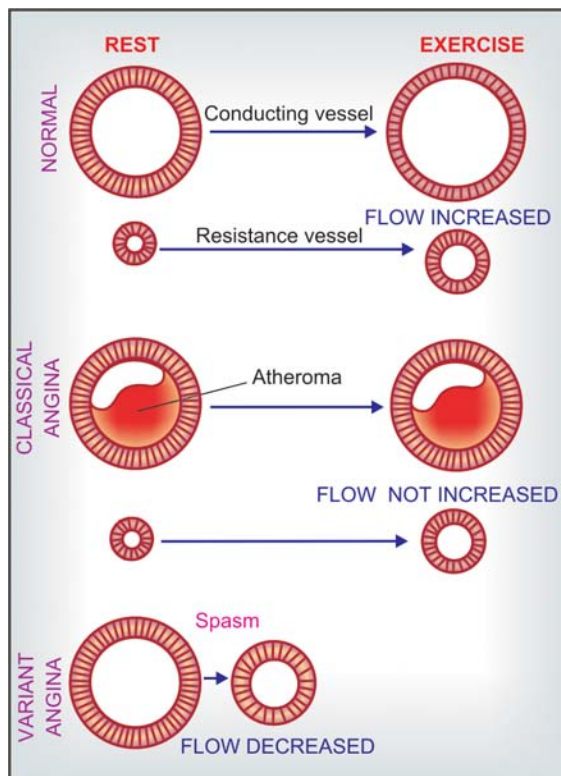

Fig. 39.2: Diagrammatic representation of coronary artery calibre changes in classical and variant angina

Abnormally reactive and hypertrophied segments in the coronary arteries have been demonstrated. Drugs are aimed at preventing and relieving the coronary vasospasm.

Unstable angina with rapid increase in duration and severity of attacks is mostly due to rupture of an atheromatous plaque attracting platelet deposition and progressive occlusion of the coronary artery; occasionally with associated coronary vasospasm.

Chronically reduced blood supply causes atrophy of cardiac muscle with fibrous replacement (reduced myocardial work capacity → CHF) and may damage conducting tissue to produce unstable cardiac rhythms. Antianginal drugs relieve cardiac ischaemia but do not alter the course of coronary artery pathology: no

permanent benefit is afforded. On the other hand, aspirin, ACE inhibitors and statins (hypocholesterolaemic) can modify coronary artery disease and improve prognosis.

Glyceryl trinitrate, the drug unsurpassed in its ability to abort and terminate anginal attack, was introduced by Murrell in 1879. Other organic nitrates were added later, but a breakthrough was achieved in 1963 when propranolol was used for chronic prophylaxis. The calcium channel blockers have been a major contribution of the 1970s and continue to proliferate. A number of vasodilator and other drugs have been promoted from time to time, but none is as uniformly effective. Some potassium channel openers (nicorandil) and metabolic modulators (trimetazidine, ranolazine) have been introduced lately.

CLASSIFICATION

1. Nitrates

- (a) *Short acting*: Glyceryl trinitrate (GTN, Nitroglycerine)
- (b) *Long acting*: Isosorbide dinitrate (short acting by sublingual route), Isosorbide mononitrate, Erythryl tetranitrate, Pentaerythritol tetranitrate

2. **β Blockers** Propranolol, Metoprolol, Atenolol and others.

3. Calcium channel blockers

- (a) *Phenyl alkylamine*: Verapamil
- (b) *Benzothiazepine*: Diltiazem
- (c) *Dihydropyridines*: Nifedipine, Felodipine, Amlodipine, Nitrendipine, Nimodipine, Lacidipine, Lercanidipine, Benidipine

4. **Potassium channel opener** Nicorandil

5. **Others** Dipyridamole, Trimetazidine, Ranolazine, Oxyphedrine

Clinical classification

- A. *Used to abort or terminate attack* GTN, Isosorbide dinitrate (sublingually).
- B. *Used for chronic prophylaxis* All other drugs.

NITRATES (GTN as prototype)

All organic nitrates share the same action; differ only in time course. The only major action is direct nonspecific smooth muscle relaxation.

Preload reduction The most prominent action is exerted on vascular smooth muscle. Nitrates dilate veins more than arteries → peripheral pooling of blood → decreased venous return i.e. preload on heart is reduced → end diastolic size and pressure are reduced → decreased cardiac work according to *Laplace relationship*—which describes the effectiveness of ventricular wall tension in elevating intraventricular pressure and the extent to which fibre shortening results in systolic ejection.

$$\text{Wall tension} = \text{intraventricular pressure} \times \frac{1}{\text{ventricular radius}}$$

Thus, reduction in ventricular radius decreases the tension that must be generated in the ventricular wall—hence decreased O₂ consumption. Reduction in cardiac output (c.o.) occurs at rest but is less marked during angina due to better ventricular emptying. The decrease in end diastolic pressure abolishes the subendocardial crunch by restoring the pressure gradient across ventricular wall due to which subendocardial perfusion occurs during diastole. It is through their action on peripheral veins that nitrates exert major beneficial effects in classical angina.

Afterload reduction Nitrates also produce some arteriolar dilatation → slightly decrease total peripheral resistance (t.p.r.) or afterload on heart; BP falls somewhat; systolic more than diastolic (reflex sympathetic activity tends to maintain diastolic BP). This action contributes to the reduction in cardiac work which is directly proportional to aortic impedance.

With usual doses, and if the patient does not stand still (which favours pooling of blood in the legs), tachycardia is not prominent. With large doses and if the mean BP falls significantly, reflex sympathetic stimulation occurs → tachycardia, increased cardiac contractility → increased cardiac work → angina may be precipitated. Fainting and cold sweat occur due to cerebral ischaemia. All these can be prevented by lying down and raising the foot end.

Redistribution of coronary flow In the arterial tree, nitrates preferentially relax bigger conducting (angiographically visible) coronary arteries than arterioles or resistance vessels. This pattern of action may cause favourable redistribution of blood flow to ischaemic areas in angina patients. Dilatation of conducting vessels all over by nitrate along with ischaemia-induced dilatation of autoregulatory resistance vessels only in the ischaemic zone increases blood flow to this area, while in the non-ischaemic zones, resistance vessels maintain their tone → flow does not increase, or may decrease to compensate for increased flow to ischaemic zone. In fact, nitrates do not appreciably increase total coronary flow in angina patients.

Mechanism of relief of angina The dilator effect on larger coronary vessels is the principal action of nitrates benefiting variant angina by counteracting coronary spasm. In classical angina undoubtedly the primary effect is to reduce cardiac work by action on peripheral vasculature, though increased blood supply to ischaemic area may contribute. Exercise tolerance of angina patients is increased because the same amount of exercise causes lesser augmentation of cardiac work.

Heart and peripheral blood flow Nitrates have no direct stimulant or depressant action on the heart. They dilate cutaneous (especially over face and neck → flushing) and meningeal vessels → headache. Splanchnic and renal blood flow decreases to compensate for vasodilatation in other areas. Nitrates tend to decongest lungs by shifting blood to systemic circulation.

Other smooth muscles Bronchi, biliary tract and esophagus are relaxed; effect on intestine, ureter, uterus is variable and insignificant.

Mechanism of action Organic nitrates are rapidly denitrated enzymatically in the smooth muscle cell to release the reactive free radical *nitric oxide* (NO) which activates cytosolic guanylyl cyclase → increased cGMP → causes dephos-

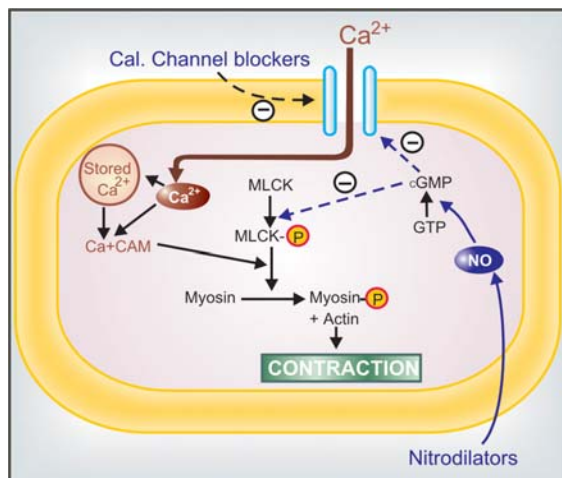

Fig. 39.3: Mechanism of vascular smooth muscle relaxant action of nitrodilators like glyceryl trinitrate and calcium channel blockers; (---) Inhibition
CAM—Calmodulin; NO—Nitric oxide; MLCK—Myosin light chain kinase; MLCK-P—Phosphorylated MLCK; GTP—Guanosine triphosphate; cGMP—Cyclic guanosine monophosphate

phorylation of myosin light chain kinase (MLCK) through a cGMP dependent protein kinase (Fig. 39.3). Reduced availability of phosphorylated (active) MLCK interferes with activation of myosin → it fails to interact with actin to cause contraction. Consequently relaxation occurs. Raised intracellular cGMP may also reduce Ca^{2+} entry—contributing to relaxation.

Veins express greater amount of the enzyme that generates NO from GTN than arteries—may account for the predominant venodilator action. It has been indicated that preferential dilatation of epicardial conducting arteries over autoregulatory arterioles is also due to differential distribution of nitrate metabolizing enzymes in these vessels.

Platelets The NO generated from nitrates activates cGMP production in platelets as well, leading to a mild antiaggregatory effect. This action may be valuable in unstable angina.

Pharmacokinetics Organic nitrates are lipid-soluble: well absorbed from buccal mucosa, intestines and skin. All except isosorbide mononitrate undergo extensive and variable first pass metabolism in liver. They are rapidly denitrated

by a glutathione reductase and a mitochondrial aldehyde dehydrogenase. The partly denitrated metabolites are less active, but have longer $t_{1/2}$. Though nitrates have been traditionally classified into short-acting and long-acting, it is the rate of absorption from the site of administration and the rate of metabolism that govern the duration of action of a particular nitrate. For example, GTN and isosorbide dinitrate are both short-acting from sublingual but longer-acting from oral route.

Adverse effects These are mostly due to vasodilatation.

1. Fullness in head, throbbing headache; some degree of tolerance develops on continued use.
2. Flushing, weakness, sweating, palpitation, dizziness and fainting; these are mitigated by lying down and accentuated by erect posture and alcohol.
3. Methemoglobinemia: is not marked with clinically used doses. However, it can reduce O_2 carrying capacity of blood in severe anaemia.
4. Rashes are rare, though relatively more common with pentaerythritol tetranitrate.

Tolerance Attenuation of haemodynamic and antiischaemic effect of nitrates occurs if they are continuously present in the body. This tolerance weans off rapidly (within hours) when the body is free of the drug. Clinically, no significant tolerance develops on intermittent use of sublingual GTN for attacks of angina. However, it may become important when GTN is used orally, transdermally or by continuous i.v. infusion round the clock, as well as with the use of long acting agents, especially sustained release formulations. Cross tolerance occurs among all nitrates. Tolerance occurs more readily with higher doses.

The mechanism of nitrate tolerance is not well understood. Reduced ability to generate NO due to depletion of cellular SH radicals has been demonstrated experimentally. However, thiol replenishing agents only partially overcome nitrate tolerance. This form of therapy has not met clinical success. Other changes which interfere with NO production like inactivation of mitochondrial aldehyde dehydrogenase

could be involved. Activation of compensatory mechanisms including volume expansion, sympathetic and renin-angiotensin system stimulation or other humoral pathways as well as oxidative stress due to free radicals generated during denitration may contribute to nitrate tolerance.

The most practical way to prevent nitrate tolerance is to provide nitrate free intervals everyday.

Dependence On organic nitrates is now well recognized. Sudden withdrawal after prolonged exposure has resulted in spasm of coronary and peripheral blood vessels. MI and sudden deaths have been recorded. Angina threshold may be lowered during nitrate free interval in some patients: episodes of angina may increase. In such cases a drug of another class should be added. Withdrawal of nitrates should be gradual.

Interactions Sildenafil causes dangerous potentiation of nitrate action: severe hypotension, MI and deaths are on record (*see* p. 296). Additive hypotension is also possible when nitrate is given to a patient receiving other vasodilators.

INDIVIDUAL DRUGS

1. Glyceryl trinitrate (GTN, Nitroglycerine) It is a volatile liquid which is adsorbed on the inert matrix of the tablet and rendered nonexplosive. The tablets must be stored in a tightly closed glass (not plastic) container lest the drug should evaporate away. The sublingual route is used when terminating an attack or aborting an imminent one is the aim. The tablet may be crushed under the teeth and spread over buccal mucosa. It acts within 1–2 min (peak blood level in 3–6 min) because of direct absorption into systemic circulation (bypassing liver where almost 90% is metabolized).

Plasma $t_{1/2}$ is 2 min, duration of action depends on the period it remains available for absorption from buccal mucosa. The remaining part of the tablet may be spit or swallowed when no longer needed. A sublingual spray formulation has been recently marketed—acts more rapidly than sublingual tablet. Hepatic metabolizing capacity

can be overwhelmed by administering a large dose (5–15 mg) orally. Sustained release oral capsules containing much larger amounts of GTN can be used for chronic prophylaxis.

Nitroglycerine is readily absorbed from the skin. In the early 1970s, cutaneous application as ointment was found to produce haemodynamic effects for 4–6 hours. A transdermal patch in which the drug is incorporated into a polymer bonded to adhesive plaster (*see* p. 9) has been developed which provides steady delivery for 24 hours. It starts working within 60 min and has a bioavailability of 70–90%. However, development of tolerance and dependence may jeopardise its value. It is advised that the patch be taken off for 8 hours daily. A transmucosal dosage form which has to be stuck to the gums under the upper lip has also been produced—acts in 5 min and releases the drug for 4–6 hours.

Intravenous infusion of GTN provides rapid, steady, titratable plasma concentration for as long as desired. It has been successfully used for unstable angina, coronary vasospasm, LVF accompanying MI, hypertension during cardiac surgery, etc. Begin with 5 $\mu\text{g}/\text{min}$, adjust according to need. Early institution of infusion may limit the size of infarct in MI.

2. Isosorbide dinitrate It is a solid but similar in properties to GTN; can be used sublingually at the time of attack (slightly slower in action than GTN, peak in 5–8 min) as well as orally for chronic prophylaxis. Presystemic metabolism on oral administration is pronounced and variable. The $t_{1/2}$ is 40 min, but sustained release formulation may afford protection for 6–10 hours. Last dose should not be taken later than 6 PM to allow nitrate level to fall during sleep at night.

3. Isosorbide mononitrate This is an active metabolite of isosorbide dinitrate. When administered orally it undergoes little first pass metabolism: bioavailability is high, interindividual differences are minimal and it is longer acting ($t_{1/2}$ 4–6 hr). Last dose is to be taken in the afternoon; SR tablet once a day in the morning.

Table 39.1: Organic nitrates available for angina pectoris

Drug	Preparations	Dose & route	Duration of action
1. GTN (Nitroglycerine)	ANGISED 0.5 mg tab	0.5 mg sublingual	10–30 min
	NITROLINGUAL, GTN spray	0.4–0.8 mg s.l. spray	10–30 min
	0.4 mg per spray		
	ANGISPAN-TR 2.5, 6.5 mg SR cap.	5–15 mg oral	4–8 hr
	NITROCONTIN, CORODIL 2.6, 6.4 mg tabs.		
	NITRODERM-TTS 5 or 10 mg patch	One patch for 14–16 hr per day	Till applied, max 24 hr.
	MYOVIN, MILLISROL, NITROJECT 5 mg/ml inj	5–20 µg/min i.v.	Till infused
2. Isosorbide dinitrate	SORBITRATE 5, 10 mg tab,	5–10 mg sublingual	20–40 min
	ISORDIL 5 mg sublingual & 10 mg oral tab.	10–20 mg oral	2–3 hr
	DITRATE 5, 10 mg tab; 20, 40 mg SR tab	20–40 mg oral	6–10 hr
3. Isosorbide-5-mononitrate	MONOTRATE 10, 20, 40 mg tab, 25, 50 mg SR tabs	20–40 mg oral	6–10 hr
	5-MONO, MONOSORBITRATE 10, 20, 40 mg tab.		
4. Erythryl-tetranitrate	CARDILATE 5, 15 mg tab	15–60 mg oral	4–6 hr
5. Pentaerythritol-tetranitrate	PERITRATE 10 mg tab	10–40 mg oral	3–5 hr
	PERITRATE-SA 80 mg SR tab	80 mg oral	8–12 hr

4. Erythryl tetranitrate and pentaerythritol tetranitrate

These are longer-acting nitrates used only for chronic prophylaxis. Sustained release oral preparations are now available for 2–3 times a day dosing. There has been considerable scepticism in the past about the efficacy of orally administered long-acting nitrates. Studies with high doses have shown that firstpass metabolism in liver can be saturated and haemodynamic effects lasting 4–6 hours do occur.

USES

1. Angina pectoris Nitrates are effective in classical as well as variant angina. For aborting or terminating an attack, sublingual GTN tablet or spray, or isosorbide dinitrate is taken on 'as and when required' basis. GTN produces relief within 3 min in 75% patients, the rest may require another dose or take longer (upto 9 min). Nitrates increase exercise tolerance and postpone ECG changes of ischaemia. Longer-acting formulations (oral, transdermal) of GTN or other nitrates are

used on regular schedule for chronic prophylaxis. However, development of tolerance and dependence may limit the usefulness of this approach: 6–8 drug free hours daily are advisable.

2. Acute coronary syndromes These are characterized by rapid worsening of anginal status of the patient: include unstable angina (UA) and non-ST segment elevation myocardial infarction (NSTEMI). It needs aggressive therapy with a combination of drugs intended to prevent further coronary occlusion, increase coronary blood flow and decrease myocardial stress (oxygen demand). Nitrates are useful by decreasing preload (myocardial work) as well as by increasing coronary flow (dilatation and antagonism of coronary spasm, if present). Initially GTN is given sublingually, but if pain persists after 3 tablets 5 min apart, i.v. infusion of GTN is started. The role of nitrates appears to be limited to relief of pain, because no mortality benefit has been demonstrated in large randomized clinical trials such as GISSI-3 (1994) and ISIS-4 (1995).

Antiplatelet drugs like aspirin, clopidogrel, GPII_b/III_a antagonists, with or without heparin are the primary measures in UA/NSTEMI. The β blockers are indicated in all patients (if there are no contraindications) to reduce myocardial oxygen demand. A CCB is indicated only when coronary spasm is not effectively counteracted by the nitrate. Revascularization by thrombolitics/coronary angioplasty with stents/coronary bypass surgery is considered in high risk patients.

3. Myocardial infarction (MI) Administered by carefully titrated i.v. infusion to avoid hypotension and tachycardia, GTN is frequently used during evolving MI with the aim of relieving chest pain, pulmonary congestion and limiting the area of necrosis by favourably altering O₂ balance in the marginal partially ischaemic zone (a consequence of preload reduction). However, the evidence that it decreases mortality is not robust; prognostic benefits appear marginal. Proper patient selection is important. GTN should not be administered if:

- Systolic BP is < 90 mm Hg
- Heart rate is < 50 or > 100 beats/min
- Right ventricular infarction is suspected
- Hypotension caused by nitrate limits the administration of β blockers which have more powerful salutary effects.*
- Patient has taken sildenafil in the past 24 hours.

4. CHF and acute LVF The role of vasodilators in CHF is described in Ch. 37. Nitrates afford relief by venous pooling of blood (which can be aided by sitting posture while managing acute LVF or severe chronic CHF) → reduced venous return (preload) → decreased end diastolic volume → improvement in left ventricular function by *Laplace law* and regression of pulmonary congestion. Intravenous GTN is the preparation of choice for emergency use: rate of infusion must be guided by continuous haemodynamic monitoring.

5. Biliary colic due to disease or morphine—responds to sublingual GTN or isosorbide dinitrate.

* American Heart Association/American College of Cardiology guidelines for the management of patients with acute myocardial infarction. *Circulation* 2004, 110, 588-636.

6. Esophageal spasm Sublingual GTN promptly relieves pain. Nitrates taken before a meal facilitate feeding in esophageal achalasia by reducing esophageal tone.

7. Cyanide poisoning Nitrates generate methaemoglobin which has high affinity for cyanide radical and forms cyanomethaemoglobin. However, this may again dissociate to release cyanide. Therefore, sodium thiosulfate is given to form Sod. thiocyanate which is poorly dissociable and is excreted in urine.

Cytochrome and other oxidative enzymes are thus protected from cyanide; even that which has complexed CN is reactivated. However, early treatment is critical. The antidotes should be repeated as required.

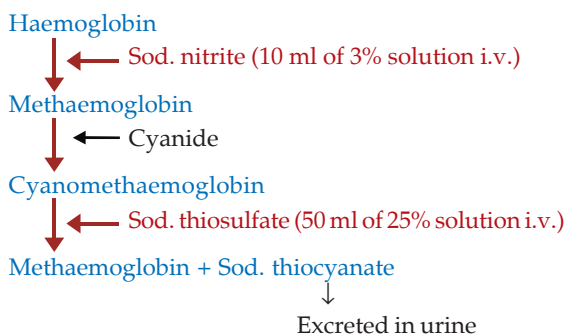

Sodium nitrite is used for this purpose because it is a very weak vasodilator; large doses (>300 mg) sufficient to generate enough methaemoglobin can be injected i.v. without producing hypotension.

β BLOCKERS (see Ch. 10)

These drugs do not dilate coronaries or other blood vessels; total coronary flow is rather reduced due to blockade of dilator β_2 receptors. However, flow to the ischaemic subendocardial area is not reduced because of favourable redistribution and decrease in ventricular wall tension. They act by reducing cardiac work and O₂ consumption (decreased heart rate, inotropic state and mean BP). This is marginal at rest. More importantly, β blockers limit increase in these modalities that occurs during exercise or anxiety (due to antiadrenergic action on heart).

All β blockers are nearly equally effective in decreasing frequency and severity of attacks and in increasing exercise tolerance in classical angina, but cardioselective agents (atenolol, metoprolol) are preferred over nonselective $\beta_1 + \beta_2$ blockers (e.g. propranolol), which may worsen variant angina due to unopposed α receptor mediated coronary constriction that may accentuate the coronary spasm. Long term β blocker therapy lowers risk of sudden cardiac death among ischaemic heart disease patients.

In angina pectoris, β -blockers are to be taken on a regular schedule; not on 'as and when required' basis. The dose has to be individualized. Abrupt discontinuation after chronic use may precipitate severe attacks, even MI.

Unstable angina (UA)/Non-ST-elevation MI (NSTEMI): Unless contraindicated, β blockers are routinely used in UA/NSTEMI. However, they should be given only after starting nitrate \pm calcium channel blocker to counteract coronary vasospasm, if present (β blockers carry the risk of worsening coronary vasospasm). β blockers reduce myocardial O_2 demand and afford additional benefit by reducing risk of impending MI/sudden cardiac death.

CALCIUM CHANNEL BLOCKERS

Verapamil was developed in Germany in 1962 as a coronary dilator. It had additional cardiodepressant property, but its mechanism of action was not known. Fleckenstein (1967) showed that it interfered with Ca^{2+} movement into the cell. In the subsequent years, a large number of chemically diverse Ca^{2+} channel blockers (CCBs) with different pharmacological profiles have been produced.

Three important classes of calcium channel blockers are exemplified by:

Verapamil—a *phenyl alkylamine*, hydrophilic papaverine congener.

Nifedipine—a *dihydropyridine* (lipophilic).

Diltiazem—a hydrophilic *benzothiazepine*.

The dihydropyridines (DHPs) are the most potent Ca^{2+} channel blockers, and this subclass has proliferated exceptionally.

Calcium channels

Three types of Ca^{2+} channels have been described in smooth muscles (other excitable cells as well):

(a) *Voltage sensitive channel* Activated when membrane potential drops to around -40 mV or lower.

(b) *Receptor operated channel* Activated by Adr and other agonists—*independent of membrane depolarization* (NA contracts even depolarized aortic smooth muscle by promoting influx of Ca^{2+} through this channel and releasing Ca^{2+} from sarcoplasmic reticulum).

(c) *Leak channel* Small amounts of Ca^{2+} leak into the resting cell and are pumped out by Ca^{2+} ATPase.

Voltage sensitive calcium channels

	L-type (Long lasting current)	T-type (Transient current)	N-type (Neuronal)
1. Conductance	25 pS	8 pS	12–20 pS
2. Activation threshold	High	Low	High
3. Inactivation rate	Slow	Fast	Medium
4. Location and function	<ul style="list-style-type: none"> Excitation-contraction coupling in cardiac and smooth muscle SA, A-V node—conductivity Endocrine cells—hormone release Neurones—transmitter release 	<ul style="list-style-type: none"> SA node—pace-maker activity 'T' current and repetitive spikes in thalamic and other neurones Endocrine cells—hormone release Certain arteries—constriction 	<ul style="list-style-type: none"> Only on neurones in CNS, sympathetic and myenteric plexuses—transmitter release
5. Blocker	Nifedipine, diltiazem, verapamil	Mibefradil, flunarizine, ethosuximide	ω -Conotoxin

Mechanical stretch promotes inward movement of Ca^{2+} , which may be occurring through activation of the leak channel or through separate *stretch sensitive channel*.

The *voltage sensitive Ca^{2+} channels* are heterogeneous: three major types have been identified (see box on p. 528):

All voltage sensitive Ca^{2+} channels are membrane spanning funnel shaped glycoproteins that function as ion selective valves. They are composed of a major α_1 subunit which encloses the ion channel and other modulatory subunits like α_2, β, γ and δ . In L-type Ca^{2+} channels each subunit exists in multiple isoforms which may be site specific, e.g.

Skeletal muscle L-channels are: $\alpha_{1s} \cdot \alpha_2/\delta_a \cdot \beta_1 \cdot \gamma$

Cardiac muscle L-channels are: $\alpha_{1ca} \cdot \alpha_2/\delta_c \cdot \beta_2$

Smooth muscle L-channels are: $\alpha_{1cb} \cdot \alpha_2/\delta \cdot \beta_3$

Even smooth muscle L-channels differ between vascular and nonvascular. Moreover, distribution may be heterogeneous in different parts of the vascular bed.

Only the voltage sensitive L-type channels are blocked by the CCBs. The 3 groups of CCBs *viz.* phenylalkylamines (verapamil), benzothiazepine (diltiazem) and dihydropyridines (nifedipine) bind to their own specific binding sites on the α_1 subunit; all restricting Ca^{2+} entry, though characteristics of channel blockade differ. Further, different drugs may have differing affinities for various site specific isoforms of the L-channels. This may account for the differences in action exhibited by various CCBs. The vascular smooth muscle has a more depolarized membrane (RMP about -40 mV) than heart. This may contribute to vascular selectivity of certain CCBs.

PHARMACOLOGICAL ACTIONS AND ADVERSE EFFECTS

The common property of all three subclasses of CCBs is to inhibit Ca^{2+} mediated slow channel

component of action potential (AP) in smooth/cardiac muscle cell. The two most important actions of CCBs are:

- (i) Smooth muscle (especially vascular) relaxation.
- (ii) Negative chronotropic, inotropic and dromotropic action on heart.

Smooth muscle Smooth muscles depolarise primarily by inward Ca^{2+} movement through voltage sensitive channel. These Ca^{2+} ions trigger release of more Ca^{2+} from intracellular stores and together bring about excitation-contraction coupling through phosphorylation of myosin light chain as depicted in Fig. 39.3. CCBs cause relaxation by decreasing intracellular availability of Ca^{2+} . They markedly relax arterioles but have mild effect on veins. Extravascular smooth muscle (bronchial, biliary, intestinal, vesical, uterine) is also relaxed.

The dihydropyridines (DHPs) have the most marked smooth muscle relaxant and vasodilator action; verapamil is somewhat weaker followed by diltiazem.

Nitrendipine and other DHPs have been shown to release NO from endothelium and inhibit cAMP-phosphodiesterase resulting in raised smooth muscle cAMP. These additional mechanisms may account for their predominant smooth muscle relaxant action. Released endothelial NO may exert antiatherosclerotic action.

Table 39.2: Comparative properties of representative calcium channel blockers

	<i>Verapamil</i>	<i>Nifedipine</i>	<i>Diltiazem</i>
1. Channel blocking potency	++	+++	+
2. Frequency dependence of channel blockade	++	-	+
3. Channel recovery rate	Much delayed	No effect	Delayed
4. Cardiac effects (<i>In vivo</i> at usual clinical doses)			
Heart rate	↓	↑	↓, -
A-V conduction velocity	↓↓	-	↓
Contractility	-, ↓	↑	↓, ↑
Output	-, ↓	↑	-, ↑
5. Vascular smooth muscle relaxation	++	+++	+
6. Clinical use in	Angina Arrhythmia (Hypertension)	Angina Hypertension	Angina Hypertension (Arrhythmia)

Heart In the working atrial and ventricular fibres, Ca^{2+} moves in during plateau phase of AP → releases more Ca^{2+} from sarcoplasmic reticulum → contraction through binding to troponin—allowing interaction of myosin with actin. The CCBs would thus have negative inotropic action.

The 0 phase depolarization in SA and A-V nodes is largely Ca^{2+} mediated. Automaticity and conductivity of these cells appear to be dependent on the rate of recovery of the Ca^{2+} channel.

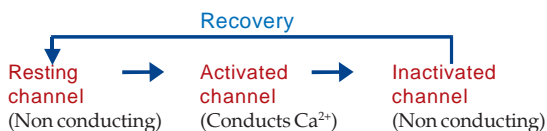

The L-type Ca^{2+} channels activate as well as inactivate at a slow rate. Consequently, Ca^{2+} depolarized cells (SA and A-V nodal) have a considerably less steep 0 phase and longer refractory period. The recovery process which restores the channel to the state from which it can again be activated by membrane depolarization is delayed by verapamil and to a lesser extent by diltiazem (resulting in depression of pacemaker activity and conduction), but not by DHPs (they have no negative chronotropic/dromotropic action). Moreover, channel blockade by verapamil is enhanced at higher rates of stimulation, that by nifedipine is independent of frequency, while diltiazem is intermediate. Thus, verapamil slows sinus rate and A-V conduction, but nifedipine does not. Effect of diltiazem on sinus node automaticity and A-V conduction is similar to that of verapamil.

The relative potencies to block slow channels in smooth muscle do not parallel those in the heart. The DHPs are more selective for smooth muscle L channels: at concentrations which cause vasodilatation they have negligible negative inotropic action. Diltiazem causes less depression of contractility than verapamil. Important differences between the three representative CCBs are summarized in Table 39.2. Their cardiac electrophysiological effects are compared in Table 38.1.

Verapamil It dilates arterioles and has some α adrenergic blocking activity—decreases t.p.r. but BP is only modestly lowered. The pronounced direct cardiodepressant effect is partially offset *in vivo* by reflex effects of peripheral vasodilatation. The HR generally decreases, A-V conduction is slowed, but c.o. is maintained by reflex sympathetic stimulation and reduction in aortic impedance. However, ventricular contractility may be markedly impaired in CHF patients. Coronary flow is increased.

Dose: 40–160 mg TDS oral, 5 mg by slow i.v. injection.
CALAPTIN 40, 80 mg tabs, 120, 240 mg SR tabs, 5 mg/2 ml inj.

Adverse effects Nausea, constipation and bradycardia are more common than other CCBs, while flushing, headache and ankle edema are less common. Hypotension is occasional and tachycardia (common with DHPs) is absent. It can accentuate conduction defects (contraindicated in 2nd and 3rd degree A-V block) and precipitate CHF in patients with preexisting disease. Cardiac arrest has occurred on i.v. injection and when it is given to patients with sick sinus.

Interactions Verapamil should not be given with β blockers—additive sinus depression, conduction defects or asystole may occur. It increases plasma digoxin level by decreasing its excretion: toxicity can develop. It should not be used with other cardiac depressants like quinidine and disopyramide.

Diltiazem It is a less potent vasodilator than nifedipine and verapamil, and has modest direct negative inotropic action, but direct depression of SA node and A-V conduction are equivalent to verapamil. Usual clinical doses produce consistent fall in BP with little change or decrease in HR. Large dose or i.v. injection decreases t.p.r. markedly which may elicit reflex cardiac effects. It dilates coronaries.

Dose: 30–60 mg TDS-QID oral; DILZEM, 30, 60 mg tabs, 90 mg SR tab; 25 mg/5 ml inj; ANGIZEM 30, 60, 90, 120, 180 mg tab, DILTIME 30, 60 mg tab; 90, 120 mg SR tab.

Adverse effects Incidence of side effects is low, but the profile is similar to verapamil. Like verapamil, it also increases plasma digoxin.

Diltiazem should not be given to patients with preexisting sinus, A-V nodal or myocardial disease. Only low doses should be given to patients on β blockers.

Nifedipine It is the prototype DHP with a rapid onset and short duration of action. The overriding action of nifedipine is arteriolar dilatation \rightarrow t.p.r. decreases, BP falls. The direct depressant effect on heart requires much higher dose, but a weak negative inotropic action can be unmasked after β blockade. As discussed above, it does not depress SA node or A-V conduction. Reflex sympathetic stimulation of heart predominates \rightarrow tachycardia, increased contractility and c.o. (no decrease in venous return along with lowering of afterload aid increase in c.o.). Coronary flow is increased.

Nifedipine has mild natriuretic action, but significant diuresis does not occur.

Dose: 5–20 mg BD–TDS oral.

CALCIGARD, DEPIN, NIFELAT 5, 10 mg tab, also 10 mg, 20 mg S.R. (RETARD) tab; NICARDIA 5, 10 mg tab; 10, 20, 30 mg SR tab.

Adverse effects Frequent side effects are palpitation, flushing, ankle edema, hypotension, headache, drowsiness and nausea. These are related to peaks of drug level in blood: can be minimized by low starting dose, fractionation of dose or use of retard formulation. Nifedipine has paradoxically increased the frequency of angina in some patients. Higher mortality among post MI patients has been confirmed. However, it has been safely administered with β blockers and digoxin.

By its relaxant effect on bladder nifedipine can increase urine voiding difficulty in elderly males. It has also been reported to hamper diabetes control by decreasing insulin release.

Other dihydropyridines (DHPs)

All DHPs have pharmacodynamic profile similar to nifedipine; there are minor differences in organ selectivity and major differences in pharmaco-

kinetic characteristics. The slower and longer acting ones induce less reflex sympathetic stimulation. Tachycardia, propensity to increase cardiac work, flushing, headache, dizziness are subdued. They are currently favoured, particularly since increased mortality among post-MI patients has been reported with the regular short-acting nifedipine formulation.

Felodipine It differs from nifedipine in having greater vascular selectivity, larger tissue distribution and longer $t_{1/2}$. The extended release preparation is suitable for once daily administration.

Dose: 5–10 mg OD, max. 10 mg BD.

FELOGARD, PLENDIL, RENDIL 2.5, 5, 10 mg ER tab.

Amlodipine Pharmacokinetically it is the most distinct DHP. It has complete but slow oral absorption: peak after 6 to 9 hr—the early vasodilator side effects (palpitation, flushing, headache, postural dizziness) are largely avoided. Because of less extensive and less variable first pass metabolism, its oral bioavailability is higher and more consistent. Volume of distribution and $t_{1/2}$ are exceptionally long: diurnal fluctuation in blood level is small and action extends over the next morning.

Dose: 5–10 mg OD; AMLOPRES, AMCARD, AMLOPIN, MYODURA 2.5, 5, 10 mg tabs.

S(–)Amlodipine The single enantiomer preparation is effective at half the dose and is claimed to cause less ankle edema.

Dose: 2.5–5 mg OD;

S-NUMLO, S-AMCARD, ASOMEX, ESAM 2.5, 5 mg tabs.

Nitrendipine A DHP with oral bioavailability of 10–30% and elimination $t_{1/2}$ of 4–12 hours. It has been shown to release NO from the endothelium and inhibit cAMP phosphodiesterase; which may be the additional mechanisms of vasodilator action. The endothelial NO is claimed to retard atherosclerosis. Ventricular contractility and A-V conduction are not depressed. Nitrendipine is indicated in hypertension and angina pectoris.

Dose: 5–20 mg OD; NITREPIN, CARDIF 10, 20 mg tabs.

Lacidipine A highly vasoselective newer DHP suitable for once daily administration. It is claimed to attain higher concentration in vascular

Table 39.3: Pharmacokinetic characteristics of calcium channel blockers

Drug	Bioavailability	Vd (L/Kg)	CL (L/hr/Kg)	Active metabolite	Elimin. t _{1/2} (hr)
1. Verapamil	15–30%	5.0	0.9	Yes	4–6
2. Diltiazem	40–60%	3.0	0.7	Yes	5–6
3. Nifedipine	30–60%	0.8	0.42	Minor	2–5
4. Felodipine	15–25%	10.0	1.0	None	12–18
5. Amlodipine	60–65%	21.0	0.42	None	35–45

smooth muscle membrane; approved only for use as antihypertensive.

Dose: 4 mg OD, increase to 6 mg OD if required.

LACIVAS, SINOPILO 2, 4 mg tabs.

Nimodipine It is a short-acting DHP which penetrates blood-brain barrier very efficiently due to high lipid solubility. It selectively relaxes cerebral vasculature; approved for prevention and treatment of neurological deficit due to cerebral vasospasm following subarachnoid haemorrhage or ruptured congenital intracranial aneurysms. Side effects are headache, flushing, dizziness, palpitation and nausea.

Dose: 30–60 mg 4–6 hourly for 3 weeks following subarachnoid haemorrhage; VASOTOP, NIMODIP, NIMOTIDE 30 mg tab; 10 mg/50 ml inj.

Lercanidipine Another DHP similar to nifedipine, but with longer duration of action. Peak plasma concentrations occur at 1.5–3 hrs; t_{1/2} is 5–10 hours. It is indicated in hypertension at a dose of 10–20 mg OD.

LEREZ, LERKA 10, 20 mg tabs.

Benidipine A long-acting DHP that owes its long duration of action to slow dissociation from the DHP receptor on the smooth muscle cell. It is indicated in hypertension and angina pectoris. It is marketed only in India and Japan.

Dose: 4–8 mg OD; CARITEC 4, 8 mg tab.

PHARMACOKINETICS

The pharmacokinetic parameters of Ca²⁺ channel blockers are tabulated in Table 39.3. All are 90–100% absorbed orally, peak occurring at 1–3 hr (except amlodipine 6–9 hr). The oral bioavailability of Ca²⁺ channel blockers is incomplete with marked inter- and intra-

individual variations. This is due to high first pass metabolism (modest and less variable for amlodipine). All are highly plasma protein bound (min.: diltiazem 80%, max.: felodipine 99%).

The Ca²⁺ channel blockers are high clearance drugs with extensive tissue distribution. All are > 90% metabolized in liver and excreted in urine. Some metabolites are active. The elimination t_{1/2} are in the range of 2–6 hr, but that of amlodipine is exceptionally long; followed by lacidipine, nitrendipine and felodipine.

On chronic use verapamil decreases its own metabolism—bioavailability is nearly doubled and t_{1/2} is prolonged.

USES

Calcium channel blockers can be safely given to patients with obstructive lung disease and peripheral vascular disease in whom β blockers are contraindicated. The problem of rebound worsening of angina on withdrawal after chronic use is less with CCBs than with β blockers.

1. Angina pectoris All CCBs are effective in reducing frequency and severity of *classical as well as variant angina*. Benefit in classical angina appears to be primarily due to reduction in cardiac work: mainly as a result of reduced afterload. Though, they can increase coronary flow in normal individuals, this is unlikely to be significant in patients with fixed arterial obstruction. Exercise tolerance is increased.

Many controlled studies and metaanalysis have concluded that myocardial ischaemia may be aggravated by short-acting DHPs. This may be due to decreased coronary flow secondary to fall

in mean arterial pressure, reflex tachycardia and coronary steal. The direct cardiac effect of verapamil and diltiazem to reduce O₂ requirement and less marked sympathetic stimulation makes them less likely to aggravate ischaemia.

Trials using high dose regular short-acting nifedipine formulation have reported increased mortality among MI patients. The sudden rush of sympathetic activity evoked by each dose of these preparations has been held responsible for the deleterious effect. The slow and long-acting DHPs do not share this disadvantage. There is some evidence that verapamil and diltiazem reduce reinfarction and mortality in MI patients (equal to that achieved by β blockers) with uncompromised ventricular function.

Myocardial infarction: The consensus opinion is against use of CCBs in MI, but verapamil/diltiazem may be employed for secondary prophylaxis when β blockers are contraindicated.

The capacity of CCBs to prevent arterial spasm is undoubtedly responsible for the beneficial effect in *variant angina*. Reduction of cardiac O₂ demand would also work in the same direction. No significant difference in efficacy among different CCBs has been noted in angina pectoris.

CCBs are not a first line treatment of *unstable angina*; may be used as add on therapy to nitrates when coronary vasospasm is prominent and is not counteracted by nitrate alone. Use of nifedipine/DHPs in non β blocked patients is to be avoided.

2. Hypertension DHPs, diltiazem and verapamil are among the first line drugs for hypertension (see Ch. 40).

3. Cardiac arrhythmias Verapamil and diltiazem are highly effective in PSVT and for control of ventricular rate in supraventricular arrhythmias (see Ch. 38).

4. Hypertrophic cardiomyopathy The negative inotropic action of verapamil can be salutary in this condition.

5. Other uses Nifedipine is an alternative drug for premature labour (see p. 323); Verapamil has

been used to suppress migraine and nocturnal leg cramps. The DHPs reduce severity of Raynaud's episodes.

RATIONAL DRUG COMBINATIONS

Along with any of the drugs used for chronic prophylaxis of angina, sublingual short-acting nitrate is allowed on 'as and when' required basis to abort and terminate anginal attacks when they occur.

Of the three major classes of antianginal drugs described above, generally one agent is used initially; choice depends on the stage of disease, associated cardiac/other medical conditions and individual acceptability of side effects, because long-term prognostic benefit and tolerability of long-acting nitrates (including transdermal GTN), β blockers and long-acting CCBs is similar. However, some direct comparative studies have found β blockers to achieve greater reduction in the number of anginal attacks than CCBs, but objective measurements and outcome were not different. When monotherapy is unable to provide adequate relief in tolerated doses, concurrent use of 2 or 3 drugs may be tried.

I. β blocker + long-acting nitrate combination is rational in classical angina because:

- Tachycardia due to nitrate is blocked by β blocker.
- The tendency of β blocker to cause ventricular dilatation is counteracted by nitrate.
- The tendency of β blocker to reduce total coronary flow is opposed by nitrate.

II. The above advantages may also be obtained by combining a slow acting DHP (in place of nitrate) with β blocker. However, verapamil or diltiazem should not be used with β blocker since their depressant effects on SA and A-V node may add up.

III. Nitrates primarily decrease preload, while CCBs have a greater effect on afterload. Their concurrent use may decrease cardiac work to an extent not possible with either drug alone. This combination may be especially valuable in severe vasospastic angina.

IV. In the most severe and resistant cases of classical angina, combined use of all the three classes is indicated. Since their primary mechanism of benefit is different, supraadditive results may be obtained.

- Nitrates primarily decrease preload.
- CCBs mainly reduce afterload + increase coronary flow.
- β blockers decrease cardiac work primarily by direct action on heart.

Verapamil/diltiazem should be avoided in such combinations.

In randomized comparative studies, combinations have been found superior to monotherapy only in more severe cases, but not in mild angina. Recent evidence suggests a greater role of vasospasm of arteriosclerotic segments of coronary arteries in precipitating attacks of angina. As such, coronary dilator action of DHPs/nitrates may be more relevant.

POTASSIUM CHANNEL OPENERS

Minoxidil and diazoxide are K^+ channel openers which were used earlier in severe hypertension and hypertensive emergencies. Novel K^+ channel openers like *nicorandil*, *pinacidil*, *cromakalim* and others have been developed in the 1990s.

Since intracellular concentration of K^+ is much higher (150 mM) compared to extracellular (4–5 mM), K^+ channel opening results in outflow of K^+ ions and hyperpolarization. There are multiple types of K^+ channels, e.g. voltage dependent, Ca^{2+} activated, receptor operated, ATP sensitive, Na^+ activated and cell volume sensitive which serve diverse functions and exhibit different sensitivities to drugs. As such, K^+ channel openers exhibit considerable diversity in action.

The most prominent action of K^+ channel openers is smooth muscle relaxation—vascular as well as visceral: their potential clinical applications (*see box*) are primarily based on this property. Diazoxide and some other K^+ channel openers reduce insulin secretion, while sulfonylureas (glibenclamide) cause hypoglycaemia by blocking K^+ channels in pancreatic β cells and promoting insulin release.

Potential clinical applications of K^+ channel openers

- Angina pectoris
- Hypertension
- Congestive heart failure
- Myocardial salvage in MI
- Antihypoglycaemic (Insulinoma)
- Alopecia
- Bronchial asthma
- Urinary urge incontinence
- Peripheral vascular disease (Raynaud's, cerebrovascular)
- Erectile dysfunction
- Premature labour

Nicorandil This novel antianginal drug activates ATP sensitive K^+ channels—hyperpolarizing vascular smooth muscle. The vasodilator action is partly antagonized by K^+ channel blocker glibenclamide. Like nitrates it also acts as a NO donor—relaxes blood vessels by increasing cGMP. Thus, arterial dilatation is coupled with venodilatation. Coronary flow is increased; dilatation of both epicardial conducting vessels and deeper resistance vessels has been demonstrated. No significant cardiac effects on contractility and conduction have been noted.

Beneficial effects on angina frequency and exercise tolerance comparable to nitrates, β blockers and CCBs have been obtained in stable as well as vasospastic angina. Mitochondrial K^+_{ATP} channel opening by nicorandil is believed to exert myocardial protection by a process of *ischaemic preconditioning* which appears to reduce *myocardial stunning*, arrhythmias and infarct size when a coronary artery is suddenly blocked. Myocardial recovery from ischaemic damage after MI as measured by left ventricular wall motion is improved by nicorandil.

The cardioprotective property of nicorandil, has been supported by the large 'Impact of nicorandil in angina' (IONA, 2002) randomized trial which found nicorandil to reduce acute coronary events in high risk stable angina patients.

Side effects are flushing, palpitation, weakness, headache, dizziness, nausea and vomiting. Large

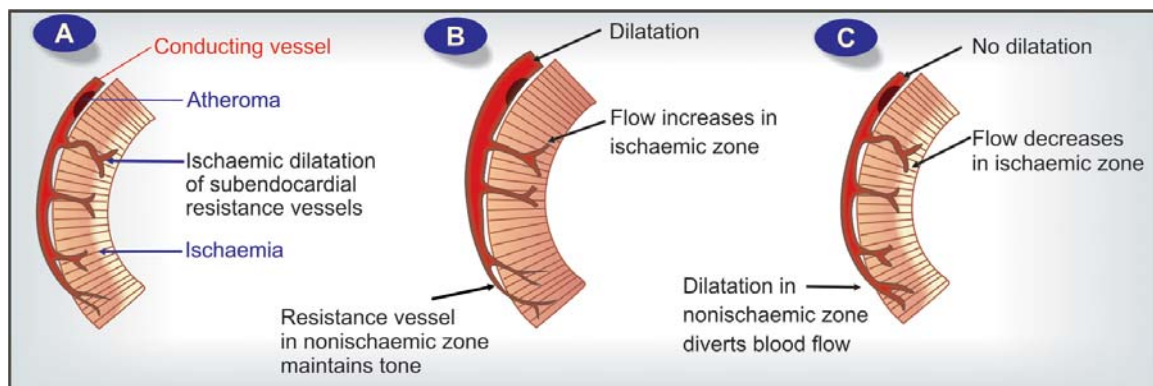

Fig. 39.4: Diagrammatic representation of coronary haemodynamics. A—in classical angina, B— Selective nitrate action on conducting vessels which along with ischaemic dilatation of resistance vessels increases flow to the subendocardial region → relief of angina. C—Dipyridamole action on all resistance vessels increases blood flow to nonischaemic zone to the detriment of ischaemic zone → coronary steal

painful aphthous ulcers in the mouth, which heal on stopping nicorandil have been reported.

Dose: 5–20 mg BD; **NIKORAN**, 5, 10 mg tabs, 2 mg/vial, 48 mg/vial inj; **KORANDIL** 5, 10 mg tabs.

OTHER ANTIANGINAL DRUGS

1. Dipyridamole It is a powerful coronary dilator; increases total coronary flow by preventing uptake and degradation of adenosine which is a local mediator involved in autoregulation of coronary flow in response to ischaemia. It dilates resistance vessels and abolishes autoregulation, but has no effect on larger conducting coronary vessels. Cardiac work is not decreased because venous return is not reduced. BP is minimally altered. It does not afford symptomatic benefit or avert ECG changes of angina.

The pharmacological success but therapeutic failure of dipyridamole has been explained on the basis of 'coronary steal' phenomenon (Fig. 39.4). By dilating resistance vessels in nonischaemic zone as well, it diverts the already reduced blood flow away from the ischaemic zone.

Dipyridamole inhibits platelet aggregation. By potentiating PGI₂ and increasing cAMP in platelets, it enhances antiaggregatory influences. Though not useful as an antianginal drug, it is being employed for prophylaxis of coronary and cerebral thrombosis in post-MI and post-stroke patients, as well as to prevent thrombosis in patients with prosthetic heart valves (see Ch. 44).

Dose: 25–100 mg TDS; **PERSANTIN**, **CARDIWELL** 25, 75, 100 mg tab.

2. Trimetazidine This novel antianginal drug acts by nonhaemodynamic mechanisms. There is no effect on determinants of myocardial O₂

consumption, such as HR and BP, both at rest as well as during exercise, but angina frequency is reduced and exercise capacity is increased. In patients not adequately controlled by long-acting nitrate/β blocker/CCB, addition of trimetazidine further reduced anginal attacks and increased exercise duration. The mechanism of action of trimetazidine is not known, but it may improve cellular tolerance to ischaemia by:

- Inhibiting mitochondrial long chain 3-ketoacyl-CoA-thiolase (LC3-KAT) a key enzyme in fatty acid oxidation—thereby reducing fatty acid metabolism and increasing glucose metabolism in myocardium. Ischaemic myocardium shifts to utilizing fatty acid as substrate, increasing requirement of O₂ for the same amount of ATP generated. Since oxidation of fatty acid requires more O₂, shift back of substrate to glucose would reduce O₂ demand. It has been labelled as pFOX (fatty acid oxidation pathway) inhibitor.
- Limiting intracellular acidosis and Na⁺, Ca²⁺ accumulation during ischaemia.
- Protecting against O[•] free radical induced membrane damage.

Trimetazidine is absorbed orally, partly metabolized and largely excreted unchanged in urine; t_{1/2} is 6 hr. It is generally well tolerated; side effects are—gastric burning, dizziness, fatigue and muscle cramps. Reversible parkinsonism has been reported in the elderly.

Trimetazidine has also been advocated for visual disturbances, tinnitus, Ménière's disease,

dizziness, etc., but conclusive evidence of efficacy in these conditions is lacking. For ischaemic heart disease, it has been widely used in France, Spain, some other European countries and India, but not in the UK or USA. It is mostly an add on medication to conventional therapy in angina and post-MI patients.

Dose: 20 mg TDS.

FLAVEDON 20 mg tabs, 35 mg modified release tab; CARVIDON, TRIVEDON 20 mg tab.

3. Ranolazine This recently developed trimetazidine congener LC3-KAT inhibitor is a metabolic modifier approved by US-FDA in 2006 for treatment of chronic angina pectoris in patients who fail to respond to standard antianginal therapy. Ranolazine spares fatty acid oxidation and shifts ATP production to more O₂ efficient carbohydrate oxidation. It also inhibits late I_{Na} current in the myocardium which indirectly facilitates Ca²⁺ entry. Reduction in Ca²⁺ overload in the myocardium during ischaemia may play an important role in the cardioprotective action of ranolazine.

The efficacy of ranolazine in decreasing frequency of anginal attacks and in prolonging exercise duration has been demonstrated both as monotherapy as well as when added to conventional drugs (atenolol, amlodipine, diltiazem) in multicentric randomized trials: MARISA (monotherapy assessment of ranolazine in stable angina, 2004), CARISA (Combination assessment of ranolazine in stable angina, 2004), ERICA (Efficacy of ranolazine in chronic angina, 2005). Efficacy in acute coronary syndromes is being assessed in a large (>6000 patients) study MERLIN-TIMI 36 (Metabolic efficiency with ranolazine for less ischaemia in non ST elevation acute coronary syndromes).

Oral absorption of ranolazine is slow taking 4–6 hours with a bioavailability of 30–50%. It is metabolized in liver and excreted by the kidney with an average t_{1/2} of 7 hours. Side effects reported are dizziness, weakness, constipation, postural hypotension, headache and dyspepsia. Prolongation of QT_c interval has been noted; *torsades de pointes* is a risk, but not yet encountered.

Dose: 0.5–1.0 g BD; (marketed in USA as ER tablet RANEXA)

Ranolazine is at present recommended in angina pectoris only in combination with conventional therapy.

4. Oxyphedrine This drug is claimed to improve myocardial metabolism so that heart can sustain hypoxia better. Though used in angina and MI, its efficacy and status in coronary artery disease is not defined. It can diminish or alter taste sensation.

Dose: 8–24 mg TDS oral, 4–8 mg i.v. OD-BD; ILDAMEN 8, 24 mg tab., 4 mg/2 ml inj.

DRUGS FOR PERIPHERAL VASCULAR DISEASES

Many vasodilators have been used in peripheral vascular diseases (PVDs) like Buerger's, Raynaud's, diabetic vascular insufficiency, gangrene, ischaemic leg ulcers, frost bite and cerebrovascular inadequacy.

1. Cyclandelate It is a papaverine like general smooth muscle relaxant which increases cutaneous, skeletal muscle and cranial blood flow in normal individuals. However, efficacy in PVDs is not different from placebo. Side effects are flushing, palpitation and headache.

Dose: 200–400 mg TDS; CYCLOSPASMOL, CYCLASYN 200, 400 mg tab/cap.

2. Xanthinol nicotinate (Nicotinyln xanthinate) It is a compound of xanthine and nicotinic acid, both of which are vasodilators. It increases blood flow in many vascular beds and has been promoted for cerebrovascular disorders and PVDs, but therapeutic benefits are insignificant.

Dose: 300–600 mg TDS oral; 300 mg by i.m. or slow i.v. injection; COMPLAMINA 150 mg tab, 500 mg retard tab, 300 mg/2 ml inj.

3. Pentoxifylline (Oxpentifylline) An analogue of theophylline and a phosphodiesterase inhibitor, it has been shown to increase blood flow in ischaemic areas by reducing whole blood viscosity and by improving flexibility of RBCs. The *rheological* (dealing with property of flow) action rather than vasodilatation is said to be responsible for improving passage of blood through microcirculation. Thus, there are no chances of the 'steal' phenomenon. Oral doses do not affect heart rate, t.p.r. or BP.

Pentoxifylline is usually well tolerated: side effects are nausea, vomiting, dyspepsia and bloating which can be minimized by taking the drug after meals.

Dose: 400 mg BD-TDS; TRENTAL-400, FLEXITAL 400 mg SR tab, 300 mg/15 ml for slow i.v. injection.

Indications are:

1. Non-haemorrhagic stroke: claimed to hasten recovery.
2. Chronic cerebrovascular insufficiency: to improve symptoms like vertigo, tinnitus, memory defects, low drive.
3. Transient ischaemic attacks (TIAs).

4. Intermittent claudication due to arteriosclerotic, diabetic or inflammatory vascular disease: walking distance is increased.
5. Trophic leg ulcers, gangrene.

It has been shown to improve sperm motility—tried in male factor infertility.

Despite initial encouraging reports, the overall benefits of this drug are modest and restricted to a fraction of patients.

Comment Apart from the above drugs, β adrenergic agonists like isoxsuprine, CCBs like nifedipine and α blockers like prazosin, tolazoline, phenoxybenzamine have been used in PVDs. However, no vasodilator can overcome organic obstruction. Because ischaemia itself is the most potent vasodilator stimulus in skeletal muscle and cerebral beds, vasodilators can even divert the blood to nonischaemic areas (steal phenomenon). They obviously are more useful when vasospasm is wholly or partly involved, e.g. in Raynaud's phenomenon. PGI₂ has been employed in severe cases with rest pain (p. 182). Antioxidants like vit. E, ginkgo biloba and antiplatelet drugs are the other measures, but overall benefits are inconsistent, mostly marginal.

DRUG THERAPY IN MYOCARDIAL INFARCTION

Myocardial infarction (MI) is ischaemic necrosis of a portion of the myocardium due to sudden occlusion of a branch of coronary artery. An acute thrombus at the site of atherosclerotic obstruction is the usual cause. About ¼ patients die before therapy can be instituted. The remaining are best treated in specialized coronary care units with continuous monitoring of the haemodynamic parameters and ECG to guide the selection of drugs and dosage. Those who receive such facility can be greatly benefitted by drug therapy, which according to individual needs is directed to:

1. Pain, anxiety and apprehension Opioid analgesics (morphine/pethidine), diazepam administered parenterally.

2. Oxygenation By O₂ inhalation and assisted respiration, if needed.

3. Maintenance of blood volume, tissue perfusion and microcirculation Slow i.v. infusion of saline/low molecular weight dextran (avoid volume overload).

4. Correction of acidosis Due to lactic acid production—sod. bicarbonate by i.v. infusion.

5. Prevention and treatment of arrhythmias Prophylactic i.v. infusion of a β blocker (unless contraindicated) as soon as the MI patient is seen and its continuation orally for a few days has been shown to reduce the incidence of arrhythmias and mortality. β blockers used early in evolving MI can reduce the infarct size (myocardial salvage) and subsequent complications.

Tachyarrhythmias may be treated with lidocaine, procainamide or other antiarrhythmics. Routine prophylactic lidocaine infusion is not recommended now. Bradycardia and heart block may be managed with atropine or electrical pacing.

6. Pump failure The objective is to increase c.o. and/or decrease filling pressure without unduly increasing cardiac work or reducing BP. Drugs used for this purpose are:

- (a) *Furosemide*: indicated if pulmonary wedge pressure is > 20 mm Hg. It decreases cardiac preload.
- (b) *Vasodilators*: venous or combined dilator is selected according to the monitored haemodynamic parameters. Drugs like GTN (i.v.), or nitroprusside have been mainly used (see Ch. 40).
- (c) *Inotropic agents*: dopamine or dobutamine (rarely digoxin if AF present) may be needed to augment the pumping action of heart and tide over the crisis.

7. Prevention of thrombus extension, embolism, venous thrombosis Aspirin (162–325 mg) should be given for chewing and swallowing as soon as MI is suspected (if not already being taken on a regular basis). This is continued at 80–160 mg/day. Anticoagulants (heparin followed by oral anticoagulants) are used primarily to prevent

deep vein thrombosis (risk due to bed rest) and pulmonary/systemic arterial embolism. Its value in checking coronary artery thrombus extension is uncertain. Any benefit is short-term; anticoagulants are not prescribed on long-term basis now (*see* Ch. 44).

8. Thrombolysis and reperfusion Fibrinolytic agents, i.e. plasminogen activators—streptokinase/urokinase/alteplase to achieve reperfusion of the infarcted area (*see* Ch. 44). Unless thrombolysis can be started within 1–2 hours of MI symptom onset, primary percutaneous coronary intervention (PCI) with stenting is now the preferred revascularization procedure, wherever available.

9. Prevention of remodeling and subsequent CHF ACE inhibitors/ARBs are of proven efficacy and afford long-term survival benefit (*see* Ch. 36).

10. Prevention of future attacks

(a) Platelet inhibitors—aspirin or clopidogrel given on long-term basis are routinely prescribed (*see* Ch. 44).

(b) β blockers—reduce risk of reinfarction, CHF and mortality. All patients not having any contraindication are put on a β blocker for at least 2 years.

(c) Control of hyperlipidaemia—dietary substitution with unsaturated fats, hypolipidemic drugs especially statins (*see* Ch. 45).

CHAPTER 40

Antihypertensive Drugs



These are drugs used to lower BP in hypertension.

Hypertension is a very common disorder, particularly past middle age. It is not a disease in itself, but is an important risk factor for cardiovascular mortality and morbidity. The cutoff manometric reading between normotensives and hypertensives is arbitrary. For practical purposes 'hypertension' could be that level of BP at or above which long-term antihypertensive treatment will reduce cardiovascular mortality. The JNC 7* (2003) and WHO-ISH® guidelines (2003) have defined it to be 140 mm Hg systolic and 90 mm Hg diastolic, though risk appears to increase even above 120/80 mm Hg. Epidemiological studies have confirmed that higher the pressure (systolic or diastolic or both) greater is the risk of cardiovascular disease.

Majority of cases are of essential (primary) hypertension, i.e. the cause is not known. Sympathetic and renin-angiotensin systems may or may not be overactive, but they do contribute to the tone of blood vessels and c.o. in hypertensives, as they do in normotensives. Many antihypertensive drugs interfere with these regulatory systems at

one level or the other. Antihypertensive drugs, by chronically lowering BP, may reset the barostat to function at a lower level of BP.

Antihypertensive drug therapy has been remarkably improved in the last 50 years. Different classes of drugs have received prominence with passage of time in this period. Before 1950 hardly any effective and tolerated antihypertensive was available. *Veratrum* and *Sod. thiocyanate* could lower BP, but were toxic and difficult to use. The *ganglion blockers* developed in the 1950s were effective, but inconvenient. *Reserpine* was a breakthrough, but produced mental depression. The therapeutic potential of *hydralazine* could not be tapped fully because of marked side effects when it was used alone. *Guanethidine* introduced in 1961 was an improvement on ganglion blockers. The antihypertensives of the 1960–70s were *methyl dopa*, β blockers, *thiazide* and *high ceiling diuretics* and *clonidine*. The status of β blockers and diuretics was consolidated in the 1970s and selective α_1 blocker *prazosin* broke new grounds. The antihypertensives of the 1980–90s are angiotensin II converting enzyme (ACE) inhibitors and *calcium channel blockers*. Angiotensin receptor blockers (*losartan*) are the latest antihypertensives. With the development of many types of drugs, delineation of their long-term benefits and complications, and understanding of the principles on which to combine them, hypertension can now be controlled in most cases with minimum discomfort.

* JNC 7—The seventh report of Joint National Committee (of USA) on prevention, detection, evaluation and treatment of high blood pressure.

@ WHO-ISH—World Health Organization and International Society of Hypertension.

CLASSIFICATION

1. Diuretics

Thiazides: Hydrochlorothiazide,
Chlorthalidone, Indapamide

High ceiling: Furosemide, etc.

K⁺ Sparing: Spironolactone, Amiloride

2. ACE inhibitors

Captopril, Enalapril, Lisinopril,
Perindopril, Ramipril, Fosinopril, etc.

3. Angiotensin (AT₁ receptor) blockers

Losartan, Candesartan, Irbesartan, Valsartan,
Telmisartan

4. Calcium channel blockers

Verapamil, Diltiazem, Nifedipine, Felodipine,
Amlodipine, Nitrendipine, Lacidipine, etc.

5. β Adrenergic blockers

Propranolol, Metoprolol, Atenolol, etc.

6. $\beta + \alpha$ Adrenergic blockers

Labetalol, Carvedilol

7. α Adrenergic blockers

Prazosin, Terazosin, Doxazosin
Phentolamine, Phenoxybenzamine

8. Central sympatholytics

Clonidine, Methyldopa

9. Vasodilators

Arteriolar: Hydralazine, Minoxidil,
Diazoxide

Arteriolar + venous: Sodium nitroprusside

Adrenergic neurone blockers (Reserpine, Guanethidine, etc.) and ganglion blockers (Pentolinium, etc.) are only of historical importance, though reserpine is still marketed.

DIURETICS

Diuretics have been the standard antihypertensive drugs over the past 4 decades, though they do not lower BP in normotensives. Their pharmacology is described in Ch. 41.

Thiazides and related drugs (chlorthalidone, etc.) are the diuretic of choice in uncomplicated hypertension. The proposed mechanism of antihypertensive action is:

1. Initially, the diuresis reduces plasma and e.c.f. volume by 5–15% → decreased c.o.
2. Subsequently, compensatory mechanisms operate to almost regain Na⁺ balance and plasma

volume; c.o. is restored, but the fall in BP is maintained by a slowly developing reduction in t.p.r.

3. The reduction in t.p.r. is most probably an indirect consequence of a small (~5%) persisting Na⁺ and volume deficit. Decrease in intracellular Na⁺ concentration in the vascular smooth muscle may decrease stiffness of vessel wall, increase their compliance and dampen responsiveness to constrictor stimuli (NA, AII). Similar effects are produced by salt restriction; antihypertensive action of diuretics is lost when salt intake is high. A mild slowly developing vasodilator action of thiazides due to opening of smooth muscle K⁺_{ATP} channels and hyperpolarization has been proposed, but does not appear to be real.

The fall in BP develops gradually over 2–4 weeks. During long-term treatment with thiazides, the heart rate and c.o. are unaffected, while t.p.r. is reduced despite compensatory increase in plasma renin activity, which confirms persisting Na⁺ deficit. They have no effect on capacitance vessels, sympathetic reflexes are not impaired: postural hypotension is rare. Thiazides are mild antihypertensives, average fall in mean arterial pressure is ~10 mm Hg. They are effective by themselves in ~30% cases (mostly low grade hypertension) but they potentiate all other antihypertensives (except DHPs) and prevent development of tolerance to these drugs by not allowing expansion of plasma volume. They are more effective in the elderly and maximal antihypertensive efficacy is reached at doses equivalent to 25 mg of hydrochlorothiazide/day, though higher doses produce greater diuresis.

High ceiling diuretics Furosemide, the prototype of this class, is a strong diuretic, but the antihypertensive efficacy does not parallel diuretic potency. Furosemide is a weaker antihypertensive than thiazides: fall in BP is entirely dependent on reduction in plasma volume and c.o. The explanation to this paradox may lie in its brief duration of action. The natriuretic action lasting only 4–6 hr after the conventional morning dose is followed by compensatory increase in

proximal tubular reabsorption of Na⁺. The Na⁺ deficient state in vascular smooth muscle may not be maintained round-the-clock. The t.p.r. and vascular responsiveness are not reduced. Moreover, the high ceiling diuretics are more liable to cause fluid and electrolyte imbalance, weakness and other side effects. They are indicated in hypertension only when it is complicated by:

- (a) Chronic renal failure: thiazides are ineffective, both as diuretics and antihypertensives.
- (b) Coexisting refractory CHF.
- (c) Resistance to combination regimens containing a thiazide, or marked fluid retention due to use of potent vasodilators.

Desirable properties of diuretics as antihypertensives are:

1. Once a day dosing and flat dose-response curve permitting simple standardized regimens.
2. No fluid retention, no tolerance.
3. Low incidence of postural hypotension and relative freedom from side effects, especially CNS, compared to sympatholytics.
4. Effective in isolated systolic hypertension (ISH).
5. Lessened risk of hip fracture in the elderly due to hypocalciuric action of thiazides.
6. Low cost.

Current status of diuretics as antihypertensives

The popularity of diuretics as antihypertensive has had ups and downs. In the 1960–70s they were almost routinely prescribed alone or in combination to nearly all hypertensive patients. The usual dose used was hydrochlorothiazide 50 mg/day or equivalent. Soon a number of drawbacks were highlighted:

- Hypokalaemia—muscle pain, fatigue and loss of energy.
- Erectile dysfunction in males.
- Carbohydrate intolerance: due to inhibition of insulin release (probably secondary to K⁺ depletion which interferes with conversion of proinsulin to insulin), precipitation of diabetes.

- Dyslipidemia: rise in total and LDL cholesterol and triglycerides with lowering of HDL. This could increase atherogenic risk, but no direct evidence has been obtained.
- Hyperuricaemia: by inhibiting urate excretion—increased incidence of gout.
- Increased incidence of sudden cardiac death: attributed to episodes of *torsades de pointes* and ischaemic ventricular fibrillation precipitated by hypokalaemia.

Consequently, prescribing of diuretics fell. Over the past 20 years thiazides have been used at lower doses (12.5–25 mg/day hydrochlorothiazide or equivalent) alone and in combination with a K⁺ sparing diuretic.

The multiple risk factor intervention trial (1982), the Medical research council trial (1987, 1992), the systolic hypertension in the elderly programme (SHEP, 1991) and a case control study (1994) demonstrated that increased incidence of death associated with thiazide diuretic use in the elderly was dose-dependent, and that 25 mg/day hydrochlorothiazide (or equivalent) yielded the best benefit-risk ratio. Favourable results obtained with ≤ 25 mg/day in the above and subsequent studies, including ALLHAT (2002) and a meta-analysis (2003) have reinstated thiazide diuretics as the first choice antihypertensive. Findings with low dose thiazide therapy are:

- Though serum K⁺ falls a little, significant hypokalaemia does not occur.
- Continuous ECG recording studies have failed to document increased incidence of arrhythmias during low-dose thiazide therapy.
- Impairment of glucose tolerance or increase in serum cholesterol or hyperuricaemia over long-term are unlikely.
- Whereas earlier data had failed to document reduction in the incidence of MI with thiazides, analysis of recent trials has found them to reduce fatal and nonfatal MI by 27–44%. The incidence of stroke is reduced by 31–49%. Overall mortality and morbidity is reduced in long-term trials.
- Though not as effective as ACE inhibitors, some recent trials in mild to moderate hypertension have found thiazides to reduce left ventricular mass.

The JNC 7 recommends instituting low-dose (12.5–25 mg) thiazide therapy, preferably with

added K⁺ sparing diuretic, as a first choice treatment of essential hypertension, especially in the elderly. Higher doses are neither more effective nor safe. If the low dose (25 mg/day) fails to reduce BP to desired level, another antihypertensive should be added, rather than increasing dose of the diuretic. However, in the treatment of severe hypertension when potent vasodilators/sympatholytics have induced fluid retention, higher dose of thiazide or a loop diuretic may be appropriate. Notwithstanding the above, there are subsets of patients in whom other antihypertensives are more suitable. Some patients complain impairment of quality of life with diuretics.

Potassium sparing diuretics Spironolactone or amiloride themselves lower BP slightly, but they are used only in conjunction with a thiazide diuretic to prevent K⁺ loss and to augment the antihypertensive action.

Indapamide It is a mild diuretic, chemically related to chlorthalidone; reduces BP at doses which cause little diuresis. Electrolyte disturbances and K⁺ loss are minimal at antihypertensive doses. In post-stroke patients, indapamide, with or without ACE inhibitor, reduces the risk of further stroke. It probably has additional vasodilator action exerted through alteration of ionic fluxes across vascular smooth muscle cell.

Indapamide is well absorbed orally, has an elimination t_{1/2} of 16 hr. Single daily dose (2.5 mg) is enough.

LORVAS, NATRILIX 2.5 mg tab, NATRILIX-SR 1.5 mg SR tab

It is well tolerated: side effects are minor g.i. symptoms and fatigue. Hypokalaemia is infrequent.

ANGIOTENSIN CONVERTING ENZYME (ACE) INHIBITORS

The ACE inhibitors are one of the first choice drugs in all grades of essential as well as renovascular hypertension (except those with bilateral renal artery stenosis). Most patients require relatively lower doses (enalapril 2.5–10 mg/day or equivalent) which are well tolerated.

Used alone they control hypertension in ~50% patients, and addition of a diuretic/ β blocker extends efficacy to ~90%. Because of supraadditive synergism, only a low dose of diuretic (12.5 mg of hydrochlorothiazide, rarely 25 mg) needs to be added. The pharmacology and use of ACE inhibitors in hypertension are described in Ch. 36. Of particular mention are their renal blood flow improving action, their potential to retard diabetic nephropathy and their capacity to regress left ventricular/vascular hypertrophy. They are the most appropriate antihypertensives in patients with diabetes, nephropathy (even nondiabetic), left ventricular hypertrophy, CHF, angina and post MI cases. Several large prospective studies including AIRE (1993), HOPE (2000), ALLHAT (2002) have confirmed the antihypertensive and cardioprotective effects of ACE inhibitors. They appear to be more effective in younger (< 55 year) hypertensives than in the elderly. Dry persistent cough is the most common side effect requiring discontinuation of ACE inhibitors.

ANGIOTENSIN RECEPTOR BLOCKERS

The pharmacology of *losartan* and other angiotensin receptor blockers (ARBs) is described on p. 488. In a dose of 50 mg/day losartan is an effective antihypertensive. Action manifests early and progresses to peak at 2–4 weeks. Addition of 12.5 mg/day hydrochlorothiazide further enhances the fall in BP. The newer ARBs—valsartan, candesartan, irbesartan and telmisartan have been shown to be as effective antihypertensives as ACE inhibitors, while losartan may be somewhat weaker than high doses of ACE inhibitors. ARBs are remarkably free of side effects. Because they do not increase kinin levels, the ACE inhibitor related cough is not encountered. Angioedema, urticaria and taste disturbance are also rare. Though effects of ACE inhibitors and ARBs are not identical, the latter have all the metabolic and prognostic advantages of ACE inhibitors.

Several interventional endpoint reduction trials like LIFE (2002), VALUE (outcomes in hypertensive patients with valsartan or amlodipine, 2004), SCOPE (study on cognition and prognosis in the elderly; stroke prevention with candesartan in elderly with isolated systolic hypertension, 2004), JLIGHT (Japanese losartan therapy intended for global renal protection in hypertensive patients, 2004) have attested to the favourable effects of ARBs on morbidity and mortality in hypertensive patients.

The value of combining ARBs with ACE inhibitors is discussed on p. 489.

CALCIUM CHANNEL BLOCKERS

Calcium channel blockers (CCBs) are another class of first line antihypertensive drugs. Their pharmacology is described in Ch. 39. All 3 subgroups of CCBs, *viz.* dihydropyridines (DHPs, e.g. amlodipine), phenylalkylamine (verapamil) and benzothiazepine (diltiazem) are equally efficacious antihypertensives. They lower BP by decreasing peripheral resistance without compromising c.o. Despite vasodilatation, fluid retention is insignificant.

Ankle edema that occurs in some patients is due to increased hydrostatic pressure across capillaries of the dependent parts as a result of reflex constriction of post capillary vessels in these vascular beds.

The onset of antihypertensive action is quick. With the availability of long acting preparations, most agents can be administered once a day. Monotherapy with CCBs is effective in ~ 50% hypertensives; their action is independent of patient's renin status, and they may improve arterial compliance. Other advantages of CCBs are:

1. Do not compromise haemodynamics: no impairment of physical work capacity.
2. No sedation or other CNS effects; cerebral perfusion is maintained.
3. Not contraindicated in asthma, angina (especially variant) and PVD patients: may benefit these conditions.
4. Do not impair renal perfusion.
5. Do not affect male sexual function.
6. No deleterious effect on plasma lipid profile, uric acid level and electrolyte balance.

7. Shown to have no/minimal effect on quality of life.
8. No adverse foetal effects; can be used during pregnancy (but can weaken uterine contractions during labour).

In the past few years large amount of data from controlled trials (HINT, TRENT, SPRINT I, II) and metaanalysis has consistently indicated increased mortality/reinfarction in patients treated with standard nifedipine (or other short-acting DHP) formulations. This increase in mortality is dose-related. Worsening of unstable angina and CHF has also been noted. The CCBs do not decrease venous return. DHPs may even increase it and jeopardise haemodynamics in patients with diastolic dysfunction. DHPs (especially short-acting) also tend to increase HR and c.o. by invoking reflex sympathetic stimulation. The increased mortality among coronary heart disease patients has been attributed to repeated surges of adrenergic discharge and marked swings of BP attending each dose of rapidly acting DHP. However, this risk cannot be extrapolated to verapamil/diltiazem as brought out by DAVIT I, II and other controlled studies, as well as to slow acting DHPs (amlodipine type) including nifedipine GITS (gastrointestinal therapeutic system).

The Systolic hypertension in Europe (Syst-EUR) trial has shown that nitrendipine (long-acting DHP) reduces cardiovascular morbidity and mortality in elderly hypertensives. The Hypertension optimal treatment (HOT), and Sweedish trial in old patients with hypertension-2 (STOP-2) studies have also found CCBs equi-effective as diuretics/ β blockers/ACE inhibitors in reducing cardiovascular/total mortality. No excess mortality with the use of amlodipine in post MI and acute coronary syndrome patients has been noted in the ALL HAT (2002) study. On the other hand, CCBs do not afford survival benefit in post MI patients as β blockers, ACE inhibitors or low dose thiazides do. CCBs are also not as effective in suppressing left ventricular hypertrophy (a major risk factor in ischaemic heart disease) as ACE inhibitors.

The JNC 7 have considered CCBs to be less suitable for monotherapy in hypertensives with no other risk factors, because they appear to afford less prognostic benefits than thiazides, β blockers and ACE inhibitors/ARBs. However, CCBs are still widely used as one of the first line monotherapy options because of their high efficacy and excellent tolerability. They are preferred in the elderly hypertensive. Also there is convincing evidence of their stroke preventing potential (syst EUR, ALLHAT studies). The long-acting DHPs are next to ACE inhibitors in reducing

albuminuria and slowing disease progression in hypertensive/diabetic nephropathy. They are the most useful antihypertensives in cyclosporine induced hypertension in renal transplant recipients.

Use of rapid acting oral nifedipine for urgent BP lowering in hypertensive emergencies is outmoded. In fact, there is currently no therapeutic indication for rapid and short-acting oral DHPs in hypertension.

Other concerns in the use of CCBs as antihypertensive are:

- (i) The negative inotropic/dromotropic action of verapamil/diltiazem may worsen CHF and cardiac conduction defects (DHPs are less likely to do so).
- (ii) By their smooth muscle relaxant action, the DHPs can worsen gastroesophageal reflux.
- (iii) CCBs (especially DHPs) may accentuate bladder voiding difficulty in elderly males.

β -ADRENERGIC BLOCKERS

The pharmacology and mechanism of antihypertensive action of β blockers is described in Ch. 10. They are mild antihypertensives; do not significantly lower BP in normotensives. Used alone they suffice in 30–40% patients—mostly mild to moderate cases. In the large majority of the rest, they can be usefully combined with other drugs.

The hypotensive response to β blockers develops over 1–3 weeks and is well sustained. Despite short and differing plasma half lives, the antihypertensive action of most β blockers is maintained over 24 hr with a single daily dose.

All β blockers, irrespective of associated properties, exert similar antihypertensive effect. Drugs with intrinsic sympathomimetic activity (ISA) cause less reduction of HR and c.o. but lower vascular resistance by β_2 agonism. The non-selective β blockers slightly reduce renal blood flow and g.f.r., but this is minimal in the β_1 selective ones and those with ISA.

There are several contraindications to β blockers, including cardiac, pulmonary and

peripheral vascular disease. The nonselective β blockers have an unfavourable effect on lipid profile (raise triglyceride level and LDL/HDL ratio). They have also fared poorly on quality of life parameters like decreased work capacity, fatigue, loss of libido and subtle cognitive effects (forgetfulness, low drive), nightmares and increased incidence of antidepressant use. However, most of these drawbacks are minimized in the β_1 selective agents and in those which penetrate brain poorly. Thus, there are several reasons to prefer a β_1 selective hydrophilic drug like atenolol over propranolol.

Because of absence of postural hypotension, bowel alteration, salt and water retention; a low incidence of side effects, low cost; once a day regimen and cardioprotective potential, β blockers continue to be among the first choice drugs recommended by JNC 7 and WHO-ISH, especially for relatively young nonobese hypertensives, those prone to psychological stress or those with ischaemic heart disease—particularly post-infarction. β blockers and ACE inhibitors are the most effective drugs for preventing sudden cardiac death in postinfarction patients; all cause mortality has been lowered in long-term trials. Hypertensives with stable heart failure should be treated with a β blocker that has been shown to be effective in retarding CHF progression (metoprolol/bisoprolol/carvedilol) along with an ACE inhibitor/ARB (CIBIS, 1999; MERIT-HF, 1999, COPERNICUS, 2002 studies). β blockers are considered less effective and less suitable for the older hypertensive. The LIFE (2002) and ALLHAT (2002) trials have found β blockers to be inferior to low-dose thiazide or ACE inhibitor/ARB (losartan) or a combination of these in preventing stroke, as well as in diabetic patients. As monotherapy, ACE inhibitors/ARBs and CCBs appear to compromise quality of life less than β blockers. Rebound hypertension has occurred on sudden discontinuation of β blockers.

β + α ADRENERGIC BLOCKERS

Labetalol (see Ch. 10). It is a combined α and β blocker; reduces t.p.r. and acts faster than pure β blockers. It has

been used i.v. for rapid BP reduction in cheese reaction, clonidine withdrawal, etc. Oral labetalol therapy is restricted to moderately severe hypertension not responding to pure β blocker. Side effects of both α blocker and β blocker occur with it.

Carvedilol This nonselective β + selective α_1 blocker produces vasodilatation and has additional antioxidant/free radical scavenging properties. Whether these ancillary properties confer any superiority is not known. It has also been used in CHF. Side effects are similar to labetalol; liver enzymes may rise in some.

α -ADRENERGIC BLOCKERS

Prazosin (See Ch. 10)

This prototype selective α_1 antagonist dilates both resistance and capacitance vessels; effect on the former predominating. The haemodynamic effects—reduction in t.p.r. and mean BP with only slight decrease in venous return and c.o. are similar to that produced by a direct acting vasodilator. However, there is little reflex cardiac stimulation and renin release during long-term therapy. Tachycardia does not compensate for the fall in BP, because release inhibitory α_2 (presynaptic) receptors are not blocked: autoregulation of NA release remains intact. It probably decreases central sympathetic tone also.

Renal blood flow and g.f.r. are maintained but fluid retention may attend hypotension. Cardiovascular reflexes are not appreciably impaired by chronic therapy, but postural hypotension and fainting may occur in the beginning—called ‘first dose effect’, and with dose increments. This disappears with continued therapy, but may persist in the elderly. For this reason, prazosin is always started at low dose (0.5 mg) given at bedtime and gradually increased with twice daily administration till an adequate response is produced (max. dose 10 mg BD). Patients who develop marked first dose effect generally require lower maintenance doses (2–6 mg/day). An oral dose produces peak fall in BP after 4–5 hours and the effect lasts for nearly 12 hours, though plasma $t_{1/2}$ is only 3 hours. This may be due to generation of active metabolites.

Other advantages of prazosin are:

1. Improves carbohydrate metabolism; suitable for diabetics, but not if neuropathy is present—postural hypotension is accentuated.
2. Has favourable effect on lipid profile: lowers LDL cholesterol and triglycerides, increases HDL.
3. Affords symptomatic improvement in coexisting PVD or benign prostatic hypertrophy.

MINIPRESS XL: Prazosin GITS 2.5 mg, 5 mg tabs.; PRAZOPRESS 1, 2 mg tabs.

Adverse effects Prazosin is generally well tolerated at low doses. Apart from postural hypotension related symptoms (to which tolerance frequently develops), other side effects are headache, drowsiness, dry mouth, weakness, palpitation, nasal blockade, blurred vision and rash. Ejaculation may be impaired in males: especially with higher doses. Fluid retention attending prazosin monotherapy may precipitate CHF.

Prazosin is a moderately potent antihypertensive with many desirable features, but is not used as a first line drug because fluid retention and tolerance gradually develops with monotherapy—necessitating dose increase—more side effects and risk of CHF. It may be added to a diuretic + β blocker in those not achieving target BP.

Terazosin, Doxazosin These are long-acting congeners of prazosin with similar properties and suitable for once daily dosing (see p. 134). In the ALL HAT (2002) study doxazosin monotherapy has doubled the incidence of CHF; but this can occur with any α_1 blocker. A higher incidence of stroke relative to patients receiving a thiazide diuretic was also noted.

Nonselective α blockers (Phentolamine, Phenoxybenzamine)

The conventional α blockers have been disappointing for routine treatment of hypertension, because fall in t.p.r. is compensated by increased HR and c.o. They block both α_1 and α_2 receptors—NA release is accentuated. They are reserved for special situations like pheochromocytoma, clonidine withdrawal, cheese reaction, etc., where circulating CAs are responsible for the rise in BP.

CENTRAL SYMPATHOLYTICS

Clonidine It is an imidazoline derivative having complex actions. Clonidine is a partial agonist with high affinity and high intrinsic activity at α_2 receptors, especially α_{2A} subtype in brainstem. The major haemodynamic effects result from stimulation of α_{2A} receptors present mainly postjunctionally in medulla (vasomotor centre) → decrease sympathetic out flow → fall in BP and bradycardia (also due to enhanced vagal tone). Plasma NA declines. Though clonidine is capable of reducing NA release from peripheral adrenergic nerve endings (release inhibitory prejunctional α_2 action), this is not manifest at clinically used doses. Clonidine is a moderately potent antihypertensive.

Presence of *Imidazoline receptors* which are distinct from α_2 receptors has now been confirmed both in the brain as well as periphery. These are activated by clonidine and related drugs but not by NA. Experimental evidence suggests that clonidine may first stimulate central imidazoline receptors which then trigger medullary α_{2A} receptors to reduce sympathetic outflow. Clonidine also appears to directly stimulate α_{2A} receptors to produce hypotension and sedation. *Rilmenidine* and *moxonidine* are selective cerebral imidazoline receptor agonists with low α_2 receptor affinity. Therefore, they have low sedative property but equivalent antihypertensive action.

Rapid i.v. injection of clonidine raises BP transiently due to activation of peripheral postsynaptic vasoconstrictor α_{2B} receptors at the high concentrations so attained. Oral doses producing lower plasma clonidine levels cause only fall in BP, because clonidine has lower intrinsic activity on α_{2B} receptors which predominate in vascular smooth muscle. Probably for the same reason clonidine exhibits the therapeutic window phenomenon: optimum lowering of BP occurs between blood levels of 0.2–2.0 ng/ml. At higher concentrations fall in BP is less marked.

On chronic administration of clonidine decrease in c.o. contributes more to the fall in BP than decrease in t.p.r. Cardiovascular reflexes are affected little. Decreased sympathetic flow to the kidney results in reduced renin release. It does not alter plasma lipid levels.

Pharmacokinetics Clonidine is well absorbed orally; peak occurs in 2–4 hours; 1/2 to 2/3 of an oral dose is excreted unchanged in urine, the rest as metabolites. Plasma $t_{1/2}$ is 8–12 hours. Effect of a single dose lasts for 6–24 hours.

Dose: Start with 100 μg OD or BD, max. 300 μg TDS, orally or i.m.

CATAPRES 150 μg tab, ARKAMIN 100 μg tab.

Adverse effects Side effects with clonidine are relatively common.

- Sedation, mental depression, disturbed sleep; dryness of mouth, nose and eyes (secretion is decreased by central action), constipation (antisecretory effect on the intestines).
- Impotence, salt and water retention, bradycardia (due to reduced sympathetic tone).
- Postural hypotension occurs, but is mostly asymptomatic.
- Alarming rise in BP, in excess of pretreatment level, with tachycardia, restlessness, anxiety, sweating, headache, nausea and vomiting occur in some patients when doses of clonidine are missed for 1–2 days. The syndrome is very similar to that seen in pheochromocytoma: plasma catecholamine (CA) concentration is increased. This is due to:
 - (a) Sudden removal of central sympathetic inhibition resulting in release of large quantities of stored CAs.
 - (b) Supersensitivity of peripheral adrenergic structures to CAs that develops due to chronic reduction of sympathetic tone during clonidine therapy.

A combination of α blocker with a β blocker, or a potent vasodilator or clonidine itself can be used to treat the syndrome.

Interactions Tricyclic antidepressants and chlorpromazine abolish the antihypertensive action of clonidine, probably by blocking α receptors on which clonidine acts.

Use Clonidine was a popular antihypertensive in the late 1960s and 1970s, but frequent side effects, risk of withdrawal hypertension and development of tolerance to its monotherapy have relegated it to a 3rd or 4th choice drug. At present, it is occasionally used in combination with a diuretic.

Other indications

1. Opioid withdrawal: Opioid and α_2 adrenergic systems converge on the same effectors in many systems; both activate the G_i regulatory protein. Clonidine suppresses sympathetic overactivity of opioid withdrawal syndrome and reduces craving to some extent.

Clonidine has also facilitated alcohol withdrawal and smoking cessation.

2. Clonidine has analgesic activity. It has been used to substitute morphine for intrathecal/epidural surgical and postoperative analgesia.
3. Administered preoperatively, it diminishes anaesthetic requirement.
4. Clonidine attenuates vasomotor symptoms of menopausal syndrome.

5. Clonidine has been used to control loose motions due to diabetic neuropathy—may be acting by α_2 receptor mediated enhancement of salt absorption in gut mucosa.

6. Clonidine suppression test for pheochromocytoma: clonidine reduces plasma NA concentration to < 0.5 ng/ml in patients of essential hypertension but not in those with pheochromocytoma.

Methyldopa It is the α -methyl analogue of dopa, the precursor of dopamine (DA) and NA. The α methyl-NA (a selective α_2 agonist) formed in the brain from methyldopa acts on central α_2 receptors to decrease efferent sympathetic activity. Because methyldopa decreases t.p.r. more than HR or c.o., it may be acting on a different population of neurones in the vasomotor centre than clonidine. In large doses, methyldopa inhibits the enzyme dopa decarboxylase in brain and periphery \rightarrow reduces NA synthesis and forms the *false transmitter* methyl-NA in periphery as well. These mechanisms were considered to be responsible for the antihypertensive effect; but it was demonstrated that neither responses to stimulation of sympathetic nerves nor their NA content was reduced at clinically used antihypertensive doses. Moreover, α methyl NA is as potent vasoconstrictor as NA. The primary central site of action of methyldopa has been confirmed.

Methyldopa is a moderate efficacy anti-hypertensive. Circulating levels of NA and renin tend to fall due to reduction in sympathetic tone. Inhibition of postural reflexes is mild.

Pharmacokinetics Though methyldopa is transported actively by intestinal amino acid carrier, less than 1/3 of an oral dose is absorbed. It is partly metabolized and partly excreted unchanged in urine. Antihypertensive effect develops over 4–6 hours and lasts for 12–24 hours.

Dose: 0.25–0.5 g BD–QID oral.

EMDOPA, ALPHADOPA 250 mg tab.

Adverse effects Sedation, lethargy and reduced mental capacity are common side effects.

Cognitive impairment may develop. Dryness of mouth, nasal stuffiness, headache, fluid retention, weight gain, impotence.

Postural hypotension is generally mild but more common than with clonidine; occurs especially in the elderly patients and in those receiving a diuretic.

Positive Coomb's test occurs in 1/6 patients, few develop haemolytic anaemia. Fever, rash, hepatitis, 'flu' like illness, thrombocytopenia and rarely lupus syndrome occur.

Rebound hypertension on sudden withdrawal of methyldopa is mild and less common.

Interactions Tricyclic antidepressants reverse its action by blocking its active transport into the adrenergic neurones.

Use Methyldopa was a widely used anti-hypertensive, especially in combination with a diuretic. However, it is infrequently used now, except to treat hypertension during pregnancy wherein it has a long track record of safety, both for the mother as well as the foetus.

VASODILATORS

Hydralazine/Dihydralazine It is a directly acting arteriolar vasodilator with little action on venous capacitance vessels; reduces t.p.r. It causes greater reduction of diastolic than systolic BP. Reflex compensatory mechanisms are evoked which cause tachycardia, increase in c.o. and renin release \rightarrow increased aldosterone \rightarrow Na^+ and water retention. The disproportionate cardiac stimulation appears to involve direct augmentation of NA release and myocardial contractility as well. Thus, a hyperdynamic circulatory state is induced—angina may be precipitated due to increased cardiac work as well as steal phenomenon. There is no reduction in renal blood flow despite fall in BP. However, fluid retention and edema may occur by the above mechanism. Tolerance to the hypotensive action develops unless diuretics or β blockers or both are given together to block the compensatory mechanisms.

The mechanism of vascular smooth muscle relaxant action of hydralazine is not clearly known. It is partly endothelium dependent: may involve generation of NO (nitric oxide) and stimulation of cGMP. Direct effects on membrane potential and on Ca^{2+} fluxes have also been proposed.

Pharmacokinetics Hydralazine is well absorbed orally, and is subjected to first pass metabolism in liver. The chief metabolic pathway is acetylation which exhibits a bimodal distribution in the population: there are slow and

fast acetylators. Bioavailability is higher in slow acetylators, but these patients are more prone to develop the lupus syndrome.

Hydralazine is completely metabolized both in liver and plasma; the metabolites are excreted in urine, $t_{1/2}$ 1–2 hours. However, hypotensive effect lasts longer (12 hours), probably because of its persistence in the vessel wall.

Dose: 25–50 mg OD–TDS; **NEPRESOL 25 mg tab.**

Adverse effects are frequent and mainly due to vasodilatation.

1. Facial flushing, conjunctival injection, throbbing headache, dizziness, palpitation, nasal stuffiness, fluid retention, edema, CHF.
2. Angina and MI may be precipitated in patients with coronary artery disease.
3. Postural hypotension is not prominent because of little action on veins: venous return and c.o. are not reduced.
4. Paresthesias, tremor, muscle cramps, rarely peripheral neuritis.
5. Lupus erythematosus or rheumatoid arthritis like symptoms develop on prolonged use of doses above 100 mg/day. It is more common in women and in slow acetylators. It is slowly reversible on stopping treatment.

Use Hydralazine is used in moderate-to-severe hypertension not controlled by the first line drugs. Usually, low doses are added to the diuretic and β blocker already being administered. It is not used alone. Large doses are not recommended for long periods.

Hydralazine can be used in patients with renal involvement, but is contraindicated in older patients and in those with ischaemic heart disease. It is one of the preferred antihypertensives during pregnancy because of decades of experience and record of safety. It can also be used parenterally in hypertensive emergencies.

The arteriolar dilator action of hydralazine can be employed in the management of CHF (*see* p. 504–505).

Minoxidil It is a powerful vasodilator, the pattern of action resembling hydralazine, i.e. direct relaxation of arteriolar smooth muscle with little effect on venous capacitance. Marked vasodilatation elicits strong compensatory reflexes: increased renin release and proximal tubular Na^+ reabsorption \rightarrow marked Na^+ and water retention \rightarrow edema and CHF may occur; increased sympathetic activity \rightarrow palpitation, increased c.o. To offset these, it has to be used along with a loop diuretic and a β blocker.

Minoxidil is a prodrug—converted to an active metabolite (by sulfate conjugation) which is an opener of ATP operated K^+ channels; acts by hyperpolarizing smooth muscle.

Minoxidil is indicated only rarely in severe or life-threatening hypertension.

Use in alopecia Oral minoxidil increases growth of body hair. Applied topically (2% twice daily) it promotes hair growth in *male pattern baldness* and *alopecia areata*. The response is slow (takes 2–6 months) and incomplete, but upto 60% subjects derive some benefit, albeit for short periods. Baldness recurs when therapy is discontinued. The mechanism of increased hair growth is not known; may involve:

- (a) Enhanced microcirculation around hair follicles.
- (b) Direct stimulation of resting hair follicles.
- (c) Alteration of androgen effect on genetically programmed hair follicles.

Local irritation, itching and burning sensation are frequent. Dermatological reaction and systemic side effects (headache, dizziness, palpitation) occur in 1–3% cases.

MINTOP, GROMANE 2% scalp lotion, MULTIGAIN 2% topical solution and metered spray, MANEXIL 5% gel; apply twice a day.

Diazoxide This K^+ channel opener dilator of arterioles was used in the past for rapid reduction of BP in hypertensive emergencies. It is administered by rapid i.v. injection in fractional doses (50–100 mg) repeated every 5–10 min, as required. Slow i.v. injection or infusion is less effective because it binds tightly to plasma proteins before binding to vessel wall.

The duration of action is long (6–24 hours) because of tight binding to plasma and tissue proteins. It is employed in place of nitroprusside when regulated i.v. infusion or close monitoring is not possible.

Sodium nitroprusside It is a rapidly (within seconds) and consistently acting vasodilator; has brief duration of action (2–5 min)—vascular tone can be titrated with the rate of i.v. infusion. It relaxes both resistance and capacitance vessels: reduces t.p.r. as well as c.o. (by decreasing venous return). Myocardial work is reduced—*ischaemia* is not accentuated, as occurs with selective arteriolar dilators (hydralazine). Little reflex tachy-

cardia is produced in supine posture. Plasma renin is increased.

In patients with heart failure and ventricular dilatation, nitroprusside improves ventricular function and CO by reducing cardiac preload and afterload.

Endothelial cells, RBCs (and may be other cells) split nitroprusside to generate NO which relaxes vascular smooth muscle. The enzymes involved are different from those that produce NO from glyceryl trinitrate. Moreover, nitroprusside is nonenzymatically converted to NO (and CN) by glutathione. This may be responsible for the different pattern of vasodilator action compared to nitrates, as well as for the fact that no nitrate like tolerance develops to nitroprusside action.

Nitroprusside has gained popularity in the management of hypertensive emergencies; 50 mg is added to a 500 ml bottle of saline/glucose solution. The infusion is started at 0.02 mg/min and titrated upward with the response: 0.1–0.3 mg/min is often needed. It decomposes at alkaline pH and on exposure to light: the infusion bottle should be covered with black paper.

Nitroprusside is split to release cyanide. The latter is converted in liver to thiocyanate which is excreted slowly. If larger doses are infused for more than 1–2 days, excess thiocyanate may accumulate and produce toxicity, including psychosis.

Side effects mainly due to vasodilatation are—palpitation, nervousness, vomiting, perspiration, pain in abdomen, weakness, disorientation, and lactic acidosis (caused by the released cyanide).

Nitroprusside has also been used to produce controlled hypotension, in refractory CHF, pump failure accompanying MI and in acute mitral regurgitation.

SONIDE, PRUSIDE, NIPRESS 50 mg in 5 ml inj.

ADRENERGIC NEURONE BLOCKERS

Reserpine It is an alkaloid from the roots of *Rauwolfia serpentina* (sarpagandha) indigenous to India which has

been used in 'Ayurvedic' medicine for centuries. The pure alkaloid was isolated in 1955 and later found to act by causing CA and 5-HT depletion. It was a popular antihypertensive of the late 1950s and early 1960s, but is now used only as a pharmacological tool.

Reserpine acts at the membrane of intraneuronal granules which store monoamines (NA, 5-HT, DA) and irreversibly inhibits the active amine transporters → the monoamines are gradually depleted and degraded by MAO. The effects last long after the drug is eliminated (hit and run drug) because tissue CA stores are restored only gradually.

Higher doses deplete CAs and 5-HT in the brain as well; cause sedation and mental depression. Antipsychotic effect (mild) and extrapyramidal symptoms are produced due to DA depletion.

SERPASIL 0.25 mg tab; 1 mg/ml inj.

Guanethidine It is a polar guanidine compound which is taken up into the adrenergic nerve endings by active amine transport, and has three important facets of action:

- Displaces NA from storage granules stoichiometrically.
- Inhibits nerve impulse coupled release of NA.
- Engages and blocks NA uptake mechanism at the axonal membrane.

Guanethidine has gone out of use now due to marked side effects.

TREATMENT OF HYPERTENSION

The aim of antihypertensive therapy is to prevent morbidity and mortality associated with persistently raised BP by lowering it to an acceptable level, with minimum inconvenience to the patient. Both systolic and diastolic BP predict the likelihood of target organ damage and complications such as:

- Cerebrovascular disease, transient ischaemic attacks, stroke, encephalopathy.
- Hypertensive heart disease—left ventricular hypertrophy, CHF.
- Coronary artery disease (CAD), angina, myocardial infarction, sudden cardiac death.
- Arteriosclerotic peripheral vascular disease, retinopathy.
- Dissecting aneurysm.
- Glomerulopathy, renal failure.

The JNC 7 (2003) has reclassified BP readings as:

BP classification	BP (mm Hg)	
	Systolic	Diastolic
1. Normal	<120	and <80
2. Prehypertension	120–139	or 80–89
3. Hypertension Stage I	140–159	or 90–99
4. Hypertension Stage II	≥ 160	or ≥ 100

Since the risk of complications depends not only on the level of BP, but also on other risk factors (see box) and existing target organ damage (TOD), these have also to be considered in deciding when to start drug therapy, in selection of drugs and in devising therapeutic regimens.

Cardiovascular risk factors

1. Age > 55 years (men), > 65 years (women)
2. Family h/o premature CV disease
3. Smoking
4. Dyslipidemia (↑LDL, ↓HDL, ↑TG)
5. Diabetes mellitus
6. Hypertension
7. Obesity (BMI ≥ 30)
8. Microalbuminuria or g.f.r. < 60 ml/min

The JNC7 have also identified compelling indications (see box) which may mandate use of specific antihypertensive drugs even in patients with BP values in the 'prehypertension' range. Moreover, presence of compelling indications may suggest fixing a lower target BP value to be attained by drug therapy.

Compelling indications for use of antihypertensive drugs

1. Heart failure
2. High coronary artery disease (CAD) risk
3. H/o MI in the past
4. H/o stroke in the past
5. Diabetes
6. Chronic renal disease

Beneficial effects of lowering BP has been established in all patients having BP above 140/90 mm Hg, and even in the 120–139 (systolic) or 80–89 mm Hg (diastolic) range in those with

compelling indications or cardiovascular risk factors; e.g. in diabetics, lowering diastolic BP to 80 mmHg was found to reduce cardiovascular events more than reducing it upto 90 mm Hg.

If the cause of hypertension can be identified (hormonal, vascular abnormality, tumours, renal disease, drugs) all efforts should be made to remove it. Nonpharmacological measures (life style modification—diet, Na⁺ restriction, aerobic activity or exercise, weight reduction, moderation in alcohol intake, mental relaxation, etc.) should be tried first and concurrently with drugs. The level to which BP should be lowered is uncertain. A value of < 140 systolic and < 90 mmHg diastolic is considered adequate response, because it clearly reduces morbidity and mortality, though risk reduction may continue upto 120/80 mmHg in terms of CAD, heart failure, stroke, etc. When significant cardiovascular and/or renal damage has already occurred, lowering BP to normotensive level may not be tolerated: edema, CHF, angina, rise in blood urea and syncope may be precipitated: reduce BP gradually and only to the level tolerated.

The Swedish trial in old patients with hypertension-2 (STOP-2, 1999) conducted over 5 years in 6614 hypertensives aged 70–84 years has shown that conventional therapy with diuretic and/or β blockers is as effective in reducing BP and risk of major cardiovascular events as are ACE inhibitors or CCBs. The ALLHAT (2002) study comparing chlorthalidone, lisinopril and amlodipine has also found no difference in the primary outcomes of death and MI. The results convey that efficacywise there is little to choose among the 4 classes of drugs; choice of initial drug has to be guided by associated features/contraindications and acceptable side effects in individual patients.

With the establishment of at least five groups (ACE inhibitors; AT₁ antagonists, CCBs, β blockers, diuretics) of first choice drugs and their evaluation in large multicentric trials, an 'individualized care approach' can be adopted for the selection of initial monotherapy, followed if needed, by stepped combination therapy. The principle of this approach is to match the lifestyle issues, tolerability and concomitant medical conditions of individual patients with the pharmacological and clinical properties of an appropriate antihypertensive drug. For each class

Selection of first line antihypertensive drugs

Compelling indications	Suitable for	To be avoided in
Diuretics		
<ol style="list-style-type: none"> Heart failure High CAD risk Recurrent stroke prevention Diabetes 	<ol style="list-style-type: none"> Elderly patients Low renin hypertension Isolated systolic hypertension Obese with volume overload Low cost therapy 	<ol style="list-style-type: none"> Gout or family history of gout Abnormal lipid profile Pregnancy induced hypertension
ACE inhibitors/AT₁ blockers		
<ol style="list-style-type: none"> Heart failure Post-MI High CAD risk Diabetes Chronic kidney disease Recurrent stroke prevention 	<ol style="list-style-type: none"> Relatively young patients Patients with left ventricular hypertrophy Gout, PVD, dyslipidemic patients 	<ol style="list-style-type: none"> Bilateral renal artery stenosis or that in single kidney Pregnancy Hyperkalaemia Preexisting dry cough (ACE inhibitor)
β Adrenergic blockers		
<ol style="list-style-type: none"> Stable heart failure Post-MI High CAD risk 	<ol style="list-style-type: none"> Coexisting anxiety or tachycardia Relatively young patient Non-obese, high renin hypertensive Pregnancy (cardioselective and β blockers with ISA) Migraine patients Low cost therapy 	<p>(especially applicable to nonselective β blockers)</p> <ol style="list-style-type: none"> Asthma, COPD Bradycardia, conduction defects Decompensated heart failure PVD Abnormal lipid profile
Calcium channel blockers		
<ol style="list-style-type: none"> Recurrent stroke prevention 	<ol style="list-style-type: none"> Elderly who generally have poor arterial wall compliance Isolated systolic hypertension Asthma/COPD patients Raynaud's (and other PVD) patients Pregnant hypertensive Diabetics 	<ol style="list-style-type: none"> Myocardial inadequacy, CHF Conduction defects, sick sinus Receiving β blockers Ischaemic heart disease; post MI cases Males with prostate enlargement Gastroesophageal reflux <p> } Verapamil and diltiazem } DHPs </p>

of antihypertensive drugs, certain patients can be identified who are best suited to be treated with that drug as first choice therapy, and those in whom it should be avoided (*see box*).

The general principles of antihypertensive therapy enunciated in JNC7 and WHO-ISH guidelines may be summarized as:

- Except for stage II hypertension, start with a single most appropriate drug which for majority of patients is a thiazide. However, a β blocker, ACE inhibitor, ARB or CCB may

also be considered. The CCBs may be less suitable for monotherapy due to less convincing prognostic benefits, except in the elderly and for stroke prevention.

- Initiate therapy at low dose; if needed increase dose moderately. Thiazide dose should be 12.5–25 mg/day hydrochlorothiazide or equivalent.
- Majority of stage II hypertensives are started on a 2 drug combination; one of which usually is a thiazide diuretic.

4. If only partial response, add a drug from another complimentary class or change to low dose combination.
5. If no response, change to a drug from another class, or low dose combination from other classes.
6. In case of side effect to the initially chosen drug, either substitute with drug of another class or reduce dose and add a drug from another class.

With the above approach 50–70% stage I hypertensives can be successfully treated, at least initially, with monodrug therapy. A simple regimen with once or twice daily drug dosing is most likely to be complied with. Because most stage I and some stage II hypertension patients are asymptomatic, a drug which makes them symptomatic (one or the other side effect) is not likely to be accepted for prolonged periods. Effect of the drug on quality of life measured by sense of wellbeing, energy level, mental acuity, drive, libido, sleep, life satisfaction, etc. is an important criterion in drug selection.

Combination therapy Though both JNC 7 and WHO-ISH emphasise on single drug therapy, the addition of a second (and third) drug when monotherapy fails or is not tolerated, is also highlighted. In practice, a large majority of hypertensives ultimately require 2 or more drugs. In the HOT study 70% patients who achieved target BP were being treated with 2 drugs.

Since BP is kept up by several interrelated factors, an attempt to block one of them tends to increase compensatory activity of the others. It is rational in such cases to combine drugs with different mechanisms of action or different patterns of haemodynamic effects:

- (a) Drugs which increase plasma renin activity—diuretics, vasodilators, CCBs, ACE inhibitors may be combined with drugs which lower plasma renin activity— β blockers, clonidine, methyldopa.
- (b) All sympathetic inhibitors (except β blockers) and vasodilators cause fluid retention: used alone tolerance develops. Addition of a diure-

tic checks fluid retention and development of tolerance.

- (c) Hydralazine and DHPs cause tachycardia which is counteracted by β blockers, while the initial increase in t.p.r. caused by non-selective β blockers is counteracted by the vasodilator.
- (d) ACE inhibitors/ARBs are particularly synergistic with diuretics; this combination is very good for patients with associated CHF and left ventricular hypertrophy.
- (e) Other useful combinations are:
ACE inhibitor/ARB + CCB
ACE inhibitor/ARB + β blocker
 β blocker + prazosin

Combination therapy with low doses of each component allows BP reduction in nonresponsive patients with fewer side effects: antihypertensive action of the components adds up, while side effects being different do not. Use of combined formulation improves compliance and lowers cost.

A three drug combination therapy may be needed in a few patients (of severe or nonresponsive hypertension). Commonly used triple drug combinations are:

- CCB + ACE inhibitor/ARB + diuretic
- CCB + β blocker + diuretic
- ACE inhibitor/ARB + β blocker + diuretic

Combinations including prazosin or clonidine or hydralazine are infrequently used. Patients who fail to reach the goal BP despite being adherent to full doses of an appropriate 3 drug (including a diuretic) regimen, have been labelled by JNC7 as 'resistant hypertension'. In them even 4 drug therapy may have to be given to achieve the target BP. However, the patient must be reevaluated and factors like non-compliance, pseudotolerance, need for a loop diuretic, drug interactions, secondary hypertension, etc. must be first excluded.

Combinations to be avoided

1. An α or β adrenergic blocker with clonidine: apparent antagonism of clonidine action has been observed.

2. Nifedipine (or other DHPs) with diuretic: synergism between these drugs is unproven.
3. Hydralazine with a DHP or prazosin: similar pattern of haemodynamic action.
4. Verapamil or diltiazem with β blocker: marked bradycardia, A-V block.
5. Methyldopa with clonidine or any two drugs of the same class.

Some antihypertensive combinations

1. Amlodipine 5 mg + Lisinopril 5 mg—**AMLOPRES-L, LISTRIL-AM**
2. Amlodipine 5 mg + Atenolol 50 mg—**AMCARD-AT, AMLOPIN-AT, AMLOPRES-AT**
3. Amlodipine 5 mg + Enalapril 5 mg—**AMACE, AMTAS-E**
4. Atenolol 25 mg or 50 mg + chlorthalidone 12.5 mg—**TENOCLOR, TENORIC**
5. Enalapril 10 mg + Hydrochlorothiazide 25 mg—**ENACE-D, VASONORM-H**
6. Ramipril 2.5 mg + Hydrochlorothiazide 12.5 mg—**CARDACE-H**
7. Losartan 50 mg + Hydrochlorothiazide 12.5 mg—**LOSAR-H, TOZAAR-H, LOSACAR-H**
8. Lisinopril 5 mg + Hydrochlorothiazide 12.5 mg—**LISTRIL PULS, LISORIL-HT**
9. Losartan 50 mg + Ramipril 2.5 mg or 5 mg—**TOZAAR-R, LAPIDO-R**
10. Losartan 50 mg + Amlodipine 5 mg—**AMCARD-LP, AMLOPRESS-Z, LOSACAR-A**
11. Losartan 50 mg + Ramipril 2.5 mg + Hydrochlorothiazide 12.5 mg—**LOSANORM-HR**
12. Irbesartan 150 mg + Hydrochlorothiazide 12.5 mg—**IROVEL-H, XARB-H**.

When the BP has been well controlled for > 1 year, stepwise reduction in dose and/or withdrawal of one or more components of a combination may be attempted to workout a minimal regimen that will maintain the target BP. However, in most patients of essential hypertension, drug therapy is usually life-long.

Hypertension in pregnancy A sustained BP reading above 140/90 mm Hg during pregnancy has implications both for the mother and the foetus: reduction of BP clearly reduces risks. Two types of situations are possible:

- (a) A woman with preexisting essential hypertension becomes pregnant.
- (b) Pregnancy induced hypertension; as in toxæmia of pregnancy—preeclampsia.

Toxaemic hypertension is associated with a hyperadrenergic state, decrease in plasma volume (despite edema) and increase in vascular resistance.

In the first category the same therapy instituted before pregnancy may be continued. However, one of the 'safer' drugs listed below may be substituted if one of the 'drugs to be avoided' was being used.

Antihypertensives to be avoided during pregnancy

Diuretics: Tend to reduce blood volume—accentuate uteroplacental perfusion deficit (of toxæmia)—increase risk of foetal wastage, placental infarcts, miscarriage, stillbirth.

ACE inhibitors, AT₁ antagonists: Risk of foetal damage, growth retardation.

Nonselective β blockers: Propranolol has been implicated to cause low birth weight, decreased placental size, neonatal bradycardia and hypoglycaemia.

Sod. nitroprusside: Contraindicated in eclampsia.

Antihypertensives found safer during pregnancy

Hydralazine

Methyldopa (a positive Coombs' test occurs, but has no adverse implication).

Dihydropyridine CCBs: discontinue before labour as they weaken uterine contractions.

Cardioselective β blockers and those with ISA, e.g. atenolol, metoprolol, pindolol, acebutolol: may be used if no other choice.

Prazosin and clonidine—provided that postural hypotension can be avoided.

Hypertensive emergencies and urgencies

Systolic BP > 180 or diastolic BP > 120 mm Hg with evidence of active end organ damage is labelled 'hypertensive emergency', while the same elevation of BP without signs of endorgan damage is termed 'hypertensive urgency'.

Controlled reduction of BP over minutes (in emergencies) or hours (in urgencies) is required to counter threat to organ function and life in:

1. Cerebrovascular accident (haemorrhage) or head injury with high BP.
2. Hypertensive encephalopathy.
3. Hypertensive acute LVF and pulmonary edema.
4. Unstable angina or MI with raised BP.
5. Dissecting aortic aneurysm.
6. Acute renal failure with raised BP.
7. Eclampsia.
8. Hypertensive episodes in pheochromocytoma, cheese reaction or clonidine withdrawal.

Nifedipine (10 mg soft geletine cap) orally every ½–1 hr was widely employed for rapid BP reduction in urgencies. This practice has now been discarded because of inability to control rate and degree of fall in BP as well as serious adverse consequences/mortality. Other rapidly acting oral drugs like *captopril* (25 mg) or *clonidine* (100 µg) every 1–2 hours have also been found unsatisfactory. Parenteral drugs with controllable action are now used. Mean BP should be lowered by no more than 25% over minutes or a few hours and then gradually to not lower than 160/100 mmHg. Drugs employed are:

1. *Sodium nitroprusside* (see p. 548) Because of predictable, instantaneous, titratable and balanced arterio-venous vasodilatory action which persists without tolerance till infused, nitroprusside (20–300 µg/min) is the drug of choice for most hypertensive emergencies. However, it needs an infusion pump and constant monitoring, but is the most effective drug.
2. *Glycerol trinitrate* (see p. 525) Given by i.v. infusion (5–20 µg/min) GTN also acts within 2–5 min and has brief titratable action. Its predominant venodilator action makes it particularly suitable for lowering BP after cardiac surgery and in acute LVF, MI, unstable angina. Tolerance starts developing after 18–24 hours of continuous infusion.
3. *Diazoxide* (see p. 548) Given as fractional i.v. bolus doses—BP once lowered remains so for ≥ 6 hours; constant monitoring is not required.
4. *Hydralazine* (see p. 547) 10–20 mg i.m. or slow i.v. injection; acts in 20–30 min and keeps BP low for 4–8 hours. It has been especially used in eclampsia. It is to be avoided in patients with myocardial ischaemia or aortic dissection.
5. *Esmolol* (see p. 141) This β blocker given as 0.5 mg/kg bolus followed by slow i.v. injection (50–200 µg/kg/min) acts in 1–2 min; action lasts for 10–20 min. It is particularly useful when cardiac contractility and work is to be reduced, such as in aortic dissection (nitroprusside may be given concurrently) and during/after anaesthesia. The BP lowering action is weaker. Excess bradycardia is to be guarded.
6. *Phentolamine* (see p. 134) This α₁ + α₂ blocker is the drug of choice for hyperadrenergic states—hypertensive episodes in pheochromocytoma, cheese reaction, clonidine withdrawal. Injected i.v. (5–10 mg) it acts in 2 min and action lasts 5–15 min. Tachycardia and myocardial ischaemia may complicate its use. A β blocker may be added.
7. *Labetalol* Injected i.v., it is an alternative to α + β blockers for lowering BP in pheochromocytoma, etc. but has only weak α blocking action. It has been used to lower BP in MI, unstable angina, eclampsia also. Concomitant CHF and asthma preclude its use.
8. *Furosemide* (20–80 mg oral or i.v.) It may be given as an adjunct with any of the above drugs if there is volume overload (acute LVF, pulmonary edema, CHF) or cerebral edema (in encephalopathy), but should be avoided when patient may be hypovolemic due to pressure induced natriuresis (especially in eclampsia, pheochromocytoma).

Drugs Acting on Kidney



SECTION

9

Relevant Physiology of Urine Formation

Urine formation starts from glomerular filtration (g.f.) in a prodigal way. Normally, about 180 L of fluid is filtered everyday: all soluble constituents of blood minus the plasma proteins (along with substances bound to them) and lipids, are filtered at the glomerulus. More than 99% of the glomerular filtrate is reabsorbed in the tubules; about 1.5 L urine is produced in 24 hours. The diuretics act primarily by inhibiting tubular reabsorption: just

1% decrease in tubular reabsorption would more than double urine output.

The mechanisms that carry out ion movement across tubular cells are complex and involve a variety of energy dependent transmembrane pumps as well as channels in between the loose fitting cells of the proximal tubule (PT). All Na^+ that enters tubular cells through the luminal membrane is pumped out of it into the renal

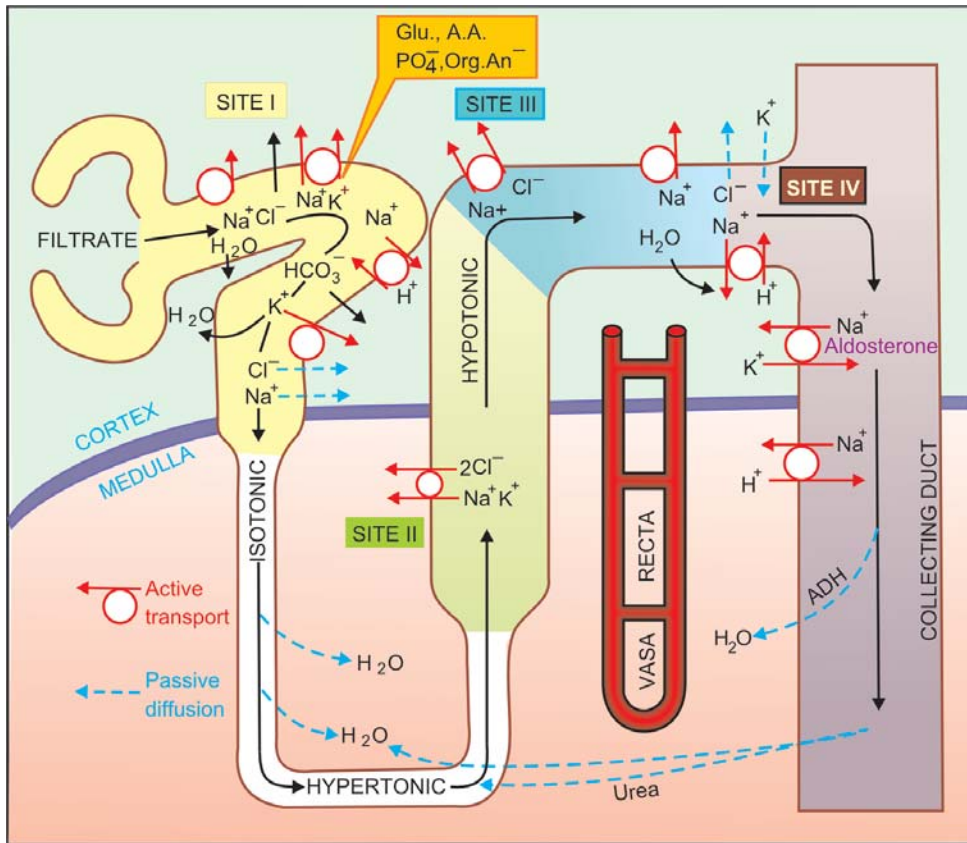

Fig. IX.1: Diagrammatic representation of nephron showing the four sites of solute reabsorption. The thick ascending limb of loop of Henle is impermeable to water; Glu.—Glucose; A.A.—Amino acid; Org. An.—Organic anions.

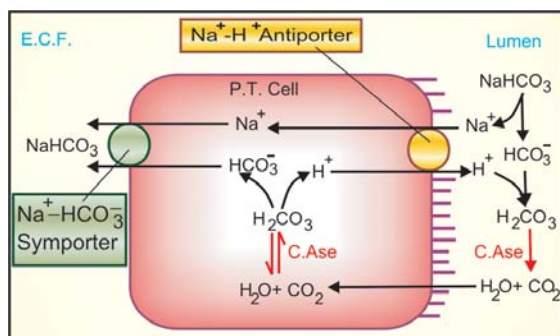

Fig. IX.2: The carbonic anhydrase (C.Ase) mediated bicarbonate absorption in proximal tubule (P.T.)

interstitium at the basolateral membrane by $\text{Na}^+\text{K}^+\text{ATPase}$ energised $\text{Na}^+\text{-K}^+$ antiporter (see Figs 41.1 and 41.2). Because there is a large intracellular to extracellular gradient for K^+ , it diffuses out through K^+ channels to be recirculated by the $\text{Na}^+\text{-K}^+$ antiporter. For simplification, tubular reabsorption can be divided into four sites (Fig. IX.1).

Site I: Proximal tubule Four mechanisms of Na^+ transport have been defined in this segment.

(a) Direct entry of Na^+ along a favourable electrochemical gradient. This is electrogenic.

(b) Transport of Na^+ and K^+ coupled to active reabsorption of glucose, amino acids, other organic anions and PO_4^{3-} through specific symporters. Only the glucose coupled Na^+ reabsorption is electrogenic.

(c) Exchange with H^+ : The PT cells secrete H^+ with the help of carbonic anhydrase (CAse), Fig. IX.2. H^+ ion exchanges with Na^+ present in tubular fluid through $\text{Na}^+\text{-H}^+$ antiporter located in the luminal membrane and forms H_2CO_3 by combining with HCO_3^- . This H_2CO_3 is broken into $\text{H}_2\text{O} + \text{CO}_2$ by brush border CAse; both CO_2 and H_2O diffuse inside the cell and recombine to form H_2CO_3 (intracellular CAse catalysed reaction) which is the source of H^+ . The dissociated HCO_3^- in the cell is transported to cortical e.c.f. by basolateral membrane $\text{Na}^+\text{-HCO}_3^-$ symporter resulting in net reabsorption of NaHCO_3 .

Practically all HCO_3^- is reabsorbed in PT by this mechanism, because tubular membrane, as such, is relatively impermeable to HCO_3^- .

(d) The disproportionately large HCO_3^- , acetate, PO_4^{3-} , amino acid and other anion reabsorption create passive driving forces for Cl^- to diffuse through the paracellular pathway (in between tubular cells), particularly in the later PT. This takes Na^+ and water along to maintain electrical neutrality and isotonicity; reabsorption in PT is isotonic.

Major part of filtered K^+ is reabsorbed in the PT. Thus, an isotonic tubular fluid with major changes in composition enters the thin descending limb of loop of Henle.

Site II: Ascending limb of loop of Henle (Asc LH) The thick AscLH can be distinguished into two distinct portions:

- (i) Medullary part lined by cuboidal cells.
- (ii) Cortical part lined by flattened cells.

Both portions are relatively impermeable to water but absorb salt actively and thus dilute the tubular fluid.

In the *medullary portion* a distinct luminal membrane carrier transports ions in the stoichiometric ratio of $\text{Na}^+\text{-K}^+\text{-2 Cl}^-$ (see Fig. 41.1), and is nonelectrogenic. The Na^+ that enters the cell is pumped to e.c.f. by $\text{Na}^+\text{K}^+\text{ATPase}$ at the basolateral membrane. In addition, a $\text{Na}^+\text{-Cl}^-$ symporter moves Cl^- down its electrochemical gradient into e.c.f. and carries Na^+ along. As the tubular fluid traverses AscLH it progressively becomes hypotonic. Accumulation of NaCl in the medullary interstitium without accompanying water makes it hypertonic: a corticomedullary osmotic gradient is set up. This draws in water from the descending limb of loop of Henle (this thin segment has high osmotic water permeability but lacks active NaCl transport) so that the fluid that enters AscLH becomes hypertonic. A 4 times higher osmolarity of medullary tip (papilla) is maintained by the hairpin structure of the loop of Henle acting as passive *counter current multiplier* and the arrangement of blood vessels as *vasa recti* with shunts

that prevents washing away of the osmotic gradient by progressively reducing blood flow to the inner medulla. Because of meagre blood supply, renal papilla is so prone to necrosis and suffers maximum damage when a toxic substance is being excreted.

Site III: Cortical diluting segment of loop of Henle This segment, also impermeable to water, continues to absorb salt, but here it is through a $\text{Na}^+\text{-Cl}^-$ symporter. Tubular fluid gets further diluted.

Site IV: Distal tubule (DT) and collecting duct (CD) In the late DT and CD, Na^+ is again actively reabsorbed; the cation-anion balance being maintained partly by passive Cl^- diffusion and partly by secretion of K^+ and H^+ . Absorption of Na^+ at this site occurs through a specific amiloride sensitive Na^+ channel and is controlled to a large extent by aldosterone (see Fig. 41.3). This provides fine tuning to electrolyte excretion according to body needs.

In common with other cells, the DT and CD cells are rich in K^+ ; a chemical gradient exists for its diffusion into tubular lumen which is aided by the lumen negative transepithelial potential difference in this part of the tubule. The luminal membrane possesses an active secretory pump for H^+ which is again governed by movement of Na^+ in the reverse direction. Any diuretic acting proximal to the aldosterone sensitive ion exchange site causes an increased delivery of Na^+ to the distal nephron—more exchange with K^+ takes place. Thus, K^+ is reabsorbed in the PT and AscLH, and is secreted in the DT and CD. The net K^+ loss is regulated by variations in the secretory process and depends on:

- (i) The Na^+ load delivered to distal segment
- (ii) Presence or absence of aldosterone
- (iii) Availability of H^+
- (iv) Intracellular K^+ stores

The characteristic feature of cells lining CD is their responsiveness to antidiuretic hormone (ADH). If ADH is absent, the hypotonic fluid entering CD is passed as such \rightarrow dilute urine is produced during water loading. If ADH levels

are high, CD cells become fully permeable to water \rightarrow equilibrate with hyperosmotic medulla \rightarrow concentrated urine is passed, as occurs during water deprivation or hypertonic saline infusion.

The CD and thin AscLH are the only segments permeable to urea. ADH promotes insertion of urea transporter (UT_1 or VRUT) into the luminal membrane of CD cells \rightarrow more urea is accumulated in the medullary interstitium, reinforcing the medullary hypertonicity during water deprivation.

Free water clearance It is defined as the volume of urine excreted per unit time in excess of that required to excrete the contained solute isoosmotically with plasma. It is positive when dilute urine is passed in the absence of ADH and negative when concentrated urine is passed in the presence of ADH. If isotonic urine is passed, regardless of its volume, free water clearance is zero.

Both positive and negative free water clearance are dependent on the production of a corticomedullary osmotic gradient; diuretics acting on medullary AscLH depress both.

Organic ion transport The PT has nonspecific bidirectional active transport mechanism, separately for organic acids and organic bases. However, the magnitude of transport in the two directions may vary from compound to compound, e.g. reabsorption of uric acid is generally more than its secretion, while in case of penicillin the converse is true. Important diuretics like furosemide, thiazides and amiloride utilize this transport to approach their site of action from the luminal side of the tubule in the AscLH/DT/CD.

Regulation of renal function

Glomerular filtration rate (g.f.r.) is dependent on the pumping action of heart, the magnitude of renal blood flow and the relative dimensions of afferent and efferent glomerular vessels. Thus, systemic and intrarenal haemodynamic changes can reflect in g.f.r.

About 80% nephrons lie in outer cortex, have short loops of Henle and low Na^+ reabsorptive capacity; while 20% or so are juxtamedullary, possess long loops of Henle and are largely responsible for creating the

corticomedullary osmotic gradient. Redistribution of blood flow between these two types of nephrons can alter salt and water excretion. Further, haemodynamic changes within different segments of renal vasculature can alter pressure relationships which govern flow of solute and water.

The renin-angiotensin-aldosterone system has a profound bearing on distal tubular reabsorption of Na^+ and secretion of K^+/H^+ . Angiotensin II produced locally in the kidney has direct effects on intrarenal vascular beds as well as on salt and water reabsorption.

Sympathetic stimulation of kidney results in renin release which would indirectly affect tubular transport. In addition, adrenergic drugs can directly enhance reabsorption of salt and water.

Prostaglandins (PGs) are produced locally in kidney; act as modulators of renal circulation and renin release. PGE_2 inhibits the action of ADH and has direct effects on tubular reabsorption.

A natriuretic hormone produced by the atrium (atrial natriuretic peptide: ANP) and may be other sites also has been found to be important in inducing natriuresis in response to salt and volume overload. It mediates 'escape' from long-term aldosterone action.

All nephrons are so arranged that the Asc LH passes close to the early PT of the same nephron. The macula densa cells are thus in close contact with afferent and efferent arterioles. This provides opportunity for feedback regulation of single unit function.

Relation to diuretic action

The relative magnitudes of Na^+ reabsorption at different tubular sites are:

PT 65–70%;	Asc LH 20–25%;
DT 8–9%;	CD 1–2%.

The maximal natriuretic response to a diuretic can give a clue to its site of action. It may appear that diuretics acting on PT should be the most efficacious. However, these agents are either too weak or cause distortion of acid-base balance (Case inhibitors). Further, their effect may be obscured by compensatory increase in reabsorption further down the nephron, because the reserve reabsorptive capacity of diluting segments is considerable and can overshadow more proximal actions.

A diuretic having primary action on medullary Asc LH (furosemide) can produce substantial effect because of limited capacity for salt absorption in DT and CD. This also explains why agents acting on DT and CD (K^+ sparing diuretics) evoke only mild saluretic effect. Diuretics acting on cortical diluting segment (thiazides) are intermediate between these two.

CHAPTER 41

Diuretics

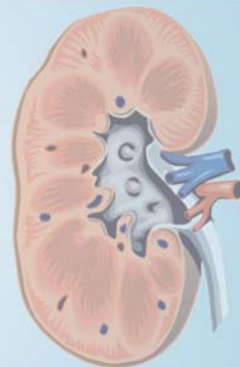

These are drugs which cause a net loss of Na^+ and water in urine.

Based on the diuretic action of calomel, organomercurials given by injection were introduced in the 1920s and dominated for nearly 40 years. The CAse inhibitors were developed in the 1950s from the observation that early sulfonamides caused acidosis and mild diuresis. The first modern orally active diuretic *chlorothiazide* was discovered in 1957, and by early 1960s its congeners (thiazide diuretics) were already in common use. Availability of *furosemide* and *ethacrynic acid* by mid 1960s revolutionized the pattern of diuretic use. The K^+ sparing diuretics *spironolactone* and *triamterene* were developed in parallel to these.

Diuretics are among the most widely prescribed drugs. Application of diuretics to the management of hypertension has outstripped their use in edema. Availability of diuretics has also had a major impact on the understanding of renal physiology.

CLASSIFICATION

1. High efficacy diuretics (Inhibitors of $\text{Na}^+ - \text{K}^+ - 2\text{Cl}^-$ cotransport)

Sulphamoyl derivatives

Furosemide, Bumetanide, Torasemide

2. Medium efficacy diuretics (Inhibitors of $\text{Na}^+ - \text{Cl}^-$ symport)

(a) Benzothiadiazines (thiazides)

Hydrochlorothiazide, Benzthiazide,

Hydroflumethiazide, Clopamide

(b) Thiazide like (related heterocyclics)

Chlorthalidone, Metolazone, Xipamide, Indapamide.

3. Weak or adjunctive diuretics

(a) Carbonic anhydrase inhibitors

Acetazolamide

(b) Potassium sparing diuretics

(i) Aldosterone antagonist: Spironolactone

(ii) Inhibitors of renal epithelial Na^+ channel: Triamterene, Amiloride.

(c) Osmotic diuretics

Mannitol, Isosorbide, Glycerol

Other high ceiling diuretics, viz. *ethacrynic acid* and organomercurials (*mersalyl*) are only historical.

HIGH CEILING (LOOP) DIURETICS

(Inhibitors of $\text{Na}^+ - \text{K}^+ - 2\text{Cl}^-$ Cotransport)

Furosemide (Frusemide) Prototype drug

The development of this orally and rapidly acting highly efficacious diuretic was a breakthrough. Its maximal natriuretic effect is much greater than that of other classes. The diuretic response goes on increasing with increasing dose: upto 10 L of urine may be produced in a day. It is active even in patients with relatively severe renal failure. The onset of action is prompt (i.v. 2–5 min., i.m. 10–20 min., oral 20–40 min.) and duration short (3–6 hours).

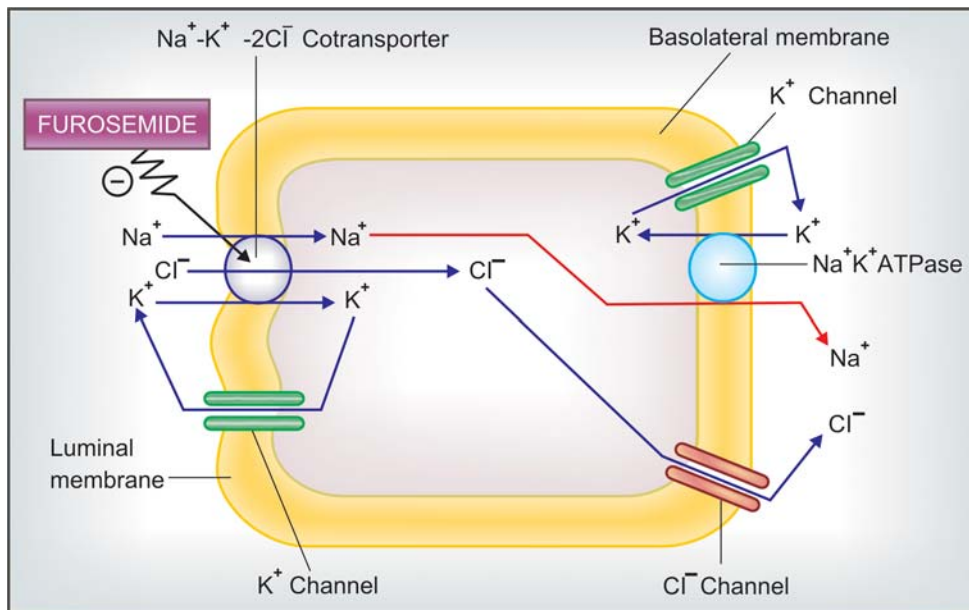

Fig. 41.1: Mechanism of salt reabsorption in the thick ascending limb of loop of Henle (AsclH) cell, and site of action of furosemide on the $\text{Na}^+\text{-K}^+\text{-2Cl}^-$ cotransporter

The major site of action is the thick AsclH (site II) where furosemide inhibits $\text{Na}^+\text{-K}^+\text{-2Cl}^-$ cotransport (Fig. 41.1). A minor component of action on PT has also been indicated. It is secreted in PT by organic anion transport and reaches AsclH where it acts from luminal side of the membrane. It abolishes the cortico-medullary osmotic gradient and blocks positive as well as negative free water clearance. K^+ excretion is increased mainly due to high Na^+ load reaching DT. However, at equinatriuretic doses, K^+ loss is less than that with thiazides.

Furosemide has weak CAse inhibitory action and increase HCO_3^- excretion as well; urinary pH may rise but the predominant urinary anion is Cl^- ; acidosis does not develop. Its action is independent of acid-base balance of the body and it causes little distortion of the same; mild alkalosis occurs at high doses.

In addition to its prominent tubular action, furosemide causes acute changes in renal and systemic haemodynamics. After 5 min of i.v. injection, renal blood flow is transiently

increased and there is redistribution of blood flow from outer to midcortical zone; g.f.r. generally remains unaltered due to compensatory mechanisms despite increased renal blood flow. Pressure relationship between vascular, interstitial and tubular compartments is altered, the net result of which is decreased PT reabsorption. The intrarenal haemodynamic changes are brought about by increased local PG synthesis.

Intravenous furosemide causes prompt increase in systemic venous capacitance and decreases left ventricular filling pressure, even before the saluretic response is apparent. This action also appears to be PG mediated and is responsible for the quick relief it affords in LVF and pulmonary edema.

Furosemide increases Ca^{2+} excretion (contrast thiazides which reduce it) as well as Mg^{2+} excretion. It tends to raise blood uric acid level by competing with its proximal tubular secretion as well as by increasing reabsorption in PT which is a consequence of reduced e.c.f. volume.

The magnitude of hyperuricaemia is lower than that with thiazides. Hyperglycaemic action of furosemide is also less marked than thiazides.

Molecular mechanism of action: A glycoprotein with 12 membrane spanning domains has been found to function as the $\text{Na}^+\text{-K}^+\text{-2Cl}^-$ cotransporter in many epithelia performing secretory/absorbing function, including AscLH. Recently, distinct *absorptive* or *secretory* isoforms of $\text{Na}^+\text{-K}^+\text{-2Cl}^-$ cotransporter have been isolated. The former is exclusively expressed at the luminal membrane of thick AscLH—furosemide attaches to the Cl^- binding site of this protein to inhibit its transport function. The secretory form is expressed on the basolateral membrane of most glandular and epithelial cells.

Pharmacokinetics Furosemide is rapidly absorbed orally but bioavailability is about 60%. In severe CHF oral bioavailability may be markedly reduced. Lipid-solubility is low, and it is highly bound to plasma proteins. It is partly conjugated with glucuronic acid and mainly excreted unchanged by glomerular filtration as well as tubular secretion. Some excretion in bile and directly in intestine also occurs. Plasma $t_{1/2}$ averages 1–2 hour but is prolonged in patients with pulmonary edema, renal and hepatic insufficiency.

Dose Usually 20–80 mg once daily in the morning. In renal insufficiency, upto 200 mg 6 hourly has been given by i.m./i.v. route. In pulmonary edema 40–80 mg may be given i.v.

LASIX 40 mg tab., 20 mg/2 ml inj. LASIX HIGH DOSE 500 mg tab, 250 mg/25 ml inj; (solution degrades spontaneously on exposure to light), SALINEX 40 mg tab, FRUSENEX 40, 100 mg tab.

Bumetanide It is similar to furosemide in all respects, but is 40 times more potent. It induces very rapid diuresis and is highly effective in pulmonary edema. However, the site of action, ceiling effect, renal haemodynamic changes and duration of action are similar to furosemide. A secondary action in PT has also been demonstrated. It may act in some cases not responding to furosemide. Hyperuricaemia, K^+ loss, glucose

intolerance and ototoxicity are claimed to be less than with furosemide. However, it may rarely cause myopathy.

Bumetanide is more lipid-soluble, 80–100% bioavailable orally, extensively bound to plasma proteins, partly metabolized and partly excreted unchanged in urine. Its accumulation in tubular fluid is less dependent on active secretion. Plasma $t_{1/2}$ ~60 min, gets prolonged in renal and hepatic insufficiency.

Dose: 1–5 mg oral OD in the morning, 2–4 mg i.m./i.v., (max. 15 mg/day in renal failure).

BUMET, 1 mg tab., 0.25 mg/ml inj.

Torsemide (Torsemide) Another high ceiling diuretic with properties similar to furosemide, but 3 times more potent. Oral absorption is more rapid and more complete. The elimination $t_{1/2}$ (3.5 hours) and duration of action (4–8 hours) are longer. Torsemide has been used in edema and in hypertension.

Dose: 2.5–5 mg OD in hypertension; 5–20 mg/day in edema; upto 100 mg BD in renal failure.

DIURETOR 10, 20 mg tabs, DYTOR 10, 20, 100 mg tabs.

Use of high ceiling diuretics

1. **Edema** Diuretics are used irrespective of etiology of edema—cardiac, hepatic or renal. The high ceiling diuretics are preferred in CHF for rapid mobilization of edema fluid (*see* Ch. 37). Thiazides may be used for maintenance, but often prove ineffective and high ceiling drugs are called in. For nephrotic and other forms of resistant edema, the high ceiling diuretics are the drugs of choice. In chronic renal failure massive doses have to be used, but they continue to be effective while thiazides just do not produce any action. In impending acute renal failure, loop diuretics may decrease the need for dialysis.

2. **Acute pulmonary edema (acute LVF, following MI):** Intravenous administration of furosemide or its congeners produces prompt relief. This is due to vasodilator action that precedes the saluretic action. Subsequently, decrease in blood volume and venous return is responsible for the improvement.

3. *Cerebral edema* Though osmotic diuretics are primarily used, furosemide may be combined to improve efficacy.

4. *Hypertension* High ceiling diuretics are indicated only in presence of renal insufficiency, CHF, in resistant cases or hypertensive emergencies; otherwise thiazides are preferred (*see* p. 540).

5. Along with blood transfusion in severe anaemia, to prevent vascular overload.

6. Hypercalcaemia and renal calcium stones: because furosemide and its congeners increase calcium excretion and urine flow, they may help to reduce serum calcium level. Excess salt that is lost must be replaced.

Forced diuresis with saline and furosemide infusion is no longer recommended to treat poisonings.

THIAZIDE AND RELATED DIURETICS

(Inhibitors of $\text{Na}^+\text{-Cl}^-$ symport)

Chlorothiazide was synthesized as a CAsE inhibitor variant which produced urine that was rich in Cl^- , and diuresis occurred in alkalosis as well as acidosis. A large number of congeners were developed subsequently and the thiazidine ring was replaced by other heterocyclic rings, but the type of activity remained the same. The important features of agents marketed in India are presented in Table 41.1.

These are medium efficacy diuretics with primary site of action in the cortical diluting segment or the early DT (Site III). Here they inhibit $\text{Na}^+\text{-Cl}^-$ symport at the luminal membrane. They do not affect the corticomedullary osmotic gradient indicating lack of action at the medullary thick AscLH. Positive free water clearance is reduced (very dilute urine cannot be passed in the absence of ADH), but negative free water clearance (in the presence of ADH) is not affected. This strengthens the view that the site of action is in between thick AscLH and late DT. These drugs gain access to their site of action *via* organic acid secretory pathway in PT and then along the tubular fluid to early DT, where they

bind to specific receptors located on the luminal membrane. Like the $\text{Na}^+\text{-K}^+\text{-2Cl}^-$ cotransporter, the $\text{Na}^+\text{-Cl}^-$ symporter is also a glycoprotein with 12 membrane spanning domains that binds thiazides but not furosemide or any other class of diuretics. It has been cloned and shown to be selectively expressed on the luminal membrane in the DT. The site of action of thiazide diuretics is shown in Fig. 41.2.

Some of the thiazides and related drugs have additional CAsE inhibitory action in PT; intensity of this action differs among different compounds (Table 41.1), but it is generally weak and clinically insignificant. However, it may confer some proximal tubular action to the compounds.

Under their action, increased amount of Na^+ is presented to the distal nephron, more of it exchanges with $\text{K}^+ \rightarrow$ urinary K^+ excretion is increased in parallel to the natriuretic response. The maximal diuresis induced by different agents falls in a narrow range; though potency (reflected in daily dose) differs markedly. Nevertheless, they are moderately efficacious diuretics because nearly 90% of the glomerular filtrate has already been reabsorbed before it reaches their site of action. They have a flat dose response curve; little additional diuresis occurs when the dose is increased beyond 100 mg of hydrochlorothiazide or equivalent. They do not cause significant alteration in acid-base balance of the body.

By their action to reduce blood volume, as also intrarenal haemodynamic changes, they tend to reduce g.f.r. This is one reason why thiazides are not effective in patients with low g.f.r. They decrease renal Ca^{2+} excretion and increase Mg^{2+} excretion by a direct distal tubular action. They also decrease urate excretion by the same mechanism as furosemide (*see* p. 562).

The *extrarenal actions* of thiazides consist of a slowly developing fall in BP in hypertensives and elevation of blood sugar in some patients due to decreased insulin release which probably is a consequence of hypokalaemia.

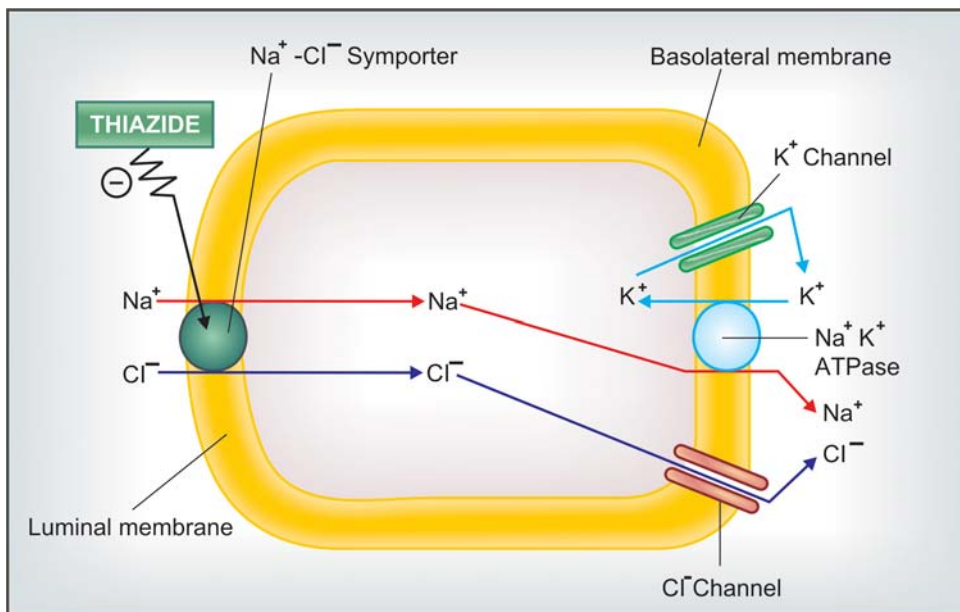

Fig. 41.2: Mechanism of salt reabsorption in early distal tubular cell and site of action of thiazide diuretics on Na^+Cl^- symporter

Pharmacokinetics All thiazides and related drugs are well absorbed orally; are administered only by this route. Their action starts within 1 hour, but the duration varies from 8–48 hours (Table 41.1). The more lipid-soluble agents have larger volumes of distribution (some are also tissue bound), lower rates of renal clearance and are longer acting. The protein binding is also variable. Most of the agents undergo little hepatic metabolism and are excreted as such. They are filtered at the glomerulus as well as secreted in the PT by organic anion transport. Tubular reabsorption depends on lipid solubility: the more soluble ones are highly reabsorbed—prolonging duration of action.

Chlorthalidone It is a particularly long acting agent with a $t_{1/2}$ 40–50 hours, used exclusively as antihypertensive.

Metolazone In common with loop diuretics, it is able to evoke a clinically useful response even in severe renal failure (g.f.r. ~ 15 ml/min), and has marked additive action when combined with

furosemide. An additional proximal tubular action has been demonstrated; PO_4 reabsorption that occurs in PT is inhibited. It is excreted unchanged in urine.

Xipamide It has a pronounced diuretic action similar to low doses of furosemide. Because of longer duration of action—hypokalemia is more prominent.

Indapamide It has little diuretic action in the usual doses, probably because it is highly lipid-soluble, is extensively metabolized and only small quantity of unchanged drug is present in the tubular fluid. However, it retains antihypertensive action and is used for that purpose only (see p. 542).

Uses

1. **Edema** Thiazides may be used for mild-to-moderate cases. For mobilization of edema fluid more efficacious diuretics are preferred, but thiazides may be considered for maintenance

Table 41.1: Thiazides and related diuretics

<i>Drug</i>	<i>Trade name (Tab. strength) (mg)</i>	<i>Daily dose (mg)</i>	<i>CAse inhibition</i>	<i>Duration of action (Hr)</i>
1. Hydrochlorothiazide	AQUAZIDE, HYDRIDE HYDRAZIDE (12.5, 25, 50 mg)	12.5–100	+	5–15
2. Benzthiazide	FOVANE (25)	25–100	++	12–18
3. Hydroflumethiazide	NACLEX (25)	25–100	±	12–18
4. Chlorthalidone	HYTHALTON (50,100)	50–100	++	48
5. Metolazone	XAROXOLYN (5, 10)	5–20	+	8–10
6. Xipamide	XIPAMID (20)	20–40	+	5–8
7. Indapamide	LORVAS (2.5)	2.5–5	–	12–24
8. Clopamide	BRINALDIX (20)	10–60	±	12–18

Some other compounds, similar in action, but are not available in India. Chlorexolone, Quinethazone, Mefruside—are nonthiazides.

therapy. They act best in cardiac edema, less effective in hepatic or renal edema. They are powerless in the presence of renal failure. Cirrhotics often develop refractoriness to thiazides due to development of secondary hyperaldosteronism.

2. *Hypertension* Thiazides and related diuretics, especially chlorthalidone are one of the first line drugs (Ch. 40).

3. *Diabetes insipidus* They reduce urine volume (*see* Ch. 42).

4. *Hypercalciuria* with recurrent calcium stones in the kidney. Thiazides act by reducing Ca^{2+} excretion.

Complications of high ceiling and thiazide type diuretic therapy

Most of the adverse effects of these drugs are related to fluid and electrolyte changes caused by them. They are remarkably safe in low doses used over short periods. Many subtle metabolic effects have been reported in their long-term use as antihypertensives at the relatively higher doses used in the past (*see* Ch. 40).

1. *Hypokalaemia* This is the most significant problem. It is rare at low doses, but may be of grave consequence when brisk diuresis is induced or on prolonged therapy, especially if dietary K^+ intake is low. Degree of hypokalaemia appears to be related to the duration of action of the diuretic; longer acting drugs causing more K^+ loss. The usual manifestations are weakness, fatigue, muscle cramps; cardiac arrhythmias are the serious complications. Hypokalaemia is less common with standard doses of high ceiling diuretics than with thiazides, possibly because of shorter duration of action of the former which permits intermittent operation of compensatory repletion mechanisms. It can be prevented and treated by:

- High dietary K^+ intake or
- Supplements of KCl (24–72 mEq/day) or
- Concurrent use of K^+ sparing diuretics.

Measures (b) and (c) are not routinely indicated, but only when hypokalaemia has been documented or in special risk situations, e.g. cirrhotics, cardiac patients—especially post MI, those receiving digitalis, antiarrhythmics, or tricyclic antidepressants and elderly patients.

Serum K^+ levels are only a rough guide to K^+ depletion, because K^+ is primarily an intracellular ion. Nevertheless, an attempt to maintain serum K^+ at or above 3.5 mEq/L should be made.

Combined tablets of diuretics and KCl are not recommended because:

- (a) they generally contain insufficient quantity of K^+ (8–12 mEq only).
- (b) may cause gut ulceration by releasing KCl at one spot.
- (c) K^+ is retained better if given after the diuresis is over.

K^+ sparing diuretics are more efficacious and more convenient in correcting hypokalaemia than are K^+ supplements. ACE inhibitors/AT₁ antagonists given with thiazides tend to prevent development of hypokalaemia.

Alkalosis may occur with hypokalaemia, because more H^+ exchanges with Na^+ in DT when less K^+ is available for exchange.

2. Acute saline depletion Over enthusiastic use of diuretics, particularly high ceiling ones, may cause dehydration and fall in BP (especially in erect posture). Serum Na^+ and Cl^- levels remain normal because isotonic saline is lost. It should be treated by saline infusion.

3. Dilutional hyponatraemia Occurs in CHF patients when vigorous diuresis is induced with high ceiling agents, rarely with thiazides. Kidney tends to retain water, though it is unable to retain salt due to the diuretic; e.c.f. gets diluted, hyponatraemia occurs and edema persists despite natriuresis. Patients feel very thirsty. Treatment of this distortion of fluid-electrolyte balance is difficult: withhold diuretics, restrict water intake and give glucocorticoid which enhances excretion of water load. If hypokalaemia is present, its correction helps.

4. GIT and CNS disturbances Nausea, vomiting and diarrhoea may occur with any diuretic. Headache, giddiness, weakness, paresthesias, impotence are occasional complaints with thiazides as well as loop diuretics.

5. Hearing loss Occurs rarely, only with high ceiling diuretics and when these drugs are used in the presence of renal insufficiency. Increased

salt content of endolymph and a direct toxic action on the hair cells in internal ear appear to be causative.

6. Allergic manifestations Rashes, photosensitivity occur, especially in patients hypersensitive to sulfonamides. Blood dyscrasias are rare; any diuretic may be causative.

7. Hyperuricaemia Long-term use of higher dose thiazides in hypertension has caused rise in blood urate level. This is uncommon now due to use of lower doses (*see* Ch. 40). Furosemide produces a lower incidence of hyperuricaemia. This effect can be counteracted by allopurinol. Probenecid is better avoided, because it may interfere with the diuretic response, particularly of loop diuretics.

8. Hyperglycaemia and hyperlipidemia Have occurred in the use of diuretics as antihypertensive (*see* Ch. 40). These metabolic changes are minimal at low doses now recommended.

9. Hypercalcaemia Occurs with thiazides, while *hypocalcaemia* occurs with high ceiling diuretics when these are administered chronically.

10. Magnesium depletion It may develop after prolonged use of thiazides as well as loop diuretics, and may increase the risk of ventricular arrhythmias, especially after MI or when patients are digitalized. K^+ sparing diuretics given concurrently minimise Mg^{2+} loss.

11. Thiazides have sometimes *aggravated renal insufficiency*, probably by reducing g.f.r.

12. Brisk diuresis induced in cirrhotics may precipitate *mental disturbances* and hepatic coma. It may be due to hypokalaemia, alkalosis and increased blood NH_3 levels.

13. Diuretics should not be used in *toxaemia of pregnancy* in which blood volume is low despite edema. Diuretics may further compromise placental circulation → miscarriage, foetal death. Thus, diuretics are contraindicated in pregnancy induced hypertension.

Interactions

1. Thiazides and high ceiling diuretics potentiate all other antihypertensives. This interaction is intentionally employed in therapeutics.
2. Hypokalaemia induced by these diuretics:
 - Enhances digitalis toxicity.
 - Increases the incidence of polymorphic ventricular tachycardia due to quinidine and other antiarrhythmics.
 - Potentiates competitive neuromuscular blockers and reduces sulfonylurea action.
3. High ceiling diuretics and aminoglycoside antibiotics are both ototoxic and nephrotoxic; produce additive toxicity; should be used together cautiously.
4. Cotrimoxazole given with diuretics has caused higher incidence of thrombocytopenia.
5. Indomethacin and other NSAIDs diminish the action of high ceiling diuretics. Inhibition of PG synthesis in the kidney, through which furosemide and related drugs induce intrarenal haemodynamic changes which secondarily affect salt output, appears to be the mechanism. Antihypertensive action of thiazides and furosemide is also diminished by NSAIDs.
6. Probenecid competitively inhibits tubular secretion of furosemide and thiazides: decreases their action by reducing the concentration in the tubular fluid, while diuretics diminish uricosuric action of probenecid.
7. Serum lithium level rises when diuretic therapy is instituted. This is due to enhanced reabsorption of Li^+ (and Na^+) in PT.

Resistance to high ceiling diuretics Refractoriness (progressive edema despite escalating diuretic therapy) is more common with thiazides, but occurs under certain circumstances with high ceiling diuretics as well. The causes and mechanism of such resistance include:

<i>Cause</i>	<i>Mechanism</i>
1. Renal insufficiency (including advanced age)	Decreased access of diuretic to its site of action due to low g.f.r. and low proximal tubular secretion.
2. Nephrotic syndrome	Binding of diuretic to urinary protein, other pharmacodynamic causes.
3. Cirrhosis of liver	Abnormal pharmacodynamics; hyperaldosteronism; mechanism not clear.
4. CHF	Impaired oral absorption due to intestinal congestion, decreased renal blood flow and glomerular filtration, increased salt reabsorption in PT.

Long-term use of loop diuretics causes distal nephron hypertrophy → resistance. Addition of metolazone, or to some extent a thiazide, which act on distal tubule overcome the refractoriness in many cases. Further increase in dose and/or fractionation of daily dose may restart diuresis. Bedrest may also help.

CARBONIC ANHYDRASE INHIBITORS

Carbonic anhydrase (CAse) is an enzyme which catalyses the reversible reaction $\text{H}_2\text{O} + \text{CO}_2 \rightleftharpoons \text{H}_2\text{CO}_3$. Carbonic acid spontaneously ionizes $\text{H}_2\text{CO}_3 \rightleftharpoons \text{H}^+ + \text{HCO}_3^-$ (Fig. IX.2). Carbonic anhydrase thus functions in CO_2 and HCO_3^- transport and in H^+ ion secretion. The enzyme is present in renal tubular cell (especially PT) gastric mucosa, exocrine pancreas, ciliary body of eye, brain and RBC. In these tissues a gross excess of CAse is present, more than 99% inhibition is required to produce effects.

Acetazolamide

It is a sulfonamide derivative which noncompetitively but reversibly inhibits CAse in PT cells resulting in slowing of hydration of CO_2 → decreased availability of H^+ to exchange with luminal Na^+ through the $\text{Na}^+\text{-H}^+$ antiporter. Inhibition of brush border CAse retards dehydration of H_2CO_3 in the tubular fluid so that less CO_2 diffuses back into the cells. The net effect is inhibition of HCO_3^- (and accompanying Na^+)

reabsorption in PT → prompt but mild alkaline diuresis ensues.

Secretion of H^+ in DT and CD is also inhibited. Though H^+ is secreted at this site by a H^+ -ATPase, it is generated in the cell by CAse mediated reaction. As such, this is a subsidiary site of action of CAse inhibitors. When CAse inhibitors are given, the distal Na^+ exchange takes place only with K^+ which is lost in excess. For the same degree of natriuresis CAse inhibitors cause the most marked kaliuresis compared to other diuretics. The urine produced under acetazolamide action is alkaline and rich in HCO_3^- which is matched by both Na^+ and K^+ . Continued action of acetazolamide depletes body HCO_3^- and causes acidosis; less HCO_3^- (on which its diuretic action depends) is filtered at the glomerulus → self-limiting diuretic action. The extrarenal actions of acetazolamide are:

- (i) Lowering of intraocular tension due to decreased formation of aqueous humour (it is rich in HCO_3^-).
- (ii) Decreased gastric HCl and pancreatic $NaHCO_3$ secretion: This action requires very high doses—clinically not significant.
- (iii) Raised level of CO_2 in brain and lowering of pH → sedation and elevation of seizure threshold.
- (iv) Alteration of CO_2 transport in lungs and tissues: these actions are masked by compensatory mechanisms.

Pharmacokinetics Acetazolamide is well absorbed orally and excreted unchanged in urine. Action of a single dose lasts 8–12 hours.

Uses Because of self-limiting action, production of acidosis and hypokalaemia, acetazolamide is not used as diuretic. Its current clinical uses are:

1. Glaucoma: as adjuvant to other ocular hypotensives (*see* Ch. 10).
2. To alkalinise urine: for urinary tract infection or to promote excretion of certain acidic drugs.
3. Epilepsy: as adjuvant in absence seizures when primary drugs are not fully effective.

4. Acute mountain sickness: for symptomatic relief as well as prophylaxis. Benefit occurs probably due to reduced CSF formation as well as lowering of CSF and brain pH.

5. Periodic paralysis.

Dose: 250 mg OD–BD; **DIAMOX**, **SYNOMAX** 250 mg tab. **IOPAR-SR** 250 mg SR cap.

Adverse effects are frequent.

Acidosis, hypokalaemia, drowsiness, paresthesias, fatigue, abdominal discomfort.

Hypersensitivity reactions—fever, rashes.

Bone marrow depression is rare but serious.

It is contraindicated in liver disease: may precipitate hepatic coma by interfering with urinary elimination of NH_3 (due to alkaline urine).

Acidosis is more likely to occur in patients of COPD.

Some topical CAse inhibitors have been introduced for use in glaucoma (*see* Ch. 10).

POTASSIUM SPARING DIURETICS

These are either aldosterone antagonist or directly inhibit Na^+ channels in DT and CD cells to indirectly conserve K^+ .

Spironolactone (Aldosterone antagonist)

It is a steroid, chemically related to the mineralocorticoid aldosterone. Aldosterone acts on the late DT and CD cells (Fig. 41.3) by combining with an intracellular mineralocorticoid receptor → induces the formation of ‘aldosterone-induced proteins’ (AIPs) which promote Na^+ reabsorption by a number of mechanisms (*see* legend to Fig. 41.3) and K^+ secretion. Spironolactone acts from the interstitial side of the tubular cell, combines with the mineralocorticoid receptor and inhibits the formation of AIPs in a competitive manner. It has no effect on Na^+ and K^+ transport in the absence of aldosterone, while under normal circumstances, it increases Na^+ and decreases K^+ excretion.

Spironolactone is a mild saluretic because majority of Na^+ has already been reabsorbed proximal to its site of action. However, it

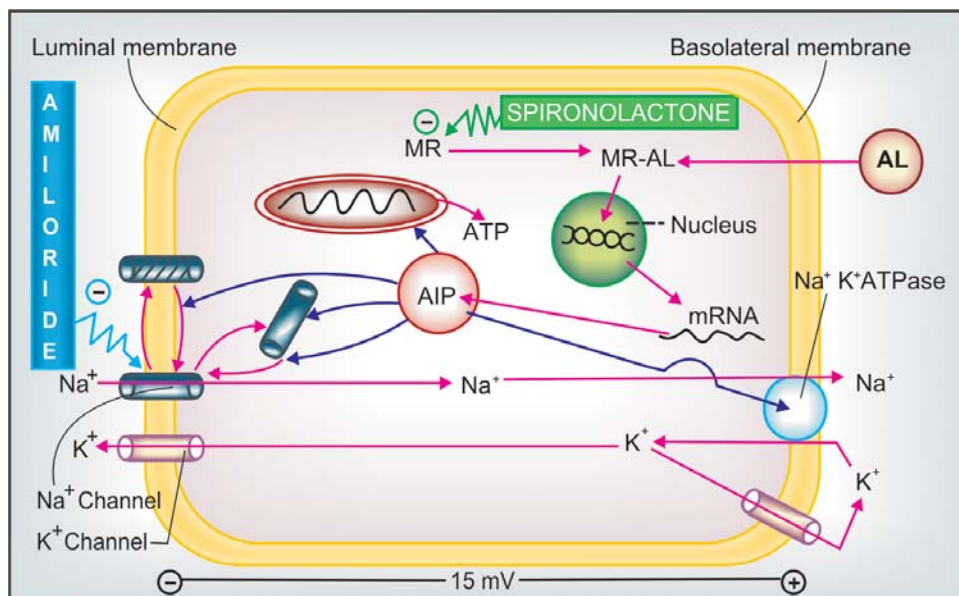

Fig. 41.3: Site and mechanism of action of potassium sparing diuretics on the late distal tubule/collecting duct cell. Aldosterone (AL) penetrates the cell from the interstitial side and combines with the mineralocorticoid receptor (MR). The complex translocates to the nucleus—promotes gene mediated mRNA synthesis. The mRNA then directs synthesis of aldosterone induced proteins (AIPs). The AIPs include Na^+K^+ ATPase and amiloride sensitive Na^+ channels. The AIPs also activate Na^+ channel, translocate Na^+ channels from cytosolic site to luminal membrane and Na^+K^+ ATPase to basolateral membrane, increase ATP production by mitochondria. All these changes promote Na^+ reabsorption—more K^+ and H^+ is secreted indirectly. Spironolactone binds to MR, prevents AL action and produces opposite effects.

Amiloride approaches the Na^+ channel from the luminal side and blocks it—reducing the lumen negative transepithelial potential difference which governs K^+ and H^+ secretion.

antagonises K^+ loss induced by other diuretics and slightly adds to their natriuretic effect. The K^+ retaining action develops over 3–4 days. It increases Ca^{2+} excretion by a direct action on renal tubules.

Pharmacokinetics The oral bioavailability of spironolactone from microfine powder tablet is 75%. It is highly bound to plasma proteins and completely metabolized in liver; converted to active metabolites, the most important of which is *Canrenone* that is responsible for 1/2–2/3 of its action *in vivo*. The $t_{1/2}$ of spironolactone is 1–2 hours, while that canrenone is ~18 hours. It undergoes some enterohepatic circulation.

Dose: 25–50 mg BD–QID;

ALDACTONE 25, 100 mg tabs.

ALDACTIDE: Spironolactone 25 mg + hydroflumethiazide 25 mg tab. LACILACTONE, SPIROMIDE: Spironolactone 50 mg + furosemide 20 mg tab.

Use Spironolactone is a weak diuretic in its own right and is used only in combination with other more efficacious diuretics.

1. Edema: It is more useful in cirrhotic and nephrotic edema: aldosterone levels are generally high. It breaks the resistance to thiazide diuretics that develops due to secondary hyperaldosteronism and reestablishes the response. Thus, it is particularly employed in refractory edema.
2. To counteract K^+ loss due to thiazide and loop diuretics.
3. Hypertension: Used only as adjuvant to thiazide to prevent hypokalaemia; has weak antihypertensive action of its own.
4. CHF: As additional drug to conventional therapy in moderate to severe CHF; can retard disease progression and lower mortality (*see p. 506*).

Interactions

1. Given together with K⁺ supplements—dangerous hyperkalaemia can occur.
2. Aspirin blocks spironolactone action by inhibiting tubular secretion of canrenone.
3. More pronounced hyperkalaemia can occur in patients receiving ACE inhibitors/angiotensin receptor blockers (ARBs).
4. Spironolactone increases plasma digoxin concentration.

Adverse effects The side effects are drowsiness, confusion, abdominal upset, hirsutism, gynaecomastia, impotence and menstrual irregularities. Most serious is hyperkalaemia that may occur especially if renal function is inadequate. Acidosis is a risk, particularly in cirrhotics. Peptic ulcer may be aggravated.

Eplerenone is a recently developed more selective aldosterone antagonist, that is less likely to cause hormonal disturbances like gynaecomastia, impotence and menstrual irregularities.

Inhibitors of renal epithelial Na⁺ channel

Triamterene and amiloride are two nonsteroidal organic bases with identical actions. Their most important effect is to decrease K⁺ excretion, particularly when it is high due to large K⁺ intake or use of a diuretic that enhances K⁺ loss. This is accompanied by a small increase in Na⁺ excretion. The excess urinary Na⁺ is matched by Cl⁻ and variable amounts of HCO₃⁻; urine is slightly alkalinized. The effect on urinary electrolyte pattern is superficially similar to spironolactone, but their action is independent of aldosterone.

Mechanism of action The luminal membrane of late DT and CD cells expresses a distinct 'amiloride sensitive' or 'renal epithelial' Na⁺ channel through which Na⁺ enters the cell down its electrochemical gradient which is generated by Na⁺K⁺ ATPase operating at the basolateral membrane (Fig. 41.3). This Na⁺ entry partially depolarizes the luminal membrane creating a

-15 mV transepithelial potential difference which promotes secretion of K⁺ into the lumen through K⁺ channels. Though there is no direct coupling between Na⁺ and K⁺ channels, more the delivery of Na⁺ to the distal nephron—greater is its entry through the Na⁺ channel—luminal membrane is depolarized more—driving force for K⁺ secretion is augmented. As such, all diuretics acting proximally (loop diuretics, thiazides, CAse inhibitors) promote K⁺ secretion. Amiloride and triamterene block the luminal Na⁺ channels—indirectly inhibit K⁺ excretion, while the net excess loss of Na⁺ is minor (most of it has already been reabsorbed).

The intercalated cells in CD possess an ATP driven H⁺ pump which secretes H⁺ ions into the lumen. This pump is facilitated by lumen negative potential. Amiloride, by reducing the lumen negative potential, decreases H⁺ ion secretion as well; predisposes to acidosis.

Both triamterene and amiloride are used in conjunction with thiazide type or high ceiling diuretics: prevent hypokalaemia and slightly augment the natriuretic and antihypertensive response. Risk of hyperkalaemia is the most important adverse effect of amiloride and triamterene. These drugs should not be given with K⁺ supplements; dangerous hyperkalaemia may develop. Hyperkalaemia is also more likely in patients receiving ACE inhibitors/ARBs, β blockers, NSAIDs and in those with renal impairment.

Both drugs elevate plasma digoxin levels.

Triamterene It is incompletely absorbed orally, partly bound to plasma proteins, largely metabolized in liver to an active metabolite and excreted in urine. Plasma t_{1/2} is 4 hours, effect of a single dose lasts 6–8 hours.

Side effects are infrequent: consist of nausea, dizziness, muscle cramps and rise in blood urea. Impaired glucose tolerance and photosensitivity are reported, but urate level is not increased.

Dose: 50–100 mg daily; **DITIDE**, triamterene 50 mg + benzthiazide 25 mg tab; **FRUSEMENE**, triamterene 50 mg + furosemide 20 mg tab.

Amiloride It is 10 times more potent than triamterene (dose 5–10 mg OD–BD). At higher doses it also inhibits Na⁺ reabsorption in PT, but this is clinically insignificant. It decreases Ca²⁺ excretion and increases urate excretion. Thus, hypercalcaemic action of thiazides is augmented but hyperuricaemic action is partly annulled. A mild antihypertensive action is also reported.

Only ¼ of an oral dose is absorbed. It is not bound to plasma proteins and not metabolized. The t½ (10–20 hours) and duration of action are longer than triamterene.

BIDURET, KSPAR: Amiloride 5 mg + hydrochlorothiazide 50 mg tab, **LASIRIDE**, **AMIMIDE** amiloride 5 mg + furosemide 40 mg tab.

Usual side effects are nausea, diarrhoea and headache.

Amiloride blocks entry of Li⁺ through Na⁺ channels in the CD cells and mitigates diabetes insipidus induced by lithium.

Given as an aerosol it affords symptomatic improvement in cystic fibrosis by increasing fluidity of respiratory secretions.

OSMOTIC DIURETICS

Mannitol

Mannitol is a nonelectrolyte of low molecular weight (182) that is pharmacologically inert—can be given in large quantities sufficient to raise osmolality of plasma and tubular fluid. It is not metabolized in the body; freely filtered at the glomerulus and undergoes limited reabsorption: therefore excellently suited to be used as osmotic diuretic. Mannitol appears to limit tubular water and electrolyte reabsorption in a variety of ways:

1. Retains water isoosmotically in PT—dilutes luminal fluid which opposes NaCl reabsorption.
2. Inhibits transport processes in the thick AscLH by an unknown mechanism. Quantitatively this appears to be the most important cause of diuresis.
3. Expands extracellular fluid volume (because it does not enter cells, mannitol

draws water from the intracellular compartment)—increases g.f.r. and inhibits renin release.

4. Increases renal blood flow, especially to the medulla—medullary hypertonicity is reduced—corticomedullary osmotic gradient is dissipated—passive salt reabsorption is reduced.

Though the primary action of mannitol is to increase urinary volume, excretion of all cations and anions is also enhanced.

Administration Mannitol is not absorbed orally; has to be given i.v. as 10–20% solution. It is excreted with a t½ of 0.5–1.5 hour.

MANNITOL 10%, 20%, in 100, 350 and 500 ml vac.

Uses Mannitol is never used for the treatment of chronic edema or as a natriuretic. Its indications are:

1. Increased intracranial or intraocular tension (acute congestive glaucoma, head injury, stroke, etc.): by osmotic action it encourages movement of water from brain parenchyma, CSF and aqueous humour; 1–1.5 g/kg is infused over 1 hour as 20% solution to transiently raise plasma osmolality. It is also used before and after ocular/brain surgery to prevent acute rise in intraocular/intracranial pressure.
2. To maintain g.f.r. and urine flow in impending acute renal failure, e.g. in shock, severe trauma, cardiac surgery, haemolytic reactions: 500–1000 ml of the solution may be infused over 24 hours. However, prognostic benefits in conditions other than cardiac surgery are still unproven. If acute renal failure has already set in, kidney is incapable of forming urine even after an osmotic load; mannitol is contraindicated: it will then expand plasma volume → pulmonary edema and heart failure may develop.
3. To counteract low osmolality of plasma/e.c.f. due to rapid haemodialysis or peritoneal dialysis (dialysis disequilibrium).

Table 41.2: Urinary electrolyte pattern and natriuretic efficacy of some diuretics

Diuretic	Urinary electrolyte excretion				Max. % of filtered Na ⁺ excreted	Efficacy
	Na ⁺	K ⁺	Cl ⁻	HCO ₃ ⁻		
1. Furosemide	↑↑↑	↑	↑↑	↑,-	25%	High
2. Thiazide	↑↑	↑	↑	↑	8%	Intermediate
3. Acetazolamide	↑	↑↑	↑,-	↑↑	5%	Mild
4. Spironolactone	↑	↓	↑	-,↑	3%	Low
5. Amiloride	↑	↓	↑	-,↑	3%	Low
6. Mannitol	↑↑	↑	↑	↑	20%	High

Mannitol along with large volumes of saline was infused i.v. to produce 'forced diuresis' in acute poisonings in the hope of enhancing excretion of the poison. However, this has been found to be ineffective and to produce electrolyte imbalances. Not recommended now.

Mannitol is *contraindicated* in acute tubular necrosis, anuria, pulmonary edema; acute left ventricular failure, CHF, cerebral haemorrhage.

Headache due to hyponatraemia is common, nausea and vomiting may occur; hypersensitivity reactions are rare.

Isosorbide and glycerol These are orally active osmotic diuretics which may be used to reduce intraocular or intracranial tension. Intravenous glycerol can cause haemolysis.

Dose: 0.5–1.5 g/kg as oral solution.

CHAPTER 42

Antidiuretics



These are drugs that reduce urine volume, particularly in *diabetes insipidus* (DI) which is their primary indication. Drugs are:

1. Antidiuretic hormone (ADH, Vasopressin),
Desmopressin, Lypressin, Terlipressin
2. Thiazide diuretics, Amiloride.
3. Miscellaneous: Indomethacin,
Chlorpropamide, Carbamazepine.

ANTIDIURETIC HORMONE

It is a nonapeptide secreted by posterior pituitary (neurohypophysis) along with oxytocin (*see* Ch. 23). It is synthesized in the hypothalamic (supraoptic and paraventricular) nerve cell bodies as a large precursor peptide along with its binding protein 'neurophysin', and is transported down the axons to nerve endings in the median eminence and pars nervosa. Osmoreceptors present in hypothalamus and volume receptors present in left atrium, ventricles and pulmonary veins primarily regulate the rate of ADH release governed by body hydration. Impulses from baroreceptors and higher centres also impinge on the nuclei synthesizing ADH and affect its release. The two main physiological stimuli for ADH release are rise in plasma osmolarity and contraction of e.c.f. volume.

ADH secretion is enhanced by angiotensin II, prostaglandins (PGs), histamine, neuropeptide Y and ACh. It is inhibited by GABA and atrial natriuretic peptide (ANP). Opioids have agent-specific action: while morphine stimulates ADH secretion, endogenous opioid peptides are mostly inhibitory. These humoral mediators may play a role in the modulation of ADH secretion.

The mammalian ADH is *8-arginine*-vasopressin (AVP); *8-lysine*-vasopressin (lypressin) is found in swine and has been synthetically prepared. Other more potent and longer acting peptide analogues of ADH having agonistic as well as antagonistic action have been prepared.

ADH (Vasopressin) receptors

These are G protein coupled cell membrane receptors; two subtypes V_1 and V_2 have been identified, cloned and structurally characterized.

V_1 Receptors All vasopressin receptors except those on renal CD cells and some blood vessels are of the V_1 type. These are further divided into:

V_{1a} present on vascular and other smooth muscles, platelets, liver, etc. and V_{1b} localized to the anterior pituitary.

The V_1 receptors function mainly through the phospholipase C-IP₃/DAG pathway—release Ca^{2+} from intracellular stores—causing vasoconstriction, visceral smooth muscle contraction, glycogenolysis, platelet aggregation, ACTH release, etc. These actions are augmented by enhanced influx of Ca^{2+} through Ca^{2+} channels as well as by DAG mediated protein kinase C activation which phosphorylates relevant proteins. V_1 receptors, in addition, activate phospholipase A₂—release

arachidonic acid resulting in generation of PGs and other eicosanoids which contribute to many of the V_1 mediated effects. Persistent V_1 receptor stimulation activates protooncogenes (possibly through IP_3 /DAG pathway) resulting in growth of vascular smooth muscle and other responsive cells.

V_2 Receptors These are located primarily on the collecting duct (CD) cells in the kidney—regulate their water permeability through cAMP production. Vasodilatory V_2 receptors are present in blood vessels.

The V_2 receptors are more sensitive (respond at lower concentrations) to ADH than are V_1 receptors. Selective peptide agonists and antagonists of the subtypes of vasopressin receptors are:

	Selective agonist
V_{1a} Receptor	[Phe ² , Ile ² , Orn ⁸] AVP
V_{1b} Receptor	Deamino [D-3 {pyridyl}-Ala ²] AVP
V_2 Receptor	Desmopressin (dDAVP)
	Selective antagonist
V_{1a} Receptor	d(CH ₂) ₅ [Tyr (Me ²)] AVP
V_{1b} Receptor	dp [Tyr (me ²)] AVP
V_2 Receptor	d(CH ₂) ₅ [D-Ile ² , Ile ⁴ , Ala-NH ₂ ⁹] AVP

Some orally active nonpeptide V_{1a} and V_2 receptor antagonists have been produced and are under clinical trial.

Actions

Kidney AVP acts on the collecting duct (CD) cells to increase their water permeability—water from the lumen diffuses to the interstitium by equilibrating with the hyperosmolar renal medulla (see Fig. IX.1). In man, maximal osmolarity of urine that can be attained is 4 times higher than plasma. When ADH is absent, CD cells remain impermeable to water → dilute urine (produced by the diluting segment) is passed as such. Graded effect occurs at lower concentration of ADH: urine volume closely balances fluid intake.

Mechanism of action The V_2 subtype of ADH receptors are present on the basolateral side of CD cell membrane. Activation of these receptors increases cAMP formation intracellularly → activation of cAMP dependent protein kinase A → phosphorylation of relevant proteins which promote exocytosis of 'aquaporin-2' water channel containing vesicles (WCVs) through the apical membrane → more aqueous channels get inserted

into the apical membrane. The rate of endocytosis and degradation of WCVs is concurrently reduced. The water permeability of CD cells is increased in proportion to the population of aquaporin-2 channels in the apical membrane at any given time. Continued V_2 receptor stimulation (during chronic water deprivation) in addition upregulates aquaporin-2 synthesis through cAMP response element of the gene encoding aquaporin-2.

Other aquaporins like aquaporin-1 (in PT) and aquaporin-3,4 (on basolateral membrane of CD cells) also participate in water transport at these sites.

To achieve maximum concentration of urine, activation of V_2 receptors increases urea permeability of terminal part of CDs by stimulating a vasopressin regulated urea transporter (VRUT or UT-1)—which in turn augments medullary hypertonicity. Recently, V_2 receptor mediated actions of AVP on AscLH have been demonstrated which further reinforce medullary hypertonicity by activating the $Na^+K^+2Cl^-$ cotransporter in the short-term and increasing its synthesis in the long-term.

The V_1 receptors also participate in the renal response to ADH. While V_{1a} receptor activation constricts vasa recta to diminish blood flow to inner medulla which will help in maintaining high osmolarity in this region and thus contribute to antidiuresis; other V_1 actions augmenting PG production from interstitial cells and directly diminishing responsiveness of CD cells to V_2 receptor stimulation tend to restrain V_2 mediated water permeability. Since V_2 action is produced at much lower concentration of AVP, physiologically V_1 renal actions may serve to restrict V_2 effect when blood levels of AVP are very high.

Lithium and demeclocycline partially antagonize ADH action (probably by limiting cAMP formation), reduce the urine concentrating ability of the kidney, produce polyuria and polydipsia. They have been used in patients with inappropriate ADH secretion. On the other hand NSAIDs (especially indomethacin) augment AVP induced antidiuresis by inhibiting renal PG synthesis. Carbamazepine and chlorpropamide also potentiate AVP.

Blood vessels AVP constricts blood vessels through V_1 receptors and can raise BP (hence the name vasopressin), but much higher concentration is needed than for maximal antidiuresis. The cutaneous, mesenteric, skeletal muscle, fat depot, thyroid, and coronary beds are particularly constricted. Though vasoconstrictor action of AVP does not appear to be physiologically important, some recent studies indicate that it may play a role in CHF, haemorrhage, hypotensive states, etc. Prolonged exposure to AVP causes vascular smooth muscle hypertrophy.

The V_2 receptor mediated vasodilatation can be unmasked when AVP is administered in the presence of a V_1 antagonist. It can also be demonstrated by the use of selective V_2 agonist desmopressin, and appears to be EDRF (NO) mediated.

Other actions Most visceral smooth muscles contract. Increased peristalsis in gut (especially large bowel), evacuation and expulsion of gases may occur.

Uterus is contracted by AVP acting on oxytocin receptors. In the nonpregnant and early pregnancy uterus, AVP is equipotent to oxytocin. Only at term sensitivity to oxytocin increases selectively.

CNS Exogenously administered AVP does not penetrate blood-brain barrier. However, it is now recognized as a peptide neurotransmitter in many areas of brain and spinal cord: may be involved in regulation of temperature, circulation, ACTH release, and in learning of tasks.

AVP induces platelet aggregation and hepatic glycogenolysis. It releases coagulation factor VIII and von Willebrand's factor from vascular endothelium through V_2 receptors.

Pharmacokinetics AVP is inactive orally because it is destroyed by trypsin. It can be administered by any parenteral route or by intranasal application. The peptide chain of AVP is rapidly cleaved enzymatically in many organs, especially in liver and kidney; plasma $t_{1/2}$ is short

~25 min. However, the action of aqueous vasopressin lasts 3–4 hours.

Aqueous vasopressin (AVP) inj: **POSTACTON 10 U inj**; for i.v., i.m. or s.c. administration.

VASOPRESSIN ANALOGUES

Lypressin It is 8-lysine vasopressin. Though somewhat less potent than AVP, it acts on both V_1 and V_2 receptors and has longer duration of action (4–6 hours). It is being used in place of AVP—mostly for V_1 receptor mediated actions.

PETRESIN, VASOPIN 20 IU/ml inj; 10 IU i.m. or s.c. or 20 IU diluted in 100–200 ml of dextrose solution and infused i.v. over 10–20 min.

Terlipressin This synthetic prodrug of vasopressin is specifically used for bleeding esophageal varices; may produce less severe adverse effects than lypressin.

Dose: 2 mg i.v., repeat 1–2 mg every 4–6 hours as needed. **GLYPRESSIN 1 mg freeze dried powder with 5 ml diluent for inj.**

Desmopressin (dDAVP) This synthetic peptide is a selective V_2 agonist; 12 times more potent antidiuretic than AVP, but has negligible vasoconstrictor activity. It is also longer acting because enzymatic degradation is slow; $t_{1/2}$ 1–2 hours; duration of action 8–12 hours. Desmopressin is the preparation of choice for all V_2 receptor related indications. The intranasal route is preferred, though bioavailability is only 10–20%. An oral formulation has been recently marketed with a bioavailability of 1–2%; oral dose is 10–15 times higher than intranasal dose, but systemic effects are produced and nasal side effects are avoided. Most patients find oral tablet more convenient.

Dose: Intranasal: Adults 10–40 μ g/day in 2–3 divided doses, children 5–10 μ g at bed time.

Oral: 0.1–0.2 mg TDS.

Parenteral (s.c. or i.v.): 2–4 μ g/day in 2–3 divided doses.

MINIRIN 100 μ g/ml nasal spray (10 μ g per actuation); 100 μ g/ml intranasal solution in 2.5 ml bottle with applicator; 0.1 mg tablets; 4 μ g/ml inj.

Uses

A. Based on V_2 actions (Desmopressin is the drug of choice)

1. **Diabetes insipidus** DI of pituitary origin (neurogenic) is the most important indication for vasopressin. It is ineffective in renal (nephrogenic) DI, since kidney is unresponsive to ADH. Life-long therapy is required, except in some cases of head injury or neurosurgery, where DI occurs transiently.

The dose of desmopressin is individualized by measuring 24 hour urine volume. Aqueous vasopressin or lypressin injection is impracticable for long-term treatment. It can be used in transient DI and to differentiate neurogenic from nephrogenic DI—urine volume is reduced and its osmolarity increased if DI is due to deficiency of ADH, but not when it is due to unresponsiveness of kidney to ADH. Desmopressin 2 µg i.m. is the preparation of choice now for the same purpose.

2. **Bedwetting in children and nocturia in adults** Intranasal or oral desmopressin at bedtime controls primary nocturia by reducing urine volume. Nocturnal voids are reduced to nearly half and first sleep period in adults is increased by ~2 hr. Fluid intake must be restricted 1 hr before and till 8 hr after the dose to avoid fluid retention. Monitor BP and body weight periodically to check fluid overload. Withdraw for one week every 3 months for reassessment.

3. **Renal concentration test** 5–10 U i.m. of aqueous vasopressin or 2 µg of desmopressin causes maximum urinary concentration.

4. **Haemophilia, von Willebrand's disease** AVP may check bleeding by releasing coagulation factor VIII and von Willebrand's factor. Desmopressin is the preferred preparation in a dose of 0.3 µg/kg diluted in 50 ml saline and infused i.v. over 30 min.

B. Based on V₁ actions

1. **Bleeding esophageal varices** Vasopressin/terlipressin often stop bleeding by constricting mesenteric blood vessels and reducing blood flow through the liver to the varices, allowing clot formation. Terlipressin stops bleeding in ~80% and has been shown to improve survival. It has

replaced AVP because of fewer adverse effects and greater convenience in use. Octreotide (a somatostatin analogue) injected i.v. is an alternative. However, definitive therapy of varices remains endoscopic obliteration by sclerotherapy.

2. **Before abdominal radiography** AVP/lypressin has been occasionally used to drive out gases from bowel.

Adverse effects Because of V₂ selectivity desmopressin produces fewer adverse effects than vasopressin, lypressin or terlipressin. However, transient headache and flushing are frequent.

Nasal irritation, congestion, rhinitis, ulceration and epistaxis can occur on local application. Systemic side effects are: belching, nausea, abdominal cramps, pallor, urge to defecate, backache in females (due to uterine contraction). Fluid retention and hyponatraemia may develop.

AVP can cause bradycardia, increase cardiac afterload and precipitate angina by constricting coronary vessels. It is contraindicated in patients with ischaemic heart disease, hypertension, chronic nephritis and psychogenic polydipsia. Urticaria and other allergies are possible with any preparation.

THIAZIDES

Diuretic thiazides paradoxically exert an antidiuretic effect in DI. High ceiling diuretics are also effective but are less desirable because of their short and brisk action. Thiazides reduce urine volume in both pituitary origin as well as renal DI; especially valuable for the latter in which AVP is ineffective. However, their efficacy is low; urine can never become hypertonic as can occur with AVP in neurogenic DI. The mechanism of action is not well understood, possible explanation is:

Thiazides induce a state of sustained electrolyte depletion so that glomerular filtrate is more completely reabsorbed iso-osmotically in PT. Further, because of reduced salt reabsorption in the cortical diluting segment, a smaller volume of less dilute urine is presented to the CDs and the same is passed out. That salt restriction has a similar effect, substantiates this mechanism of

action. Secondly, thiazides reduce g.f.r. and thus the fluid load on tubules.

Hydrochlorothiazide 25–50 mg TDS or equivalent dose of a longer acting agent is commonly used. Though less effective than AVP, it is more convenient and cheap even for pituitary origin DI; may reduce polyuria to some extent. K⁺ supplements are needed.

Amiloride is the drug of choice for lithium induced nephrogenic DI (see p. 572).

Indomethacin has also been found to reduce polyuria in renal DI to some extent by reducing renal PG synthesis. It can be combined with a

thiazide ± amiloride in nephrogenic DI. Other NSAIDs are less active.

Chlorpropamide It is a long-acting oral hypoglycaemic (see Ch. 19), found to reduce urine volume in DI of pituitary origin but not in renal DI. It sensitizes the kidney to ADH action; thus its efficacy depends on small amounts of the circulating hormone; it is not active when ADH is totally absent. Nearly 50% patients with partial neurogenic DI respond reasonably well. A thiazide may be added to augment the response. However, induced hypoglycaemia limits its usefulness in DI. *Dose:* 125–500 mg/day.

Carbamazepine It is an antiepileptic (see Ch. 30) which reduces urine volume in DI of pituitary origin, but mechanism of action is not clear. Higher doses are needed; adverse effects are marked; it is of little value in treatment of DI.

The background of the entire page is a dense field of microscopic blood cells. The majority are red blood cells, depicted as orange-red, biconcave discs. Scattered throughout are several white blood cells, which are larger and have a more irregular, spherical shape with a lighter, purple-tinged center. The overall appearance is that of a microscopic view of a blood smear.

Drugs Affecting Blood and Blood Formation

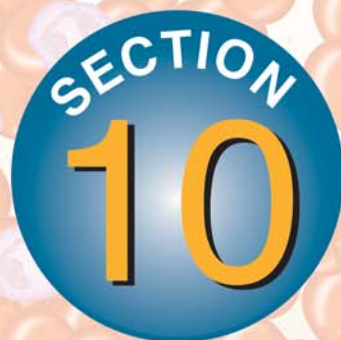
A circular logo with a blue-to-teal gradient. The word "SECTION" is written in white, uppercase letters along the top inner curve of the circle. The number "10" is written in large, bold, yellow-orange digits in the center of the circle.

SECTION
10

CHAPTER 43

Haematinics and Erythropoietin

Haematinics These are substances required in the formation of blood, and are used for treatment of anaemias.

Anaemia occurs when the balance between production and destruction of RBCs is disturbed by:

- Blood loss (acute or chronic)
- Impaired red cell formation due to:
 - Deficiency of essential factors, i.e. iron, vitamin B₁₂, folic acid.
 - Bone marrow depression (hypoplastic anaemia), erythropoietin deficiency.
- Increased destruction of RBCs (haemolytic anaemia)

In this chapter essential factors required for normal formation or pigmentation of RBCs will be covered.

IRON

Iron has for long been considered important for the body. *Lauha bhasma* (calcined iron) has been used in ancient Indian medicine. According to Greek thought Mars is the God of strength and iron is dedicated to Mars: thus, iron was used for weakness, which is common in anaemia. In 1713 iron was shown to be present in blood. In the early 19th century Blaud developed his famous 'Blaud's pill' consisting of ferrous sulfate and potassium carbonate for anaemia. All important aspects of iron metabolism have been learned in the past 60 years.

Distribution of iron in body Iron is an essential body constituent. Total body iron in an adult is

2.5–5 g (average 3.5 g). It is more in men (50 mg/kg) than in women (38 mg/kg). It is distributed into:

Haemoglobin (Hb)	: 66%
Iron stores as ferritin and haemosiderin	: 25%
Myoglobin (in muscles)	: 3%
Parenchymal iron (in enzymes, etc.)	: 6%

Haemoglobin is a protoporphyrin; each molecule having 4 iron containing haeme residues. It has 0.33% iron; thus loss of 100 ml of blood (containing 15 g Hb) means loss of 50 mg elemental iron. To raise the Hb level of blood by 1 g/dl—about 200 mg of iron is needed. Iron is stored only in ferric form, in combination with a large protein *apoferritin*.

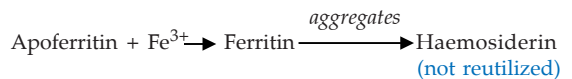

Ferritin can get saturated to different extents; at full saturation it can hold 30% iron by weight. The most important storage sites are reticuloendothelial (RE) cells. Parenchymal iron occurs as prosthetic group in many cellular enzymes—cytochromes, peroxidases, catalases, xanthine oxidase and some mitochondrial enzymes. Though, the primary reflection of iron deficiency occurs in blood, severe deficiency affects practically every cell.

Daily requirement To make good average daily loss, iron requirements are:

Adult male	: 0.5–1 mg (13 µg/kg)
Adult female (menstruating)	: 1–2 mg (21 µg/kg)
Infants	: 60 µg/kg
Children	: 25 µg/kg
Pregnancy (last 2 trimesters)	: 3–5 mg (80 µg/kg)

Dietary sources of iron

<i>Rich</i>	: Liver, egg yolk, oyster, dry beans, dry fruits, wheat germ, yeast.
<i>Medium</i>	: Meat, chicken, fish, spinach, banana, apple.
<i>Poor</i>	: Milk and its products, root vegetables.

Iron absorption

The average daily diet contains 10–20 mg of iron. Its absorption occurs all over the intestine, but majority in the upper part. Dietary iron is present either as haeme or as inorganic iron. Absorption of haeme iron is better (upto 35% compared to inorganic iron which averages 5%) and occurs directly without the aid of a carrier (Fig. 43.1).

However, it is a smaller fraction of dietary iron. The major part of dietary iron is inorganic and in the ferric form. It needs to be reduced to the ferrous form before absorption. Two separate iron transporters in the intestinal mucosal cells function to effect iron absorption. At the luminal membrane the *divalent metal transporter 1* (DMT1) carries ferrous iron into the mucosal cell. This along with the iron released from haeme is transported across the basolateral membrane by another iron transporter *ferroportin* (FP). These iron transporters are regulated according to the body needs. Absorption of haeme iron is largely independent of other foods simultaneously ingested, but that of inorganic iron is affected by several factors.

Factors facilitating iron absorption

1. Acid: by favouring dissolution and reduction of ferric iron.
2. Reducing substances: ascorbic acid, amino acids containing SH radical. These agents reduce ferric iron and form absorbable complexes.
3. Meat: by increasing HCl secretion and providing haeme iron.

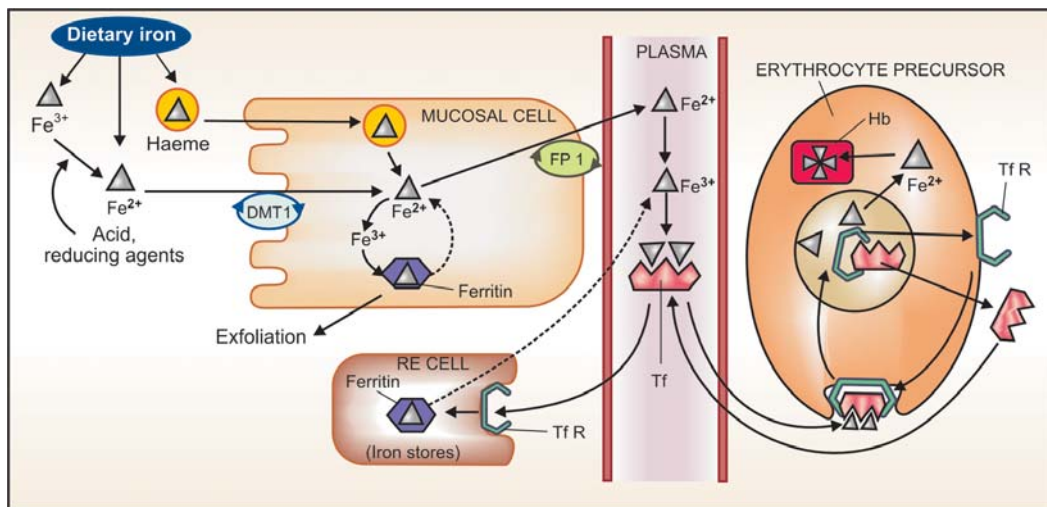

Fig. 43.1: Schematic depiction of intestinal absorption, transport, utilization and storage of iron (see text for description) Fe^{2+} —Ferrous iron; Fe^{3+} —Ferric iron; DMT1—Divalent metal transporter 1; Hb—Haemoglobin; RE cell—Reticuloendothelial cell; FP1—Ferroportin; Tf—Transferrin; TfR—Transferrin receptor

Factors impeding iron absorption

1. Alkalies (antacids) render iron insoluble, oppose its reduction.
2. Phosphates (rich in egg yolk)
3. Phytates (in maize, wheat)
4. Tetracyclines
5. Presence of other foods in the stomach.

} By
} complexing
} iron

In general, bioavailability of iron from cereal based diets is low.

Mucosal block The gut has a mechanism to prevent entry of excess iron in the body. Iron reaching inside mucosal cell is either transported to plasma or oxidised to ferric form and complexed with apoferritin to form ferritin (Fig. 43.1). This ferritin generally remains stored in the mucosal cells and is lost when they are shed (lifespan 2–4 days). This is called the 'Ferritin curtain'.

The iron status of the body and erythropoietic activity govern the balance between these two processes, probably through a 'haematopoietic transcription factor', and thus the amount of iron that will enter the body. A larger percentage is absorbed during iron deficiency. When body iron is low or erythropoiesis is occurring briskly, ferritin is either not formed or dissociates soon—the released iron is transported to the blood.

Mucosal block however, can be overwhelmed by gross excess of iron.

Transport, utilization, storage and excretion

Free iron is highly toxic. As such, on entering plasma it is immediately converted to the ferric form and complexed with a glycoprotein *transferrin* (Tf). Iron circulates in plasma bound to Tf (two Fe^{3+} residues per molecule). The total plasma iron content (~3 mg) is recycled 10 times everyday (turnover of iron is 30 mg/day).

Iron is transported into erythropoietic and other cells through attachment of transferrin to specific membrane bound transferrin receptors (TfRs). The complex is engulfed by receptor mediated endocytosis. Iron dissociates from the complex at the acidic pH of the intracellular vesicles; the released iron is utilized for

haemoglobin synthesis or other purposes, while Tf and TfR are returned to the cell surface to carry fresh loads. In iron deficiency and haemolytic states when brisk erythropoiesis is occurring, TfRs in erythropoietic cells increase in number. This does not occur in other cells. Thus, the erythron becomes selectively more efficient in trapping iron.

Iron is stored in RE cells in liver, spleen, bone marrow, also in hepatocytes and myocytes as ferritin and haemosiderin after entering these cells through TfRs. Apoferritin synthesis is regulated by iron status of the body. When it is low—the 'iron regulating element' (IRE) on mRNA is blocked—transcription of apoferritin does not occur, while more Tf is produced. On the other hand, more apoferritin is synthesized to trap iron when iron stores are rich. Plasma iron derived from destruction of old RBCs (lifespan ~120 days), from stores and from intestinal absorption forms a common pool that is available for erythropoiesis, to all other cells and for restorage.

Iron is tenaciously conserved by the body; daily excretion in adult male is 0.5–1 mg, mainly as exfoliated g.i. mucosal cells, some RBCs and in bile (all lost in faeces). Other routes are desquamated skin, very little in urine and sweat. In menstruating women, monthly menstrual loss may be averaged to 0.5–1 mg/day. Excess iron is required during pregnancy for expansion of RBC mass, transfer to foetus and loss during delivery; totalling to about 700 mg. This is to be met in the later 2 trimesters.

Preparations and dose

Oral iron

The preferred route of iron administration is oral. Dissociable ferrous salts are inexpensive, have high iron content and are better absorbed than ferric salts, especially at higher doses. Gastric irritation and constipation (the most important side effects of oral iron) are related to the total quantity of elemental iron administered. If viewed in terms of iron content, nearly all preparations have the same degree of gastric tolerance, the

Table 43.1: Some combination preparations of iron

<i>Trade name</i>	<i>Iron compound</i>	<i>Other ingredients</i>
CONVIRON Cap	Fe. sulfate (dried) 60 mg	B ₁₂ 15 µg, folic acid 1.5 mg, B ₆ 1.5 mg, vit. C 75 mg
FESOVIT-SPANSULE Cap	Fe. sulfate (dried) 150 mg	B ₁₂ 15 µg, folic acid 1 mg, nicotinamide 50 mg, B ₆ 2 mg
FEFOL SPANSULE Cap	Fe. sulfate 150 mg	Folic acid 0.5 mg
HEMGLOB syr (15 ml)	Fe. gluconate 300 mg	B ₁₂ 15 µg, B ₁ 5 mg, B ₂ 5 mg, B ₆ 1.5 mg, niacinamide 45 mg
AUTRIN Cap	Fe. fumarate 300 mg	B ₁₂ 15 µg, folic acid 1.5 mg
DUMASULES Cap	Fe. fumarate 300 mg	B ₁₂ 7.5 µg, folic acid 0.75 mg, B ₁ 5 mg, niacinamide 50 mg, vit. C 75 mg, B ₆ 1.5 mg
HEMSYNERAL Cap	Fe. fumarate 200 mg	B ₁₂ 15 µg, folic acid 1.5 mg
ANEMIDOX Cap	Fe fumarate 360 mg	Folic acid 1.5 mg, vit B ₁₂ 15 µg, Cal. carb. 200 mg, vit C 75 mg, vit D 400 i.u.
FERRICARB Cap	Carbonyl iron (100 mg iron)	Folic acid 1.5 mg, vit B ₁₂ 15 µg, zinc sulfate 88 mg, pyridoxine 3 mg, sod. selenite 60 µg
HBFASST tab	Carbonyl iron (100 mg iron)	Folic acid 0.35 mg
HEMATRINE Cap	Fe. succinate 100 mg	B ₁₂ 2.5 µg, folic acid 0.5 mg, vit. C 25 mg, niacinamide 15 mg.
POLYRON tab, BIOFER tab POLYFER chewable tab	Iron hydroxy polymaltose (Iron 100 mg)	Folic acid 0.35 mg
TONOFERON syr (5 ml)	Colloidal ferric hydroxide 500 mg (iron 250 mg)	Folic acid 0.5 mg, B ₁₂ 5 µg.
drops (1 ml)	—do—50 mg (Iron 25 mg)	Folic acid 0.2 mg, B ₁₂ 5 µg.
FERROCHELATE syr (5 ml)	Ferric ammon. cit. (Iron 60 mg)	B ₁₂ 5 µg, folic acid 1 mg.
drops (1 ml)	—do—(Iron 20 mg)	B ₁₂ 4 µg, folic acid 0.2 mg.
RARICAP tab	Iron cal. complex (Iron 25 mg)	Folic acid 0.3 mg
PROBOFEX Cap	Fe. aminoate (60 mg iron)	B ₁₂ 15 µg, folic acid 1.5 mg, B ₆ 3 mg.
DEXORANGE Cap, syrup (15 ml)	Ferric ammon. cit. 160 mg	B ₁₂ 7.5 µg, folic acid 0.5 mg.

Combination of iron with strychnine, arsenic and yohimbine and all fixed dose combination of haemoglobin in any form are banned in India.

limits of which are fairly well defined in individual patients. Some simple oral preparations are:

1. Ferrous sulfate: (hydrated salt 20% iron, dried salt 32% iron) is the cheapest; may be preferred on this account. It often leaves a metallic taste in mouth; **FERSOLATE 200 mg tab.**
2. Ferrous gluconate (12% iron): **FERRONICUM 300 mg tab, 400 mg/15 ml elixer.**
3. Ferrous fumarate (33% iron): is less water soluble than ferrous sulfate and tasteless; **NORI-A 200 mg tab.**

4. Colloidal ferric hydroxide (50% iron):

NEOFERUM 200 mg tab, 400 mg/5 ml liquid, 100 mg/ml drops.

Other forms of iron present in oral formulations are:

- Ferrous succinate (35% iron)
- Iron choline citrate
- Iron calcium complex (5% iron)
- Ferric ammonium citrate (scale iron)
- Ferrous aminoate (10% iron)
- Ferric glycerophosphate
- Iron hydroxy polymaltose

These are claimed to be better absorbed and/or produce less bowel upset, but this is primarily due to lower iron content. They are generally more expensive.

A number of oral formulations containing one of the iron compounds along with one to many vitamins, yeast, amino acids and other minerals are widely marketed and promoted. Some of these are listed in Table 43.1, but should be considered irrational.

A technical Advisory Board (India) has recommended that B complex vitamins and zinc should not be included in iron and folic acid containing haematinic preparations.

Iron hydroxy polymaltose has been marketed by many pharmaceuticals and vigorously promoted for its high iron content, no metallic taste, good g.i. tolerability and direct absorption from the intestines. Because the complex releases little free iron in the gut lumen—g.i. irritation is minimal. However, the high bioavailability observed in rats has not been found in humans and reports of its poor efficacy in treating iron deficiency anaemia have appeared. Preparations of iron hydroxy polymaltose are 4–5 times costlier than other iron salts and its therapeutic efficacy is questionable.

The elemental iron content and not the quantity of iron compound per dose unit should be taken into consideration. Sustained release preparations are more expensive and not rational because most of the iron is absorbed in the upper intestine, while these preparations release part of their iron content lower down. Liquid formulations may stain teeth: should be put on the back of tongue and swallowed. In general they are less satisfactory.

A total of 200 mg elemental iron (infants and children 3–5 mg/kg) given daily in 3 divided doses produces the maximal haemopoietic response. Prophylactic dose is 30 mg iron daily. Absorption is much better when iron preparations are taken in empty stomach. However, side effects are also more; some prefer giving larger amounts after meals, while others like to give smaller doses in between meals.

Adverse effects of oral iron These are common at therapeutic doses and are related to elemental iron content. Individuals differ in susceptibility. Epigastric pain, heartburn, nausea, vomiting, staining of teeth, metallic taste, bloating, colic.

Constipation is more common (believed to be due to astringent action of iron) than diarrhoea (thought to reflect irritant action). However, these may be caused by alteration of intestinal flora as well.

Parenteral iron

Iron therapy by injection is indicated only when:

1. Oral iron is not tolerated: bowel upset is too much.
2. Failure to absorb oral iron: malabsorption; inflammatory bowel disease. Chronic inflammation (rheumatoid arthritis) decreases iron absorption, also the rate at which iron can be utilized is decreased.
3. Non-compliance to oral iron.
4. In presence of severe deficiency with chronic bleeding.
5. Along with erythropoietin: oral iron may not be absorbed at sufficient rate to meet the demands of induced rapid erythropoiesis.

Parenteral iron therapy needs calculation of the total iron requirement of the patient.

Iron requirement (mg) =

$$4.4 \times \text{body weight (kg)} \times \text{Hb deficit (g/dl)}$$

This formula includes iron needed for replenishment of stores. The rate of response with parenteral iron is not faster than with optimal doses given orally. However, stores can be replenished in a shorter time by parenteral therapy.

The ionized salts of iron used orally, cannot be injected because of their strong protein precipitating action. Two organically complexed preparations for parenteral use are:

- (i) Iron-dextran: as a colloidal solution containing 50 mg elemental iron/ml is the preparation of choice; **IMFERON 2 ml ampoule**.
- (ii) Iron-sorbitol-citric acid complex: 50 mg iron/ml; **JECTOFR 1.5 ml ampoule**.

The i.m. dose of both iron-dextran and iron-sorbitol is 30% higher than the calculated requirement of a patient. A test dose of the preparation (few drops) must be injected first to screen sensitive patients.

Table 43.2: Comparative properties of Iron-dextran and Iron-sorbitol-citric acid complex

<i>Iron-dextran</i>	<i>Iron-sorbitol-citric acid</i>
1. High molecular weight	Low molecular weight
2. Can be given i.m. or i.v.	Only i.m. use
3. Given i.m. 10–30% gets locally bound, which is not available for immediate utilization	Not locally bound
4. Not excreted	About 30% excreted in urine
5. Given i.m. absorbed through lymphatics	Absorbed directly into circulation
6. Not bound to transferrin	Binds to transferrin, may saturate it
7. Taken up by macrophages, slowly made available to the erythron	Directly available

Intramuscular: Injection is given deeply in the gluteal region using Z track technique (to avoid staining of the skin). Iron dextran can be injected 2 ml daily, or on alternate days, or 5 ml each side on the same day (local pain lasting weeks may occur with the higher dose). More than 1.5–2 ml of iron-sorbitol should not be injected at one time.

Intravenous: After a test dose of 0.5 ml iron-dextran injected i.v. over 5–10 min, 2 ml can be injected per day taking 10 min for the injection. Alternatively the total calculated dose is diluted in 500 ml of glucose/saline solution and infused i.v. over 6–8 hours under constant observation. Injection should be terminated if the patient complains of giddiness, paresthesias or constriction in chest. Intravenous iron injection is more risky than i.m. injection. Iron sorbitol is not suitable for i.v. use or for total dose infusion because it would rapidly saturate transferrin and very high levels of free iron in blood will be attained.

Adverse effects of parenteral iron

Local Pain at site of i.m. injection, pigmentation of skin, sterile abscess—especially in old and debilitated patient.

Systemic Fever, headache, joint pains, flushing, palpitation, chest pain, dyspnoea, lymph node enlargement. A metallic taste in mouth lasting few hours occurs with iron-sorbitol injection.

An anaphylactoid reaction resulting in vascular collapse and death occurs rarely. Iron sorbitol causes more immediate reactions than iron-dextran.

Iron-sorbitol should be avoided in patients with kidney disease.

Use

1. **Iron deficiency anaemia** It is the most important indication for medicinal iron. Iron deficiency is the commonest cause of anaemia, especially in developing countries where a sizable percentage of population is anaemic. The RBC are microcytic and hypochromic due to deficient Hb synthesis. Other metabolic manifestations are seen when iron deficiency is severe. Apart from nutritional deficiency, chronic bleeding from g.i. tract (ulcers, hookworm infestation) is a common cause. Iron deficiency also accompanies repeated attacks of malaria and chronic inflammatory diseases. The cause of iron deficiency should be identified and treated. Iron should be normally administered orally; parenteral therapy is to be reserved for special circumstances. A rise in Hb level by 0.5–1 g/dl per week is an optimum response to iron therapy. It is faster in the beginning and when anaemia is severe. Later, the rate of increase in Hb% declines. However, therapy should be continued till normal Hb level is attained (generally takes 1–3 months depending on the severity) and 2–3 months thereafter to replenish the stores, because after correction of anaemia, iron absorption is slow.

Prophylaxis: The amount of iron available from average diet and the absorptive processes in the intestine place a ceiling on iron absorption of ~3 mg/day. Thus, iron balance is precarious in most menstruating women. Later half of pregnancy and infancy are periods when iron deficiency will develop unless medicinal iron is supplemented.

In these situations as well as others (chronic illness, menorrhagia, after acute blood loss, etc.) prophylactic use of iron is indicated.

2. Megaloblastic anaemia When brisk haemopoiesis is induced by vit B₁₂ or folate therapy, iron deficiency may be unmasked. The iron status of these patients should be evaluated and iron given accordingly.

3. As an astringent Ferric chloride is used in throat paint.

ACUTE IRON POISONING

It occurs mostly in infants and children: 10–20 iron tablets or equivalent of the liquid preparation (> 60 mg/kg iron) may cause serious toxicity in them. It is very rare in adults.

Manifestations are vomiting, abdominal pain, haematemesis, diarrhoea, lethargy, cyanosis, dehydration, acidosis, convulsions; finally shock, cardiovascular collapse and death. In few cases death occurs early (within 6 hours), but is typically delayed to 12–36 hours, with apparent improvement in the intervening period. The pathological lesion is haemorrhage and inflammation in the gut, hepatic necrosis and brain damage.

Treatment It should be prompt.

To prevent further absorption of iron from gut

- (a) Induce vomiting or perform gastric lavage with sodium bicarbonate solution—to render iron insoluble.
- (b) Give egg yolk and milk orally: to complex iron. Activated charcoal does not adsorb iron.

To bind and remove iron already absorbed

Desferrioxamine (an iron chelating agent—see Ch. 66) is the drug of choice. It should be injected i.m. (preferably) 0.5–1 g (50 mg/kg) repeated 4–12 hourly as required, or i.v. (if shock is present) 10–15 mg/kg/hour; max 75 mg/kg in a day till serum iron falls below 300 µg/dl. Early therapy with desferrioxamine has drastically reduced mortality of iron poisoning.

Alternatively DTPA or calcium edetate (see Ch. 66) may be used if desferrioxamine is not available. BAL is contraindicated because its iron chelate is also toxic.

Supportive measures Fluid and electrolyte balance should be maintained and acidosis corrected by appropriate i.v. infusion. Respiration and BP may need support. Diazepam i.v. should be cautiously used to control convulsions, if they occur.

Miscellaneous/Adjuvant haematinics

1. Copper Haeme synthesis is interfered in copper deficiency. However, copper is a trace metal for man and clinical deficiency is very rare. Its routine use is, therefore, not justified. However, when copper deficiency is demonstrated, 0.5–5 mg of copper sulphate/day may be given therapeutically; prophylactic dose is 0.1 mg/day. It is present in some haematinic combinations (see Table 43.1).

2. Cobalt It stimulates erythropoiesis transiently, probably by inducing tissue hypoxia → increased erythropoietin production. Cobalt deficiency is not known in man. Moreover, it can cause hypothyroidism, angina and CHF. It should not be prescribed.

3. Pyridoxine (see Ch. 67) Pyridoxine responsive anaemia is a rare entity. It is due to inherent abnormality in haeme synthesis. Sideroblastic anaemia associated with isoniazid and pyrazinamide (which interfere with pyridoxine metabolism and action) therapy needs to be treated with pyridoxine. Some other sideroblastic anaemias show partial improvement with large doses of pyridoxine. However, routine use of pyridoxine in anaemia is wasteful.

4. Riboflavin (see Ch. 67) Hypoplastic anaemia occurs in riboflavin deficiency which is generally a part of multiple deficiencies in protein-calorie malnutrition. In the absence of specific deficiency, use of riboflavin in anaemia is of no value.

MATURATION FACTORS

Deficiency of vit B₁₂ and folic acid, which are B group vitamins, results in megaloblastic anaemia characterized by the presence of large red cell precursors in bone marrow and their large and shortlived progeny in peripheral blood. Vit B₁₂ and folic acid are therefore called maturation factors. The basic defect is in DNA synthesis. Apart from haemopoietic, other rapidly proliferating tissues also suffer.

VITAMIN-B₁₂

Cyanocobalamin and hydroxocobalamin are complex cobalt containing compounds present in the diet and referred to as vit B₁₂.

Thomas Addison (1849) described cases of anaemia not responding to iron. This was later called 'pernicious' (incurable, deadly) anaemia and its relation with atrophy of gastric mucosa was realized. Minot and Murphy (1926) treated such patients by including liver in diet and received Nobel prize. Castle (1927–32) propounded the hypothesis that there was an *extrinsic factor* present in diet which combined with an *intrinsic factor* produced by stomach to give rise to the *haemopoietic principle*. Vit B₁₂ was isolated in 1948 and was shown to be the extrinsic factor as well as the haemopoietic principle, the intrinsic factor only helped in its absorption.

Vit B₁₂ occurs as water soluble, thermostable red crystals. It is synthesized in nature only by microorganisms; plants and animals acquire it from them.

Dietary sources Liver, kidney, sea fish, egg yolk, meat, cheese are the main vit B₁₂ containing constituents of diet. The only vegetable source is legumes (pulses) which get it from microorganisms harboured in their root nodules.

Vit B₁₂ is synthesized by the colonic microflora but this is not available for absorption in man. The commercial source is *Streptomyces griseus*; as a byproduct of streptomycin industry.

Daily requirement. 1–3 µg, pregnancy and lactation 3–5 µg.

Metabolic functions Vit B₁₂ is intricately linked with folate metabolism in many ways; megaloblastic anaemia occurring due to deficiency of either is indistinguishable. In addition, vit B₁₂ has some independent metabolic functions as well. The active coenzyme forms of B₁₂ generated in the body are *deoxyadenosyl-cobalamin* (DAB₁₂) and *methyl-cobalamin* (methyl B₁₂).

(i) Vit B₁₂ is essential for the conversion of homocysteine to methionine

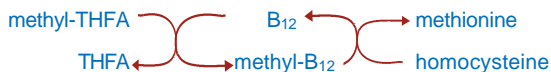

Methionine is needed as a methyl group donor in many metabolic reactions and for protein synthesis. This reaction is also critical in making

tetrahydrofolic acid (THFA) available for reutilization. In B₁₂ deficiency THFA gets trapped in the methyl form and a number of *one carbon* transfer reactions suffer (*see* under folic acid).

(ii) Purine and pyrimidine synthesis is affected primarily due to defective 'one carbon' transfer because of 'folate trap'. The most important of these is inavailability of thymidylate for DNA production.



is an important step in propionic acid metabolism. It links the carbohydrate and lipid metabolisms. This reaction does not require folate and has been considered to be responsible for demyelination seen in B₁₂ deficiency, but not in pure folate deficiency. That myelin is lipoidal, supports this contention.

(iv) Now it appears that interference with the reaction:



may be more important in the neurological damage of B₁₂ deficiency, because it is needed in the synthesis of phospholipids and myelin.

(v) Vit B₁₂ is essential for cell growth and multiplication.

Utilization of vit B₁₂ Vit B₁₂ is present in food as protein conjugates and is released by cooking or by proteolysis in stomach facilitated by gastric acid. Intrinsic factor (a glycoprotein, MW60,000) secreted by stomach forms a complex with B₁₂—attaches to specific receptors present on intestinal mucosal cells and is absorbed by active carrier mediated transport. This mechanism is essential for absorption of vit B₁₂ ingested in physiological amounts. However, when gross excess is taken, a small fraction is absorbed without the help of intrinsic factor.

Vit B₁₂ is transported in blood in combination with a specific β globulin *transcobalamin II* (TCII). Congenital absence of TCII or presence of abnormal protein (TCI or TCIII, in liver and bone marrow disease) may interfere with delivery of

vit B₁₂ to tissues. Vit B₁₂ is especially taken up by liver cells and stored: about 2/3 to 4/5 of body's content (2–8 mg) is present in liver.

Vit B₁₂ is not degraded in the body. It is excreted mainly in bile (3–7 µg/day); all but 0.5–1 µg of this is reabsorbed—considerable enterohepatic circulation occurs. Thus, in the absence of intrinsic factor or when there is malabsorption, B₁₂ deficiency develops much more rapidly than when it is due to nutritional deficiency. It takes 3–5 years of total absence of B₁₂ in diet to deplete normal body stores.

Vit B₁₂ is directly and completely absorbed after i.m. or deep s.c. injection. Normally, only traces of B₁₂ are excreted in urine, but when pharmacological doses (> 100 µg) are given orally or parenterally—a large part is excreted in urine, because the plasma protein binding sites get saturated and free vit B₁₂ is filtered at the glomerulus. Hydroxocobalamin is more protein bound and better retained than cyanocobalamin.

Deficiency Vit B₁₂ deficiency occurs due to:

1. Addisonian pernicious anaemia: is probably an autoimmune disorder which results in destruction of gastric parietal cells → absence of intrinsic factor in gastric juice (along with achlorhydria) → inability to absorb vit B₁₂.
2. Other causes of gastric mucosal damage, e.g. chronic gastritis, gastric carcinoma, gastrectomy, etc.
3. Malabsorption (damaged intestinal mucosa), bowel resection.
4. Consumption of vit B₁₂ by abnormal flora in intestine (blind loop syndrome) or fish tape worm.
5. Nutritional deficiency: less common cause.
6. Increased demand: pregnancy, infancy.

Manifestations of deficiency are:

- (a) Megaloblastic anaemia (generally the first manifestation), neutrophils with hypersegmented nuclei, giant platelets.
- (b) Glossitis, g.i. disturbances: damage to epithelial structures.
- (c) Neurological: subacute combined degeneration of spinal cord; peripheral neuritis—diminished vibration and position sense, paresthesias, depressed stretch reflexes; mental changes—

poor memory, mood changes, hallucinations, etc. are late effects.

Preparations, dose, administration

- Cyanocobalamin: REDISOL, MACRABIN 35 µg/5 ml liq; 100, 500, 1000 µg inj.
- Hydroxocobalamin: REDISOL-H, MACRABIN-H 500, 1000 µg inj.
- Methylcobalamin: BIOCOBAL, DIACOBAL, METHYLCOBAL 0.5 mg tab.

Methyl B₁₂ is the active coenzyme form of vit B₁₂ for synthesis of methionine and S-adenosylmethionine that is needed for integrity of myelin. This preparation of vit B₁₂ in a dose of 1.5 mg/day has been especially promoted for correcting the neurological defects in diabetic, alcoholic and other forms of peripheral neuropathy. However, in USA and many other countries, it is used only as a nutritional supplement, and not as a drug.

Combination preparations of B₁₂ with other vitamins and iron are listed in Tables 43.1 and 67.2. Hydroxocobalamin has been preferred for parenteral use because of better retention. However, it has been found to induce antibody formation so that vit B₁₂ becomes metabolically unavailable. It is not recommended in USA, but used in UK and India.

When vit B₁₂ deficiency is due to lack of intrinsic factor (pernicious anaemia and other causes), it should be given by i.m. or deep s.c. (but not i.v.) injection. Parenteral administration is necessary to bypass the defective absorptive mechanism. Initially 30–100 µg/day for 10 days followed by 100 µg weekly and then monthly for maintenance—indefinitely or life-long. When neurological complications are present, a higher dose (500–1000 µg/day) has been used, but the response is not superior to conventional doses.

In other types of deficiency 10–30 µg/day may be used orally. The prophylactic dose is 3–10 µg/day.

Uses

1. Treatment of vit B₁₂ deficiency: vit B₁₂ is used as outlined above. It is wise to add 1–5 mg of oral folic acid and an iron preparation, because reinstatement of brisk haemopoiesis may unmask deficiency of these factors. Response to vit B₁₂ is dramatic—symptomatic improvement starts in 2 days: appetite improves, patient feels better; mucosal lesions heal in 1–2 weeks; reticulocyte count increases; Hb% and haematocrit rise progressively; platelet count normalises in 10 days and WBC count in 2–3 weeks. Time taken for complete recovery of anaemia depends on the severity of disease to start with. Neurological parameters improve more slowly—may take several months; full recovery may not occur if vit B₁₂ deficiency has been severe or had persisted for long.
2. Prophylaxis: needs to be given only when there are definite predisposing factors for development of deficiency (*see* above).
3. Mega doses of vit B₁₂ have been used in neuropathies, psychiatric disorders, cutaneous sarcoid and as a general tonic to allay fatigue, improve growth—value is questionable.
4. Tobacco amblyopia: hydroxocobalamin is of some benefit—it probably traps cyanide derived from tobacco to form cyanocobalamin.

Adverse effects Even large doses of vit B₁₂ are quite safe. Allergic reactions have occurred on injection, probably due to contaminants. Anaphylactoid reactions (probably to sulfite contained in the formulation) have occurred on i.v. injection: this route should not be employed.

FOLIC ACID

It occurs as yellow crystals which are insoluble in water, but its sodium salt is freely water soluble. Chemically it is *Pteroyl glutamic acid* (PGA) consisting of pteridine + paraaminobenzoic acid (PABA) + glutamic acid.

Wills (1932–37) had found that liver extract contained a factor, other than vit B₁₂, which could cure megaloblastic

anaemia. Mitchell in 1941 isolated an antianaemia principle from spinach and called it ‘folic acid’ (from leaf). Later the Will’s factor was shown to be identical to folic acid.

Dietary sources Liver, green leafy vegetables (spinach), egg, meat, milk. It is synthesized by gut flora, but this is largely unavailable for absorption.

Daily requirement of an adult is < 0.1 mg but dietary allowance of 0.2 mg/day is recommended. During pregnancy, lactation or any condition of high metabolic activity, 0.8 mg/day is considered appropriate.

Utilization Folic acid is present in food as polyglutamates; the additional glutamate residues are split off primarily in the upper intestine before being absorbed. Reduction to DHFA and methylation also occurs at this site. It is transported in blood mostly as methyl-THFA which is partly bound to plasma proteins. Small, physiological amounts of folate are absorbed by specific carrier-mediated active transport in the intestinal mucosa. Large pharmacological doses may gain entry by passive diffusion, but only a fraction is absorbed.

Folic acid is rapidly extracted by tissues and stored in cells as polyglutamates. Liver takes up a large part and secretes methyl-THFA in bile which is mostly reabsorbed from intestine: enterohepatic circulation occurs. Alcohol interferes with release of methyl-THFA from hepatocytes. The total body store of folates is 5–10 mg. Normally, only traces are excreted, but when pharmacological doses are given, 50–90% of a dose may be excreted in urine.

Metabolic functions Folic acid is inactive as such and is reduced to the coenzyme form in two steps: FA → DHFA → THFA by folate reductase (FRase) and dihydrofolate reductase (DHFRase). THFA mediates a number of *one carbon* transfer reactions by carrying a methyl group as an adduct (*see* under vit. B₁₂ also).

1. Conversion of homocysteine to methionine: vit B₁₂ acts as an intermediary carrier of methyl group (*see* p. 588). This is the most important reaction which releases THFA from the methylated form.

2. Generation of thymidylate, an essential constituent of DNA:

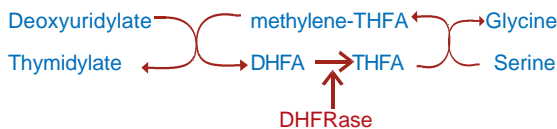

3. Conversion of serine to glycine: needs THFA and results in the formation of methylene-THFA which is utilized in thymidylate synthesis.

4. Purine synthesis: *de novo* building of purine ring requires formyl-THFA and methenyl-THFA (generated from methylene-THFA) to introduce carbon units at position 2 and 8.

5. Generation and utilization of 'formate pool'.

6. Histidine metabolism: for mediating formimino group transfer.

Ascorbic acid protects folates in the reduced form. Other cofactors, e.g. pyridoxal, etc. are required for some of the above reactions.

Deficiency Folate deficiency occurs due to:

- Inadequate dietary intake
- Malabsorption: especially involving upper intestine—coeliac disease, tropical sprue, regional ileitis, etc. Deficiency develops more rapidly as both dietary and biliary folate is not absorbed.
- Biliary fistula; bile containing folate for recirculation is drained.
- Chronic alcoholism: intake of folate is generally poor. Moreover, its release from liver cells and recirculation are interfered.
- Increased demand: pregnancy, lactation, rapid growth periods, haemolytic anaemia and other diseases with high cell turnover rates.
- Drug induced: prolonged therapy with anticonvulsants (phenytoin, phenobarbitone, primidone) and oral contraceptives—interfere with absorption and storage of folate.

Manifestations of deficiency are:

- Megaloblastic anaemia, indistinguishable from that due to vit B₁₂ deficiency. However, folate deficiency develops more rapidly if external supply is cut off: body stores last 3–4 months only. In malabsorptive conditions megaloblastosis may appear in weeks.
- Epithelial damage: glossitis, enteritis, diarrhoea, steatorrhoea.

(iii) Neural tube defects, including spina bifida in the offspring, due to maternal folate deficiency.

(iv) General debility, weight loss, sterility. However, neurological symptoms do not appear in pure folate deficiency.

Preparations and dose

Folic acid: **FOLVITE, FOLITAB 5 mg tab;**

Liquid oral preparations and injectables are available only in combination formulation (see Tables 43.1 and 67.2).

Oral therapy is adequate except when malabsorption is present or in severely ill patient—given i.m.

Dose: therapeutic 2 to 5 mg/day, prophylactic 0.5 mg/day.

Folinic acid; **CALCIUM LEUCOVORIN 3 mg/ml inj. FASTOVORIN 3 mg, 15 mg amps, 50 mg vial; RECOVERIN 15 mg tab, 15 mg, 50 mg vial for inj.**

Uses

1. **Megaloblastic anaemias** due to:

- Nutritional folate deficiency; manifests earlier than vit B₁₂ deficiency. Response occurs as quickly as with vit B₁₂.
- Increased demand: pregnancy, lactation, infancy, during treatment of severe iron deficiency anaemia, haemolytic anaemias.
- Pernicious anaemia: folate stores may be low and deficiency may be unmasked when vit B₁₂ induces brisk haemopoiesis: it has only secondary and adjuvant role in this condition.

Folic acid should never be given alone to patients with vit B₁₂ deficiency—haematological response may occur, but neurological defect may progress due to diversion of meagre amount of vit B₁₂ present in body to haemopoiesis.

- Malabsorption syndromes: Tropical sprue, coeliac disease, idiopathic steatorrhoea, etc.
- Antiepileptic therapy: Megaloblastic anaemia can occur due to prolonged phenytoin/phenobarbitone therapy (see Ch. 30). This is treated by folic acid, but large doses should be avoided as they may antagonize anticonvulsant effect.

2. **Prophylaxis** of folate deficiency: only when definite predisposing factors are present. Routine

folate supplementation (1 mg/day) is recommended during pregnancy to reduce the risk of neural tube defects in the newborn.

3. Methotrexate toxicity Folinic acid (Leucovorin, citrovorum factor, 5-formyl-THFA) is an active coenzyme form which does not need to be reduced by DHFRase before it can act. Methotrexate is a DHFRase inhibitor; its toxicity is not counteracted by folic acid, but antagonized by folinic acid.

Folinic acid is expensive and not needed for the correction of simple folate deficiency for which folic acid is good enough.

4. Citrovorum factor rescue In certain malignancies, high dose of methotrexate is injected i.v. and is followed within ½–1 hour with 1–3 mg i.v. of folinic acid to rescue the normal cells. It is ineffective if given > 3 hours after methotrexate.

Adverse effects Oral folic acid is entirely nontoxic. Injections rarely cause sensitivity reactions.

Shotgun antianaemia preparations A large number of formulations containing varying quantities of iron, vit B₁₂, folic acid and may be other vitamins and nutrients are marketed and promoted. They are liable to be used indiscriminately without proper assessment of needs of the patient, and investigating the cause of anaemia. Most preparations contain one or all ingredients in low amounts; thus, an incomplete response can occur. Diagnosis and assessment of the patient can become impossible thereafter.

ERYTHROPOIETIN

Erythropoietin (EPO) is a sialoglycoprotein hormone (MW 34000) produced by peritubular cells of the kidney. It is essential for normal erythropoiesis. Anaemia and hypoxia are sensed by kidney cells → rapid secretion of EPO → acts on erythroid marrow and:

- (a) Stimulates proliferation of colony forming cells of the erythroid series.
- (b) Induces haemoglobin formation and erythroblast maturation.

(c) Releases reticulocytes in circulation.

EPO binds to specific receptors on the surface of its target cells. The EPO receptor is a JAK-STAT-kinase binding receptor that alters phosphorylation of intracellular proteins and activates transcription factors to regulate gene expression. It induces erythropoiesis in a dose dependent manner, but has no effect on RBC lifespan.

The recombinant human erythropoietin (Epoetin α , β) is administered by i.v. or s.c. injection and has a plasma t_½ of 6–10 hr.

Use The primary indication for epoetin is anaemia of chronic renal failure which is due to low levels of EPO; 25–100 U/kg s.c. or i.v. 3 times a week (max. 600 U/kg/week) raises haematocrit and haemoglobin, reduces need for transfusions and improves quality of life. It is prudent to start with a low dose and titrate upwards to keep haematocrit between 30–36%, and Hb 10–12 g/dl. Some recent studies have indicated that dose reduction by about 30% is possible when epoetin is given s.c. compared to i.v. Exercise capacity and overall wellbeing of the patients is improved. Most patients have low iron stores; require concurrent parenteral/oral iron therapy for an optimum response. Other uses are:

1. Anaemia in AIDS patients treated with zidovudine.
2. Cancer chemotherapy induced anaemia.
3. Preoperative increased blood production for autologous transfusion during surgery.

Adverse effects Epoetin is nonimmunogenic. Adverse effects are related to sudden increase in haematocrit, blood viscosity and peripheral vascular resistance (due to correction of anaemia). These are—increased clot formation in the A-V shunts (most patients are on dialysis) hypertensive episodes, occasionally seizures. Flu like symptoms lasting 2–4 hr occur in some patients. HEMAX 2000 IU/ml and 4000 IU/ml vials; EPREX 2000 IU, 4000 IU and 10000 IU in 1 ml prefilled syringes; ZYROP (epoetin β) 2000 IU and 4000 IU vials.

CHAPTER 44

Drugs Affecting Coagulation, Bleeding and Thrombosis

Haemostasis (arrest of blood loss) and blood coagulation involve complex interactions between the injured vessel wall, platelets and coagulation factors. A cascading series of proteolytic reactions (Fig. 44.1) is started by:

- (i) Contact activation of Hageman factor: *intrinsic system*, in which all factors needed for coagulation are present in plasma. This is slow and takes several minutes to activate factor X.
- (ii) Tissue thromboplastin: *extrinsic system*, needs a tissue factor, but activates factor X in seconds.

The subsequent events are common in the two systems and result in polymerization of fibrinogen to form fibrin strands. Blood cells are trapped in the meshwork of fibrin strands producing clot.

Two *in vitro* tests 'activated partial thromboplastin time' (aPTT) and 'prothrombin time' (PT) are employed for testing integrity of the intrinsic, extrinsic and common pathways of the coagulation cascade. The results are interpreted as:

	PT	aPTT
Intrinsic pathway interfered	Normal (12–14S)	Prolonged
Extrinsic pathway interfered	Prolonged	Normal (26–32S)
Common pathway interfered	Prolonged	Prolonged

Most clotting factors are proteins present in plasma in the inactive (zymogen) form. By partial

proteolysis they themselves become an active protease and activate the next factor. In addition to its critical role in cleaving and polymerizing fibrinogen, thrombin activates many upstream factors (especially f. XI, VIII and V) of the intrinsic and common pathways—amplifying its own generation and continuation of clot formation. It is also a potent activator of platelets.

On the other hand, factors like *antithrombin*, *protein C*, *protein S*, *antithromboplastin* and the *fibrinolysin system* tend to oppose coagulation and lyse formed clot. Thus, a check and balance system operates to maintain blood in a fluid state while in circulation and allows rapid haemostasis following injury.

COAGULANTS

These are substances which promote coagulation, and are indicated in haemorrhagic states.

Fresh whole blood or plasma provide all the factors needed for coagulation and are the best therapy for deficiency of any clotting factor; also they act immediately. Other drugs used to restore haemostasis are:

1. Vitamin K

K₁ (from plants, fat-soluble) : Phytonadione (Phylloquinone)

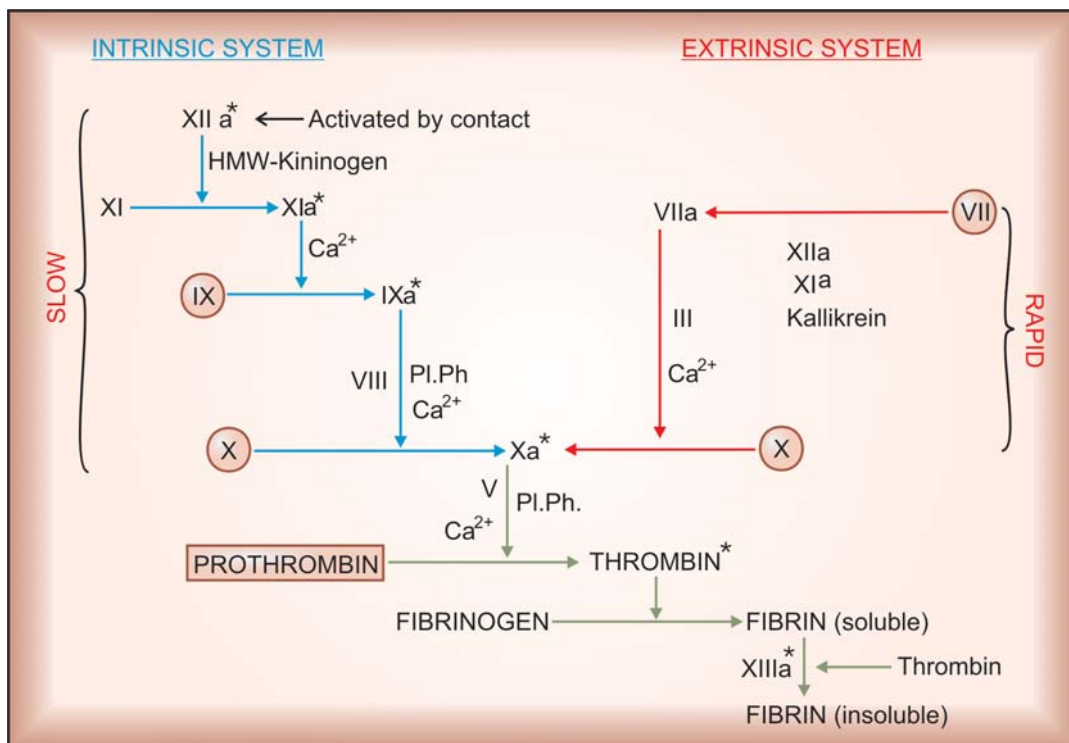

Fig. 44.1: The coagulation cascade. The vit. K dependent factors have been encircled,* Inactivated by heparin a—activated form; PI.Ph.—Platelet phospholipid; HMW—High molecular weight.

K₃ (synthetic)

- Fat-soluble : Menadione, Acetomenaphthone
- Water-soluble : Menadione sod. bisulfite ; Menadione sod. diphosphate

2. Miscellaneous

- Fibrinogen (human)
- Antihaemophilic factor
- Desmopressin
- Adrenochrome monosemicarbazone
- Rutin, Ethamsylate

VITAMIN K

It is a fat-soluble dietary principle required for the synthesis of clotting factors.

Dam (1929) produced bleeding disorder in chicken by feeding deficient diet. This was later found to be due to

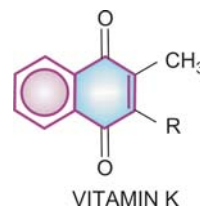

decreased concentration of prothrombin in blood and that it could be cured by a fat soluble fraction of hog liver. This factor was called *Koagulations vitamin* (vit K) and soon its structure was worked out. A similar vitamin was isolated in 1939 from alfalfa grass and labelled vit K₁, while that from sardine (sea fish) meal was labelled K₂. Synthetic compounds have been produced and labelled K₃.

Chemistry and source Vit K has a basic naphthoquinone structure, with or without a side chain (R) at position 3. The side chain in K₁ is *phytyl*, in K₂ *prenyl*, while in K₃ there is no side chain.

Dietary sources are—green leafy vegetables, such as cabbage, spinach; and liver, cheese, etc.

Daily requirement It is uncertain, because a variable amount of menaquinone (vit K₂) produced by colonic bacteria becomes available. Even 3–10 µg/day external source may be sufficient. However, the total requirement of an adult has been estimated to be 50–100 µg/day.

Action Vit K acts as a cofactor at a late stage in the synthesis by liver of coagulation proteins—prothrombin, factors VII, IX and X. The vit K dependent change (γ carboxylation of glutamate residues of these zymogen proteins; see Fig. 44.2) confers on them the capacity to bind Ca²⁺ and to get bound to phospholipid surfaces—properties essential for participation in the coagulation cascade.

Utilization Fat-soluble forms of vit K are absorbed from the intestine *via* lymph and require bile salts for absorption, while water-soluble forms are absorbed directly into portal blood. An active transport process in the jejunum has been demonstrated for K₁, while K₂ and K₃ are absorbed by simple diffusion. Vit K is only temporarily concentrated in liver, but there are no significant stores in the body. It is metabolized in liver by side chain cleavage and glucuronide conjugation; metabolites are excreted in bile and urine.

Deficiency Deficiency of vit K occurs due to liver disease, obstructive jaundice, malabsorption, long-term antimicrobial therapy which alters intestinal flora. However, deficient diet is rarely responsible. The most important manifestation is bleeding tendency due to lowering of the levels of prothrombin and other clotting factors in blood. Haematuria is usually first to occur; other common sites of bleeding are g.i.t., nose and under the skin—ecchymoses.

Preparations

Phytonadione: VITAMIN-K, KENADION 10 mg/ml for i.m. injection.

Menadione: 0.66 mg in GYNAE CVP with vit C 75 mg, ferrous gluconate 67 mg, Cal. lactate 300 mg and citras bioflavonoid 150 mg per cap:

Acetomenaphthone: ACETOMENADIONE 5, 10 mg tab; KAPILIN 10 mg tab.

Menadione sod. bisulfite: 20 mg, in CADISPER-C with vit C 100 mg, adrenochrome monosemicarbazone, 1 mg, rutin 60 mg, methylhesperidin 40 mg, Cal. phosphate 100 mg per tab.

STYPTOCID 10 mg with adrenochrome monosemicarbazone 0.5 mg, rutin 50 mg, vit C 37.5 mg, vit D 200 i.u., Cal. phosphate 260 mg per tab.

Use The only use of vit K is in prophylaxis and treatment of bleeding due to deficiency of clotting factors in the following situations:

(a) *Dietary deficiency*: of vit K is very rare in adults. However, when it occurs 5–10 mg/day oral or parenteral vit K rapidly corrects the defects.

(b) *Prolonged antimicrobial therapy*: treat in the same way as dietary deficiency of vit K.

(c) *Obstructive jaundice or malabsorption syndromes* (sprue, regional ileitis, steatorrhoea, etc.): vit K 10 mg i.m./day, or orally along with bile salts.

(d) *Liver disease* (cirrhosis, viral hepatitis): associated bleeding responds poorly to vit K. Because of hepatocellular damage, synthesis of clotting factors is inadequate despite the presence of vit K. However, vit K may be of some use if its absorption had been affected due to lack of bile salts.

(e) *Newborns*: All newborns have low levels of prothrombin and other clotting factors. Further decrease occurs in the next few days. The cause is both lower capacity to synthesize clotting factors as well as deficiency of vit K. The defect is exaggerated in the premature infant. Vit K 1 mg i.m. soon after birth has been recommended routinely. Some prefer administering 5–10 mg i.m. to the mother 4–12 hours before delivery. Haemorrhagic disease of the newborn can be effectively prevented/treated by such medication.

Menadione (K₃) should not be used for this purpose (see below).

(f) *Overdose of oral anticoagulants*: This is the most important indication of vit K. Phytonadione (K₁) is the preparation of choice, because it acts most rapidly; dose depends on the severity of hypoprothrombinaemia (measured INR) and bleeding. Unnecessary high dose is to be avoided because it will render the patient unresponsive to oral anticoagulants for several days.

Severe: 10 mg i.m. followed by 5 mg 4 hourly; bleeding generally stops in 6–12 hours, but normal levels of coagulation factors are restored only after 24 hr. This dose of vit K will block anticoagulant action for 7–10 days.

Moderate: 10 mg i.m. followed by 5 mg once or twice according to response.

Mild: Just omit a few doses of the anticoagulant.

(g) Prolonged high dose salicylate therapy causes hypoprothrombinemia; vit K should be given prophylactically. If bleeding occurs—treat as for oral anticoagulants.

Toxicity Rapid i.v. injection of emulsified vit K produces flushing, breathlessness, a sense of constriction in the chest, fall in BP; few deaths are on record. It is probably due to emulsion form of the preparation.

Menadione and its water-soluble derivatives can cause haemolysis in a dose-dependent manner. Patients with G-6-PD deficiency and neonates are especially susceptible. In the newborn menadione or its salts can precipitate kernicterus: (a) by inducing haemolysis and increasing bilirubin load.

(b) by competitively inhibiting glucuronidation of bilirubin. Glucuronide conjugation is, as such, inadequate in neonates.

Because of poor efficacy and higher toxicity, there is little justification to use menadione and its water soluble salts for any indication.

Fibrinogen The fibrinogen fraction of human plasma is employed to control bleeding in haemophilia, antihæmophilic globulin (AHG) deficiency and acute afibrinogenemic states; 0.5 g is infused i.v.

FIBRINAL 0.5 g/bottle for i.v. infusion.

Antihæmophilic factor It is concentrated human AHG prepared from pooled human plasma. It is indicated (along with human fibrinogen) in haemophilia and AHG deficiency. It is highly effective in controlling bleeding episodes, but action is short-lasting (1 to 2 days).

Dose: 5–10 U/kg by i.v. infusion, repeated 6–12 hourly.
FIBRINAL-H, ANTIHÆMOPHILIC FACTOR: 150 U or 200 U + fibrinogen 0.5 g/bottle for i.v. infusion.

Desmopressin It releases factor VIII and von Willebrand's factor from vascular endothelium and checks bleeding in haemophilia and von Willebrand's disease (*see p. 577*).

Adrenochrome monosemicarbazone It is believed to reduce capillary fragility, control oozing from raw surfaces and prevent microvessel bleeding, e.g. epistaxis, haematuria, retinal haemorrhage, secondary haemorrhage from wounds, etc. Its efficacy is uncertain.

Dose: 1–5 mg oral, i.m.

STYPTOCHROME 3 mg/2 ml inj, **STYPTOCID:** 2 mg/2 ml inj; in **CADISPER-C, STYPTOCID** 1 mg, 0.5 mg tab, with other ingredients.

Rutin It is a plant glycoside claimed to reduce capillary bleeding. It has been used in a dose of 60 mg oral BD–TDS along with vit C which is believed to facilitate its action. Its efficacy is uncertain.

In **CADISPER-C** 60 mg tab, in **KERUTIN-C** 100 mg tab, in **STYPTOBION** 100 mg tab, 200 mg/2 ml inj.

Ethamsylate It reduces capillary bleeding when platelets are adequate; probably exerts antihyaluronidase action—improves capillary wall stability, but does not stabilize fibrin (not an antifibrinolytic). Ethamsylate has been used in the prevention and treatment of capillary bleeding in menorrhagia, after abortion, PPH, epistaxis, malena, hematuria and after tooth extraction, but efficacy is unsubstantiated. Side effects are nausea, rash, headache, and fall in BP (only after i.v. injection).

Dose: 250–500 mg TDS oral/i.v.; **ETHAMSYL, DICYNENE, HEMSYL, K. STAT** 250, 500 mg tabs; 250 mg/2 ml inj.

LOCAL HAEMOSTATICS (STYPTICS)

After injury to arterioles and other smaller blood vessels, normal haemostasis occurs successively by contraction of injured vessel wall (lasting few minutes), adhesion and aggregation of platelets to form a plug, formation of a blood clot, and finally in due course dissolution of the clot by fibrinolysis. External bleeding is usually stopped by manual pressure, cotton-gauze pressure pack or by suturing. Control of bleeding may be aided by *local haemostatics (styptics)* that are substances used to stop bleeding from a local and approachable site. They are particularly effective on oozing surfaces, e.g. tooth socket, abrasions, etc. Absorbable materials like *fibrin* (prepared from human plasma and dried as sheet or foam), *gelatin foam*, *oxidized cellulose* (as strips which can be cut and placed in the wound) provide a meshwork which activates the clotting mechanism and checks bleeding. Left *in situ* these materials are absorbed in 1–4 weeks and generally cause no foreign body reaction. *Thrombin* obtained from bovine plasma may be applied as dry powder or freshly prepared solution to the bleeding surface in haemophiliacs.

Vasoconstrictors like 0.1% Adr solution may be soaked in sterile cotton-gauze and packed in the bleeding tooth socket or nose in case of epistaxis to check bleeding when spontaneous vasoconstriction is inadequate. *Astringents* such as tannic acid or metallic salts are occasionally applied for bleeding gums, bleeding piles, etc.

SCLEROSING AGENTS

These are irritants, cause inflammation, coagulation and ultimately fibrosis, when injected into haemorrhoids (piles) or varicose vein mass. They are used only for local injection.

1. Phenol (5%) in almond oil or peanut oil: 2–5 ml.
2. Ethanolamine oleate (5% in 25% glycerine and 2% benzyl alcohol): 1–5 ml inj.
3. Sod. tetradecyl sulfate (3% with benzyl alcohol 2%): 0.5–2 ml at each site. **SETROL 2 ml inj.**
4. Polidocanol (3% inj): 2 ml; **ASKLEROL 2 ml inj.**

ANTICOAGULANTS

These are drugs used to reduce the coagulability of blood. They may be classified into:

I. Used in vivo

A. Parenteral anticoagulants

Heparin, Low molecular weight heparin.
Heparinoids—Heparan sulfate,
Danaparoid, Lepirudin, Ancrod.

B. Oral anticoagulants

- (i) *Coumarin derivatives*: Bishydroxycoumarin (dicumarol), Warfarin sod, Acenocoumarol (Nicoumalone), Ethylbiscoumacetate
- (ii) *Indandione derivative*: Phenindione.

II. Used in vitro

A. Heparin:

150 U to prevent clotting of 100 ml blood.

B. Calcium complexing agents:

Sodium citrate: 1.65 g for 350 ml of blood; used to keep blood in the fluid state for transfusion;
ANTICOAGULANT ACID CITRATE DEXTROSE SOLUTION 2.2 g/100 ml (75 ml is used for 1 unit of blood).

Sodium oxalate:

10 mg for 1 ml blood

Sodium edetate:

2 mg for 1 ml blood

} used in blood taken for investigations

HEPARIN

McLean, a medical student, discovered in 1916 that liver contains a powerful anticoagulant. Howell and Holt (1918) named it 'heparin' because it was obtained from liver. However, it could be used clinically only in 1937 when sufficient degree of purification was achieved.

Chemistry and occurrence Heparin is a non-uniform mixture of straight chain mucopolysaccharides with MW 10,000 to 20,000. It contains polymers of two sulfated disaccharide units:

D-glucosamine-L- iduronic acid	} chain length and proportion of the two disaccharide units varies. Some glucosamine residues are N-acetylated.
D-glucosamine-D- glucuronic acid	

It carries strong electronegative charges and is the strongest organic acid present in the body. It occurs in mast cells as a much bigger molecule (MW ~75,000) loosely bound to the granular protein. Thus, heparin is present in all tissues containing mast cells; richest sources are lung, liver and intestinal mucosa. Commercially it is produced from ox lung and pig intestinal mucosa.

ACTIONS

1. Anticoagulant Heparin is a powerful and instantaneously acting anticoagulant, effective both *in vivo* and *in vitro*. It acts indirectly by activating plasma antithrombin III (AT III, a serine proteinase inhibitor) and may be other similar cofactors. The heparin-AT III complex then binds to clotting factors of the intrinsic and common pathways (Xa, IIa, IXa, XIa, XIIa and XIIIa) and inactivates them but not factor VIIa operative in the extrinsic pathway. At low concentrations of heparin, factor Xa mediated conversion of prothrombin to thrombin is selectively affected. The anticoagulant action is exerted mainly by inhibition of factor Xa as well as thrombin (IIa) mediated conversion of fibrinogen to fibrin.

Low concentrations of heparin prolong aPTT without significantly prolonging PT. High concentrations prolong both. Thus, low concentrations interfere selectively with the intrinsic pathway, affecting amplification and continuation of clotting, while high concentrations affect the common pathway as well.

Antithrombin III is itself a substrate for the protease clotting factors; binds with the protease to form a stable complex (suicide inhibitor). However, in the absence of heparin, the two interact very slowly. Heparin enhances the action of AT III in two ways:

(a) Long heparin molecule provides a scaffolding for the clotting factors (mainly Xa and IIa) as well as AT III to get bound and interact with each other.

(b) Heparin induces conformational change in AT III to expose its interactive sites. Recently, it has been shown that a specific pentasaccharide sequence, which is present in only some of the heparin molecules, binds to AT III with high affinity to induce the conformational change needed for rapid interaction with clotting factors.

Inhibition of IIa requires both the mechanisms, but Xa inhibition can occur by mechanism 'b' alone. This probably explains why low molecular weight heparin, which is insufficient to provide a long scaffolding, selectively inhibits factor Xa.

Higher doses of heparin given for some time cause reduction in AT-III levels, probably a compensatory phenomenon. Sudden stoppage of conventional-dose therapy may result in rebound increase in coagulability for few days.

2. Antiplatelet Heparin in higher doses inhibits platelet aggregation and prolongs bleeding time.

3. Lipaemia clearing Injection of heparin clears turbid post-prandial lipaemic by releasing a lipoprotein lipase from the vessel wall and tissues, which hydrolyses triglycerides of chylomicra and very low density lipoproteins to free fatty acids; these then pass into tissues and the plasma looks clear. This action requires lower concentration of heparin than that needed for anticoagulation.

Facilitation of fatty acid transport may be the physiological function of heparin; but since, it is not found in circulating blood and its storage form in tissues is much less active, this seems only conjunctural.

PHARMACOKINETICS

Heparin is a large, highly ionized molecule; therefore not absorbed orally. Injected i.v. it acts instantaneously, but after s.c. injection anticoagulant effect develops after ~60 min. Bioavailability of s.c. heparin is inconsistent. Heparin does not

cross blood-brain barrier or placenta (it is the anticoagulant of choice during pregnancy). It is metabolized in liver by heparinase and fragments are excreted in urine.

Heparin released from mast cells is degraded by tissue macrophages—it is not a physiologically circulating anticoagulant.

After i.v. injection of doses < 100 U/kg, the $t_{1/2}$ averages 1 hr. Beyond this, dose-dependent inactivation is seen and $t_{1/2}$ is prolonged to 1–4 hrs. The $t_{1/2}$ is longer in cirrhotics and kidney failure patients, and shorter in patients with pulmonary embolism.

Unitage and administration Because of variable molecular size, heparin is standardized only by bioassay: 1 U is the amount of heparin that will prevent 1 ml of citrated sheep plasma from clotting for 1 hour after the addition of 0.2 ml of 1% CaCl₂ solution. Heparin sod. 1 mg has 120–140 U of activity.

HEPARIN SOD., BEPARINE, NUPARIN 1000 and 5000 U/ml in 5 ml vials for injection.

Heparin should not be mixed with penicillin, tetracyclines, hydrocortisone or NA in the same syringe or infusion bottle. Heparinized blood is not suitable for blood counts (alters the shape of RBCs and WBCs), fragility testing and complement fixation tests.

Dosage Heparin is conventionally given i.v. in bolus doses of 5,000–10,000 U (children 50–100 U/kg) every 4–6 hours, or the initial bolus dose is followed by continuous infusion of 750–1000 U/hr which may reduce the total dose needed and the incidence of bleeding. The dose and frequency is controlled by aPTT measurement which is kept at 50–80 sec. or 1.5–2.5 times the patient's pretreatment value. If this test is not available, whole blood clotting time should be measured and kept at ~2 times the normal value.

Deep s.c. injection of 10,000–20,000 U every 8–12 hrs can be given if repeated i.v. injection or infusion is not possible. Needle used should be fine and trauma should be minimum to avoid haematoma formation. Haematomas are more common with i.m. injection—this route should not be used.

Low dose (s.c.) regimen 5000 U is injected s.c. every 8–12 hours, started before surgery and continued for 7–10 days or till the patient starts moving about. This regimen has been found to prevent postoperative deep vein thrombosis without increasing surgical bleeding. It also does not prolong aPTT or clotting time. However, it should

not be used in case of neurosurgery or when spinal anaesthesia is to be given. The patients should not be receiving aspirin or oral anticoagulants. It is ineffective in high-risk situations, e.g. hip joint or pelvic surgery.

ADVERSE EFFECTS

1. Bleeding due to overdose is the most serious complication of heparin therapy. Haematuria is generally the first sign. With proper monitoring, serious bleeding is reported in 1–3% patients.
2. Thrombocytopenia is another common problem. Generally it is mild and transient; occurs due to aggregation of platelets. Occasionally serious thromboembolic events result. In some patients antibodies are formed to the heparin-platelet complex and marked depletion of platelets occurs—heparin should be discontinued. Even LMW heparins are not safe in such patients.
3. Transient and reversible alopecia is infrequent. Serum transaminase levels may rise.
4. Osteoporosis may develop on long-term use of relatively high doses.
5. Hypersensitivity reactions are rare—urticaria, rigor, fever and anaphylaxis. Patients with allergic diathesis are more liable.

Contraindications

1. Bleeding disorders, heparin induced thrombocytopenia.
2. Severe hypertension, (risk of cerebral haemorrhage), threatened abortion, piles, g.i. ulcers (risk of aggravated bleeding).
3. Subacute bacterial endocarditis (risk of embolism), large malignancies (risk of bleeding in the central necrosed area of the tumour), tuberculosis (risk of hemoptysis).
4. Ocular and neurosurgery, lumbar puncture.
5. Chronic alcoholics, cirrhosis, renal failure.
6. Aspirin and other antiplatelet drugs should be used very cautiously during heparin therapy.

Low molecular weight (LMW) heparins

Heparin has been fractionated into LMW forms (MW 3000–7000) by different techniques. LMW heparins have a different anticoagulant profile; selectively inhibit factor Xa with little effect on

IIa. They act only by inducing conformational change in AT III and not by bringing together AT III and thrombin. As a result, LMW heparins have smaller effect on aPTT and whole blood clotting time than unfractionated heparin (UFH) relative to antifactor Xa activity. Also, they appear to have lesser antiplatelet action—less interference with haemostasis. Thrombocytopenia is less frequent. A lower incidence of haemorrhagic complications compared to UFH has been reported in some studies, but not in others. However, major bleeding may be less frequent. The more important advantages of LMW heparins are pharmacokinetic:

- Better subcutaneous bioavailability (70–90%) compared to UFH (20–30%); Variability in response is minimized.
- Longer and more consistent monoexponential $t_{1/2}$: once daily s.c. administration.
- Since aPTT/clotting times are not prolonged, laboratory monitoring is not needed; dose is calculated on body weight basis.

Most studies have found LMW heparins to be equally efficacious to UFH. Indications of LMW heparins are:

1. Prophylaxis of deep vein thrombosis and pulmonary embolism in high-risk patients undergoing surgery; stroke or other immobilized patients.
2. Treatment of established deep vein thrombosis.
3. Unstable angina.
4. To maintain patency of cannulae and shunts in dialysis patients, and in extracorporeal circulation.

A number of LMW heparins have been marketed. They differ in composition, pharmacokinetics and dosage.

Enoxaparin: CLEXANE 20 mg (0.2 ml) and 40 mg (0.4 ml) prefilled syringes; 20–40 mg OD, s.c. (start 2 hour before surgery).

Reviparin: CLIVARINE 13.8 mg (eq. to 1432 anti Xa IU) in 0.25 ml prefilled syringe; 0.25 ml s.c. once daily for 5–10 days.

Nadroparin: FRAXIPARINE 3075 IU (0.3 ml) and 4100 IU (0.4 ml) inj., CARDIOPARIN 4000 anti Xa IU/0.4 ml, 6000 anti Xa IU/0.6 ml, 100, 000 anti Xa IU/10 ml inj.

Dalteparin: 2500 IU OD for prophylaxis; 100 U/Kg 12 hourly or 200 U/Kg 24 hourly for treatment of deep vein thrombosis. **FRAGMIN 2500, 5000 IU prefilled syringes.**

Pamparin: 0.6 ml s.c. OD for unstable angina and prophylaxis of DVT; **FLUXUM 3200 IU (0.3 ml), 6400 IU (0.6 ml) inj.**

Ardeparin: 2500-5000 IU OD; **INDEPARIN 2500 IU, 5000 IU prefilled syringes.**

Fondaparinux: The pentasaccharide with specific sequence that binds to AT III with high affinity to selectively inactivate factor Xa has been recently produced synthetically and given the name *fondaparinux*. It has been marketed in USA and some other countries.

HEPARINOIDS

Heparan sulfate It is a heparin-like natural substance found on cell surface and intercellular matrix in many tissues. It is a less potent anticoagulant than heparin, but may have a more favourable profile of action.

Danaparoid is a preparation containing mainly heparan sulfate, obtained from pig gut mucosa, which is used in cases with heparin induced thrombocytopenia.

Lepirudin This recombinant preparation of hirudin (a polypeptide anticoagulant secreted by salivary glands of leech) acts by inhibiting thrombin directly. It is indicated in patients with heparin induced thrombocytopenia.

Ancrod It is an enzyme obtained from Malayan pit viper venom. It degrades fibrinogen into an unstable form of fibrin which is taken up by RE cells. Thus, fibrinogen gets depleted and an apparent heparin like effect results. It is given only by slow infusion: 2 U/kg over 6 hours for deep vein thrombosis in patients who develop thrombocytopenia or hypersensitivity reactions to heparin and require immediate anticoagulation.

HEPARIN ANTAGONIST

Protamine sulfate It is a strongly basic, low molecular weight protein obtained from the sperm of certain fish. Given i.v. it neutralises heparin weight for weight, i.e. 1 mg is needed for every 100 U of heparin. For the treatment of heparin induced bleeding, due consideration must be given to the amount of heparin that may have been degraded by the patient's body in the mean time. However, it is needed infrequently because the action of heparin disappears by itself in a few hours, and whole blood transfusion is indicated to replenish the loss when bleeding occurs.

Protamine is more commonly used when heparin action needs to be terminated rapidly, e.g. after cardiac or vascular surgery.

In the absence of heparin, protamine itself acts as a weak anticoagulant by interacting with platelets and fibrinogen. Being basic in nature it can release histamine in the body. Hypersensitivity reactions have occurred. Rapid i.v. injection causes flushing and breathing difficulty.

PROTA, PROTAMINE SULFATE 50 mg in 5 ml inj.

ORAL ANTICOAGULANTS

A haemorrhagic disease was described in cattle in 1924 which was due to feeding them on spoiled sweet clover hay. The disorder was found to be due to prothrombin deficiency and the toxic principle was identified as bishydroxycoumarin in 1939. It was cured by feeding alfalfa grass. First clinical use of bishydroxycoumarin was made in 1941 and many congeners were added later. Warfarin was initially used as rat poison; demonstration of its safety led to clinical trial; it is now a commonly employed oral anticoagulant.

Action and mechanism

Warfarin and its congeners act as anticoagulants only *in vivo*, not *in vitro*. This is so because they act indirectly by interfering with the synthesis of vit K dependent clotting factors in liver. They apparently behave as competitive antagonists of vit K and reduce the plasma levels of functional clotting factors in a dose-dependent manner. In fact, they interfere with regeneration of the active hydroquinone form of vit K (Fig. 44.2) which carries out the final step of γ carboxylating glutamate residues of prothrombin and factors VII, IX and X. This carboxylation is essential for the ability of the clotting factors to bind Ca^{2+} and to get bound to phospholipid surfaces, necessary for coagulation sequence to proceed.

Factor VII has the shortest plasma $t_{1/2}$ (6 hr), its level falls first when warfarin is given, followed by factor IX ($t_{1/2}$ 24 hr), factor X ($t_{1/2}$ 40 hr) and prothrombin ($t_{1/2}$ 60 hr). Though the synthesis of clotting factors diminishes within 2–4 hours of warfarin administration, anticoagulant effect develops gradually over the next 1–3 days as the levels of the clotting factors already present in

Table 44.1: Pharmacokinetic and adverse effect profile of oral anticoagulants

Drug	$t_{1/2}$ (hour)	Duration of action (days)	Dose (mg)		Adverse side effects (other than bleeding)
			Loading	Maintenance*	
1. Bishydroxycoumarin	25–100 (dose dependent)	4–7	200 for 2 days	50–100	Frequent g.i.t. disturbances
2. Warfarin sod.	36–48	3–6	10–15	2–10 [‡]	Alopecia, dermatitis, diarrhoea
3. Acenocoumarol (Nicoumalone)	18–24	2–3	8–12	2–8	Oral ulceration, g.i.t. disturbances, dermatitis, urticaria, alopecia
4. Ethylbiscoumacetate	2	1–3	900	300–600	Alopecia, bad taste
5. Phenindione	5	1–3	200	50–100	Orange urine, rashes, fever, leukopenia, hepatitis, nephropathy, agranulocytosis

* Daily maintenance dose: to be adjusted by measurement of prothrombin time (INR).

[‡] To be taken in a single dose at the same hour (usually bed time) each day.

plasma decline progressively. Thus, there is always a delay between administration of the drug and the anticoagulant effect. Larger initial doses hasten the effect only slightly.

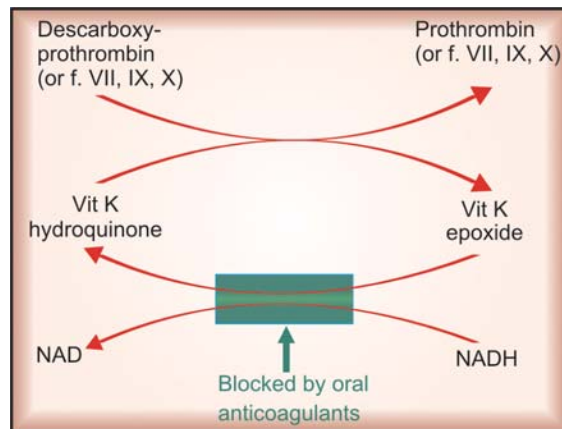

Fig. 44.2: Mechanism of action of oral anticoagulants
NAD—Nicotinamide adenine dinucleotide; NADH—its reduced form

Therapeutic effect occurs when synthesis of clotting factors is reduced by 40–50%.

Protein C, protein S, osteocalcin and some other proteins contain glutamate residues that require vit. K dependent γ carboxylation. These are also inhibited by oral anticoagulants, but density of adult bone is not affected, though new bone formation may be depressed.

The differences between different oral anticoagulants are primarily pharmacokinetic and in the adverse side effects produced by them. These are summarized in Table 44.1.

Recemic Warfarin sod. It is the most popular oral anticoagulant. The commercial preparation of warfarin is a mixture of R (dextrorotatory) and S (levorotatory) enantiomers. The S form is more potent and is metabolized relatively faster by ring oxidation, while R form is less potent and degraded by side chain reduction. Both are partially conjugated with glucuronic acid and undergo some enterohepatic circulation; finally excreted in urine.

Warfarin is rapidly and completely absorbed from intestines and is 99% plasma protein bound. It crosses placenta and is secreted in milk; however, quantity of active form is generally insufficient to affect the suckling infant.

UNIWARFIN 1, 2, 5 mg tabs; WARF-5: 5 mg tab.

Bishydroxycoumarin (Dicumarol) It is slowly and unpredictably absorbed orally. Its metabolism is dose dependent— $t_{1/2}$ is prolonged at higher doses. Has poor g.i. tolerance.

DICOUMAROL 50 mg tab.

Acenocoumarol (Nicoumalone) The $t_{1/2}$ of acenocoumarol as such is 8 hours, but an active

metabolite is produced so that overall $t_{1/2}$ is about 24 hours. Acts more rapidly.

ACITROM, 1, 2, 4 mg tabs.

Ethyl biscoumacetate It has a rapid and brief action; occasionally used to initiate therapy, but difficult to maintain.

Phenindione It produces more serious nonhaemorrhagic toxic effects: should not be used.

DINDEVAN 50 mg tab.

Adverse effects Bleeding as a result of extension of the desired pharmacological action is the most important problem: ecchymosis, epistaxis, hematuria, bleeding in the g.i.t. Intracranial or other internal haemorrhages may be fatal. This is more likely if therapy is not properly monitored or interacting drugs/contraindications are present.

Treatment: of bleeding due to oral anticoagulants consists of:

- Withhold the anticoagulant.
- Give fresh blood transfusion: supplies clotting factors and replenishes lost blood. Alternatively fresh frozen plasma may be used as a source of clotting factors.
- Give vit K₁—specific antidote (*see* p. 595), but it takes 6–24 hours for the clotting factors to be resynthesized and released in blood after vit K administration.

Adverse effects unrelated to anticoagulation are given in Table 44.1. Cutaneous necrosis is a rare complication that can occur with any oral anticoagulant.

Phenindione produces serious toxicity; should not be used (though still available).

Warfarin and acenocoumarol are considered to be the most suitable and better tolerated drugs.

Dose regulation The dose of oral anticoagulant must be individualised by repeated measurement of *prothrombin time*; the aim is to achieve a therapeutic effect without unduly increasing the chances of bleeding.

The optimum ratio of PT during treatment to the normal value (of the testing laboratory) has been defined for various indications. But this value differs depending on whether rabbit brain or human brain thromboplastin (Tp)

has been used for the test. A standardized system called the International Normalized Ratio (INR) based on the use of human brain Tp has been developed by WHO and adopted in all countries.

Recommended INR for various indications of oral anticoagulants

	INR
1. Prophylaxis of deep vein thrombosis and similar indications	2–2.5
2. Treatment of deep vein thrombosis, pulmonary embolism, TIAs, hip surgery	2–3
3. Recurrent thromboembolism, arterial disease (MI), prosthetic heart valves	3–3.5

Factors enhancing effect of oral anticoagulants are:

- Debility, malnutrition, malabsorption and prolonged antibiotic therapy: the supply of vit K to liver is reduced in these conditions.
- Liver disease, chronic alcoholism: synthesis of clotting factors may be deficient.
- Hyperthyroidism: the clotting factors are degraded faster.
- Newborns: have low levels of vit K and clotting factors (there should be no need of these drugs in neonates anyway).

Factors decreasing effect of oral anticoagulants are:

- Pregnancy: plasma level of clotting factors is higher.
- Nephrotic syndrome: drug bound to plasma protein is lost in urine.
- Genetic warfarin resistance: the affinity of warfarin (as well as of vit K epoxide) to bind to the reductase enzyme, which generates the active vit K hydroquinone, is low. Dose of oral anticoagulant is 4–5 times higher.

Contraindications All contraindications to heparin (p. 599) apply to these drugs as well. Factors which enhance the effect of oral anticoagulants (*see* above) should also be taken into consideration.

Oral anticoagulants should not be used during pregnancy. Warfarin given in early pregnancy increases birth defects, especially skeletal abnormalities: foetal warfarin syndrome—hypoplasia of nose, eye socket, hand bones, and growth

retardation. Given later in pregnancy, it can cause CNS defects, foetal haemorrhage, foetal death and accentuates neonatal hypoprothrombinemia.

Drug interactions A large number of drugs interact with oral anticoagulants at pharmacokinetic or pharmacodynamic level, and either enhance or depress their effect. These interactions are clinically important (may be fatal if bleeding occurs) and may involve more than one mechanism; the exact mechanism of an interaction is not always definable.

A. *Enhanced anticoagulant action*

1. Broad-spectrum antibiotics, inhibit gut flora and reduce vit K production.
2. Newer cephalosporins (cefamandole, moxalactam, cefoperazone) cause hypoprothrombinaemia by the same mechanism as warfarin—additive action.
3. Aspirin: inhibits platelet aggregation and causes g.i. bleeding—this may be hazardous in anticoagulated patients. High doses of salicylates have synergistic hypoprothrombinemic action and also displace warfarin from protein binding site.
4. Long acting sulfonamides, indomethacin, phenytoin and probenecid: displace warfarin from plasma protein binding.
5. Chloramphenicol, erythromycin, celecoxib, cimetidine, allopurinol, amiodarone and metronidazole: inhibit warfarin metabolism.
6. Tolbutamide and phenytoin: inhibit warfarin metabolism and *vice versa*.
7. Liquid paraffin (habitual use): reduces vit K absorption.

B. *Reduced anticoagulant action*

1. Barbiturates (but not benzodiazepines), rifampin and griseofulvin induce the metabolism of oral anticoagulants. The dose of anticoagulant determined during therapy with these drugs would be higher: if the same is continued after withdrawing the inducer—marked hypoprothrombinemia can occur—fatal bleeding is on record.

2. Oral contraceptives: increase blood levels of clotting factors.

USES OF ANTICOAGULANTS

The aim of using anticoagulants is to prevent thrombus extension and embolic complications by reducing the rate of fibrin formation. They do not dissolve already formed clot, but prevent recurrences. Heparin is utilized for rapid and short-lived action, while oral anticoagulants are suitable for maintenance therapy. Generally, the two are started together; heparin is discontinued after 4–7 days when warfarin has taken effect.

The important features of heparin and oral anticoagulants are compared in Table 44.2.

1. Deep vein thrombosis and pulmonary embolism Because venous thrombi are mainly fibrin thrombi, anticoagulants are expected to be highly effective. The best evidence of efficacy of anticoagulants comes from treatment and prevention of venous thrombosis and pulmonary embolism. Prophylaxis is recommended for all high risk patients including bedridden, old, postoperative, postpartum, poststroke and leg fracture patients. When deep vein thrombosis/pulmonary embolism has occurred, immediate heparin followed by warfarin therapy should be instituted. Three months anticoagulant therapy (continued further if risk factor persists) has been recommended by American College of Chest Physicians (2001).

Introduction of low dose heparin prophylaxis for patients undergoing elective surgery has considerably reduced the incidence of leg vein thrombosis and pulmonary embolism in the postoperative period. It has been extended to other situations needing prolonged immobilization. It is based on the premise that inhibition of small amount of activated factor X prevents further amplification of active products—particularly thrombin. This is the regimen of choice: does not need laboratory monitoring; spontaneous bleeding does not occur. LMW heparin is being preferred for this purpose.

Table 44.2: Some comparative aspects of heparin and oral anticoagulants

	<i>Heparin</i>	<i>Warfarin</i>
1. Chemistry	Mucopolysaccharide	Coumarin derivative
2. Source	Hog lung, pig intestine	Synthetic
3. Route of admin.	Parenteral (i.v., s.c.)	Oral
4. Onset of action	Immediate	Delayed (1–3 days)
5. Duration of action	4–6 hrs	3–6 days
6. Activity	<i>In vitro</i> and <i>in vivo</i>	<i>In vivo</i> only
7. Mechanism	Blocks action of factor X and thrombin	Inhibits synthesis of clotting factors
8. Antagonist	Protamine sulphate	Vit K
9. Variability in response	Little	Marked
10. Lab. control	a PTT/clotting time (desirable)	Prothrombin time/INR (essential)
11. Drug interactions	Few and not significant	Many and significant
12. Use	To initiate therapy	For maintenance

Anticoagulants are of little value in chronic peripheral vascular diseases.

2. Myocardial infarction (MI) Arterial thrombi are mainly platelet thrombi; anticoagulants are of questionable value. Their use in acute MI has declined. They do not alter immediate mortality of MI. It was hoped that anticoagulants will prevent extension of the thrombus and ward off a recurrent attack. This has not been supported by the collected statistics. They may benefit by preventing mural thrombi at the site of infarction and venous thrombi in leg veins. Thus, anticoagulants may be given for a short period till patient becomes ambulatory. For secondary prophylaxis against a subsequent attack—anticoagulants are inferior to antiplatelet drugs.

Heparin (i.v.) for 2–8 days followed by oral anticoagulants for 3 months or low dose s.c. heparin are generally given after recanalization of coronary artery by fibrinolytic therapy. Heparin is also used during coronary angioplasty and stent placement.

3. Unstable angina Short-term use of heparin has reduced the occurrence of MI in unstable angina patients; aspirin is equally effective.

Current recommendation is to use aspirin + heparin followed by warfarin.

4. Rheumatic heart disease; Atrial fibrillation (AF) Warfarin/low dose heparin/low dose aspirin are effective in preventing stroke (due to embolism from fibrillating atria). The ‘Stroke prevention in Atrial Fibrillation’ trial and a metaanalysis have shown warfarin to be more effective than aspirin. Current guideline is to give warfarin to a target INR of 2–3 in AF patients with high risk for stroke (elderly, heart failure, etc.), and to reserve aspirin for low risk patients or for those unable to take warfarin. Anticoagulants are given for 3–4 weeks before and after attempting conversion of AF to sinus rhythm.

5. Cerebrovascular disease Anticoagulants are of little value in cerebral thrombosis. They have been used with the aim of preventing clot propagation, but all the trials conducted, including International Stroke Trial (IST), have failed to demonstrate significant benefit. Neurological sequelae are similar whether they are used or not. Moreover, in the initial stages it is difficult to rule out cerebral haemorrhage (unless CAT scan

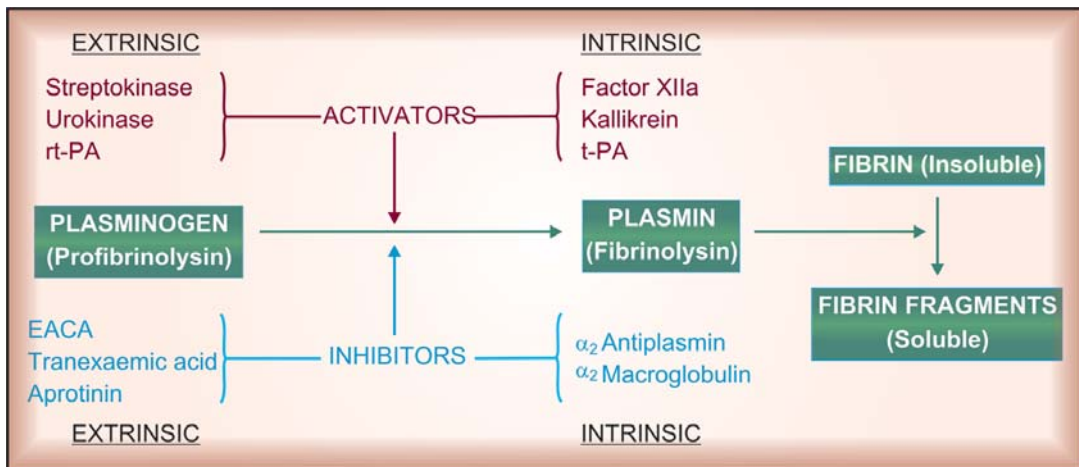

Fig. 44.3: The plasminogen-plasmin system

is done) in which they can be devastating. They may be used in cerebral embolism, because showers of emboli are often recurrent and can be prevented by anticoagulants. A late start (after one week) anticoagulant therapy is advocated by many in case of large embolic stroke. Oral anticoagulants may be beneficial in transient ischaemic attacks (TIAs), but antiplatelet drugs are simpler to use and probably better.

6. Vascular surgery, prosthetic heart valves, retinal vessel thrombosis, extracorporeal circulation, haemodialysis Anticoagulants are indicated along with antiplatelet drugs for prevention of thromboembolism.

Heparin flushes (200 U in 2 ml) every 4–8 hr are used to keep patent long-term intravascular cannulae/catheters.

7. Defibrination syndrome or 'disseminated intravascular coagulation' occurs in abruptio placentae and other obstetric conditions, certain malignancies and infections. The coagulation factors get consumed for the formation of intravascular microclots and blood is incoagulable. Heparin paradoxically checks bleeding in such patients by preserving the clotting factors. However, in some cases heparin may aggravate bleeding.

FIBRINOLYTICS (Thrombolytics)

These are drugs used to lyse thrombi/clot to recanalize occluded blood vessels (mainly coronary artery). They are curative rather than prophylactic; work by activating the natural fibrinolytic system (Fig. 44.3).

Haemostatic plug of platelets formed at the site of injury to blood vessels is reinforced by fibrin deposition to form a thrombus. Once repair is over, the fibrinolytic system is activated to remove fibrin. The enzyme responsible for digesting fibrin is a serine protease *Plasmin* generated from *plasminogen* by tissue plasminogen activator (t-PA), which is produced primarily by vascular endothelium. Plasminogen circulates in plasma as well as remains bound to fibrin. The t-PA selectively activates fibrin bound plasminogen within the thrombus, and any plasmin that leaks is inactivated by circulating antiplasmins. Fibrin bound plasmin is not inactivated by antiplasmins because of common binding site for both fibrin and antiplasmin.

When excessive amounts of plasminogen are activated (by administered fibrinolytics), the α_2 antiplasmin is exhausted and active plasmin persists in plasma. Plasmin is a rather nonspecific protease: degrades coagulation factors (including fibrinogen) and some other plasma proteins as well. Thus, activation of circulating plasminogen induces a lytic state whose major complication is haemorrhage. Even selective activation of thrombus bound plasmin can cause bleeding by dissolving physiological thrombi.

In general, venous thrombi are lysed more easily than arterial, and recent thrombi respond better: little effect on thrombi > 3 days old. The clinically important fibrinolytics are:

Streptokinase	Alteplase (rt-PA)
Urokinase	Retepase
	Tenecteplase

Streptokinase (Stk) It is obtained from β haemolytic *Streptococci* group C. It is inactive as such: combines with circulating plasminogen to form an activator complex which then causes limited proteolysis of other plasminogen molecules to plasmin. Antistreptococcal antibodies present due to past infections inactivate considerable fraction of the initial dose of Stk: a loading dose is necessary in the beginning. Its $t_{1/2}$ is estimated to be 30–80 min.

Streptokinase is antigenic; can cause hypersensitivity reactions and anaphylaxis, especially when used second time in a patient. Repeat doses are also less effective due to neutralization by antibodies. Fever is common, hypotension and arrhythmias are reported.

Because of the availability of newer fibrinolytics which do not pose some of the above problems, Stk is infrequently used now in developed countries. However, being the least expensive, it is still widely used in India and other developing countries.

STREPTASE, (freeze dried powder in vials) 2.5 lac, 7.5 lac and 15 lac IU/vial, **ESKINASE**, **CARDIOSTREP** 7.5 lac, 15 lac IU/vial.

For MI: 7.5–15 lac IU infused i.v. over 1 hr.

For deep vein thrombosis and pulmonary embolism: 2.5 lac IU loading dose over ½-1 hr, followed by 1 lac IU/hr for 24 hr.

Urokinase It is an enzyme isolated from human urine; now prepared from cultured human kidney cells, which activates plasminogen directly and has a plasma $t_{1/2}$ of 10–15 min. It is nonantigenic. Fever occurs during treatment, but hypotension and allergic phenomena are rare. Indicated in patients in whom streptokinase has been used for an earlier episode, use has now declined due to introduction of newer fibrinolytics.

UROKINASE, **KD-UNASE**, 2.5 lac, 5 lac, 10 lac IU per vial inj.

For MI: 2.5 lac IU i.v. over 10 min followed by 5 lac IU over next 60 min (stop in between if full recanalization occurs) or 6000 IU/min for upto 2 hr.

For venous thrombosis and pulmonary embolism: 4400 IU/kg over 10 min i.v. followed by 4400 IU/kg/hr for 12 hr.

Alteplase (*recombinant tissue plasminogen activator (rt-PA)*) Produced by recombinant DNA technology from human tissue culture, it specifically activates gel phase plasminogen already bound to fibrin, and has little action on circulating plasminogen. It is rapidly cleared by liver and has a plasma $t_{1/2}$ of 4–8 min. Because of the short $t_{1/2}$, it needs to be given by slow i.v. infusion and often requires heparin coadministration. It is nonantigenic, but nausea, mild hypotension and fever may occur. It is expensive.

ACTILYSE 50 mg vial with 50 ml solvent water.

For MI: 15 mg i.v. bolus injection followed by 50 mg over 30 min, then 35 mg over the next 1 hr.

For pulmonary embolism: 100 mg i.v. infused over 2 hr.

Retepase It is a modified form of rt-PA that is longer acting, but somewhat less specific for fibrin bound plasminogen. The longer duration of action enables bolus dose administration (10 mg over 10 min repeated after 30 min).

Tenecteplase It is a mutant variant of rt-PA with higher fibrin selectivity and longer duration of action. A single i.v. bolus dose (0.5 mg/kg) or split into two doses 30 min apart is given.

The clinical efficacy and risk of bleeding with reteplase and tenecteplase are similar to alteplase.

Uses of fibrinolytics

1. **Acute myocardial infarction** is the chief indication. Fibrinolytics are an alternative first line approach to emergency percutaneous coronary intervention (PCI) with stent placement. Recanalization of thrombosed coronary artery has been achieved in 50–90% cases. Time lag in starting the infusion is critical for reducing area of necrosis, preserving ventricular function and reducing mortality. The benefits of i.v. thrombolytic therapy have been established by large randomised studies. Aspirin with or without heparin is generally started concurrently or soon after thrombolysis to prevent reocclusion.

Alteplase has advantages over streptokinase, including higher thrombolytic efficacy. However, incidence of haemorrhage is not lower; may even be higher. Its stronger lytic effect on physiological haemostatic plugs may compensate for the lesser systemic fibrinolytic state.

Fibrinolytic therapy has also been used in unstable angina, because many such patients have coronary thrombi.

2. Deep vein thrombosis in leg, pelvis, shoulder etc.; up to 60% patients can be successfully treated. Thrombolytics can decrease subsequent pain and swelling, but the main advantage is preservation of venous valves and may be a reduced risk of pulmonary embolism, though at the risk of haemorrhage. Comparable results have been obtained with Stk, urokinase and rt-PA.

3. Pulmonary embolism Fibrinolytic therapy is indicated in large, life-threatening pulmonary embolism. The lung function may be better preserved, but reduction in mortality is not established.

4. Peripheral arterial occlusion Fibrinolytics recanalise ~40% limb artery occlusions, especially those treated within 72 hr. However, it is indicated only when surgical thrombectomy is not possible. Regional intraarterial fibrinolytics have been used for limb arteries with greater success. Peripheral arterial thrombolysis is followed by short-term heparin and long-term aspirin therapy.

Fibrinolytics have no role in chronic peripheral vascular diseases.

5. Stroke: Thrombolytic therapy of ischaemic stroke is controversial. Trials showing improved neurological outcome with no change in mortality, as well as those finding significant risk of intracranial haemorrhage and increased mortality are on record. No net benefit was concluded by the ATLANTIS trial in patients treated at 3–5 hours of stroke onset. However, rt-PA is approved for use in ischaemic stroke, and current opinion supports use of i.v. alteplase in carefully selected patients who can be treated

within 3 hours of onset, and in whom intracranial haemorrhage is ruled out along with all risk factors for bleeding.

Evaluation All patients with ST segment elevation myocardial infarction (STEMI) are candidates for reperfusion therapy. Both short-term and long-term outcome is determined by early restoration of flow in the occluded artery, regardless of whether it is achieved by thrombolysis or by PCI. Best results are obtained if perfusion can be restored within the first hour (the golden hour). While the efficacy of fibrinolytics in dissolving the thrombus diminishes with passage of time (little benefit after 6 hours of MI onset), reperfusion by PCI is not as much affected by the time lapse. Thrombolysis may be favoured if it can be started within 1–2 hours of onset. After 3 hours, PCI is favoured. Moreover, PCI has the advantage of lower bleeding risk, higher grade of flow in the reperfused artery and reduction in the rate of nonfatal recurrent MI compared to thrombolysis. As such, wherever available, PCI is being used in preference. Presence of risk factors for bleeding also favour PCI. However, the overall 6 month mortality has not been found to differ between either mode of reperfusion.

Invasive procedures, such as cardiac catheterization, should be avoided in patients who are to be given thrombolytics, because risk of bleeding is increased. With concurrent use of heparin, major bleeding (including intracranial haemorrhage) occurs in 2–4% patients. The incidence of bleeding is almost similar with Stk, urokinase and rt-PA. Analysis of recent trials has shown that exclusion of heparin reduces bleeding, and that heparin affords no extra benefit over fibrinolytic + aspirin. Another analysis has shown that efficacy of Stk and rt-PA in MI is similar, but certain other features favour the newer thrombolytics.

Thrombolytic therapy requires careful patient selection. It is contraindicated in all situations where the risk of bleeding is increased, such as—recent trauma, surgery, biopsies, haemorrhagic

stroke or peptic ulcer, severe hypertension, aneurysms, bleeding disorders, diabetes, acute pancreatitis, etc. Its use in retinal vessel occlusion has been abandoned.

ANTIFIBRINOLYTICS

These are drugs which inhibit plasminogen activation and dissolution of clot.

Epsilon amino-caproic acid (EACA) It is an analogue of the amino acid lysine: combines with the lysine binding sites of plasminogen and plasmin so that the latter is not able to bind to fibrin and lyse it. It is a specific antidote for fibrinolytic agents and has been used in many hyperplasmaemic states associated with excessive intravascular fibrinolysis resulting in bleeding, e.g.:

- Overdose of streptokinase/urokinase/alteplase.
- To prevent recurrence of subarachnoid and g.i. haemorrhage.
- Certain traumatic and surgical bleedings (prostatectomy, tooth extraction in haemophiliacs).
- Abruptio placentae, PPH and certain cases of menorrhagia.

However, the usefulness of EACA in most of the above conditions is equivocal, except in overdose of fibrinolytics. In haematuria it can cause ureteric obstruction by the unlysed clots. Therefore, fibrinolysis must be established firmly before using it. It can cause intravascular thrombosis. Rapid i.v. injection results in hypotension, bradycardia and may be arrhythmias. It should be used cautiously when renal function is impaired. Myopathy occurs rarely.

Initial priming dose is 5 g oral/i.v., followed by 1 g hourly till bleeding stops (max. 30 g in 24 hrs).

AMICAR, HEMOCID, HAMOSTAT 0.5 g tab., 1.25 g/5 ml syr., 5 g/20 ml inj.

Tranexaemic acid Like EACA, it binds to the lysine binding site on plasminogen and prevents its combination with fibrin and is 7 times more potent. It has been used for prevention of excessive bleeding in:

- Overdose of fibrinolytics
- After cardio-pulmonary bypass surgery.
- After tonsillectomy, prostatic surgery, tooth extraction in haemophiliacs.
- Menorrhagia, specially due to IUCD.
- Recurrent epistaxis, ocular trauma, bleeding peptic ulcer.

Main side effects are nausea and diarrhoea. Headache, giddiness and thrombophlebitis of injected vein are other adverse effects.

Dose: 10–15 mg/kg 2–3 times a day or 1–1.5 g TDS oral, 0.5–1 g TDS by slow i.v. infusion.

CYCLOKAPRON 500 mg tab, 100 mg/ml inj.

Aprotinin It is a polypeptide isolated from bovine tissues with polyvalent serine protease inhibitory activity: trypsin, chymotrypsin, kallikrein and plasmin are inhibited. It can be administered only i.v. and has a $t_{1/2}$ of 2 hr. It has been employed in selected situations:

Administered at the beginning of cardiopulmonary bypass surgery—it reduces blood loss.

Traumatic, haemorrhagic and endotoxic shock—has adjuvant value.

Acute pancreatitis (trypsin may be released in circulation which may be fatal).

Fibrinolytic states, prostatic surgery, carcinoid: may afford symptomatic relief.

Renal toxicity and ischaemic events like MI and stroke are the possible adverse effects.

Dose: 5 lac KIU (Kallikrein inactivator unit) initially, followed by 2 lac KIU every 4 hr, all as slow i.v. infusion;

TRASYLOL INF 5 lac KIU in 50 ml inj; **APROGEN** 1 lac KIU (10 ml) and 5 lac KIU (50 ml) inj.

ANTIPLATELET DRUGS (Antithrombotic drugs)

These are drugs which interfere with platelet function and are useful in the prophylaxis of thromboembolic disorders.

Platelets express several glycoprotein (GP) integrin receptors on their surface. Reactive proteins like collagen and von Willebrand factor (vWF) are exposed when there is damage to vascular endothelium, and they react respectively with platelet GPI_a and GPI_b receptors. This results in platelet activation and release of proaggregatory and vasoconstrictor mediators like TXA₂, ADP and 5-HT. The platelet GPII_b/III_a receptor undergoes a conformational change favouring binding of fibrinogen that cross links platelets inducing aggregation. Thus, a 'platelet plug' is formed. In veins, due to sluggish blood flow, a fibrinous tail is formed which traps RBCs 'the red tail'. In arteries,

platelet mass is the main constituent of the thrombus. Antiplatelet drugs are, therefore, more useful in arterial thrombosis, while anticoagulants are more effective in venous thrombosis.

Prostacyclin (PGI₂), synthesized in the intima of blood vessels, is a strong inhibitor of platelet aggregation. A balance between TXA₂ released from platelets and PGI₂ released from vessel wall appears to control intravascular thrombus formation. Platelets also play a role in atherogenesis.

In the above scheme, various drugs act on different targets to interfere with platelet function. The clinically important antiplatelet drugs are:

Aspirin	Clopidogrel
Dipyridamole	Abciximab
Ticlopidine	(GP II _b /III _a antagonist)

Aspirin It acetylates and inhibits the enzyme COX1 and TX-synthase—inactivating them irreversibly. Because platelets are exposed to aspirin in the portal circulation before it is deacetylated during first pass in the liver and because platelets cannot synthesize fresh enzyme (have no nuclei) TXA₂ formation is suppressed at very low doses and till fresh platelets are formed. Thus, aspirin induced prolongation of bleeding time lasts for 5–7 days. Effect of daily doses cumulates and it has now been shown that doses as low as 40 mg/day have an effect on platelet aggregation. Maximal inhibition of platelet function occurs at ~160 mg aspirin per day.

Aspirin also inhibits COX1 and PGI₂ synthesis in vessel wall. However, since intimal cells can synthesize fresh enzyme, activity returns rapidly. It is possible that at low doses (75–150 mg/day or 300 mg twice weekly), TXA₂ formation by platelets is selectively suppressed, whereas higher doses (> 900 mg/day) may decrease both TXA₂ and PGI₂ production.

Aspirin inhibits the release of ADP from platelets and their sticking to each other. However, it has no effect on platelet survival time and their adhesion to damaged vessel wall.

ASA 50 mg tab., COLSPRIN, DISPRIN CV-100: aspirin 100 mg soluble tab, LOPRIN 75 mg tab, ASPICOT 80 mg tab, ECOSPRIN 75, 150 mg tab.

Other NSAIDs are reversible inhibitors of COX, produce short-lasting inhibition of platelet function—are not clinically useful.

Dipyridamole It is a vasodilator which was introduced for angina pectoris (*see* Ch. 39). It inhibits phosphodiesterase and blocks uptake of adenosine to increase platelet cAMP which potentiates PGI₂ and interferes with aggregation. Levels of TXA₂ or PGI₂, are not altered, but platelet survival time reduced by disease is normalized.

Dipyridamole alone has little clinically significant effect, but improves the response to warfarin, along with which it is used to decrease the incidence of thromboembolism in patients with prosthetic heart valves.

Dipyridamole has also been used to enhance the antiplatelet action of aspirin, but trials have failed to demonstrate additional benefit in prophylaxis of MI. Risk of stroke in patients with transient ischaemic attacks (TIAs) may be additively reduced.

Dose: 150–300 mg/day. PERSANTIN 25, 100 mg tabs, THROMBONIL 75, 100 mg tabs, DYNASPRIN: dipyridamole 75 mg + aspirin 60 mg e.c. tab.

Ticlopidine It is the first thienopyridine which alters surface receptors on platelets and inhibits ADP as well as fibrinogen-induced platelet aggregation. The Gi coupled P2Y_{AC} (also labelled P2Y₁₂) type of purinergic receptors which mediate adenylyl cyclase inhibition by ADP are blocked irreversibly by ticlopidine. As a result, activation of platelets is interfered. It prevents fibrinogen binding to platelets without modifying GPII_b/III_a receptor. There is no effect on platelet TXA₂, but bleeding time is prolonged and platelet survival in extra-corporeal circulation is increased. Because of different mechanism of action, it has synergistic effect on platelets with aspirin: combination is a potent platelet inhibitor.

Ticlopidine is well absorbed orally, is converted in liver to an active metabolite, cumulates in the body—peak antiplatelet effect is produced after 8–10 days therapy. The plasma t_{1/2} after single dose is 8 hr, but after multiple doses it is 8 days.

Ticlopidine has produced beneficial effects in stroke prevention, TIAs, intermittent claudication, unstable angina, PCI, coronary artery bypass

grafts and secondary prophylaxis of MI. Combined with aspirin, it has markedly lowered incidence of restenosis after PCI and stent thrombosis. Because of its potential for serious adverse reactions, use of ticlopidine is restricted to supplementing aspirin or when aspirin is contraindicated.

Side effects: Diarrhoea, vomiting, abdominal pain, headache, tinnitus, skin rash. Serious adverse effects are bleeding, neutropenia, thrombocytopenia and jaundice. Several fatalities have occurred.

Dose: 250 mg BD with meals; effect persists several days after discontinuation; **TYKLID, TICLOVAS, TICLOP, 250 mg tab; ASTIC ticlopidine 250 mg + aspirin 100 mg tab.**

Clopidogrel This newer congener of ticlopidine has similar mechanism of action, ability to inhibit platelet function and therapeutic efficacy, but appears to be safer and better tolerated (CLASSICS study). The clopidogrel *vs* aspirin in patients at risk of ischaemic events (CAPRIE) trial has found clopidogrel recipients to have a slightly lower annual risk of primary ischaemic events than aspirin recipients. The most important adverse effect is bleeding. Addition of aspirin to clopidogrel has been found to double the incidence of serious bleeding among high risk stroke patients (MATCH study). A lower frequency of neutropenia, thrombocytopenia and other bone marrow toxicity compared to ticlopidine has been recorded. Side effects are diarrhoea, epigastric pain and rashes.

Clopidogrel + aspirin is as effective in stented patients as ticlopidine + aspirin. Clopidogrel is 50% absorbed orally and like ticlopidine, it is a prodrug; action lasts for upto 7 days.

Dose: 75 mg OD; **CLODREL, CLOPILET, DEPLATT 75 mg tab.**

Glycoprotein (GP) II_b/III_a receptor antagonists

GP II_b/III_a antagonists are a new class of potent platelet aggregation inhibitors which act by blocking the key receptor involved in platelet aggregation. The GP II_b/III_a is an adhesive

receptor (integrin) for fibrinogen and vWF through which agonists like collagen, thrombin, TXA₂, ADP, etc. induce platelet aggregation. Thus, GP II_b/III_a antagonists block aggregation induced by all platelet agonists.

Abciximab It is the Fab fragment of a chimeric monoclonal antibody against GP II_b/III_a. Given along with aspirin + heparin during PCI it has markedly reduced the incidence of restenosis, subsequent MI and death. After a bolus dose platelet aggregation remains inhibited for 12–24 hr, while the remaining antibody is cleared from blood with a t_{1/2} of 10–30 min.

Dose: 0.25 mg/kg i.v. 10–60 min before PCI, followed by 10 µg/min for 12 hr. **REOPRO 2 mg/ml inj.**

Abciximab is nonantigenic. The main risk is haemorrhage, incidence of which can be reduced by carefully managing the concomitant heparin therapy. Thrombocytopenia is another complication. Constipation, ileus and arrhythmias can occur. It is very expensive, but is being used in unstable angina and as adjuvant to coronary thrombolysis/PCI with stent placement.

Eptifibatide and Tirofiban respectively are peptide and nonpeptide GP II_b/III_a receptor antagonists, developed as alternatives to abciximab.

Uses of antiplatelet drugs

For certain indications like maintenance of vascular recanalization, stent placement, vessel grafting, etc. potent inhibition of platelet function is required. This is achieved by combining antiplatelet drugs which act by different mechanisms.

1. Coronary artery disease

MI: Low dose aspirin started immediately after MI has been found to reduce mortality and prevent reinfarction. It also improves survival when used along with thrombolytic therapy. Ticlopidine and clopidogrel are alternatives.

Aspirin is now routinely used to prevent reocclusion after thrombolytic therapy. It is also given along with heparin to cover PCI, and then continued indefinitely. Ticlopidine, clopidogrel

or abciximab used along with aspirin have markedly improved the outcome of PCI and stent procedures.

Unstable angina Aspirin reduces the risk of MI and sudden death in patients with unstable angina. For maximum benefit aspirin (100–150 mg/day) is given along with heparin—followed by warfarin. Ticlopidine or clopidogrel can be used as alternatives or adjuvant to aspirin.

The Clopidogrel in unstable angina to prevent recurrent events (CURE) trial has found that addition of clopidogrel to aspirin further reduced cardiovascular mortality, nonfatal MI and stroke by 20%.

Primary and secondary prevention of MI On the basis of trials in post-MI as well as in those with no such history, it has been recommended that aspirin 75–150 mg/day be given to all individuals with evidence of coronary artery disease and in those with risk factors for the same, but routine use in the whole population is not warranted. Aspirin reduces the incidence of fatal as well as nonfatal MI, but increases the risk of cerebral haemorrhage; overall mortality is marginally reduced.

2. Cerebrovascular disease Antiplatelet drugs do not alter the course of stroke due to cerebral thrombosis. However, aspirin has reduced the incidence of TIAs, of stroke in patients with TIAs or persistent atrial fibrillation and in those with history of stroke in the past. It is recommended in all such individuals. The European stroke prevention study-2 (ESPS) has found combination of dipyridamole with low dose aspirin to be

synergistic in secondary prevention of stroke. Ticlopidine and clopidogrel also reduce TIAs and stroke.

3. Coronary angioplasty, stents, bypass implants

The patency of recanalized coronary artery or implanted bypass vessel is improved and incidence of reocclusion is reduced by aspirin alone and in combination with ticlopidine/clopidogrel. Abciximab used along with aspirin and heparin has markedly reduced restenosis and subsequent MI after coronary angioplasty.

4. Prosthetic heart valves and arteriovenous shunts

Antiplatelet drugs, used with warfarin reduce formation of microthrombi on artificial heart valves and the incidence of embolism. Aspirin is clearly effective but increases risk of bleeding due to warfarin. Dipyridamole does not increase bleeding risk, but incidence of thromboembolism is reduced when it is combined with an oral anticoagulant. Antiplatelet drugs also prolong the patency of chronic arteriovenous shunts implanted for haemodialysis and of vascular grafts.

5. Venous thromboembolism Anticoagulants are routinely used. Trials have shown antiplatelet drugs also to have a prophylactic effect, but their relative value in comparison to or in addition to anticoagulants is not known.

6. Peripheral vascular disease Aspirin/ticlopidine/clopidogrel may produce some improvement in intermittent claudication and reduce the incidence of thromboembolism.

CHAPTER 45

Hypolipidaemic Drugs and Plasma Expanders

HYPOLIPIDAEMIC DRUGS

These are drugs which lower the levels of lipids and lipoproteins in blood.

The hypolipidaemic drugs have attracted considerable attention because of their potential to prevent cardiovascular disease by retarding the accelerated atherosclerosis in hyperlipidaemic individuals.

Lipid transport

Lipids are carried in plasma in lipoproteins after getting associated with several apoproteins; plasma lipid concentrations are dependent on the

concentration of lipoproteins. The core of lipoprotein globules consists of triglycerides (TGs) or cholesteryl esters (CHEs) while the outer polar layer has phospholipids, free cholesterol (CH) and apoproteins. The lipoproteins have been divided into 6 classes on the basis of their particle size and density. They also differ in the nature of apoproteins, the ratio of TG and CHE, tissue of origin and fate. These are given in Table 45.1.

Dietary lipids are absorbed in the intestine with the help of bile acids. Chylomicrons (Chy) are formed and passed into lacteals—reach blood stream *via* thoracic duct. During their passage through capillaries, the endothelium bound lipoprotein lipase hydrolyses the TGs into fatty acids which

Table 45.1: Characteristics and function of plasma lipoproteins

Lipoprotein class	Diameter (nm)	Lipid contained	Source of lipid	Function
1. Chy.	100–500	TG >> CHE	Diet	Dietary TG transport
2. Chy. rem.	30–50	CHE >> TG	Diet, Chy.	Dietary CH transport
3. VLDL	40–80	TG >> CHE	Liver	Endogenous TG transport
4. IDL	30–35	CHE ≥ TG	VLDL	Transport CHE & TG to liver, source of LDL
5. LDL	20–25	CHE	IDL	Transport CH to tissues and liver
6. HDL	5–10	Phospholipid, CHE	Tissues, cell memb.	Removal of CH from tissues

Chy—Chylomicrons; Chy. rem.—Chylomicron remnant; VLDL—Very low density lipoprotein; IDL—Intermediate density lipoprotein; LDL—Low density lipoprotein; HDL—High density lipoprotein; CHE—Cholesteryl esters; TG—Triglyceride; CH—Cholesterol

Table 45.2: Types of primary hyperlipoproteinaemias

Type	Disorder	Cause	Occurrence	Elevated plasma lipoprotein	Plasma lipids	
					CH	TG
I	Familial lipoprotein lipase deficiency	G	Very rare	Chylomicron	↑↑	↑↑↑
IIa	Familial hypercholesterolaemia	G	Less common	LDL	↑↑	N
IIb	Polygenic hypercholesterolaemia	MF	Commonest	LDL	↑	N
III	Familial dysbetalipoproteinaemia	G	Rare	IDL, Chy. rem.	↑	↑
IV	Hypertriglyceridaemia	MF, G	Common	VLDL	N	↑↑
V	Familial combined hyperlipidaemia	G	Less common	VLDL, LDL	↑	↑

CH—Cholesterol; TG—Triglycerides; G—Genetic; MF—Multifactorial; Chy. rem.—Chylomicron remnants; VLDL—very low density lipoprotein; IDL—Intermediate density lipoprotein; LDL—Low density lipoprotein.

The genetic defect in some of the monogenic disorders is:

Type I : absence of lipoprotein lipase—TG in Chy cannot be utilized.

Type IIa : deficiency of LDL receptor—LDL and IDL are taken up very slowly by liver and tissues.

Type III : the apoprotein in IDL and Chy. rem. (apoE) is abnormal, these particles are cleared at a lower rate.

Type IV : this type of hypertriglyceridaemia is both multifactorial and monogenic, the former is more prevalent than the latter.

pass into muscle cells to be utilized as energy source and in fat cells to be reconverted into TGs and stored. The remaining part—chylomicron remnant (Chy. rem.) containing mainly CHE and little TG is engulfed by liver cells, which have receptors for the surface apoproteins of Chy. rem., and digested. Free CH that is liberated is either stored in liver cells after reesterification or incorporated into a different lipoprotein and released in blood or excreted in bile as CH/bile acids.

Liver secretes *very low density lipoproteins (VLDL)* containing mainly TG and some CHE into blood. VLDL is acted upon by endothelial lipoprotein lipase in the same way as on Chy and the fatty acids pass into adipose tissue and muscle; the remnant called *intermediate density lipoprotein (IDL)* now contains more CHE than TG. About half of the IDL is taken back by the liver cells by attachment to another receptor (LDL receptor), while the rest loses the remaining TGs gradually and becomes *low density lipoprotein (LDL)* containing only CHE. The LDL circulates in plasma for a long time; its uptake into liver and other tissues is dependent on the need for CH. The rate of LDL uptake is regulated by the rate of LDL receptor synthesis in a particular tissue.

The CHE of LDL is deesterified and used mainly for cell membrane formation. The CH released into blood from

degradation of membranes is rapidly incorporated in *high density lipoproteins (HDL)*, esterified with the help of an enzyme lecithin: cholesterol acyltransferase (LCAT) and transferred back to VLDL or IDL, completing the cycle.

The excess lipoproteins in plasma are phagocytosed by macrophages for disposal. When too much of lipoproteins have to be degraded in this manner, CH is deposited in *atheromas* (in arterial walls) and *xanthomas* (in skin and tendons). Raised levels of VLDL, IDL and LDL (rarely Chy and Chy. rem. also) are atherogenic, while HDL may be protective, because HDL facilitates removal of CH from tissues.

Hyperlipoproteinaemias can be:

(i) *Secondary*: associated with diabetes, myxoedema, nephrotic syndrome, chronic alcoholism, drugs (corticosteroids, oral contraceptives, β blockers) etc.

(ii) *Primary*: due to:

(a) A single gene defect: is familial and called 'monogenic' or *genetic*.

(b) Multiple genetic, dietary and physical activity related causes: 'polygenic' or *multifactorial*.

On the whole, LDL is the primary carrier of plasma CHE, and VLDL that of TGs. The important features of major types of hyperlipoproteinaemias are given in Table 45.2.

CLASSIFICATION

1. **HMG-CoA reductase inhibitors (Statins):**
Lovastatin, Simvastatin, Pravastatin, Atorvastatin, Rosuvastatin
2. **Bile acid sequestrants (Resins):**
Cholestyramine, Colestipol
3. **Activate lipoprotein lipase (Fibric acid derivatives):** Clofibrate, Gemfibrozil, Bezafibrate, Fenofibrate.
4. **Inhibit lipolysis and triglyceride synthesis:**
Nicotinic acid
5. **Others:** Ezetimibe, Gugulipid.

The mechanism of action and profile of lipid lowering effect of important hypolipidaemic drugs is summarized in Table 45.3.

HMG-CoA REDUCTASE INHIBITORS (STATINS)

Introduced in the 1980s, this class of compounds are the most efficacious and best tolerated hypolipidaemic drugs. They competitively inhibit

conversion of 3-Hydroxy-3-methyl glutaryl coenzyme A (HMG-CoA) to mevalonate (rate limiting step in CH synthesis) by the enzyme HMG-CoA reductase. Therapeutic doses reduce CH synthesis by 20–50%. This results in compensatory increase in LDL receptor expression on liver cells → increased receptor mediated uptake and catabolism of IDL and LDL. Over long-term, feedback induction of HMG-CoA reductase tends to increase CH synthesis, but a steady-state is finally attained with a dose-dependent lowering of LDL-CH levels.

Different statins differ in their potency and maximal efficacy in reducing LDL-CH. The daily dose for lowering LDL-CH by 30–35% is lovastatin 40 mg, pravastatin 40 mg, simvastatin 20 mg, atorvastatin 10 mg, rosuvastatin 5 mg. Moreover, at their maximum recommended doses simvastatin, atorvastatin and rosuvastatin can reduce LDL-CH by upto 45–55%, while the ceiling effect of lovastatin and pravastatin is 35–40% LDL-CH reduction. All statins produce peak LDL-CH lowering after 1–2 weeks therapy. Hepatic synthesis of VLDL is concurrently reduced and its removal from plasma is enhanced.

A dose-dependent effect is seen with all statins. With lovastatin a mean reduction of LDL-

Table 45.3: Mechanism of action and pattern of lipid lowering effect of important hypolipidaemic drugs

Drug (daily dose)	Mechanism of action	Effect on lipids (%)
HMG-CoA reductase inhibitors		
Lovastatin (10–80 mg)	↓ CH synthesis by inhibition of rate limiting HMG-CoA reductase	LDL ↓ 20–55
Simvastatin (5–40 mg)		HDL ↑ 5–15
Atorvastatin (10–80 mg)		TG ↓ 10–35
Rosuvastatin (5–20 mg)		
Bile acid sequestrants		
Cholestyramine (4–16 g)	↓ bile acid absorption, ↑ hepatic conversion of CH to bile acids, ↑ LDL receptors on hepatocytes	LDL ↓ 15–30
Colestipol (5–30 g)		HDL ↑ 3–5 TG not affected, may ↑ in some
Fibric acid derivatives		
Gemfibrozil (1200 mg)	↑ Activity of lipoprotein lipase, ↓ release of fatty acids from adipose tissue	LDL ↓ 5–20
Bezafibrate (600 mg)		may ↑ LDL when TG is high
Fenofibrate (200 mg)		HDL ↑ 10–20 TG ↓ 20–50
Nicotinic acid (2–6 g)		
	↓ Production of VLDL, ↓ lipolysis in adipocytes	LDL ↓ 15–25 HDL ↑ 20–35 TG ↓ 20–50

CH by 25% at 20 mg/day, 32% at 40 mg/day and 40% at 80 mg/day has been measured. A concurrent fall by 10–30% in plasma TG level, probably due to reduction of VLDL occurs. A rise in HDL-CH by 5–15% is also noted. Simultaneous use of bile salt sequestrant augments the LDL lowering effect upto 60% and addition of nicotinic acid to this combination may boost the effect to 70% reduction in LDL-CH. Statins are effective in secondary hypercholesterolaemias also. The more efficacious statins (simvastatin, atorvastatin, rosuvastatin) given at their higher doses effectively reduce TGs (by 25% to 35%) when they are moderately raised, but not when they are markedly raised.

Because HMG-CoA reductase activity is maximum at midnight, all statins are administered at bed time to obtain maximum effectiveness. However, this is not necessary for atorvastatin and rosuvastatin, which have long plasma $t_{1/2}$.

All statins, except rosuvastatin are metabolized primarily by CYP3A4. Inhibitors and inducers of this isoenzyme respectively increase and decrease statin blood levels.

Lovastatin It is the first clinically used statin; is lipophilic and given orally in the precursor lactone form. Absorption is incomplete and first pass metabolism is extensive. Metabolites are excreted mainly in bile. The $t_{1/2}$ is short (1–4 hours).

Dose: 10–40 mg/day (max. 80 mg).

ROVACOR, AZTATIN, LOVAMEG 10, 20 mg tabs.

Simvastatin It is twice as potent as lovastatin; also more efficacious. A greater rise in HDL-CH (when low) has been noted with simvastatin than others. Like lovastatin, it is lipophilic and given in the lactone precursor form. Oral absorption is better and first pass metabolism extensive; $t_{1/2}$ is 2–3 hr.

Dose: 5–20 mg/day (max. 40 mg)

SIMVOTIN, SIMCARD, ZOSTA 5, 10, 20 mg tabs.

Pravastatin It is hydrophilic and given in the active form. At low doses it is equipotent to lovastatin, but at higher doses (40–80 mg/day), CH lowering effect is less. It can be employed when

reduction of LDL-CH by $\leq 25\%$ is contemplated. An additional action of decrease in plasma fibrinogen level has been observed. The $t_{1/2}$ is 1–3 hours.

PRAVATOR 10, 20 mg tabs.

Atorvastatin This newer statin is more potent and appears to have the highest LDL-CH lowering efficacy at maximal daily dose of 80 mg. At this dose a greater reduction in TGs is noted if the same was raised at baseline. Atorvastatin has a much longer plasma $t_{1/2}$ of 18–24 hr than other statins, and has additional antioxidant property.

Dose: 10–40 mg/day (max. 80 mg)

AZTOR, ATORVA, ATORLIP 10, 20 mg tabs.

Rosuvastatin This is the latest and the most potent statin (10 mg rosuvastatin \simeq 20 mg atorvastatin), with a plasma $t_{1/2}$ of 18–24 hours. Greater LDL-CH reduction can be obtained in severe hypercholesterolaemia; partly due to its longer persistence in the plasma. In patients with raised TG levels, rosuvastatin raises HDL-CH by 15–20% (greater rise than other statins).

Dose: Start with 5 mg OD, increase if needed upto 20 mg/day, (max 40 mg/day)

ROSUVAS, ROSYN 5, 10, 20 mg tabs.

Adverse effects All statins are remarkably well tolerated; overall incidence of side effects not differing from placebo. Notable side effects are:

- Headache, nausea, bowel upset, rashes.
- Sleep disturbances (probably more with lipophilic drugs).
- Rise in serum transaminase can occur, but liver damage is rare.
- Muscle tenderness and rise in CPK levels occurs infrequently. Myopathy is the only serious reaction, but is rare (< 1 per 1000). Few fatalities due to rhabdomyolysis are on record. Myopathy is more common when nicotinic acid/gemfibrozil or CYP3A4 inhibitor—ketoconazole/ erythromycin/cyclosporine/ HIV protease inhibitor is given concurrently. Gemfibrozil inhibits the hepatic uptake of statins by the organic anion transporter OATP2. Fenofibrate interferes the least with

statin uptake/metabolism and should be preferred for combining with them.

Use Statins are the first choice drugs for primary hyperlipidaemias with raised LDL and total CH levels, with or without raised TG levels (Type IIa, IIb, V), as well as for secondary (diabetes, nephrotic syndrome) hypercholesterolaemia.

Efficacy of statins in reducing raised LDL-CH associated mortality and morbidity is now well established.

In the 'Scandinavian Simvastatin Survival Study' (4S study, 1994), patients with history of MI (80%) or angina (20%) and raised serum CH level (> 212 mg/dl) were treated with simvastatin or placebo. Simvastatin reduced total CH by 25%, LDL-CH by 35%, raised HDL-CH by 8%. Over a period of 6 years coronary artery disease (CAD) mortality was less by 42%, overall mortality by 30% and cerebrovascular events by 30% in the simvastatin group. Similar results have been obtained with other statins, e.g. the West of Scotland Coronary Prevention Study (WOSCOPS) in men with no history of MI has found pravastatin to lower risk of MI by 31% and all cause mortality by 22%.

Subsequent studies like Long-term intervention with pravastatin in ischaemic disease (LIPID-1998), Airforce/Texas coronary atherosclerosis prevention study (AFCAPS/TexCAPS-1998), Cholesterol and recurrent events (CARE-1998), and trials conducted by Heart Protection Study Collaborative Group (2002, 2004) in over 20,000 patients have confirmed the mortality and morbidity benefits of statins, including stroke prevention.

Beneficial effects in subjects who have raised CH levels but no evidence of CAD may relate to improved coronary artery compliance and atheromatous plaque stabilization due to suppression of macrophage mediated inflammation, reducing chances of plaque rupture and thrombus formation. Improvement in endothelial function due to increased NO production and reduction in LDL oxidation are proposed as additional mechanisms by which statins may exert anti-atherosclerotic action. On the basis of these results as well as the excellent patient acceptability, the statins are being increasingly used for primary and secondary hypercholesterolaemia with or without raised TG levels. They are the first choice drugs for dyslipidaemia in diabetics.

BILE ACID SEQUESTRANTS (RESINS)

Cholestyramine and Colestipol These are basic ion exchange resins supplied in the chloride form. They are neither digested nor absorbed in the gut: bind bile acids in the intestine interrupting their enterohepatic circulation. Faecal excretion of bile salts and CH (which is absorbed with the help of bile salts) is increased. This indirectly leads to enhanced hepatic metabolism of CH to bile acids. More LDL receptors are expressed on liver cells: clearance of plasma IDL, LDL and indirectly that of VLDL is increased.

Resins have been shown to retard atherosclerosis, but are not popular clinically because they are unpalatable, inconvenient, have to be taken in large doses, cause flatulence and other g.i. symptoms, interfere with absorption of many drugs and have poor patient acceptability.

FIBRIC ACID DERIVATIVES

The fibrates (isobutyric acid derivatives) primarily activate lipoprotein lipase which is a key enzyme in the degradation of VLDL resulting in lowering of circulating TGs. This effect is exerted through peroxisome proliferator-activated receptor α (PPAR α) that is a gene transcription regulating receptor expressed in liver, fat and muscles. Activation of PPAR α enhances lipoprotein lipase synthesis and fatty acid oxidation. PPAR α may also mediate enhanced LDL receptor expression in liver seen particularly with second generation fibrates. Fibrates decrease hepatic TG synthesis as well. A peripheral effect reducing circulating free fatty acids has also been shown.

Drugs in this class primarily lower TG levels by 20–50%, generally accompanied by 10–15% decrease in LDL-CH and a 10–15% increase in HDL-CH. In some patients with hypertriglyceridaemia LDL-CH may rise, partly because of inability of LDL receptor to clear the excess number of LDL particles generated by enhanced VLDL catabolism. The increase in HDL-CH is at least in part due to transfer of surface lipid components from catabolized VLDL to HDL, and partly due to increased production of HDL apoproteins (apo A-I, apo A-II) by liver. Gemfibrozil also appears to reduce VLDL secretion by liver.

LDL composition may be altered. Gemfibrozil and bezafibrate have been shown to shift small dense LDL particles (believed to be more atherogenic) to larger less dense particles.

Clofibrate It was a widely used hypolipidaemic drug, but later evidence showed that it does not prevent atherosclerosis, therefore has gone out of use.

Gemfibrozil This fibric acid derivative effectively lowers plasma TG level by enhancing breakdown and suppressing hepatic synthesis of TGs. Besides high efficacy in type III hyperlipoproteinemia, gemfibrozil has shown action in subjects with raised blood CH in addition. In the 'Helsinki Heart Study' men without known CAD treated with gemfibrozil had a 34% reduction in fatal and nonfatal MI, though overall mortality was not affected. Additional actions to decrease the level of clotting factor VII-phospholipid complex and promotion of fibrinolysis have been observed, which may contribute to the antiatherosclerotic effect.

Pharmacokinetics Gemfibrozil is completely absorbed orally, metabolized by glucuronidation and undergoes some enterohepatic circulation. It is excreted in urine; elimination $t_{1/2}$ 1–2 hr.

Adverse effects Common side effects are epigastric distress, loose motions. Skin rashes, body ache, eosinophilia, impotence, headache and blurred vision have been reported. Myopathy is uncommon. Gemfibrozil + statin increases risk of myopathy. Incidence of gallstone is not increased as seen with clofibrate.

It is contraindicated during pregnancy.

GEMPAR, **NORMOLIP** 300 mg cap. **LOPID** 300 mg cap, 600 mg and 900 mg tabs.

Use In a dose of 600 mg BD taken before meals, gemfibrozil is the drug of choice for patients with markedly raised TG levels, whether or not CH levels are also raised. Episodes of acute pancreatitis are prevented in patients with chylomicronaemia and severe hypertriglyceridaemia. It is most effective in type III hyperlipoproteinaemia; also a first line drug in type IV and type V disease.

It may be used as an adjuvant drug in type IIb patients.

Bezafibrate This second generation fibric acid derivative is an alternative for gemfibrozil in mixed hyperlipidaemias (type III, IV and V). Though it has also been indicated in hypercholesterolaemia (type II), it is inferior to statins and resins. It has not shown propensity to increase LDL-CH in hypertriglyceridaemic patients and appears to have greater LDL-CH lowering action than gemfibrozil. Decreased level of circulating fibrinogen and glucose has been demonstrated. The 5 year 'Bezafibrate Coronary Atherosclerosis Intervention Trial' (BECAIT) in young male post-MI subjects has shown it to slow atherosclerotic process and reduce coronary events.

Adverse effects and contraindications of bezafibrate are similar to other fibrates. Main side effects are g.i. upset, myalgia, rashes. Dose reduction is needed in elderly and in renal insufficiency. Action of oral anticoagulants may be enhanced.

In contrast to other fibrates, combination of bezafibrate with a statin has not so far been found to increase the incidence of rhabdomyolysis.

Dose: 200 mg TDS with meals.

BEZALIP 200, 400 mg tab.

Fenofibrate Another 2nd generation prodrug fibric acid derivative which has greater HDL-CH raising and greater LDL-CH lowering action than other fibrates: may be more appropriate as an adjunctive drug in subjects with raised LDL-CH levels in addition to raised TG levels. No rise in LDL-CH has been observed in patients with high TG levels. Its $t_{1/2}$ is 20 hr. Adverse effects are myalgia, hepatitis, rashes. Cholelithiasis and rhabdomyolysis are rare. Fenofibrate appears to be the most suitable fibrate for combining with statins, because statin metabolism is minimally affected and enhancement of statin myopathy risk is lower. Indications of fenofibrate are similar to that of gemfibrozil.

Dose: 200 mg OD with meals.

FENOLIP, **LIPICARD** 200 mg cap.

NICOTINIC ACID (NIACIN)

It is a B group vitamin (*see* Ch. 67) which in much higher doses reduces plasma lipids. This action is unrelated to its vitamin activity and not present in nicotinamide. When nicotinic acid is given, TGs and VLDL decrease rapidly, followed by a modest fall in LDL-CH and total CH. A 20–50% reduction in plasma TGs and 15–25% reduction in CH levels has been recorded. Nicotinic acid is the most effective drug to raise HDL-CH; a 20–35% increase is generally obtained. Relatively lower dose suffices to raise HDL-CH.

Nicotinic acid reduces production of VLDL in liver by inhibiting TG synthesis. Indirectly the VLDL degradation products IDL and LDL are also reduced. No direct effect on CH and bile acid metabolism has been found. It inhibits intracellular lipolysis in adipose tissue and increases the activity of lipoprotein lipase that clears TGs.

A cell surface G-protein coupled receptor which negatively regulates adipocyte adenylyl cyclase has been found to selectively bind nicotinic acid, and has been called 'niacin receptor'. Nicotinic acid appears to inhibit lipolysis in adipose tissue by decreasing hormone stimulated intracellular cAMP formation through this receptor. Hepatic VLDL production is believed to be decreased due to reduced flow of fatty acids from adipose tissue to liver.

Adverse effects The large doses needed for hypolipidaemic action are poorly tolerated. Only about half of the patients are able to take the full doses.

Nicotinic acid is a cutaneous vasodilator: marked flushing, heat and itching (especially in the blush area) occur after every dose. This can be minimized by starting with a low dose taken with meals and gradually increasing as tolerance develops. Aspirin taken daily largely prevents the reaction (PGs may be involved).

Dyspepsia is very common; vomiting and diarrhoea occur when full doses are given. Peptic ulcer may be activated.

Dryness and hyperpigmentation of skin can be troublesome. Other long-term effects are:

Liver dysfunction and jaundice. Serious liver damage is the most important risk.

Hyperglycaemia, precipitation of diabetes (should not be used in diabetics).

Hyperuricaemia and gout, atrial arrhythmias.

It is contraindicated during pregnancy and in children.

Interaction Postural hypotension may occur in patients on antihypertensives when they take nicotinic acid.

Risk of myopathy due to statins is increased.

Dose: Start with 100 mg TDS, gradually increase to 2–6 g per day in divided doses. It should be taken just after food to minimize flushing and itching.

NIALIP 250, 375, 500 mg tabs.

Use Nicotinic acid is a wide spectrum hypolipidaemic drug. It is highly efficacious in hypertriglyceridaemia (type III, IV, V) whether associated with raised CH level or not. It is mostly used to lower VLDL and raise HDL levels, and as an adjunctive drug to statins/fibrates.

Nicotinic acid is the most effective drug in reducing plasma TG levels and controlling pancreatitis in genetic type IV and type V disorders. Long-term use prevents further attacks of pancreatitis. Given over long-term in post-MI patients, it has been found to reduce recurrences of MI and overall mortality. However, because of marked side effects, use of nicotinic acid is restricted to high-risk cases only.

OTHER HYPOLIPIDAEMICS

1. Ezetimibe It is a new drug of its own kind that acts by inhibiting intestinal absorption of cholesterol and phytosterols. It interferes with a specific CH transport protein NPC1C1 in the intestinal mucosa and reduces absorption of both dietary and biliary CH. There is compensatory increase in hepatic CH synthesis, but LDL-CH level is lowered by 15–20%. The enhanced CH synthesis can be blocked by statins, and the two drugs have synergistic LDL-CH lowering effect.

Due to very poor aqueous solubility, ezetimibe is not absorbed as such. It is absorbed partly after getting conjugated with glucuronic acid in the intestinal mucosa → secreted in bile → undergoes

Table 45.4: Interpretation of plasma lipid levels*

	Total CH	Plasma lipid levels (mg/dl)		
		LDL-CH	HDL-CH	TGs
1. Optimal/desirable	< 200	< 100 (< 70 for CAD pts)	> 40 (men) > 50 (women)	< 150
2. Borderline high	200–239	130–159	—	150–199
3. High	≥ 240	160–189	> 60	200–499
4. Very high	—	≥190	—	≥ 500

* Adopted from NCEP (2001)

enterohepatic circulation and is mainly excreted in faeces. A plasma $t_{1/2}$ of 22 hours has been calculated.

Used alone, ezetimibe is a weak hypocholesterolaemic drug; LDL-CH lowering beyond 15–20% is not obtained by increasing the dose. Though it may be used alone in mild hypercholesterolaemia when a statin is contraindicated/not tolerated, its main value is to supplement statins without increasing their dose. The combination of ezetimibe + low dose of a statin is as effective in lowering LDL-CH as high dose of statin alone. Upto 60% decrease in LDL-CH level has been obtained with a combination of simvastatin + ezetimibe. No specific adverse effect, except reversible hepatic dysfunction and rarely myositis has been noted with ezetimibe.

Dose: 10 mg OD; **ZETICA, EZEDOC 10 mg tab.**

2. Gugulipid It is a mixture of sterones obtained from 'gum guggul' which has been used in Ayurveda. Modest lowering of plasma CH and TGs occurs after continued use of gugulipid. It is well tolerated: loose stools are the only significant side effect.

Dose: 25 mg TDS; **GUGLIP 25 mg tab.**

Comments on the use of hypolipidaemic drugs

Raised plasma CH is a major risk factor for coronary artery disease (CAD); higher the CH level, greater is the risk of CAD. Abundant data has confirmed that lowering the level of LDL-CH,

when the same is high, results in decreased incidence of cardiovascular mortality and morbidity. More recent evidence (HPS, 2002; ASCOT-LLA, 2003 studies) has indicated that prophylactic use of a statin in CAD/hypertensive patients even with average or lower than average CH levels lowers coronary and stroke events. With the availability of effective, well tolerated and safe hypolipidaemic drugs, it has become a standard practice to prescribe statin therapy after an acute coronary event irrespective of lipid levels. Evidence that elevated plasma TG level or low plasma HDL-CH level poses independent high risk of CAD and stroke is also now quite strong.

Whereas raised LDL-CH is atherogenic, a higher HDL-CH level is either itself protective or indicates a low atherogenic state.

The US National Cholesterol Education Programme (NCEP) in its third report (2001) delineated the optimal levels of plasma lipids and various grades of hyperlipidaemias (Table 45.4) and revised the guidelines for use of hypolipidaemic drugs (Adult Treatment Panel III or ATP III).

Subsequently, the results of some large randomized controlled trials like HPS (2002), ASCOT-LLA (2003), PROVE-IT (2004) became available and necessitated further revision of the treatment guidelines. A 2004 revision of the ATP III guidelines has been published (Grundy *et al*,

1. HPS (2002, 2004): Heart protection study. *Lancet* (2002) **360**, 7-22, and *Lancet* (2004) **363**, 757-767
2. ASCOT-LLA (2003): Anglo-Scandinavian cardiac outcomes trial-Lipid lowering arm. *Lancet* (2003) **361**, 1149-1158.
3. PROVE-IT (2004): Intensive versus moderate lipid lowering with statins after acute coronary syndromes. *NEJM* (2004), **350**, 1495-1504.
4. NCEP-ATP III (2004 revision). Grundy. SM *et al.* *Circulation* (2004) **110**, 227-239.

2004). The salient features of these guidelines are incorporated in the following summary.

Lifestyle modification, such as low fat, low cholesterol diet, limitation of saturated and trans-fats, regular exercise, body weight control, smoking cessation, restriction of alcohol are the primary approach, whether drugs are used or not.

Risk factors for coronary artery disease*

- Men > 45 years, women > 55 years
- Family history of MI/sudden cardiac death before 55 year (men), 65 year (women) age in first degree relative
- Smoking
- Hypertension (BP > 140/90 or use of anti-hypertensive medication)
- Diabetes mellitus[£]
- Low HDL-CH (< 40 mg/dl in men, < 50 mg/dl in women)
- High LDL-CH (≥ 160 mg/dl) or total CH ≥ 240 mg/dl
- Obesity (BMI > 25 Kg/m²)[†] or waist > 40" (men), > 35" (women)

* Adopted from the NCEP-ATP III (2001)

£ Diabetes is considered equivalent to existing CAD

† Not included in NCEP guideline (2001)

The decision to prescribe hypolipidaemic drugs depends not only on the LDL-CH level and the type of lipid abnormality, but also on associated CAD risk factor(s) or existing CAD or its equivalent like diabetes, peripheral/cerebral vascular disease, etc. in an individual patient (*see box*).

Treatment based on LDL-CH level The revised NCEP-ATP III guidelines are summarized in Table 45.5. All subjects should receive statin (or statin-based combination) therapy if LDL-CH is ≥ 190 mg/dl. The dose should be titrated to achieve the goal LDL-CH level or 30-40% reduction, whichever is lower (this degree of lipid lowering has been found to yield optimum prognostic benefit). For subjects who already have CAD or CAD equivalent, there is no lower threshold LDL-CH level; all subjects should receive lipid lowering drug. Though, LDL-CH value upto 100 mg/dl is considered optimal for non-CAD subjects, the goal for CAD patients has been lowered to 70 mg/dl. These decisions have been based on the findings

Table 45.5: LDL-CH lowering treatment guidelines*

Risk category	LDL-CH goal (mg/dl)	LDL-CH (mg/dl) level for initiation of	
		Lifestyle modifications	Drug therapy
1. Very high risk (CAD/CAD equivalent [£] + one [§])	<70 [†]	All subjects	All subjects
2. High risk (CAD/CAD equivalent)	< 100 [†]	All subjects	All subjects
3. Moderately high risk (≥ 2 CAD risk factors + 10 yr CAD risk [°] 10-20%)	< 130 (or < 100 [†])	≥ 100	≥ 130 (or 100-129 [#])
4. Moderate risk (≥ 2 CAD risk factors + 10 yr CAD risk [°] < 10%)	< 130	≥130	≥160
5. Low risk (0-1 CAD risk factor)	< 160	≥160	≥190 (or 160-189 [#])

* Adopted from the US National Cholesterol Education Programme (NCEP); 2004 revision of adult treatment panel III (ATP III)

£ CAD equivalent includes—diabetes mellitus/10 yr CAD risk > 20%/peripheral vascular disease/abdominal aortic aneurysm/symptomatic carotid artery disease

§ One additional feature from (i) ≥ 2 CAD risk factors (ii) Single uncontrolled CAD risk factor (iii) diabetes mellitus (iv) metabolic syndrome (v) acute coronary syndrome

° As per risk assessment tables from the Framingham Heart Study

† When LDL-CH is near or below the goal value, then a statin dose to lower LDL-CH by 30-40% should be employed

Patients with a severe risk factor or multiple risk factors.

of recent studies which have compared mortality as well as CAD and stroke prevention benefits of standard *vs* intensive CH lowering regimens. Also the criteria for grading the cardiovascular disease risk as 'very high' to 'low' have been defined, and threshold as well as goal LDL-CH levels have been demarcated for each category of risk.

The primary drugs to lower LDL-CH are statins. Statin therapy should be commenced at low dose. In case of inadequate response, dose should be doubled at 6 week intervals (till max doses reached) and/or another drug (fibrate/nicotinic acid/ezetimibe) should be added to achieve the target LDL-CH level.

Treatment of low HDL-CH level Epidemiological data has shown that most patients with premature CAD have low HDL-CH level. The total CH: HDL-CH ratio has been recognized as a more important determinant of CAD risk. While a ratio of ≤ 3.5 is considered desirable, a ratio of > 4.5 is associated with higher risk. Recent trials have shown that statin therapy reduces CAD endpoints in subjects with low HDL-CH even though LDL-CH may be in the normal range. Most low HDL-CH subjects have metabolic syndrome (obesity, hypertriglyceridaemia, insulin resistance/diabetes, hypertension). Therapy directed towards components of this syndrome often helps to normalise HDL-CH. In addition to these measures, the primary approach of therapy in subjects with low HDL-CH is to reduce LDL-CH to the target level as per their LDL-CH risk category or to achieve a total CH: HDL-CH ratio of ≤ 3.5 , whichever is more intensive. None of the currently available lipid modifying drugs has a marked effect to raise HDL-CH, but nicotinic acid has the highest efficacy followed by fibrates. These drugs may be usefully combined with the statin, watching for signs of myositis.

Treatment of raised TG level: On the basis of metaanalysis of studies, the NCEP have recognized elevated TGs to be an independent CAD risk factor. Treatment strategy for hypertriglyceridaemia depends on its cause (obesity, physical inactivity, smoking, alcohol, high carbohydrate

diet, diabetes, renal failure, drugs like corticosteroids, estrogens, high dose β blockers and genetic disorders) and its severity. Initial treatment is directed to achieving the target LDL-CH level appropriate for the patient's CAD risk category (by using a statin). This may itself lower the TG level. The primary TG lowering drugs are fibrates and nicotinic acid. In case of failure to reduce serum TG to < 200 mg/dl, a fibrate (preferably fenofibrate) or nicotinic acid may be added to the statin regimen, with extra vigilance to guard against the increased risk of myopathy.

Therapeutic intervention for raised TG level

a. Plasma TG < 150 mg/dl (normal)

No TG lowering needed; treat as per CH levels

b. Plasma TG 200-499 mg/dl (high)

Lifestyle modification; treatment of cause if identified; statin therapy to achieve the goal LDL-CH level as per CAD risk category; specific TG lowering drug (fibrate/nicotinic acid) may be considered if—(i) CAD present (ii) family history of premature CAD (iii) non HDL-CH ≥ 190 mg/dl (iv) HDL < 40 mg/dl (v) genetic dysbetalipoproteinaemia (type III) or familial combined hyperlipaemia (type v) (vi) multiple risk factors present.

c. Plasma TG > 500 mg/dl (very high)

Vigorous measures to lower TG level needed since risk of acute pancreatitis is high; control diabetes and other causes; institute very low fat diet; reduce weight; curtail alcohol; specific TG lowering drugs strongly indicated.

PLASMA EXPANDERS

These are high molecular weight substances which exert colloidal osmotic (oncotic) pressure, and when infused i.v. retain fluid in the vascular compartment. They are used to correct hypovolemia due to loss of plasma/blood.

Human plasma or reconstituted human albumin would seem to be the best. However, the former carries risk of transmitting serum hepatitis, AIDS, etc., and the latter is expensive. Therefore, synthetic colloids are more often used.

Desirable properties of a plasma expander are:

1. Should exert oncotic pressure comparable to plasma.
2. Should remain in circulation and not leak out in tissues, or be too rapidly disposed.

3. Should be pharmacodynamically inert.
4. Should not be pyrogenic or antigenic.
5. Should not interfere with grouping and cross-matching of blood.
6. Should be stable, easily sterilizable and cheap.

Substances employed are:

Human Albumin	Hydroxyethyl starch
Dextran	(HES); (Hetastarch)
Degraded gelatin polymer	Polyvinyl pyrrolidone (PVP)

Human albumin It is obtained from pooled human plasma; 100 ml of 20% human albumin solution is the osmotic equivalent of about 400 ml of fresh frozen plasma or 800 ml of whole blood. It can be used without regard to patient's blood group and does not interfere with coagulation. Unlike whole blood or plasma, it is free of risk of transmitting serum hepatitis because the preparation is heat treated. There is also no risk of sensitization with repeated infusions.

The 20% solution draws and holds additional fluid from tissues: crystalloid solutions must be infused concurrently for optimum benefit. Apart from burns, hypovolemia, shock, etc., it has been used in acute hypoproteinaemia, acute liver failure and dialysis. Dilution of blood using albumin and crystalloid solutions can be used before cardiopulmonary bypass. Febrile reaction to human albumin occurs occasionally. It is expensive.

Human albumin 20%: **ALBUDAC**, **ALBUPAN 50**, 100 ml inj., **ALBUMED 5%**, 20% infusion (100 ml)

Dextran It is a polysaccharide obtained from sugar beat which is available in two forms.

Dextran-70 (MW 70,000): **DEXTRAN-70**, **LOMODEX-70**; 6% solution in dextrose or saline, 540 ml vac.

Dextran-40 (MW 40,000; low MW dextran): **LOMODEX 10%** solution in dextrose or saline, 540 ml vac.

The more commonly used preparation is dextran-70. It expands plasma volume for nearly 24 hours, and is slowly excreted by glomerular filtration as well as oxidized in the body over weeks. Some amount is deposited in RE cells. Dextran has nearly all the properties of an ideal plasma expander except:

- (a) It may interfere with blood grouping and cross-matching.
- (b) Though the dextran used clinically is not antigenic, its structure is similar to other antigenic polysaccharides. Some polysaccharide reacting antibodies, if present, may cross react with dextran and trigger anaphylactic reaction. Urticaria, itching, bronchospasm, fall in BP occur occasionally; anaphylactic shock is rare.

- (c) It can interfere with coagulation and platelet function and thus prolong bleeding time; should not be used in hypofibrinogenemia, thrombocytopenia or in presence of bleeding.

Dextran-40 It acts more rapidly than dextran-70. It reduces blood viscosity and prevents RBC sludging that occurs in shock by coating them and maintaining their electronegative charge. Microcirculation may improve. However, it is rapidly filtered at the glomerulus: expands plasma volume for a shorter period, and may get highly concentrated in the tubule if oliguria develops—tubular obstruction may occur. The total dose should not exceed 20 ml/kg in 24 hr. It has also been tried in stroke and for prophylaxis of deep vein thrombosis and pulmonary infarction.

Dextrans can be stored for 10 years and are cheap. They are the most commonly used plasma expanders.

Degraded gelatin polymer (Polygeline) It is a polypeptide with average MW 30,000 which exerts oncotic pressure similar to albumin and is not antigenic; hypersensitivity reactions are rare, but should be watched for. It does not interfere with grouping and cross-matching of blood and remains stable for three years. It is not metabolized in the body; excreted slowly by the kidney. Expansion of plasma volume lasts for 12 hours. It is more expensive than dextran. It can also be used for priming of heart-lung and dialysis machines.

Hypersensitivity reactions like flushing, rigor, urticaria, wheezing and hypotension can occur.

HAEMACCEL, SERACCEL 500 ml vac. (as 3.5% solution in balanced electrolyte medium).

Hydroxyethyl starch (HES; Hetastarch) It is a complex mixture of ethoxylated amylopectin of various molecular sizes; average MW 4.5 lac (range 10,000 to 1 million). The colloidal properties of 6% HES approximate those of human albumin. Plasma volume expands slightly in excess of the volume infused. Haemodynamic status is improved for 24 hour or more.

Smaller molecules (MW < 50,000) are excreted rapidly by kidney; 40% of infused dose appears in urine in 24 hr. Larger molecules are slowly broken down to smaller ones and eliminated with a $t_{1/2}$ of 17 days.

Adverse effects are vomiting, mild fever, itching, chills, flu like symptoms, swelling of salivary glands. Urticaria, periorbital edema and bronchospasm are the anaphylactoid reactions.

It has also been used to improve harvesting of granulocytes because it accelerates erythrocyte sedimentation.

EXPAN 6% inj (100, 500 ml vac)

Polyvinylpyrrolidone (PVP) It is a synthetic polymer (average MW 40,000) used as a 3.5% solution. It interferes with blood grouping and cross-matching and is a histamine releaser. PVP is slowly excreted by kidney and small amounts by liver into bile. A fraction is stored in

RE cells for prolonged periods. It has been found to bind penicillin and insulin in circulation so that the same is not available for action. It is infrequently used as a plasma expander.

OSMOPLASMA, SIOPLASMA; 3.5% solution in buffered normal saline, 540 ml vac.

USE OF PLASMA EXPANDERS

These colloidal solutions are used primarily as substitutes for plasma in conditions where plasma has been lost or has moved to extravas-

cular compartment, e.g. in burns, hypovolemic and endotoxin shock, severe trauma and extensive tissue damage. They can also be used as a temporary measure in cases of whole blood loss till the same can be arranged: but they do not have O₂ carrying capacity.

Contraindications to plasma expanders are—severe anaemia, cardiac failure, pulmonary edema, renal insufficiency.

Gastrointestinal Drugs

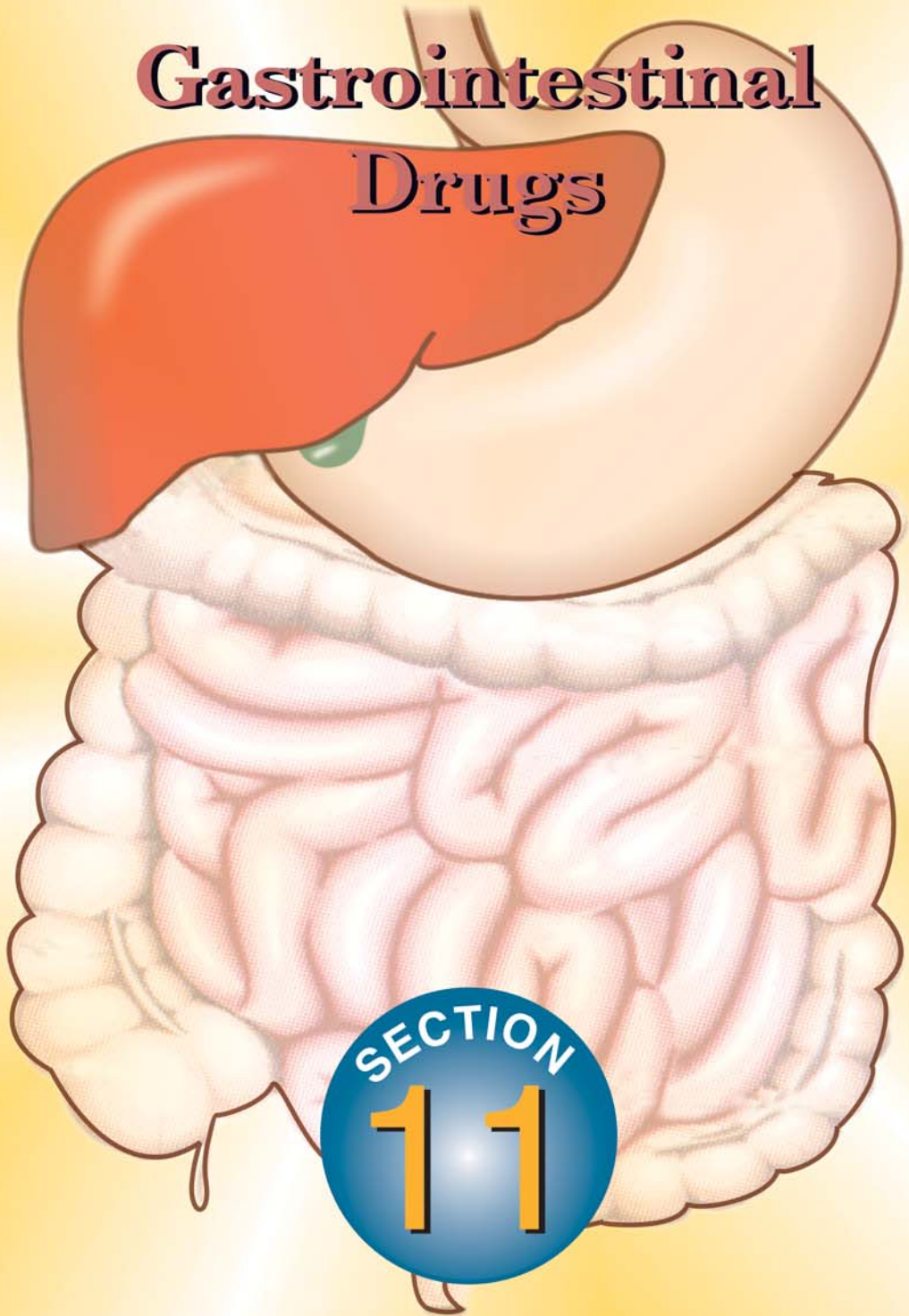

SECTION

11

CHAPTER 46

Drugs for Peptic Ulcer



Peptic ulcer occurs in that part of the gastrointestinal tract (g.i.t.) which is exposed to gastric acid and pepsin, i.e. the stomach and duodenum. The etiology of peptic ulcer is not clearly known. It results probably due to an imbalance between the *aggressive* (acid, pepsin, bile and *H. pylori*) and the *defensive* (gastric mucus and bicarbonate secretion, prostaglandins, nitric oxide, innate resistance of the mucosal cells) factors. A variety of psychosomatic, humoral and vascular derangements have been implicated and the importance of *Helicobacter pylori* infection as a contributor to ulcer formation and recurrence has been recognized.

In *gastric ulcer*, generally acid secretion is normal or low. In *duodenal ulcer*, acid secretion is high in half of the patients but normal in the rest. Notwithstanding whether production of acid is normal or high, it does contribute to ulceration as an aggressive factor, reduction of which is the main approach to ulcer treatment. An understanding of the mechanism and control of gastric acid secretion will elucidate the targets of antisecretory drug action.

Regulation of gastric acid secretion

The mechanisms operating at the gastric parietal cells are summarized in Fig. 46.1. The terminal enzyme $H^+K^+ATPase$ (proton pump) which secretes H^+ ions in the apical canaliculi of parietal cells can be activated by histamine,

ACh and gastrin acting *via* their own receptors located on the basolateral membrane of these cells. Out of the three physiological secretagogues, histamine, acting through H_2 receptors, plays the dominant role, because the other two, gastrin and ACh act partly directly and to a greater extent indirectly by releasing histamine from paracrine enterochromaffin-like cells called "histaminocytes" located in the oxyntic glands. While H_2 receptors activate $H^+K^+ATPase$ by generating cAMP, muscarinic and gastrin/cholecystokinin (CCK_2) receptors appear to function through the phospholipase C \rightarrow IP_3 -DAG pathway that mobilizes intracellular Ca^{2+} . The cAMP mediated proton pump activation also involves Ca^{2+} . The secretomotor response to gastrin and cholinergic agonists is expressed fully only in the presence of cAMP generated by H_2 activation. As such, histamine participates in the acid response to gastrin and ACh at more than one levels, and H_2 antagonists suppress not only histamine, but also ACh, pentagastrin and in fact any gastric acid secretory stimulus.

Gastrin is secreted from the antrum in response to rise in antral pH, food constituents and vagally mediated reflexes. The dominant muscarinic receptor mediating vagal responses is of the M_1 subtype. Its location on the ganglion cells of the intramural plexuses has been confirmed. The parietal cell muscarinic receptor is of the M_3 subtype but the subtype of muscarinic receptor on histaminocytes has not been defined. Vagus releases ACh in close proximity to histaminocytes and gastrin secreting cells, but apparently at a distance from the parietal cells. As such, vagal effects are exerted largely indirectly through histamine and gastrin.

Prostaglandins have been ascribed a "cytoprotective" role in the gastric mucosa by augmenting mucus and bicarbonate secretion, as well as other actions. PGE_2 , produced by gastric mucosa, inhibits acid secretion by opposing cAMP generation (in parietal cells) and gastrin release (from antral cells).

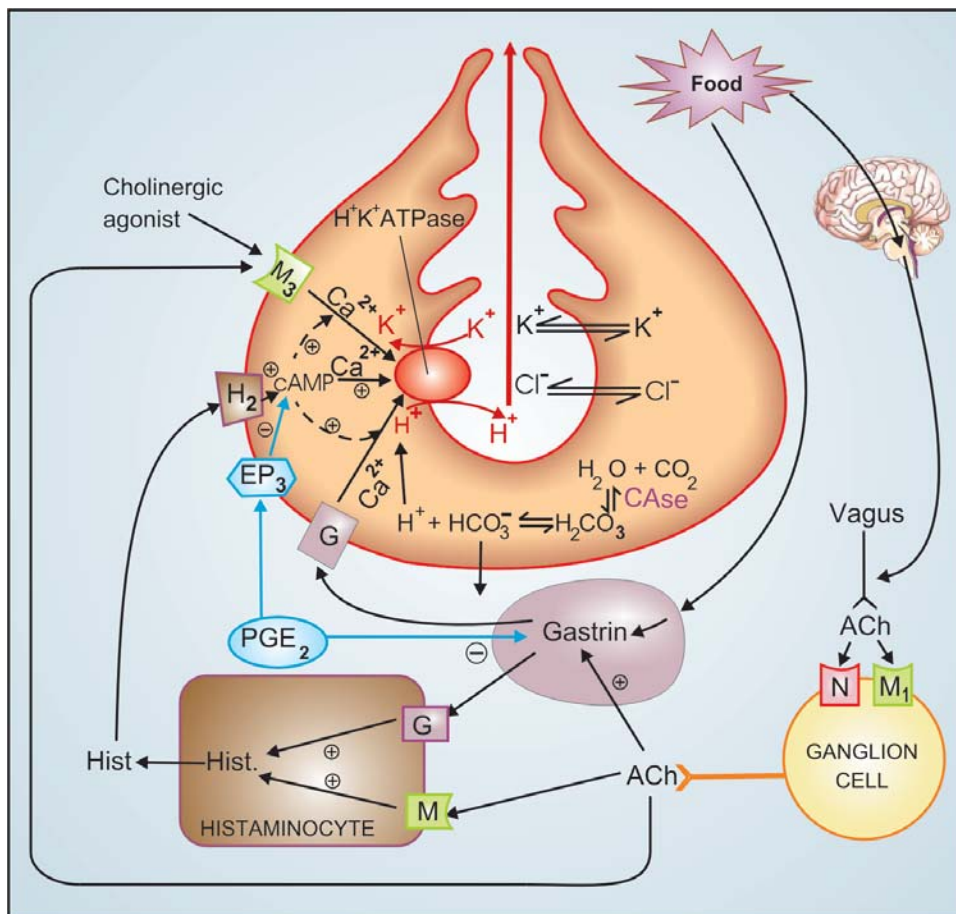

Fig. 46.1: Secretion of HCl by gastric parietal cell and its regulation

C.Ase.—Carbonic anhydrase; Hist.—Histamine; ACh.—Acetylcholine; G—Gastrin/cholecystokinin (CCK₂) receptor; M.—Muscarinic receptor; N—Nicotinic receptor; H₂—Histamine H₂ receptor; EP₃—Prostaglandin receptor; + Stimulation; –Inhibition.

Approaches for the treatment of peptic ulcer are:

1. *Reduction of gastric acid secretion*

- (a) *H₂ antihistamines*: Cimetidine, Ranitidine, Famotidine, Roxatidine
- (b) *Proton pump inhibitors*: Omeprazole, Lansoprazole, Pantoprazole, Rabeprazole, Esomeprazole
- (c) *Anticholinergics*: Pirenzepine, Propantheline, Oxyphenonium
- (d) *Prostaglandin analogue*: Misoprostol

2. *Neutralization of gastric acid (Antacids)*

- (a) *Systemic*: Sodium bicarbonate, Sod. citrate
 - (b) *Nonsystemic*: Magnesium hydroxide, Mag. trisilicate, Aluminium hydroxide gel, Magaldrate, Calcium carbonate
3. *Ulcer protectives*: Sucralfate, Colloidal bismuth subcitrate (CBS)
 4. *Anti-H. pylori drugs*: Amoxicillin, Clarithromycin, Metronidazole, Tinidazole, Tetracycline

H₂ ANTAGONISTS

These are the first class of highly effective drugs for acid-peptic disease. Four H₂ antagonists cimetidine, ranitidine, famotidine and roxatidine are available in India; many others are marketed elsewhere. Their interaction with H₂ receptors has been found to be competitive in case of cimetidine, ranitidine and roxatidine, but competitive-noncompetitive in case of famotidine. Cimetidine was the first H₂ blocker to be introduced clinically and is described as the prototype, though other H₂ blockers are more commonly used now.

PHARMACOLOGICAL ACTIONS

1. H₂ blockade Cimetidine and all other H₂ antagonists block histamine-induced gastric secretion, cardiac stimulation (prominent in isolated preparations, especially in guinea pig), uterine relaxation (in rat) and bronchial relaxation (H₂ blockers potentiate histamine induced bronchospasm). They attenuate fall in BP due to histamine, especially the late phase response seen with high doses. They are highly selective: have no effect on H₁ mediated responses or on the action of other transmitters/autacoids.

2. Gastric secretion The only significant *in vivo* action of H₂ blockers is marked inhibition of gastric secretion. All phases (basal, psychic, neurogenic, gastric) of secretion are suppressed dose-dependently, but the basal nocturnal secretion is suppressed more completely. Secretory responses to not only histamine but all other stimuli (ACh, gastrin, insulin, alcohol, food) are attenuated. This reflects the permissive role of histamine in amplifying responses to other secretagogues. The volume, pepsin content and intrinsic factor secretion are also reduced. However, normal vit B₁₂ absorption is not interfered: no vit B₁₂ deficiency occurs even after prolonged use.

The usual ulcer healing doses produce 60–70% inhibition of 24 hr acid output. The H₂

blockers have antiulcerogenic effect. Gastric ulceration due to stress and drugs (NSAIDs, cholinergic, histaminergic) is prevented. They do not have any direct effect on gastric or esophageal motility or on lower esophageal sphincter (LES) tone.

PHARMACOKINETICS

Cimetidine is adequately absorbed orally, though bioavailability is 60–80% due to first pass hepatic metabolism. Absorption is not interfered by presence of food in stomach. It crosses placenta and reaches milk, but penetration in brain is poor because of its hydrophilic nature. About 2/3 of a dose is excreted unchanged in urine and bile, the rest as oxidized metabolites. The elimination t_{1/2} is 2–3 hr. Dose reduction is needed in renal failure.

ADVERSE EFFECTS

Cimetidine is well tolerated by most patients: adverse effects occur in < 5%. These are generally mild.

- Headache, dizziness, bowel upset, dry mouth, rashes.
- CNS effects like confusional state, restlessness, convulsions and coma have occurred infrequently in elderly patients, in those with renal impairment, especially with large doses infused i.v.
- Bolus i.v. injection can release histamine—has caused bradycardia, arrhythmias and cardiac arrest: it should always be given by slow infusion.
- Cimetidine (but not other H₂ blockers) has antiandrogenic action (displaces dihydrotestosterone from its cytoplasmic receptor), increases plasma prolactin and inhibits degradation of estradiol by liver. High doses given for long periods have produced gynaecomastia, loss of libido, impotence and temporary decrease in sperm count.
- Transient elevation of plasma aminotransferases; but hepatotoxicity is rare.

INTERACTIONS

Cimetidine inhibits several cytochrome P-450 isoenzymes and reduces hepatic blood flow. It inhibits the metabolism of many drugs so that they can accumulate to toxic levels, e.g. theophylline, phenytoin, carbamazepine, phenobarbitone, sulfonylureas, metronidazole, warfarin, imipramine, lidocaine, nifedipine, quinidine. Metabolism of propranolol and diazepam is also retarded, but this may not be clinically significant.

Antacids reduce absorption of all H₂ blockers. When used concurrently a gap of 2hr should be allowed. Ketoconazole absorption is decreased by cimetidine (probably by other H₂ blockers also).

Dose: For ulcer healing—400 mg BD or 800 mg at bed time orally; maintenance—400 mg at bed time; for stress ulcer—50 mg/hr i.v. infusion.

CIMETIDINE 200 mg, 400 mg, 800 mg tabs, 200 mg/2 ml inj., **LOCK-2** 200 mg tab.

Ranitidine A nonimidazole (has a furan ring) H₂ blocker, it has several desirable features compared to cimetidine:

- About 5 times more potent than cimetidine. Though its pharmacokinetic profile and t_{1/2} of 2–3 hr is similar to cimetidine, a longer duration of action with greater 24 hr acid suppression is obtained clinically because of higher potency.
- No antiandrogenic action, does not increase prolactin secretion or spare estradiol from hepatic metabolism—no effect on male sexual function or gynaecomastia.
- Lesser permeability into the brain: lower propensity to cause CNS effects. In fact, little effect outside g.i.t. has been observed.
- Does not significantly inhibit hepatic metabolism of other drugs; drug interactions mostly have no clinical relevance.
- Overall incidence of side effects is lower: headache, diarrhoea/constipation, dizziness have an incidence similar to placebo.

Dose: for ulcer healing 300 mg at bed time or 150 mg BD; for maintenance 150 mg at bed time. Parenteral dose—50 mg i.m. or slow i.v. inj. every 6–8 hr (rapid i.v. injection can cause hypotension), 0.1–0.25 mg/kg/hr by i.v.

infusion has been used for prophylaxis of stress ulcers. For gastrinoma 300 mg 3–4 times a day.

ULTAC, ZINETAC 150 mg, 300 mg tabs; **HISTAC, RANITIN, ACILOC, RANTAC** 150 mg, 300 mg tabs, 50 mg/2 ml inj.

Famotidine A thiazole ring containing H₂ blocker which binds tightly to H₂ receptors and exhibits longer duration of action despite an elimination t_{1/2} of 2.5–3.5 hr. Some inverse agonistic action on H₂ receptors (in the absence of histamine) has been demonstrated. It is 5–8 times more potent than ranitidine and antiandrogenic action is absent. Because of low affinity for cytochrome P450 and the low dose, drug metabolism modifying propensity is minimal.

The oral bioavailability of famotidine is 40–50% and it is excreted by the kidney, 70% in the unchanged form. Incidence of adverse effects is low: only headache, dizziness, bowel upset, rarely disorientation and rash have been reported. Because of the higher potency and longer duration, it has been considered more suitable for ZE syndrome and for prevention of aspiration pneumonia.

Dose: 40 mg at bed time or 20 mg BD (for healing); 20 mg at bed time for maintenance; upto 480 mg/day in ZE syndrome; parenteral dose 20 mg i.v. 12 hourly.

FAMTAC, FAMONITE, TOPCID 20 mg, 40 mg tabs; **FAMOCID, FACID** 20, 40 mg tabs, 20 mg/2 ml inj.

Roxatidine The pharmacodynamic, pharmacokinetic and side effect profile of roxatidine is similar to that of ranitidine, but it is twice as potent and longer acting. It has no antiandrogenic or cytochrome P450 inhibitory action.

Dose: 150 mg at bed time or 75 mg BD; maintenance 75 mg at bed time.

ROTANE, ZORPEX 75 mg, 150 mg SR tabs.

USES

The H₂ blockers are used in conditions in which it is profitable to suppress gastric acid secretion. Used in appropriate doses, all available agents have similar efficacy. However, proton pump inhibitors (PPIs), because of higher efficacy and

equally good tolerability, have outstripped H₂ blockers.

1. Duodenal ulcer H₂ blockers produce rapid and marked pain relief (within 2–3 days); 60–85% ulcers heal at 4 weeks and 70–95% ulcers at 8 weeks.

Suppression of nocturnal secretion by single high bed time dose is equally efficacious and physiologically more sound (continuous achlorhydria is considered undesirable). About ½ of the patients relapse within 1 year of healing with H₂ blockers. Maintenance therapy with bedtime dose reduces the relapse rate to 15–20% per year. However, when such treatment is withdrawn relapses occur with the same frequency.

2. Gastric ulcer Healing rates obtained in gastric ulcer are somewhat lower (50–75% at 8 weeks). However, doses remain the same. Maintenance therapy reduces recurrences as long as continued. H₂ blockers can heal NSAID associated ulcers, but are less effective than PPIs or misoprostol. H₂ blockers (i.v. or oral) are commonly administered in bleeding peptic ulcer, but benefits are uncertain.

3. Stress ulcers and gastritis Acutely stressful situations like hepatic coma, severe burns and trauma, prolonged surgery, prolonged intensive care, renal failure, asphyxia neonatorum, etc. are associated with gastric erosions and bleeding. Intravenous infusion of H₂ blockers successfully prevents the gastric lesions and haemorrhage.

4. Zollinger-Ellison syndrome It is a gastric hypersecretory state due to a rare tumour secreting gastrin. H₂ blockers in high doses control hyperacidity and symptoms in many patients, but relief is often incomplete and side effects frequent. PPIs are the drugs of choice. Definitive treatment is surgical.

5. Gastroesophageal reflux disease (GERD) H₂ blockers afford symptomatic relief and facilitate healing of esophageal erosions by reducing acidity of gastric contents that are refluxed; long-term treatment, preferably with 2–3 divided daily doses, is needed. However, they are less

effective in this condition than PPIs; are indicated only in mild or stage-1 cases of GERD.

6. Prophylaxis of aspiration pneumonia H₂ blockers given preoperatively (preferably evening before also) reduce the risk of aspiration of acidic gastric contents during anaesthesia and surgery.

7. Other uses H₂ blockers have adjuvant beneficial action in certain cases of urticaria who do not adequately respond to an H₁ antagonist alone.

PROTON PUMP INHIBITORS (PPIs)

Omeprazole It is the prototype member of substituted benzimidazoles which inhibit the final common step in gastric acid secretion and have overtaken H₂ blockers for acid-peptic disorders. The only significant pharmacological action of omeprazole is dose dependent suppression of gastric acid secretion; without anticholinergic or H₂ blocking action. It is a powerful inhibitor of gastric acid: can totally abolish HCl secretion, both resting as well as that stimulated by food or any of the secretagogues, without much effect on pepsin, intrinsic factor, juice volume and gastric motility.

Omeprazole is inactive at neutral pH, but at pH < 5 rearranges to two charged cationic forms (a sulphenic acid and a sulphenamide configurations) that react covalently with SH groups of the H⁺K⁺ATPase enzyme and inactivate it irreversibly, especially when two molecules of omeprazole react with one molecule of the enzyme. After diffusing into the parietal cell from blood, it gets concentrated in the acidic pH of the canaliculi because the charged forms generated there are unable to diffuse back. Moreover, it gets tightly bound to the enzyme. These features and the specific localization of H⁺K⁺ATPase to the apical membrane of the parietal cells confer high degree of selectivity of action to omeprazole. Acid secretion resumes only when new H⁺K⁺ATPase molecules are synthesized. It also inhibits gastric mucosal carbonic anhydrase.

The oral absorption of omeprazole is ~50%, because of instability at acidic pH. As the gastric pH rises, a higher fraction (up to 3/4) may be absorbed. Bioavailability of all PPIs is reduced by food; they should be taken in empty stomach, followed 1 hour later by a meal to activate the H⁺K⁺ ATPase and make it more susceptible to the PPI. Omeprazole is highly plasma protein bound, rapidly metabolised in liver by CYP2C19 and CYP3A4 (plasma t_{1/2} ~1 hr) and metabolites are excreted in urine. No dose modification is required in elderly or in renal/hepatic impairment. Because of tight binding to its target enzyme—it can be detected in the gastric mucosa long after its disappearance from plasma. As such, inhibition of HCl secretion occurs within 1 hr, reaches maximum at 2 hr, is still half maximal at 24 hr and lasts for 3 days. Because only actively acid secreting proton pumps are inhibited, and only few pumps may be active during the brief interval that the PPI is present (all have 1–2 hours plasma t_{1/2}), antisecretory action increases on daily dosing to reach a plateau after 4 days. All PPIs produce 80–98% suppression of 24 hour acid output with conventional doses at steady-state. Secretion resumes gradually over 3–5 days of stopping the drug.

Because of marked and long lasting acid suppression, compensatory hypergastrinemia has been observed. This has been found to induce proliferation of parietal cells and gastric carcinoid tumours in rats, but not in human beings. Though patients have been treated continuously for > 11 years without any problem, it may appear prudent to be apprehensive of prolonged achlorhydria and hypergastrinaemia, and if possible avoid long-term use of PPIs.

Uses

1. *Peptic ulcer* Omeprazole 20 mg OD is equally or more effective than H₂ blockers. Relief of pain is rapid and excellent. Faster healing has been demonstrated with 40 mg/day: some

duodenal ulcers heal even at 2 weeks and the remaining at 4 weeks. Gastric ulcer generally requires 4–8 weeks. It has caused healing of ulcers in patients not responding to H₂ blockers. Continued treatment (20 mg daily or thrice weekly) can prevent relapse. PPIs are an integral component of anti-*H. pylori* therapy. PPIs are the drugs of choice for NSAID induced gastric/duodenal ulcers. Healing may occur despite continued use of the NSAID.

2. *Bleeding peptic ulcer*: Acid enhances clot dissolution promoting ulcer bleed. Suppression of gastric acid has been found to facilitate clot formation reducing blood loss and rebleed. High dose i.v. PPI therapy (pantoprazole 40–120 mg/day or rabeprazole 40–80 mg/day) profoundly inhibits gastric acid, and has been shown to reduce rebleeding after therapeutic endoscopy. Even in cases where the bleeding vessel could not be visualized, i.v. followed by oral PPI reduces recurrence and need for surgery.

3. *Stress ulcers*: Intravenous pantoprazole is as effective prophylactic (if not more) for stress ulcers as i.v. H₂ blockers.

4. *Gastroesophageal reflux disease (GERD)*: Omeprazole produces more complete round-the-clock inhibition of gastric acid resulting in rapid symptom relief and is more effective than H₂ blockers in promoting healing of esophageal lesions. PPIs are the drugs of choice for patients with frequent or chronic symptoms and/or esophagitis/erosions; i.e. stage-2 or stage-3 GERD. Dose: 20–60 mg daily in 1 or 2 doses. Many patients require continued therapy since cause is not corrected.

5. *Zollinger-Ellison syndrome* Omeprazole is more effective than H₂ blockers in controlling hyperacidity in Z-E syndrome. However, 60–120 mg/day or more (in 2 divided doses) is often required for healing of ulcers. Inoperable cases have been treated for >6 years with sustained benefit and no adverse effects. Other gastric hypersecretory states like systemic mastocytosis, endocrine adenomas, etc. also respond well.

6. *Aspiration pneumonia*: PPIs are an alternative to H₂ blockers for prophylaxis of aspiration pneumonia due to prolonged anaesthesia.

OMIZAC, NILSEC 20 mg cap. OMEZ, OCID, OMEZOL 10, 20 mg caps, PROTOLOC 20, 40 mg caps containing enteric coated granules. Capsules must not be opened or chewed; to be taken in the morning before meals.

Adverse effects These are minimal: nausea, loose stools, headache, abdominal pain, muscle and joint pain, dizziness are complained by 3–5%. Rashes (1.5% incidence), leucopenia and hepatic dysfunction are infrequent. On prolonged treatment atrophic gastritis has been reported occasionally.

Lately, few reports of gynaecomastia and erectile dysfunction, possibly due to reduced testosterone level, on prolonged use of omeprazole have appeared. Accelerated osteoporosis among elderly due to reduced calcium absorption has been recently associated with high-dose long-term use of PPIs for GERD.

Interactions Omeprazole inhibits oxidation of certain drugs: diazepam, phenytoin and warfarin levels may be increased. Clarithromycin inhibits omeprazole metabolism and increases its plasma concentration.

Esomeprazole It is the S-enantiomer of omeprazole; claimed to have higher oral bioavailability and to produce better control of intragastric pH than omeprazole in GERD patients because of longer t_{1/2}. Higher healing rates of erosive esophagitis and better GERD symptom relief have been reported in comparative trials with omeprazole. Side effect and drug interaction profile is similar to the racemic drug.

Dose: 20–40 mg OD; NEXPRO, RACIPER, IZRA 20, 40 mg tabs.

Lansoprazole Somewhat more potent than omeprazole but similar in properties. Inhibition of H⁺ K⁺ ATPase by lansoprazole is partly reversible. It has higher oral bioavailability, faster onset of action and slightly longer t_{1/2} than omeprazole. Dose should be reduced in liver disease. Side effects are similar, but drug interactions appear to be less significant; diazepam and phenytoin metabolism may be reduced.

Ulcer healing dose: 15–30 mg OD; LANZOL, LANZAP, LEVANT, LANPRO 15, 30 mg caps.

Pantoprazole It is a newer H⁺ K⁺ ATPase inhibitor, similar in potency and clinical efficacy to omeprazole, but is more acid stable and has higher oral bioavailability. It is also available for i.v. administration; particularly employed in bleeding peptic ulcer and for prophylaxis of acute stress ulcers. It has lower affinity for cytochrome P450 than omeprazole or lansoprazole: risk of drug interactions is minimal.

Dose: 40 mg OD; PANTOCID, PANTODAC 40 mg enteric coated tab; PANTIUM 40 mg tab, 40 mg inj for i.v. use.

S-Pantoprazole It is the active single enantiomer, twice as potent as the racemate.

PANPURE, ZOSECTA 20 mg tab.

Rabeprazole This newer PPI is claimed to cause fastest acid suppression (due to higher pK_a, it is more rapidly converted to the active species) and to aid gastric mucin synthesis. However, potency and efficacy are similar to omeprazole.

Dose: 20 mg OD; ZE syndrome — 60 mg/day.

RABLET, PRORAB, RABELOC, RABICIP, RAZO 10, 20 mg tab; HAPPI 10, 20 mg tab, 20 mg/vial inj.

ANTICHOLINERGICS (See Ch. 8)

Atropinic drugs reduce the volume of gastric juice without raising its pH unless there is food in stomach to dilute the secreted acid. Stimulated gastric secretion is less completely inhibited. Effective doses (for ulcer healing) of nonselective antimuscarinics (atropine, propantheline, oxyphenonium) invariably produce intolerable side effects. Introduction of H₂ blockers and PPIs has sent them into oblivion.

Pirenzepine (see p. 111) It is a selective M₁ anticholinergic that has been used in Europe for peptic ulcer. Gastric secretion is reduced by 40–50% without producing intolerable side effects, but side effects occur with slight excess. It has not been used in India and USA.

PROSTAGLANDIN ANALOGUE

PGE₂ and PGI₂ are produced in the gastric mucosa and appear to serve a protective role by inhibiting acid secretion and promoting mucus + HCO₃⁻ secretion (see Ch. 13). In addition, PGs

inhibit gastrin production, increase mucosal blood flow and probably have an ill-defined “cytoprotective” action. However, the most important appears to be their ability to reinforce the mucus layer covering gastric and duodenal mucosa which is buffered by HCO_3^- secreted into this layer by the underlying epithelial cells.

Natural PGs have very short $t_{1/2}$. A number of stable PG analogues which exert action for hours rather than minutes have been developed for use in peptic ulcer. *Misoprostol* (methyl-PGE₁ ester) is commercially available. It inhibits acid output dose dependently. However, reduction in 24 hrs acid production is less than H₂ blockers because of shorter duration of action (~3 hr.) Ulcer healing rates comparable to cimetidine have been obtained in 4–8 weeks, but misoprostol is poorer in relieving ulcer pain. Some patients may even complain of increased pain during the first week of therapy.

Dose: 200 µg QID; **CYTOLOG** 200 µg tab; **MISOPROST** 100 µg, 200 µg tabs.

Major problems in the use of misoprostol are—diarrhoea, abdominal cramps, uterine bleeding, abortion, and need for multiple daily doses. Patient acceptability is poor.

The primary use of PG analogues is in the prevention and treatment of NSAID associated gastrointestinal injury and blood loss. However, PPIs are more effective, more convenient, better tolerated and cheaper.

ANTACIDS

These are basic substances which neutralize gastric acid and raise pH of gastric contents. Peptic activity is indirectly reduced if the pH rises above 4, because pepsin is secreted as a complex with an inhibitory terminal moiety that dissociates below pH 5: optimum peptic activity is exerted between pH 2 to 4.

Antacids do not decrease acid production; rather, agents that raise the antral pH to > 4 evoke reflex gastrin release → more acid is secreted, especially in patients with hyperacidity and duodenal ulcer; “acid rebound” occurs and gastric motility is increased.

The potency of an antacid is generally expressed in terms of its *acid neutralizing capacity* (ANC), which is defined as number of mEq of 1N HCl that are brought to pH 3.5 in 15 min (or 60 min in some tests) by a unit dose of the antacid preparation. This takes into consideration the rate at which it dissolves and reacts with HCl. This is important because a single dose of any antacid taken in empty stomach acts for 30–60 min only, since in this time any gastric content is passed into duodenum. Taken with meals antacids may act for at the most 2–3 hr.

SYSTEMIC ANTACIDS

Sodium bicarbonate It is water soluble, acts instantaneously, but the duration of action is short. It is a potent neutralizer (1 g → 12 mEq HCl), pH may rise above 7. However, it has several demerits:

- Absorbed systemically: large doses will induce alkalosis.
- Produces CO₂ in stomach → distention, discomfort, belching, risk of ulcer perforation.
- Acid rebound occurs, but is usually short lasting.
- Increases Na⁺ load: may worsen edema and CHF.

Use of sod. bicarbonate is restricted to casual treatment of heartburn: provides quick symptomatic relief. Other uses are to alkalinize urine and to treat acidosis.

Sodium citrate Properties similar to sod. bicarbonate; 1 g neutralizes 10 mEq HCl; CO₂ is not evolved.

NONSYSTEMIC ANTACIDS

These are insoluble and poorly absorbed basic compounds; react in stomach to form the corresponding chloride salt. The chloride salt again reacts with the intestinal bicarbonate so that HCO_3^- is not spared for absorption—no acid-base disturbance occurs. However, small amounts that are absorbed have the same alkalizing effect as NaHCO_3 .

Mag. hydroxide has low water solubility: its aqueous suspension (milk of magnesia) has low concentration of OH⁻ ions and thus low alkalinity. However, it reacts with HCl promptly and is an efficacious antacid (1 g → 30 mEq HCl). Rebound acidity is mild and brief.

MILK OF MAGNESIA 0.4 g/5 ml suspension: 5 ml neutralizes 12 mEq acid.

Magnesium trisilicate has low solubility and reactivity; 1 g can react with 10 mEq acid, but in clinical use only about 1 mEq is neutralized.

About 5% of administered Mg is absorbed systemically—may cause problem if renal function is inadequate.

All Mg salts have a laxative action—by generating osmotically active $MgCl_2$ in the stomach and through Mg^{2+} ion induced cholecystokinin release. Soluble Mg salts are used as osmotic purgatives.

Aluminium hydroxide gel It is a bland, weak and slowly reacting antacid. On keeping it slowly polymerizes to variable extents into still less reactive forms. Thus, the ANC of a preparation gradually declines on storage. Also, the product from different manufacturers may have differing ANCs; usually it varies from 1–2.5 mEq/g. Thus, 5 ml of its suspension may neutralize just 1 mEq HCl. As such, little worthwhile acid neutralization is obtained at conventional doses.

The Al^{3+} ions relax smooth muscle. Thus, it delays gastric emptying. Alum. hydrox. frequently, causes constipation due to its smooth muscle relaxant and mucosal astringent action.

Alum. hydrox. binds phosphate in the intestine and prevents its absorption—hypophosphatemia occurs on regular use. This may:

- (a) cause osteomalacia
- (b) be used therapeutically in hyperphosphatemia and phosphate stones.

Small amount of Al^{3+} that is absorbed is excreted by kidney which is not possible in renal failure—aluminium toxicity (encephalopathy, osteoporosis) can occur.

ALUDROX 0.84 g tab, 0.6 g/10 ml susp.

Magaldrate It is a hydrated complex of hydroxy-magnesium aluminate that initially reacts rapidly with acid and releases alum. hydrox. which then reacts more slowly. The freshly released alum. hydrox. is in the unpolymerized more reactive form. Thus, magaldrate cannot be equated to a physical mixture of mag. and alum. hydroxides. It is a good antacid with prompt and sustained neutralizing action. Its ANC is estimated to be 28 mEq HCl/g.

STACID 400 mg tab, 400 mg/5 ml susp.; **ULGEL** 400 mg with 20 mg simethicone per tab or 5 ml susp.

Calcium carbonate It is a potent and rapidly acting acid neutralizer (1 g \rightarrow 20 mEq HCl), but ANC of commercial preparations is less and variable due to differing particle size and crystal structure. Though it liberates CO_2 in the stomach at a slower rate than $NaHCO_3$, it can cause distention and discomfort. The Ca^{2+} ions are partly absorbed.

The greatest drawback of $CaCO_3$ as an antacid is that Ca^{2+} ions diffuse into the gastric mucosa—increase HCl production directly by parietal cells as well as by releasing gastrin. Acid rebound is marked. Cal. carbonate is constipating in most individuals, but in some it causes loose motions. The absorbed calcium can be dangerous in renal insufficiency.

Milk alkali syndrome In the past, large quantity of milk was prescribed with $CaCO_3$ (or $NaHCO_3$) for peptic ulcer.

Such regimen often produced a syndrome characterized by headache, anorexia, weakness, abdominal discomfort, abnormal Ca deposits and renal stones due to concurrent hypercalcaemia and alkalosis. It is rare now.

Antacid combinations A combination of two or more antacids is frequently used. These may be superior to any single agent on the following accounts:

- (a) Fast (Mag. hydrox.) and slow (Alum. hydrox.) acting components yield prompt as well as sustained effect.
- (b) Mag. salts are laxative, while alum. salts are constipating; combination may annul each other's action and bowel movement may be least affected.
- (c) Gastric emptying is least affected; while alum. salts tend to delay it, mag./cal. salts tend to hasten it.
- (d) Dose of individual components is reduced; systemic toxicity (dependent on fractional absorption) is minimized.

Some available antacid combinations are:

ACIDIN: Mag. carb. 165 mg, dried alum. hydrox. gel 232 mg, cal. carb. 165 mg, sod. bicarb. 82 mg, with kaolin 105 mg and belladonna herb 30 μ g per tab.

ALMACARB: Dried alum. hydrox. gel 325 mg, mag. carb. 50 mg, methyl polysilox. 40 mg, deglycyrrhizinated liquorice 380 mg per tab.

ALLUJEL-DF: Dried alum. hydrox. gel 400 mg, mag. hydrox. 400 mg, methyl polysilox. 30 mg per 10 ml susp.

DIGENE: Dried alum. hydrox. gel 300 mg, mag. alum. silicate 50 mg, mag. hydrox. 25 mg, methylpolysilox. 10 mg per tab.

DIGENE GEL: Mag. hydrox. 185 mg, alum. hydrox. gel 830 mg, sod. carboxymethyl cellulose 100 mg, methylpolysilox. 25 mg per 10 ml susp.

GELUSIL: Dried alum. hydrox. gel 250 mg, mag. trisilicate 500 mg per tab.

GELUSIL LIQUID: Mag. trisilicate 625 mg, alum. hydrox. gel 312 mg per 5 ml susp.

MUCAINE: Alum. hydrox. 290 mg, mag. hydrox. 98 mg, oxethazaine 10 mg per 5 ml susp.

TRICAINE-MPS: Alum. hydrox. gel 300 mg, mag. hydrox. 150 mg, oxethazaine 10 mg, simethicone 10 mg per 5 ml gel.

MAYLOX: Dried alum. hydrox. gel 225 mg, mag. hydrox. 200 mg, dimethicone 50 mg per tab and 5 ml susp.

POLYCROL FORTE GEL: Mag. hydrox. 100 mg, dried alum. hydrox. gel 425 mg, methylpolysilox. 125 mg per 5 ml susp.

Drug interactions By raising gastric pH and by forming complexes, the non-absorbable antacids decrease the absorption of many drugs, especially tetracyclines, iron salts, fluoroquinolones, ketoconazole, H₂ blockers, diazepam, phenothiazines, indomethacin, phenytoin, isoniazid, ethambutol and nitrofurantoin. Stagger their administration by 2 hours. The efficacy of nitrofurantoin is also reduced by alkalinization of urine.

Uses

Antacids are no longer used for healing peptic ulcer because they are needed in large and frequent doses, are inconvenient, can cause acid rebound and bowel upset, afford little nocturnal protection and have poor patient acceptability. Antacids are now employed only for intercurrent pain relief and acidity, mostly self-prescribed by the patients as over the counter preparations. They continue to be used for nonulcer dyspepsia and minor episodes of heartburn.

Gastroesophageal reflux Antacids afford faster symptom relief than drugs which inhibit acid secretion, but do not provide sustained benefit. May be used off and on for acid eructation and heartburn.

ULCER PROTECTIVES

Sucralfate It is a basic aluminium salt of sulfated sucrose; a drug of its own kind. Sucralfate polymerizes at pH < 4 by cross linking of molecules, assuming a sticky gel-like consistency. It preferentially and strongly adheres to ulcer base, especially duodenal ulcer; has been seen endoscopically to remain there for ~ 6 hours. It precipitates surface proteins at ulcer base and acts as a physical barrier preventing acid, pepsin and bile from coming in contact with the ulcer base. Dietary proteins get deposited on this coat, forming another layer.

Sucralfate has no acid neutralizing action, but delays gastric emptying—its own stay in stomach is prolonged. Augmented gastric mucosal PG synthesis may supplement physical protective action of sucralfate.

Sucralfate is minimally absorbed after oral administration; action is entirely local. It promotes healing of both duodenal and gastric ulcers; efficacy has been found

similar to cimetidine at 4 weeks. It is considered to be superior in patients who continue to smoke. However, sucralfate is infrequently used now because of need for 4 large well-timed daily doses and the availability of simpler H₂ blockers/PPIs.

Dose: The ulcer healing dose of sucralfate is 1 g taken 1 hour before the 3 major meals and at bed time for 4–8 weeks. Antacids should not be taken with sucralfate because its polymerization is dependent on acid pH.

ULCERFATE, SUCRACE, RECUFATE 1 g tab.

Side effects are few; constipation is reported by 2% patients. It has potential for inducing hypophosphatemia by binding phosphate ions in the intestine. Dry mouth and nausea are infrequent.

Other uses Bile reflux, gastritis and prophylaxis of stress ulcers.

In intensive care units, acid suppressant (with i.v./intra-gastric H₂ blocker/PPI) prophylaxis of stress ulcers is almost routinely used now. This practice is argued to contribute to occurrence of pneumonia due to overgrowth of bacteria in the stomach. Intra-gastric sucralfate provides effective prophylaxis of stress ulcers without acid suppression, and is being tried.

As a suspension in glycerol, it has been tried in stomatitis.

A topical formulation of sucralfate **PEPSIGARD LIGHT GEL** is available for application on burns, bedsores, diabetic/radiation ulcers, excoriated skin, etc. as a protective.

Interactions Sucralfate adsorbs many drugs and interferes with the absorption of tetracyclines, fluoroquinolones, cimetidine, phenytoin and digoxin. Antacids given concurrently reduce the efficacy of sucralfate.

Colloidal bismuth subcitrate (CBS; Tripotassium dicitratobismuthate)

It is a colloidal bismuth compound; water soluble but precipitates at pH < 5. It is not an antacid but heals 60% ulcers at 4 weeks and 80–90% at 8 weeks. The mechanism of action of CBS is not clear; probabilities are:

- (i) Increased secretion of mucus and bicarbonate through stimulation of mucosal PGE₂ production.
- (ii) CBS and mucus form a glycoprotein-Bi complex which coats the ulcer and acts as a diffusion barrier to HCl.
- (iii) Detaches *H. pylori* from the surface of mucosa and directly kills this organism involved in causation of ulcers and relapses.

Gastritis and nonulcer dyspepsia associated with *H. pylori* are also improved by CBS. The regimen for CBS is 120 mg (as Bi₂O₃) taken ½ hr before 3 major meals and at bedtime for 4–8 weeks. Milk and antacids should not be taken concomitantly.

TRYMO, DENOL 120 mg tab.

Most of the ingested CBS passes in the faeces. Small amounts absorbed are excreted in urine. Side effects reported are diarrhoea, headache and dizziness. Prolonged use has the potential to cause osteodystrophy and encephalopathy due to bismuth toxicity. Patient acceptance of CBS is compromised by blackening of tongue, dentures and stools; and by the inconvenience of dosing schedule. Presently, it is used occasionally as a component of triple drug anti-*H. pylori* regimen, but not by itself to heal peptic ulcer.

ANTI-HELICOBACTER PYLORI DRUGS

H. pylori is a gram negative bacillus uniquely adapted to survival in the hostile environment of stomach. It attaches to the surface epithelium beneath the mucus, has high urease activity—produces ammonia which maintains a neutral microenvironment around the bacteria, and promotes back diffusion of H⁺ ions. It has been found as a commensal in 20–70% normal individuals, and is now accepted as an important contributor to the causation of chronic gastritis, dyspepsia, peptic ulcer, gastric lymphoma and gastric carcinoma. *H. pylori* infection starts with a neutrophilic gastritis lasting 7–10 days which is usually asymptomatic. Once established, *H. pylori* generally persists for the life of the host. Up to 90% patients of duodenal and gastric ulcer have tested positive for *H. pylori*.

Eradication of *H. pylori* concurrently with H₂ blocker/PPI therapy of peptic ulcer has been associated with faster ulcer healing and markedly lower relapse rate. Anti-*H. pylori* therapy is, therefore, now recommended in all ulcer patients who test positive for *H. pylori*. In the absence of such testing, all cases with failed conventional ulcer therapy and relapse cases may be given the benefit of *H. pylori* eradication.

Antimicrobials that have been found clinically effective against *H. pylori* are: amoxicillin, clarithromycin, tetracycline and metronidazole/tinidazole. However, any single drug is relatively ineffective. Resistance develops rapidly, especially to metronidazole/tinidazole. Since bismuth (CBS) is active against *H. pylori* and resistance does not develop to it, early

combination regimens included bismuth, but had poor patient acceptability; are infrequently used now. In the meantime, it was observed that omeprazole monotherapy reduces the population of *H. pylori* in gastric antrum, probably by altering the acid environment as well as direct inhibitory effect. Rise in intragastric pH enhances the anti-*H. pylori* action of the antibiotics. A number of 2-drug and 3-drug regimens of 1 or 2 weeks duration have been tested reporting 60–96% eradication rates, but the optimum regimen is difficult to proclaim. Some of the 2 week regimens are:

Two week regimens (mg)

1. Amoxicillin 750 + Tinidazole 500 + Omeprazole 20 all BD
2. Amoxicillin 750 + Tinidazole 500 + Lansoprazole 30 all BD
3. Clarithromycin 250 + Tinidazole 500 + Lansoprazole 30 all BD
4. Clarithromycin 500 + Amoxicillin 1000 + Lansoprazole 30 all BD
5. Clarithromycin 500 BD/Amoxicillin 750 BD + Omeprazole 20 BD
6. Amoxicillin 500 TDS/Tetracycline 500 QID + Metronidazole 400 QID/Tinidazole 500 BD + Bismuth 120 QID
7. Amoxicillin 750 TDS + Metronidazole 500 TDS + Ranitidine 300 OD
8. Amoxicillin 750 BD + Clarithromycin 250 BD + Lansoprazole 30 BD

The US-FDA approved regimen is: lansoprazole 30 mg + amoxicillin 1000 mg + clarithromycin 500 mg all given twice daily for 2 weeks. It has achieved 86–92% eradication rate.* High prevalence of *in vitro* nitroimidazole resistance among *H. pylori* now being detected, especially in tropical regions, and better tolerability of regimens which exclude the nitroimidazole, favour the triple drug regimen of a PPI + amoxicillin + clarithromycin. The 2 week treatment is considered more appropriate, because higher relapse

* • Treating *Helicobacter pylori*: Arch Intern Med (1998) 23, 2396–97.

• A practical approach to patients with refractory *H. pylori* infection. Drugs (1999), 57, 905–15.

rate after one week regimen indicates incomplete eradication leading to recrudescence. A 4 drug regimen (PPI + tetracycline + CBS + metronidazole) has also been advocated.

All regimens are complex and expensive, side effects are frequent and compliance is poor. Higher failure rates (20–40%) of *H. pylori* eradication have been reported from India. Also, 5 year recurrence rate of *H. pylori* infection is higher. Three week treatment is now being advocated. Nevertheless, long-term benefits of anti-*H. pylori* therapy include lowering of ulcer disease prevalence and prevention of gastric carcinoma/lymphoma; but benefits in nonulcer dyspepsia are equivocal.

H. pylori vaccines are under development.

Some available anti-*H. pylori* kits (one kit to be taken daily in 2 doses)

HP-KIT, HELIBACT, OMXITIN: Omeprazole 20 mg 2 cap + Amoxicillin 750 mg 2 tab + Tinidazole 500 mg 2 tab.

PYLOMOX: Lansoprazole 15 mg 2 cap + Amoxicillin 750 mg 2 tab + Tinidazole 500 mg 2 tab.

LANSI KIT: Lansoprazole 30 mg 1 cap + Amoxicillin 750 mg 1 tab + Tinidazole 500 mg 1 tab (one kit twice a day)

PYLOKIT, HELIGO: Lansoprazole 30 mg 2 cap + Clarithromycin 250 mg 2 cap + Tinidazole 500 mg 2 tab.

LANPRO AC: Lansoprazole 30 mg 2 cap + Clarithromycin 250 mg 2 tab + Amoxicillin 750 mg 2 tab.

Role of drugs in peptic ulcer disease

Duodenal ulcer is a chronic remitting and relapsing disease lasting several years. Goals of antiulcer therapy are:

- (i) Relief of pain
- (ii) Ulcer healing
- (iii) Prevention of complications
- (iv) Prevention of relapse

The currently available drugs have adequately achieved the first two goals, partially the third, but there has been little success on the fourth performance criterion. Strategies to maintain the disease in remission are—continuous or on demand intermittent H₂ blocker/PPI treatment. Out of these continuous maintenance H₂ blocker/PPI therapy is regarded the most effective and convenient. Duration of such therapy is uncertain, but should not be less than a few years.

The better approach, however, is to identify and treat *H. pylori* positive cases. Long-term acid suppressive therapy would then be needed only in *H. pylori* negative cases, or those in whom this organism cannot be eradicated.

CHAPTER 47

Drugs for Emesis, Reflux and Digestive Disorders



Emesis Vomiting occurs due to stimulation of the *emetic (vomiting) centre* situated in the medulla oblongata. Multiple pathways can elicit vomiting (Fig. 47.1). The *chemoreceptor trigger zone (CTZ)* located in the area postrema and the *nucleus tractus solitarius (NTS)* are the most important relay areas for afferent impulses arising in the g.i.t, throat and other viscera. The CTZ is also accessible to blood-borne drugs, mediators, hormones, toxins, etc. because it is unprotected by the blood-brain barrier. Cytotoxic drugs, radiation and other g.i. irritants release 5-HT from enterochromaffin cells → acts on 5-HT₃ receptors present on extrinsic primary afferent neurones (PAN) of the enteric nervous system (ENS), which connect with vagal and spinal visceral afferents to send impulses to NTS and CTZ. Released in large quantity, 5-HT may also spill into circulation and reach CTZ. It may as well be released from platelets by inflammatory mediators. However, 5-HT is not the only mediator of such signals: many peptides and other messengers are also involved.

The CTZ and NTS express a variety of receptors, e.g. histamine H₁, dopamine D₂, serotonin 5-HT₃, cholinergic M and opioid μ through which the emetic signals are relayed and which could be targets of antiemetic drug action.

The vestibular apparatus generates impulses when body is rotated or equilibrium is disturbed or when ototoxic drugs act. These impulses reach the vomiting centre mainly relayed from the cerebellum and utilize muscarinic as well as H₁ receptors. Various unpleasant sensory stimuli such as bad odour, ghastly sight, severe pain as well as fear, recall of an obnoxious event, anticipation of an emetic stimulus (repeat dose of cisplatin) cause nausea and vomiting through higher centres.

Nausea is accompanied by reduced gastric tone and peristalsis. In the emetic response fundus and body of stomach, esophageal sphincter and esophagus relax, while duodenum and pyloric stomach contract in a retrograde manner. Rhythmic contractions of diaphragm and abdominal muscles then compress the stomach and evacuate its contents *via* the mouth. Conditions that inhibit gastric emptying predispose to vomiting.

EMETICS

These are drugs used to evoke vomiting.

1. *Act on CTZ* : Apomorphine
2. *Act reflexly and on CTZ* : Ipecacuanha

Vomiting needs to be induced only when an undesirable substance (poison) has been ingested. Powdered mustard suspension or strong salts solution may be used in emergency. They act reflexly by irritating the stomach.

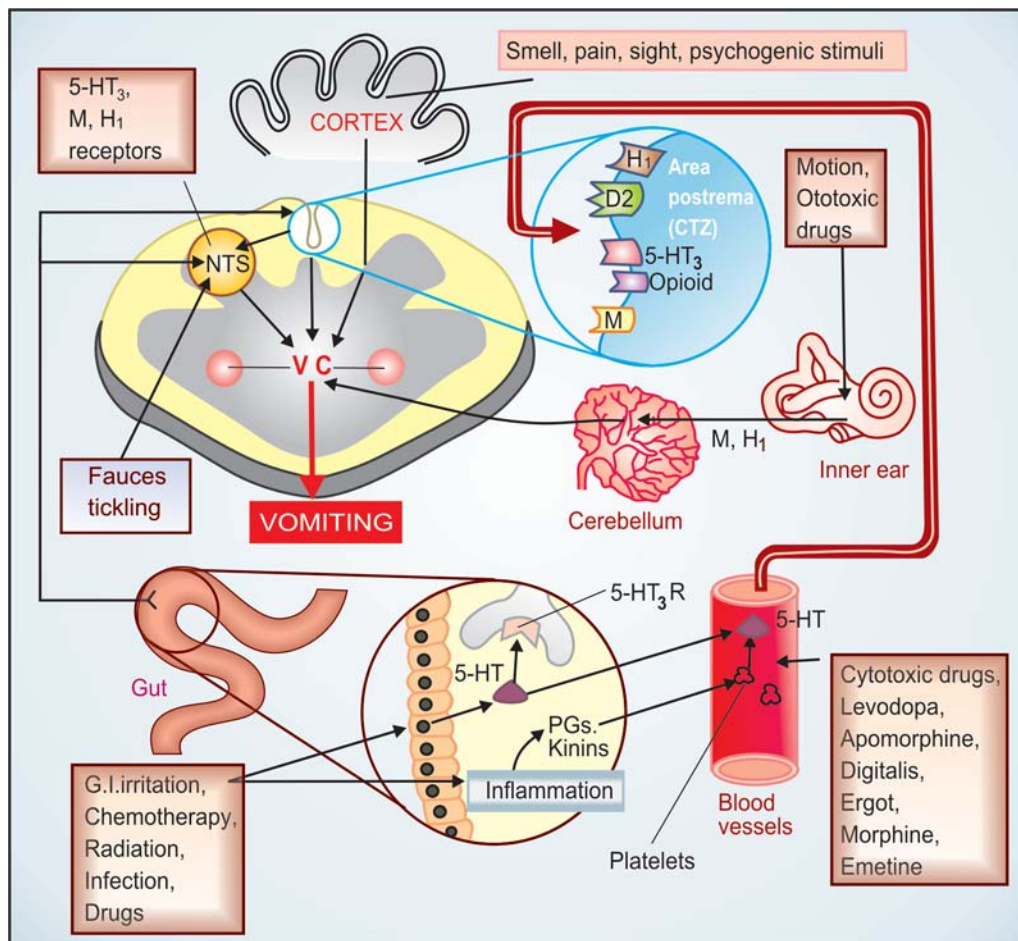

Fig. 47.1: Major central and visceral structures involved in emesis and the neurohumoral receptors mediating the emetic response. NTS: Nucleus tractus solitarius; VC: Vomiting centre; CTZ—Chemoreceptor trigger zone; 5-HT₃R: 5-HT₃ receptor

Apomorphine It is a semisynthetic derivative of morphine; acts as a dopaminergic agonist on the CTZ. Injected i.m./s.c. in a dose of 6 mg, it promptly (within 5 min) induces vomiting. It should not be used if respiration is depressed, because it has inherent respiratory and CNS depressant actions. Oral use of apomorphine is not recommended because the emetic dose is larger, slow to act and rather inconsistent in action.

Apomorphine has a therapeutic effect in parkinsonism, but is not used due to side effects.

Ipecacuanha The dried root of *Cephaelis ipecacuanha* contains emetine and is used as *syrup ipecac* (15–30 ml in adults, 10–15 ml in children, 5 ml in infants) for inducing vomiting. It should be available in every household for emergency use. It is less dependable than

parenteral apomorphine and takes 15 min or more for the effect, but is safer. It acts by irritating gastric mucosa as well as through CTZ.

All emetics are contraindicated in:

- Corrosive (acid, alkali) poisoning: risk of perforation and more injury to esophageal mucosa.
- CNS stimulant drug poisoning: convulsions may be precipitated.
- Kerosine (petroleum) poisoning: chances of aspiration of the liquid (due to low viscosity) and chemical pneumonia are high.

- (d) Unconscious patient: may aspirate the vomitus, because laryngeal reflex is likely to be impaired.
- (e) Morphine or phenothiazine poisoning: emetics are ineffective.

ANTIEMETICS

These are drugs used to prevent or suppress vomiting.

CLASSIFICATION

1. *Anticholinergics* Hyoscine, Dicyclomine
2. *H₁ antihistaminics* Promethazine, Diphenhydramine, Dimenhydrinate, Doxylamine, Cyclizine, Meclozine, Cinnarizine.
3. *Neuroleptics (D₂ blockers)* Chlorpromazine, Prochlorperazine, Haloperidol, etc.
4. *Prokinetic drugs* Metoclopramide, Domperidone, Cisapride, Mosapride, Tegaserod
5. *5-HT₃ antagonists* Ondansetron, Granisetron
6. *Adjuvant antiemetics* Dexamethasone, Benzodiazepines, Cannabinoids.

ANTICHOLINERGICS (See Ch. 8)

Hyoscine (0.2–0.4 mg oral, i.m.) is the most effective drug for motion sickness. However, it has a brief duration of action; produces sedation and other anticholinergic side effects; suitable only for short brisk journeys. It acts probably by blocking conduction of nerve impulses across a cholinergic link in the pathway leading from the vestibular apparatus to the vomiting centre and is not effective in vomiting of other etiologies.

A transdermal patch containing 1.5 mg of hyoscine, to be delivered over 3 days has been developed. Applied behind the pinna, it sup-

presses motion sickness while producing only mild side effects.

Dicyclomine (10–20 mg oral) has been used for prophylaxis of motion sickness and for morning sickness. It has been cleared of teratogenic potential.

H₁ ANTIHISTAMINICS (See Ch. 11)

Some antihistaminics are antiemetic. They are useful mainly in motion sickness and to a lesser extent in morning sickness, postoperative and some other forms of vomiting. Their antiemetic effect appears to be based on anticholinergic, antihistaminic and sedative properties.

Promethazine, diphenhydramine, dimenhydrinate These drugs afford protection of motion sickness for 4–6 hours, but produce sedation and dryness of mouth. By their central anticholinergic action they block the extrapyramidal side effects of metoclopramide while supplementing its antiemetic action. Their combination is used in chemotherapy induced vomiting.

Promethazine theoclate (AVOMINE 25 mg tab.) It has been specially promoted as an antiemetic, but the action does not appear to be significantly different from promethazine HCl.

Doxylamine It is a sedative H₁ antihistaminic with prominent anticholinergic activity. Marketed in combination with pyridoxine, it is specifically promoted in India for 'morning sickness' (vomiting of early pregnancy) although such use is not made in the USA, UK and many other countries.

After over 2 decades of worldwide use of a combination product of doxylamine for morning sickness, some reports of foetal malformation appeared and the product was withdrawn in 1981. Subsequent studies have both supported and refuted its teratogenic potential. Though the US-FDA and CSM in UK found no credible evidence of increase in birth defects, they did not rule out the possibility. The product remains suspended in these countries, probably to avoid litigation, but not due to safety or efficacy concerns. In USA and UK doxylamine is available for treatment of allergic reaction, cough and cold.

Oral absorption of doxylamine is slow, and its $t_{1/2}$ is 10 hr. The side effects are drowsiness, dry mouth, vertigo and abdominal upset.

Dose: 10–20 mg at bed time; if needed additional doses may be given in morning and afternoon.

DOXINATE, GRAVIDOX, VOMNEX, NOSIC: 10 mg with pyridoxine 10 mg tab.

Cyclizine, meclizine These are less sedative and less anticholinergic. Meclizine is long-acting, protects against sea sickness for nearly 24 hours.

MAREZINE: Cyclizine 50 mg tab; **DILIGAN:** Meclizine 12.5 mg + nicotinic acid 50 mg tab; **PREGNIDOXIN:** Meclizine 25 mg + Caffeine 20 mg tab.

Cinnarizine It is an antivertigo drug, and is also protective for motion sickness. It probably acts by inhibiting influx of Ca^{2+} from endolymph into the vestibular sensory cells which mediates labyrinthine reflexes.

Anticholinergic-antihistaminic antiemetics are the first choice drugs for *motion sickness*. Antidopaminergic and anti-HT₃ drugs are less effective. All antimotion sickness drugs act better when taken ½–1 hour before commencing journey. Once sickness has started, it is more difficult to control; higher doses/parenteral administration may be needed.

The antihistaminics are suspected to have teratogenic potential, but there is no conclusive proof. Nevertheless, it is better to avoid them for morning sickness. Most cases of morning sickness can be managed by reassurance and dietary adjustment. If an antiemetic has to be used, dicyclomine, promethazine, prochlorperazine or metoclopramide may be prescribed in low doses.

NEUROLEPTICS (see Ch. 32)

These are potent antiemetics; act by blocking D2 receptors in the CTZ; antagonize apomorphine induced vomiting and have additional antimuscarinic as well as H₁ antihistaminic property. They have broad spectrum antiemetic action effective in:

(a) Drug induced and postanaesthetic nausea and vomiting.

- (b) Disease induced vomiting: gastroenteritis, uraemia, liver disease, migraine, etc.
- (c) Malignancy associated and cancer chemotherapy (mildly emetogenic) induced vomiting.
- (d) Radiation sickness vomiting (less effective).
- (e) Morning sickness: should not be used except in hyperemesis gravidarum.

They are less effective in motion sickness: the vestibular pathway does not involve dopaminergic link.

Most of these drugs produce significant degree of sedation. Acute muscle dystonia may occur after a single dose, especially in children and girls. The antiemetic dose is generally much lower than antipsychotic doses. These agents should not be administered until the cause of vomiting has been diagnosed; otherwise specific treatment of conditions like intestinal obstruction, appendicitis may be delayed due to symptom relief.

Prochlorperazine This D2 blocking phenothiazine is a labyrinthine suppressant, has selective antivertigo and antiemetic actions. It is highly effective when given by injection in vertigo associated with vomiting and to some extent in cancer chemotherapy associated vomiting. Prochlorperazine is used as an antiemetic rather than as antipsychotic. Muscle dystonia and other extrapyramidal side effects are the most important limiting features.

STEMETIL 5, 25 mg tabs., 12.5 mg/ml inj, 1 ml amp, 10 ml vial.

PROKINETIC DRUGS

These are drugs which promote gastrointestinal transit and speed gastric emptying by enhancing coordinated propulsive motility.

Metoclopramide

Metoclopramide is chemically related to procainamide, but has no pharmacological similarity with it. Introduced in early 1970s as a 'gastric hurrying' agent, it is now a widely used antiemetic.

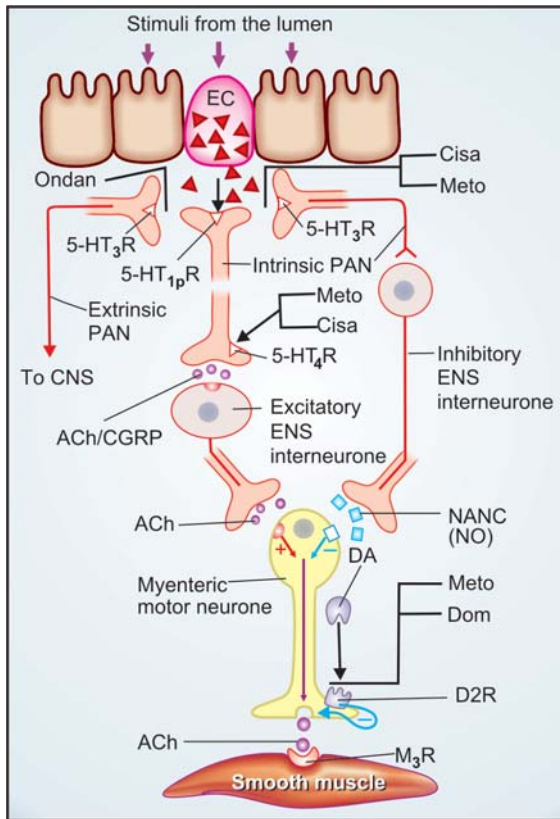

Fig. 47.2: Schematic depiction of serotonergic (5-HT) regulation of peristaltic reflex, and sites of action of prokinetic drugs.

Distention and other luminal stimuli trigger 5-HT release from the enterochromaffin cells (EC) located in the enteric mucosa. This stimulates intrinsic and extrinsic primary afferent neurons (PAN) of the enteric nervous system (ENS) through peripheral variant of 5-HT₁ receptor (5-HT_{1p}R) and 5-HT₃ receptor (5-HT₃R). The extrinsic PAN convey impulses to the CNS *via* vagus and dorsal root ganglia and participate in the causation of vomiting when stimulation is strong. Ondansetron (Ondan) acts partly by blocking activation of extrinsic PAN through 5-HT₃R.

The intrinsic PAN interact with excitatory and inhibitory interneurons of the ENS to mediate both contraction (of proximal gut muscles) and relaxation (of distal gut muscles) to coordinate the peristaltic reflex, respectively through release of acetylcholine (ACh)/calcitonin gene related peptide (CGRP) and nonadrenergic–noncholinergic (NANC) transmitter, which mainly is nitric oxide (NO). Cisapride (Cisa.) and metoclopramide (Meto.) activate the pre-junctional 5-HT₄ receptors (5-HT₄R) located on the terminals of the intrinsic PAN and promote ACh/CGRP release, and thereby the contractile activity. The weak 5-HT₃ blocking action of Cisa. and Meto., in addition, reduces activity in the inhibitory interneurone (minor action).

Domperidone (Dom) and Meto also block the action of dopamine (DA) on pre-junctional D₂ receptor (D₂R) which normally inhibits ACh release from the myenteric motor neurone, and thus augment smooth muscle contraction elicited through muscarinic M₃ receptor (M₃R)

Actions

GIT: It has more prominent effect on upper g.i.t.; increases gastric peristalsis while relaxing the pylorus and the first part of duodenum → speeds gastric emptying, especially if it was slow. This action is independent of vagal innervation, but is more prominent when vagus is intact. Lower esophageal sphincter (LES) tone is increased and gastroesophageal reflux is opposed. It also increases intestinal peristalsis to some extent, but has no significant action on colonic motility and gastric secretion.

CNS Metoclopramide is an effective antiemetic; acting on the CTZ, blocks apomorphine induced vomiting. The gastrokinetic action may contribute to the antiemetic effect. However, it has no chlorpromazine (CPZ) like neuroleptic action,

though it does share the extrapyramidal and prolactin secretion augmenting action of CPZ.

Mechanism of action: Metoclopramide acts through both dopaminergic and serotonergic receptors (*see* Fig. 47.2)

(a) D₂ antagonism Dopamine (acting through D₂ receptors) is an inhibitory transmitter in the g.i.t.— normally acts to delay gastric emptying when food is present in stomach. It also appears to cause gastric dilatation and LES relaxation attending nausea and vomiting. Metoclopramide blocks D₂ receptors and has an opposite effect— hastening gastric emptying and enhancing LES tone by augmenting ACh release. However, clinically this action is secondary to that exerted through 5HT₄ receptors.

The central antidopaminergic (D₂) action of metoclopramide on CTZ is clearly responsible

for its antiemetic property. Other manifestations of D2 blockade are antagonism of apomorphine induced vomiting, CPZ like extrapyramidal effects and hyperprolactinaemia.

(b) 5-HT₄ agonism Metoclopramide acts in the g.i.t. to enhance ACh release from myenteric motor neurones. This results from 5-HT₄ receptor activation on primary afferent neurones (PAN) of the ENS *via* excitatory interneurons (Fig. 47.2). The *gastric hurrying* and *LES tonic* effects are mainly due to this action which is synergised by bethanechol and attenuated by atropine.

(c) 5-HT₃ antagonism At high concentrations metoclopramide can block 5-HT₃ receptors present on inhibitory myenteric interneurons and in NTS/CTZ. The peripheral action can augment ACh release in the gut, but appears to be minor. The central anti 5-HT₃ action appears to be significant only when large doses are used to control chemotherapy induced vomiting.

Pharmacokinetics Metoclopramide is rapidly absorbed orally, enters brain, crosses placenta and is secreted in milk. It is partly conjugated in liver and excreted in urine within 24 hours; $t_{1/2}$ is 3–6 hours. Orally it acts in ½–1 hr, but within 10 min after i.m. and 2 min after i.v. injection. Action lasts for 4–6 hours.

Interactions It hastens the absorption of many drugs, e.g. aspirin, diazepam, etc. by facilitating gastric emptying. It reduces the extent of absorption of digoxin by allowing less time for it. Bioavailability of cimetidine is also reduced.

By blocking DA receptors in basal ganglia, it abolishes the therapeutic effect of levodopa.

Adverse effects Metoclopramide is generally well tolerated.

Sedation, dizziness, loose stools, muscle dystonias (especially in children) are the main side effects.

Long-term use can cause parkinsonism, galactorrhoea and gynaecomastia.

It should not be used to augment lactation. Though the amount secreted in milk is small, but

suckling infant may develop loose motions, dystonia, myoclonus.

Dose: 10 mg (children 0.2–0.5 mg/kg) TDS oral or i.m. For chemotherapy induced vomiting 0.3–1.0 mg/kg slow i.v./i.m. **PERINORM, MAXERON, REGLAN, SIGMET, 10 mg tab; 5 mg/5 ml syr; 10 mg/2 ml inj; 50 mg/10 ml inj.**

Uses

1. *Antiemetic:* Metoclopramide is an effective and popular drug for many types of vomiting—postoperative, drug induced, disease associated (especially migraine), radiation sickness, etc, but is less effective in motion sickness. Though ondansetron is preferred, metoclopramide continues to be used for prophylaxis and treatment of vomiting induced by highly emetic anticancer drugs (cisplatin, etc.). A higher dose (1 mg/kg i.v.) is often needed, but is effective when phenothiazines and antihistamines do not work. Promethazine, diphenhydramine, diazepam or lorazepam injected i.v. along with metoclopramide supplement its antiemetic action and reduce the attending dystonic reactions. Dexamethasone i.v. also augments the efficacy of metoclopramide.

Though no teratogenic effects have been reported, metoclopramide should be used for morning sickness only when not controlled by other measures.

2. *Gastrokinetic:* to accelerate gastric emptying:

- When emergency general anaesthesia has to be given and the patient has taken food less than 4 hours before.
- To relieve postvagotomy or diabetes associated gastric stasis.
- To facilitate duodenal intubation.

Clinical efficacy is moderate.

3. *Dyspepsia* and other functional g.i. disorders. Metoclopramide may succeed in stopping persistent hiccups.

4. *Gastroesophageal reflux disease (GERD)* Metoclopramide may afford symptomatic relief in milder cases of GERD, but is much less effective

than PPIs/H₂ blockers. It does not aid healing of esophagitis. It may be used as adjuvant to acid suppressive therapy, but additional benefit is uncertain.

Domperidone It is a D2 antagonist, chemically related to haloperidol, but pharmacologically related to metoclopramide. It has lower ceiling antiemetic and prokinetic actions. Unlike metoclopramide, its prokinetic action is not blocked by atropine and is based only on D2 receptor blockade in upper g.i.t. Domperidone crosses blood-brain barrier poorly. Accordingly, extrapyramidal side effects are rare, but hyperprolactinaemia can occur. However, it does act on CTZ which is not protected by blood-brain barrier. Antiemetic efficacy is lower than metoclopramide. Administered with levodopa or bromocriptine, it counteracts their dose limiting emetic action without affecting the therapeutic effect in parkinsonism.

Domperidone is absorbed orally, but bioavailability is only ~15% due to first pass metabolism. It is completely biotransformed and metabolites are excreted in urine. Plasma t_{1/2} is 7.5 hr.

Side effects Are much less than with metoclopramide: dry mouth, loose stools, headache, rashes, galactorrhoea. Cardiac arrhythmias have developed on rapid i.v. injection.

Dose: 10–40 mg (Children 0.3–0.6 mg/kg) TDS. Its indications are similar to that of metoclopramide, but it is a less efficacious gastrokinetic and not useful against high emetogenic chemotherapy.

DOMSTAL, DOMPERON, NORMETIC 10 mg tab, 1 mg/ml susp, MOTINORM 10 mg tab, 10 mg/ml drops.

Cisapride It is a prokinetic drug with little antiemetic property, because it lacks D2 receptor antagonism. Effects of cisapride on gastric motility resemble metoclopramide—gastric emptying is accelerated, LES tone is improved and esophageal peristalsis is augmented. It restores and facilitates motility throughout the g.i.t., including colon (metoclopramide/domperidone do not accelerate colonic transit). Cisapride often

produces loose stools. Its prokinetic action is exerted mainly through 5-HT₄ agonism which promotes ACh release from myenteric neurones, aided by weak 5-HT₃ antagonism which suppresses inhibitory transmission in myenteric plexus. Enteric neuronal activation *via* 5-HT₄ receptor also promotes cAMP-dependent Cl⁻ secretion in the colon, increasing water content of stools. Cisapride is devoid of action on CTZ and does not produce extrapyramidal symptoms or hyperprolactinaemia.

Oral bioavailability of cisapride is ~33%. It is primarily inactivated by hepatic metabolism by CYP3A4 with a t_{1/2} of ~10 hr. Dose needs to be reduced in liver disease.

Cisapride is a prokinetic drug without antidopaminergic side effects, but abdominal cramps and diarrhoea can occur. Other side effects are dizziness and occasional rise in serum transaminases.

Primary indication of cisapride has been GERD. Some patients derive symptomatic relief, but this is less complete compared to PPIs/H₂ blockers. Healing of esophageal lesions is infrequent. Other indications of cisapride are nonulcer dyspepsia, impaired gastric emptying and chronic constipation, though usefulness in these conditions also is limited.

Safety of cisapride was challenged by reports of serious ventricular arrhythmias and death, mainly among patients who took CYP3A4 inhibitors like azole antifungals, macrolide antibiotics, antidepressants, HIV protease inhibitors, etc. concurrently. At high concentrations, cisapride blocks delayed rectifying K⁺ channels in heart—prolongs Q-Tc interval and predisposes to *torsades de pointes*/ventricular fibrillation. It has been withdrawn in USA and some other countries, but is available in India.

Dose: 10–20 mg TDS; SYSPRIDE, UNIPRIDE, NUPRIDE 10 mg tab; MOTEN, PULSID 10 mg tab, 5 mg/5 ml susp.; CIZA also 20 mg tab

Mosapride A newer congener of cisapride with similar gastrokinetic and LES tonic action due to 5-HT₄ agonistic (major) and 5-HT₃ antagonistic

(minor) action in the myenteric plexus, but has not caused Q-Tc prolongation or arrhythmias. Like cisapride, it has no clinically useful antiemetic action and does not produce extrapyramidal/hyperprolactinaemic side effects due to absence of D2 blocking property. Indications and side effects are similar to cisapride.

Dose: 5 mg (elderly 2.5 mg) TDS.

MOZA, MOZASEF, NORMAGUT 2.5, mg, 5 mg tabs; MOZA MPS: 5 mg + methylpolysiloxane 125 mg tab.

Tegaserod It is a recently introduced selective 5-HT₄ partial agonist, with no action on 5-HT₃ and other receptors, which mainly augments colonic motility along with promotion of gastric emptying and intestinal transit, and less effect on LES tone. The 5-HT₄ agonistic action also increases colonic Cl⁻ (and water) secretion. The current indication of tegaserod is constipation-predominant irritable bowel syndrome (described in Ch. 48). Its possible use as a gastrokinetic is being explored.

5-HT₃ ANTAGONISTS

Ondansetron It is the prototype of a new class of antiemetic drugs developed to control cancer chemotherapy/radiotherapy induced vomiting, and later found to be highly effective in postoperative nausea and vomiting as well. It blocks the depolarizing action of 5-HT through 5-HT₃ receptors on vagal afferents in the g.i.t. as well as in NTS and CTZ. Cytotoxic drugs/radiation produce nausea and vomiting by causing cellular damage → release of mediators including 5-HT from intestinal mucosa → activation of vagal afferents in the gut → emetogenic impulses to the NTS and CTZ. Ondansetron blocks emetogenic impulses both at their peripheral origin and their central relay. It does not block dopamine receptors and apomorphine or motion sickness induced vomiting. A weak gastrokinetic action due to 5-HT₃ blockade has been detected, but it is clinically insignificant. A minor 5-HT₄ antagonistic action has also been shown.

Pharmacokinetics: Oral bioavailability of ondansetron is 60–70% due to first pass metabolism. It is hydroxylated by CYP 1A2, 2D6 and 3A, but no clinically significant drug interactions have been noted. It is eliminated in urine and faeces, mostly as metabolites; t_{1/2} being 3–5 hrs, and duration of action 4–12 hr.

Dose and efficacy: For cisplatin and other highly emetogenic drugs—8 mg i.v. by slow injection over 15 min ½ hr before chemotherapeutic infusion, followed by 2 similar doses 4 hour apart. To prevent delayed emesis 8 mg oral is given twice a day for 3–5 days. For postoperative nausea/vomiting 4–8 mg i.v. given before induction is repeated 8 hourly. For less emetogenic drugs and for radiotherapy an oral dose of 8 mg is given 1–2 hr prior to the procedure and repeated twice 8 hrly. It is effective in 60–80% cases; similar to or better than high doses of metoclopramide, and does not cause dystonias or sedation like the latter.

EMESET, VOMIZ, OSETRON, EMSETRON 4,8 mg tabs, 2 mg/ml inj in 2 ml and 4 ml amps.

Patients who do not obtain optimum protection by ondansetron alone, addition of dexamethasone, promethazine/diazepam or both enhances antiemetic efficacy. Adjuvant drugs are more often required for delayed phase vomiting that occurs on the second to fourth day of cisplatin therapy, because 5-HT₃ antagonists alone are less effective.

Other types of vomiting: Efficacy of 5-HT₃ antagonists in prevention and treatment of postoperative nausea and vomiting is now well established. Since this vomiting is multifactorial in origin, 5-HT₃ blockers are not as completely efficacious as in chemotherapy induced vomiting, and many other classes of antiemetic drugs are also protective. In comparative trials, superiority of ondansetron in terms of efficacy as well as lack of side effects and drug interactions has been demonstrated. Administered before surgery ondansetron (4–8 mg i.v.) repeated after 4 hours has become the first choice antiemetic at many centres.

Reports of efficacy in vomiting associated with drug overdose, side effect of cotrimoxazole and fluvoxamine, uraemia and certain neurological injuries are also available.

Some 5-HT₃ antagonists have produced symptomatic relief in diarrhoea-predominant irritable bowel syndrome.

Side effects: Ondansetron is generally well tolerated: the only common side effect is headache. Mild constipation or diarrhoea and abdominal discomfort occur in few patients. Rashes and allergic reactions are reported, especially after i.v. injection.

Granisetron It is 10–15 times more potent than ondansetron and probably more effective during the repeat cycle of chemotherapy. The weak 5-HT₄ blockade seen in ondansetron has not been detected in granisetron. Its plasma t_{1/2} is longer (8–12 hrs) and it needs to be given only twice on the day of chemotherapy. Side effect profile is similar to ondansetron.

Dose: 10 µg/kg i.v. 30 min before chemotherapy, repeated after 12 hr. For less emetogenic regimen 2 mg oral 1 hr before chemotherapy or 1 mg before and 1 mg 12 hr after it.

GRANICIP, GRANISSET 1 mg, 2 mg tabs; 1 mg/ml inj. (1, 3 ml amps).

Dolasetron, Tropisetron, and Palonosetron are the other selective 5-HT₃ antagonists.

ADJUVANT ANTIEMETICS

Corticosteroids (e.g. dexamethasone 8–20 mg i.v.) can alleviate nausea and vomiting due to moderately emetogenic chemotherapy, but are more often employed to augment the efficacy of other primary antiemetic drugs like metoclopramide and ondansetron for highly emetogenic regimens and for cisplatin induced delayed emesis. They also serve to reduce certain side effects of the primary antiemetic. However, because of their metabolic effects, they should be used only in selected and refractory cases.

Benzodiazepines The weak antiemetic property of BZDs is primarily based on the sedative action. Used as adjuvant to metoclopramide/ondansetron, diazepam/lorazepam (oral/i.v.) help by relieving anxiety, anticipatory vomiting and produce amnesia for the unpleasant procedure. They also suppress dystonic side effects of metoclopramide.

Cannabinoids Δ⁹ Tetrahydrocannabinol (Δ⁹ THC) is the active principle of the hallucinogen *Cannabis indica*. It possesses antiemetic activity against moderately emetogenic chemotherapy. It probably acts at higher centres or at vomiting centre itself by activating CB₁ subtype of cannabinoid receptors. The disorienting and other central effects of Δ⁹ THC limit its clinical utility.

Dronabinol, a synthetic Δ⁹ THC, is less hallucinogenic and more antiemetic than Δ⁹ THC. Dronabinol has been used for chemotherapy induced vomiting in patients who cannot tolerate other antiemetics or are unresponsive to them.

It has also been tried as an appetite stimulant in cachectic/AIDS patients. *Nabilone* is another cannabinoid with antiemetic property.

Gastroesophageal reflux disease (GERD)

It is a very common problem presenting as ‘heartburn’, acid eructation, sensation of stomach contents coming back in foodpipe, especially after a large meal, aggravated by stooping or lying flat. Some cases have an anatomical defect (hiatus hernia) but majority are only functional (LES relaxation in the absence of swallowing). Repeated reflux of acid gastric contents into lower 1/3rd of esophagus causes esophagitis, erosions, ulcers, pain on swallowing, dysphagia strictures, and increases the risk of esophageal carcinoma.

The primary barrier to reflux is the tone of LES which can be altered by several influences:

Inherent tone: of sphincteric smooth muscle.

Hormonal: gastrin increases, progesterone decreases (reflux is common in pregnancy).

Neurogenic: vagus is motor to the sphincter, promotes esophageal peristalsis.

Dietary: fats, alcohol, coffee, chocolates decrease, while protein rich foods increase LES tone.

Drugs: anticholinergics, tricyclic antidepressants, Ca²⁺ channel blockers, nitrates reduce LES tone.

Smoking: relaxes LES.

Delayed gastric emptying and increased intragastric pressure may overcome the LES barrier to reflux. GERD is a wide spectrum of conditions from occasional heartburn to persistent incapacitating reflux which interferes with sleep and results in esophageal, laryngotracheal and pulmonary complications. Severity of GERD may be graded as:

Stage 1: occasional heartburn (<3 episodes/week), mostly only in relation to a precipitating factor, mild symptoms, no esophageal lesions.

Stage 2: ≥ 3 episodes/week of moderately severe symptoms, nocturnal awakening due to regurgitation, esophagitis present or absent.

Stage 3: Daily/chronic symptoms, disturbed sleep, esophagitis/erosions/stricture, symptoms recur soon after treatment stopped.

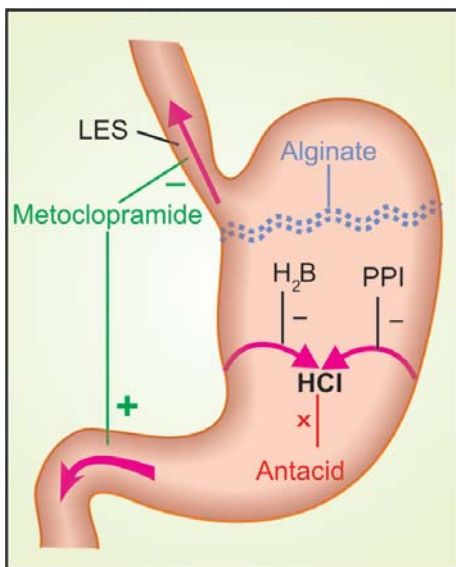

Fig. 47.3: Sites and mechanisms of drug action in gastroesophageal reflux disease.

Metoclopramide increases lower esophageal sphincter (LES) tone and promotes gastric emptying. Proton pump inhibitor (PPI) and H_2 blocker (H_2B) inhibit acid secretion, while antacids neutralize it. Alginate floats on gastric contents and prevents contact of esophageal mucosa with gastric acid

Though GERD is primarily a g.i. motility disorder, acidity of gastric contents is the most important aggressive factor in causing symptoms and esophageal lesions. The functional abnormality is persistent; dietary and other lifestyle measures (light early dinner, raising head end of bed, weight reduction and avoidance of precipitating factors) must be taken.

Treatment of GERD is individualized according to severity and stage of the disorder.

The site and mechanism of benefit afforded by different classes of drugs in GERD is depicted in Fig. 47.3.

1. Proton pump inhibitors (PPIs) These are the most effective drugs, both for symptomatic relief as well as for healing of esophageal lesions. Intra-gastric pH >4 maintained for ~ 18 hr/day is considered optimal for healing of esophagitis. This level of acid suppression can be consistently

achieved only by PPIs. Therefore, PPIs are the drugs of choice for all stages of GERD patients, particularly stage 2 and 3 cases. Symptom relief is rapid and 80–90% esophageal lesions heal in 4–8 weeks. Dose titration is needed according to response in individual patients. Some patients require twice daily dosing. Prolonged (often indefinite) therapy is required in chronic cases because symptoms recur a few days after drug stoppage. PPIs have no effect on LES tone.

2. H_2 blockers They reduce acidity of gastric contents and have no effect on LES tone. H_2 blockers cause less complete acid suppression than PPIs—adequate symptom relief is obtained only in mild cases; healing of esophagitis may occur in 50–70% patients. H_2 antagonists are indicated in stage-1 cases, or as alternative to PPIs in stage 2 or 3. The daily dose should be divided into 2–3 portions for better response.

3. Antacids Their use in GERD is limited to occasional or intercurrent relief of heartburn. Antacids are no longer employed for healing of esophagitis.

4. Sodium alginate It forms a thick frothy layer which floats on the gastric contents like a raft may prevent contact of acid with esophageal mucosa. It has no effect on LES tone. Combination of alginate with antacids may be used in place of antacids alone, but real benefit is marginal.

REFLUX LIQUID: Sod. alginate 200 mg + alum. hydrox. gel 300 mg + mag. trisilicate 125 mg/10 ml susp; **REFLUX FORTE** Aginic acid 20 mg + sod. bicarb. 70 mg + alum. hydrox. 300 mg tab; **GAVISCON** Alginic acid 500 mg + mag. trisilicate 25 mg + alum. hydrox. gel 100 mg + sod. bicarb. 170 mg tab.

5. Prokinetic drugs Metoclopramide, cisapride and other prokinetic drugs may relieve regurgitation and heartburn by increasing LES tone, improving esophageal clearance and facilitating gastric emptying, but do not affect gastric acidity or promote healing of esophagitis. Symptom control afforded by prokinetic drugs is inferior to that by PPIs/ H_2 blockers. Their use in GERD has declined. Prokinetic drugs are occasionally added to PPI/ H_2 blocker therapy, but whether this improves outcome is not clear.

CARMINATIVES

These are drugs which promote the expulsion of gases from the g.i.t. and give a feeling of warmth and comfort in the epigastrium.

Commonly used drugs are:

Sodium bicarbonate	: 0.6–1.5 g
Oil Peppermint	: 0.06–0.1 ml
Tincture Cardamom Co.	: 1–2 ml
Oil of dil	: 0.06–0.2 ml
Tincture ginger	: 0.6–1 ml

Sodium bicarbonate reacts with gastric HCl and evolves CO₂ which rapidly distends stomach, relaxes LES and brings about eructation.

The others are condiments and spices, contain volatile oil, which by their mild irritant action and flavour relax LES and increase g.i.t. motility. They give a feeling of warmth and comfort in the abdomen.

Used for: flatulent dyspepsia.

DIGESTANTS

These are substances intended to promote digestion of food. A number of proteolytic, amylolytic and lipolytic enzymes are marketed in combination formulations and are vigorously promoted for dyspeptic symptoms, and as appetite stimulants or health tonics. They are occasionally beneficial, only when their elaboration in g.i.t. is deficient. Their routine use in tonics and appetite improving mixtures is irrational.

- Hydrochloric acid** It may be used in achlorhydria; 5–10 ml of dilute HCl (10%) should be further diluted to 100–200 ml with water and sipped with a straw (to prevent contact with teeth) during meals.
- Pepsin** May be used along with HCl in gastric achylia due to atrophic gastritis, gastric carcinoma, pernicious anaemia, etc.
- Papain** It is a proteolytic enzyme obtained from raw papaya. Its efficacy after oral ingestion is doubtful.
- Pancreatin** It is a mixture of pancreatic enzymes obtained from hog and pig pancreas. It contains amylase, trypsin and lipase; indicated in chronic pancreatitis and other exocrine pancreatic deficiency states. Fat and nitrogen content of stools may be reduced and diarrhoea/steatorrhoea may be prevented. It has to be used as enteric coated tablets or capsules to protect the enzymes from being themselves digested in stomach by pepsin. Nausea, diarrhoea and hyperuricaemia are the occasional side effects.
- Diastase and Takadiastase** These are amylolytic enzymes obtained from the fungus *Aspergillus oryzae*. They have been used in pancreatic insufficiency, but efficacy is equivocal.

Preparations

ALVIZYME: Pancreatin 125 mg, simethicone 25 mg tab.
BESTOZYME: Alfa amylase 320 mg, papain 60 mg, dimethicone 40 mg cap.

DIGENZYMES: Diastase 19 mg, pepsin 110 mg, papain 50 mg per 10 ml liq.

DIGIPLEX: Diastase 20 mg, pepsin 20 mg, vit B₁ 1 mg, vit B₂ 1 mg, vit B₆ 0.5 mg, nicotinamide 10 mg, pantothenyl alcohol 2 mg, vit B₁₂ 0.5 µg per 10 ml liq.
DIZEC: Pancreatin 250 mg, sod. tauroglycocholate 50 mg, methylpolysiloxane 25 mg tab.

LUPIZYME: Pepsin 12.5 mg, diastase 18.75 mg, vit B₁ 2 mg, B₂ 1 mg, B₆ 1.5 mg, B₁₂ 1 µg, pantothenol 1.5 mg, nicotinamide 15 mg per 5 ml syr.

PEPSINOZYME: Diastase 150 mg, pepsin 50 mg, papain 30 mg, vit B₁ 0.5 mg, vit B₂ 0.5 mg, niacinamide 5 mg, activated charcoal 75 mg tab.

RALCRIZYME: Pancreatin 150 mg, bile extract 25 mg, pepsin 5 mg, diastase 10 mg, methyl polysiloxane 25 mg tab.

TAKADIASTASE: Takadiastase 162 mg tab.

Enzyme preparations containing an antispasmodic or a laxative and fixed dose combinations of pancreatine or pancrelipase containing amylase, protease and lipase with any other enzyme are banned in India.

Methyl polysiloxane (Dimethyl polysiloxane, Simethicone, Dimethicone) It is a silicone polymer, a viscous amphiphilic liquid—reduces surface tension and collapses froth, 'antifoaming agent'. It is not absorbed from g.i.t. and is pharmacologically inert. Added to antacid, digestant and antireflux preparations (*see above*), it is claimed to relieve flatulence, to coat and protect ulcer surface, to aid dispersion of antacids in gastric contents, and to prevent gastroesophageal reflux. However, clinical efficacy is equivocal.

Dose: 40–120 mg 3 to 4 times a day.

DIMOL 40 mg tab. (single ingredient).

GALLSTONE DISSOLVING DRUGS

Cholesterol (CH) remains dissolved in bile with the help of bile salts (salts of cholic acid and chenodeoxycholic acid conjugated with glycine and taurine) because bile salts are highly amphiphilic. A high CH : bile salt ratio favours crystallization of CH in bile; these crystals act as nuclei for stone formation. *Chenodeoxycholic acid* (Chenodiol) and *Ursodeoxycholic acid* (Ursodiol) decrease CH content of bile, enabling solubilization of CH from stone surface. These two bile acids act differently.

CHENODIOL

1. Acts primarily by inhibiting CH synthesis in liver. It is a HMG-CoA-reductase inhibitor. Does not reduce intestinal CH absorption.
2. Raises plasma LDL-CH by reducing LDL receptors in liver.
3. Reduces CH secretion in bile after prolonged administration.
4. Generates a more litholytic bile acid pool.
5. Promotes micellar solubilization of CH.

URSODIOL

- Acts primarily by inhibiting intestinal CH absorption. Has inconsistent effect on HMG-CoA-reductase. Little inhibition of hepatic CH synthesis. Does not raise plasma LDL-CH level. Promptly reduces CH secretion in bile. Itself lowers CH saturation index of bile. Promotes solubilization by liquid crystal formation.

Chenodiol In a dose of 10–15 mg/kg/day it has been found to partially or completely dissolve CH gallstones in about 40% patients over 1/2 to 2 years. However, only 1/3 of these had complete dissolution. Pigment stones and calcified stones (15–20% cases) are not affected.

Side effects Diarrhoea occurs in nearly half of the patients. It is dose-related and generally mild. Raised aminotransferase level is also common and dose-related, but overt liver damage occurs in only 3% patients. It is reversible.

Gastric and esophageal mucosal resistance to acid is impaired favouring ulceration.

Ursodiol It is a hydroxy epimer of chenodiol, is more effective and needs to be used at lower doses (7–10 mg/kg/day). Complete dissolution of CH stones has been achieved in upto 50% cases. It is also much better tolerated. Diarrhoea and hypertransaminaemia are infrequent, but effect on mucosal resistance is similar to chenodiol. Calcification of some gall stones may be induced.

Dose: 450–600 mg daily in 2–3 divided doses after meals; UDCA, UDIHEP 150 mg tab.

Dissolution of gallstones is a very slow process: patient compliance is often poor. However, medical treatment is now possible in selected patients:

- (a) Only CH stones (radiolucent, generally multiple stones that float on oral cholecystography) are amenable.
- (b) Smaller stones respond better; therapy is not indicated if stone is > 15 mm in diameter.
- (c) Gallbladder should be functional. If bile is not entering gallbladder, it will not be able to solubilize the stones.
- (d) Contraindicated in pregnant women and those likely to conceive (foetal damage possible).

Efficacy of these drugs is enhanced by a single daily bedtime dose and by low CH diet. Concurrent lithotripsy speeds dissolution rate. Because chenodiol and ursodiol act differently, their combination at 1/2 of the individual doses is more effective and attended with fewer adverse effects. However, ursodiol alone is the preferred drug.

Another method of achieving quick dissolution is direct instillation of liquid ether, methylterbutyl ether into the gallbladder through a percutaneous pigtail catheter.

Once treatment is discontinued after stone dissolution, recurrences are common, because bile returns to its CH supersaturated state. Repeat courses may have to be given. Because of these problems the pros and cons of medical therapy must be weighed against cholecystectomy.

Other uses Bile salts and bile acids have been used as replacement therapy in cholestasis, biliary fistula and liver disease. They are a constituent of many combination formulations. Ursodiol, because it is not hepatotoxic, may be useful in cirrhosis and some other hepatic disorders.

CHAPTER 48

Drugs for Constipation and Diarrhoea

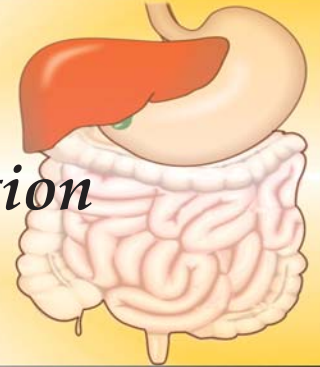

LAXATIVES

(Aperients, Purgatives, Cathartics)

These are drugs that promote evacuation of bowels. A distinction is sometimes made according to the intensity of action.

(a) *Laxative or aperient*: milder action, elimination of soft but formed stools.

(b) *Purgative or cathartic*: stronger action resulting in more fluid evacuation.

Many drugs in low doses act as laxative and in larger doses as purgative.

CLASSIFICATION

1. Bulk forming

Dietary fibre: Bran, Psyllium (Plantago)
Ispaghula, Methylcellulose

2. Stool softener

Docusates (DOSS), Liquid paraffin

3. Stimulant purgatives

(a) *Diphenylmethanes*

Phenolphthalein, Bisacodyl, Sodium
picosulfate

(b) *Anthraquinones (Emodins)*

Senna, Cascara sagrada

(c) *5-HT₄ agonist*

Tegaserod

(d) *Fixed oil*

Castor oil

4. Osmotic purgatives

Magnesium salts: sulfate, hydroxide

Sodium salts: sulfate, phosphate

Sod. pot. tartrate

Lactulose

MECHANISM OF ACTION

All purgatives increase the water content of faeces by:

(a) A hydrophilic or osmotic action, retaining water and electrolytes in the intestinal lumen—increase volume of colonic content and make it easily propelled.

(b) Acting on intestinal mucosa, decrease net absorption of water and electrolyte; intestinal transit is enhanced indirectly by the fluid bulk.

(c) Increasing propulsive activity as primary action—allowing less time for absorption of salt and water as a secondary effect.

For some of the drugs, controversy continues as to whether they increase water content of stools as the primary action or it is a consequence of increased motility. However, certain purgatives do increase motility through an action on the myenteric plexuses. Laxatives modify the fluid

dynamics of the mucosal cell and may cause fluid accumulation in gut lumen by one or more of following mechanisms:

- Inhibiting $\text{Na}^+\text{K}^+\text{ATPase}$ of *villous cells*—impairing electrolyte and water absorption.
- Stimulating adenylyl cyclase in *crypt cells*—increasing water and electrolyte secretion.
- Enhancing PG synthesis in mucosa which increases secretion.
- Structural injury to the absorbing intestinal mucosal cells.

BULK PURGATIVES

Dietary fibre: bran Dietary fibre consists of unabsorbable cell wall and other constituents of vegetable food—cellulose, pectins, glycoproteins and other polysaccharides. Bran is a byproduct of flour industry—consists of ~40% dietary fibre. It absorbs water in the intestines, swells, increases water content of faeces—softens it and facilitates colonic transit. Osmotically active products may be formed in the colon by bacterial degradation of pectins, etc. which act to retain water. Dietary fibre supports bacterial growth in colon which contribute to the faecal mass. Certain dietary fibres (gums, lignins, pectins) bind bile acids and promote their excretion in faeces → degradation of cholesterol in liver is enhanced → plasma LDL-cholesterol is lowered.

Increased intake of dietary fibres is the most appropriate method for prevention of functional constipation. It is the first line approach for most patients of simple constipation. Prolonged intake of bran and other bulk forming agents reduces rectosigmoid intraluminal pressure—relieves symptoms of irritable bowel syndrome (IBS) including pain, constipation as well as diarrhoea, and of colonic diverticulosis. It is also useful when straining at stools has to be avoided.

Drawbacks: Bran is generally safe, but it is unpalatable, large quantity (20–40 g/day) needs to be ingested. It has been included in some breakfast cereals. Full effect requires daily intake for at least 3–4 days. It does not soften faeces

already present in colon or rectum. As such, bran is useful for prevention of constipation, but not for treating already constipated subjects. Flatulence may occur.

It should not be used in patients with gut ulcerations, adhesions, stenosis and when faecal impaction is a possibility.

Psyllium (Plantago) and Ispaghula They contain natural colloidal mucilage which forms a gelatinous mass by absorbing water; 3–12 g of refined husk freshly mixed with water or milk and taken daily—acts in 1–3 days. It should not be swallowed dry (may cause esophageal impaction).

Ispaghula husk (refined): **ISOGEL** (27 g/ 30 g), **NATURE CURE** (49 g/100 g), **FYBOGEL** (3.5 g/5.4 g) powder
FIBRIL (3.4 g/11 g) powder;
Psyllium hydrophilic mucilloid: **ISOVAC** (65 g/100 g) granules.

Methylcellulose A semi-synthetic, colloidal, hydrophilic derivative of cellulose; 4–6 g/day is satisfactory in most individuals.

Generous amounts of water must be taken with all bulk forming agents. The choice among different bulking agents is a matter of personal preferences.

STOOL SOFTENER

Docusates (Dioctyl sodium sulfosuccinate: DOSS) It is an anionic detergent, softens the stools by net water accumulation in the lumen by an action on the intestinal mucosa. It emulsifies the colonic contents and increases penetration of water into faeces. By a detergent action, it can disrupt the mucosal barrier and enhance absorption of many nonabsorbable drugs, e.g. liquid paraffin—should not be combined with it. It is a mild laxative; especially indicated when straining at stools must be avoided.

Dose: 100–400 mg/day; acts in 1–3 days.

CELLUBRIL 100 mg cap; **LAXICON** 100 mg tab, **DOSLAX** 150 mg cap.

As enema 50–150 mg in 50–100 ml;

LAXICON 125 mg in 50 ml enema.

Cramps and abdominal pain can occur. It is bitter; liquid preparations may cause nausea. Hepatotoxicity is feared on prolonged use.

Liquid paraffin It is a viscous liquid; a mixture of petroleum hydrocarbons, that was introduced as a laxative at the turn of 19th century. Millions of gallons have passed through the intestinal pipeline since then. It is pharmacologically inert. Taken for 2–3 days, it softens stools and is said to lubricate hard scybali by coating them.

Dose: 15–30 ml/day—oil as such or in emulsified form.

Disadvantages

- It is bland but very unpleasant to swallow because of oily consistency.
 - Small amount passes into the intestinal mucosa—is carried into the lymph → may produce foreign body granulomas in the intestinal submucosa, mesenteric lymph nodes, liver and spleen.
 - While swallowing it may trickle into lungs—cause lipid pneumonia.
 - Carries away fat soluble vitamins with it into the stools: deficiency may occur on chronic use.
 - Leakage of the oil past anal sphincter may embarrass.
 - May interfere with healing in the anorectal region.
- Thus, it should be used only occasionally.

STIMULANT PURGATIVES

They are powerful purgatives: often produce griping. They were thought to irritate the intestinal mucosa and thus stimulate motor activity. Though some of them do primarily increase motility by acting on myenteric plexuses, the more important mechanism of action is accumulation of water and electrolytes in the lumen by altering absorptive and secretory activity of the mucosal cell. They inhibit $\text{Na}^+\text{K}^+\text{ATPase}$ at the basolateral membrane of villous cells—transport of Na^+ and accompanying water into the interstitium is reduced. Secretion is enhanced by activation of cAMP in crypt cells and by increased PG synthesis.

Larger doses of stimulant purgatives can cause excess purgation → fluid and electrolyte imbalance. Hypokalaemia can occur on regular use. Routine and long-term use must be discouraged; produces colonic atony. They can reflexly stimulate gravid uterus—contraindicated during pregnancy. Subacute or chronic intestinal obstruction is another contraindication.

Diphenylmethanes

Phenolphthalein is an indicator and is in use as purgative from the beginning of the 20th century. It turns urine pink if alkaline.

Bisacodyl is a later addition and is more popular.

They are partly absorbed and reexcreted in bile: enterohepatic circulation is more important in phenolphthalein which can produce protracted action. Bisacodyl is activated in the intestine by deacetylation. Their primary site of action is in the colon: irritate the mucosa, produce mild inflammation and secretion. One or two semiformal motions occur after 6–8 hours. Optimum doses vary considerably among individuals. Average doses are:

Phenolphthalein 60–130 mg: LAXIL 130 mg tab. To be taken at bedtime (tab. not to be chewed).

Bisacodyl 5–15 mg: DULCOLAX 5 mg tab; 10 mg (adult), 5 mg (child) suppository: CONLAX 5 mg, 10 mg suppository, BIDLAX-5 5 mg tab.

These doses may be ineffective in some individuals, but produce fluid evacuations and cramps in others. Morphological alterations in the colonic mucosa have been observed—mucosa becomes more leaky.

Allergic reactions—skin rashes, fixed drug eruption and Stevens-Johnson syndrome have been reported.

Phenolphthalein has been found to produce tumours in mice and genetic damage. The US-FDA has ordered its withdrawal from the market.

Bisacodyl is also available as 5 mg (infant) and 10 mg (adult) suppository—acts by irritating the anal and rectal mucosa → reflex increase in motility → evacuation occurs in 20–40 min. It can cause inflammation and mucosal damage.

Sodium picosulfate: Another diphenylmethane related to bisacodyl. Like others, it is hydrolysed by colonic bacteria to the active form, which then acts locally to irritate the mucosa and activate myenteric neurones. Bowel movement generally occurs after 6–12 hours of oral dose. Along with

mag. citrate solution, it has been used to evacuate the colon for colonoscopy or surgery.

Dose: 5–10 mg at bed time. Indications and side effects are similar to bisacodyl.

CREMALAX, LAXICARE 10 mg tab; **PICOFIT** 5 mg/5 ml syr.

Anthraquinones

Senna is obtained from leaves and pod of certain *Cassia sp.*, while *Cascara sagrada* is the powdered bark of the buck-thorn tree. These and a number of other plant purgatives contain anthraquinone glycosides, also called *emodins*. *Senna* is most popularly used. The glycosides are not active as such. Unabsorbed in the small intestine, they are passed to the colon where bacteria liberate the active *anthrol* form, which either acts locally or is absorbed into circulation—excreted in bile to act on small intestine. Thus, they take 6–8 hours to produce action. Amount secreted in milk is sufficient to cause purgation in the suckling infant.

The purgative action and uses of anthraquinones are quite similar to diphenylmethanes. Taken at bed time—a single, soft but formed evacuation generally occurs in the morning. Cramps and excessive purging occur in some cases. The active principle acts on the myenteric plexus to increase peristalsis and decrease segmentation. They also promote secretion and inhibit salt and water absorption in the colon. *Senna* anthraquinone has been found to stimulate PGE₂ production in rat intestine—this is blocked by indomethacin and the purgative action is reduced.

Skin rashes, fixed drug eruption are seen occasionally.

Regular use for 4–12 months causes colonic atony and mucosal pigmentation (melanosis).

Sennosides (Cal. salt): **GLAXENNA** 11.5 mg tab; **PURSENNID** 18 mg tab; **SOFSENA** 12 mg tab.

Tegaserod It is a new selective 5-HT₄ receptor partial agonist with no action on other receptors. By activating prejunctional 5-HT₄ receptors on intrinsic enteric afferents (see Fig. 47.2), tegaserod enhances release of excitatory transmitters ACh and calcitonin gene related peptide (CGRP)

which promote peristaltic reflex and colonic secretion (by enhancing cAMP mediated Cl⁻ efflux). Propulsive activity is increased in the stomach, ileum and most prominently in colon.

The primary indication of tegaserod is constipation-predominant irritable bowel syndrome (IBS), in which modest increase in stool frequency and some relief of abdominal pain and bloating have been noted. It is also approved for treatment of chronic constipation: frequency of satisfactory bowel movement is moderately increased and hardness of stools/straining are reduced. However, efficacy in IBS as well as chronic constipation is not superior to conventional laxatives.

Only a small fraction of tegaserod is absorbed. It is mainly excreted unchanged in faeces. The elimination t_{1/2} of absorbed drug is 11 hr. Side effects reported are loose motions, flatulence and headache.

Dose: 2–6 mg BD before meals.

TEGIBIS, IBSINORM 2, 6 mg tabs; **TAGON, TEGOD** 6 mg tab.

Castor oil

It is one of the oldest purgatives. Castor oil is a bland vegetable oil obtained from the seeds of *Ricinus communis*; has been used on the skin as emollient. It mainly contains triglyceride of ricinoleic acid which is a polar long chain fatty acid. Castor oil is hydrolysed in the ileum by lipase to ricinoleic acid and glycerol. Ricinoleic acid, being polar, is poorly absorbed. It was believed to irritate the mucosa and stimulate intestinal contractions. The primary action has now been shown to be decreased intestinal absorption of water and electrolytes, and enhanced secretion by a detergent like action on the mucosa. Structural damage to the villous tips (expected of a detergent) has also been observed. Peristalsis is increased secondarily.

Dose: 15–25 ml (adults) 5–15 ml (children) is generally taken in the morning. Because the site of action is small intestine, purgation occurs in 2–3 hours—motion is semifluid and often accompanied by griping.

Due to its unpalatability, frequent cramping, a rather violent action, possibility of dehydration and after-constipation (due to complete evacuation of colon), it is no longer a favoured purgative. Regular use is particularly to be avoided—may damage intestinal mucosa.

OSMOTIC PURGATIVES

Solutes that are not absorbed in the intestine retain water osmotically and distend the

bowel—increasing peristalsis indirectly. Magnesium ions release cholecystokinin which may aid purgative action of Mag. salts. All inorganic salts used as osmotic (saline) purgatives have similar action—differ only in dose, palatability and risk of systemic toxicity.

- Mag. sulfate (Epsom salt): 5–15 g; bitter in taste.
- Mag. hydroxide (as 8% W/W suspension—milk of magnesia) 30 ml; bland in taste, also used as antacid.
- Sod. sulfate (Glauber's salt): 10–15 g; bad in taste.
- Sod. phosphate: 6–12 g, taste not unpleasant.
- Sod. pot. tartrate (Rochelle salt): 8–15 g, relatively pleasant tasting.

The salts in above mentioned doses, dissolved in 150–200 ml of water, produce 1–2 fluid evacuations within 1–3 hours with mild cramping; cause nearly complete emptying of bowels. Smaller doses may have a milder laxative action.

Mag. salts are contraindicated in renal insufficiency, while Sod. salts should not be given to patients of CHF and other Sod. retaining states. Repeated use of saline purgatives can cause fluid and electrolyte imbalance.

They are practically not used for the treatment of constipation, because afterconstipation is quite common. However, they may be preferred for preparation of bowel before surgery and colonoscopy; in food/drug poisoning and as after-purge in treatment of tapeworm infestation.

Lactulose It is a semisynthetic disaccharide of fructose and lactose which is neither digested nor absorbed in the small intestine—retains water. Further, it is broken down in the colon by bacteria to osmotically more active products. In a dose of 10 g BD taken with plenty of water, it produces soft formed stools in 1–3 days. Flatulence and flatus is common, cramps occur in few. Some patients feel nauseated by its peculiar sweet taste.

Lactulose causes reduction of blood NH_3 concentration by 25–50% in patients with hepatic encephalopathy. The breakdown products of lactulose are acidic—reduce the pH of stools.

Ammonia produced by bacteria in colon is converted to ionized NH_4^+ salts and is not absorbed. For this purpose 20 g TDS or more may be needed.

LACSAN, MTLAC 10 g/15 ml liq. DUPHALAC, LIVO-LUK 6.67 g/10 ml liq.

Other drugs used to reduce blood NH_3 in hepatic coma are *sod. benzoate* and *sod. phenyl acetate*. They combine with NH_3 in blood to form hippuric acid or phenyl acetic glutamine respectively: these are rapidly excreted in urine.

CHOICE AND USE OF PURGATIVES

Laxatives are as important for their harmfulness as they are for their value in medicine.

All laxatives are *contraindicated* in:

- (i) A patient of undiagnosed abdominal pain, colic or vomiting.
- (ii) Organic (secondary) constipation due to stricture or obstruction in bowel, hypothyroidism, hypercalcaemia, malignancies and certain drugs, e.g.—opiates, sedatives, anticholinergics including antiparkinsonian, antidepressants and antihistaminics, oral iron, clonidine, verapamil and laxative abuse itself.

The primary cause should be treated in these cases.

Valid indications of laxatives are:

1. **Functional constipation** Constipation is infrequent production of hard stools requiring straining to pass, or a sense of incomplete evacuation. Constipation is a symptom rather than a disease. Various aspects of the patient's lifestyle may contribute:

- (a) Misconception about the normal/necessary frequency, amount or consistency of stools.
- (b) Inadequate fibre in diet, less fluid intake.
- (c) Lack of exercise, sedentary nature of work.
- (d) Irregular bowel habits, rushing out for job.

Proper assessment of the causative factor in the patient and its correction leaves only a minority of cases to be treated by drugs.

Constipation may be spastic or atonic.

(i) *Spastic constipation* (irritable bowel): The stools are hard, rounded, stone like and difficult to pass. The first choice laxative is dietary fibre

or any of the bulk forming agents taken over weeks/months. Tegaserod is a new option available now. Stimulant purgatives are contraindicated.

(ii) *Atonic constipation* (sluggish bowel): mostly due to advanced age, debility or laxative abuse. Non-drug measures like plenty of fluids, exercise, regular habits and reassurance should be tried. In resistant cases a bulk forming agent should be prescribed. In case of poor compliance or if the patient is not satisfied—bisacodyl or senna may be given once or twice a week for as short a period as possible.

2. *Bedridden patients* (myocardial infarction, stroke, fractures, postoperative): bowel movement may be sluggish and constipation can be anticipated.

To prevent constipation: Give bulk forming agents on a regular schedule; docusates, lactulose and liquid paraffin are alternatives.

To treat constipation: Enema (soap-water/glycerine) is preferred; bisacodyl or senna may be used.

3. *To avoid straining at stools* (hernia, cardiovascular disease, eye surgery) and in perianal afflictions (piles, fissure, anal surgery) it is essential to keep the faeces soft. One should not hesitate to use adequate dose of a bulk forming agent, lactulose or docusates.

4. *Preparation of bowel for surgery, colonoscopy, abdominal X-ray* The bowel needs to be emptied of the contents including gas. Saline purgative, bisacodyl or senna may be used; castor oil only in exceptional circumstances.

5. *After certain anthelmintics* (especially for tapeworm) Saline purgative or senna may be used to flush out the worm and the anthelmintic drug.

Fixed dose combinations of an anthelmintic (other than piperazine) with a purgative is banned in India, as are laxatives with enzyme preparations.

6. *Food/drug poisoning* The idea is to drive out the unabsorbed irritant/poisonous material

from the intestines. Only saline purgatives are satisfactory.

The choice of a purgative depends on the latency of action and type of stools desired. This is given in Table 48.1.

Some combined preparations

AGAROL: Liquid paraffin 9.5 ml, phenolphthalein 400 mg, agar 60 mg per 30 ml emulsion.

CREMAFFIN: Milk of magnesia 11.25 ml, liq. paraffin 3.75 ml per 15 ml emulsion; **CREMAFFIN PINK** with phenolphthalein 50 mg per 15 ml.

JULAX: Bisacodyl 10 mg, casanthranol 10 mg dragees.

PURSENNID-IN (with DOS): Purified senna ext. (cal salt) 18 mg, docusates 50 mg tab.

Table 48.1: Type of stools and latency of action of purgatives employed in usually recommended doses

<i>Soft, formed faeces (take 1–3 days)</i>	<i>Semifluid stools (take 6–8 hrs)</i>	<i>Watery evacuation (within 1–3 hrs)</i>
Bulk forming	Phenolphthalein	Saline purgatives
Docusates	Bisacodyl	Castor oil
Liquid paraffin	Sod. picosulfate	
Lactulose	Senna	

Purgative abuse Some individuals are obsessed with using purgatives regularly. This may be the reflection of a psychological problem. Others use a purgative casually, obtain thorough bowel evacuation, and by the time the colon fills up for a proper motion (2–3 days) they get convinced that they are constipated and start taking the drug regularly. Chronic use of purgatives must be discouraged. Once the purgative habit forms, it is difficult to break. Dangers of purgative abuse are:

1. Flairing of intestinal pathology, rupture of inflamed appendix.
2. Fluid and electrolyte imbalance, especially hypokalaemia.
3. Steatorrhoea, malabsorption syndrome.
4. Protein losing enteropathy.
5. Spastic colitis.

TREATMENT OF DIARRHOEAS

Diarrhoea is too frequent, often too precipitate passage of poorly formed stools. In pathological

terms, it occurs due to passage of excess water in faeces.

Diarrhoeal diseases constitute a major cause of morbidity and mortality worldwide; especially in developing countries. More than 5 million children under the age of 5 years die every year due to diarrhoea. A nationwide study has estimated that diarrhoea kills > 1 million children in India annually. Recurrent or protracted diarrhoea is also a major cause of protein-calorie malnutrition in developing countries. Even mild diarrhoea, and that in adults, is a disabling symptom and an inconvenience.

Relevant pathophysiology

Water and electrolytes are absorbed as well as secreted in the intestine. Jejunum is freely permeable to salt and water which are passively absorbed secondary to nutrient (glucose, amino acids, etc.) absorption. In the ileum and colon active $\text{Na}^+\text{K}^+\text{ATPase}$ mediated salt absorption occurs, primarily in the mature cells lining the villous tips, water follows isoosmotically. In addition *glucose facilitated Na^+ absorption* takes place in the ileum by Na^+ -glucose cotransporter; one Na^+ ion is transported along with each molecule of glucose absorbed. This mechanism remains intact even in severe diarrhoeas.

Absorption of Cl^- and HCO_3^- is passive (paracellular) as well as by exchange of HCO_3^- for Cl^- (transcellular). Bicarbonate is absorbed also by the secretion of H^+ (similar to that in proximal tubule of kidney) and Na^+ accompanies it. K^+ is excreted in faecal water by exchange with Na^+ , as well as by secretion into mucus and in desquamated cells. The osmotic load of luminal contents plays an important role in determining final stool water volume. When nonabsorbable solutes are present and in disaccharidase deficiency (which occurs during starvation), the stool water is increased. Inhibition of $\text{Na}^+\text{K}^+\text{ATPase}$ and structural damage to mucosal cell (by Rota virus) causes diarrhoea by reducing absorption.

Intracellular cyclic nucleotides are important regulators of absorptive and secretory processes (Fig. 48.1). Stimuli enhancing cAMP or cGMP cause net loss of salt and water, both by inhibiting NaCl absorption in villous cells and by promoting anion secretion (Na^+ accompanies)

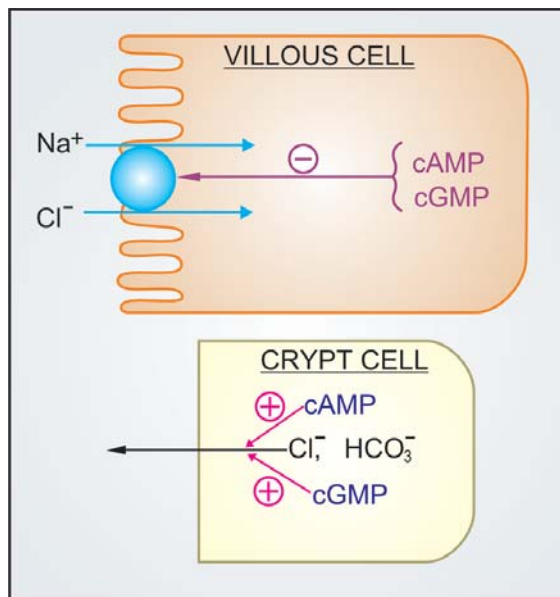

Fig. 48.1: Action of cyclic nucleotides on electrolyte transport of intestinal mucosal cells. In crypt cells cAMP plays the dominant role

in the crypt cells which are primarily secretory. Many bacterial toxins, e.g. cholera toxin, exotoxin elaborated by *Enterotoxigenic E. coli* (ETEC), *Staph. aureus*, *Salmonella*, etc. activate adenylyl cyclase which enhances secretion that reaches its peak after 3–4 hours and persists until the stimulated cells are shed in the normal turnover, i.e. 36 hours after a single exposure. Concurrent inhibition of absorption adds to the rate of salt and water loss. Prostaglandins (PGs) and intracellular Ca^{2+} also stimulate the secretory process. All acute enteric infections produce secretory diarrhoea. The heat stable toxin (ST) of ETEC, *Clostridium difficile* and *E. histolytica* cause accumulation of cGMP which also stimulates anion secretion (less potent than cAMP) and inhibits Na^+ absorption.

Diarrhoea associated with carcinoid (secreting 5-HT) and medullary carcinoma of thyroid (secreting calcitonin) is mediated by cAMP. Excess of bile acids also cause diarrhoea by activating adenylyl cyclase.

Traditionally, hypermotility of bowel has been ascribed a crucial role in diarrhoea. However,

changes in intestinal motility are now thought to be of secondary importance and may be due to fluid accumulation in the lumen. Decreased segmenting activity in the intestine may promote diarrhoea by allowing less time for the absorptive processes.

Principles of management

Rational management of diarrhoea depends on establishing the underlying cause and instituting specific therapy (only if necessary), since most diarrhoeas are self-limiting. Majority of enteropathogens are taken care of by motility and other defence mechanisms of the gut. Therapeutic measures may be grouped into:

- (a) Treatment of fluid depletion, shock and acidosis.
- (b) Maintenance of nutrition.
- (c) Drug therapy.

The relative importance of each is governed by the severity and nature of diarrhoea.

REHYDRATION

In majority of cases, this is the only measure needed. Rehydration can be done orally or i.v.

Intravenous rehydration It is needed only when fluid loss is severe i.e., > 10% body weight, (if not promptly corrected, it will lead to shock and death) or if patient is losing > 10 ml/kg/hr, or is unable to take enough oral fluids due to weakness, stupor or vomiting. The recommended composition of i.v. fluid (Dhaka fluid) is:

NaCl	85 mM = 5 g	}	in 1 L of water
KCl	13 mM = 1 g		
NaHCO ₃	48 mM = 4 g		
			or 5% glucose solution.

This provides 133 mM Na⁺, 13 mM K⁺, 98 mM Cl⁻ and 48 mM HCO₃⁻. Ringer lactate (Na⁺ 130, Cl⁻ 109, K⁺ 4, lactate 28 mM) recommended by WHO (1991) could be used alternatively.

Volume equivalent to 10% BW should be infused over 2–4 hours; the subsequent rate of infusion is matched with the rate of fluid loss. In most cases, oral rehydration can be instituted after the initial volume replacement.

Oral rehydration Advent of oral rehydration therapy (ORT) is considered a major advance of recent times. If the fluid loss is mild (5–7% BW) or moderate (7.5–10% BW) ORT can be instituted from the very beginning.

Rationale of ORS composition

Oral rehydration is possible if glucose is added with salt. It capitalizes on the intactness of glucose coupled Na⁺ absorption, even when other mechanisms have failed or when intestinal secretion is excessive—the secreted fluid lacks glucose and cannot be reabsorbed. The composition of oral rehydration salt/solution (ORS) has been debated. The general principles are:

- (a) It should be isotonic or somewhat hypotonic, i.e. total osmolarity 200–310 mOsm/L (diarrhoea fluids are approximately isotonic with plasma).
- (b) The molar ratio of glucose should be equal to or somewhat higher than Na⁺ (excess glucose will be utilized in absorbing Na⁺ present in the intestinal secretions in addition to that present in ORS itself), but not exceed 110 mM.
- (c) Enough K⁺ (15–25 mM) and bicarbonate/citrate (8–12 mM) should be provided to make up the losses in stool.

The WHO recommended a standard formula which provided Na⁺ 90 mM, K⁺ 20 mM, Cl⁻ 80 mM, citrate (base) 10 mM, glucose 110 mM and had a total osmolarity of 310 mOsm/L. Trisod. citrate was included in place of sod. bicarbonate because bicarbonate containing powder caked and developed a brown colour due to formation of furfural compounds with glucose: had a short shelf life.

It has been argued that the composition of ORS should be varied according to that of the diarrhoea stool. The average electrolyte composition (mM) of 3 important infective diarrhoea stools is:

	Na ⁺	Cl ⁻	K ⁺	HCO ₃ ⁻
1. Cholera:				
– infants, children	88	86	30	32
– adults	140	104	13	44
2. ETEC	53	24	37	18
3. Rotavirus	37	22	38	6

As can be seen, the standard WHO-ORS is based on the composition of cholera stools, particularly in children. When used in noncholera diarrhoea, this WHO-ORS occasionally produces periorbital edema due to excess Na^+ absorption. Based also on the Na^+ content of ETEC stools, many pediatricians have favoured 60 mM Na^+ and 90 mM glucose ORS for non-cholera diarrhoeas.

New formula WHO-ORS In 2002 a new formula low Na^+ low glucose ORS has been released by the WHO. Over the past 20 years WHO sponsored studies were carried out in several developing countries among children and adults suffering from diarrhoeas. It was found that maximum water absorption occurs from a slightly hypotonic solution and when glucose concentration is between 60–110 mM. At higher concentrations, glucose appears in the stools and takes its osmotic penalty—stool volume is increased. Recent studies showed that efficacy of ORS in children with acute noncholera diarrhoea is improved by reducing Na^+ and glucose concentration to 75 mM, and total osmolarity to 245 mOsm/L. The need for supplemental i.v. therapy was reduced by 33%. A combined analysis of studies with low osmolarity ORS has revealed that stool volume is reduced by 20% and incidence of vomiting by 30%. The new formula ORS has proven as effective and as safe in cholera as well, both in children and in adults, but there is some risk of hyponatremia in adults with cholera.

The WHO and UNICEF have recommended replacement of standard (310 mOsm/L) ORS formula by the new (245 mOsm/L).

New formula WHO-ORS			
Content		Concentrations	
NaCl	: 2.6 g	Na^+	— 75 mM
KCl	: 1.5 g	K^+	— 20 mM
Trisod. citrate	: 2.9 g	Cl^-	— 65 mM
Glucose	: 13.5 g	Citrate	— 10 mM
Water	: 1 L	Glucose	— 75 mM
Total osmolarity 245 mOsm/L			

(available as ORETRAL-A, ELECTROBION, ELECTRAL 21 g sachet for 1000 ml; WALYTE, RELYTE 4.2 g sachet for 200 ml).

Potassium is an important constituent of ORS, since in most acute diarrhoeas K^+ loss is

substantial. The base (bicarbonate, citrate, lactate) is added to correct acidosis due to alkali loss in stools. It may independently promote Na^+ and water absorption. However, relying on the ability of the kidney to restore acid-base balance, acidotic states have been managed without an exogenous base. Base free ORS has been found to be equally effective in rehydrating, though correction of acidosis is slower. Thus, there is a trend to consider base as a nonessential constituent of ORS, but if present it may be beneficial, especially in severe cases with overt acidosis.

Administration of ORT Patients are encouraged to drink ORS at $\frac{1}{2}$ –1 hourly intervals, initially 5–7.5% BW volume equivalent is given in 2–4 hours (5 ml/kg/hr in children). Thirst due to volume depletion provides an adequate driving force. Subsequently it may be left to demand, but should at least cover the rate of loss in stools. In a weak child who refuses to drink ORS at the desired rate—it can be given by intragastric drip; restoring hydration in 6 hours should be aimed.

ORT is not designed to stop diarrhoea, but to restore and maintain hydration, electrolyte and pH balance until diarrhoea ceases, mostly spontaneously. It is the best and not a second choice approach to i.v. hydration. About 300 million litre of ORS is being used annually, and is estimated to be preventing 0.5 million child deaths worldwide.

Non-diarrhoeal uses of ORT

- Postsurgical, postburn and post-trauma maintenance of hydration and nutrition (in place of i.v. infusion).
- Heat stroke.
- During changeover from parenteral to enteral elimination.

Super ORS This is a solution which in addition to rehydrating may lead to decrease in purging rates and improvement in diarrhoea by enhanced absorption. Improvement in ORS by adding certain actively transported amino acids (alanine, glycine which cotransport Na^+) has been tried. Their efficacy is marginal, and not extended to noncholera diarrhoea; cost-effectiveness may not be favourable. There is compelling evidence, however, that a complex substrate like boiled rice powder 40–50 g/L is an efficient substitute for glucose. The rice starch is slowly hydrolysed at the brush border or in the lumen into glucose

which is absorbed: does not cause osmotic diarrhoea even when larger quantity is added: more calories can be administered. Rice has 7% protein: yields amino acids which may themselves stimulate salt and water absorption. It has been found to reduce stool volume compared to WHO-ORS in cholera patients. Moreover, rice is cheap and widely available. Thus, rice (or wheat, maize, potato) based ORS appears to be suitable for developing countries.

MAINTENANCE OF NUTRITION

Contrary to traditional view, patients of diarrhoea should not be starved. Fasting decreases brush border disaccharidase enzymes and reduces absorption of salt, water and nutrients; may lead to malnutrition if diarrhoea is prolonged or recurrent. Feeding during diarrhoea has been shown to increase intestinal digestive enzymes and cell proliferation in mucosa. Simple foods like breast milk or ½ strength buffalo milk, boiled potato, rice, chicken soup, banana, sago, etc. should be given as soon as the patient can eat.

DRUG THERAPY

It consists of:

- (i) Specific antimicrobial drugs.
- (ii) Nonspecific antidiarrhoeal drugs.

ANTIMICROBIALS

One or more antimicrobial agent is almost routinely prescribed to every patient of diarrhoea. However, such drugs have a limited role in the overall treatment of diarrhoeal patients; the reasons are:

- (i) Bacterial pathogen is responsible for only a fraction of cases.
- (ii) Even in bacterial diarrhoea, antimicrobials alter the course of illness only in selected cases.
- (iii) Antimicrobials may prolong the carrier state.

Diarrhoea patients can generally be placed in one of the two categories:

(a) Abundant watery diarrhoea lacking mucus or blood, usually dehydrating with frequent vomiting, but little or no fever—are generally

caused by adhesive but noninvasive enterotoxigenic bacteria such as cholera, ETEC, *Salmonella enteritidis* or by rota virus and other viruses which stimulate massive secretion by activating cAMP: ORS and not antimicrobials are the main therapy.

(b) Slightly loose, smaller volume stools, frequently with mucus and/or blood, mild dehydration, usually attended with fever and abdominal pain, but not vomiting—are indications of mucosal invasion, generally caused by enteroinvasive organisms like *Shigella*, enteropathogenic *E. coli* (EPEC), *Campy. jejuni*, *Salmonella typhimurium*, *Yersinia enterocolitica*, *E. histolytica*, *Clostri. difficile*; antimicrobials are needed in many of these.

A. Antimicrobials are of no value In diarrhoea due to *noninfective causes*, such as:

- (i) Irritable bowel syndrome (IBS)
- (ii) Coeliac disease
- (iii) Pancreatic enzyme deficiency
- (iv) Tropical sprue (except when there is secondary infection)
- (v) Thyrotoxicosis.

Rotavirus is an important pathogen of acute diarrhoea, especially in children in developed countries. It along with other diarrhoea causing viruses, is not amenable to chemotherapy.

Salmonella food poisoning is generally a self-limiting disease. Antibiotics have been widely used, but may be harmful rather than beneficial—treated patients pass organisms in stool for longer periods than untreated patients. However, very severe illness or that in infants, elderly or immunocompromized patients may be treated with ciprofloxacin/azithromycin/i.v. ceftriaxone.

B. Antimicrobials are useful only in severe disease (but not in mild cases):

(i) Travellers' diarrhoea: mostly due to ETEC, *Campylobacter* or virus: cotrimoxazole, norfloxacin, doxycycline and erythromycin reduce the duration and total fluid needed only in severe cases.

(ii) *EPEC*: is less common, but causes *Shigella*-like invasive illness. Cotrimoxazole, colistin, nalidixic acid or norfloxacin may be used in acute cases and in infants. Efficacy of ampicillin has declined due to development of resistance.

(iii) *Shigella* enteritis: only when associated with blood and mucus in stools may be treated with ciprofloxacin, norfloxacin or nalidixic acid; cotrimoxazole and ampicillin are alternatives, but many strains are resistant to these.

(iv) *Salmonella typhimurium* enteritis is often invasive; severe cases may be treated with a fluoroquinolone, cotrimoxazole or ampicillin.

(v) *Yersinia enterocolitica*: common in colder places, not in tropics. Cotrimoxazole is the most suitable drug in severe cases; ciprofloxacin is an alternative.

C. Antimicrobials are regularly useful in:

(i) Cholera: Though not life saving, tetracyclines reduce stool volume to nearly $\frac{1}{2}$. Cotrimoxazole is an alternative, especially in children. Lately, multidrug resistant cholera strains have arisen: can be treated with norfloxacin/ciprofloxacin. Ampicillin and erythromycin are also effective.

(ii) *Campylobacter jejuni*: Norfloxacin and other fluoroquinolones eradicate the organism from the stools and control diarrhoea. Erythromycin is fairly effective and is the preferred drug in children.

(iii) *Clostridium difficile*: produces antibiotic associated pseudomembranous enterocolitis. The drug of choice for it is metronidazole, while vancomycin given orally is an alternative. Offending antibiotic must be stopped.

(iv) Diarrhoea associated with bacterial growth in blind loops/diverticulitis may be treated with tetracycline or metronidazole.

(v) Amoebiasis } metronidazole, diloxanide furoate,
(vi) Giardiasis } are effective drugs (see Ch. 60).

NONSPECIFIC ANTIDIARRHOEAL AGENTS

These are classified and their uses listed in Table 48.2.

1. Absorbants These are colloidal bulk forming substances which absorb water and swell. They modify the consistency and frequency of stools and give an impression of improvement, but do not reduce the water and electrolyte loss. They are of value in selected conditions (Table 48.2). Ispaghula and other bulk forming colloids are useful in both constipation and diarrhoea phases of IBS and reduce abdominal pain as well.

2. Antisecretory drugs

Sulfasalazine (Salicylazosulfapyridine) It is a compound of 5-aminosalicylic acid (5-ASA) with sulfapyridine linked through an azo bond that has a specific therapeutic effect in inflammatory bowel diseases (IBDs) like ulcerative colitis and Crohn's disease.

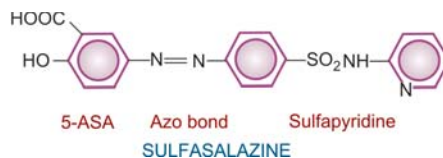

Having low solubility, it is poorly absorbed from the ileum. The azo bond is split by colonic bacteria to release 5-ASA and sulfapyridine. The former exerts a local antiinflammatory effect, the mechanism of which is not clear. Though it inhibits both COX and LOX, decreased PG and LT production appears to play a minor role in the therapeutic effect. Inhibition of cytokine, PAF, TNF α and nuclear transcription factor (NF κ B) generation seems to be more important. Migration of inflammatory cells into bowel wall is interfered and mucosal secretion is reduced—affords considerable relief in ulcerative colitis and related inflammatory bowel diseases. Given during an exacerbation it reduces number of stools, abdominal cramps and fever, but is less effective than corticosteroids; may be employed for mild to moderate exacerbation. A dose of 3–4 g/day induces remission over a few weeks in many cases, but relapses are common after stoppage. Maintenance therapy with 1.5–2 g/day has been found to postpone relapse as long as taken. The primary value of sulfasalazine is in maintaining remission, while corticosteroids are reserved to treat acute exacerbations.

The beneficial effect of sulfasalazine is clearly not due to any antibacterial action (bowel flora

Table 48.2: Nonspecific antidiarrhoeal agents and their indications

Class	Drug	Use
ABSORBANTS	Ispaghula	Irritable bowel syndrome (IBS), Ileostomy/colostomy diarrhoea
	Psyllium	
	Methyl cellulose	
ANTISECRETORY	Sulfasalazine	Ulcerative colitis, Other inflammatory bowel diseases (IBD)
	Mesalazine	
	Bismuth subsalicylate	Travellers' diarrhoea
	Atropine	Nervous, drug induced diarrhoea
	Octreotide	Carcinoid, VIP secreting tumour, diarrhoea in AIDS
	Racecadotril	Acute secretory diarrhoeas
ANTIMOTILITY (Opioids) (also antisecretory)	Codeine	Noninfective or mild travellers' diarrhoea; Idiopathic diarrhoea in AIDS, After anal surgery, colostomy.
	Diphenoxylate-atropine	
	Loperamide	

remains largely unaffected): sulfapyridine moiety only serves to carry 5-ASA to the colon without being absorbed proximally. However, part of the released sulfapyridine is absorbed in the colon and is responsible for adverse effects like rashes, fever, joint pain, haemolysis and blood dyscrasias. Nausea, vomiting, headache, malaise and anaemia are other frequent side effects. Upto 1/3rd patients suffer intolerable adverse effects. Oligozoospermia and male infertility is reported. Sulfasalazine interferes with folate absorption; folic acid supplementation should be given during its use.

Sulfasalazine has also been used as a disease modifying drug in rheumatoid arthritis: the absorbed sulfapyridine appears to be responsible for the therapeutic effect (*see p. 203*).

SALAZOPYRIN, SAZO-EN 0.5 g tab.

Mesalazine (Mesalamine) These are the official names given to 5-ASA. Realizing that 5-ASA is the active moiety in ulcerative colitis, but is not effective orally because of inability to reach the large bowel (it is absorbed in the small intestine), it has been formulated as delayed release preparations by coating with acrylic polymer. The pattern of release over the length of jejunum, ileum and colon differs among the different formulations, but most of them do effectively deliver 5-ASA to the distal small bowel and colon. A daily dose of 2.4 g has been found to improve over 50% patients of ulcerative

colitis (upto 80% mild-to-moderate cases). Less than half of the 5-ASA released from these preparations is absorbed, acetylated in the liver and excreted in urine. Like sulfasalazine, the primary use of mesalazine is in preventing relapses, though it may also be employed to treat mild-to-moderate exacerbations.

MESACOL, TIDOCOL 400 mg tab, **ETISA** 500 mg sachet.

Adverse effects Coated mesalazine is better tolerated than sulfasalazine. Side effects noted are nausea, diarrhoea, abdominal pain and headache, but are mild and less frequent. Rashes and hypersensitivity reactions are rare. Bone marrow depression and decreased sperm count has not occurred. Mesalazine has nephrotoxic potential, because 30–40% of 5-ASA is released in the ileum and is absorbed. It is contraindicated in renal and hepatic impairment.

Drug interactions Coated mesalazine may enhance the gastric toxicity of glucocorticoids and hypoglycaemic action of sulfonylureas. Interaction with coumarins, furosemide, spironolactone, methotrexate and rifampicin are possible.

5-ASA enemas Another mode of delivery of 5-ASA to colon is to administer it by a retention enema: 1–2 g enema once or twice daily is effective in distal ulcerative colitis, including some refractory cases.

MESACOL ENEMA 4 g/60 ml.

Olsalazine It consists of two molecules of 5-ASA coupled together by azo bond. It is poorly absorbed in the ileum, the

azo bond is split in the colon to provide 5-ASA locally. No separate carrier moiety is needed. Olsalazine is probably the most reliable preparation for delivery of 5-ASA to the colon. However, it often aggravates diarrhoea initially by decreasing transit time through the bowels.

Balsalazine This is 5-ASA linked to 4-aminobenzoyl- β -alanine as the carrier. The 5-ASA is released in the colon and the carrier is poorly absorbed.

Corticosteroids Prednisolone (40 mg/day) or equivalent are highly effective in controlling symptoms/inducing remission in both ulcerative colitis and Crohn's disease. They are the drugs of choice for moderately severe exacerbations. Hydrocortisone enema, or foam (**ENTOFOAM 10%**) can be used for topical treatment of proctitis and distal ulcerative colitis. Corticosteroids are generally discontinued after remission is induced, and mesalazine started during steroid therapy is continued to prevent relapses.

A sizeable percentage of severe IBD patients either relapse on stoppage of the steroid (steroid-dependent) or do not respond to it (steroid-resistant). Increasing use of specific immunosuppressant drugs is now being made in such IBD patients, particularly to avoid long-term steroid therapy which carries hazards.

Immunosuppressants (see Ch. 63)

Azathioprine is the most commonly used immunosuppressant in IBD. Though the response is delayed—occurring after weeks or months, it has lower toxicity. Azathioprine is used for moderate-to-severe Crohn's disease as well as ulcerative colitis, especially as a steroid sparing drug or in steroid resistant cases. It has good remission maintaining property.

Methotrexate is also effective in IBD and acts faster, but higher doses are needed than for rheumatoid arthritis. In IBD, efficacy by oral route is lower. Thus, it has a limited role in severe Crohn's disease only.

Cyclosporine can be used to maintain remission in both Crohn's as well as ulcerative colitis, but is not a first line immunosuppressant because of renal toxicity, and poor oral efficacy in IBD.

Infliximab: This chimeric anti-TNF α immunoglobulin has shown promising effect in IBD and is being increasingly used for severe uncontrolled cases.

Bismuth subsalicylate Taken as suspension (60 ml 6 hourly) it is thought to act by decreasing PG synthesis in the intestinal mucosa, thereby reducing Cl⁻ secretion. It has some prophylactic value in travellers' diarrhoea; (probably

due to weak antibacterial action also), but it is rather inconvenient to carry and take.

Anticholinergics Atropinic drugs can reduce bowel motility and secretion, but have poor efficacy in secretory diarrhoeas. They may benefit nervous/drug (neostigmine, metoclopramide, reserpine) induced diarrhoeas and provide some symptomatic relief in dysenteries, diverticulitis.

Octreotide This somatostatin analogue (see p. 235) has a long plasma t $\frac{1}{2}$ (90 min) as well as potent antisecretory/antimotility action on the gut. It has been used to control diarrhoea in carcinoid and vasoactive intestinal peptide (VIP) secreting tumours, and for refractory diarrhoea in AIDS patients, but needs to be given by s.c. injection.

Opioids In addition to their well recognized antimotility action, opioids reduce intestinal secretion. Loperamide has been clearly shown to reduce secretion, probably through specific opioid receptors, but does not affect mucosal cAMP or cGMP levels.

Racecadotril This recently introduced pro-drug is rapidly converted to *thiorphan*, an enkephalinase inhibitor. It prevents degradation of endogenous enkephalins (ENKs) which are mainly δ opioid receptor agonists. Racecadotril decreases intestinal hypersecretion, without affecting motility, by lowering mucosal cAMP due to enhanced ENK action. It is indicated in the short-term treatment of acute secretory diarrhoeas. In contrast to loperamide/diphenoxylate, it is not contraindicated in children. The elimination t $\frac{1}{2}$ as thiorphan is 3 hr. Side effects are nausea, vomiting, drowsiness, flatulence.

Dose: 100 mg (children 1.5 mg/kg) TDS for not more than 7 days.

CADOTRIL, RACIGYL 100 mg cap, 15 mg sachet; REDOTIL 100 mg cap.

3. Antimotility drugs

These are opioid drugs which increase small bowel tone and segmenting activity, reduce propulsive movements and diminish intestinal secretions while enhancing absorption. The major action appears to be mediated through μ opioid receptors located on enteric neuronal network, but direct action on intestinal smooth muscle and secretory/absorptive epithelium has also been demonstrated. The δ receptors are believed to promote absorption and inhibit secretion, while the μ receptors enhance

absorption and decrease propulsive movements. Overall they increase resistance to luminal transit and allow more time for the absorptive processes. No tolerance develops to their constipating action.

Codeine (*see* p. 214, 458) This opium alkaloid has prominent constipating action at a dose of 60 mg TDS. The antidiarrhoeal effect is attributed primarily to its peripheral action on small intestine and colon. It does have central effects, but dependence producing liability is low. Side effects are nausea, vomiting and dizziness. It should be used only for short periods and with caution in children.

Diphenoxylate (2.5 mg) + *atropine* (0.025 mg): LOMOTIL tab and in 5 ml liquid.

Dose: 5–10 mg, followed by 2.5–5 mg 6 hourly.

It is a synthetic opioid, chemically related to pethidine; used exclusively as constipating agent; action is similar to codeine. The antidiarrhoeal action is most prominent, but because it is absorbed systemically and crosses blood-brain barrier—CNS effects do occur. Atropine is added in subpharmacological dose to discourage abuse by taking several tablets. Abuse liability is rated low, and overdose will produce disturbing atropinic side effects. It has caused respiratory depression, paralytic ileus and toxic megacolon in children. Response is more variable in them—contraindicated below 6 years of age.

Loperamide It is an opiate analogue with major peripheral μ opioid and additional weak anticholinergic property. As a constipating agent it is much more potent than codeine. Because of poor water solubility—little is absorbed from the intestines. Entry into brain is negligible—CNS effects are rare and occur only with high doses; no abuse liability. The duration of action is longer (12 hr) than codeine and diphenoxylate.

In addition to its opiate like action on motility, loperamide also inhibits secretion: directly interacts with calmodulin—this may be responsible for the antidiarrhoeal action. It

improves faecal continence by enhancing anal sphincter tone.

Adverse effects: Abdominal cramps and rashes are the most common side effects. Paralytic ileus, toxic megacolon with abdominal distension is a serious complication in young children—fatalities have occurred, probably due to absorption of toxins from the intestines: contraindicated in children < 4 yr. Loperamide appears to be the most effective and most suitable of the antimotility drugs.

Dose: 4 mg followed by 2 mg after each motion (max. 10 mg in a day); 2 mg BD for chronic diarrhoea.

IMODIUM, LOPESTAL, DIARLOP: 2 mg tab, cap. Liquid formulation has been withdrawn.

The utility of antimotility drugs in diarrhoea is limited to noninfective diarrhoea, mild traveller's diarrhoea, and when diarrhoea is exhausting or idiopathic diarrhoea in AIDS patients. Their use is a short-term measure only.

Antimotility drugs are contraindicated in acute infective diarrhoeas because they delay clearance of the pathogen from the intestine. If invasive organisms (*Shigella*, EPEC, EH, etc.) are present, antimotility drugs can be disastrous. They are contraindicated in irritable bowel syndrome, ulcerative colitis and diverticulosis because they increase intraluminal pressure.

Antimotility drugs can be used to induce deliberate short-term constipation, e.g. after anal surgery, and to reduce the volume, fluidity and bag cleaning frequency in ileostomy/colostomy patients.

NOTE: Drugs Controller General of India has banned the following category of antidiarrhoeal drugs:

1. Containing adsorbants like Kaolin, pectin, attapulgit, activated charcoal, etc.
2. Containing phthalylsulfathiazole, succinylsulfathiazole, sulfaguanidine, neomycin, streptomycin, dihydrostreptomycin.
3. For pediatric use containing diphenoxylate, loperamide, atropine, belladonna, hyosciamine, halogenated hydroxyquinolines.
4. Fixed dose combinations of antidiarrhoeals with electrolytes.
5. Fixed dose combination of loperamide with furazolidone.
6. Fixed dose combination of antidiarrhoeals with antihistaminics.

Antimicrobial Drugs

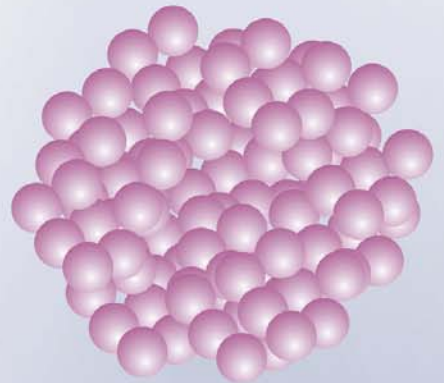
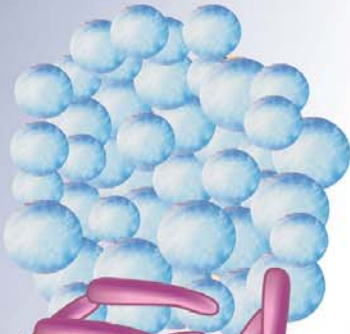
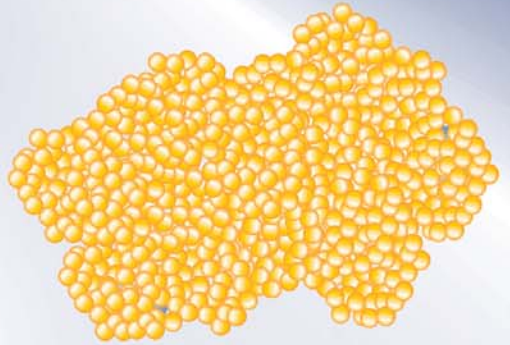
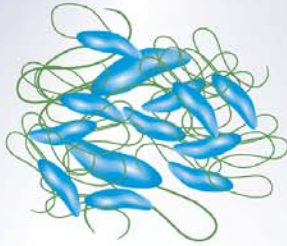
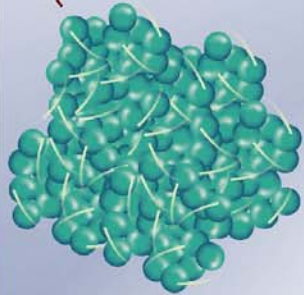
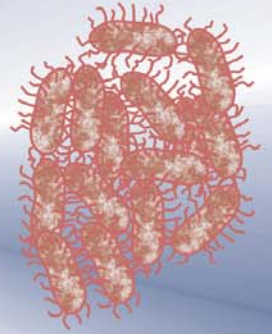
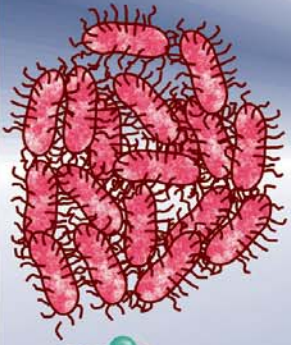

SECTION
12



CHAPTER 49

Antimicrobial Drugs: General Considerations

Antimicrobial drugs are the greatest contribution of the 20th century to therapeutics. Their advent changed the outlook of the physician about the power drugs can have on diseases. They are one of the few curative drugs. Their importance is magnified in the developing countries, where infective diseases predominate. As a class, they are one of the most frequently used as well as misused drugs.

Drugs in this class differ from all others in that they are designed to inhibit/kill the infecting organism and to have no/minimal effect on the recipient. This type of therapy is generally called *chemotherapy* which has come to mean 'treatment of systemic infections with specific drugs that selectively suppress the infecting microorganism without significantly affecting the host.' The basis of selective microbial toxicity is the action of the drug on a component of the microbe (e.g. bacterial cell wall) or metabolic processes (e.g. folate synthesis) that is not found in the host, or high affinity for certain microbial biomolecules (e.g. trimethoprim for bacterial dihydrofolate reductase). Due to analogy between the malignant cell and the pathogenic microbes, treatment of neoplastic diseases with drugs is also called 'chemotherapy'.

Antibiotics These are substances produced by microorganisms, which selectively suppress the

growth of or kill other microorganisms at very low concentrations. This definition excludes other natural substances which also inhibit microorganisms but are produced by higher forms (e.g. antibodies) or even those produced by microbes but are needed in high concentrations (ethanol, lactic acid, H_2O_2).

Initially the term 'chemotherapeutic agent' was restricted to synthetic compounds, but now since many antibiotics and their analogues have been synthesized, this criterion has become irrelevant; both synthetic and microbiologically produced drugs need to be included together. It would be more meaningful to use the term *Antimicrobial agent (AMA)* to designate synthetic as well as naturally obtained drugs that attenuate microorganisms.

The *history* of chemotherapy may be divided into 3 phases.

(a) The period of empirical use: of 'mouldy curd' by Chinese on boils, chaulmoogra oil by the Hindus in leprosy, chenopodium by Aztecs for intestinal worms, mercury by Paracelsus (16th century) for syphilis, cinchona bark (17th century) for fevers.

(b) Ehrlich's phase of dyes and organometallic compounds (1890–1935): With the discovery of microbes in the later half of 19th century and that they are the cause of many diseases; Ehrlich toyed with the idea that if certain dyes could selectively stain microbes, they could also be selectively toxic to these organisms. He tried methylene

blue, trypan red, etc. He developed the arsenicals—*atoxyl* for sleeping sickness, *arsphenamine* in 1906 and nearsphenamine in 1909 for syphilis. He coined the term ‘chemotherapy’ because he used drugs of known chemical structure (that of most other drugs in use at that time was not known) and showed that selective attenuation of infecting parasite was a practical proposition.

(c) The modern era of chemotherapy was ushered by Domagk in 1935 by demonstrating the therapeutic effect of *Prontosil*, a sulfonamide dye, in pyogenic infection. It was soon realized that the active moiety was paraamino benzene sulfonamide, and the dye part was not essential. Sulfapyridine (M & B 693) was the first sulfonamide to be marketed in 1938.

The phenomenon of *antibiosis* was demonstrated by Pasteur in 1877: growth of anthrax bacilli in urine was inhibited by air-borne bacteria. Fleming (1929) found that a diffusible substance was elaborated by *Penicillium* mould which could destroy *Staphylococcus* on the culture plate. He named this substance *penicillin* but could not purify it. Chain and Florey followed up this observation in 1939 which culminated in the clinical use of penicillin in 1941. Because of the great potential of this discovery in treating war wounds, commercial manufacture of penicillin soon started.

In the 1940s, Waksman and his colleagues undertook a systematic search of Actinomycetes as source of antibiotics and discovered *streptomycin* in 1944. This group of soil microbes proved to be a treasure-house of antibiotics and soon tetracyclines, chloramphenicol, erythromycin and many others followed. All three groups of scientists, Domagk, Fleming-Chain-Florey and Waksman received the Nobel Prize for their discoveries.

In the past 40 years emphasis has shifted from searching new antibiotic producing organisms to developing semisynthetic derivatives of older antibiotics with more desirable properties or differing spectrum of activity. Few novel synthetic AMAs, e.g. fluoroquinolones, oxazolidinones have also been produced.

CLASSIFICATION

Antimicrobial drugs can be classified in many ways:

A. Chemical structure

1. **Sulfonamides and related drugs:** Sulfadiazine and others, Sulfones—Dapsone (DDS), Paraaminosalicylic acid (PAS).
2. **Diaminopyrimidines:** Trimethoprim, Pyrimethamine.
3. **Quinolones:** Nalidixic acid, Norfloxacin, Ciprofloxacin, Gatifloxacin, etc.

4. **β -Lactam antibiotics:** Penicillins, Cephalosporins, Monobactams, Carbapenems.
5. **Tetracyclines:** Oxytetracycline, Doxycycline, etc.
6. **Nitrobenzene derivative:** Chloramphenicol.
7. **Aminoglycosides:** Streptomycin, Gentamicin, Amikacin, Neomycin, etc.
8. **Macrolide antibiotics:** Erythromycin, Clarithromycin, Azithromycin, etc.
9. **Lincosamide antibiotics:** Lincomycin, Clindamycin.
10. **Glycopeptide antibiotics:** Vancomycin, Teicoplanin.
11. **Oxazolidinone:** Linezolid.
12. **Polypeptide antibiotics:** Polymyxin-B, Colistin, Bacitracin, Tyrothricin.
13. **Nitrofurans derivatives:** Nitrofurantoin, Furozolidone.
14. **Nitroimidazoles:** Metronidazole, Tinidazole, etc.
15. **Nicotinic acid derivatives:** Isoniazid, Pyrazinamide, Ethionamide.
16. **Polyene antibiotics:** Nystatin, Amphotericin-B, Hamycin.
17. **Azole derivatives:** Miconazole, Clotrimazole, Ketoconazole, Fluconazole.
18. **Others:** Rifampin, Spectinomycin, Sulfisidate, Cycloserine, Viomycin, Ethambutol, Thiacetazone, Clofazimine, Griseofulvin.

B. Mechanism of action

1. **Inhibit cell wall synthesis:** Penicillins, Cephalosporins, Cycloserine, Vancomycin, Bacitracin.
2. **Cause leakage from cell membranes:** Polypeptides—Polymyxins, Colistin, Bacitracin. Polyenes—Amphotericin B, Nystatin, Hamycin.
3. **Inhibit protein synthesis:** Tetracyclines, Chloramphenicol, Erythromycin, Clindamycin, Linezolid.
4. **Cause misreading of m-RNA code and affect permeability:** Aminoglycosides—Streptomycin, Gentamicin, etc.

5. *Inhibit DNA gyrase*: Fluoroquinolones—Ciprofloxacin and others.
6. *Interfere with DNA function*: Rifampin, Metronidazole.
7. *Interfere with DNA synthesis*: Acyclovir, Zidovudine.
8. *Interfere with intermediary metabolism*: Sulfonamides, Sulfones, PAS, Trimethoprim, Pyrimethamine, Ethambutol.

C. Type of organisms against which primarily active

1. *Antibacterial*: Penicillins, Aminoglycosides, Erythromycin, etc.
2. *Antifungal*: Griseofulvin, Amphotericin B, Ketoconazole, etc.
3. *Antiviral*: Acyclovir, Amantadine, Zidovudine, etc.
4. *Antiprotozoal*: Chloroquine, Pyrimethamine, Metronidazole, Diloxanide, etc.
5. *Anthelmintic*: Mebendazole, Pyrantel, Niclosamide, Diethyl carbamazine, etc.

D. Spectrum of activity

<i>Narrow-spectrum</i>	<i>Broad-spectrum</i>
Penicillin G	Tetracyclines
Streptomycin	Chloramphenicol
Erythromycin	

The initial distinction between narrow and broad-spectrum antibiotics is no longer clearcut. Drugs with all ranges of intermediate band width, e.g. extended spectrum penicillins, newer cephalosporins, aminoglycosides, fluoroquinolones are now available. However, the terms 'narrow-spectrum' and 'broad-spectrum' are still applied.

E. Type of action

Primarily bacteriostatic

Sulfonamides	Erythromycin
Tetracyclines	Ethambutol
Chloramphenicol	Clindamycin
	Linezolid

Primarily bactericidal

Penicillins	Cephalosporins
Aminoglycosides	Vancomycin
Polypeptides	Nalidixic acid
Rifampin	Ciprofloxacin
Isoniazid	Metronidazole
Pyrazinamide	Cotrimoxazole

Some primarily static drugs may become cidal at higher concentrations (as attained in the urinary tract), e.g. sulfonamides, erythromycin, nitrofurantoin. On the other hand, some cidal drugs, e.g. cotrimoxazole, streptomycin may only be static under certain circumstances.

F. Antibiotics are obtained from:

Fungi

Penicillin	Griseofulvin
Cephalosporin	

Bacteria

Polymyxin B	Tyrothricin
Colistin	Aztreonam
Bacitracin	

Actinomycetes

Aminoglycosides	Macrolides
Tetracyclines	Polyenes
Chloramphenicol	

PROBLEMS THAT ARISE WITH THE USE OF AMAs

1. Toxicity

(a) *Local irritancy*: This is exerted at the site of administration. Gastric irritation, pain and abscess formation at the site of i.m. injection, thrombophlebitis of the injected vein are the complications. Practically all AMAs, especially erythromycin, tetracyclines, certain cephalosporins and chloramphenicol are irritants.

(b) *Systemic toxicity*: Almost all AMAs produce dose related and predictable organ toxicities. Characteristic toxicities are exhibited by different AMAs.

Some have a *high therapeutic index*—doses up to 100-fold range may be given without apparent damage to host cells. These include penicillins, some cephalosporins and erythromycin.

Others have a *lower therapeutic index*—doses have to be individualized and toxicity watched for, e.g.:

Aminoglycosides	: 8th cranial nerve and kidney toxicity.
Tetracyclines	: liver and kidney damage, antianabolic effect.
Chloramphenicol	: bone marrow depression.

Still others have a *very low therapeutic index*—use is highly restricted to conditions where no suitable alternative is available, e.g.:

Polymyxin B	: neurological and renal toxicity.
Vancomycin	: hearing loss, kidney damage.
Amphotericin B	: kidney, bone marrow and neurological toxicity.

2. Hypersensitivity reactions

Practically all AMAs are capable of causing hypersensitivity reactions. These are unpredictable and unrelated to dose. The whole range of reactions from rashes to anaphylactic shock can be produced. The more commonly involved AMAs are—penicillins, cephalosporins, sulfonamides, fluoroquinolones.

3. Drug resistance

It refers to unresponsiveness of a microorganism to an AMA, and is akin to the phenomenon of tolerance seen in higher organisms.

Natural resistance Some microbes have always been resistant to certain AMAs. They lack the metabolic process or the target site which is affected by the particular drug. This is generally a group or species characteristic, e.g. gram-negative bacilli are normally unaffected by penicillin G, or *M. tuberculosis* is insensitive to tetracyclines.

This type of resistance does not pose a significant clinical problem.

Acquired resistance It is the development of resistance by an organism (which was sensitive before) due to the use of an AMA over a period of time. This can happen with any microbe and is a major clinical problem. However, development of resistance is dependent on the microorganism as well as the drug. Some bacteria are notorious for rapid acquisition of resistance, e.g. staphylococci, coliforms, tubercle bacilli. Others like *Strep. pyogenes* and spirochetes have not developed significant resistance to penicillin despite its widespread use for > 50 years. Gonococci quickly developed resistance to sulfonamides, but only slowly and low-grade resistance to penicillin. However, in the past 30 years, highly penicillin resistant gonococci producing penicillinase have appeared.

Resistance may be developed by mutation or gene transfer.

Mutation It is a stable and heritable genetic change that occurs spontaneously and randomly among microorganisms. It is not induced by the AMA. Any sensitive population of a microbe contains a few mutant cells which require higher concentration of the AMA for inhibition. These are selectively preserved and get a chance to proliferate when the sensitive cells are eliminated by the AMA. Thus, in time it would appear that a sensitive strain has been replaced by a resistant one, e.g. when a single antitubercular drug is used. Mutation and resistance may be:

(i) **Single step:** A single gene mutation may confer high degree of resistance; emerges rapidly, e.g. enterococci to streptomycin, *E. coli* and *Staphylococci* to rifampin.

(ii) **Multistep:** A number of gene modifications are involved; sensitivity decreases gradually in a stepwise manner. Resistance to erythromycin, tetracyclines and chloramphenicol is developed by many organisms in this manner.

Sometimes mutational acquisition of resistance is accompanied by decrease in virulence, e.g. certain rifampin-resistant staphylococci and low grade penicillin-resistant gonococci have decreased virulence.

Gene transfer (infectious resistance) from one organism to another can occur by:

(i) **Conjugation** Sexual contact through the formation of a bridge or sex pilus is common among gram-negative bacilli of the same or another species. This may involve chromosomal or extrachromosomal (plasmid) DNA. The gene carrying the 'resistance' or 'R' factor is transferred only if another 'resistance transfer factor' (RTF) is also present. Conjugation frequently occurs in the colon where a large variety of gram-negative bacilli come in close contact. Even nonpathogenic organisms may transfer R factor to pathogenic organisms, which may become widespread by contamination of food or water. Chloramphenicol resistance of typhoid bacilli, streptomycin resistance of *E. coli*, penicillin resistance of *Haemophilus* and gonococci and many others have been traced to this mechanism. Concomitant acquisition of multidrug resistance has occurred by conjugation. Thus, this is a very important mechanism of horizontal transmission of resistance.

(ii) **Transduction** It is the transfer of gene carrying resistance through the agency of a bacteriophage. The R factor is taken up by the phage and delivered to another bacterium which it infects. Many *Staph. aureus* strains have acquired resistance by transduction. Certain instances of penicillin, erythromycin and chloramphenicol resistance have been found to be phage mediated.

(iii) **Transformation** A resistant bacterium may release the resistance carrying DNA into the medium and this may be imbibed by another sensitive organism—becoming unresponsive to the drug. This mechanism is probably not clinically significant except isolated instances of pneumococcal resistance to penicillin G due to altered penicillin binding protein, and some other cases.

Resistance once acquired by any of the above mechanisms becomes prevalent due to the *selection pressure* of a widely used AMA, i.e. presence of the AMA provides opportunity for the resistant subpopulation to thrive in preference to the sensitive population.

Resistant organisms can broadly be of the following three types:

(a) Drug tolerant Loss of affinity of the target biomolecule of the microorganism for a particular AMA, e.g. resistant *Staph. aureus* and *E. coli* develop a RNA polymerase that does not bind rifampin, certain penicillin-resistant pneumococcal strains have altered penicillin binding proteins; trimethoprim-resistance results from plasmid-mediated synthesis of a dihydrofolate reductase that has low affinity for trimethoprim.

Another mechanism is acquisition of an alternative metabolic pathway, e.g. certain sulfonamide resistant bacteria switch over to utilizing preformed folic acid in place of synthesizing it from PABA taken up from the medium.

(b) Drug destroying The resistant microbe elaborates an enzyme which inactivates the drug, e.g.

(i) β -lactamases are produced by staphylococci, *Haemophilus*, gonococci, etc. which inactivate penicillin G. The β -lactamases may be present in low quantity but strategically located periplasmically (as in gram-negative bacteria) so that the drug is inactivated soon after entry, or may be elaborated in large quantities (by gram-positive bacteria) to diffuse into the medium and destroy the drug before entry.

(ii) Chloramphenicol acetyl transferase is acquired by resistant *E. coli*, *H. influenzae* and *S. typhi*.

(iii) Some of the aminoglycoside-resistant coliforms have been found to produce enzymes which adenylate/acetylate/phosphorylate specific aminoglycoside antibiotics.

(c) Drug impermeable Many hydrophilic antibiotics gain access into the bacterial cell through specific channels formed by proteins called 'porins', or need specific transport mechanisms. These may be lost by the resistant strains, e.g. concentration of some aminoglycosides and tetracyclines in the resistant gram-negative bacterial strains has been found to be much lower than that in their sensitive counterparts when both were exposed to equal concentrations of the drugs. Similarly, the low degree penicillin-resistant gonococci are less permeable to penicillin G; chloroquine-resistant *P. falciparum* accumulates less chloroquine. The bacteria may also acquire plasmid directed inducible energy dependent efflux proteins in their cell membrane which pump out tetracyclines. Active efflux-based resistance has been detected for erythromycin and fluoroquinolones as well.

Cross resistance Acquisition of resistance to one AMA conferring resistance to another AMA,

to which the organism has not been exposed, is called cross resistance. This is more commonly seen between chemically or mechanistically related drugs, e.g. resistance to one sulfonamide means resistance to all others, and resistance to one tetracycline means insensitivity to all others. Such cross resistance is often complete. However, resistance to one aminoglycoside may not extend to another, e.g. gentamicin-resistant strains may respond to amikacin. Sometimes unrelated drugs show partial cross resistance, e.g. between tetracyclines and chloramphenicol, between erythromycin and lincomycin.

Cross resistance may be two-way, e.g. between erythromycin and clindamycin and *vice versa*, or one-way, e.g. development of neomycin resistance by enterobacteriaceae makes them insensitive to streptomycin but many streptomycin-resistant organisms remain susceptible to neomycin.

Prevention of drug resistance It is of utmost clinical importance to curb development of drug resistance. Measures are:

- (a) No indiscriminate and inadequate or unduly prolonged use of AMAs should be made. This would minimize the selection pressure and resistant strains will get less chance to preferentially propagate. For acute localized infections in otherwise healthy patients, symptom determined shorter courses of AMAs are being advocated now.
- (b) Prefer rapidly acting and selective (narrow-spectrum) AMAs whenever possible; broad-spectrum drugs should be used only when a specific one cannot be determined or is not suitable.
- (c) Use combination of AMAs whenever prolonged therapy is undertaken, e.g. tuberculosis, SABC.
- (d) Infection by organisms notorious for developing resistance, e.g. *Staph. aureus*, *E. coli*, *M. tuberculosis*, *Proteus*, etc. must be treated intensively.

4. Superinfection (Suprainfection)

This refers to the appearance of a new infection as a result of antimicrobial therapy.

Use of most AMAs causes some alteration in the normal microbial flora of the body. The normal flora contributes to host defence by elaborating substances called *bacteriocins* which inhibit pathogenic organisms. Further, ordinarily, the pathogen has to compete with the normal flora for nutrients, etc. to establish itself. Lack of competition may allow even a normally non-pathogenic component of the flora, which is not inhibited by the drug (e.g. *Candida*), to predominate and invade. More complete the suppression of body flora, greater are the chances of developing superinfection. Thus, it is commonly associated with the use of broad/extended-spectrum antibiotics, such as tetracyclines, chloramphenicol, ampicillin, newer cephalosporins; especially when combinations of these are employed. Tetracyclines are more prone than chloramphenicol and ampicillin is more prone than amoxicillin to cause superinfection diarrhoeas because of incomplete absorption—higher amounts reach the lower bowel and cause greater suppression of colonic bacteria.

Superinfections are more common when host defence is compromised.

Conditions predisposing to superinfections

- Corticosteroid therapy
- Leukaemias and other malignancies, especially when treated with anticancer drugs (these are also immunosuppressants and decrease WBC count)
- Acquired immunodeficiency syndrome (AIDS)
- Agranulocytosis
- Diabetes, disseminated lupus erythematosus

Sites involved in superinfection are those that normally harbour commensals, i.e. oropharynx; intestinal, respiratory and genitourinary tracts; occasionally skin.

Superinfections are generally more difficult to treat. The organisms frequently involved, manifestations and drugs for treating superinfections are:

- (a) *Candida albicans*: monilial diarrhoea, thrush, vulvovaginitis; treat with nystatin or clotrimazole.

(b) Resistant staphylococci: enteritis; treat with cloxacillin or its congeners.

(c) *Clostridium difficile*: pseudomembranous enterocolitis associated with the use of clindamycin, tetracyclines, aminoglycosides, ampicillin, cotrimoxazole; more common after colorectal surgery; the organism produces an enterotoxin which damages gut mucosa forming plaques; metronidazole and vancomycin are the drugs of choice.

(d) *Proteus*: Urinary tract infection, enteritis; treat with a cephalosporin or gentamicin.

(e) *Pseudomonas*: Urinary tract infection, enteritis; treat with carbenicillin, piperacillin or gentamicin.

To minimize superinfections:

- (i) Use specific (narrow-spectrum) AMA whenever possible.
- (ii) Do not use antimicrobials to treat trivial, self-limiting or untreatable (viral) infections.
- (iii) Do not unnecessarily prolong antimicrobial therapy.

5. Nutritional deficiencies

Some of the B complex group of vitamins and vit K synthesized by the intestinal flora is utilized by man. Prolonged use of antimicrobials which alter this flora may result in vitamin deficiencies.

Neomycin causes morphological abnormalities in the intestinal mucosa—steatorrhoea and malabsorption syndrome can occur.

6. Masking of an infection

A short course of an AMA may be sufficient to treat one infection but only briefly suppress another one contacted concurrently. The other infection will be masked initially, only to manifest later in a severe form. Examples are:

- (i) Syphilis masked by the use of a single dose of penicillin which is sufficient to cure gonorrhoea.
- (ii) Tuberculosis masked by a short course of streptomycin given for trivial respiratory infection.

CHOICE OF AN ANTIMICROBIAL AGENT

After having established the need for using a systemic AMA in a patient by assessing that the condition is due to a treatable (mostly bacterial) infection, and that it is not likely to resolve by itself or by local measures (antiseptics, drainage of pus, etc) only, one has to choose a drug from the large number available. The choice depends on the peculiarities of the patient, the infecting organism and the drug.

Patient factors

1. **Age** may affect kinetics of many AMAs. Conjugation and excretion of chloramphenicol is inefficient in the newborn: larger doses produce *gray baby syndrome*. Sulfonamides displace bilirubin from protein binding sites—can cause kernicterus in the neonate because their blood-brain barrier is more permeable. The $t_{1/2}$ of aminoglycosides is prolonged in the elderly and they are more prone to develop VIII nerve toxicity. Tetracyclines deposit in the developing teeth and bone—discolour and weaken them—are contraindicated below the age of 6 years.

2. **Renal and hepatic function** Cautious use and modification of the dose of an AMA (with low safety margin) becomes necessary when the organ of its disposal is defective (*see box*).

Antimicrobials needing dose reduction/avoidance in renal failure

<i>Reduce dose even in mild failure</i>	
Aminoglycosides	Amphotericin B
Cephalosporins	Ethambutol
Vancomycin	Flucytosine
<i>Reduce dose only in moderate-severe failure</i>	
Metronidazole	Carbenicillin
Cotrimoxazole	Fluoroquinolones
Aztreonam	Clarithromycin
Meropenem	Imipenem
<i>Drugs to be avoided</i>	
Cephalothin	Talampicillin
Nalidixic acid	Tetracyclines
Nitrofurantoin	(except doxycycline)

Antimicrobials in liver disease

Drugs to be avoided

Erythromycin estolate	Tetracyclines
Pyrazinamide	Nalidixic acid
Talampicillin	Pefloxacin

Dose reduction needed

Chloramphenicol	Isoniazid
Metronidazole	Rifampin
Clindamycin	

3. Local factors The conditions prevailing at the site of infection greatly affect the action of AMAs.

(a) Presence of pus and secretions decrease the efficacy of most AMAs, especially sulfonamides and aminoglycosides. Drainage of the abscess reduces the population of the causative bacteria, suppresses anaerobes by exposure to oxygen, and improves diffusion of the antibiotic into the abscess.

(b) Presence of necrotic material or foreign body makes eradication of infection practically impossible.

(c) Haematomas foster bacterial growth; tetracyclines, penicillins and cephalosporins get bound to the degraded haemoglobin in the haematoma.

(d) Lowering of pH at the site of infection reduces activity of macrolide and aminoglycoside antibiotics.

(e) Anaerobic environment in the centre of an abscess impairs bacterial transport processes which concentrate aminoglycosides in the bacterial cell, rendering them less susceptible.

(f) Penetration barriers may hamper the access of the AMA to the site of infection in subacute bacterial endocarditis (SABE), endophthalmitis, prostatitis. However, trimethoprim and fluoroquinolones attain high concentration in prostate due to ion trapping.

4. Drug allergy History of previous exposure to an AMA should be obtained. If a drug has caused allergic reaction—it has to be avoided in that patient, e.g. drug of choice for syphilis in a patient allergic to penicillin is tetracycline.

β -lactams, sulfonamides, fluoroquinolones and nitrofurantoin frequently cause allergy.

5. Impaired host defence Integrity of host defence plays a crucial role in overcoming an infection. Pyogenic infections occur readily in neutropenic patients, while if cell-mediated immunity is impaired (e.g. AIDS), infections by low grade pathogens and intracellular organisms abound. In an individual with normal host defence, a bacteriostatic AMA may achieve cure; while intensive therapy with cidal drugs is imperative in those with impaired host defence (conditions given on p. 672) or when the organisms are protected by a barrier—as in SABE. Even then complete eradication of the organism may not occur.

6. Pregnancy All AMAs should be avoided in the pregnant because of risk to the foetus. Penicillins, many cephalosporins and erythromycin are safe, while safety data on most others is not available. Therefore, manufacturers label 'contraindicated during pregnancy'. Tetracyclines carry risk of acute yellow atrophy of liver, pancreatitis and kidney damage in the mother. They also cause teeth and bone deformities in the offspring. Aminoglycosides can cause foetal ear damage. Animal studies indicate increased risk to the foetus, especially with fluoroquinolones, cotrimoxazole, chloramphenicol, sulfonamides and nitrofurantoin. Though metronidazole has not been found teratogenic, its mutagenic potential warrants caution in its use during pregnancy.

7. Genetic factors Primaquine, nitrofurantoin, sulfonamides, chloramphenicol and fluoroquinolones are likely to produce haemolysis in G-6-PD deficient patient.

Organism-related considerations

Each AMA has a specific effect on a limited number of microbes. Successful chemotherapy must be rational and demands a diagnosis. However, most of the time, definitive bacteriological

diagnosis is not available before initiating treatment. Bacteriological testing is time consuming, expensive and appropriate samples of infected material for bacteriology may not be obtainable. A clinical diagnosis should first be made, at least tentatively, and the likely pathogen guessed. The following line of action may be taken:

1. *Clinical diagnosis itself directs choice of the AMA* The infecting organism and its sensitivity are not variable, e.g. syphilis, chancroid, diphtheria, tetanus, plague, cholera, trachoma, thrush, tuberculosis, lobar pneumonia, leprosy, amoebiasis, herpes simplex, etc.

2. *A good guess can be made* from the clinical features and local experience about the type of organism and its sensitivity: tonsillitis, otitis media, boils, vaginitis, urethritis; the most appropriate specific AMA should be prescribed and the response watched for. A gram stained smear examination of infected material may help to aid the choice.

3. *Choice to be based on bacteriological examination* No guess can be made about the infecting organism or its sensitivity, e.g. bronchopneumonia, empyema, meningitis, osteomyelitis, urinary tract infection, wound infection, etc. In these situations, an AMA should be selected on the basis of culture and sensitivity testing; but this may not be always possible.

(a) *Bacteriological services not available*: empirical therapy to cover all likely organisms with a broad-spectrum drug like fluoroquinolone, tetracycline or a combination such as penicillin + streptomycin or gentamicin + a cephalosporin may be used (with metronidazole if anaerobes are suspected). Further therapy is modified on the basis of clinical response; but hasty and arbitrary changes in therapy should be avoided.

(b) *Bacteriological services available, but treatment cannot be delayed*: as in serious infections like meningitis, septicaemias, etc., specimens for bacteriological examination should be sent and empirical therapy started provisionally as in (a). In case of inadequate response, the AMA should

be changed later in the light of bacteriological findings.

(c) *Bacteriological services are available and treatment can be delayed for a few days*: as in chronic urinary tract infection; it is better to wait for the culture and sensitivity report; start definitive therapy thereafter.

Bacteriological sensitivity testing This is generally done by disk-agar diffusion method using standardized concentrations of antibiotics based on clinically attained plasma concentrations of these. As such, they serve only as guides and cannot be blindly extrapolated to the clinical situation in every patient and for every organism. Broth cultures with *break-point* concentration (concentration that demarcates between sensitive and resistant bacteria) of antibiotics probably yield more reliable results. Break-point concentrations are based on clinically attainable serum concentrations of the antibiotic.

Minimum inhibitory concentration (MIC), i.e. the lowest concentration of an antibiotic which prevents visible growth of a bacterium determined in microwell culture plates using serial dilutions of the antibiotic is more informative, but not estimated routinely.

Minimum bactericidal concentration (MBC), of the antibiotic is determined by subculturing from tubes with no visible growth. If the organism is killed, no growth will occur; but if it was only inhibited in the parent culture—it will grow on subculturing in antibiotic-free medium. MBC is the concentration of the antibiotic which kills 99.9% of the bacteria. A small difference between MIC and MBC indicates that the antibiotic is primarily bactericidal, while a large difference indicates bacteriostatic action. MBC is not used to guide selection of antibiotics in clinical practice.

Postantibiotic effect (PAE) After a brief exposure if the organism is placed in antibiotic-free medium, it starts multiplying again, but after a lag period which depends on the antibiotic as well as the organism. This lag period in growth resumption is known as 'postantibiotic effect' and is the time required for reattainment of logarithmic growth. A long PAE has been noted with fluoroquinolones, aminoglycosides and β -lactam antibiotics.

Drug factors

When any one of a number of AMAs could be used to treat an infection, choice among them is based upon specific properties of these AMAs:

1. *Spectrum of activity*: For definitive therapy, a narrow-spectrum drug which selectively affects the concerned organism is preferred, because it is generally more effective than a broad-spectrum AMA, and is less likely to disturb the normal

microbial flora. However, for empirical therapy, often a broad-spectrum drug has to be used to cover all likely pathogens.

2. Type of activity: Many infections in patients with normal host defence respond equally well to bacteriostatic and bactericidal AMAs. But several acute infections resolve faster with a cidal than a static drug, because the cidal drug directly reduces the number of bacteria at the site of infection, while the static drug only prevents increase in their number. Many bactericidal drugs exert prolonged postantibiotic effect so that maintenance of drug level continuously above the MIC is not essential. With bacteriostatic AMAs the bacteria start multiplying quickly when drug level falls below the MIC, resulting in relapse of infection.

A bactericidal antibiotic is clearly superior to bacteriostatic one in treating patients with impaired host defence, life-threatening infections, infections at less accessible sites (SABE) or when carrier state is possible (typhoid).

3. Sensitivity of the organism: assessed on the basis of MIC values (if available) and consideration of postantibiotic effect.

4. Relative toxicity: Obviously, a less toxic antibiotic is preferred, e.g. a β -lactam over an aminoglycoside or erythromycin over clindamycin.

5. Pharmacokinetic profile: For optimum action the antibiotic has to be present at the site of infection in sufficient concentration for an adequate length of time. This depends on their pharmacokinetic characteristics. Most antibiotics are given at 2 to 4 half-life intervals—thus attaining therapeutic concentrations only intermittently. For many organisms, aminoglycosides and fluoroquinolones produce 'concentration-dependent inhibition'—inhibitory effect depends on the ratio of peak concentration to the MIC; the same daily dose of gentamicin produces better action when given as a single dose than if it is divided into 2–3 portions. On the other hand, β -lactams, glycopeptides and macrolides produce 'time-dependent inhibition'—antimicrobial action depends on the length of time the

concentration remains above MIC; division of daily dose has better effect. However, the doses should be so spaced that the surviving organisms again start multiplying and a cidal action is exerted.

Penetration to the site of infection also depends on the pharmacokinetic properties of the drug. A drug which penetrates better and attains higher concentration at the site of infection is likely to be more effective. The fluoroquinolones have excellent tissue penetration—attain high concentrations in soft tissues, lungs, prostate, joints, etc. Ciprofloxacin and rifampin have very good intracellular penetration. Cefuroxime, ceftriaxone, chloramphenicol, ciprofloxacin attain high CSF concentration. On the other hand, penicillins and aminoglycosides penetrate poorly into CSF unless meninges are inflamed. Ampicillin, cephalosporins and erythromycin attain high biliary concentration.

6. Route of administration: Many AMAs can be given orally as well as parenterally, but aminoglycosides, penicillin G, carbenicillin, many cephalosporins, vancomycin, etc. have to be given by injection only. For less severe infections, an oral antibiotic is preferable; but for serious infections, e.g. meningitis, spreading cellulitis, septicaemias, a parenteral antibiotic may be chosen.

7. Evidence of clinical efficacy: Relative value of different AMAs in treating an infection is decided on the basis of comparative clinical trials. Optimum dosage regimens and duration of treatment are also determined on the basis of such trials. Reliable clinical trial data, if available, is the final guide for choice of the antibiotic.

8. Cost: Less expensive drugs are to be preferred.

COMBINED USE OF ANTIMICROBIALS

More than one AMAs are frequently used concurrently. This should be done only with a specific purpose and not blindly in the hope that if one is good, two should be better and three should cure almost any infection. The objectives of using antimicrobial combinations are:

1. To achieve synergism Every AMA has a specific effect on selected microorganisms. Depending on the drug pair as well as the organism involved, either synergism (supra-additive effect), additive action, indifference or antagonism may be observed when two AMAs belonging to different classes are used together.

Synergism may manifest in terms of decrease in the MIC of one AMA in the presence of another, or the MICs of both may be lowered. If the MIC of each AMA is reduced to 25% or less, the pair is considered synergistic, 25–50% of each is considered additive and more than 50% of each indicates antagonism. Thus, a synergistic drug sensitizes the organisms to the action of the other member of the pair. This may also manifest as a more rapid lethal action of the combination than either of the individual members. Synergistic prolongation of postantibiotic effect has also been demonstrated for combinations of β -lactams with aminoglycoside and by addition of rifampin to a variety of antibiotics.

Every combination is unique; the same drugs may be synergistic for one organism but antagonistic for another. However, general guidelines are:

(a) Two bacteriostatic agents are often additive, rarely synergistic, i.e. combination of tetracyclines, chloramphenicol, erythromycin, etc. A sulfonamide used with trimethoprim is a special case where supraadditive effect is obtained because of sequential block in folate metabolism of certain bacteria (Ch. 50). The combination often exerts cidal action, while the individual components are only static.

Another special example is the combination of a β -lactamase inhibitor clavulanic acid or sulbactam with amoxicillin or ampicillin for β -lactamase producing *H. influenzae*, *N. gonorrhoeae* and other organisms.

(b) Two bactericidal drugs are frequently additive and sometime synergistic if the organism is sensitive to both, e.g.:

- Penicillin/ampicillin + streptomycin/gentamicin or vancomycin + gentamicin for

enterococcal SABE. Penicillins by acting on the cell wall may enhance the penetration of the aminoglycoside into the bacterium.

- Carbenicillin/ticarcillin + gentamicin for *Pseudomonas* infection, especially in neutropenic patients.
- Ceftazidime + ciprofloxacin for *Pseudomonas* infected orthopedic prosthesis.
- Rifampin + isoniazid in tuberculosis.

In the above cases, the combination produces faster cure and reduces the chances of relapse by more complete eradication of the pathogen.

(c) Combination of a bactericidal with a bacteriostatic drug may be synergistic or antagonistic depending on the organism. In general (i) If the organism is highly sensitive to the cidal drug—response to the combination is equal to the static drug given alone (apparent antagonism), because cidal drugs act primarily on rapidly multiplying bacteria, while the static drug retards multiplication. This has been seen with penicillin + tetracycline/chloramphenicol on pneumococci which are highly sensitive to penicillin. Pneumococcal meningitis treated with penicillin + tetracycline had higher mortality than those treated with penicillin alone. Penicillin + erythromycin for group A *Streptococci* and nalidixic acid + nitrofurantoin for *E. coli* have also shown antagonism.

(ii) If the organism has low sensitivity to the cidal drug—synergism may be seen, e.g.:

- Penicillin + sulfonamide for actinomycosis
- Streptomycin + tetracycline for brucellosis
- Streptomycin + chloramphenicol for *K. pneumoniae* infection
- Rifampin + dapsone in leprosy.

Thus, wherever possible, synergistic combinations may be used to treat infections that are normally difficult to cure. Full doses of individual drugs are given for this purpose.

2. To reduce severity or incidence of adverse effects This is possible only if the combination is synergistic so that the doses can be reduced. This is needed for AMAs with low safety margin,

which when used alone in effective doses, produce unacceptable toxicity, e.g.

- Streptomycin + penicillin G for SABC due to *Strep. faecalis*.
- Amphotericin B + rifampin or minocycline: the latter drugs are not themselves antifungal, but enhance the action of amphotericin B.
- Amphotericin B + flucytosine: a shorter course is needed, specially for cryptococcal meningitis, than when amphotericin is used alone.

3. To prevent emergence of resistance Mutation conferring resistance to one AMA is independent of that conferring resistance to another. If the incidence of resistant mutants of a bacillus infecting an individual for drug P is 10^{-5} and for drug Q is 10^{-7} , then only one out of 10^{12} bacilli will be resistant to both. The chances of its surviving host defence and causing a relapse would be meagre.

This principle of using two or more AMAs together is valid primarily for chronic infections needing prolonged therapy; has been widely employed in tuberculosis, leprosy and now adopted for *H. pylori*, HIV as well. It is of little value in most acute and short-lived infections. However, rifampin given with ciprofloxacin prevents *Staph. aureus* resistance to the latter.

4. To broaden the spectrum of antimicrobial action This is needed in:

(a) *Treatment of mixed infection* Bronchiectasis, peritonitis, certain urinary tract infections, brain abscesses, diabetic foot infection, bedsores, gynaecological infections are mostly mixed infections. Often, aerobic and anaerobic organisms sensitive to different drugs are involved. Obviously two or more AMAs have to be used to cover the pathogens. Drugs should be chosen on the basis of bacteriological diagnosis and sensitivity pattern (known or presumed), and should be employed in full doses. Clindamycin or metronidazole are generally included to cover anaerobes. It may sometimes be possible to find a single agent effective against all the causative organisms.

(b) *Initial treatment of severe infections* For empirical therapy, since bacterial diagnosis is not known; drugs covering gram-positive and gram-negative (in certain situations anaerobes as well), e.g. penicillin + streptomycin; cephalosporin or erythromycin + an aminoglycoside ± metronidazole or clindamycin, may be given together. Rational combinations improve the certainty of curing the infection in the first attempt, but should be continued only till bacteriological data become available. When the organism and its sensitivity has been determined, severity of infection is in itself not an indication for combination therapy. Combinations should not be used as a substitute for accurate diagnosis.

(c) *Topically* Generally, AMAs which are not used systemically, are poorly absorbed from the local site and cover a broad range of gram-positive and gram-negative bacteria are combined for topical application, e.g. bacitracin, neomycin, polymyxin B.

Disadvantages of antimicrobial combinations

1. They foster a casual rather than rational outlook in the diagnosis of infections and choice of AMA.
2. Increased incidence and variety of adverse effects. Toxicity of one agent may be enhanced by another, e.g. vancomycin + tobramycin and gentamicin + cephalothin produce exaggerated kidney failure.
3. Increased chances of superinfections.
4. If inadequate doses of nonsynergistic drugs are used —emergence of resistance may be promoted.
5. Increased cost of therapy.

PROPHYLACTIC USE OF ANTIMICROBIALS

This refers to the use of AMAs for preventing the setting in of an infection or suppressing contacted infection before it becomes clinically manifest. AMAs are frequently given prophylactically, but in a number of circumstances this is at best wasteful if not harmful. The difference between

treating and preventing infections is that treatment is directed against a specific organism infecting an individual patient, while prophylaxis is often against all organisms capable of causing infection. The valid as well as improper prophylactic uses may be categorized as:

1. Prophylaxis against specific organisms In general highly satisfactory; the choice of drug is clearcut.

(a) Rheumatic fever: group A *Streptococci*: long acting penicillin G is the drug of choice for preventing recurrences.

(b) Tuberculosis: Children, HIV positive and other susceptible contacts of open cases: Isoniazid alone or with rifampin is recommended.

(c) *Mycobacterium avium* complex (MAC): HIV / AIDS patients with low CD4 count may be protected against MAC infection by azithromycin / clarithromycin.

(d) HIV infection: Health care workers exposed to blood by needle stick injury: zidovudine + lamivudine ± indinavir. Offspring of HIV positive woman can be protected by zidovudine given to pregnant mother and then to the newborn for 6 weeks.

(e) Meningococcal meningitis: during an epidemic, especially in contacts; rifampin / sulfadiazine / ceftriaxone may be used.

(f) Gonorrhoea / syphilis: before or immediately after contact: ampicillin / ceftriaxone.

(g) Recurrent genital herpes simplex: Acyclovir prophylaxis may be given when four or more recurrences occur in a year.

(h) Malaria: for travellers to endemic areas with high transmission rate: chloroquine / mefloquine.

(i) Influenza A₂: during an epidemic, especially in contacts: amantadine.

(j) Cholera: tetracycline prophylaxis may be given to close contacts of a case.

(k) Whooping cough: non-immunized child contact during the incubation period: erythromycin can abort clinical disease.

(l) Plague: contacts curing an epidemic: doxycycline.

(m) *Pneumocystis jiroveci* pneumonia: Transplant recipients on immunosuppressants / leukaemia / AIDS patients may be protected by cotrimoxazole.

2. Prevention of infection in high risk situations It may be valid and satisfactory in certain situations, but controversial in others.

(a) Dental extraction, tonsillectomy, endoscopies cause damage to mucosa harbouring bacteria → bacteremia occurs. In patients with valvular defects, this can cause endocarditis: appropriate prophylaxis with amoxicillin or clindamycin may be given few hours before to few hours after the manipulation.

(b) Catheterization or instrumentation of urinary tract: cotrimoxazole or norfloxacin. Patients with valvular lesions may be protected with ampicillin, gentamicin or vancomycin during catheterization.

(c) To prevent recurrences of urinary tract infection in patients with abnormalities of the tract: cotrimoxazole or nitrofurantoin may be given on a long-term basis since the organism mostly is *E. coli*.

(d) Chronic obstructive lung disease, chronic bronchitis: ampicillin / doxycycline / ciprofloxacin has been used to prevent acute exacerbations: but are of doubtful value.

(e) Immunocompromized patients (receiving corticosteroids or antineoplastic chemotherapy, neutropenic patients): penicillin / cephalosporin ± an aminoglycoside or fluoroquinolone are often used to prevent respiratory tract infections and septicaemia, but incidence of superinfections is high.

Prophylaxis of surgical site infection

Surgical site infection (SSI) includes superficial incisional infections (e.g. stitch abscess), deep incisional infection (of soft tissue) and organ / space infection. The purpose of surgical prophylaxis is to reduce the incidence of SSI with minimal alteration of normal microbial flora of the host and minimal adverse effects.

For grading the need and intensity of antimicrobial prophylaxis, the operative wounds have been classified into 4 categories with increasing risk of SSI (see box).

Classification of operative wounds* with increasing risk of infection

- *Clean*: Elective, nontraumatic surgery, no viscera or tract (respiratory, g.i., biliary, genitourinary) entered, no infection at site, no break in technique.
- *Clean-contaminated*: Otherwise clean but emergency surgery, elective with opening of any viscera/tract but minimal spillage, no contact with infected material, minor break in technique.
- *Contaminated*: Gross spillage from g.i. tract (gut resection), opening of infected biliary or genitourinary tract, penetrating injury < 4 hr old, grafting on chronic open wound, major break in technique.
- *Dirty*: Opening of abscess or purulent site, preoperative perforation of g.i./respiratory/genitourinary tract/penetrating injury > 4 hr old.

*based on National Research Council (NRC) criteria.

Wound infection occurs due to microbial contamination of the surgical site. It is important for the surgeon to see that the wound left after surgery does not get infected. Use of sterile instruments, cross-infection control measures (antiseptic/disinfectant, etc.) and good surgical technique to minimise tissue damage, haematoma and devascularization are the primary, and often the only, measures needed. However, extensive, prolonged and often combined use of AMAs is made for prophylaxis of infection after practically all surgeries. Such misuse is particularly rampant in developing countries, probably because of unreliability of infection control measures. The SSI is directly related to the number of bacteria present in the surgical wound at the time of closure. Systemic antimicrobial prophylaxis should be employed only when there is clear risk of SSI. In general, it is not required for clean surgery, except in patient at special risk. Clean surgery in otherwise healthy subjects is associated with very low risk of SSI.

Incidence of postoperative infection is higher when surgery had lasted 2 hours or more. Prophylaxis should be given for surgeries in which a prosthesis is inserted into the bone or soft tissue. Even clean surgery needs to be covered

by AMA in diabetics, corticosteroid recipients and other immunocompromised subjects, infants, elderly, malnourished and when there is extensive tissue handling/use of electrocautery, etc.

The selection of drug, dose, timing and duration of prophylactic medication is crucial. It is important that the antibiotic is not started prematurely and is not continued beyond the time when bacteria have access to the surgical wound. Administration of the AMA has to be so timed that peak blood levels occur when clot is forming in the surgical wound, and it is present throughout the procedure. Thus, most of the oral drugs are given 1 hour before incision, while i.v. administration just before/after anaesthesia best ensures effective blood levels of the AMA during surgery. Most AMAs do not penetrate the clot once it is formed and is older than 3 hours. Thus, late and prolonged presence of the antibiotic in circulation serves no purpose, but can foster resistant organisms. In case of prolonged surgery, the AMA may be repeated i.v. during the procedure. Postoperative administration of the AMA, especially after 4 hours of wound closure is recommended only in case of contaminated and dirty surgery, in which case it may be given for upto 5 days.

To be maximally effective, a relatively high dose of the AMA is selected which yields peak blood level several times higher than MIC for the likely pathogens. The drug or combination of drugs is selected based on the knowledge of the organism most commonly causing SSI in a given procedure. Local patterns of wound infection (e.g. prevalence of MRSA) and sensitivities of the causative organisms should guide the selection. The commonly employed AMAs for prophylaxis in case of clean and clean-contaminated surgeries are listed in the box.

Dirty contaminated wounds (including road side accidents): The antimicrobial regimens generally administered for 5 days in case of contaminated dirty wounds are:

1. Cefazolin 1 g i.v. 8 hourly
+ vancomycin 1 g i.v. 12 hourly.

2. Cefoxitin 1 g i.v. 6 hourly/ceftizoxime 1 g i.v. 12 hourly.
3. Clindamycin 0.6 g i.v. 8 hourly
+ Gentamicin 80 mg i.v. 8 hourly.
4. Ampicillin 2 g i.v. 6 hourly/vancomycin 1 g i.v. 12 hourly
+ Gentamicin 80 mg i.v. 8 hourly
+ Metronidazole 0.5 g i.v. 8 hourly.
5. Amoxicillin 1 g + Clavulanate 0.2 g i.v. 12 hourly.
All given for 5 days.

Commonly used antimicrobials for surgical prophylaxis

Oral (single dose given 1 hour before procedure)

1. Amoxicillin 2 g (50 mg/kg)
 2. Cephalexin 2 g (50 mg/kg)
 3. Cefadroxil 2 g (50 mg/kg)
 4. Clindamycin 600 mg (20 mg/kg)
 5. Azithromycin 500 mg (15 mg/kg)
 6. Clarithromycin 500 mg (15 mg/kg)
- } For patients allergic to penicillin

Parenteral (single injection just before procedure)

1. Ampicillin 2 g (50 mg/kg) i.m./i.v.
2. Cefazolin 1 g (25 mg/kg) i.v.
3. Vancomycin 1 g (20 mg/kg) i.v. (in MRSA prevalent areas and/or penicillin allergic patients).
4. Clindamycin 600 mg (20 mg/kg) i.v. (for penicillin allergic patients).

3. Prevention of infection in general This is highly unsatisfactory in most cases and must be condemned. Examples are:

- (a) Neonates, especially after prolonged or instrumental delivery.
- (b) To prevent postpartum infections in the mother after normal delivery.
- (c) Viral upper respiratory tract infections: to prevent secondary bacterial invasion.
- (d) To prevent respiratory infections in unconscious patients or in those on respirators.

Antimicrobial prophylaxis in these situations may be hazardous—infection by resistant organisms, fungal and other superinfections can occur, because it is not possible to prevent all infections, at all times, in all individuals.

FAILURE OF ANTIMICROBIAL THERAPY

The success of antimicrobial therapy can be measured either clinically in terms of improvement in symptoms/signs or microbiologically as eradication of the infecting organism.

Antimicrobials may fail to cure an infection/fever, or there may be relapses. This is rare when antimicrobial therapy was begun, in the first place, on sound clinical and/or bacteriological basis. When a real or apparent failure of the antimicrobial regimen occurs, the diagnosis and therapy should be reviewed. One of the following causes will usually be identified.

1. Improper selection of drug, dose, route or duration of treatment.
2. Treatment begun too late.
3. Failure to take necessary adjuvant measures, e.g. drainage of abscesses, empyema, etc.; removal of renal stones, other foreign bodies or infected gall bladder, adjustment of proper urinary pH in case of urinary tract infection; cavity closure; control of diabetes, etc.
4. Poor host defence—as in leukaemias, neutropenia and other causes, especially if a bacteriostatic AMA is used.
5. Infecting organism present behind barriers, such as vegetation on heart valves (SABE), inside the eyeball, blood brain-barrier.
6. Trying to treat untreatable (viral) infections or other causes of fever (malignancy, collagen diseases).
7. Presence of dormant or altered organisms (the persisters) which later give rise to a relapse.

CHAPTER 50

Sulfonamides, Cotrimoxazole and Quinolones

SULFONAMIDES

Sulfonamides were the first antimicrobial agents (AMAs) effective against pyogenic bacterial infections. Sulfonamido-chrysoidine (Prontosil Red) was one of the dyes included by Domagk to treat experimental streptococcal infection in mice and found it to be highly effective. He subsequently cured his daughter of streptococcal septicaemia (which was 100% fatal at that time) by prontosil. By 1937, it became clear that prontosil was broken down in the body to release sulfanilamide which was the active antibacterial agent. A large number of sulfonamides were produced and used extensively in the subsequent years, but because of rapid emergence of bacterial resistance and the availability of many safer and more effective antibiotics, their current utility is limited, except in combination with trimethoprim (as cotrimoxazole) or pyrimethamine (for malaria).

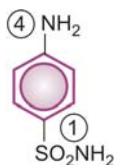

SULFANILAMIDE

Chemistry All sulfonamides may be considered to be derivatives of sulfanilamide (p-aminobenzene sulfonamide). Individual members differ in the nature of N¹ (Sulfonamido N) substitution, which governs solubility, potency and pharmacokinetic property. A free amino group in the para position (N⁴) is required for antibacterial activity.

Sulfonamides that are still of clinical interest are:

1. **Short acting** (4–8 hr): Sulfadiazine
2. **Intermediate acting** (8–12 hr): Sulfamethoxazole
3. **Long acting** (~7 days): Sulfadoxine, Sulfamethopyrazine
4. **Special purpose sulfonamides**: Sulfacetamide sod., Mafenide, Silver sulfadiazine, Sulfasalazine

ANTIBACTERIAL SPECTRUM

Sulfonamides are primarily bacteriostatic against many gram-positive and gram-negative bacteria. However, bactericidal concentrations may be attained in urine. Sensitivity patterns among microorganisms have changed from time-to-time and place-to-place. Those still sensitive are:

many *Strepto. pyogenes*, *Haemophilus influenzae*, *H. ducreyi*, *Calymmatobacterium granulomatis*, *Vibrio cholerae*. Only a few *Staph. aureus*, gonococci,

NOTE: Nonabsorbable sulfonamides—Phthylsulfathiazole, Succinyl sulfathiazole, Sulfaganidine are banned in India

meningococci, pneumococci, *Escherichia coli*, and *Shigella* respond, but majority are resistant.

Anaerobic bacteria are not susceptible.

Chlamydiae: trachoma, lymphogranuloma venereum, inclusion conjunctivitis, are sensitive, as are *Actinomyces*, *Nocardia* and *Toxoplasma*.

Mechanism of action Many bacteria synthesize their own folic acid (FA) of which p-aminobenzoic acid (PABA) is a constituent, and is taken up from the medium. Woods and Fildes (1940) proposed the hypothesis regarding sulfonamide action. Sulfonamides, being structural analogues of PABA, inhibit bacterial folate synthase → FA is not formed and a number of essential metabolic reactions suffer. Sulfonamides competitively inhibit the union of PABA with pteridine residue to form dihydropteroic acid which conjugates with glutamic acid to produce dihydrofolic acid. Also, being chemically similar to PABA, the sulfonamide may itself get incorporated to form an altered folate which is metabolically injurious.

Human cells also require FA, but they utilize preformed FA supplied in diet and are unaffected by sulfonamides. Evidences in favour of this mechanism of action of sulfonamides are:

- PABA, in small quantities, antagonizes the antibacterial action of sulfonamides.
- Only those microbes which synthesize their own FA, and cannot take it from the medium are susceptible to sulfonamides.

Pus and tissue extracts contain purines and thymidine which decrease bacterial requirement for FA and antagonize sulfonamide action. Pus is also rich in PABA.

Resistance to sulfonamides Most bacteria are capable of developing resistance to sulfonamides. Prominent among these are gonococci, pneumococci, *Staph. aureus*, meningococci, *E. coli*, *Shigella* and some *Strep. pyogenes*, *Strep. viridans* and anaerobes. The resistant mutants either:

- produce increased amounts of PABA, or
- their folate synthase enzyme has low affinity for sulfonamides, or

- adopt an alternative pathway in folate metabolism.

Resistance developed *in vivo* is quite persistent. Sensitivity patterns have changed depending on the extent of use. When an organism is resistant to one sulfonamide, it is resistant to them all. No cross resistance between sulfonamides and other AMAs has been noted. Development of resistance has markedly limited the clinical usefulness of this class of compounds.

PHARMACOKINETICS

Sulfonamides are rapidly and nearly completely absorbed from g.i.t. Extent of plasma protein binding differs considerably (10–95%) among different members. The highly protein bound members are longer acting. Sulfonamides are widely distributed in the body—enter serous cavities easily. The free form of sulfadiazine attains the same concentration in CSF as in plasma. They cross placenta freely.

The primary pathway of metabolism of sulfonamides is acetylation at N⁴ by nonmicrosomal acetyl transferase, primarily in liver. There are slow and fast acetylators, but the difference is mostly insufficient to be clinically significant. The extent of metabolism differs for different members. The acetylated derivative is inactive, but can contribute to the adverse effects. It is generally less soluble in acidic urine than the parent drug—may precipitate and cause crystalluria. The acetylated form accumulates in blood in patients with renal failure along with the parent drug—toxicity increases.

Sulfonamides are excreted mainly by the kidney through glomerular filtration. Both renal tubular secretion and reabsorption also occur. The more lipid-soluble members are highly reabsorbed in the tubule, therefore are longer acting.

Sulfadiazine It is the prototype of the general purpose sulfonamides that is rapidly absorbed orally and rapidly excreted in urine. It is 50% plasma protein bound and 20–40% acetylated. The acetylated derivative is less soluble in urine, crystalluria is likely. It has good penetrability in brain and CSF—was the preferred compound for meningitis.

Dose: 0.5 g QID to 2 g TDS; **SULFADIAZINE 0.5 g tab.**

Sulfamethoxazole It has slower oral absorption and urinary excretion—intermediate duration of action, t_{1/2} in adults averages 10 hours. It is the preferred compound for combining with trimethoprim because the t_{1/2} of both is similar. However, a high fraction is acetylated, which is relatively insoluble—crystalluria can occur.

Dose: 1 g BD for 2 days, then 0.5 g BD.

GANTANOL 0.5 g tab.

Sulfadoxine, Sulfamethopyrazine These are ultralong acting compounds, action lasting > 1 week because of high plasma protein binding and slow renal excretion ($t_{1/2}$ 5–9 days). They attain low plasma concentration (of free form) and are not suitable for treatment of acute pyogenic infections. They are used in combination with pyrimethamine in the treatment of malaria, (especially chloroquine resistant *P. falciparum*; See Ch. 59), *Pneumocystis jiroveci* pneumonia in AIDS patients and in toxoplasmosis. Because they have caused serious cutaneous reactions, large-scale use of the combination for prophylaxis of malaria is not recommended.

Sulfacetamide sod. It is a highly soluble compound yielding neutral solution which is only mildly irritating to the eye in concentrations up to 30%. It is used topically for ocular infections due to susceptible bacteria and chlamydia, including ophthalmia neonatorum caused by *Ch. oculogenitalis*. It attains high concentrations in anterior segment and aqueous humour after topical instillation. The incidence of sensitivity reactions with ocular use of sulfacetamide sod. has been low; but it must be promptly stopped when they occur.

LOCULA, ALBUCID 10%, 20%, 30% eye drops, 6% eye oint.

Mafenide It is not a typical sulfonamide, because a —CH₂— bridge separates the benzene ring and the amino group. It is used only topically—inhibits a variety of gram-positive and gram-negative bacteria. In contrast to typical sulfonamides, it is active in the presence of pus and against *Pseudomonas*, clostridia which are not inhibited by typical sulfonamides. It has been mainly employed for burn dressing to prevent infection, but not to treat already infected cases.

The biggest limitation is that mafenide produces burning sensation and severe pain when applied to raw surface. It is rapidly absorbed from the raw surface, metabolized and excreted in urine. Mafenide and its metabolite are carbonic anhydrase (CAse) inhibitors—alkalinize urine, can cause acidosis and hyperventilation: must not be applied over large areas. Allergic reactions, particularly rashes also occur.

SULFAMYLON 1% cream for surface application.

Silver sulfadiazine Used topically as 1% cream, it is active against a large number of bacteria and fungi, even those resistant to other sulfonamides, e.g. *Pseudomonas*. It slowly releases silver ions which appear to be largely responsible for the antimicrobial action. It is considered to be one of the most effective drugs for preventing infection of burnt surfaces and chronic ulcers and is well tolerated. However, it is not good for treating established infection. **SILVIRIN 1% cream, ARGENEX 1% cream with chlorhexidine 0.2%.**

Local side effects are—burning sensation on application and itch.

Released sulfadiazine may be absorbed systemically and produce its own adverse effects.

Sulfasalazine (see p. 203, 661) used in ulcerative colitis and rheumatoid arthritis.

ADVERSE EFFECTS

Adverse effects to sulfonamides are relatively common. These are:

- Nausea, vomiting and epigastric pain.
- Crystalluria is dose related, but infrequent now. Precipitation in urine can be minimized by taking plenty of fluids and by alkalinizing the urine in which sulfonamides and their acetylated derivatives are more soluble.
- Hypersensitivity reactions occur in 2–5% patients. These are mostly in the form of rashes, urticaria and drug fever. Photosensitization is reported. Stevens-Johnson syndrome and exfoliative dermatitis are more common with long-acting agents.
- Hepatitis, unrelated to dose, occurs in 0.1% patients.
- Topical use of sulfonamides is not recommended because of risk of contact sensitization. However, ocular use is permitted.
- Sulfonamides cause haemolysis in a dose-dependent manner in individuals with G-6-PD deficiency. Neutropenia and other blood dyscrasias are rare.
- Kernicterus may be precipitated in the newborn, especially premature, by displacement of bilirubin from plasma protein binding sites and more permeable blood-brain barrier.

Interactions Sulfonamides inhibit the metabolism (possibly displace from protein binding also) of phenytoin, tolbutamide and warfarin—enhance their action.

They displace methotrexate from binding and decrease its renal excretion—toxicity can occur. Fixed dose combinations of sulfonamides with penicillin are banned in India.

USES

Systemic use of sulfonamides alone (not combined with trimethoprim or pyrimethamine) is rare now. Though they can be employed for suppressive therapy of chronic urinary tract infection, for

streptococcal pharyngitis and gum infection; such uses are outmoded.

Combined with trimethoprim (as cotrimoxazole) sulfamethoxazole is used for many bacterial infections, *P. jiroveci* and nocardiasis (see below). Along with pyrimethamine, certain sulfonamides are used for malaria (see Ch. 59) and toxoplasmosis.

Ocular sulfacetamide sod. (10–30%) is a cheap alternative in trachoma/inclusion conjunctivitis, though additional systemic azithromycin or tetracycline therapy is required for eradication of the disease. Topical silver sulfadiazine or mafenide are used for preventing infection on burn surfaces.

COTRIMOXAZOLE

The fixed dose combination of trimethoprim and sulfamethoxazole is called *cotrimoxazole*. Trimethoprim is a diaminopyrimidine related to the antimalarial drug pyrimethamine which selectively inhibits bacterial dihydrofolate reductase (DHFRase). Cotrimoxazole introduced in 1969 causes sequential block of folate metabolism as depicted in Fig. 50.1. Trimethoprim is >50,000 times more active against bacterial DHFRase than against the mammalian enzyme. Thus, human folate metabolism is not interfered at antibacterial concentrations of trimethoprim. Individually, both sulfonamide and trimethoprim are bacteriostatic, but the combination becomes cidal against many organisms. Maximum synergism is seen when the organism is sensitive to both the components, but even when it is moderately resistant to one component, the action of the other may be enhanced.

Sulfamethoxazole was selected for combining with trimethoprim because both have nearly the same $t_{1/2}$ (~10 hr). Optimal synergy in case of most organisms is exhibited at a concentration ratio of sulfamethoxazole 20 : trimethoprim 1, the MIC of each component may be reduced by 3–6 times. This ratio is obtained in the plasma when the two are given in a dose ratio of 5 : 1, because trimethoprim enters many tissues, has a larger

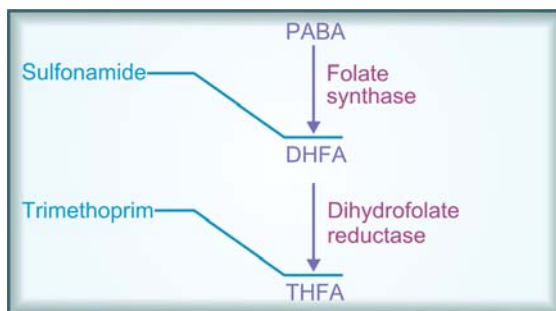

Fig. 50.1: Sequential block in bacterial folate metabolism
PABA—Para aminobenzoic acid; DHFA—Dihydrofolic acid;
THFA—Tetrahydrofolic acid

volume of distribution than sulfamethoxazole and attains lower plasma concentration. However, the concentration ratio in many tissues is less than 20 : 1. Trimethoprim adequately crosses blood-brain barrier and placenta, while sulfamethoxazole has a poorer entry. Moreover, trimethoprim is more rapidly absorbed than sulfamethoxazole—concentration ratios may vary with time. Trimethoprim is 40% plasma protein bound, while sulfamethoxazole is 65% bound. Trimethoprim is partly metabolized in liver and excreted in urine.

Spectrum of action Antibacterial spectra of trimethoprim and sulfonamides overlap considerably. Additional organisms covered by the combination are—*Salmonella typhi*, *Serratia*, *Klebsiella*, *Enterobacter*, *Yersinia enterocolitica*, *Pneumocystis jiroveci* and many sulfonamide-resistant strains of *Staph. aureus*, *Strep. pyogenes*, *Shigella*, enteropathogenic *E. coli*, *H. influenzae*, gonococci and meningococci.

Resistance Bacteria are capable of acquiring resistance to trimethoprim mostly through mutational or plasmid mediated acquisition of a DHFRase having lower affinity for the inhibitor. However, resistance to the combination has been slow to develop compared to either drug alone. Widespread use of the combination has resulted in reduced responsiveness of over 20% originally sensitive strains.

Adverse effects All adverse effects seen with sulfonamides can be produced by cotrimoxazole.

- Nausea, vomiting, stomatitis, headache and rashes are the usual manifestations.
- Folate deficiency (megaloblastic anaemia) is infrequent, occurs only in patients with marginal folate levels.
- Blood dyscrasias occur rarely.

It should not be given during pregnancy: trimethoprim being an antifolate, there is theoretical teratogenic risk. Neonatal haemolysis and methaemoglobinaemia can occur if it is given near term.

- Patients with renal disease may develop uremia. Dose should be reduced in moderately severe renal impairment.
- A high incidence (upto 50%) of fever, rash and bone marrow hypoplasia due to cotrimoxazole has been reported among AIDS patients with *Pneumocystis jiroveci* infection.
- The elderly are also at greater risk of bone marrow toxicity from cotrimoxazole.
- Diuretics given with cotrimoxazole have produced a higher incidence of thrombocytopenia.

Preparations SEPTRAN, SEPMAX, BACTRIM, CIPLIN, ORIPRIM, SUPRISTOL, FORTRIM

Trimethoprim	Sulfamethoxazole
80 mg +	400 mg tab: 2 BD for 2 days then 1 BD.
160 mg +	800 mg tab: double strength (DS); 1 BD.
20 mg +	100 mg pediatric tab.
40 mg +	200 mg per 5 ml susp; infant 2.5 ml (not to be used in newborns), children 1–5 yr 5 ml, 6–12 year 10 ml (all BD).
160 mg +	800 mg per 3 ml for i.m. injection 12 hourly. (CIPLIN, ORIPRIM-IM)
80 mg +	400 mg per 5 ml for i.v. injection (WK-TRIM, ORIPRIM-IV) 10–15 ml BD.

Cotrimazine It is a combination of trimethoprim with sulfadiazine. Its utility is similar to that of cotrimoxazole.

Trimethoprim	Sulfadiazine
90 mg +	410 mg: TRIGLOBE, ULTROX tab and per 10 ml susp.; 2 tab BD for 2 days, then 1 BD.
180 mg +	820 mg: TRIGLOBE FORTE, ULTROX DS tabs.

Uses

Though cotrimoxazole is still widely used, its popularity in the treatment of systemic infections has declined. Common indications are:

1. **Urinary tract infections** Most acute uncomplicated infections respond rapidly. Single dose therapy with 4 tablets of cotrimoxazole has been recommended for acute cystitis. Courses of 3–10 days have been advised for lower and upper urinary tract infections, according to associated features. It is specially valuable for chronic and recurrent cases and in prostatitis, because trimethoprim is concentrated in prostate.

2. **Respiratory tract infections** Both upper and lower respiratory tract infections, including chronic bronchitis and facio-maxillary infections, otitis media caused by gram positive cocci and *H. influenzae* respond well.

3. **Typhoid** Initially cotrimoxazole was an effective alternative to chloramphenicol. However, in many areas resistant *S. typhi* have appeared, and now it is seldom used. Sensitive strains of *S. typhi* respond to one DS tab BD for 2 weeks.

4. **Bacterial diarrhoeas and dysentery** Cotrimoxazole may be used for severe and invasive infections by *Campylobacter*, *E. coli*, *Shigella* and *Y. enterocolitica* (see p. 661). Though response rate is lower than previously, and fluoroquinolones are more commonly used, it is effective in ampicillin resistant cases.

5. ***Pneumocystis jiroveci*** causes severe pneumonia in neutropenic and AIDS patients. Cotrimoxazole has prophylactic as well as therapeutic value, but high doses are needed. One DS tablet 4–6 times/day for 2–3 weeks may be curative, but adverse effects necessitate discontinuation in upto 20% cases. One DS tab. daily has been used for prophylaxis and is better tolerated.

6. **Chancroid** Cotrimoxazole (800 + 160 mg) BD for 7 days is a 3rd choice inexpensive alternative to ceftriaxone, erythromycin or ciprofloxacin.

7. Cotrimoxazole is an effective alternative to penicillin for protecting *agranulocytosis patients* and treating respiratory and other infections in them. Intensive parenteral cotrimoxazole therapy has been used successfully in septicaemias, but other drugs are more commonly employed now.

Trimethoprim It has been argued that in certain situations trimethoprim alone may be as effective as the combination, while majority of adverse effects are due to the sulfonamide. Thus, wherever shown effective, trimethoprim alone may be preferred.

However, comparable efficacy of trimethoprim alone has been demonstrated only in:

1. *Urinary tract infections*: treatment of acute cases, suppressive treatment of chronic and recurrent cases—especially in females.

2. *Prostatitis*: Trimethoprim is concentrated in prostate, but not sulfonamide.

Dose: 100–200 mg BD (children 6 mg/kg/day).

QUINOLONES

These are synthetic antimicrobials having a quinolone structure that are active primarily against gram-negative bacteria, though newer fluorinated compounds also inhibit gram-positive ones. The first member *Nalidixic acid* introduced in mid-1960s had usefulness limited to urinary and g.i. tract infections because of low potency, modest blood and tissue levels, limited spectrum and high frequency of bacterial resistance. A breakthrough was achieved in the early 1980s by fluorination of the quinolone structure at position 6 and introduction of a piperazine substitution

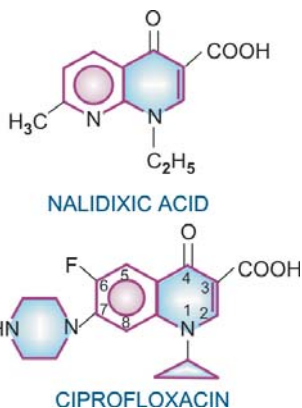

at position 7 resulting in derivatives called *fluoroquinolones* with high potency, expanded spectrum, slow development of resistance, better tissue penetration and good tolerability.

Nalidixic acid

It is active against gram-negative bacteria, especially coliforms: *E. coli*, *Proteus*, *Klebsiella*, *Enterobacter*, *Shigella* but not *Pseudomonas*. It acts by inhibiting bacterial DNA gyrase and is bactericidal. Resistance to nalidixic acid develops rather rapidly.

Nalidixic acid is absorbed orally, highly plasma protein bound and partly metabolized in liver: one of the metabolites is active. It is excreted in urine with a plasma $t_{1/2}$ ~8 hrs. Concentration of the free drug in plasma and most tissues attained with the usual doses is non-therapeutic for systemic infections (MIC values for most susceptible bacteria just approach the 'break-point' concentration). However, high concentration attained in urine (20–50 times that in plasma) is lethal to the common urinary pathogens.

Adverse effects These are relatively infrequent, consist mostly of g.i. upset and rashes.

Most important toxicity is neurological—headache, drowsiness, vertigo, visual disturbances, occasionally seizures (especially in children).

Phototoxicity is rare. Individuals with G-6-PD deficiency may develop haemolysis.

Nalidixic acid is contraindicated in infants.

Dose: 0.5–1 g TDS or QID; **GRAMONEG**, **WINTOMYLON**, **URODIC**, 0.5 g tab, 0.3 g/5 ml syrup.

Use

1. Nalidixic acid is primarily used as a urinary antiseptic, generally as a second line drug in recurrent cases or on the basis of sensitivity reports.

Nitrofurantoin should not be given concurrently—antagonism occurs.

2. It has also been employed in diarrhoea caused by *Proteus*, *E. coli*, *Shigella* or *Salmonella*, and has a

special place in ampicillin resistant *Shigella* enteritis.

FLUOROQUINOLONES

These are quinolone antimicrobials having one or more fluorine substitutions. The 'first generation' fluoroquinolones (FQs) introduced in 1980s have one fluoro substitution. In the 1990s, compounds with additional fluoro and other substitutions have been developed—further extending antimicrobial activity to gram-positive cocci and anaerobes, and/or conferring metabolic stability (longer $t_{1/2}$). These are referred to as 'second generation' FQs.

First generation fluoroquinolones

Norfloxacin	Ofloxacin
Ciprofloxacin	Pefloxacin

Second generation fluoroquinolones

Lomefloxacin	Sparfloxacin
Levofloxacin	Gatifloxacin
	Moxifloxacin

Mechanism of action The FQs inhibit the enzyme bacterial DNA gyrase, which nicks double-stranded DNA, introduces negative supercoils and then reseals the nicked ends. This is necessary to prevent excessive positive supercoiling of the strands when they separate to permit replication or transcription. The DNA gyrase consists of two A and two B subunits: The A subunit carries out nicking of DNA, B subunit introduces negative supercoils and then A subunit reseals the strands. FQs bind to A subunit with high affinity and interfere with its strand cutting and resealing function. Recent evidence indicates that in gram-positive bacteria the major target of FQ action is a similar enzyme *topoisomerase IV* which nicks and separates daughter DNA strands after DNA replication. Greater affinity for topoisomerase IV may confer higher potency against gram-positive bacteria. The bactericidal

action probably results from digestion of DNA by exonucleases whose production is signalled by the damaged DNA.

In place of DNA gyrase or topoisomerase IV, the mammalian cells possess an enzyme topoisomerase II (that also removes positive supercoils) which has very low affinity for FQs—hence the low toxicity to host cells.

Mechanism of resistance Because of the unique mechanism of action, plasmid mediated transferable resistance probably does not occur. Resistance noted so far is due to chromosomal mutation producing a DNA gyrase or topoisomerase IV with reduced affinity for FQs, or due to reduced permeability/increased efflux of these drugs across bacterial membranes. In contrast to nalidixic acid which selects single step resistant mutants at high frequency, FQ-resistant mutants are not easily selected. Therefore, resistance to FQs has been slow to develop. However, increasing resistance has been reported among *Salmonella*, *Pseudomonas*, staphylococci, gonococci and pneumococci.

Ciprofloxacin (prototype)

It is the most potent first generation FQ active against a broad range of bacteria, the most susceptible ones are the aerobic gram-negative bacilli, especially the Enterobacteriaceae and *Neisseria*. The MIC of ciprofloxacin against these bacteria is usually $< 0.1 \mu\text{g/ml}$, while gram-positive bacteria are inhibited at relatively higher concentrations. The spectrum of action is summarized below:

Highly susceptible

<i>E. coli</i>	<i>Neisseria gonorrhoeae</i>
<i>K. pneumoniae</i>	<i>N. meningitidis</i>
<i>Enterobacter</i>	<i>H. influenzae</i>
<i>Salmonella typhi</i>	<i>H. ducreyi</i>
other <i>Salmonella</i>	<i>Campylobacter jejuni</i>
<i>Shigella</i>	<i>Yersinia enterocolitica</i>
<i>Proteus</i>	<i>Vibrio cholerae</i>

Moderately susceptible

<i>Pseudomonas aeruginosa</i>	<i>Legionella</i>
<i>Staph. aureus</i>	<i>Brucella</i>
(including few MRSA)	<i>Listeria</i>
<i>Staph. epidermidis</i>	<i>Bacillus anthracis</i>
<i>Branhamella catarrhalis</i>	<i>Mycobact. tuberculosis</i>

Organisms which have shown low / variable susceptibility are: *Strep. pyogenes*, *Strep. faecalis*, *Strep. pneumoniae*, *Mycoplasma*, *Chlamydia*, *Mycobact. kansasii*, *Mycobact. avium*.

Notable resistant bacteria are: *Bacteroides fragilis*, *Clostridia*, anaerobic cocci.

The remarkable microbiological features of ciprofloxacin (also other FQs) are:

- Rapidly bactericidal activity and high potency: MBCs are close to MICs.
- Relatively long post-antibiotic effect on Enterobacteriaceae, *Pseudomonas* and *Staph.*
- Low frequency of mutational resistance.
- Low propensity to select plasmid type resistant mutants.
- Protective intestinal streptococci and anaerobes are spared.
- Active against many β -lactam and aminoglycoside resistant bacteria.
- Less active at acidic pH.

Pharmacokinetics Ciprofloxacin is rapidly absorbed orally, but food delays absorption, and first pass metabolism occurs. The pharmacokinetic characteristics are given in Table 50.1. The most prominent feature of ciprofloxacin (and other FQs) is high tissue penetrability: concentration in lung, sputum, muscle, bone, prostate and phagocytes exceeds that in plasma, but CSF and aqueous levels are lower. It is excreted primarily in urine, both by glomerular filtration and tubular secretion. Urinary and biliary concentrations are 10–50 fold higher than plasma.

Adverse effects Ciprofloxacin has good safety record: side effects occur in ~10% patients, but are generally mild; withdrawal is needed only in 1.5%.

- Gastrointestinal: nausea, vomiting, bad taste, anorexia. Because gut anaerobes are not affected—diarrhoea is infrequent.

- CNS: dizziness, headache, restlessness, anxiety, insomnia, impairment of concentration and dexterity (caution while driving), tremor. Seizures are rare, occur only at high doses or when predisposing factors are present: possibly reflect GABA antagonistic action of FQs.
- Skin/hypersensitivity: rash, pruritus, photosensitivity, urticaria, swelling of lips, etc. Serious cutaneous reactions are rare.
- Tendonitis and tendon rupture: a few cases have been reported.

Ciprofloxacin and other FQs are contraindicated during pregnancy.

On the basis of the finding that administered to immature pups ciprofloxacin (and other FQs) caused cartilage damage in weight bearing joints, the FQs have been contraindicated in children. However, under pressing situations like *Pseudomonas pneumonia* in cystic fibrosis and multi-resistant typhoid, ciprofloxacin has been administered to millions of children in India and elsewhere. Though a few cases of joint pain and swelling have been reported, cartilage damage has not occurred. Caution may seem prudent while using FQs in children.

Interactions

- Plasma concentration of theophylline, caffeine and warfarin are increased by ciprofloxacin (also by norfloxacin and pefloxacin) due to inhibition of metabolism: toxicity of these drugs can occur.
- NSAIDs may enhance the CNS toxicity of FQs; seizures are reported.
- Antacids, sucralfate and iron salts given concurrently reduce absorption of FQs.

CIFRAN, CIPLOX, CIPROBID, QUINTOR, CIPROLET 250, 500, 750 mg tab, 200 mg/100 ml i.v. infusion, 3 mg/ml eye drops.

Uses Ciprofloxacin is effective in a broad range of infections including some difficult to treat ones. Because of wide-spectrum bactericidal activity, oral efficacy and good tolerability, it is being extensively employed for blind therapy of any infection, but should not be used for minor cases or where gram-positive organisms and/or anaerobes are primarily causative. In severe infections, therapy may be initiated by i.v. infusion and then switched over to oral route.

Table 50.1: Pharmacokinetic characteristics and doses of fluoroquinolones

	CIPROFL	NORFL	PEFL	OFL	LEVOFL	LOME	SPAR	GATI
1. Oral bioavailability (%)	60–80	35–45	90–100	85–95	~100	> 90	90	96
2. Plasma protein binding (%)	20–35	15	20–30	25	25	10	40	20
3. Vol. of distribution (L/kg)	3–4	2	2	1.5	1.3	1.7–2.5	3.6	—
4. Percent metabolized	20	25	85	5–10	5	20	60	<5
5. Elimination t _{1/2} (hr)	3–5	4–6	8–14	5–8	8	6–9	15–20	8
6. Routes of administration	oral, i.v.	oral	oral, i.v.	oral, i.v.	oral, i.v.	oral	oral	oral, i.v.
7. Dose (mg BD)	: oral	250–750	400	200–400	500	400	200–400	200–400
	: iv	100–200	—	400	200	500	—	200–400
					(OD)	(OD)	(OD)	(OD)

1. *Urinary tract infections*: High cure rates, even in complicated cases or those with indwelling catheters/prostatitis, have been achieved. Chronic *Pseudomonas* infections respond less completely.

2. *Gonorrhoea*: Initially a single 500 mg dose was nearly 100% curative in non-PPNG as well as PPNG infections, but cure rate has declined in the recent years due to emergence of resistance.

3. *Chancroid*: 500 mg BD for 3 days is an excellent alternative to ceftriaxone/erythromycin.

4. *Bacterial gastroenteritis*: Severe cases due to EPEC, *Shigella*, *Salmonella* and *Campy. jejuni* respond quickly. It has also been used to reduce stool volume in cholera.

5. *Typhoid*: Ciprofloxacin is the first choice drug in typhoid fever since chloramphenicol, ampicillin and cotrimoxazole have become unreliable due to development of resistance. In India and elsewhere up to 95% *S. typhi* isolates are sensitive to ciprofloxacin. However, increasing number of nonresponsive cases are being reported. A dose of 500–750 mg BD for 10 days is recommended. Patients unable to take the drug orally may be treated with 200 mg. i.v. 12 hourly in the beginning. Being bactericidal the advantages of ciprofloxacin are:

- Quick defervescence: On an average fever subsides in 4–5 days.
- Early abatement of symptoms; low incidence of complications and relapse.
- Prevention of carrier state due to cidal action, good penetration into infected cells, high biliary and intestinal mucosal concentration.

It can also be used to treat typhoid carriers (750 mg BD for 4–8 weeks). This has been found to achieve 92% eradication rate compared to 50% by ampicillin.

(For alternative drugs see box on p. 691)

6. *Bone, soft tissue, gynaecological and wound infections*: caused by resistant *Staph.* and gram-negative bacteria: high cure rates have been obtained but prolonged treatment with high doses is required in osteomyelitis and joint infections. Used along with clindamycin/ metronidazole (to cover anaerobes) it is a good drug for diabetic foot.

7. *Respiratory infections*: Ciprofloxacin should not be used as the primary drug because pneumococci and streptococci have low and variable susceptibility. However, it can treat *Mycoplasma*, *Legionella*, *H. influenzae*, *Branh. catarrhalis* and some streptococcal and pneumococcal infections besides gram-negative ones.

The US-FDA has approved use of ciprofloxacin for post exposure treatment of inhalational *anthrax* which may occur due to bioterrorism.

8. *Tuberculosis* It is now frequently used as a component of combination chemotherapy against multidrug resistant tuberculosis. Recently, even FQ-resistant TB (extensively drug resistant or XDR-TB) have arisen.

9. *Gram-negative septicaemias*: Parenteral ciprofloxacin may be combined with a third generation cephalosporin or an aminoglycoside.

10. *Meningitis*: Though penetration in CSF is not very good, ciprofloxacin has been successfully

Alternative drugs for typhoid fever

- 1. Other fluoroquinolones:** Ofloxacin (400 mg BD), levofloxacin (500 mg OD/BD) and pefloxacin (400 mg BD) are nearly equally efficacious alternatives to ciprofloxacin.
- 2. Ceftriaxone** (*see p. 706*): Currently, it is the most reliable and fastest acting bactericidal drug for enteric fever. Practically all *S. typhi* isolates, including multidrug resistant ones, are susceptible. However, it has to be injected i.v. (4 g daily for 2 days followed by 2 g/day till 2 days after fever subsides; children 75 mg/kg/day) and is expensive. Generally 7–10 days treatment is required. Being bactericidal, it also prevents relapses and carrier state. Ceftriaxone is to be preferred over FQs in children, pregnant women and in areas with FQ resistance.
Cefoperazone and *cefotaxime* are the other third generation cephalosporins used in typhoid.
- 3. Chloramphenicol** (*see p. 718*): Since majority of *S. typhi* strains are now chloramphenicol resistant, it has become clinically unreliable. It is seldom used, only in case the local strain is known to be sensitive and clinical experience supports its use. It is administered orally (0.5 g 6 hourly till fever subsides, then 0.25 g 6 hourly for another 5–7 days), and is inexpensive.
- 4. Cotrimoxazole** (*see p. 686*): It was effective in typhoid till plasmid mediated multidrug resistance spread among *S. typhi*. Now it is rarely used.
- 5. Ampicillin/amoxicillin** (*see p. 701*): These antibiotics are no longer dependable therapy for typhoid because of multi-drug resistance. Response rate is low and defervescence takes longer even in patients who respond.
- 6. Combination therapy:** There is no evidence that combination of any two or more AMAs is better than the single drug to which the infecting strain of *S. typhi* is responsive.

used in gram-negative bacterial meningitis, especially that occurring in immunocompromised patients or those with CSF shunts.

11. *Prophylaxis:* of infections in neutropenic/cancer and other susceptible patients.

12. *Conjunctivitis:* by gram-negative bacteria: topical therapy is effective.

Norfloxacin It is less potent than ciprofloxacin: MIC values for most gram-negative bacteria are 2–4 times higher. Many *Pseudomonas* and gram-positive organisms are not inhibited at clinically attained concentrations. Moreover, it attains lower

concentration in tissues. It is metabolized as well as excreted unchanged in urine.

Norfloxacin is primarily used for urinary and genital tract infections. It is also good for bacterial diarrhoeas, because high concentrations are present in the gut and anaerobic flora is not disturbed. Norfloxacin is not recommended for respiratory and other systemic infections, particularly where gram-positive cocci are involved.

NORBACTIN, NORFLOX 200, 400, 800 mg tab, 3 mg/ml eye drops; UROFLOX, NORILET 200, 400 mg tab. BACIGYL 400 mg tab, 100 mg/5 ml syr.

Pefloxacin It is the methyl derivative of norfloxacin; more lipid soluble, completely absorbed orally, penetrates tissues better and attains higher plasma concentrations. Passage into CSF is higher than other FQs—preferred for meningeal infections. It is highly metabolized—partly to norfloxacin which contributes to its activity. Pefloxacin has longer $t_{1/2}$: cumulates on repeated dosing achieving plasma concentrations twice as high as after a single dose. Because of this it is effective in many systemic infections in addition to those of the urinary and g.i. tract, though the *in vitro* activity is similar to norfloxacin. Dose of pefloxacin needs to be reduced in liver disease, but not in renal insufficiency.

Pefloxacin is an alternative to ciprofloxacin for typhoid. However, it is less effective in gram-positive coccal and *Listeria* infections.

PELOX, 200, 400 mg tab, to be taken with meals; 400 mg/5 ml inj (to be diluted in 100–250 ml of glucose solution but not saline since it precipitates in presence of Cl^- ions), PERTI, 400 mg tab.

Ofloxacin This FQ is intermediate between ciprofloxacin and norfloxacin in activity against gram-negative bacteria, but it is comparable to or more potent than ciprofloxacin for gram-positive organisms and certain anaerobes. Good activity against *Chlamydia* and *Mycoplasma* has been noted: it is an alternative drug for nonspecific urethritis, cervicitis and atypical pneumonia. It also inhibits *M. tuberculosis*; can be used in place of ciprofloxacin. It is highly active against *M. leprae*: is being used in alternative multidrug therapy regimens.

Ofloxacin is relatively lipid soluble; oral bioavailability is high: attains higher plasma concentrations. Food does not interfere with its absorption. It is excreted largely unchanged in urine; dose needs to be reduced in renal failure.

Ofloxacin is comparable to ciprofloxacin in the therapy of systemic and mixed infections. It is particularly suitable for chronic bronchitis and other respiratory or ENT infections. Inhibition of theophylline metabolism is less marked.

Gonorrhoea has been treated with a single 200 mg dose. It is also useful in nongonococcal urethritis.

ZANOCIN, TARIVID 100, 200, 400 mg tab; 200 mg/100 ml i.v. infusion, ZENFLOX also 50 mg/5 ml susp.
ZANOCIN, OFLOX, EXOCIN 0.3% eye drops.

Levofloxacin It is the levoisomer of ofloxacin having improved activity against *Strep. pneumoniae* and some other gram-positive and gram-negative bacteria. Anaerobes are moderately susceptible. Oral bioavailability of levofloxacin is nearly 100%; oral and i.v. doses are similar. It is mainly excreted unchanged and a single daily dose is sufficient because of slower elimination.

Theophylline, warfarin, cyclosporine and zidovudine pharmacokinetics has been found to remain unchanged during levofloxacin treatment. The primary indication of levofloxacin is community acquired pneumonia and exacerbations of chronic bronchitis in which 87–96% cure rate has been obtained. High cure rates have been noted in sinusitis, enteric fevers, pyelonephritis and skin/soft tissue infections as well.

TAVANIC, GLEVO 500 mg tab, 500 mg/100 ml inj.

Lomefloxacin It is a second generation difluorinated quinolone, equal in activity to ciprofloxacin but more active against some gram-negative bacteria and chlamydia. Because of longer $t_{1/2}$ and persistence in tissues, it is suitable for single daily administration. It is primarily excreted unchanged in urine; dose needs to be reduced in renal insufficiency. Interaction with theophylline has not been noted, but warfarin levels are increased.

LOMEF-400, LOMEDON, LOMADAY 400 mg tab.
LOMIBACT, LOX 0.3% eye drops.

Sparfloxacin This second generation difluorinated quinolone has enhanced activity against gram-positive bacteria (especially *Strep. pneumoniae*, *Staphylococcus*, *Enterococcus*), *Bacteroides fragilis*, other anaerobes and mycobacteria. Its major indications include pneumonia, exacerbations of chronic bronchitis, sinusitis and other ENT infections. Reports suggest good efficacy in tuberculosis, MAC infection in AIDS patients and in leprosy. Also used for chlamydial infections. It does not alter the pharmacokinetics of theophylline and warfarin. However, it has caused a higher incidence of phototoxic reactions: recipients should be cautioned not to go out in the sun. Slight prolongation of QTc interval has been noted in 3% recipients; should be avoided in patients taking cisapride, tricyclic antidepressants, phenothiazines, class IA and class III antiarrhythmics, etc. Because of longer $t_{1/2}$ it is suitable for single daily dosing.

TOROSPAR 200, 400 mg tab; SPARTA, SPARQUIN, SPARDAC 100, 200 mg tab, ZOSPAR, SPARC, EYPAR 0.3% eye drops.

Gatifloxacin Another 2nd generation FQ that has excellent activity against *Strep. pneumoniae*, many atypical respiratory pathogens including *Chlamydia pneumoniae* and certain anaerobes. *M. tuberculosis* is also inhibited. A greater affinity for topoisomerase IV may be responsible for improved activity against gram-positive cocci. The major indication of gatifloxacin is community-acquired pneumonia, exacerbation of chronic bronchitis, and other upper/lower respiratory tract infections.

MYGAT 200, 400 mg tab, 400 mg/200 ml inj; GATIQUIN 200, 400 mg tab, GAITY 200, 400 mg tab, 400 mg/40 ml inj. GATICIN, GATIQUIN 0.3% eye drops.

Gatifloxacin has the potential to cause tachycardia and prolong QTc interval; contraindicated in hypokalaemia and with other drugs that can prolong QT. Phototoxicity, CNS effects and swelling over face are other side effects.

Changes in blood glucose level have been reported, and there is some risk of *Torsades de pointes*. It has been discontinued in USA, and is not available in the UK.

Moxifloxacin It is also a long-acting 2nd generation FQ having high activity against *Str. pneumoniae*, other gram-positive bacteria including β -lactam/macrolide resistant ones and some anaerobes. It is the most potent FQ against *M. tuberculosis*. Bacterial topoisomerase IV is the major target of action. Moxifloxacin is primarily used for pneumonias, bronchitis, sinusitis, otitis media, in which efficacy is comparable to β -lactam

antibiotics. However, it is not good for urinary tract infections. Side effects are similar to other FQs. It should not be given to patients predisposed to seizures and to those receiving proarrhythmic drugs, because it can prolong Q-T_c interval. Phototoxicity occurs only rarely.

Dose: 400 mg OD; MOXIF 400 mg tab; STAXOM 400 mg tab, 400 mg/250 ml i.v. infusion.

MOXICIP, MILFLOX 0.5% eye drops for conjunctivitis caused by gram-positive as well as negative bacteria.

CHAPTER 51

Beta-Lactam Antibiotics

These are antibiotics having a β -lactam ring. The two major groups are penicillins and cephalosporins. Monobactams and carbapenems are relatively newer additions.

PENICILLINS

Penicillin was the first antibiotic to be used clinically in 1941. It is a miracle that the least toxic drug of its kind was the first to be discovered. It was originally obtained from the fungus *Penicillium notatum*, but the present source is a high yielding mutant of *P. chrysogenum*.

Chemistry and properties The penicillin nucleus consists of fused thiazolidine and β -lactam rings to which side chains are attached through an amide linkage (Fig. 51.1). Penicillin G (PnG),

having a benzyl side chain at R (benzyl penicillin), is the original penicillin used clinically.

The side chain of natural penicillin can be split off by an amidase to produce 6-aminopenicillanic acid. Other side chains can then be attached to it resulting in different semisynthetic penicillins with unique antibacterial activities and different pharmacokinetic profiles.

At the carboxyl group attached to the thiazolidine ring, salt formation occurs with Na^+ and K^+ ; these salts are more stable than the parent acid. Sod. PnG is highly water soluble. It is stable in the dry state, but solution deteriorates rapidly at room temperature, though it remains stable at 4°C for 3 days. Therefore, PnG solutions are always prepared freshly. PnG is also thermolabile and acid labile.

Unitage 1 U of crystalline sod. benzyl penicillin = $0.6 \mu\text{g}$ of the standard preparation. Thus 1 g = 1.6 million units or 1 MU = 0.6 g.

Mechanism of action

All β -lactam antibiotics interfere with the synthesis of bacterial cell wall. The bacteria synthesize UDP-N-acetylmuramic acid pentapeptide, called 'Park nucleotide' (because Park in 1957 found it to accumulate when susceptible *Staphylococcus*

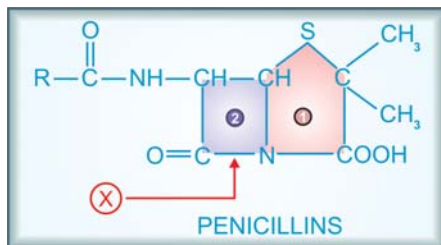

Fig. 51.1: Chemical structure of penicillins. (1) Thiazolidine ring; (2) β -lactam ring; (X) Bond which is broken by penicillinase.

was grown in the presence of penicillin) and UDP-N-acetyl glucosamine. The peptidoglycan residues are linked together forming long strands and UDP is split off. The final step is cleavage of the terminal D-alanine of the peptide chains by transpeptidases; the energy so released is utilized for establishment of cross linkages between peptide chains of the neighbouring strands (Fig. 51.2). This cross linking provides stability and rigidity to the cell wall.

The β -lactam antibiotics inhibit the transpeptidases so that cross linking (which maintains the close knit structure of the cell wall) does not take place. These enzymes and related proteins constitute the *penicillin binding proteins (PBPs)* which have been located in the bacterial cell membrane. Each organism has several PBPs and PBPs obtained from different species differ in their affinity towards different β -lactam antibiotics. This fact probably explains their differing sensitivity to the various β -lactam antibiotics.

When susceptible bacteria divide in the presence of a β -lactam antibiotic—cell wall deficient (CWD) forms are produced. Because the interior of the bacterium is hyperosmotic, the CWD forms swell and burst \rightarrow bacterial lysis. This is how β -lactam antibiotics exert bactericidal action. Under certain conditions and in case of certain organisms, bizarre shaped or filamentous forms, which are incapable of multiplying, result. Grown in hyperosmotic medium, globular 'giant' forms or *protoplasts* are produced. Lytic effect of these antibiotics may also be due to derepression of some bacterial autolysins which normally function during cell division.

Rapid cell wall synthesis occurs when the organisms are actively multiplying; β -lactam antibiotics are more lethal in this phase.

The peptidoglycan cell wall is unique to bacteria. No such substance is synthesized (particularly, D-alanine is not utilized) by higher animals. This is why penicillin is practically nontoxic to man.

In gram-positive bacteria, the cell wall is almost entirely made of peptidoglycan, which is

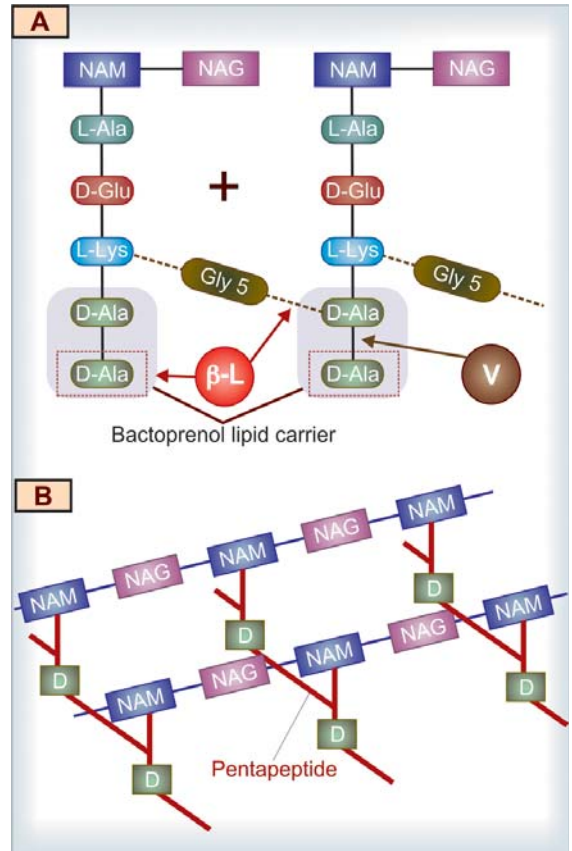

Fig. 51.2: Key features of bacterial cell wall synthesis and structure, depicting the site of action of β -lactam antibiotics and vancomycin.

- Cross linking of peptidoglycan residues of neighbouring strands by cleavage of terminal D-alanine (D-Ala/D) and transpeptidation with the chain of 5 glycine (Gly5) residues. The β -lactam antibiotics (β -L) block cleavage of terminal D-Ala and transpeptidation. The peptidoglycan units are synthesized within the bacterial cell and are transported across the cell membrane by attachment to a bactoprenol lipid carrier for assembly into strands. Vancomycin (V) binds tightly to the terminal D-Ala-D-Ala sequence and prevents its release from the carrier, so that further transpeptidation cannot take place.
- The highly cross linked peptidoglycan strands in bacterial cell wall

NAM—N-acetyl muramic acid;

NAG—N-acetylglucosamine; L-Ala—L-alanine; D-Glu—D-glutamic acid; L-Lys—L-Lysine

>50 layers thick and extensively cross linked, so that it may be regarded as a single giant mucopeptide molecule. In gram-negative bacteria, it consists of alternating layers of lipoprotein and peptidoglycan (each layer 1–2 molecule thick with little cross linking). This may be the reason for higher susceptibility of the gram-positive bacteria to PnG.

Blood, pus, and tissue fluids do not interfere with the antibacterial action of β -lactam antibiotics.

PENICILLIN-G (BENZYL PENICILLIN)

Antibacterial spectrum PnG is a narrow spectrum antibiotic; activity is limited primarily to gram-positive bacteria and few others.

Cocci: *Streptococci* (except *viridans*, group D or enterococci) are highly sensitive, so are many pneumococci. *Staph. aureus*, though originally very sensitive, has acquired resistance to such an extent that it must be counted out of PnG spectrum. Gram negative cocci—*Neisseria gonorrhoeae* and *N. meningitidis* are susceptible to PnG, though increasing number of gonococci have developed partial and others high degree resistance.

Bacilli: Gram-positive bacilli—majority of *B. anthracis*, *Corynebacterium diphtheriae*, and practically all *Clostridia* (*tetani* and others), *Listeria* are highly sensitive, so are spirochetes (*Treponema pallidum*, *Leptospira*, and others), but *Bacteroides fragilis* is largely resistant.

Actinomyces israelii is only moderately sensitive. Majority of gram-negative bacilli (except a few *E. coli*, *Proteus*), *Mycobacterium tuberculosis*, rickettsiae, chlamydiae, protozoa, fungi and viruses are totally insensitive to PnG.

Bacterial resistance Many bacteria are inherently insensitive to PnG because in them the target enzymes and PBPs are located deeper under lipoprotein barrier where PnG is unable to penetrate or have low affinity for PnG. The primary mechanism of acquired resistance is production of penicillinase.

Penicillinase It is a narrow spectrum β -lactamase which opens the β -lactam ring and inactivates PnG and some closely related congeners. Majority of *Staphylococci* and some strains of gonococci, *B. subtilis*, *E. coli*, *H. influenzae* and few other bacteria produce penicillinase. The gram-positive penicillinase producers elaborate large quantities of the enzyme which diffuses into the surroundings and can protect other inherently sensitive bacteria. In gram-negative bacteria, penicillinase is found in small quantity, but is strategically located inbetween the lipoprotein and peptidoglycan layers of the cell wall. Staphylococcal penicillinase is inducible, and methicillin is an important inducer; while in gram-negative organisms, it is mostly a constitutive enzyme.

Penicillinase has been successfully used to destroy PnG in patient's blood sample so that it does not interfere with bacterial growth when such blood is cultured.

Some resistant bacteria become *penicillin tolerant* and not penicillin destroying. Their target enzymes are altered to have low affinity for penicillin, e.g. highly resistant pneumococci isolated in some areas have altered PBPs. The methicillin-resistant *Staph. aureus* (MRSA) have acquired a PBP which has very low affinity for β -lactam antibiotics. Some penicillin resistant pneumococci and enterococci have altered PBPs. The low level penicillin-resistant gonococci are less permeable to the drug, while high degree resistant ones produce penicillinase, as do highly resistant *H. influenzae*. Both these appear to have acquired the penicillinase plasmid by conjugation or transduction and then propagated by selection.

The gram-negative bacteria have 'porin' channels formed by specific proteins located in their outer membrane. Permeability of various β -lactam antibiotics through these channels differs: ampicillin and other members which are active against gram-negative bacteria cross the porin channels much better than PnG. Some gram-negative bacteria become resistant by loss or alteration of porin channels.

Pharmacokinetics

Penicillin G is acid labile—destroyed by gastric acid. As such, less than 1/3rd of an oral dose is absorbed in the active form. Absorption of sod. PnG from i.m. site is rapid and complete; peak plasma level is attained in 30 min. It is distributed mainly extracellularly; reaches most body fluids, but penetration in serous cavities and CSF is poor. However, in the presence of inflammation (sinovitis, meningitis, etc.) adequate amounts may reach these sites. About 60% is plasma protein bound. It is little metabolized because of rapid excretion.

The pharmacokinetics of PnG is dominated by very rapid renal excretion; about 10% by glomerular filtration and the rest by tubular secretion. The plasma $t_{1/2}$ of PnG in healthy adult is 30 min. Neonates have slower tubular secretion— $t_{1/2}$ is longer; but approaches adult value at 3 months and then is even shorter during childhood. Aged and those with renal failure excrete penicillin slowly. Tubular secretion of PnG can be blocked by probenecid—higher and longer lasting plasma concentrations are achieved. Probenecid also decreases the volume of distribution of penicillins.

Preparations and dose

1. *Sod. penicillin G (crystalline penicillin) injection* 0.5–5 MU i.m./i.v. 6–12 hourly. It is available as dry powder in vials to be dissolved in sterile water at the time of injection. **BENZYL PEN 0.5, 1 MU inj.**

Repository penicillin G injections These are insoluble salts of PnG which must be given by deep i.m. (never i.v.) injection. They release PnG slowly at the site of injection, which then meets the same fate as soluble PnG.

1. *Procaine penicillin G inj.* 0.5–1 MU i.m. 12–24 hourly as aqueous suspension. Plasma concentrations attained are lower, but are sustained for 12–24 hours; **PROCAINE PENICILLIN-G 0.5, 1 MU dry powder in vial.**

Fortified procaine penicillin G inj: contains 3 lac U procaine penicillin and 1 lac U sod. penicillin G to provide rapid as well as sustained blood levels. **FORTIFIED P.P. INJ 3+1 lac U vial.**

2. *Benzathine penicillin G* 0.6–2.4 MU i.m. every 2–4 weeks as aqueous suspension. It releases penicillin

extremely slowly—plasma concentrations are very low but remain effective for prophylactic purposes for up to 4 weeks:

PENIDURE-LA (long acting), LONGACILLIN, PENCOM, 0.6, 1.2, 2.4 MU as dry powder in vial.

Adverse effects

Penicillin G is one of the most nontoxic antibiotics; up to 100 MU (60 g) has been injected in a day without any direct toxicity.

Local irritancy and direct toxicity Pain at i.m. injection site, nausea on oral ingestion and thrombophlebitis of injected vein are dose-related expressions of irritancy.

Toxicity to the brain may be manifested as mental confusion, muscular twitchings, convulsions and coma, when very large doses (> 20 MU) are injected i.v.; especially in patients with renal insufficiency. Bleeding has also occurred with such high doses due to interference with platelet function. Intrathecal injection of PnG is no longer recommended because it has caused arachnoiditis and degenerative changes in spinal cord.

Accidental i.v. injection of procaine penicillin produces CNS stimulation, hallucinations and convulsions due to procaine. Being insoluble, it may also cause microembolism.

Hypersensitivity These reactions are the major problem in the use of penicillins. An incidence of 1–10% is reported. Individuals with an allergic diathesis are more prone to develop penicillin reactions. PnG is the most common drug implicated in drug allergy, because of which it has practically vanished from use in general practice.

Frequent manifestations are—rash, itching, urticaria and fever. Wheezing, angioneurotic edema, serum sickness and exfoliative dermatitis are less common. Anaphylaxis is rare (1 to 4 per 10,000 patients) but may be fatal.

All forms of natural and semisynthetic penicillins can cause allergy, but it is more commonly seen after parenteral than oral administration. Incidence is highest with procaine penicillin: procaine is itself allergenic. The course of

penicillin hypersensitivity is unpredictable, i.e. an individual who tolerated penicillin earlier may show allergy on subsequent administration and *vice versa*.

There is partial cross sensitivity between different types of penicillins; an individual who has exhibited immediate type of hypersensitivity—urticaria, angioedema, bronchospasm, anaphylaxis or serum sickness with one penicillin should not be given any other type of penicillin. However, if the earlier reaction had been only a rash, penicillin may be given cautiously—often no untoward effect is seen. History of penicillin allergy must be elicited before injecting it. A scratch test or intradermal test (with 2–10 U) may be performed first. On occasions, this itself has caused fatal anaphylaxis. Testing with benzylpenicilloyl-polylysine is safer. However, a negative intradermal test does not rule out delayed hypersensitivity. It should also be realised that presence of antibodies to penicillin does not mean allergy to it, because practically everyone who receives penicillin develops antibodies to it.

For the development of antibodies, penicillin or a product of it (mostly penicilloyl moiety—major determinant) acts as a hapten. There are many minor determinants as well.

Topical use of penicillin is highly sensitizing (contact dermatitis and other reactions). Therefore, all topical preparations of penicillin (including eye ointment) have been banned, except for use in eye as freshly prepared solution in case of gonococcal ophthalmia.

If a patient is allergic to penicillin, it is best to use an alternative antibiotic. Hyposensitization by the injection of increasing amounts of penicillin intradermally at hourly intervals may be tried only if there is no other choice.

Superinfections These are rare with PnG because of its narrow spectrum; though bowel, respiratory and cutaneous microflora does undergo changes.

Jarisch-Herxheimer reaction Penicillin injected in a syphilitic patient (particularly secondary syphilis) may produce shivering, fever, myalgia, exacerbation of lesions, even vascular collapse. This is due to sudden release of spirochetal lytic products and lasts for 12–72 hours. It

does not recur and does not need interruption of therapy. Aspirin and sedation afford relief of symptoms.

Uses

Penicillin G is the drug of choice for infections caused by organisms susceptible to it, unless the patient is allergic to this antibiotic. However, use has declined very much due to fear of causing anaphylaxis.

1. **Streptococcal infections** Like pharyngitis, otitis media, scarlet fever, rheumatic fever respond to ordinary doses of PnG given for 7–10 days. For subacute bacterial endocarditis (SABE) caused by *Strep. viridans* or *faecalis* high doses (10–20 MU i.v. daily) along with gentamicin given for 2–6 weeks is needed.

2. **Pneumococcal infections** PnG is not used now for empirical therapy of pneumococcal (lobar) pneumonia and meningitis because many strains have become highly penicillin resistant. However, PnG 3–6 MU i.v. every 6 hours is the drug of choice if organism is sensitive.

3. **Meningococcal infections** are still mostly responsive; meningitis and other infections may be treated with intravenous injection of high doses.

4. **Gonorrhoea** PnG has become unreliable for treatment of gonorrhoea due to spread of resistant strains. For alternative regimens see Table 54.1.

The treatment of ophthalmia neonatorum due to sensitive *N. gonorrhoeae* consists of saline irrigation + sod. PnG 10,000–20,000 U/ml 1 drop in each eye every 1–3 hours. In severe cases, give 50,000 U i.m. BD for 1 week in addition.

5. **Syphilis** *T. pallidum* has not shown any resistance and PnG is the drug of choice. Early and latent syphilis is treated either with daily injection of 1.2 MU of procaine penicillin for 10 days or with 1–3 weekly doses of 2.4 MU benzathine penicillin. For late syphilis, benzathine penicillin 2.4 MU weekly for 4 weeks is recommended. Cardiovascular and neurosyphilis requires 5 MU i.m. 6 hourly of sod. PnG. for 2 weeks followed by the above regimen.

Leptospirosis: PnG 1.5 MU injected i.v. 6 hourly for 7 days is curative.

6. *Diphtheria* Antitoxin therapy is of prime importance. Procaine penicillin 1–2 MU daily for 10 days has adjuvant value and prevents carrier state.

7. *Tetanus and gas gangrene* Antitoxin and other measures are more important; PnG 6–12 MU/day is used to kill the causative organism and has adjuvant value.

8. Penicillin G is the drug of choice for rare infections like anthrax, actinomycosis, trench mouth, rat bite fever and those caused by *Listeria monocytogenes*, *Pasteurella multocida*.

9. *Prophylactic uses*

(a) Rheumatic fever: Low concentrations of penicillin prevent colonization by streptococci responsible for rheumatic fever. Benzathine penicillin 1.2 MU every 4 weeks till 18 years of age or 5 years after an attack, whichever is more.
(b) Bacterial endocarditis: Dental extractions, endoscopies, catheterization, etc. cause bacteraemia which in patients with valvular defects can cause endocarditis. PnG can afford protection, but amoxicillin is preferred now.

(c) Agranulocytosis patients: Penicillin may be used alone or in combination with an aminoglycoside antibiotic to prevent respiratory and other acute infections.

SEMISYNTHETIC PENICILLINS

Semisynthetic penicillins are produced by chemically combining specific side chains (in place of benzyl side chain of PnG) or by incorporating specific precursors in the mould cultures. Thus, procaine penicillin and benzathine penicillin are salts of PnG and *not* semisynthetic penicillins. The aim of producing semisynthetic penicillins has been to overcome the shortcomings of PnG, which are:

1. Poor oral efficacy.
2. Susceptibility to penicillinase.
3. Narrow spectrum of activity.

4. Hypersensitivity reactions (this has not been overcome in any preparation).

In addition, some β -lactamase inhibitors have been developed which themselves are not antibacterial, but augment the activity of penicillins against β -lactamase producing organisms.

CLASSIFICATION

1. *Acid-resistant alternative to penicillin G*
Phenoxymethyl penicillin (Penicillin V).
2. *Penicillinase-resistant penicillins* Methicillin, Cloxacillin.
3. *Extended spectrum penicillins*
 - (a) *Aminopenicillins*: Ampicillin, Bacampicillin, Amoxicillin.
 - (b) *Carboxypenicillins*: Carbenicillin, Ticarcillin.
 - (c) *Ureidopenicillins*: Piperacillin, Mezlocillin.

β -lactamase inhibitors Clavulanic acid
Sulbactam, Tazobactam

ACID-RESISTANT ALTERNATIVE TO PENICILLIN-G

Phenoxymethyl penicillin (Penicillin V)

It differs from PnG only in that it is acid stable. Oral absorption is better; peak blood level is reached in 1 hour and plasma $t_{1/2}$ is 30–60 min.

The antibacterial spectrum of penicillin V is identical to PnG, but it is about 1/5 as active against *Neisseria*, other gram negative bacteria and anaerobes. It cannot be depended upon for more serious infections and is used only for streptococcal pharyngitis, sinusitis, otitis media, prophylaxis of rheumatic fever (when an oral drug has to be selected), less serious pneumococcal infections and trench mouth.

Dose: 250–500 mg, infants 60 mg, children 125–250 mg; given 6 hourly, (250 mg = 4 lac U). **CRYSTAPEN-V**, **KAYPEN 125**, 250 mg tab, 125 mg/5 ml dry syr—for reconstitution, **PENIVORAL** 65, 130 mg tab.

PENICILLINASE-RESISTANT PENICILLINS

These congeners have side chains that protect the β -lactam ring from attack by staphylococcal

penicillinase. However, this also partially protects the bacteria from the β -lactam ring: nonpenicillinase producing organisms are less sensitive to these drugs than to PnG. Their only indication is infections caused by penicillinase producing *Staphylococci*, for which they are the drugs of choice except in areas where methicillin resistant *Staph. aureus* (MRSA) has become prevalent. These drugs are not resistant to gram-negative β -lactamases.

Methicillin It is highly penicillinase resistant but not acid resistant—must be injected. It is also an inducer of penicillinase production.

MRSA have emerged in many areas. These are insensitive to all penicillinase-resistant penicillins and to other β -lactams as well as to erythromycin, aminoglycosides, tetracyclines, etc. The MRSA have altered PBP_s which do not bind penicillins. The drug of choice for these organisms is vancomycin/linezolid, but ciprofloxacin can also be used.

Haematuria, albuminuria and reversible interstitial nephritis are the specific adverse effects of methicillin. It has been replaced by cloxacillin.

Cloxacillin It has an isoxazolyl side chain and is highly penicillinase as well as acid resistant. It is less active against PnG sensitive organisms: should not be used as its substitute. It is more active than methicillin against penicillinase producing *Staph*, but not against MRSA.

Cloxacillin is incompletely but dependably absorbed from oral route, especially if taken in empty stomach. It is >90% plasma protein bound. Elimination occurs primarily by kidney, also partly by liver. Plasma $t_{1/2}$ is about 1 hour.

Dose: 0.25–0.5 g orally every 6 hours; for severe infections 0.25–1 g may be injected i.m. or i.v.—higher blood levels are produced.

KLOX 0.25, 0.5 g cap, 125 mg/3 g dry syr, 0.25, 0.5 g inj; **BIOCLOX, CLOCILIN** 0.25, 0.5 g cap; 0.25, 0.5 g/vial inj.

Oxacillin, Dicloxacillin, Flucloxacillin (Floxacillin) are other isoxazolyl penicillins, similar to cloxacillin, but not marketed in India. Nafcillin is another parenteral penicillinase resistant penicillin.

EXTENDED SPECTRUM PENICILLINS

These semisynthetic penicillins are active against a variety of gram-negative bacilli as well. They

can be grouped according to their spectrum of activity.

1. Aminopenicillins

This group, led by ampicillin, has an amino substitution in the side chain. Some are prodrugs and all have quite similar antibacterial spectra. None is resistant to penicillinase or to other β -lactamases.

Ampicillin It is active against all organisms sensitive to PnG; in addition, many gram-negative bacilli, e.g. *H. influenzae*, *E. coli*, *Proteus*, *Salmonella* and *Shigella* are inhibited. However, due to widespread use, many of these have developed resistance; usefulness of this antibiotic has decreased considerably.

Ampicillin is more active than PnG for *Strep. viridans* and enterococci; equally active for pneumococci, gonococci and meningococci (penicillin-resistant strains are resistant to ampicillin as well); but less active against other gram-positive cocci. Penicillinase producing *Staph.* are not affected, as are other gram-negative bacilli, such as *Pseudomonas*, *Klebsiella*, indole positive *Proteus* and anaerobes like *Bacteroides fragilis*.

Pharmacokinetics Ampicillin is not degraded by gastric acid; oral absorption is incomplete but adequate. Food interferes with absorption. It is partly excreted in bile and reabsorbed—enterohepatic circulation occurs. However, primary channel of excretion is kidney, but tubular secretion is slower than for PnG; plasma $t_{1/2}$ is 1 hr.

Dose: 0.5–2 g oral/i.m./i.v. depending on severity of infection, every 6 hours; children 25–50 mg/kg/day.

AMPILIN, ROSCILLIN, BIOCILIN 250, 500 mg cap; 125, 250 mg/5 ml dry syr; 100 mg/ml pediatric drops; 250, 500 mg and 1.0 g per vial inj.

Uses

1. Urinary tract infections: Ampicillin has been the drug of choice for most acute infections, but resistance has increased and fluoroquinolones/cotrimoxazole are now more commonly used for empirical therapy.

2. Respiratory tract infections: including bronchitis, sinusitis, otitis media, etc. are usually treated with ampicillin, but higher doses (50–80 mg/kg/day) are generally required now.

3. Meningitis: Ampicillin has been a first line drug, but a significant number of meningococci, pneumococci and *H. influenzae* are now resistant. It is usually combined with a third generation cephalosporin/chloramphenicol for empirical therapy.

4. Gonorrhoea: It is one of the first line drugs for oral treatment of nonpenicillinase producing gonococcal infections. A single dose of 3.5 g ampicillin + 1 g probenecid (**ROSCIND, DYNACIL-PRB cap**) is adequate and convenient for urethritis.

5. Typhoid fever: Due to emergence of resistance it is now rarely used when other first line drugs cannot be given. It is less efficacious than ciprofloxacin in eradicating carrier state.

Salmonella diarrhoeas should usually not be treated with antimicrobials, including ampicillin.

6. Bacillary dysentery: due to *Shigella* often responds to ampicillin, but many strains are now resistant; quinolones are preferred.

7. Cholecystitis: Ampicillin is a good drug because high concentrations are attained in bile.

8. Subacute bacterial endocarditis: Ampicillin 2 g i.v. 6 hourly is used in place of PnG. Concurrent gentamicin is advocated.

9. Septicaemias and mixed infections: Injected ampicillin may be combined with gentamicin or one of the third generation cephalosporins.

Adverse effects Diarrhoea is frequent after oral administration. Ampicillin is incompletely absorbed—the unabsorbed drug irritates the lower intestines as well as causes marked alteration of bacterial flora.

It produces a high incidence (up to 10%) of rashes, especially in patients with AIDS, EB virus infections or lymphatic leukaemia. Concurrent administration of allopurinol also increases the incidence of rashes. Sometimes the rashes may not be allergic, but toxic in nature.

Patients with a history of immediate type of hypersensitivity to PnG should not be given ampicillin as well.

Interactions Hydrocortisone inactivates ampicillin if mixed in the i.v. solution.

By inhibiting colonic flora, it may interfere with deconjugation and enterohepatic cycling of oral contraceptives → failure of oral contraception. Probenecid retards renal excretion of ampicillin.

Bacampicillin It is an ester prodrug of ampicillin which is nearly completely absorbed from the g.i.t.; and is largely hydrolysed during absorption. Thus, higher plasma levels are attained. Tissue penetration is also claimed to be better. It does not markedly disturb intestinal ecology—incidence of diarrhoea is claimed to be lower.

Dose: 400–800 mg BD; **PENGLOBE 200, 400 mg tab.**

Talampicillin, Pivampicillin, Hetacillin are other prodrugs of ampicillin.

Note: A fixed dose combination of ampicillin + cloxacillin (**AMPILOX and others**) containing 250 mg of each per cap or per vial for injection is vigorously promoted for postoperative, skin and soft tissue, respiratory, urinary and other infections. This combination is not synergistic since cloxacillin is not active against gram-negative bacteria, while ampicillin is not active against staphylococci. Since mixed staphylococcal and gram-negative bacillary infections are uncommon, for any given infection, one of the components is useless but adds to the cost and adverse effects. Since the amount of the drug which is actually going to act in any individual patient is halved (when the combination is used), efficacy is reduced and chances of selecting resistant strains are increased. Both drugs are ineffective against MRSA. Blind therapy with this combination is irrational and harmful.

Amoxicillin It is a close congener of ampicillin (but not a prodrug); similar to it in all respects except:

- Oral absorption is better; food does not interfere with absorption; higher and more sustained blood levels are produced.
- Incidence of diarrhoea is lower.
- It is less active against *Shigella* and *H. influenzae*.

Many physicians now prefer it over ampicillin for bronchitis, urinary infections, SABC and gonorrhoea.

Dose: 0.25–1 g TDS oral/i.m.; **AMOXYLIN, NOVAMOX, SYNAMOX 250, 500 mg cap, 125 mg/5 ml dry syr. AMOXIL, MOX 250, 500 mg caps; 125 mg/5 ml dry syr; 250, 500 mg/vial inj. MOXYLONG: Amoxicillin 250 mg + probenecid 500 mg tab (also 500 mg + 500 mg DS tab).**

2. Carboxypenicillins

Carbenicillin The special feature of this penicillin congener is its activity against *Pseudomonas aeruginosa* and indole positive *Proteus* which are not inhibited by PnG or aminopenicillins. It is less active against *Salmonella*, *E. coli* and *Enterobacter*, while *Klebsiella* and gram-positive cocci are unaffected by it. *Pseudomonas* strains less sensitive to carbenicillin have developed in some areas, especially when inadequate doses have been used.

Carbenicillin is neither penicillinase-resistant nor acid resistant. It is inactive orally and is excreted rapidly in urine ($t_{1/2}$ 1 hr). It is used as sodium salt in a dose of 1–2 g i.m. or 1–5 g i.v. every 4–6 hours. At the higher doses, enough Na may be administered to cause fluid retention and CHF in patients with borderline renal or cardiac function.

High doses have also caused bleeding by interfering with platelet function. This appears to result from perturbation of agonist receptors on platelet surface.

PYOPEN, CARBELIN 1 g, 5 g, per vial inj.

The indications for carbenicillin are—serious infections caused by *Pseudomonas* or *Proteus*, e.g. burns, urinary tract infection, septicaemia, but piperacillin is now preferred. It may be used together with gentamicin, but the two should not be mixed in the same syringe.

Ticarcillin It is more potent than carbenicillin against *Pseudomonas*, but other properties are similar to it.

3. Ureidopenicillins

Piperacillin This antipseudomonal penicillin is about 8 times more active than carbenicillin. It has good activity against *Klebsiella* and is used mainly in neutropenic/immunocompromised patients having serious gram-negative infections, and in burns. Elimination $t_{1/2}$ is 1 hr. Concurrent use of gentamicin or tobramycin is advised.

Dose: 100–150 mg/kg/day in 3 divided doses (max 16 g/day) i.m. or i.v. The i.v. route is preferred when > 2 g is to be injected.

PIRAPEN 1 g, 2 g vials; **PIPRACIL** 2 g, 4 g vials for inj; contains 2 mEq Na⁺ per g.

Mezlocillin It has activity similar to ticarcillin against *Pseudomonas* and inhibits *Klebsiella* as well. It is given parenterally primarily for infections caused by enteric bacilli.

BETA-LACTAMASE INHIBITORS

β -lactamases are a family of enzymes produced by many gram-positive and gram-negative bacteria that inactivate β -lactam antibiotics by opening the β -lactam ring. Different β -lactamases differ in their substrate affinities. Three inhibitors of this enzyme *clavulanic acid*, *sulbactam* and *tazobactam* are available for clinical use.

Clavulanic acid Obtained from *Streptomyces clavuligerus*, it has a β -lactam ring but no antibacterial activity of its own. It inhibits a wide variety (class II to class V) of β -lactamases (but not class I cephalosporinase) produced by both gram-positive and gram-negative bacteria.

Clavulanic acid is a 'progressive' inhibitor: binding with β -lactamase is reversible initially, but becomes covalent later—inhibition increasing with time. Called a 'suicide' inhibitor, it gets inactivated after binding to the enzyme. It permeates the outer layers of the cell wall of gram-negative bacteria and inhibits the periplasmically located β -lactamase.

Pharmacokinetics Clavulanic acid has rapid oral absorption and a bioavailability of 60%; can also be injected. Its elimination $t_{1/2}$ of 1 hr and tissue distribution matches amoxicillin with which it is used (called coamoxiclav). However, it is eliminated mainly by glomerular filtration and its excretion is not affected by probenecid. Also, it is largely hydrolysed and decarboxylated before excretion, while amoxicillin is primarily excreted unchanged by tubular secretion.

Uses Addition of clavulanic acid re-establishes the activity of amoxicillin against β -lactamase producing resistant *Staph. aureus* (but not MRSA that have altered PBPs), *H. influenzae*, *N. gonorrhoeae*, *E. coli*, *Proteus*, *Klebsiella*, *Salmonella* and *Shigella*. *Bact. fragilis* and *Branhamella catarrhalis* are not responsive to amoxicillin alone,

but are inhibited by the combination. Amoxicillin sensitive strains are not affected by the addition of clavulanic acid. Coamoxiclav is indicated for:

- Skin and soft tissue infections, intra-abdominal and gynaecological sepsis, urinary, biliary and respiratory tract infections: especially when empiric antibiotic therapy is to be given for hospital acquired infections.
- Gonorrhoea (including PPNG) single dose amoxicillin 3 g + clavulanic acid 0.5 g + probenecid 1 g is highly curative.

AUGMENTIN, ENHANCIN, AMONATE: Amoxicillin 250 mg + clavulanic acid 125 mg tab; also 500 mg + 125 mg tab; 125 mg + 31.5 mg per 5 ml dry syr; **CLAVAM** 250 + 125 mg tab, 500 + 125 mg tab, 875 + 125 mg tab, 125 mg + 32 mg per 5 ml dry syr, 1–2 tab TDS.

Also **AUGMENTIN, CLAVAM:** Amoxicillin 1 g + clavulanic acid 0.2 g vial and 0.5 g + 0.1 g vial; inject 1 vial deep i.m. or i.v. 6–8 hourly for severe infections.

It is more expensive than amoxicillin alone.

Adverse effects are the same as for amoxicillin alone; g.i. tolerance is poorer—especially in children. Other side effects are *Candida* stomatitis/vaginitis and rashes. Some cases of hepatic injury have been reported with the combination.

Sulbactam It is a semisynthetic β -lactamase inhibitor, related chemically as well as in activity to clavulanic acid. It is also a progressive inhibitor, highly active against class II to V but poorly active against class I β -lactamase. On weight basis, it is 2–3 times less potent than clavulanic acid for most types of the enzyme, but the same level of inhibition can be obtained at the higher concentrations achieved clinically. Sulbactam does not induce chromosomal β -lactamases, while clavulanic acid can induce some of them.

Oral absorption of sulbactam is inconsistent. Therefore, it is preferably given parenterally. It has been combined with ampicillin for use against β -lactamase producing resistant strains. Absorption of its complex salt with ampicillin—*sultamicillin tosylate* is better, which is given orally. Indications are:

- PPNG gonorrhoea; sulbactam *per se* inhibits *N. gonorrhoeae*.

- Mixed aerobic-anaerobic infections, intra-abdominal, gynaecological, surgical and skin/soft tissue infections, especially those acquired in the hospital.

SULBACIN, AMPITUM: Ampicillin 1 g + sulbactam 0.5 g per vial inj; 1–2 vial deep i.m. or i.v. injection 6–8 hourly. Sultamicillin tosylate: **BETAMPORAL, SULBACIN** 375 mg tab.

Pain at site of injection, thrombophlebitis of injected vein, rash and diarrhoea are the main adverse effects.

Tazobactam is another β -lactamase inhibitor similar to sulbactam. Its pharmacokinetics matches with piperacillin with which it has been combined for use in severe infections like peritonitis, pelvic/urinary/respiratory infections caused by β -lactamase producing bacilli. However, the combination is not active against piperacillin-resistant *Pseudomonas*, because tazobactam (like clavulanic acid and sulbactam) does not inhibit inducible chromosomal β -lactamase produced by Enterobacteriaceae. It is also of no help against *Pseudomonas* that develop resistance by losing permeability to piperacillin.

Dose: 0.5 combined with piperacillin 4 g injected i.v. over 30 min 8 hourly.

PYBACTUM, TAZACT, TAZOBID, ZOSYN 4 g + 0.5 g vial for inj.

CEPHALOSPORINS

These are a group of semisynthetic antibiotics derived from 'cephalosporin-C' obtained from a fungus *Cephalosporium*. They are chemically related to penicillins; the nucleus consists of a β -lactam ring fused to a dihydrothiazine ring, (7-aminocephalosporanic acid). By addition of different side chains at position 7 of β -lactam ring (altering spectrum of activity) and at position 3 of dihydrothiazine ring (affecting pharmacokinetics), a large number of semisynthetic compounds have been produced. These have been conventionally divided into 4 generations. This division has a chronological sequence of development, but more importantly, takes into consideration the overall antibacterial spectrum as well as potency.

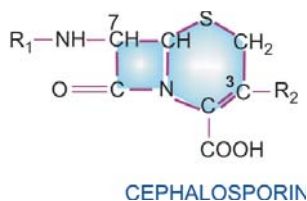

First generation cephalosporins	
<i>Parenteral</i>	<i>Oral</i>
Cephalothin*	Cephalexin
Cefazolin	Cephadrine
	Cefadroxil
Second generation cephalosporins	
<i>Parenteral</i>	<i>Oral</i>
Cefuroxime	Cefaclor
Cefoxitin*	Cefuroxime axetil
Third generation cephalosporins	
<i>Parenteral</i>	<i>Oral</i>
Cefotaxime	Cefixime
Ceftizoxime	Cefpodoxime proxetil
Ceftriaxone	Cefdinir
Ceftazidime	Ceftibuten
Cefoperazone	Ceftamet pivoxil
Fourth generation cephalosporins	
<i>Parenteral</i>	
Cefepime	
Cefpirome	

*Not available in India

All cephalosporins are bactericidal and have the same mechanism of action as penicillin, i.e. inhibition of bacterial cell wall synthesis. However, they bind to different proteins than those which bind penicillins. This may explain differences in spectrum, potency and lack of cross resistance.

Acquired resistance to cephalosporins could have the same basis as for penicillins, i.e.:

- alteration in target proteins (PBPs) reducing affinity for the antibiotic.
- impermeability to the antibiotic or its efflux so that it does not reach its site of action.

- elaboration of β -lactamases which destroy specific cephalosporins (cephalosporinases).

Though the incidence is low, resistance has been developed by some organisms, even against the third generation compounds. Individual cephalosporins differ in their:

- Antibacterial spectrum and relative potency against specific organisms.
- Susceptibility to β -lactamases elaborated by different organisms.
- Pharmacokinetic properties—many have to be injected, some are oral; majority are not metabolized, and are excreted rapidly by the kidney; have short $t_{1/2}$ s, probenecid inhibits their tubular secretion.
- Local irritancy on i.m. injection; few cannot be injected i.m.

FIRST GENERATION CEPHALOSPORINS

These were developed in the 1960s, have high activity against gram-positive but weaker against gram-negative bacteria.

Cefazolin This prototype first generation cephalosporin is active against most PnG sensitive organisms, i.e. *Streptococci* (*pyogenes* as well as *viridans*), gonococci, meningococci, *C. diphtheriae*, *H. influenzae*, clostridia and *Actinomyces*. Activity against *Klebsiella* and *E. coli* is relatively high, but it is quite susceptible to staphylococcal β -lactamase. It can be given i.m. (less painful) as well as i.v. and has a longer $t_{1/2}$ (2 hours) due to slower tubular secretion; attains higher concentration in plasma and in bile. It is the preferred parenteral first generation cephalosporin, especially for surgical prophylaxis.

Dose: 0.25 g 8 hourly (mild cases), 1 g 6 hourly (severe cases) i.m. or i.v.

ALCIZON, ORIZOLIN 0.25 g, 0.5 g, 1 g per vial inj.

Cephalexin It is an orally effective first generation cephalosporin, similar in spectrum to cefazolin, but less active against penicillinase producing *Staphylococci* and *H. influenzae*. It is little bound to plasma proteins, attains high concentration in bile and is excreted unchanged

in urine; $t_{1/2}$ ~60 min. It is one of the most commonly used cephalosporins.

Dose: 0.25–1 g 6–8 hourly (children 25–100 mg/kg/day).
CEPHACILLIN 250, 500 mg cap; **SPORIDEX**,
ALCEPHIN, **CEPHAXIN** 250, 500 mg cap, 125 mg/5 ml
 dry syr., 100 mg/ml pediatric drops.

ALCEPHIN-LA: Cephalexin + probenecid (250 + 250 mg
 and 500 + 500 mg) tabs.

Cephadrine Another orally active drug, almost identical to cephalexin, but less active against some organisms. Oral administration has caused diarrhoea as side effect. It is available for parenteral use also.

Dose: 0.25–1 g 6–12 hourly oral/i.m./i.v.

CEFLAD 0.25, 0.5, 1 g per vial inj.

Cefadroxil A close congener of cephalexin; has good tissue penetration—exerts more sustained action at the site of infection; can be given 12 hourly despite a $t_{1/2}$ of 1 hr. It is excreted unchanged in urine, but dose need be reduced only if creatinine clearance is < 50 ml/min. The antibacterial activity of cefadroxil and indications are similar to those of cephalexin.

Dose: 0.5–1 g BD. **DROXYL** 0.5, 1 g tab, 250 mg/5 ml syr;
CEFADROX 0.5 g cap, 125 mg/5 ml syr and 250 mg kid
 tab; **KEFLOXIN** 0.5 g cap, 0.25 g Distab, 125 mg/5 ml
 susp.

SECOND GENERATION CEPHALOSPORINS

These were developed subsequent to the first generation compounds and are more active against gram-negative organisms, with some members active against anaerobes, but none inhibits *P. aeruginosa*. Clinically, they have been largely replaced by the 3rd generation agents that are more active.

Cefuroxime It is resistant to gram-negative β -lactamases: has high activity against organisms producing these enzymes including PPNG and ampicillin-resistant *H. influenzae*, while retaining significant activity on gram-positive cocci and certain anaerobes. It is well tolerated by i.m. route and attains relatively higher CSF levels, but has been superseded by 3rd generation cephalosporins in the treatment of meningitis. It has been

employed for single dose i.m. therapy of gonorrhoea due to PPNG.

CEFOGEN, **SUPACEF**, **FUROXIL** 250 mg and 750 mg/
 vial inj; 0.75–1.5 g i.m. or i.v. 8 hourly, children 30–100
 mg/kg/day.

Cefuroxime axetil This ester of cefuroxime is effective orally, though absorption is incomplete. The activity depends on *in vivo* hydrolysis and release of cefuroxime.

Dose: 250–500 mg BD, children half dose; **CEFTUM**,
SPIZEF 125, 250, 500 mg captab and 125 mg/5 ml susp.

Cefaclor It retains significant activity by the oral route and is more active than the first generation compounds against *H. influenzae*, *E. coli* and *Pr. mirabilis*.

Dose: 0.25–1.0 g 8 hourly

KEFLOR, **VERCEF**, **DISTAFLOR** 250 mg cap, 125 and
 250 mg distab, 125 mg/5 ml dry syr, 50 mg/ml ped.
 drops.

THIRD GENERATION CEPHALOSPORINS

These compounds introduced in the 1980s have highly augmented activity against gram-negative Enterobacteriaceae; some inhibit *Pseudomonas* as well. All are highly resistant to β -lactamases from gram-negative bacteria. However, they are less active on gram-positive cocci and anaerobes.

Cefotaxime It is the prototype of the third generation cephalosporins; exerts potent action on aerobic gram-negative as well as some gram-positive bacteria, but is not active on anaerobes (particularly *Bact. fragilis*), *Staph. aureus* and *Ps. aeruginosa*. Prominent indications are meningitis caused by gram-negative bacilli (attains relatively high CSF levels), life-threatening resistant/hospital-acquired infections, septicaemias and infections in immunocompromised patients. It is also utilized for single dose therapy (1 g i.m. + 1 g probenecid oral) of PPNG urethritis, but is not dependable for *Pseudomonas* infections.

Cefotaxime is deacetylated in the body; the metabolite exerts weaker but synergistic action with the parent drug. The plasma $t_{1/2}$ of cefotaxime is 1 hr, but is longer for the deacetylated metabolite—permitting 12 hourly doses in many situations.

Dose: 1–2 g i.m./i.v. 8–12 hourly, children 50–100 mg/kg/day.

OMNATAX, ORITAXIM, CLAFORAN 0.25, 0.5, 1.0 g per vial inj.

Ceftizoxime It is similar in antibacterial activity and indications to cefotaxime, but inhibits *B. fragilis* also. It is not metabolized—excreted by the kidney at a slower rate; $t_{1/2}$ 1.5–2 hr.

Dose: 0.5–2.0 g i.m./i.v. 8 or 12 hourly.

CEFIZOX, EPOCELIN 0.5 and 1 g per vial inj.

Ceftriaxone The distinguishing feature of this cephalosporin is its longer duration of action ($t_{1/2}$ 8 hr), permitting once, or at the most twice daily dosing. Penetration into CSF is good and elimination occurs equally in urine and bile.

Ceftriaxone has shown high efficacy in a wide range of serious infections including bacterial meningitis (especially in children), multiresistant typhoid fever, complicated urinary tract infections, abdominal sepsis and septicaemias. A single dose of 250 mg i.m. has proven curative in gonorrhoea including PPNG, and in chancroid.

Hypoprothrombinaemia and bleeding are specific adverse effects. Haemolysis is reported.

OFRAMAX, MONOCEF, MONOTAX 0.25, 0.5, 1.0 g per vial inj.

For skin/soft tissue/urinary infections: 1–2 g i.v. or i.m./day.

Meningitis: 4 g followed by 2 g i.v. (children 75–100 mg/kg) once daily for 7–10 days.

Typhoid: 4 g i.v. daily \times 2 days followed by 2 g/day (children 75 mg/kg) till 2 days after fever subsides.

Ceftazidime The most prominent feature of this third generation cephalosporin is its high activity against *Pseudomonas*. It has been specifically used in febrile neutropenic patients with haematological malignancies, burn, etc. Its activity against Enterobacteriaceae is similar to that of cefotaxime, but it is less active on *Staph. aureus*, other gram positive cocci and anaerobes like *Bact. fragilis*. Its plasma $t_{1/2}$ is 1.5–1.8 hr.

Neutropenia, thrombocytopenia, rise in plasma transaminases and blood urea have been reported.

Dose: 0.5–2 g i.m. or i.v. every 8 hr, children 30 mg/kg/day. Resistant typhoid 30 mg/kg/day.

FORTUM, CEFAZID, ORZID 0.25, 0.5 and 1 g per vial inj.

Cefoperazone Like ceftazidime, it differs from other third generation compounds in having stronger activity on *Pseudomonas* and weaker activity on other organisms. It is good for *S. typhi* and *B. fragilis* also, but more susceptible to β -lactamases. The indications are—severe urinary, biliary, respiratory, skin-soft tissue infections, meningitis and septicaemias. It is primarily excreted in bile; $t_{1/2}$ is 2 hr. It has hypoprothrombinaemic action but does not affect platelet function. A disulfiram-like reaction with alcohol has been reported.

Dose: 1–3 g i.m./i.v. 8–12 hourly.

MAGNAMYCIN 0.25 g, 1, 2 g inj; CEFOMYCIN, NEGAPLUS 1 g inj.

Cefixime It is an orally active third generation cephalosporin highly active against Enterobacteriaceae, *H. influenzae* and is resistant to many β -lactamases. However, it is not active on *Staph. aureus*, most pneumococci and *Pseudomonas*. It is longer acting ($t_{1/2}$ 3 hr) and has been used in a dose of 200–400 mg BD for respiratory, urinary and biliary infections. Stool changes and diarrhoea are the most prominent side effects.

TOPCEF, ORFIX 100, 200 mg tab/cap, CEFSPAN 100 mg cap, 100 mg/5 ml syr.

Cefpodoxime proxetil It is the orally active ester prodrug of 3rd generation cephalosporin cefpodoxime. In addition to being highly active against Enterobacteriaceae and streptococci, it inhibits *Staph. aureus*. It is used mainly for respiratory, urinary, skin and soft tissue infections.

Dose: 200 mg BD (max 800 mg/day)

CEFOPROX 100, 200 mg tab, 100 mg/5 ml dry syr; CEPODEM 100, 200 mg tab, 50 mg/5 ml susp.

Cefdinir This orally active 3rd generation cephalosporin has good activity against many β lactamase producing organisms. Most respiratory pathogens including gram-positive cocci are susceptible. Its indications are pneumonia, acute exacerbations of chronic bronchitis, ENT and skin infections.

Dose: 300 mg BD

SEFDIN, ADCEF 300 mg cap, 125 mg/5 ml susp.

Ceftibuten Another oral 3rd generation cephalosporin, active against both gram-positive

and gram-negative bacteria, but not pneumococci and *Staph. aureus* and stable to β -lactamases. It is indicated in respiratory, urinary and gastrointestinal infections; $t_{1/2}$ 2–3 hours.

Dose: 200 mg BD or 400 mg OD.

PROCADAX 400 mg cap, 90 mg/5 ml powder for oral suspension.

Ceftamet pivoxil This ester prodrug of ceftamet, a 3rd generation cephalosporin has high activity against gram-negative bacteria, especially Enterobacteriaceae and *N. gonorrhoea*; used in respiratory, skin-soft tissue infections, etc.

Dose: 500 mg BD-TDS.

ALTAMET 250 tab; **CEPIME-O** 500 mg tab.

FOURTH GENERATION CEPHALOSPORINS

Cefepime Developed in 1990s, this 4th generation cephalosporin has antibacterial spectrum similar to that of 3rd generation compounds, but is highly resistant to β -lactamases, hence active against many bacteria resistant to the earlier drugs. *Ps. aeruginosa* and *Staph. aureus* are also inhibited. Due to high potency and extended spectrum, it is effective in many serious infections like hospital-acquired pneumonia, febrile neutropenia, bacteraemia, septicaemia, etc.

Dose: 1–2 g (50 mg/kg) i.v. 8–12 hourly.

KEFAGE, CEFICAD, CEPIME 0.5, 1.0 g inj.

Cefpirome This 4th generation cephalosporin is indicated for the treatment of serious and resistant hospital-acquired infections including septicaemias, lower respiratory tract infections, etc. Its zwitterion character permits better penetration through porin channels of gram-negative bacteria. It is resistant to many β -lactamases; inhibits type 1 β -lactamase producing Enterobacteriaceae and it is more potent against gram-positive and some gram-negative bacteria than the 3rd generation compounds.

Dose: 1–2 g i.m./i.v. 12 hourly;

CEFROM, CEFORTH 1 g inj; **BACIROM, CEFOR** 0.25, 0.5, 1.0 g inj.

Adverse effects

Cephalosporins are generally well tolerated, but are more toxic than penicillin.

1. *Pain* after i.m. injection occurs with many. This is so severe with cephalothin as to interdict i.m. route, but many others can be injected i.m. (see individual compounds). Thrombophlebitis of injected vein can occur.

2. *Diarrhoea* due to alteration of gut ecology or irritative effect is more common with oral cephadrine and parenteral cefoperazone (it is significantly excreted in bile).

3. *Hypersensitivity reactions* caused by cephalosporins are similar to penicillin, but incidence is lower. Rashes are the most frequent manifestation, but anaphylaxis, angioedema, asthma and urticaria have also occurred. About 10% patients allergic to penicillin show cross reactivity with cephalosporins. Those with a history of immediate type of reactions to penicillin should better not be given a cephalosporin. Skin tests for sensitivity to cephalosporins are unreliable.

A positive Coombs' test occurs in many, but haemolysis is rare.

4. *Nephrotoxicity* is highest with cephaloridine, which consequently has been withdrawn. Cephalothin and a few others have low-grade nephrotoxicity which may be accentuated by preexisting renal disease, concurrent administration of an aminoglycoside or loop diuretic.

5. *Bleeding* occurs with cephalosporins having a methylthiotetrazole or similar substitution at position 3 (cefoperazone, ceftriaxone). This is due to hypoprothrombinaemia caused by the same mechanism as warfarin and is more common in patients with cancer, intra-abdominal infection or renal failure.

6. Neutropenia and thrombocytopenia are rare adverse effects reported with ceftazidime and some others.

7. A disulfiram-like interaction with alcohol has been reported with cefoperazone.

Uses

Cephalosporins are now extensively used antibiotics. Their indications are:

1. As alternatives to PnG; particularly in allergic patients (but not who had anaphylactic reaction); one of the first generation compounds may be used.
2. Respiratory, urinary and soft tissue infections caused by gram-negative organisms, especially *Klebsiella*, *Proteus*, *Enterobacter*, *Serratia*. Cephalosporins preferred for these infections are cefuroxime, cefotaxime, ceftriaxone.
3. Penicillinase producing staphylococcal infections.
4. Septicaemias caused by gram-negative organisms: an aminoglycoside may be combined with a cephalosporin.
5. Surgical prophylaxis: the first generation cephalosporins are popular drugs. Cefazolin (i.m. or i.v.) is employed for most types of surgeries including those with surgical prosthesis such as artificial heart valves, artificial joints, etc.
6. Meningitis: Optimal therapy of pyogenic meningitis requires bactericidal activity in the CSF, preferably with antibiotic concentrations several times higher than the MBC for the infecting organism. For empirical therapy before bacterial diagnosis, i.v. cefotaxime/ceftriaxone is generally combined with ampicillin or vancomycin. Ceftazidime + gentamicin is the most effective therapy for *Pseudomonas* meningitis.
7. Gonorrhoea caused by penicillinase producing organisms: ceftriaxone is a first choice drug for single dose therapy of gonorrhoea if the penicillinase producing status of the organism is not known. Cefuroxime and cefotaxime have also been used for this purpose. For chancroid also, a single dose is as effective as erythromycin given for 7 days.
8. Typhoid: Currently, ceftriaxone and cefoperazone injected i.v. are the fastest acting and most reliable drugs for enteric fever. They are an alternative to fluoroquinolones (especially in children) for empirical therapy, since many *S. typhi* strains are resistant to chloramphenicol, ampicillin and cotrimoxazole.
9. Mixed aerobic-anaerobic infections in cancer patients, those undergoing colorectal surgery,

obstetric complications: cefuroxime, cefaclor or one of the third generation compounds is used.

10. Hospital acquired infections resistant to commonly used antibiotics: cefotaxime, ceftizoxime or a fourth generation drug may work.

11. Prophylaxis and treatment of infections in neutropenic patients: ceftazidime or another third generation compound, alone or in combination with an aminoglycoside.

MONOBACTAMS

Aztreonam It is a novel β -lactam antibiotic in which the other ring is missing (hence monobactam). It inhibits gram-negative enteric bacilli and *H. influenzae* at very low concentrations and *Pseudomonas* at moderate concentrations, but does not inhibit gram-positive cocci or faecal anaerobes. Thus, it is a β -lactam antibiotic with a spectrum resembling aminoglycosides. It is resistant to gram-negative β -lactamases. The main indications of aztreonam are hospital-acquired infections originating from urinary, biliary, gastrointestinal and female genital tracts.

Lack of cross sensitivity with other β -lactam antibiotics except possibly ceftazidime is the most prominent feature of aztreonam: permitting its use in patients allergic to penicillins or cephalosporins. Rashes and rise in serum aminotransferases are the notable adverse effects. It is eliminated in urine with a $t_{1/2}$ of 1.8 hr.

Dose: 0.5–2 g i.m. or i.v. 6–12 hourly.

AZENAM, TREZAM 0.5, 1.0, 2.0 g/vial inj.

CARBAPENEMS

Imipenem It is an extremely potent and broad-spectrum β -lactam antibiotic whose range of activity includes gram-positive cocci, Enterobacteriaceae, *Ps. aeruginosa*, *Listeria* as well as anaerobes like *Bact. fragilis* and *Cl. difficile*. It is resistant to most β -lactamases; inhibits penicillinase producing staphylococci and some MRSA.

A limiting feature of imipenem is its rapid hydrolysis by the enzyme dehydropeptidase I located on the brush border of renal tubular cells. An innovative solution to this problem is its combination with cilastatin, a reversible inhibitor of dehydropeptidase I, which has matched pharmacokinetics with imipenem ($t_{1/2}$ of both is 1 hr) and protects it.

Imipenem-cilastatin 0.5 g i.v. 6 hourly (max 4 g/day) has proved effective in a wide range of serious hospital-acquired infections including those in neutropenic, cancer and AIDS patients.

Imipenem has propensity to induce seizures at higher doses and in predisposed patients. Diarrhoea, vomiting and skin rashes are the other side effects.

Meropenem This newer carbapenem is not hydrolysed by renal peptidase; does not need to be protected by cilastatin. Like imipenem, it is active against both gram-positive and gram-negative bacteria, aerobes as well as anaerobes; somewhat more potent on gram-negative aerobes, but less potent on gram-positive cocci.

Meropenem is a reserve drug for the treatment of serious nosocomial infections like septicaemia, febrile neutropenia, intraabdominal and pelvic infections, etc. caused by cephalosporin-resistant

bacteria. For *P. aeruginosa* infections, it should be combined with an aminoglycoside. The adverse effects of meropenem are similar to imipenem, but it is less likely to cause seizures.

Dose: 0.5–2.0 g (10–40 mg/kg) by slow i.v. injection 8 hourly.

MERONAM, MENEM, UBPENEM 0.5, 1.0 g/vial inj.

Faropenem Another carbapenem β -lactam antibiotic that is orally active against many gram-positive as well as gram-negative bacteria, including some anaerobes. *Strep. pneumoniae*, *H. influenzae*, *Moraxella catarrhalis* are highly susceptible. It has been mainly used in respiratory, ENT and genitourinary infections. Usual side effects are diarrhoea, abdominal pain, nausea and rashes.

Dose: 200–300 mg oral TDS; **FARONEM 100, 200 mg tab.**

CHAPTER 52

Tetracyclines and Chloramphenicol (Broad-Spectrum Antibiotics)

TETRACYCLINES

These are a class of antibiotics having a nucleus of four cyclic rings.

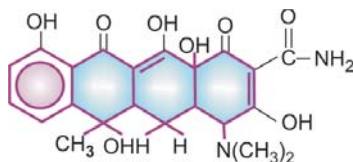

TETRACYCLINE

All are obtained from soil actinomycetes. The first to be introduced was chlortetracycline in 1948 under the name *aureomycin* (because of the golden yellow colour of *S. aureofaciens* colonies producing it). It contrasted markedly from penicillin and streptomycin (the other two antibiotics available at that time) in being active orally and in affecting a wide range of microorganisms—hence called 'broad-spectrum antibiotic'. Oxytetracycline soon followed; others were produced later, either from mutant strains or semisynthetically.

All tetracyclines are slightly bitter solids which are weakly water soluble, but their hydrochlorides are more soluble. Aqueous solutions are unstable. All have practically the same antimicrobial activity (with minor differences). The subsequently developed members have high lipid solubility, greater potency and some other differences. The tetracyclines still available in India for clinical use are:

Tetracycline
Oxytetracycline

Demeclocycline
Doxycycline
Minocycline

Many others like Chlortetracycline, Methacycline, Rolitetracycline, Lymecycline are no longer commercially available.

Mechanism of action The tetracyclines are primarily bacteriostatic; inhibit protein synthesis by binding to 30S ribosomes in susceptible organism. Subsequent to such binding, attachment of aminoacyl-t-RNA to the mRNA-ribosome complex is interfered with (Fig. 52.1). As a result, the peptide chain fails to grow.

The sensitive organisms have an energy dependent active transport process which concentrates tetracyclines intracellularly. In gram-negative bacteria tetracyclines diffuse through porin channels as well. The more lipid-soluble members (doxycycline, minocycline) enter by passive diffusion also (this is partly responsible for their higher potency). The carrier involved in active transport of tetracyclines is absent in the host cells. Moreover, protein synthesizing apparatus of host cells is less sensitive to tetracyclines. These two factors are responsible for the selective toxicity of tetracyclines for the microbes.

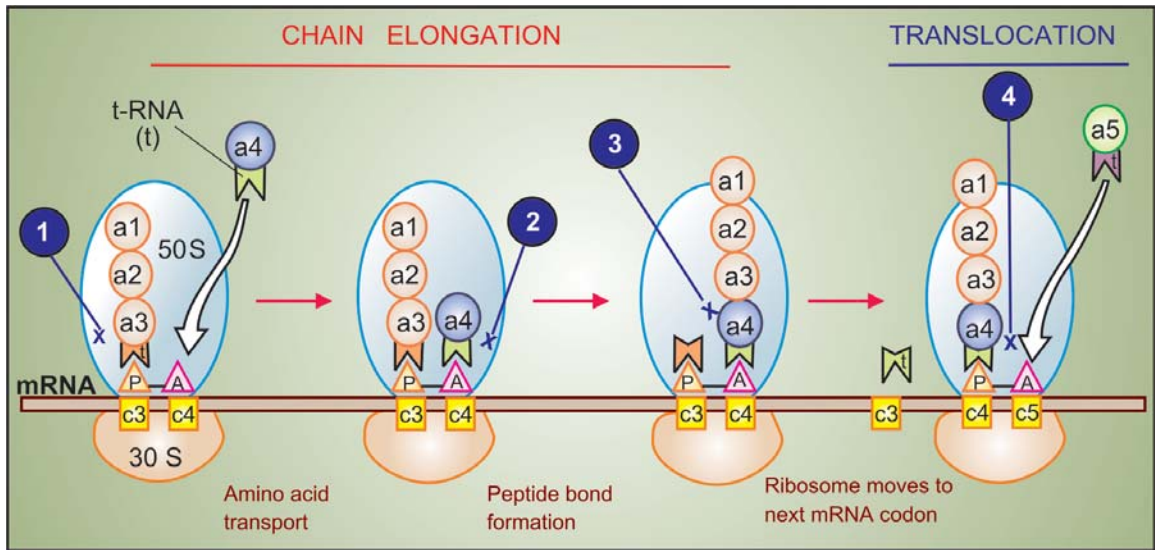

Fig. 52.1: Bacterial protein synthesis and the site of action of antibiotics

The messenger RNA (mRNA) attaches to the 30S ribosome. The initiation complex of mRNA starts protein synthesis and polysome formation. The nascent peptide chain is attached to the peptidyl (P) site of the 50S ribosome. The next amino acid (a) is transported to the acceptor (A) site of the ribosome by its specific tRNA which is complementary to the base sequence of the next mRNA codon (C). The nascent peptide chain is transferred to the newly attached amino acid by peptide bond formation. The elongated peptide chain is shifted back from the 'A' to the 'P' site and the ribosome moves along the mRNA to expose the next codon for amino acid attachment. Finally the process is terminated by the termination complex and the protein is released.

(1) Aminoglycosides bind to several sites at 30S and 50S subunits as well as to their interface—freeze initiation, interfere with polysome formation and cause misreading of mRNA code. (2) Tetracyclines bind to 30S ribosome and inhibit aminoacyl tRNA attachment to the 'A' site. (3) Chloramphenicol binds to 50S subunit—interferes with peptide bond formation and transfer of peptide chain from 'P' site. (4) Erythromycin and clindamycin also bind to 50S ribosome and hinder translocation of the elongated peptide chain back from 'A' site to 'P' site and the ribosome does not move along the mRNA to expose the next codon. Peptide synthesis may be prematurely terminated.

Antimicrobial spectrum When originally introduced, tetracyclines inhibited practically all types of pathogenic microorganisms except fungi and viruses; hence the name 'broad-spectrum antibiotic'. However, promiscuous and often indiscriminate use has gradually narrowed the field of their usefulness.

1. Cocci: All gram-positive and gram-negative cocci were originally sensitive, but now many *Strep. pyogenes*, *Staph. aureus* and enterococci have become resistant. Responsiveness of *Strep. pneumoniae* has decreased somewhat. Tetracyclines (especially minocycline) are now active against few *N. gonorrhoeae* and *N. meningitidis*.

2. Most gram-positive bacilli, e.g. *Clostridia* and other anaerobes, *Listeria*, *Corynebacteria*, *Propionibacterium acnes*, *B. anthracis* are inhibited but not *Mycobacteria*, except some atypical ones.

3. Sensitive gram-negative bacilli are—*H. ducreyi*, *Calymmatobacterium granulomatis*, *V. cholerae*, *Yersinia pestis*, *Y. enterocolitica*, *Campylobacter*, *Helicobacter pylori*, *Brucella*, *Pasteurella multocida*, *F. tularensis* and many anaerobes; some *H. influenzae* have become insensitive.

Enterobacteriaceae are now largely resistant. Notable bacilli that are not inhibited are *Pseudomonas aeruginosa*, *Proteus*, *Klebsiella*, *Salmonella typhi* and many *Bact. fragilis*. MIC against anaerobes is relatively higher.

4. Spirochetes, including *T. pallidum* and *Borrelia* are quite sensitive.
5. All rickettsiae (typhus, etc.) and chlamydiae are highly sensitive.
6. *Mycoplasma* and *Actinomyces* are moderately sensitive.
7. *Entamoeba histolytica* and *Plasmodia* are inhibited at high concentrations.

Resistance Resistance to tetracyclines develops slowly in a graded manner. In such bacteria, usually the tetracycline concentrating mechanism becomes less efficient or the bacteria acquire capacity to pump it out. Another mechanism is plasmid mediated synthesis of a 'protection' protein which protects the ribosomal binding site from tetracycline. Elaboration of tetracycline inactivating enzymes is an unimportant mechanism of tetracycline resistance. Due to widespread use, tetracycline resistance has become common among gram-positive cocci, *E. coli*, *Enterobacter* and many others.

Nearly complete cross resistance is seen among different members of the tetracycline group. However, some organisms not responding to other tetracyclines may be inhibited by therapeutically attained concentrations of minocycline (the most potent agent).

Partial cross resistance between tetracyclines and chloramphenicol has been noted.

Pharmacokinetics

The pharmacokinetic differences between individual tetracyclines are included in Table 52.1. The older tetracyclines are incompletely absorbed from g.i.t.; absorption is better if taken in empty stomach. Doxycycline and minocycline are completely absorbed irrespective of food. Tetracyclines have chelating property—form insoluble and unabsorbable complexes with calcium and other metals. Milk, iron preparations, nonsystemic antacids and sucralfate reduce their absorption. Administration of these substances and tetracyclines should be staggered, if they cannot be avoided altogether.

Tetracyclines are widely distributed in the body (volume of distribution > 1 L/kg). Variable degree of protein binding is exhibited by different members. They are concentrated in liver, spleen and bind to the connective tissue in bone and teeth. Intracellularly, they bind to mitochondria. Minocycline accumulates in body fat. The CSF concentration of most tetracyclines is about 1/4 of plasma concentration, whether meninges are inflamed or not.

Most tetracyclines are primarily excreted in urine by glomerular filtration; dose has to be reduced in renal failure; doxycycline is an exception to this. They are partly metabolized and significant amounts enter bile—some degree of enterohepatic circulation occurs. They are secreted in milk in amounts sufficient to affect the suckling infant.

Enzyme inducers like phenobarbitone and phenytoin enhance metabolism and reduce the $t_{1/2}$ of doxycycline.

Administration Oral capsule is the dosage form in which tetracyclines are most commonly administered. The capsule should be taken $\frac{1}{2}$ hr before or 2 hr after food. Dry syrups and other liquid oral preparations have been banned and discontinued to discourage use in children.

Tetracyclines are not recommended by i.m. route because it is painful and absorption from the injection site is poor. Slow i.v. injection may be given in severe cases, but is rarely required now.

A variety of topical preparations (ointment, cream, etc.) are available, but should not be used, because there is high risk of sensitization. However, ocular application is not contraindicated.

Preparations

1. Oxytetracycline: TERRAMYCIN 250, 500 mg cap, 50 mg/ml in 10 ml vials inj; 3% skin oint, 1% eye/ear oint.
2. Tetracycline: ACHROMYCIN, HOSTACYCLINE, RESTECLIN 250, 500 mg cap. 3% skin oint, 1% eye/ear drops and oint.
3. Demeclocycline (Demethylchlortetracycline): LEDERMYCIN 150, 300 mg cap/tab.

Table 52.1: Comparative features of tetracyclines

	<i>Tetracycline (T)</i> <i>Oxytetracycline (OxyT)</i>	<i>Demeclocycline</i>	<i>Doxycycline (Doxy)</i> <i>Minocycline (Mino)</i>
1. Source	Oxy T: <i>S. rimosus</i> T: semisynthetic	<i>S. aureofaciens</i> (mutant)	Doxy: semisynthetic Mino: semisynthetic
2. Potency	Low	Intermediate	High (Doxy < Mino)
3. Intestinal absorption	T: Moderate Oxy T: Moderate	Moderate	Complete, no interference by food
4. Plasma protein binding	Oxy T: Low T: Moderate	High	High
5. Elimination	T: Rapid renal excretion Oxy T: Rapid renal excretion	Partial metabolism, slower renal excretion	Doxy: Primarily excreted in faeces as conjugate Mino: Primarily metabolized, excreted in urine and bile
6. Plasma t _{1/2}	6–10 hr.	16–18 hr.	18–24 hr.
7. Dosage	250–500 mg QID or TDS	300 mg BD	200 mg initially, then 100–200 mg OD
8. Alteration of intestinal flora	Marked	Moderate	Least
9. Incidence of diarrhoea	High	Intermediate	Low
10. Phototoxicity	Low	Highest	Doxy: High
11. Specific toxicity	Oxy T: less tooth discolouration	More phototoxic, diabetes insipidus	Doxy: Low renal toxicity. Mino: Vestibular toxicity, less superinfections

4. Doxycycline: **TETRADOX**, **BIODOXI**, **DOXT**, **NOVADOX** 100 mg cap.
5. Minocycline: **CYANOMYCIN** 50, 100 mg caps.

Adverse effects

Irritative effects Tetracyclines can cause epigastric pain, nausea, vomiting and diarrhoea by their irritant property. The irritative diarrhoea is to be distinguished from that due to superinfection. Esophageal ulceration has occurred by release of the material from capsules in the esophagus during swallowing, especially with doxycycline. Intramuscular injection of tetracyclines is very painful; thrombophlebitis of the injected vein can occur, especially on repeated use.

Dose related toxicity

1. **Liver damage** Fatty infiltration of liver and jaundice occurs occasionally. Oxytetracycline and

tetracycline are safer in this regard. Tetracyclines are risky in pregnant women; can precipitate acute hepatic necrosis which may be fatal.

2. **Kidney damage** It is prominent only in the presence of existing kidney disease. All tetracyclines, except doxycycline, accumulate and enhance renal failure. A reversible *Fanconi syndrome* like condition is produced by outdated tetracyclines due to proximal tubular damage caused by degraded products—epitetracycline, anhydrotetracycline and epianhydrotetracycline. Exposure to acidic pH, moisture and heat favours such degradation.

3. **Phototoxicity** A sunburn-like or other severe skin reaction on exposed parts is seen in some individuals. A higher incidence has been noted with demeclocycline and doxycycline. Distortion of nails occurs occasionally.

4. Teeth and bones Tetracyclines have chelating property. Calcium-tetracycline chelate gets deposited in developing teeth and bone. Given from midpregnancy to 5 months of extrauterine life, the deciduous teeth are affected: brown discolouration, ill-formed teeth, more susceptible to caries. Tetracyclines given between 3 months and 6 years of age affect the crown of permanent anterior dentition. Repeated courses are more damaging.

Given during late pregnancy or childhood, tetracyclines can cause temporary suppression of bone growth. The ultimate effect on stature is mostly insignificant, but deformities and reduction in height are a possibility with prolonged use.

5. Antianabolic effect Tetracyclines reduce protein synthesis and have an overall catabolic effect. They induce negative nitrogen balance and can increase blood urea.

6. Increased intracranial pressure is noted in some infants.

7. Diabetes insipidus Demeclocycline antagonizes ADH action and reduces urine concentrating ability of the kidney. It has been tried in patients with inappropriate ADH secretion.

8. Vestibular toxicity Minocycline has produced ataxia, vertigo and nystagmus, which subside when the drug is discontinued.

Hypersensitivity This is infrequent with tetracyclines. Skin rashes, urticaria, glossitis, pruritus ani and vulvae, even exfoliative dermatitis have been reported. Angioedema and anaphylaxis are extremely rare. Complete cross sensitization is exhibited by different tetracyclines.

Superinfection Tetracyclines are the most common antibiotics responsible for superinfections, because they cause marked suppression of the resident flora.

Though mouth, skin or vagina may be involved, intestinal superinfection by *Candida albicans* is most prominent (details see p. 672); pseudo-

membranous enterocolitis is rare but serious. Higher doses suppress flora more completely—greater chance of superinfection: doses on the lower side of the range should be used whenever possible. The tetracycline should be discontinued at the first sign of superinfection and appropriate therapy instituted.

Doxycycline and minocycline are less liable to cause diarrhoea, because only small amounts reach the lower bowel in the active form.

Precautions

1. Tetracyclines should not be used during pregnancy, lactation and in children.
2. They should be avoided in patients on diuretics: blood urea may rise in such patients.
3. They should be used cautiously in renal or hepatic insufficiency.
4. Preparations should never be used beyond their expiry date.
5. Do not mix injectable tetracyclines with penicillin—inactivation occurs.
6. Do not inject tetracyclines intrathecally.

Uses

Although tetracyclines are broad-spectrum antibiotics, they should be employed only for those infections for which a more selective and less toxic AMA is not available. Clinical use of tetracyclines has very much declined due to availability of fluoroquinolones and other efficacious AMAs.

1. Empirical therapy Tetracyclines are often employed when the nature and sensitivity of the infecting organism cannot be reasonably guessed, but they are not dependable for empirical treatment of serious/life-threatening infections. They may also be used for initial treatment of *mixed infections*, although a combination of β -lactam and an aminoglycoside antibiotic or a third generation cephalosporin or a fluoroquinolone are now preferred.

2. Tetracyclines are the first choice drugs: despite development of resistance by many organisms in:

(a) Venereal diseases:

- *Chlamydial nonspecific urethritis/endocervicitis*: 7 day doxycycline treatment is as effective as azithromycin single dose.
- *Lymphogranuloma venereum*: resolves in 2–3 weeks (see Table 54.1).
- *Granuloma inguinale*: due to *Calymm. granulomatis*: a tetracycline administered for 3 weeks is the most effective treatment.

(b) Atypical pneumonia: due to *Mycoplasma pneumoniae*: duration of illness is reduced by tetracycline therapy. Psittacosis is treated in 2 weeks by tetracyclines.

(c) Cholera: Tetracyclines have adjuvant value by reducing stool volume and limiting the duration of diarrhoea.

(d) Brucellosis: Tetracyclines are highly efficacious; cause rapid symptomatic relief; therapy of choice is doxycycline 200 mg/day + rifampin 600 mg/day for 6 weeks. Gentamicin may be combined with doxycycline in acute cases.

(e) Plague: Tetracyclines are highly effective in both bubonic and pneumonic plague. They are preferred for blind/mass treatment of suspected cases during an epidemic, though streptomycin often acts faster.

(f) Relapsing fever: due to *Borrelia recurrentis* responds adequately.

(g) Rickettsial infections: typhus, rocky mountain spotted fever, Q fever, etc. respond dramatically. Chloramphenicol is an alternative.

3. Tetracyclines are second choice drugs:

(a) To penicillin/ampicillin for tetanus, anthrax, actinomycosis and *Listeria* infections.

(b) To ceftriaxone, amoxicillin or azithromycin for gonorrhoea, especially for penicillin resistant non-PPNG; also in patients allergic to penicillin, but response rate has decreased.

(c) To ceftriaxone for syphilis in patients allergic to penicillin; early syphilis can be treated in 2 weeks but late syphilis requires 1 month.

(d) To penicillin for leptospirosis; doxycycline 100 mg BD for 7 days is curative. Weekly doxycycline

(200 mg) has been used as prophylactic in subjects at risk during an epidemic.

(e) To azithromycin for pneumonia due to *Chlamydia pneumoniae*. Oral as well as topical tetracycline has been used in trachoma.

(f) To ceftriaxone/azithromycin for chancroid.

(g) To streptomycin for tularemia.

4. Other situations in which tetracyclines may be used are:

(a) Urinary tract infections: Odd cases in which the organism has been found sensitive.

(b) Community-acquired pneumonia, when a more selective antibiotic cannot be used.

(c) Amoebiasis: along with other amoebicides for chronic intestinal amoebiasis.

(d) As adjuvant to quinine or sulfadoxine-pyrimethamine for chloroquine-resistant *P. falciparum* malaria (see p. 792).

(e) Acne vulgaris: prolonged therapy with low doses may be used in severe cases (since *Propionibacterium acnes* is sensitive to tetracyclines), but simpler treatments are preferred in most cases (see Ch. 64).

(f) Chronic obstructive lung disease: prophylactic use may reduce the frequency of exacerbations, but the risk : benefit ratio is controversial.

CHLORAMPHENICOL

Chloramphenicol was initially obtained from *Streptomyces venezuelae* in 1947. It was soon synthesized chemically and the commercial product now is all synthetic.

It is a yellowish white crystalline solid, aqueous solution is quite stable, stands boiling, but needs protection from light. It has a nitrobenzene substitution, which is probably responsible for the antibacterial activity and its intensely bitter taste.

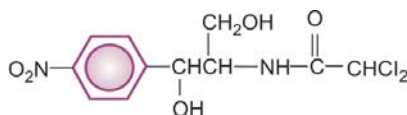
**CHLORAMPHENICOL**

Mechanism of action Chloramphenicol inhibits bacterial protein synthesis by interfering with 'transfer' of the elongating peptide chain to the newly attached aminoacyl-tRNA at the ribosome-mRNA complex. It specifically attaches to the 50S ribosome and thus may hinder the access of aminoacyl-tRNA to the acceptor site for amino acid incorporation (see Fig. 52.1). Probably by acting as a peptide analogue, it prevents formation of peptide bonds.

At high doses, it can inhibit mammalian mitochondrial protein synthesis as well. Bone marrow cells are especially susceptible.

Antimicrobial spectrum Chloramphenicol is primarily bacteriostatic, though high concentrations have been shown to exert cidal effect on some bacteria, e.g. *H. influenzae*. It is a broad-spectrum antibiotic, active against nearly the same range of organisms (gram-positive and negative bacteria, rickettsiae, mycoplasma) as tetracyclines. Notable differences between these two are:

(a) Chloramphenicol was highly active against *Salmonella* including *S. typhi*, but resistant strains are now rampant.

(b) It is more active than tetracyclines against *H. influenzae* (though many have now developed resistance), *B. pertussis*, *Klebsiella*, *N. meningitidis* and anaerobes including *Bact. fragilis*.

(c) It is less active against gram-positive cocci, spirochetes, certain Enterobacteriaceae and *Chlamydia*. *Entamoeba* and *Plasmodia* are not inhibited.

Like tetracyclines, it is ineffective against *Mycobacteria*, *Pseudomonas*, many *Proteus*, viruses and fungi.

Resistance Most bacteria are capable of developing resistance to chloramphenicol, which generally emerges in a graded manner, as with tetracyclines. Being orally active, broad-spectrum and relatively cheap, chloramphenicol was extensively and often indiscriminately used, especially in developing countries, resulting in high incidence of resistance among many gram-positive and gram-negative bacteria.

In many areas, highly chloramphenicol resistant *S. typhi* have emerged due to transfer of R factor by conjugation. Resistance among gram-negative bacteria is generally due to acquisition of R plasmid encoded for an acetyl transferase—an enzyme which inactivates chloramphenicol. Acetyl-chloramphenicol does not bind to the bacterial ribosome. In many cases, this plasmid has also carried resistance to ampicillin and tetracycline. Multidrug-resistant *S. typhi* have arisen.

Decreased permeability into the resistant bacterial cells (chloramphenicol appears to enter bacterial cell both by passive as well as facilitated diffusion) and lowered affinity of bacterial ribosome for chloramphenicol are the other mechanisms of resistance. Partial cross resistance between chloramphenicol and erythromycin/clindamycin has been noted, because all these antibiotics bind to 50S ribosome at adjacent sites. Some cross resistance with tetracyclines also occurs, though the latter binds to 30S ribosome.

Pharmacokinetics

Chloramphenicol is rapidly and completely absorbed after oral ingestion. It is 50–60% bound to plasma proteins and very widely distributed: volume of distribution 1 L/kg. It freely penetrates serous cavities and blood-brain barrier: CSF concentration is nearly equal to that of unbound drug in plasma. It crosses placenta and is secreted in bile and milk.

Chloramphenicol is primarily conjugated with glucuronic acid in the liver and little is excreted unchanged in urine. Cirrhotics and neonates, who have low conjugating ability, require lower doses. The metabolite is excreted mainly in urine. Plasma $t_{1/2}$ of chloramphenicol is 3–5 hours in adults. It is increased only marginally in renal failure: dose need not be modified.

Preparations and administration

The commonest route of administration of chloramphenicol is oral—as capsules; 250–500 mg 6 hourly (max.

total dose 28 g), children 25–50 mg/kg/day. Significant bioavailability differences among different market preparations have been shown. It is also available for application to eye/ear, but topical use at other sites is not recommended.

CHLOROMYCETIN, ENTEROMYCETIN, PARAXIN, 250 mg, 500 mg cap, 1% eye oint, 0.5% eye drops, 5% ear drops, 1% applicaps.

Chloramphenicol palmitate (CHLOROMYCETIN PALMITATE, ENTEROMYCETIN, PARAXIN 125 mg/5 ml oral susp) is an insoluble tasteless ester of chloramphenicol, which is inactive as such. It is nearly completely hydrolysed in the intestine by pancreatic lipase and absorbed as free chloramphenicol, but produces lower plasma concentration.

Chloramphenicol succinate (ENTEROMYCETIN, CHLOROMYCETIN SUCCINATE, KEMICETINE 1 g/vial inj, PHENIMYCIN 0.25, 0.5, 1.0 g inj. is the soluble but inactive ester which is used in the parenteral preparations. Intramuscular injection is painful and produces lower blood levels. It is hydrolysed in tissues to the free active form. However, bioavailability even on i.v. injection is only 70% due to renal excretion of the ester before hydrolysis. **also VANMYCETIN 0.4% eye drops, 250 mg optiaps, LYKACETIN 1% skin cream, 10% otic solution.**

Adverse effects

1. **Bone marrow depression** Of all drugs, chloramphenicol is the most important cause of aplastic anaemia, agranulocytosis, thrombocytopenia or pancytopenia. Two forms are recognized: (a) Non-dose related idiosyncratic reaction: This is rare (1 in 40,000), unpredictable, but serious, often fatal, probably has a genetic basis and is more common after repeated courses. Aplastic anaemia is the most common manifestation. Apparently, a longer latent period of onset of marrow aplasia is associated with higher mortality. Many victims, even if they survive, develop leukaemias later.

(b) Dose and duration of therapy related myelosuppression: a direct toxic effect, predictable and probably due to inhibition of mitochondrial enzyme synthesis. This is often reversible without long-term sequelae. Liver and kidney disease predisposes to such toxicity.

2. **Hypersensitivity reactions** Rashes, fever, atrophic glossitis, angioedema are infrequent.

3. **Irritative effects** Nausea, vomiting, diarrhoea, pain on injection.

4. **Superinfections** These are similar to tetracyclines, but less common.

5. **Gray baby syndrome** It occurred when high doses (~100 mg/kg) were given prophylactically to neonates, especially premature. The baby stopped feeding, vomited, became hypotonic and hypothermic, abdomen distended, respiration became irregular; an ashen gray cyanosis developed in many, followed by cardiovascular collapse and death. Blood lactic acid was raised.

It occurs because of inability of the newborn to adequately metabolize and excrete chloramphenicol. At higher concentration, chloramphenicol blocks electron transport in the liver, myocardium and skeletal muscle, resulting in the above symptoms. It should be avoided in neonates, and even if given, dose should be ~ 25 mg/kg/day.

Interactions Chloramphenicol inhibits metabolism of tolbutamide, chlorpropamide, warfarin, cyclophosphamide and phenytoin. Toxicity can occur if dose adjustments are not done. Phenobarbitone, phenytoin, rifampin enhance chloramphenicol metabolism → reduce its concentration → failure of therapy may occur.

Being bacteriostatic, chloramphenicol can antagonize the cidal action of β -lactams/aminoglycosides on certain bacteria.

Uses

Because of serious (though rare) bone marrow toxicity:

(a) Never use chloramphenicol for minor infections or those of undefined etiology.

(b) Do not use chloramphenicol for infections treatable by other safer antimicrobials.

(c) Avoid repeated courses.

(d) Daily dose not to exceed 2–3 g; duration of therapy to be < 2 weeks, total dose in a course < 28 g.

(e) Regular blood counts (especially reticulocyte count) may detect dose-related bone marrow toxicity but not the idiosyncratic type.

(f) Combined formulation of chloramphenicol with any drug meant for internal use is banned in India.

Indications of chloramphenicol are:

1. **Enteric fever:** Chloramphenicol was the first antibiotic and the drug of choice for typhoid fever till the 1980s when resistant *S. typhi* emerged and spread globally, including most parts of India. As a result, it became clinically unreliable; 50–80% isolates showed *in vitro* resistance. Many of these are multidrug resistant—not responsive to ampicillin and cotrimoxazole as well. However, few recent reports from certain parts of India indicate return of sensitivity to chloramphenicol. Being orally active and inexpensive, it may be used only if the local strain is known to be sensitive. The dose is 0.5 g 6 hourly (children 50 mg/kg/day) till fever subsides, then 0.25 g 6 hourly for another 5–7 days, because bacteriological cure takes longer.

Being bacteriostatic, relapses occur in ~ 10% chloramphenicol treated patients. Also, it does not prevent or cure the carrier state. Bactericidal action is required to eradicate carrier state, because in this state, host defence mechanisms do not operate against the pathogenic bacteria; body treats them as commensals.

2. **Pyogenic meningitis:** Third generation cephalosporins (\pm vancomycin) are presently the first line drugs for empirical therapy of bacterial meningitis (see Ch. 51). Chloramphenicol in a dose of 50–75 mg/kg/day may be used as a second line drug for *H. influenzae* and meningococcal

meningitis, especially in young children and cephalosporin allergic patients, because it has excellent penetration into CSF and clinical efficacy has been demonstrated.

3. **Anaerobic infections** caused by *Bact. fragilis* and others (wound infections, pelvic and brain abscesses, etc.) respond well to chloramphenicol. However, clindamycin or metronidazole are preferred for these. Chloramphenicol may be used in addition or as an alternative in patients not tolerating these drugs. A penicillin/cephalosporin is generally combined since most of these are mixed infections.

4. **Intraocular infections** Chloramphenicol given systemically attains high concentration in ocular fluid. It is the preferred drug for endophthalmitis caused by sensitive organisms.

5. **As second choice drug**

(a) to tetracyclines for brucellosis and rickettsial infections, especially in young children and pregnant women in whom tetracyclines are contraindicated.

(b) to erythromycin for whooping cough.

6. **Urinary tract infections** Use of chloramphenicol is improper when safer drugs are available. It should be used only when kidney substance is involved and the organism is found to be sensitive only to this drug.

7. **Topically** In conjunctivitis, external ear infections—chloramphenicol 0.5–5.0% is highly effective. Topical use on skin or other areas is not recommended because of risk of sensitization.

CHAPTER 53

Aminoglycoside Antibiotics

These are a group of natural and semisynthetic antibiotics having polybasic amino groups linked glycosidically to two or more aminosugar (streptidine, 2-deoxystreptamine, garosamine) residues.

Unlike penicillin, which was a chance discovery, aminoglycosides are products of deliberate search for drugs effective against gram-negative bacteria. *Streptomycin* was the first member discovered in 1944 by Waksman and his colleagues. It assumed great importance because it was active against tubercle bacilli. Others have been produced later; now aminoglycosides are a sizable family. All aminoglycosides are produced by soil actinomycetes and have many common properties.

Systemic aminoglycosides

Streptomycin	Amikacin
Gentamicin	Sisomicin
Kanamycin	Netilmicin
Tobramycin	

Topical aminoglycosides

Neomycin	Framycetin
----------	------------

MECHANISM OF ACTION

The aminoglycosides are bactericidal antibiotics, all having the same general pattern of action which may be described in two main steps:

Common properties of aminoglycoside antibiotics

1. All are used as sulfate salts, which are highly water soluble; solutions are stable for months.
2. They ionize in solution; are not absorbed orally; distribute only extracellularly; do not penetrate brain or CSF.
3. All are excreted unchanged in urine by glomerular filtration.
4. All are bactericidal and more active at alkaline pH.
5. They act by interfering with bacterial protein synthesis.
6. All are active primarily against aerobic gram-negative bacilli and do not inhibit anaerobes.
7. There is only partial cross resistance among them.
8. They have relatively narrow margin of safety.
9. All exhibit ototoxicity and nephrotoxicity.

(a) Transport of the aminoglycoside through the bacterial cell wall and cytoplasmic membrane.

(b) Binding to ribosomes resulting in inhibition of protein synthesis.

Transport of aminoglycoside into bacteria is a multistep process. They diffuse across the outer coat of gram-negative bacteria through porin channels. Entry from the periplasmic space across the cytoplasmic membrane is carrier mediated which is linked to the electron transport chain. Thus, penetration is dependent upon maintenance of a polarized membrane and on oxygen dependent active processes. These

processes are inactivated under anaerobic conditions; anaerobes are not sensitive and facultative anaerobes are more resistant when O₂ supply is deficient, e.g. inside big abscesses. Penetration is also favoured by high pH; aminoglycosides are ~20 times more active in alkaline than in acidic medium. Inhibitors of bacterial cell wall (β -lactams, vancomycin) enhance entry of aminoglycosides and exhibit synergism.

Once inside the bacterial cell, streptomycin binds to 30S ribosomes, but other aminoglycosides bind to additional sites on 50S subunit, as well as to 30S-50S interface. They freeze initiation of protein synthesis (see Fig. 52.1), prevent polyosome formation and promote their disaggregation to monosomes so that only one ribosome is attached to each strand of mRNA. Binding of aminoglycoside to 30S-50S juncture causes distortion of mRNA codon recognition resulting in misreading of the code: one or more wrong amino acids are entered in the peptide chain and/or peptides of abnormal lengths are produced. Different aminoglycosides cause misreading at different levels depending upon their selective affinity for specific ribosomal proteins.

The cidal action of these drugs appears to be based on secondary changes in the integrity of bacterial cell membrane, because other antibiotics which inhibit protein synthesis (tetracyclines, chloramphenicol, erythromycin) are only static. After exposure to aminoglycosides, sensitive bacteria become more permeable; ions, amino acids and even proteins leak out followed by cell death. This probably results from incorporation of the defective proteins into the cell membrane. One of the consequences of aminoglycoside induced alteration of cell membrane is augmentation of the carrier-mediated entry of the antibiotic. This reinforces the lethal action.

The cidal action of aminoglycosides is concentration dependent, i.e. rate of bacterial cell killing is directly related to the ratio of the peak antibiotic concentration to the MIC value. They also exert a long and concentration dependent 'postantibiotic effect' (see p. 675). It has, therefore, been argued that despite their short $t_{1/2}$ (2–4 hr),

single injection of the total daily dose of aminoglycoside may be more effective and possibly less toxic than its conventional division into 2–3 doses.

MECHANISM OF RESISTANCE

Resistance to aminoglycosides is acquired by one of the following mechanisms:

(a) Acquisition of cell membrane bound inactivating enzymes which phosphorylate/adenylate or acetylate the antibiotic. The conjugated aminoglycosides do not bind to the target ribosomes and are incapable of enhancing active transport like the unaltered drug. These enzymes are acquired mainly by conjugation and transfer of plasmids. Nosocomial microbes have become rich in such plasmids, some of which encode for multidrug resistance. This is the most important mechanism of development of resistance to aminoglycosides. Susceptibility of different aminoglycosides to these enzymes differs. Thus, cross resistance among different members is partial or absent.

(b) Mutation decreasing the affinity of ribosomal proteins that normally bind the aminoglycoside: this mechanism can confer high degree resistance, but operates to a limited extent, e.g. *E. coli* that develop streptomycin resistance by single step mutation do not bind the antibiotic on the polyribosome. Only a few other instances are known. This type of resistance is specific for a particular aminoglycoside.

(c) Decreased efficiency of the aminoglycoside transporting mechanism: either the pores in the outer coat become less permeable or the active transport is interfered. This again is not frequently encountered in the clinical setting. In some *Pseudomonas* which develop resistance, the antibiotic induced 2nd phase active transport has been found to be deficient.

SHARED TOXICITIES

The aminoglycosides produce toxic effects which are common to all members, but the relative propensity differs (see Table 53.1).

Table 53.1: Comparative toxicity of aminoglycoside antibiotics (tentative)

Systemically used aminoglycoside	Ototoxicity		Nephrotoxicity
	vestibular	cochlear	
1. Streptomycin	++	±	+
2. Gentamicin	++	+	++
3. Kanamycin	+	++	++
4. Tobramycin	±	+	+
5. Amikacin	+	++	++
6. Sisomicin	++	+	++
7. Netilmicin	+	+	++

1. Ototoxicity This is the most important dose and duration of treatment related adverse effect. The vestibular or the cochlear part may be primarily affected by a particular aminoglycoside. These drugs are concentrated in the labyrinthine fluid and are slowly removed from it when the plasma concentration falls. Ototoxicity is greater when plasma concentration of the drug is persistently high and above a threshold value. The vestibular/cochlear sensory cells and hairs undergo concentration dependent destructive changes. Aminoglycoside ear drops can cause ototoxicity when instilled in patients with perforated eardrum; contraindicated in them.

Cochlear damage It starts from the base and spreads to the apex; hearing loss affects the high frequency sound first, then progressively encompasses the lower frequencies. No regeneration of the sensory cells occurs; auditory nerve fibres degenerate in a retrograde manner—deafness is permanent. Older patients and those with preexisting hearing defect are more susceptible. Initially, the cochlear toxicity is asymptomatic; can be detected only by audiometry. Tinnitus then appears, followed by progressive hearing loss. On stopping the drug, tinnitus disappears in 4–10 days, but frequency loss persists.

Vestibular damage Headache is usually first to appear, followed by nausea, vomiting, dizziness, nystagmus, vertigo and ataxia. When the drug is stopped at this stage, it passes into a chronic phase lasting 6 to 10 weeks in which the patient is asymptomatic while in bed and has difficulty only

during walking. Compensation by visual and proprioceptive positioning and recovery (often partial) occurs over 1–2 years. Permanency of changes depends on the extent of initial damage and the age of the patient (elderly have poor recovery).

2. Nephrotoxicity It manifests as tubular damage resulting in loss of urinary concentrating power, low g.f.r., nitrogen retention, albuminuria and casts. Aminoglycosides attain high concentration in the renal cortex and toxicity is related to the total amount of the drug received by the patient. It is more in the elderly and in those with preexisting kidney disease. Essentially, renal damage caused by aminoglycosides is totally reversible, provided the drug is promptly discontinued. It has been suggested that aminoglycosides interfere with the production of PGs in the kidney and that this is causally related to the reduced g.f.r. An important implication of aminoglycoside-induced nephrotoxicity is reduced clearance of the antibiotic → higher blood levels → enhanced ototoxicity.

3. Neuromuscular blockade All aminoglycosides reduce ACh release from the motor nerve endings: interfere with mobilization of centrally located synaptic vesicles to fuse with the terminal membrane (probably by antagonizing Ca^{2+}) as well as decrease the sensitivity of the muscle endplates to ACh. The effect of this action is not manifested ordinarily in the clinical use of these drugs. However, apnoea and fatalities have occurred when these antibiotics were put into peritoneal or pleural cavity after an operation, especially if a curare-like muscle relaxant was administered during surgery. Rapid absorption from the peritoneum/pleura produces high blood levels and adds to the residual action of the neuromuscular blocker.

Neomycin and streptomycin have higher propensity than kanamycin, gentamicin or amikacin; tobramycin is least likely to produce this effect. The neuromuscular block can be partially antagonized by i.v. injection of a calcium

salt. Neostigmine has inconsistent reversing action.

Myasthenic weakness is accentuated by these drugs. Neuromuscular blockers should be used cautiously in patients receiving aminoglycosides.

PRECAUTIONS AND INTERACTIONS

1. Avoid aminoglycosides during pregnancy: risk of foetal ototoxicity.
2. Avoid concurrent use of other ototoxic drugs, e.g. high ceiling diuretics, minocycline.
3. Avoid concurrent use of other nephrotoxic drugs, e.g. amphotericin B, vancomycin, cyclosporine and cisplatin.
4. Cautious use in patients past middle age and in those with kidney damage.
5. Cautious use of muscle relaxants in patients receiving an aminoglycoside.
6. Do not mix aminoglycoside with any drug in the same syringe/infusion bottle.

STREPTOMYCIN

It is the oldest aminoglycoside antibiotic obtained from *Streptomyces griseus*; used extensively in the past, but now practically restricted to treatment of tuberculosis. It is less potent (MICs are higher) than other aminoglycosides. The antimicrobial spectrum of streptomycin is relatively narrow: active primarily against aerobic gram-negative bacilli, but potency is low. Sensitive organisms are—*H. ducreyi*, *Brucella*, *Yersinia pestis*, *Francisella tularensis*, *Nocardia*, *Calym. granulomatis*, *M. tuberculosis*. Only few strains of *E. coli*, *H. influenzae*, *V. cholerae*, *Shigella*, *Klebsiella*, enterococci and some gram-positive cocci are now inhibited, that too at higher concentrations. All other organisms including *Pseudomonas* are unaffected.

Resistance Many organisms develop rapid resistance to streptomycin, either by one-step mutation or by acquisition of plasmid which codes for inactivating enzymes. In the intestinal and urinary tracts, resistant organisms may emerge within 2 days of therapy. *E. coli*,

H. influenzae, *Str. pneumoniae*, *Str. pyogenes*, *Staph. aureus* have become largely resistant. If it is used alone, *M. tuberculosis* also become resistant.

Streptomycin dependence Certain mutants grown in the presence of streptomycin become dependent on it. Their growth is promoted rather than inhibited by the antibiotic. This occurs when the antibiotic induced misreading of the genetic code becomes a normal feature for the organism. This phenomenon is probably significant only for use of streptomycin in tuberculosis.

Cross resistance Only partial and often unidirectional cross resistance occurs between streptomycin and other aminoglycosides.

Pharmacokinetics Streptomycin is highly ionized. It is neither absorbed nor destroyed in the g.i.t. However, absorption from injection site in muscles is rapid. It is distributed only extracellularly: volume of distribution (0.3 L/kg) is nearly equal to the extracellular fluid volume. Low concentrations are attained in serous fluids like synovial, pleural, peritoneal. Concentrations in CSF and aqueous humour are often non-therapeutic, even in the presence of inflammation. Plasma protein binding is clinically insignificant.

Streptomycin is not metabolized—excreted unchanged in urine. Glomerular filtration is the main channel: tubular secretion and reabsorption are negligible. The plasma $t_{1/2}$ is 2–4 hours, but the drug persists longer in tissues. Renal clearance of streptomycin parallels creatinine clearance and is approximately 2/3 of it. Half-life is prolonged and accumulation occurs in patients with renal insufficiency, in the elderly and neonates who have low g.f.r. Reduction in dose or increase in dose-interval is essential in these situations.

These pharmacokinetic features apply to all systemically administered aminoglycosides.

Adverse effects About 1/5 patients given streptomycin 1 g BD i.m. experience vestibular disturbances. Auditory disturbances are less common.

Streptomycin has the lowest nephrotoxicity among aminoglycosides; probably because it is not concentrated in the renal cortex. Hypersensitivity reactions are rare; rashes, eosinophilia,

fever and exfoliative dermatitis have been noted. Anaphylaxis is very rare. Topical use is contraindicated for fear of contact sensitization. Superinfections are not significant. Pain at injection site is common. Paraesthesias and scotoma are occasional.

AMBISTRYN-S 0.75, 1 g dry powder per vial for inj.

Acute infections: 1 g (0.75 g in those above 50 yr age) i.m. BD for 7–10 days.

Tuberculosis: 1 g or 0.75 g i.m. OD or twice weekly for 30–60 days.

Uses

1. Tuberculosis: *see* Ch. 55.
2. Subacute bacterial endocarditis (SABE): Streptomycin (now mostly gentamicin) is given in conjunction with penicillin. A 4–6 weeks treatment is needed.
3. Plague: It effects rapid cure (in 7–12 days), may be employed in confirmed cases, but tetracyclines have been more commonly used for mass treatment of suspected cases during an epidemic.
4. Tularemia: Streptomycin is the drug of choice for this rare disease: effects cure in 7–10 days. Tetracyclines are the alternative drugs, especially in milder cases.

In most other situations, e.g. urinary tract infection, peritonitis, septicaemias, etc. where streptomycin was used earlier, gentamicin or one of the newer aminoglycosides is now preferred due to low potency and widespread resistance to streptomycin.

Oral use of streptomycin for diarrhoea is banned in India.

GENTAMICIN

It was obtained from *Micromonospora purpurea* in 1964; has become the most commonly used aminoglycoside for acute infections. The properties of gentamicin including plasma $t_{1/2}$ of 2–4 hours after i.m. injection are the same as described above for streptomycin, but there are following differences:

- (a) It is more potent (MIC for most organisms is 4–8 times lower.)
- (b) It has a broader spectrum of action: effective against *Ps. aeruginosa* and most strains of *Proteus*, *E. coli*, *Klebsiella*, *Enterobacter*, *Serratia*.
- (c) It is ineffective against *M. tuberculosis*, *Strep. pyogenes* and *Strep. pneumoniae*, but inhibits many *Strep. faecalis* and some *Staph. aureus*.
- (d) It is relatively more nephrotoxic.

Dose: The dose of gentamicin must be precisely calculated according to body weight and level of renal function. For an average adult with normal renal function (creatinine clearance ≥ 100 ml/min) 3–5 mg/kg/day i.m. either as single dose or divided in three 8 hourly doses is recommended.

Because of concentration dependent bactericidal and postantibiotic effect of aminoglycosides, it was theorised that high plasma concentration attained after the single daily dose will be more effective. It is also likely to be less ototoxic because plasma concentrations will remain subthreshold for ototoxicity for a longer period each day allowing washout of the drug from the endolymph. The efficacy and safety of many aminoglycosides by the conventional (thrice daily) and once daily regimens has been compared in several studies. The data indicate similar efficacy and a trend towards less toxicity. As such, many hospitals now practice once daily dosing of aminoglycosides. It is more convenient as well.

The daily dose of gentamicin (and other aminoglycosides) should be reduced in patients with impaired renal function according to measured creatinine clearance. A general guideline is:

Guideline for dose adjustment of gentamicin in renal insufficiency

CLcr (ml/min)	% of daily dose
70	70% daily
50	50% daily
30	30% daily
10–30	60% alternate day
<10	40% alternate day

GARAMYCIN, GENTASPORIN, GENTICYN 20, 60, 80, 240 mg per vial inj; also 0.3% eye/ear drops, 0.1% skin cream.

Uses Gentamicin is the cheapest (other than streptomycin) and the first line aminoglycoside antibiotic. However, because of low therapeutic index, its use should be restricted to serious gram-negative bacillary infections.

1. Gentamicin is very valuable for preventing and treating respiratory infections in critically ill patients; in those with impaired host defence (receiving anticancer drugs or high-dose corticosteroids; AIDS; neutropenic), patients in resuscitation wards, with tracheostomy or on respirators; postoperative pneumonias; patients

with implants and in intensive care units. It is often combined with a penicillin/cephalosporin or another antibiotic in these situations. However, resistant strains have emerged in many hospitals and nosocomial infections are less amenable to gentamicin now. Another aminoglycoside (tobramycin, amikacin, sisomicin, netilmicin) is then selected on the basis of the local sensitivity pattern. Aminoglycosides should not be used to treat community acquired pneumonias caused by gram-positive cocci and anaerobes.

Gentamicin is often added to the peritoneal dialysate to prevent or treat peritonitis.

2. *Pseudomonas*, *Proteus* or *Klebsiella* infections: burns, urinary tract infection, pneumonia, lung abscesses, osteomyelitis, middle ear infection, septicaemia, etc. are an important area of use of gentamicin. It may be combined with piperacillin or a third generation cephalosporin for serious infections. Topical use on infected burns and in conjunctivitis is permissible.

3. Meningitis caused by gram-negative bacilli: in addition to the usual i.m. dose, 4 mg intrathecal injection may be given daily, but benefits are uncertain. Because this is a serious condition, drug combinations including an aminoglycoside are often used. The third generation cephalosporins alone or with an aminoglycoside are favoured for this purpose.

4. SABA: gentamicin is more commonly used in place of streptomycin to accompany penicillin.

Gentamicin-PMMA (polymethyl methacrylate) chains (SEPTOPAL) is a special drug delivery system for use in osteomyelitis. It consists of small acrylic beads each impregnated with 7.5 mg gentamicin sulph. and threaded over surgical grade wire. Implanted in the bone cavity after thorough removal of sequestra and left in place for 10 days, it has improved cure rates.

KANAMYCIN

Obtained from *S. kanamyceticus* (in 1957), it was the second systemically used aminoglycoside to be developed after streptomycin. It is similar to streptomycin in all respects including efficacy against *M. tuberculosis* and lack of activity on *Pseudomonas*. However, it is more toxic, both to the cochlea and to kidney. Hearing loss is more common than vestibular disturbance.

Because of toxicity and narrow spectrum of activity, it has been largely replaced by other aminoglycosides for treatment of gram-negative bacillary infections. It is occasionally used as a second line drug in resistant tuberculosis. Dose: 0.5 g i.m. BD-TDS: KANAMYCIN, KANCIN, KANAMAC 0.5, 1 g inj.

TOBRAMYCIN

It was obtained from *S. tenebrarius* in the 1970s. The antibacterial and pharmacokinetic properties, as well as dosage are almost identical to gentamicin, but it is 2–4 times more active against *Pseudomonas* and *Proteus*, including those resistant to gentamicin. However, it is not useful for combining with penicillin in the treatment of enterococcal endocarditis. It should be used only as a reserve alternative to gentamicin. Serious infections caused by *Pseudomonas* and *Proteus* are its major indications. Ototoxicity and nephrotoxicity is probably lower than gentamicin.

Dose: 3–5 mg/kg day in 1–3 doses.

TOBACIN 20, 60, 80 mg in 2 ml inj. 0.3% eye drops.

TOBRANEG 20, 40, 80 mg per 2 ml inj, TOBRABACT 0.3% eye drops.

AMIKACIN

It is a semisynthetic derivative of kanamycin to which it resembles in pharmacokinetics, dose and toxicity. The outstanding feature of amikacin is its resistance to bacterial aminoglycoside inactivating enzymes. Thus, it has the widest spectrum of activity, including many organisms resistant to other aminoglycosides. However, relatively higher doses are needed for *Pseudomonas*, *Proteus* and *Staph.* infections.

The range of conditions in which amikacin can be used is the same as for gentamicin. It is recommended as a reserve drug for hospital acquired gram-negative bacillary infections where gentamicin/tobramycin resistance is high. It is effective in tuberculosis, but rarely used for this purpose. More hearing loss than vestibular disturbance occurs in toxicity.

Dose: 15 mg/kg/day in 1–3 doses; urinary tract infection 7.5 mg/kg/day.

AMICIN, MIKACIN, MIKAJECT 100 mg, 250 mg, 500 mg in 2 ml inj.

SISOMICIN

Introduced in 1980s, it is a natural aminoglycoside from *Micromonospora inyoensis* that is chemically and pharmacokinetically similar to gentamicin, but somewhat more potent on *Pseudomonas*, a few other gram-negative bacilli and β haemolytic *Streptococci*. It is moderately active on faecal *Streptococci*—can be combined with penicillin for SABE. However, it is susceptible to aminoglycoside inactivating enzymes and offers no advantage in terms of ototoxicity and nephrotoxicity. It can be used interchangeably with gentamicin for the same purposes in the same doses.

ENSAMYCIN, SISOPTIN 50 mg, 10 mg (pediatric) per ml in 1 ml amps, 0.3% eyedrops, 0.1% cream.

NETILMICIN

This semisynthetic derivative of sisomicin has a broader spectrum of activity than gentamicin. It is relatively resistant to aminoglycoside inactivating enzymes and thus effective against many gentamicin-resistant strains. It is more active against *Klebsiella*, *Enterobacter* and *Staphylococci*, but less active against *Ps. aeruginosa*.

Pharmacokinetic characteristics and dosage of netilmicin are similar to gentamicin. Experimental studies have shown it to be less ototoxic than gentamicin and tobramycin, but clinical evidence is inconclusive: hearing loss occurs, though fewer cases of vestibular damage have been reported.

A marginal improvement in antibacterial spectrum, clinical efficacy and possibly reduced toxicity indicates that netilmicin could be preferable in critically ill and neutropenic patients, and retain activity in hospitals where gentamicin resistance has spread.

Dose: 4–6 mg/kg/day in 1–3 doses; NETROMYCIN 10, 25, 50 mg in 1 ml, 200 mg in 2 ml and 300 mg in 3 ml inj., NETICIN 200 mg (2 ml), 300 mg (3 ml) inj.

NEOMYCIN

Obtained from *S. fradiae*, it is a wide-spectrum aminoglycoside, active against most gram-negative bacilli and some gram-positive cocci.

However, *Pseudomonas* and *Strep. pyogenes* are not sensitive. Neomycin is highly toxic to the internal ear (mainly auditory) and to kidney. It is, therefore, not used systemically. Absorption from the g.i.t. is minimal. Oral and topical administration does not ordinarily cause systemic toxicity.

Dose: 0.25–1 g QID oral, 0.3–0.5% topical.

NEOMYCIN SULPHATE 350, 500 mg tab, 0.3% skin oint, 0.5% skin cream, eye oint.

NEBASULF: Neomycin sulph. 5 mg, bacitracin 250 U, sulfacetamide 60 mg/g oint. and powder for surface application.

POLYBIOTIC CREAM: Neomycin sulph. 5 mg, polymyxin 5,000 IU, gramicidin 0.25 mg/g cream.

NEOSPORIN: Neomycin 3400 iu, polymyxin B 5000 iu, bacitracin 400 iu/g oint and powder for surface application. NEOSPORIN-H: Neomycin 3400 iu, polymyxin B 5000 iu, hydrocortisone 10 mg per g oint and per ml ear drops.

Uses

1. Topically (often in combination with polymyxin, bacitracin, etc.) for infected wound, ulcers, burn, external ear infections, conjunctivitis, but like other topical anti-infective preparations, benefits are limited.

2. Orally for:

(a) Preparation of bowel before surgery: (3 doses of 1.0 g along with metronidazole 0.5 g on day before surgery) may reduce postoperative infections.

(b) Hepatic coma: Normally NH_3 is produced by colonic bacteria. This is absorbed and converted to urea by liver. In severe hepatic failure, detoxication of NH_3 does not occur, blood NH_3 levels rise and produce encephalopathy. Neomycin, by suppressing intestinal flora, diminishes NH_3 production and lowers its blood level; clinical improvement is seen within 2–3 days. However, because of toxic potential it is infrequently used for this purpose; lactulose (see p. 655) is preferred.

Adverse effects Applied topically neomycin has low sensitizing potential. However, rashes do occur.

Oral neomycin has a damaging effect on intestinal villi—prolonged treatment can induce malabsorption syndrome with diarrhoea and steatorrhoea. It can decrease the absorption of digoxin and many other drugs, as well as bile acids.

Due to marked suppression of gut flora, superinfection by *Candida* can occur.

Small amounts that are absorbed from the gut or topical sites are excreted unchanged by kidney. This may accumulate in patients with renal insufficiency—cause further kidney damage and ototoxicity. Neomycin is contraindicated if renal function is impaired.

Applied to serous cavities (peritoneum), it can cause apnoea due to muscle paralysing action.

Neomycin containing antidiarrhoeal formulations are banned in India.

FRAMYCETIN

Obtained from *S. lavendulae*, it is very similar to neomycin. It is too toxic for systemic administration and is used topically on skin, eye, ear in the same manner as neomycin.

SOFRAMYCIN, FRAMYGEN 1% skin cream, 0.5% eye drops or oint.

CHAPTER 54

Macrolide, Lincosamide, Glycopeptide and Other Antibacterial Antibiotics; Urinary Antiseptics

MACROLIDE ANTIBIOTICS

These are antibiotics having a macrocyclic lactone ring with attached sugars. *Erythromycin* is the first member discovered in the 1950s, *Roxithromycin*, *Clarithromycin* and *Azithromycin* are the later additions.

ERYTHROMYCIN

It was isolated from *Streptomyces erythreus* in 1952. Since then it has been widely employed, mainly as alternative to penicillin. Water solubility of erythromycin is limited, and the solution remains stable only when kept in cold.

Mechanism of action Erythromycin is bacteriostatic at low but cidal (for certain bacteria) at high concentrations. Cidal action depends on the organism concerned and its rate of multiplication. Sensitive gram-positive bacteria accumulate erythromycin intracellularly by active transport which is responsible for their high susceptibility to this antibiotic. It is several fold more active in alkaline medium, because the nonionized (penetrable) form of the drug is favoured at higher pH.

Erythromycin acts by inhibiting bacterial protein synthesis. It combines with 50S ribosome

subunits and interferes with 'translocation' (see Fig. 52.1). After peptide bond formation between the newly attached amino acid and the nascent peptide chain at the acceptor (A) site the elongated peptide is translocated back to the peptidyl (P) site, making the A site available for next aminoacyl tRNA attachment. This is prevented by erythromycin and the ribosome fails to move along the mRNA to expose the next codon. As an indirect consequence, peptide chain may be prematurely terminated: synthesis of larger proteins is specifically suppressed.

Antimicrobial spectrum It is narrow, includes mostly gram-positive and a few gram-negative bacteria, and overlaps considerably with that of penicillin G. Erythromycin is highly active against *Str. pyogenes* and *Str. pneumoniae*, *N. gonorrhoeae*, *Clostridia*, *C. diphtheriae*, *Listeria*. Most penicillin-resistant *Staphylococci* and *Streptococci* were initially sensitive, but have now become resistant to erythromycin also.

In addition, *Campylobacter*, *Legionella*, *Branhamella catarrhalis*, *Gardnerella vaginalis* and *Mycoplasma*, that are not affected by penicillin, are highly sensitive to erythromycin. Few others, including *H. influenzae*, *H. ducreyi*, *B. pertussis*, *Chlamydia trachomatis*, *Str. viridans*, *N. meningitidis*

and *Rickettsiae* are moderately sensitive. Enterobacteriaceae, other gram-negative bacilli and *B. fragilis* are not inhibited.

Resistance All cocci readily develop resistance to erythromycin, mostly by mechanisms which render them less permeable to erythromycin or acquire the capacity to pump it out. Resistant Enterobacteriaceae have been found to produce an erythromycin esterase. Alteration in the ribosomal binding site for erythromycin by plasmid encoded methylase enzyme is an important mechanism in gram-positive bacteria. All the above types of resistance are plasmid mediated, while change in the 50S ribosome by chromosomal mutation has also been found.

Bacteria that develop resistance to erythromycin are resistant to other macrolides as well. Cross resistance with clindamycin and chloramphenicol also occurs, because the ribosomal binding sites for all these are proximal to each other.

Pharmacokinetics

Erythromycin base is acid labile. To protect it from gastric acid, it is given as enteric coated tablets, from which absorption is incomplete and food delays absorption by retarding gastric emptying. Its acid stable esters are better absorbed.

Erythromycin is widely distributed in the body, enters cells and into abscesses, crosses serous membranes and placenta, but not blood-brain barrier. It attains therapeutic concentration in the prostate. It is 70–80% plasma protein bound, partly metabolized and excreted primarily in bile in the active form. Renal excretion is minor; dose need not be altered in renal failure. The plasma $t_{1/2}$ is 1.5 hr, but erythromycin persists longer in tissues.

Preparations and dose

Dose: 250–500 mg 6 hourly (max. 4 g/day), children 30–60 mg/kg/day.

1. Erythromycin (base): **ERYSAFE 250, mg tabs, EROMED 333 mg tab, 125 mg/5 ml susp.**

2. Erythromycin stearate: blood levels produced are similar to those after erythromycin base. **ERYTHROCIN 250, 500 mg tab, 100 mg/5 ml susp., 100 mg/ml ped. drops. ETROCIN, ERYSTER 250 mg tab, 100 mg/5 ml dry syr, EMTHRO 250 mg tab, 125 mg/5 ml susp.**

3. Erythromycin estolate (lauryl sulfate): it is relatively acid stable and better absorbed after oral administration. However, concentration of free and active drug in plasma may be the same as after administration of erythromycin base. Certain organisms hydrolyse it to liberate the free form intracellularly and are more susceptible to it.

ALTHROCIN 250, 500 mg tab, 125 mg kid tab, 125 mg/5 ml and 250 mg/5 ml dry syr, 100 mg/ml ped. drops, E-MYCIN 100, 250 mg tab, 100 mg/5 ml dry syr; ERYC-S 250 mg tab, 125 mg/5 ml dry syr.

4. Erythromycin ethylsuccinate: well absorbed orally; **ERYNATE 100 mg/5 ml dry syr, ERYTHROCIN 100 mg/ml drops, 125 mg/5 ml syr.**

A 30% ointment (**GERY OINTMENT**) is marketed for topical treatment of boils, carbuncles and skin infections, but efficacy is doubtful.

Adverse effects Erythromycin base is a remarkably safe drug.

1. **Gastrointestinal** Mild-to-severe epigastric pain is experienced by many patients, especially children, on oral therapy. Diarrhoea is occasional. Erythromycin stimulates motilin receptors in the g.i.t.—thereby induces gastric contractions, hastens gastric emptying and promotes intestinal motility. However, contribution of this action to the g.i. side effects is not known.

2. Very high doses of erythromycin have caused reversible hearing impairment.

3. **Hypersensitivity** Rashes and fever are infrequent. Other allergic manifestations are rare with erythromycin base or esters other than estolate.

Hepatitis with cholestatic jaundice resembling viral hepatitis or extrahepatic biliary obstruction occurs with the estolate ester (rarely with ethyl succinate or stearate ester) after 1–3 weeks. Incidence is higher in pregnant women. It clears on discontinuation of the drug, and is probably due to hypersensitivity to the estolate ester; erythromycin base or other esters can be given to these patients without recurrence. Though the estolate is acid stable, tasteless and better absorbed, it has been banned in some countries (but not in India).

Interaction Erythromycin inhibits hepatic oxidation of many drugs. The clinically significant interactions are—rise in plasma levels of theophylline, carbamazepine, valproate, ergotamine and warfarin.

Several cases of Q-T prolongation, serious ventricular arrhythmias and death have been reported due to inhibition of CYP3A4 by erythromycin/clarithromycin resulting in high blood levels of concurrently administered terfenadine/astemizole/cisapride (see p. 158 and 645).

Uses

A. As an alternative to penicillin

1. Streptococcal pharyngitis, tonsillitis, mastoiditis and community acquired respiratory infections caused by pneumococci and *H. influenzae* respond equally well to erythromycin. It is an alternative drug for prophylaxis of rheumatic fever and SABA. However, many bacteria resistant to penicillin are also resistant to erythromycin.
2. Diphtheria: acute stage as well as for carriers—7 day treatment. Some prefer it over penicillin. Antitoxin is the primary treatment.
3. Tetanus: as an adjuvant to antitoxin, toxoid therapy.
4. Syphilis and gonorrhoea: only if other alternative drugs, including tetracyclines also cannot be used: relapse rates are higher.
5. Leptospirosis: 250 mg 6 hourly for 7 days in patients allergic to penicillins.

B. As a first choice drug for

1. Atypical pneumonia caused by *Mycoplasma pneumoniae*: rate of recovery is hastened.
2. Whooping cough: a 1–2 week course of erythromycin is the most effective treatment for eradicating *B. pertussis* from upper respiratory tract. However, effect on the symptoms depends on the stage of disease when treatment is started.
 - (a) Prophylactic: during the 10 day incubation period—disease is prevented.
 - (b) Catarrhal stage: which lasts for about a week—erythromycin may abort the next stage or reduce its duration and severity.
 - (c) Paroxysmal stage: lasting 2–4 weeks—no effect on the duration and severity of ‘croup’ despite eradication of the causative organism.
 - (d) Convalescent stage: during which ‘croup’ gradually resolves (4–12 weeks)—is not modified.

Azithromycin, clarithromycin, and chloramphenicol are the alternative antimicrobials. Cough sedatives are not very effective. Corticosteroids may reduce the duration of paroxysmal stage but increase the risk of superinfections and carrier stage; should be reserved for severe cases only. Adrenergic β_2 stimulants may reduce the severity of paroxysms; more useful in infants.

3. Chancroid: erythromycin 2 g/day for 7 days is one of the drugs of choice, as effective as azithromycin or ceftriaxone.

C. As a second choice drug in

1. *Campylobacter* enteritis: duration of diarrhoea and presence of organisms in stools is reduced. However, fluoroquinolones are superior.
2. Legionnaires’ pneumonia: 3 week erythromycin treatment is effective, but azithromycin/ciprofloxacin are preferred.
3. *Chlamydia trachomatis* infection of urogenital tract: erythromycin 500 mg 6 hourly for 7 days is an effective alternative to single dose azithromycin.
4. Penicillin-resistant *Staphylococcal* infections: its value has reduced due to emergence of erythromycin resistance as well. It is not effective against MRSA.

NEWER MACROLIDES

In an attempt to overcome the limitations of erythromycin like narrow spectrum, gastric intolerance, gastric acid lability, low oral bioavailability, poor tissue penetration and short half-life, a number of semisynthetic macrolides have been produced, of which roxithromycin, clarithromycin and azithromycin have been marketed.

Roxithromycin It is a semisynthetic long-acting acid-stable macrolide whose antimicrobial spectrum resembles closely with that of erythromycin. It is more potent against *Branh. catarrhalis*, *Gard. vaginalis* and *Legionella* but less potent against *B. pertussis*. Good enteral absorption and tissue penetration, an average plasma $t_{1/2}$ of 12 hr making it suitable for twice daily dosing, as well as better gastric tolerability are its desirable features.

Though its affinity for cytochrome P450 is lower, drug interactions with terfenadine, cisapride and others are not ruled out. Thus, it is an alternative to erythromycin for respiratory, ENT, skin and soft tissue and genital tract infections with similar efficacy.

Dose: 150–300 mg BD 30 min before meals, children 2.5–5 mg/kg BD;

ROXID, ROXIBID, RULIDE 150, 300 mg tab, 50 mg kid tab, 50 mg /5 ml liquid; ROXEM 50 mg kid tab, 150 mg tab.

Clarithromycin The antimicrobial spectrum of clarithromycin is similar to erythromycin; in addition, it includes *Mycobact. avium* complex (MAC), other atypical mycobacteria, *Mycobact. leprae* and some anaerobes but not *Bact. fragilis*. It is more active against sensitive strains of gram-positive cocci, *Moraxella*, *Legionella*, *Mycoplasma pneumoniae* and *Helicobacter pylori*. However, bacteria that have developed resistance to erythromycin are resistant to clarithromycin also.

Clarithromycin is more acid-stable than erythromycin, and is rapidly absorbed; oral bioavailability is ~50% due to first pass metabolism; food delays but does not decrease absorption. It has slightly greater tissue distribution than erythromycin and is metabolized by saturation kinetics— $t_{1/2}$ is prolonged from 3–6 hours at lower doses to 6–9 hours at higher doses. An active metabolite is produced. About 1/3 of oral dose is excreted unchanged in urine, but no dose modification is needed in liver disease or in mild-to-moderate kidney failure.

Clarithromycin is indicated in upper and lower respiratory tract infections, sinusitis, otitis media, whooping cough, atypical pneumonia, skin and skin structure infections due to *Strep. pyogenes* and some *Staph. aureus*. Used as a

component of triple drug regimen (see p. 637) it eradicates *H. pylori* in 1–2 weeks. It is a first line drug in combination regimens for MAC infection in AIDS patients and a second line drug for other atypical mycobacterial diseases as well as leprosy.

Dose: 250 mg BD for 7 days; severe cases 500 mg BD up to 14 days.

CLARIBID 250, 500 mg tabs, 250 mg/5 ml dry syr; CLARIMAC 250, 500 mg tabs; SYNCLAR 250 mg tab, 125 mg/5 ml dry syr.

Side effects of clarithromycin are similar to erythromycin, but gastric tolerance is better. High doses can cause reversible hearing loss. Few cases of pseudomembranous enterocolitis, hepatic dysfunction or rhabdomyolysis are reported. Its safety in pregnancy and lactation is not known. The drug interaction potential is also similar to erythromycin.

Azithromycin This new azalide congener of erythromycin has an expanded spectrum, improved pharmacokinetics, better tolerability and drug interaction profiles. It is more active than other macrolides against *H. influenzae*, but less active against gram-positive cocci. High activity is exerted on respiratory pathogens—*Mycoplasma*, *Chlamydia pneumoniae*, *Legionella*, *Moraxella* and on others like *Campylobacter*, *Ch. trachomatis*, *H. ducreyi*, *Calymm*, *granulomatis*, *N. gonorrhoeae*. However, it is not active against erythromycin-resistant bacteria. Penicillinase producing *Staph. aureus* are inhibited but not MRSA. Good activity is noted against MAC.

The remarkable pharmacokinetic properties are acid-stability, rapid oral absorption, marked tissue distribution and intracellular penetration. Concentration in most tissues exceeds that in plasma. Particularly high concentrations are attained inside macrophages and fibroblasts; volume of distribution is ~30 L/kg. Slow release from the intracellular sites contributes to its long terminal $t_{1/2}$ of >50 hr. It is largely excreted unchanged in bile, renal excretion is ~10%.

Because of higher efficacy, better gastric tolerance and convenient once a day dosing, azithromycin is now preferred over erythromycin as **first choice** drug for infections such as:

(a) *Legionnaires'* pneumonia: 500 mg OD oral/ i.v. for 2 weeks. Erythromycin or a FQ are the alternatives.

(b) *Chlamydia trachomatis*: nonspecific urethritis and genital infections in both men and women — 1 g single dose is curative, while 3 weekly doses are required for lymphogranuloma venereum. It is also the drug of choice for chlamydial pneumonia and is being preferred over tetracycline for trachoma in the eye.

(c) Donovanosis caused by *Calymmatobacterium granulomatis*: 500 mg OD for 7 days or 1.0 g weekly for 4 weeks is as effective as doxycycline.

(d) Chancroid and PPNG urethritis: single 1.0 g dose is highly curative.

The other indications of azithromycin are pharyngitis, tonsillitis, sinusitis, otitis media, pneumonias, acute exacerbations of chronic bronchitis, streptococcal and some staphylococcal skin and soft tissue infections. In combination with at least one other drug it is effective in the prophylaxis and treatment of MAC in AIDS patients. Other potential uses are in typhoid, toxoplasmosis and malaria.

Dose: 500 mg once daily 1 hour before or 2 hours after food (food decreases bioavailability); (children above 6 month—10 mg/kg/day for 3 days is sufficient for most infections.

AZITHRAL 250, 500 mg cap and 250 mg per 5 ml dry syr; **AZIWOK** 250 mg cap, 100 mg kid tab, 100 mg/5 ml and 200 mg/5 ml susp. **AZIWIN** 100, 250, 500 mg tab, 200 mg/5 ml liq. Also **AZITHRAL** 500 mg inj.

Side effects are mild gastric upset, abdominal pain (less than erythromycin), headache and dizziness. Azithromycin has been found not to affect hepatic CYP3A4 enzyme. Interaction with theophylline, carbamazepine, warfarin, terfenadine and cisapride is not likely.

Spiramycin This macrolide antibiotic, though available for more than a decade, has been employed only sporadically. It resembles erythromycin in spectrum of activity and properties. Distinctively, it has been found to limit risk of transplacental transmission of *Toxoplasma gondii* infection. Its specific utility is for toxoplasmosis and recurrent abortion in pregnant women; 3 week courses of 3 MU 2–3 times a day are repeated after 2 week gaps till delivery. Other indications are similar to erythromycin,

for which 6 MU/day is given for 5 days. Side effects are gastric irritation, nausea, diarrhoea and rashes.

ROVAMYCIN 1.5 MU, 3 MU tabs, 0.375 MU/ 5 ml susp.

LINCOSAMIDE ANTIBIOTICS

Clindamycin

This potent lincosamide antibiotic is similar in mechanism of action (inhibits protein synthesis by binding to 50S ribosome) and spectrum of activity to erythromycin with which it exhibits partial cross resistance. Modification of the ribosomal binding site by constitutive methylase enzyme confers resistance to both. It inhibits most gram-positive cocci (including penicillinase producing *Staph.*, but not MRSA), *C. diphtheriae*, *Nocardia*, *Actinomyces*, *Toxoplasma*, but the distinctive feature is its high activity against a variety of anaerobes, especially *Bact. fragilis*. Aerobic gram-negative bacilli, spirochetes, *Chlamydia*, *Mycoplasma* and *Rickettsia* are not affected.

Oral absorption of clindamycin is good. It penetrates into most skeletal and soft tissues, but not in brain and CSF; accumulates in neutrophils and macrophages. It is largely metabolized and metabolites are excreted in urine and bile. The $t_{1/2}$ is 3 hr.

Side effects are rashes, urticaria, abdominal pain, but the major problem is diarrhoea and pseudomembranous enterocolitis due to *Clostridium difficile* superinfection which is potentially fatal. The drug should be promptly stopped and metronidazole (alternatively vancomycin) given to treat it.

Because of potential toxicity, use of clindamycin is restricted to anaerobic and mixed infections, especially by *Bact. fragilis* causing abdominal, pelvic and lung abscesses. It is generally combined with an aminoglycoside or cephalosporin. Metronidazole and chloramphenicol are the alternatives to clindamycin for covering the anaerobes. Anaerobic streptococcal and *Cl. perfringens* infections and those involving bone and joints respond well. It has also been employed for prophylaxis of endocarditis in penicillin allergic patients with valvular defects

who undergo dental surgery, as well as to prevent surgical site infection in colorectal/pelvic surgery.

In AIDS patients, it has been combined with pyrimethamine for toxoplasmosis and with primaquine for *Pneumocystis jiroveci* pneumonia. Topically it can be used for infected acne vulgaris.

Clindamycin, erythromycin and chloramphenicol can exhibit mutual antagonism, probably because their ribosomal binding sites are proximal; binding of one hinders access of the other to its target site. Clindamycin weakly potentiates neuromuscular blockers.

Dose: 150–300 mg QID oral; 200–600 mg i.v. 8 hourly; DALCAP 150 mg cap; CLINCIN 150, 300 mg cap; DALCIN 150, 300 mg cap, 300 mg/2 ml and 600 mg/4 ml inj.

Lincomycin

It is the forerunner of clindamycin; has similar antibacterial and toxic properties, but is less potent and produces a higher incidence of diarrhoea and colitis—deaths have occurred. Thus, it has been largely replaced by clindamycin. It is absorbed orally and excreted mainly in bile; plasma $t_{1/2}$ 5 hrs.

Dose: 500 mg TDS-QID oral; 600 mg i.m. or by i.v. infusion 6–12 hrly.

LINCOCIN 500 mg cap, 600 mg/2 ml inj; LYNX 250, 500 mg cap, 125 mg/5 ml syr, 300 mg/ml inj in 1, 2 ml amp.

GLYCOPEPTIDE ANTIBIOTICS

Vancomycin

It is a glycopeptide antibiotic discovered in 1956 as a penicillin substitute which has assumed special significance due to efficacy against MRSA, *Strep. viridans*, *Enterococcus* and *Cl. difficile*. It is bactericidal to gram-positive cocci, *Neisseria*, *Clostridia* and diphtheroids. However, in hospitals where it has been extensively used for surgical prophylaxis, etc., vancomycin-resistant *Staph. aureus* (VRSA) and vancomycin-resistant *Enterococcus* (VRE) have emerged. These nosocomial bacteria are resistant to methicillin and most other antibiotics as well.

Vancomycin acts by inhibiting bacterial cell wall synthesis. It binds to the terminal dipeptide 'D-ala-D-ala' sequence of peptidoglycan units—prevents its release from the bactoprenol lipid

carrier so that assembly of the units at the cell membrane and their cross linking to form the cell wall cannot take place (see Fig. 51.2). Enterococcal resistance to vancomycin is due to a plasmid mediated alteration of the dipeptide target site, reducing its affinity for vancomycin.

Vancomycin is not absorbed orally. After i.v. administration, it is widely distributed, penetrates serous cavities, inflamed meninges and is excreted mainly unchanged by glomerular filtration with a $t_{1/2}$ of 6 hours. Dose reduction is needed in renal insufficiency.

Toxicity: Systemic toxicity of vancomycin is high. It can cause plasma concentration-dependent nerve deafness which may be permanent. Kidney damage is also dose-related. Other oto- and nephrotoxic drugs like aminoglycosides must be very carefully administered when vancomycin is being used. Skin allergy and fall in BP during i.v. injection, due to histamine release from mast cells, are the other problems. Rapid i.v. injection has caused chills, fever, urticaria and intense flushing—called 'Red man syndrome'.

Uses: Given orally (125–500 mg 6 hourly), it is the second choice drug to metronidazole for antibiotic associated pseudomembranous enterocolitis caused by *C. difficile*.

Systemic use (500 mg 6 hourly or 1 g 12 hourly infused i.v. over 1 hr) is restricted to serious MRSA infections for which it is the most effective drug, and as a penicillin substitute (in allergic patients) for enterococcal endocarditis along with gentamicin. For empirical therapy of bacterial meningitis, i.v. vancomycin is usually combined with i.v. ceftriaxone/cefotaxime. It is also used in dialysis patients and those undergoing cancer chemotherapy. Penicillin-resistant pneumococcal infections and infection caused by diphtheroids respond very well to vancomycin.

It is the preferred surgical prophylactic in MRSA prevalent areas and in penicillin allergic patients.

VANCOIN-CP 150 mg tab, 500 mg/vial inj;
VANCOGEN, VANCORID-CP 500 mg/vial inj;
VANCOLED 0.5, 1.0 g inj.

Teicoplanin It is a newer glycopeptide antibiotic which in fact is a mixture of 6 similar compounds. It is active against gram-positive bacteria only; mechanism of action and spectrum of activity is similar to vancomycin. Notable features are:

- It is more active than vancomycin against enterococci, and equally active against MRSA.
- Some VRE but not VRSA are susceptible to teicoplanin.
- It can be injected i.m. as well; is excreted by kidney; dose needs to be reduced in renal insufficiency; has a very long $t_{1/2}$ (3–4 days).
- Toxicity is less than vancomycin; adverse effects are rashes, fever, granulocytopenia and rarely hearing loss. Reactions due to histamine release are rare (1 in 2500).

Teicoplanin is indicated in enterococcal endocarditis (along with gentamicin); MRSA and penicillin resistant streptococcal infections, osteomyelitis, as alternative to vancomycin.

Dose: 400 mg first day—then 200 mg daily i.v. or i.m.; severe infection 400 mg \times 3 doses 12 hourly—then 400 mg daily.

TARGOCID 200, 400 mg per vial inj. for reconstitution.

OXAZOLIDINONE

Linezolid This is the first member of a new class of synthetic AMAs 'Oxazolidinones' which has become available for the treatment of resistant gram-positive coccal (aerobic and anaerobic) and bacillary infections. It is active against MRSA and some VRSA, VRE, penicillin-resistant *Strep. pyogenes*, *Strep. viridans* and *Strep. pneumoniae*, *M. tuberculosis*, *Corynebacterium*, *Listeria*, *Clostridia* and *Bact. fragilis*. It is primarily bacteriostatic, but can exert cidal action against some streptococci, pneumococci and *B. fragilis*. Gram-negative bacteria are not affected.

Linezolid inhibits bacterial protein synthesis by acting at an early step and a site different from that of other AMAs. It binds to the 23 S fraction of the 50S ribosome and interferes with formation of the ternary N-formylmethionine-tRNA (tRNA^{Met}) -70S initiation complex. Binding of linezolid distorts the tRNA binding site overlapping both

50S and 30S ribosomal subunits and stops protein synthesis before it starts. As such, there is no cross resistance with any other class of AMAs.

Linezolid is rapidly and completely absorbed orally, partly metabolized nonenzymatically and excreted in urine. Plasma $t_{1/2}$ is 5 hrs. Dose modification has not been necessary in renal insufficiency.

Linezolid has been used for uncomplicated and complicated skin and soft tissue infections, community and hospital-acquired pneumonias, bacteraemias and other drug-resistant gram-positive infections by oral and i.v. routes with 83–94% cure rates. However, to prevent emergence of resistance to this valuable drug, use should be restricted to serious hospital-acquired pneumonias, febrile neutropenia, wound infections and others caused by multidrug-resistant gram-positive bacteria such as VRE, vancomycin resistant-MRSA, multi-resistant *S. pneumoniae*, etc. Being bacteriostatic, it is not suitable for treatment of enterococcal endocarditis.

Dose: 600 mg BD, oral/ i.v.; **LIZOLID** 600 mg tab; **LINOX** 600 mg tab, 200 mg/100 ml i.v. infusion.

Side effects to linezolid have been few; mostly mild abdominal pain and bowel upset. Occasionally, rash, pruritus, headache, oral/vaginal candidiasis have been reported. Neutropenia and thrombocytopenia are infrequent and usually mild. Because linezolid is a MAO inhibitor, interactions with adrenergic/serotonergic drugs and excess dietary tyramine are expected. No cytochrome P450 enzyme related interactions seem likely.

Quinupristin/Dalfopristin It is a recently developed combination of two semisynthetic pristinamycin antibiotics which together exert synergistic inhibition of bacterial protein synthesis. It is active against most gram-positive cocci including MRSA, some VRSA and some VRE; as well as certain *Neisseria*, *Legionella* and *Chlamydia pneumoniae*. The combination is bactericidal against strepto and staphylococci but bacteriostatic against *E. faecium*.

It is being used in Europe, USA and some other countries for serious nosocomial MRSA, VRE and other resistant gram positive infections.

Mupirocin This topically used antibiotic obtained from a species of *Pseudomonas* is active mainly against gram-

positive bacteria, including *Strep. pyogenes* (penicillin sensitive/resistant), *Staph aureus*. MRSA, etc. It inhibits bacterial protein synthesis by blocking the production of t-RNA for isoleucine. As such, no cross resistance with any other antibiotic is seen. Though primarily bacteriostatic, high concentrations applied topically may be bactericidal. It is indicated in furunculosis, folliculitis, impetigo, infected insect bites and small wounds. Local itching, irritation and redness may occur.

BACTROBAN, MUPIN, T-BACT 2% oint. for topical application thrice daily.

Fusidic acid

It is a narrow spectrum steroidal antibiotic, blocks bacterial protein synthesis and is active against penicillinase producing *Staphylococci* and few other gram-positive bacteria. It is used only topically for boils, folliculitis, sycosis barbae and other cutaneous infections.

FUCIDIN-L, FUCIBACT, FUSIDERM; 2% oint. and cream.

POLYPEPTIDE ANTIBIOTICS

These are low molecular weight cationic polypeptide antibiotics. All are powerful bactericidal agents, but not used systemically due to toxicity. All are produced by bacteria. Clinically used ones are:

Polymyxin B	Bacitracin
Colistin	Tyrothricin

Polymyxin B and Colistin Polymyxin and colistin were obtained in the late 1940s from *Bacillus polymyxa* and *B. colistinus* respectively. They are active against gram-negative bacteria only; all except *Proteus*, *Serratia* and *Neisseria* are inhibited. Both have very similar range of activity, but colistin is more potent on *Pseudomonas*, *Salmonella* and *Shigella*.

Mechanism of action They are rapidly acting bactericidal agents; have a detergent-like action on the cell membrane. They have high affinity for phospholipids: the peptide molecules (or their aggregates) orient between the phospholipid and protein films in gram-negative bacterial cell membrane causing membrane distortion or pseudopore formation. As a result ions, amino acids, etc. leak out. Sensitive bacteria take up more of the antibiotic. They may also inactivate the bacterial endotoxin.

They exhibit synergism with many other AMAs by improving their penetration into the bacterial cell.

Resistance Resistance to these antibiotics has never been a problem. There is no cross resistance with any other AMA.

Adverse effects Little or no absorption occurs from oral route or even from denuded skin (burn, ulcers). Applied topically, they are safe—no systemic effect or sensitization occurs. A rash is rare.

- Given orally, side effects are limited to the g.i.t.—occasional nausea, vomiting, diarrhoea.
- Systemic toxicity of these drugs (when injected) is high: flushing and paresthesias (due to liberation of histamine from mast cells), marked kidney damage, neurological disturbances, neuromuscular blockade.

Preparation and dose

Polymyxin B: (1 mg = 10,000 U)

NEOSPORIN POWDER: 5000 U with neomycin sulf. 3400 U and bacitracin 400 U per g.

NEOSPORIN EYE DROPS: 5000 U with neomycin sulf. 1700 U and gramicidin 0.25 mg per ml.

NEOSPORIN-H EAR DROPS: 10,000 U with neomycin sulf. 3400 U and hydrocortisone 10 mg per ml.

Colistin sulfate: 25–100 mg TDS oral; WALAMYCIN 12.5 mg (25000 i.u.) per 5 ml dry syr, COLISTOP 12.5 mg/5 ml and 25 mg/5 ml dry syr.

Uses

(a) *Topically* Usually in combination with other antimicrobials for skin infections, burns, otitis externa, conjunctivitis, corneal ulcer—caused by gram-negative bacteria including *Pseudomonas*.

(b) *Orally* Gram-negative bacillary (*E. coli*, *Salmonella*, *Shigella*) diarrhoeas, especially in infants and children; *Pseudomonas* superinfection enteritis.

Bacitracin It is one of the earliest discovered antibiotics from a strain of *Bacillus subtilis*. In contrast to polymyxin, it is active mainly against gram-positive organisms (both cocci and bacilli). *Neisseria*, *H. influenzae* and few other bacteria are also affected.

It acts by inhibiting cell wall synthesis at a step earlier than that inhibited by penicillin. Subsequently, it increases the efflux of ions by binding to cell membrane. It is bactericidal.

Bacitracin is not absorbed orally. It is not used parenterally because of high toxicity, especially to the kidney. Use is restricted to topical application for infected wounds, ulcers, eye infections—generally in combination with neomycin, polymyxin, etc.

In NEBASULF 250 U/g powder, skin oint, eye oint; in NEOSPORIN 400 U/g powder. (1 U = 26 µg).

It does not penetrate intact skin, therefore, of little value in furunculosis, boils, carbuncles, etc.

Tyrothricin It is a mixture of *gramicidin* and *tyrocidin*, obtained from *Bacillus brevis*. It is active against gram-positive and a few gram-negative bacteria. It acts on cell membrane causing leakage and uncouples oxidative phosphorylation in the bacteria.

Tyrothricin is not absorbed orally and is too toxic for systemic use; causes haemolysis. Used only topically; does not cause sensitization.

TYRODERM: 0.5 mg/g skin cream; **PROTHRICIN** 0.2 mg/ml topical solution.

TYOTOCIN: 0.05% otic solution with benzocaine 1.25% antipyrine 5%, hexylresorcinol 0.1%.

URINARY ANTISEPTICS

Some AMAs, in orally tolerated doses, attain antibacterial concentration only in urine, with little or no systemic antibacterial effect. Like many other drugs, they are concentrated in the kidney tubules, and are useful mainly in lower urinary tract infection. They have been called *urinary antiseptics* because this may be considered as a form of local therapy. Nitrofurantoin and methenamine are two such agents; infrequently used now. Nalidixic acid (*see p. 687*) can also be considered to be a urinary antiseptic.

Nitrofurantoin

It is primarily bacteriostatic, but may be cidal at higher concentrations and in acidic urine: its activity is enhanced at lower pH. It inhibits many gram-negative bacteria, but due to development of resistance, activity is now restricted largely to *E. coli*. Resistance to nitrofurantoin develops slowly and no cross resistance with any other AMA is known. It antagonizes the bactericidal action of nalidixic acid. Susceptible bacteria appear to enzymatically reduce nitrofurantoin to generate reactive intermediates which damage DNA.

Pharmacokinetics Nitrofurantoin is well absorbed orally; rapidly metabolized in liver and other tissues; less than half is excreted unchanged in urine; plasma $t_{1/2}$ is 30–60 min. Antibacterial concentrations are not attained in blood or tissues. Probenecid inhibits its tubular secretion and reduces the concentration attained in urine—may interfere with its urinary antiseptic action. Renal excretion is reduced in azotaemic patients; effective concentrations may not be reached in urine, while toxicity increases: contraindicated in renal failure; also during pregnancy and in neonates.

Adverse effects Commonest is gastrointestinal intolerance—nausea, epigastric pain and diarrhoea.

An acute reaction with chills, fever and leucopenia occurs occasionally.

Peripheral neuritis and other neurological effects are reported with long-term use. Haemolytic anaemia is rare, except in G-6-PD deficiency. Liver damage and a pulmonary reaction with fibrosis on chronic use are infrequent events.

Urine of patients taking nitrofurantoin turns dark brown on exposure to air.

Use The only indication for nitrofurantoin is uncomplicated lower urinary tract infection, but it is infrequently used now. Acute infections due to *E. coli* can be treated with 50–100 mg TDS, given for 5–10 days. These doses should not be used for > 2 weeks at a time. Suppressive long-term treatment has been successful with 50 mg BD. It is also employed for prophylaxis of urinary tract infection when catheterization or instrumentation of the lower urinary tract is performed.

FURADANTIN 50, 100 mg tab, 25 mg/5 ml susp.

TRIFURAN: nitrofurantoin 50 mg + trimethoprim 40 mg + deglycylrhizinised liquorice 200 mg tab.

Methenamine (Hexamine)

It is hexamethylene-tetramine; inactive as such; decomposes slowly in acidic urine to release formaldehyde which inhibits all bacteria. This drug exerts no antimicrobial activity in blood and tissues, including kidney parenchyma. Acidic urine is essential for its action; urinary pH must be kept below 5.5 by administering some organic acid which is excreted as such, e.g. mandelic acid or ascorbic acid.

Methenamine is administered in enteric coated tablets to protect it from decomposing in gastric juice. Mandelic acid itself is a urinary antiseptic in high doses, also lowers pH of urine. However, the amount taken with methenamine (as methenamine mandelate) is inadequate in its own right: serves only to promote decomposition of methenamine.

MANDELAMINE 0.5 g, 1 g tab: 1 g TDS or QID with fluid restriction (daily urine volume between 1–1.5 L) to ensure adequate concentration of formaldehyde in urine.

It is not a good drug for acute urinary tract infections or for catheterization prophylaxis. Its use is restricted to chronic, resistant type of urinary tract infections, not involving kidney substance. Resistance to formaldehyde does not occur, but methenamine is not popular now.

Adverse effects Gastritis can occur due to release of formaldehyde in stomach—patient compliance is often poor due to this.

Chemical cystitis and haematuria may develop with high doses given for long periods. CNS symptoms are produced occasionally.

Methenamine mandelate is contraindicated in renal failure (mandelic acid accumulates in blood → acidosis) and in liver disease (the released NH_3 is not detoxified).

Sulfonamides combine chemically with methenamine in urine resulting in antagonism.

Phenazopyridine It is an orange dye which exerts analgesic action in the urinary tract and affords symptomatic relief of burning sensation, dysuria and urgency due to cystitis. It does not have antibacterial property. Side effects are nausea and epigastric pain.

Dose: 200–400 mg TDS: **PYRIDIUM** 200 mg tab.

TREATMENT OF URINARY TRACT INFECTIONS

The general principles of use of AMAs for urinary tract infections (UTIs) remain the same as for any other infection. Some specific considerations are highlighted below.

Most UTIs are caused by gram-negative bacteria, especially coliforms. Majority of acute infections involve a single organism (commonest is *E. coli*); chronic and recurrent infections may be mixed infections. Acute infections are largely self limiting; high urine flow rates with frequent bladder voiding may suffice. Many single dose antimicrobial treatments have been successfully tried, but a three day regimen is considered optimal for lower UTIs. Upper UTIs require more aggressive and longer treatment. In any case, treatment for more than 2 weeks is seldom warranted.

Bacteriological investigations are very important to direct the choice of drug. Though, treatment may not wait till report comes, urine sample must be collected for bacteriology before commencing therapy. Most AMAs attain high concentrations in urine, smaller than usual doses may be effective in lower UTIs—antibacterial action in urine is sufficient, mucosa takes care of itself. In upper UTI (pyelonephritis) antimicrobial activity in kidney tissue is needed—doses are similar to any systemic infection.

The least toxic and cheaper AMA should be used just long enough to eradicate the pathogen. It is advisable to select a drug which does not disrupt normal gut and perineal flora. If recurrences are frequent, chronic suppressive treatment with cotrimoxazole, nitrofurantoin, methenamine, cephalexin or norfloxacin may be given.

The commonly used antimicrobial regimens for empirical therapy of uncomplicated acute UTI are given in the box.

The status of AMAs (other than urinary antiseptics) in urinary tract infections is summarized below:

1. Sulfonamides Dependability in acute UTIs has decreased: not used now as single drug. May

Antimicrobial regimens for acute UTI (all given orally for 3–5 days)*

1. Norfloxacin 400 mg 12 hourly
2. Ciprofloxacin 250 mg 12 hourly
3. Cotrimoxazole 960 mg 12 hourly
4. Cephalexin 250 mg 6 hourly
5. Cefpodoxime proxetil 200 mg 12 hourly
6. Amoxicillin + clavulanic acid (500 + 125 mg) 8 hourly
7. Nitrofurantoin 50 mg 8 hourly or 100 mg 12 hourly × 5–7 days

* For upper UTI, the same drugs may be given for 10–14 days. Nitrofurantoin is not suitable for pyelonephritis.

occasionally be employed for suppressive and prophylactic therapy.

2. Cotrimoxazole Though response rate and use have declined, it may be employed empirically in acute UTI without bacteriological data, because majority of urinary pathogens, including *C. trachomatis*, are covered by cotrimoxazole. It should not be used to treat UTI during pregnancy.

3. Quinolones The first generation FQs, especially norfloxacin and ciprofloxacin are highly effective and currently the most popular drugs, because of potent action against gram-negative bacilli and low cost. Nalidixic acid is also employed. However, to preserve their efficacy, use should be restricted. FQs are particularly valuable in complicated cases, those with prostatitis or indwelling catheters and for bacteria resistant to cotrimoxazole/ampicillin. The FQs should not be given to pregnant women.

4. Ampicillin/Amoxicillin Frequently used in the past as first choice drug for initial treatment of acute infections without bacteriological data, but higher failure and relapse rates have made them unreliable for empirical therapy. Many *E. coli* strains are now ampicillin-resistant. Amoxicillin + clavulanic acid is more frequently employed.

5. Cloxacillin Use is restricted to penicillinase producing staphylococcal infection, which is uncommon in urinary tract.

6. Piperacillin/Carbenicillin Only in serious *Pseudomonas* infection in patients with indwelling catheters or chronic obstruction, and in hospitalized patients.

Table 54.1: Regimens for the treatment of sexually transmitted diseases

DISEASE/CAUSATIVE ORGANISM	1st Choice	TREATMENT	Alternatives
1. Gonorrhoea Nonpenicillinase producing Penicillinase producing	Amoxicillin 3 g oral, or Ampicillin 3.5 g oral Ceftriaxone 250 mg i.m. or Cefuroxime 250 mg i.m. or Azithromycin 1.0 g oral single dose	+ Probenecid 1 g oral single dose + Probenecid 1 g oral single dose	Cefixime 400 mg once oral, or Doxycycline 100 mg BD × 7 days oral, or Erythromycin 500 mg QID × 5 days oral, or Ciprofloxacin 250–500 mg oral once or Ofloxacin 200–400 mg oral once
2. Syphilis Early (Primary, Secondary and Latent <1 yr) Late (>1 yr)	Benzathine Pen. 2.4 MU i.m., 1–3 weekly inj., or Proc. Pen.G 1.2 MU i.m. × 10 days Benzathine Pen. 2.4 MU i.m. weekly × 4 weeks, or Proc. Pen.G 1.2 MU i.m. × 20 days		Doxycycline 100 mg BD oral × 15 days, or Ceftriaxone 1 g i.m. × 7 days, or Erythromycin 500 mg QID oral × 15 days Doxycycline or Erythromycin for 30 days, or Ceftriaxone 1 g i.m./i.v. × 15 days.
3. Chlamydia trachomatis Nonspecific urethritis Lymphogranuloma venereum	Azithromycin 1 g oral single dose or Doxycycline 100 mg BD oral × 7 days Azithromycin 1.0 g oral weekly × 3 weeks or Doxycycline 100 mg BD oral × 3 weeks (aspirate fluctuant lymph node)		Erythromycin 500 mg QID oral × 7 days Erythromycin 500 mg QID oral × 3 weeks
4. Granuloma inguinale/Donovanosis (<i>Calymni. granulomatis</i>)	Tetracycline 500 mg QID oral × 3 weeks or Doxycycline 100 mg BD oral × 3 weeks or Azithromycin 500 mg OD oral × 7 days or 1.0 weekly oral × 4 weeks		Erythromycin 500 mg QID oral × 3 weeks
5. Chancroid (<i>H. ducreyi</i>)	Ceftriaxone 0.25 g i.m. single dose or Azithromycin 1.0 g oral single dose or Erythromycin 0.5 g QID oral × 7 days		Ciprofloxacin 500 mg BD oral × 3 days or Doxycycline 100 mg BD oral × 7 days or Cotrimoxazole 960 mg BD oral × 14 days
6. Genital Herpes simplex First episode Recurrent episode Suppressive treatment	Acyclovir 200 mg 5 times a day/400 mg TDS oral × 10 days or Valaciclovir 0.5–1.0 g BD oral × 10 days or Famciclovir 250 mg TDS oral × 5 days (Acyclovir 5% oint locally 6 times a day × 10 days may afford relief in mild cases) The above drugs are given for 3–5 days (Topical acyclovir is ineffective) Acyclovir 400 mg BD oral × 6–12 months or Valaciclovir 500 mg OD oral × 6–12 months or Famciclovir 250 mg BD oral × 6–12 months		Does not prevent recurrences
7. Trichomonas vaginitis	Metronidazole 2 g single dose or 400 mg TDS × 7 days, or Tinidazole 2 g single dose or 600 mg OD × 7 days (treat the male partner also if recurrent)		Clotrimazole 100 mg intravaginal. every night × 6 to 12 days

7. Cephalosporins Use is increasing, especially in women with nosocomial *Klebsiella* and *Proteus* infections; should normally be used only on the basis of sensitivity report, but empirical use for community acquired infection is also common. Some guidelines recommend them as alternative drugs.

8. Gentamicin Very effective against most urinary pathogens including *Pseudomonas*. However, because of narrow margin of safety and need for parenteral administration, it is generally used only on the basis of *in vitro* bacteriological sensitivity testing. The newer aminoglycosides may be needed for hospital-acquired infections.

9. Chloramphenicol Though effective in many cases, use should be restricted, for fear of toxicity, to pyelonephritis in cases where the causative bacteria is sensitive only to this antibiotic.

10. Tetracyclines They are seldom effective now, because most urinary pathogens have become resistant. Though broad spectrum, they are used only on the basis of sensitivity report and in *Ch. trachomatis* cystitis.

Urinary pH in relation to use of AMAs

Certain AMAs act better in acidic urine, while others in alkaline urine. However, specific intervention to produce urine of desired reaction (by administering acidifying or alkalinizing agents) is seldom required (except for methenamine), because most drugs used in UTI attain high concentration in urine and minor changes in urinary pH do not affect clinical outcome. In case of inadequate response or in complicated cases,

measurement of urinary pH and appropriate corrective measure may help.

In certain urease positive *Proteus* (they split urea present in urine into NH_3) infections it is impossible to acidify urine. In such cases, acidification should not be attempted and drugs which act better at higher pH should be used.

Urinary infection in patients with renal impairment

This is relatively difficult to treat because most AMAs attain lower urinary concentration. Methenamine mandelate, tetracyclines (except doxycycline) and certain cephalosporins are contraindicated.

Nitrofurantoin, nalidixic acid and aminoglycosides are better avoided. Still, every effort must be made to cure the infection, because if it persists, kidneys may be further damaged. Bacteriological testing and followup cultures are a must to select the appropriate drug and to ensure eradication of the pathogen. Potassium salts and acidifying agents are contraindicated.

Prophylaxis for urinary tract infection

This may be given when:

- Catheterization or instrumentation inflicting trauma to the lining of the urinary tract is performed; bacteremia frequently occurs and injured lining is especially susceptible.
- Indwelling catheters are placed.
- Uncorrectable abnormalities of the urinary tract are present.
- Inoperable prostate enlargement or other chronic obstruction causes urinary stasis.

TREATMENT OF SEXUALLY TRANSMITTED DISEASES (STDs)

The effectiveness of various AMAs in treating different STDs is described with the individual drugs. The preferred drugs and regimens for important STDs are summarized in Table 54.1.

Favourable urinary pH for antimicrobial action

Acidic	Alkaline	pH immaterial
Nitrofurantoin	Cotrimoxazole	Chloramphenicol
Methenamine	Aminoglycosides	Ampicillin
Tetracyclines	(Gentamicin, etc.)	Colistin
Cloxacillin	Cephalosporins	
	Fluoroquinolones	

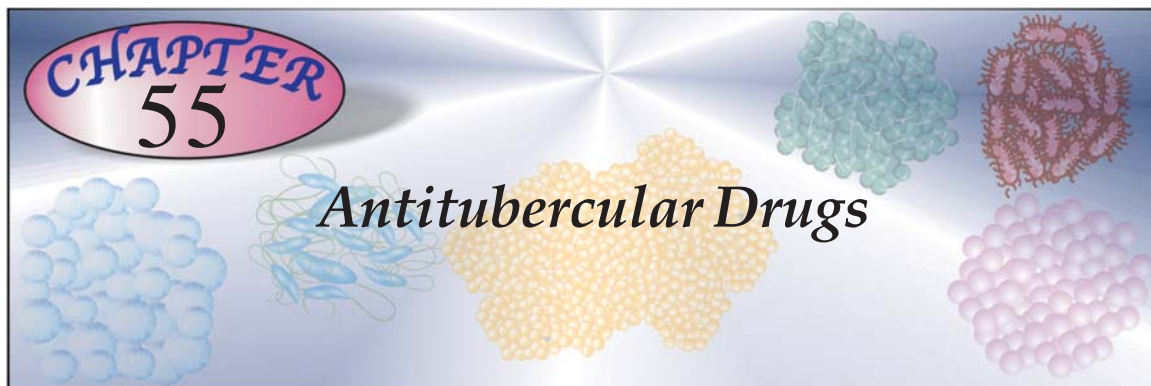

Tuberculosis is a chronic granulomatous disease and a major health problem in developing countries. About 1/3rd of the world's population is infected with *Mycobact. tuberculosis*. As per WHO estimate, 9 million people globally develop active TB and 1.7 million die of it annually. In India, it is estimated that nearly 2 million people develop active disease every year and about 0.5 million die from it.

A new dimension got added in the 1980s due to spread of HIV with high prevalence of tuberculosis and *Mycobact. avium* complex (MAC) infection among these patients. India has a large load of HIV infected subjects, and these patients are especially vulnerable to severe forms of tubercular/MAC infection. While lately, the increase in TB case rate associated with HIV infection has been halted in the USA, no such trend is apparent in India. Emergence of 'multidrug resistant' (MDR) TB of which over 0.4 million cases are occurring globally every year, is threatening the whole future of current antitubercular chemotherapy.

Remarkable progress has been made in the last 60 years since the introduction of *Streptomycin* in 1947 for the treatment of tuberculosis. Its

full therapeutic potential could be utilized only after 1952 when *isoniazid* was produced to accompany it. The discovery of *ethambutol* in 1961, *rifampin* in 1962, and redefinition of the role of *pyrazinamide* has changed the strategies in the chemotherapy of tuberculosis. Since 1970 the efficacy of short course (6–9 months) and domiciliary regimens has been demonstrated and clear-cut treatment guidelines have been formulated.

Fluoroquinolones, newer macrolides and some rifampin congeners are the recent additions to the antimycobacterial drugs. According to their clinical utility the anti-TB drugs can be divided into:

First line: These drugs have high antitubercular efficacy as well as low toxicity; are used routinely.

Second line: These drugs have either low antitubercular efficacy or high toxicity or both; are used in special circumstances only.

First line drugs

1. Isoniazid (H)
2. Rifampin (R)
3. Pyrazinamide (Z)
4. Ethambutol (E)
5. Streptomycin (S)

Second line drugs

- | | |
|----------------------------------|--------------------|
| 1. Thiacetazone (Tzn) | <i>Newer drugs</i> |
| 2. Paraaminosalicylic acid (PAS) | 1. Ciprofloxacin |
| 3. Ethionamide (Etm) | 2. Ofloxacin |
| 4. Cycloserine (Cys) | 3. Clarithromycin |
| 5. Kanamycin (Kmc) | 4. Azithromycin |
| 6. Amikacin (Am) | 5. Rifabutin |
| 7. Capreomycin (Cpr) | |

Isoniazid (Isonicotinic acid hydrazide, H)

Isoniazid is the antitubercular drug par excellence, and an essential component of all antitubercular regimens, unless the patient is not able to tolerate it or bacilli are resistant. It is primarily tuberculocidal. Fast multiplying organisms are rapidly killed, but quiescent ones are only inhibited. It acts on extracellular as well as on intracellular TB (bacilli present within macrophages); is equally active in acidic and alkaline medium. It is one of the cheapest antitubercular drugs. However, most atypical mycobacteria are not inhibited by INH.

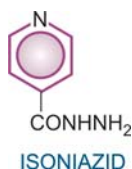

The most plausible mechanism of action of INH is inhibition of synthesis of *mycolic acids* which are unique fatty acid component of mycobacterial cell wall. This may explain the high selectivity of INH for mycobacteria (it is not active against any other microorganism). The lipid content of mycobacteria exposed to INH is reduced. A gene labelled *inh A* which encodes for a fatty acid synthase enzyme is the target of INH action. The sensitive mycobacteria concentrate INH and convert it by a catalase-peroxidase enzyme into an active metabolite that interacts with the *inh A* gene.

About 1 in 10^6 tubercle bacilli is inherently resistant to clinically attained INH concentra-

tions. If INH is given alone, such bacilli proliferate selectively and after 2–3 months (sometimes even earlier) an apparently resistant infection emerges. The most common mechanism of INH resistance is by mutation of the catalase-peroxidase gene so that the bacilli do not generate the active metabolite of INH. However, bacilli that lose catalase activity also appear to become less virulent; many physicians like to continue INH even when bacilli are apparently resistant to it *in vitro*. INH resistance may also involve mutation in the target *inh A* gene. Other resistant TB bacilli lose the active INH concentrating process. The incidence of primary INH resistance varies widely (1–33%) among different populations, depending on the extent of use and misuse of INH in that area. Combined with other drugs, INH has good resistance preventing action. No cross resistance with other antitubercular drugs occurs.

Pharmacokinetics INH is completely absorbed orally and penetrates all body tissues, tubercular cavities, placenta and meninges. It is extensively metabolized in liver; most important pathway being acetylation—metabolites are excreted in urine. The rate of INH acetylation shows genetic variation. There are either:

Fast acetylators	
(30–40% of Indians)	$t_{1/2}$ of INH 1 hr.
Slow acetylators	
(60–70% of Indians)	$t_{1/2}$ of INH 3 hr.

The proportion of fast and slow acetylators differs in different parts of the world. However, acetylator status does not matter if INH is taken daily, but biweekly regimens are less effective in fast acetylators. Isoniazid induced peripheral neuritis appears to be more common in slow acetylators.

Interactions Aluminium hydroxide inhibits INH absorption.

INH inhibits phenytoin, carbamazepine, diazepam and warfarin metabolism: may raise their blood levels.

PAS inhibits INH metabolism and prolongs its $t_{1/2}$.

Dose of all first line drugs is given in Table 55.1.

Adverse effects INH is well tolerated by most patients. Peripheral neuritis and a variety of neurological manifestations (paresthesias, numbness, mental disturbances, rarely convulsions) are the most important dose-dependent toxic effects. These are due to interference with utilization of pyridoxine and its increased excretion in urine (see Ch. 67). Pyridoxine given prophylactically (10 mg/day) prevents the neurotoxicity even with higher doses, but routine use is not mandatory. INH neurotoxicity is treated by pyridoxine 100 mg/day.

Hepatitis, a major adverse effect of INH, is rare in children, but more common in older people and in alcoholics. It is due to dose-related damage to liver cells and is reversible on stopping the drug.

Other side effects are rashes, fever, acne and arthralgia.

ISONEX 100, 300 mg tabs, ISOKIN 100 mg tab, 100 mg per 5 ml liq.

Rifampin (Rifampicin, R)

It is a semisynthetic derivative of rifamycin B obtained from *Streptomyces mediterranei*. Rifampin is bactericidal to *M. tuberculosis* and many other gram-positive and gram-negative bacteria like *Staph. aureus*, *N. meningitidis*, *H. influenzae*, *E. coli*, *Klebsiella*, *Pseudomonas*, *Proteus* and *Legionella*. Against TB bacilli, it is as efficacious as INH and better than all other drugs. The bactericidal action covers all subpopulations of TB bacilli, but acts best on slowly or intermittently (spurters) dividing ones, as well as on many atypical mycobacteria. Both extra- and intracellular organisms are affected. It has good sterilizing and resistance preventing actions.

Rifampin inhibits DNA dependent RNA synthesis. Probably, the basis of selective toxicity is that mammalian RNA polymerase does not avidly bind rifampin.

Mycobacteria and other organisms develop resistance to rifampin rather rapidly. However, the incidence of resistant TB is less than 10^{-7} and it is quite unusual for a patient to have primary

rifampin resistant tubercular infection. Rifampin resistance is nearly always due to mutation in the *repO*B gene (for the β subunit of RNA polymerase—the target of rifampin action) reducing its affinity for the drug. No cross resistance with any other antitubercular drug has been noted.

Pharmacokinetics It is well absorbed orally, widely distributed in the body: penetrates cavities, caseous masses, placenta and meninges. It is metabolized in liver to an active deacetylated metabolite which is excreted mainly in bile, some in urine also. Rifampin and its desacetyl derivative undergo enterohepatic circulation. The $t_{1/2}$ of rifampin is variable (2–5 hours).

Interactions Rifampin is a microsomal enzyme inducer—increases several CYP450 isoenzymes, including CYP3A4, CYP2D6, CYP1A2 and CYP2C subfamily. It thus enhances its own metabolism as well as that of many drugs including warfarin, oral contraceptives, corticosteroids, sulfonyleureas, digitoxin, steroids, HIV protease inhibitors, non-nucleoside reverse transcriptase inhibitors (NNRTIs), theophylline, metoprolol, fluconazole, ketoconazole, etc. Contraceptive failures have occurred: switch over to an oral contraceptive containing higher dose (50 μ g) of estrogen or use alternative method of contraception.

Adverse effects The incidence of adverse effects is similar to INH.

Hepatitis, a major adverse effect, generally occurs in patients with preexisting liver disease and is dose-related: development of jaundice requires discontinuation of the drug—then it is reversible. Other serious but rare reactions are:

- ‘Respiratory syndrome’: breathlessness which may be associated with shock and collapse.
- Purpura, haemolysis, shock and renal failure. Minor reactions usually not requiring drug withdrawal and more common with intermittent regimens are:
- ‘Cutaneous syndrome’: flushing, pruritus + rash (especially on face and scalp), redness and watering of eyes.

- 'Flu syndrome': with chills, fever, headache, malaise and bone pain.
- 'Abdominal syndrome': nausea, vomiting, abdominal cramps with or without diarrhoea. Urine and secretions may become orange-red—but this is harmless.

Other uses of rifampin

- (i) Leprosy (*see* Ch. 56)
- (ii) Prophylaxis of *Meningococcal* and *H. influenzae* meningitis and carrier state.
- (iii) Second/third choice drug for MRSA, diphtheroids and *Legionella* infections.
- (iv) Combination of doxycycline and rifampin is the first line therapy of brucellosis.

RCIN 150, 300, 450, 600 mg caps, 100 mg/5 ml susp. RIMACTANE, RIMPIN 150, 300, 450 mg caps, 100 mg/5 ml syr.; RIFAMYCIN 450 mg cap, ZUCOX 300, 450, 600 mg tabs; to be taken 1 hour before or 2 hour after meals.

Pyrazinamide (Z)

Chemically similar to INH, pyrazinamide (Z) was developed parallel to it in 1952. It is weakly tuberculocidal but more active in acidic medium. It is more lethal to intracellularly located bacilli and to those at sites showing an inflammatory response (pH is acidic at both these locations). It is highly effective during the first 2 months of therapy when inflammatory changes are present. By killing the residual intracellular bacilli it has good 'sterilizing' activity. Its use has enabled regimens to be shortened and risk of relapse to be reduced. Mechanism of antimycobacterial action of Z resembles INH; it inhibits mycolic acid synthesis, but by interacting with a different fatty acid synthase encoding gene. Resistance to Z develops rapidly if it is used alone, and is due to mutation in the *pncA* gene which encodes for the enzyme generating the active metabolite of Z.

Pyrazinamide is absorbed orally, widely distributed, has good penetration in CSF, extensively metabolized in liver and excreted in urine; plasma $t_{1/2}$ is 6–10 hours.

Hepatotoxicity is the most important dose-related adverse effect, but it appears to be less

common in the Indian population than in western countries. Daily dose is now limited to 25–30 mg/kg which produces only a low incidence of hepatotoxicity. It is contraindicated in patients with liver disease.

Hyperuricaemia is common and is due to inhibition of uric acid secretion in kidney: gout can occur.

Other adverse effects are arthralgia, flushing, rashes, fever and loss of diabetes control.

PYZINA 0.5, 0.75, 1.0 g tabs, 0.3 g kid tab; PZA-CIBA 0.5, 0.75 g tabs, 250 mg/5 ml syr; RIZAP 0.75, 1.0 g tabs.

Ethambutol (E)

Ethambutol is selectively tuberculostatic and clinically as active as S. Fast multiplying bacilli are more susceptible as are many atypical mycobacteria. Added to the triple drug regimen of RHZ it has been found to hasten the rate of sputum conversion and to prevent development of resistance.

The mechanism of action of E is not fully understood, but it has been found to inhibit arabinosyl transferases involved in arabinogalactan synthesis and to interfere with mycolic acid incorporation in mycobacterial cell wall. Resistance to E develops slowly; in many cases it is due to alteration in the drug target gene. No cross resistance with any other antitubercular drug has been noted.

About 3/4 of an oral dose of E is absorbed. It is distributed widely but penetrates meninges incompletely and is temporarily stored in RBCs. Less than 1/2 of E is metabolized. It is excreted in urine by glomerular filtration and tubular secretion; plasma $t_{1/2}$ is ~4 hrs. Caution is required in its use in patients with renal disease.

Patient acceptability of E is very good and side effects are few. Loss of visual acuity/colour vision, field defects due to optic neuritis is the most important dose and duration of therapy dependent toxicity. Because young children may be unable to report early visual impairment, it should not be used below 6 years of age. With early recognition and stoppage of therapy, visual

toxicity is largely reversible. Ethambutol produces few other symptoms: nausea, rashes, fever, neurological changes are infrequent. Hyperuricemia is due to interference with urate excretion. It is a commonly used antitubercular drug.

MYCOBUTOL, MYAMBUTOL, COMBUTOL 0.2, 0.4, 0.6, 0.8, 1.0 g tabs.

Streptomycin (S)

The pharmacology of streptomycin is described in Ch. 53. It was the first clinically useful antitubercular drug. It is tuberculocidal, but less effective than INH or rifampin; acts only on extracellular bacilli (because of poor penetration into cells). Thus, host defence mechanisms are needed to eradicate the disease. It penetrates tubercular cavities, but does not cross to the CSF, and has poor action in acidic medium.

Resistance developed rapidly when streptomycin was used alone in tuberculosis—most patients had a relapse. In an average population of TB, 1 in 10^8 to 1 in 10^6 bacillus is resistant to S; these bacilli selectively multiply and stage a comeback after initial control. In case of S-resistant infection, it must be stopped at the earliest because of chances of S-dependence—the infection flourishing when the drug is continued. Most atypical mycobacteria are unaffected by S.

Popularity of S in the treatment of tuberculosis had declined due to need for i.m. injections and lower margin of safety, because of ototoxicity and nephrotoxicity, especially in the elderly and in those with impaired renal function.

Thiacetazone (Tzn, Amithiozone)

Thiosemicarbazones were the first antitubercular drugs tested, but were weak. Domagk studied their action. Thiacetazone was found to be the best out of many derivatives. It was tried in the west, found to be hepatotoxic and discarded. In India, interest in Tzn was revived in the 1960s for oral use along with INH as a substitute for PAS. Though, its importance has declined, it continues to be used as a convenient low cost drug to prevent emergence of resistance to INH and more active agents.

Thiacetazone is a tuberculostatic, low efficacy drug; does not add to the therapeutic effect of H, S or E, but delays resistance to these drugs. It is orally active, and primarily excreted unchanged in urine with a $t_{1/2}$ of 12 hr.

The major adverse effects of Tzn are hepatitis, exfoliative dermatitis, Stevens-Johnson syndrome and rarely bone marrow depression. The common side effects are anorexia, abdominal discomfort, loose motions and minor rashes. A mild anaemia persists till Tzn is given. Tzn is a reserve anti-TB drug, sometimes added to INH in alternative regimens. It should not be used in HIV positive cases, because incidence of serious toxicity is higher.

Dose: 150 mg OD in adults, 2.5 mg/kg in children. It is frequently used as combined tablet with isoniazid.

Para-amino salicylic acid (PAS)

Introduced in 1946, it is related to sulfonamides—chemically as well as in mechanism of action. It is not active against other bacteria: selectivity may be due to difference in the affinity of folate synthase of TB and other bacteria for PAS.

PAS is tuberculostatic and one of the least active drugs: does not add to the efficacy of more active drugs that are given with it; only delays development of resistance—probably, by directly inhibiting episomal resistance transfer. Resistance to PAS is slow to develop. It is used as the sodium salt (large doses that are needed may cause Na^+ overload) or calcium salt (better gastric tolerance is claimed).

PAS is absorbed completely by the oral route and distributed all over except in CSF. About 50% PAS is acetylated; competes with acetylation of INH—prolongs its $t_{1/2}$. PAS formulations interfere with absorption of rifampin. It is excreted rapidly by glomerular filtration and tubular secretion; $t_{1/2}$ is short, ~1 hour.

Patient acceptability of PAS is poor because of frequent anorexia, nausea and epigastric pain. Other adverse effects are rashes, fever, malaise, goiter, liver dysfunction and blood dyscrasias.

Dose: 10–12 g (200 mg/kg) per day in divided doses; **SODIUM-PAS 0.5 g tab, 80 g/100 g granules.** It is rarely used now.

Ethionamide (Etm)

It is a tuberculostatic drug of moderate efficacy introduced in 1956. It acts on both extra- and intracellular organisms. Atypical mycobacteria are sensitive. Resistance to Etm develops rapidly and some cross resistance with Tzn is seen. It is absorbed orally, distributes all over, including CSF, completely metabolized and has a short duration of action ($t_{1/2}$ 2–3 hr).

Anorexia, nausea, vomiting and abdominal upset are common, especially in Indian patients. Though the recommended dose of Etm is 1 g/day, more than 0.5 g is generally not tolerated. Other side effects are aches and pains, rashes, hepatitis, peripheral or optic neuritis, mental disturbances and impotence. It is seldom used; only in case of resistance to better tolerated drugs.

Dose: 0.5–0.75 g (10–15 mg/kg) per day; **ETHIDE, ETHICID, MYOBID 250 mg tab.**

Cycloserine (Cys)

It is an antibiotic obtained from *S. orchidaceus*, and is a chemical analogue of D-alanine: inhibits bacterial cell wall synthesis by inactivating the enzymes which recemize L-alanine and link two D-alanine residues. Cys is tuberculostatic and inhibits some other gram-positive bacteria, *E. coli*, *Chlamydia* also. Resistance to Cys develops slowly: no cross resistance.

Cycloserine is absorbed orally, diffuses all over, CSF concentration is equal to that in plasma. About 1/3rd of a dose is metabolized, the rest is excreted unchanged by kidney. The CNS toxicity of Cys is high—sleepiness, headache, tremor and psychosis; convulsions may be prevented by pyridoxine 100 mg/day. It is rarely used; only in resistant cases. The shelf life of Cys in warm climate is short.

Dose: 250 mg BD, increased if tolerated upto 500 mg BD.
CYCLORINE, COXERIN, MYSER 250 mg cap.

Kanamycin, Amikacin and Capreomycin are more toxic antibiotics used as reserve drugs in rare cases not responding to the usual therapy, or infection by atypical mycobacteria. Any one of these is used at a time in combination with the commonly employed drugs to which resistance has not developed. Because all exhibit similar ototoxicity and nephrotoxicity, they are not combined among themselves or with streptomycin. Capreomycin, in addition, can induce electrolyte abnormalities. All act by inhibiting protein synthesis. None is effective orally; none penetrates meninges. All are excreted unchanged by the kidney. All are given in a dose of 0.75–1.0 g i.m. per day.

Kanamycin and amikacin are aminoglycosides and have been described in Ch. 53. Amikacin is a very promising drug for atypical mycobacteria including *M. avium*. Capreomycin is available as
KAPOCIN 0.5, 0.75, 1.0 g inj.

NEWER DRUGS

Ciprofloxacin, Ofloxacin, Moxifloxacin (*see* Ch 50 for description) The fluoroquinolones are a useful new addition to the antitubercular drugs. Ciprofloxacin, ofloxacin, moxifloxacin, gatifloxacin and sparfloxacin are active against *M. tuberculosis* as well as *M. avium* complex (MAC) and *M. fortuitum*. They penetrate cells and kill mycobacteria lodged in macrophages as well. Because of their good tolerability, ciprofloxacin and ofloxacin are being increasingly included in combination regimens against MDR tuberculosis and MAC infection in HIV patients. They are also being used to supplement ethambutol + streptomycin in cases when H, R, Z have been stopped

due to hepatotoxicity. However, neither ciprofloxacin nor ofloxacin have enhanced the sterilizing ability of long-term regimens containing H and R. The generally employed doses are ciprofloxacin 1500 mg/day and ofloxacin 800 mg/day in 2 divided doses. Sparfloxacin is more active against mycobacteria *in vitro*, but has been used clinically to a lesser extent.

Clarithromycin, Azithromycin (*See* Ch. 54)

These newer macrolide antibiotics are most active against nontubercular mycobacteria including MAC, *M. fortuitum*, *M. Kansasii* and *M. marinum*. Clarithromycin has been used to a greater extent because its MIC values are lower, but azithromycin may be equally efficacious due to its higher tissue and intracellular levels. For MAC and other atypical mycobacterial infection the dose of clarithromycin is 500 mg BD and that of azithromycin 500 mg OD in combination with other drugs. In AIDS patients, life-long therapy is required—may cause ototoxicity.

Rifabutin It is related to rifampin in structure and mechanism of action; but less active against *M. tuberculosis* and more active against MAC. Only partial cross resistance occurs between the two. In a dose of 300 mg/day rifabutin is used for prophylaxis of MAC infection in AIDS patients. For the treatment of established MAC infection, it has been added to ethambutol + clarithromycin/azithromycin. Gastrointestinal intolerance, rashes, granulocytopenia, myalgia and uveitis have been noted as adverse effects. Reactions similar to those produced by rifampin can also occur. Like rifampin, it is an enzyme inducer, but weaker. It is substituted for rifampin for *M. tuberculosis* infection in HIV patients who receive a protease inhibitor and/or a NNRTI, whose metabolism is markedly induced by rifampin.

Some antitubercular combinations

RIFATER: Rifampin 120 mg, isoniazid 80 mg, pyrazinamide 250 mg tab.

R-CINEX: Rifampin 600 mg, isoniazid 300 mg tab; **R-CINEX-Z:** Rifampin 225 mg, isoniazid 150 mg, pyrazinamide 750 mg tab. **RIMACTAZID, RIFADIN-INH,** Rifampin 450 mg, isoniazid 300 mg tab.

MYCONEX 600 and 800; Isoniazid 300 mg, ethambutol 600 mg or 800 mg tab, **COMBUNEX** Isoniazid 300 mg, ethambutol 800 mg tab.

ARZIDE, ISORIFAM: Rifampin 450 mg, isoniazid 300 mg cap.

BI-TEBEN, ISOZONE, UNITHIBEN: Isoniazid 75 mg, thiacetazone 37.5 mg tab, **ISOZONE FORTE**—double strength.

INAPAS: sod PAS 834 mg, isoniazid 25 mg tab; sod PAS 3.34 g + isoniazid 100 mg per measure granules.

INABUTOL: Isoniazid 150 mg, ethambutol 400 mg tab; INABUTOL FORTE—double strength.

ISOKIN-300: Isoniazid 300 mg, vit B₆ 10 mg tab.

IPCAZIDE: Isoniazid 100 mg, vit B₆ 5 mg per 5 ml liq.

Antitubercular combipacks (packs of 1 day's dose)

AKT-4: R 450 mg 1 cap + Z 750 mg 2 tab + E 800 mg H 300 mg 1 tab.

AKT-3: R 450 mg 1 cap + E 800 mg H 300 mg 1 tab.

CX-5: R 450 mg 1 cap + Z 750 mg 2 tab + E 800 mg H 300 mg pyridoxine 10 mg 1 tab.

RIFACOM-Z and

RIMACTAZIDE-Z: R 450 mg H 300 mg 1 tab. + Z 750 mg 2 tab.

RIFACOM-EZ: R 450 mg H 300 mg 1 tab. + Z 750 mg 2 tab + E 800 mg 1 tab.

Fixed dose combination of antitubercular drugs with vitamins (except INH + Vit B₆) are banned in India.

TREATMENT OF TUBERCULOSIS

The therapy of tuberculosis has undergone remarkable change.

The conventional 12–18 month treatment has been replaced by more effective and less toxic 6 month treatment which also yields higher completion rates. This has been possible due to better understanding of the biology of tubercular infection and the differential properties of the antitubercular drugs.

Biology of tubercular infection *M. tuberculosis* is an aerobic organism. In unfavourable conditions it grows only intermittently or remains dormant for prolonged periods. Several subpopulations of bacilli, each with a distinctive metabolic state, could exist in an infected patient, e.g.:

(a) **Rapidly growing with high bacillary load** as in the wall of a cavitary lesion where oxygen tension is high and pH is neutral. These bacilli are highly susceptible to H and to a lesser extent to R, E and S.

(b) **Slow growing** located intracellularly (in macrophages) and at inflamed sites where pH is low. They are particularly vulnerable to Z, while H, R and E are less active, and S is inactive.

(c) **Spurters** within caseous material where oxygen tension is low but pH is neutral: the bacilli grow intermittently with occasional spurts of active metabolism. R is most active on this subpopulation.

(d) **Dormant** some bacilli remain totally inactive for prolonged periods. No antitubercular drug is significantly active against them.

However, there is continuous shifting of bacilli between these subpopulations.

The goals of antitubercular chemotherapy are:

(a) **Kill dividing bacilli** Drugs with early bactericidal action rapidly reduce bacillary load in the patient and achieve quick sputum negativity so that the patient is non-contagious to the community: transmission of TB is interrupted. This also affords quick symptom relief.

(b) **Kill persisting bacilli** To effect cure and prevent relapse. This depends on sterilizing capacity of the drug.

(c) **Prevent emergence of resistance** So that the bacilli remain susceptible to the drugs.

The relative activity of the first line drugs in achieving these goals differs, e.g. H and R are the most potent bactericidal drugs active against all populations of TB bacilli, while Z acts best on intracellular bacilli and those at inflamed sites—has very good sterilizing activity. On the other hand S is active only against rapidly multiplying extracellular bacilli. E is bacteriostatic—mainly serves to prevent resistance and may hasten sputum conversion.

Drug combinations are selected to maximise the above actions together with considerations of cost, convenience and feasibility. The general principles of antitubercular chemotherapy are:

- Use of any single drug in tuberculosis results in the emergence of resistant organisms and relapse in almost 3/4th patients. A combination of two or more drugs must be used. The rationale is: the incidence of resistant bacilli to most drugs ranges from 10⁻⁸ to 10⁻⁶. Because an average patient of pulmonary tuberculosis harbours 10⁸ to 10¹⁰ bacilli, the number of organisms that will not respond to a single drug is high and cannot be dealt by the host defence. During protracted treatment, these bacilli multiply and become dominant in 3–4 months. Because insensitivity to one drug is independent of that to another, i.e. incidence of H resistance among bacilli resistant to R will

Table 55.1: Recommended doses of antitubercular drugs®

DRUG	Daily dose		3 × per week dose	
	mg/kg	For > 50 kg	mg/kg	For > 50 kg
Isoniazid (H)	5 (4–6)	300 mg	10 (8–12)	600 mg
Rifampin (R)	10 (8–12)	600 mg	10 (8–12)	600 mg
Pyrazinamide (Z)	25 (20–30)	1500 mg	35 (30–40)	2000 mg
Ethambutol (E)	15 (15–20)	1000 mg	30 (25–35)	1600 mg
Streptomycin (S)	15 (12–18)	1000 mg [£]	15 (12–18)	1000 mg

@ The WHO guidelines also describe a twice weekly dosage schedule, but do not recommend it.

£ Dose to be reduced to 750 mg above 50 yr age and to 500 mg above 65 yr age; also in patients with renal impairment.

be 10^{-6} and *vice versa*; only few bacilli will be resistant to both; these can be handled by host defence. By the same rationality, massive infection ($>10^{10}$ organisms) has to be treated by at least 3 drugs; and a single drug is sufficient for prophylaxis, because the number of bacilli is small.

- Isoniazid and R are the most efficacious drugs; their combination is definitely synergistic—duration of therapy is shortened from > 12 months to 9 months. Addition of Z for the initial 2 months further reduces duration of treatment to 6 months.
- A single daily dose of all first line antitubercular drugs is preferred. The 'directly observed treatment short course' (DOTS) was recommended by the WHO in 1995.
- Response is fast in the first few weeks as the fast dividing bacilli are eliminated rapidly. Symptomatic relief is evident within 2–4 weeks. The rate of bacteriological, radiological and clinical improvement declines subsequently as the slow multiplying organisms respond gradually. Bacteriological cure takes much longer. The adequacy of any regimen is decided by observing sputum conversion rates and 2–5 year relapse rates after completion of treatment.

Conventional regimens These consist of H + Tzn or E with or without S (for initial 2 months) and require 12–18 months therapy. Failure rates are high, compliance is poor—therefore not recommended now.

SHORT COURSE CHEMOTHERAPY (SCC)

These are regimens of 6–9 month duration which have been found highly efficacious. After several years of experience a WHO expert group has framed clear-cut treatment guidelines* (1997) for different categories of TB patients. The dose of first line anti-TB drugs has been standardized on body weight basis and is applicable to both adults and children (Table 55.1).

All regimens have an *initial intensive phase*, lasting for 2–3 months aimed to rapidly kill the TB bacilli, bring about sputum conversion and afford symptomatic relief. This is followed by a *continuation phase* lasting for 4–6 months during which the remaining bacilli are eliminated so that relapse does not occur. Treatment of TB is categorized by:

- Site of disease (pulmonary or extrapulmonary) and its severity: the bacillary load and acute threat to life or permanent handicap are taken into consideration.
- Sputum smear-positivity/negativity: positive cases are infectious and have higher mortality.
- History of previous treatment: risk of drug resistance is more in irregularly treated patients.

Rationale Patients of smear-positive pulmonary TB harbour and disseminate large number of

* Treatment of tuberculosis: Guidelines for National Programmes, Second Edition (1997), WHO, Geneva

bacilli. Initial treatment with 4 drugs reduces risk of selecting resistant bacilli as well as covers patients with primary resistance. When few bacilli are left only 2 drugs in the continuation phase are enough to effect cure. Smear-negative pulmonary TB and extrapulmonary TB patients harbour fewer bacilli in their lesions—risk of selecting resistant bacilli is less; regimens containing only 3 drugs in the initial phase and 2 in the continuation phase are of proven efficacy. Accordingly, previously treated/failure/default/relapse cases are treated with a longer intensive phase—5 drugs for 2 months and 4 drugs for 1 month followed by 3 drugs in the continuation phase of 5 months duration (instead of usual 4 months).

The category-wise treatment regimens are summarized in Tables 55.2 and 55.3.

Category I This category includes:

- New (untreated) smear-positive pulmonary TB.
- New smear-negative pulmonary TB with extensive parenchymal involvement.
- New cases of severe forms of extrapulmonary TB, viz. meningitis, miliary, pericarditis, peritonitis, bilateral or extensive pleural effusion, spinal, intestinal, genitourinary TB.

Initial phase Four drugs HRZ + E or S are given daily or thrice weekly for 2 months. The revised national tuberculosis control programme (RNTCP) has been launched in India in 1997, which is implementing DOTS*. Out of the WHO recommended regimens, the RNTCP has decided to follow thrice weekly regimen, since it is equally effective, saves drugs and effort, and is more practical. The RNTCP regimen is presented in Table 55.3. The RNTCP recommends that if the patient is still sputum-positive at 2 months, the intensive phase should be extended by another month; then continuation phase is started regardless of sputum status at 3 months.

* Technical guidelines for tuberculosis control (2000). Central TB Division, Directorate General of Health Services, Ministry of Health and F.W., New Delhi.

Table 55.2: Category-wise alternative treatment regimens for tuberculosis (WHO 1997)

TB category	Initial phase (daily/ 3×per week)	Continuation phase	Total duration
I	2 HRZE (S)	4 HR/4 H ₃ R ₃ or 6 HE	6 8
II	2 HRZES + 1 HRZE	5 HRE or 5 H ₃ R ₃ E ₃	8 8
III	2 HRZ	4 HR/4 H ₃ R ₃ or 6 HE	6 8
IV	Chronic case:	See text	

Explanation of standard code

- Each anti-TB drug has a standard abbreviation (H, R, Z, E, S).
- The numeral before a phase is the duration of that phase in months.
- The numeral in subscript (e.g. H₃ R₃) is number of doses of that drug per week. If there is no subscript numeral, then the drug is given daily.

Table 55.3: Treatment regimens followed in India under the Revised National Tuberculosis Control Programme (RNTCP 1997)

TB category	Initial phase	Continuation phase	Total duration
I	2H ₃ R ₃ Z ₃ E ₃	4H ₃ R ₃	6
II	2H ₃ R ₃ Z ₃ E ₃ S ₃ + 1H ₃ R ₃ Z ₃ E ₃	5H ₃ R ₃ E ₃	8
III	2H ₃ R ₃ Z ₃	4H ₃ R ₃	6

Continuation phase Two drugs HR for 4 months or HE for 6 months are given. When both H and R are used, thrice weekly regimen is permissible. Under the RNTCP, thrice weekly treatment with H and R is given for 4 months. This phase is extended to 6–7 months (total duration 8–9 months) for TB meningitis, miliary and spinal disease. In areas where DOTS has not been implemented, use of Tzn in place of E in the continuation phase is permitted except in HIV positive cases.

Category II These are smear-positive failure, relapse and interrupted treatment cases:

Treatment failure: Patient who remains or again becomes smear-positive 5 months or later after

commencing treatment. Also one who was smear-negative at start of therapy and becomes smear-positive after the 2nd month.

Relapse: A patient declared cured from any form of TB in the past after receiving one full course of chemotherapy and now has become sputum positive.

Treatment after interruption (default): A patient who interrupts treatment for 2 months or more and returns with sputum-positive or clinically active TB.

These patients may have resistant bacilli and are at greater risk of developing MDR-TB.

Initial phase All 5 first line drugs are given for 2 months followed by 4 drugs (HRZE) for another month. Continuation phase is started if sputum is negative, but 4 drug treatment is continued for another month if sputum is positive at 3 months.

Continuation phase Three drugs (HRE) are given for 5 months either daily or thrice weekly (only thrice weekly under the RNTCP).

Category III These are new cases of smear-negative pulmonary TB with limited parenchymal involvement or less severe forms of extrapulmonary TB, *viz*, lymphnode TB, unilateral pleural effusion, bone (excluding spine), peripheral joint or skin TB.

Initial phase Three drugs (HRE) given for 2 months are enough because the bacillary load is smaller.

Continuation phase This is similar to category I, i.e. 4 month daily/thrice weekly HR or 6 months daily HE (Tzn) therapy. Under the RNTCP only thrice weekly HR regimen is followed.

Category IV These are chronic cases who have remained or have become smear-positive after completing fully supervised retreatment (Category II) regimen. These are most likely MDR cases.

Multidrug-resistant (MDR) TB is defined as resistance to both H and R and may be any number of other anti-TB drugs. MDR-TB has a more rapid course (some die in 4–16 weeks). Treatment of

these cases is difficult, because one or more second line drugs are to be given for 12–24 months. The second line drugs are less efficacious, less convenient, more toxic and more expensive.

The choice of drugs depends on the drugs used in the earlier regimen, dosage and regularity with which they were taken, presence of associated disease like AIDS/diabetes/leukaemia/silicosis, and whether sensitivity of the pathogen to various drugs is known (by *in vitro* testing) or unknown. If sensitivity of the TB bacilli is known, the drug/drugs to which they are resistant is/are excluded and other first line drugs are prescribed along with 1–3 second line drugs. A total of 5–6 drugs are given. One of the FQs is generally included. In case streptomycin is not being given, one out of kanamycin/amikacin/capreomycin should be added, because they are tuberculocidal.

- For H resistance—RZE given for 12 months is recommended.
- For H + R resistance—ZE + S/Kmc/Am/Cpr + Cipro/ofl ± Etm could be used.

The actual regimen is devised according to the features of the individual patient.

Extensively drug resistant (XDR) TB Recently, the WHO and CDC (USA) have identified TB cases that are ‘extensively drug resistant’. This term has been applied to bacilli that are resistant to at least 4 most effective cidal drugs, i.e. cases resistant to H, R, a FQ, one of Kmc/Am/Cpr with or without any number of other drugs. The global survey for the period 2002-2004 has found 20% TB isolates to be MDR, out of which 2% were XDR. The XDR-TB is virtually untreatable; mortality is high, particularly among HIV positive patients.

Tuberculosis in pregnant women The WHO and British Thoracic Society consider H, R and Z to be safe to the foetus and recommend the standard 6 month (2HRZ + 4HR) regimen for pregnant women with TB. E can be added during late but not early pregnancy. S is contraindicated. However, Z is not recommended in the USA (due to lack of adequate teratogenicity data). In India, it is advised to avoid Z, and to treat

pregnant TB patients with 2 HRE + 7HR (total 9 months). Treatment of TB should not be withheld or delayed because of pregnancy.

Treatment of breastfeeding women All anti-TB drugs are compatible with breastfeeding; full course should be given to the mother, but the baby should be watched (*See Appendix-3*). The infant should receive BCG vaccination and isoniazid prophylaxis.

Management of patients with adverse drug reactions to antitubercular drugs Minor side effects are to be managed symptomatically without altering medication; e.g. Z induced arthralgia can be treated by analgesic-NSAIDs; peripheral neuritis due to H can be counteracted by pyridoxine. With more severe reactions, the offending drug should be stopped; e.g. E should be promptly discontinued at the first indication of optic neuritis. If possible H and R should be continued, or should be reintroduced after the reaction has subsided by challenging with small doses. However, R should never be reintroduced in case of severe reaction such as haemolysis, thrombocytopenia or renal failure.

Hepatotoxicity is the most common problem with antitubercular drugs. Any one or more of H, R and Z could be causative and the reaction occurs more frequently when combination of these drugs is used. In case hepatitis develops, all these drugs should be stopped and S + E may be started or continued. A fluoroquinolone may be added. When the reaction clears, the above drugs are started one by one to identify the culprit, which should never be used again, while the others found safe should be continued. It is best to avoid Z in patients who once developed hepatitis.

Chemoprophylaxis The purpose is to prevent progression of latent tubercular infection to active disease. This is indicated only in :

- (a) Contacts of open cases who show recent Mantoux conversion.
- (b) Children with positive Mantoux and a TB patient in the family.
- (c) Neonate of tubercular mother.

(d) Patients of leukaemia, diabetes, silicosis, or those who are HIV positive but are not anergic, or are on corticosteroid therapy who show a positive Mantoux.

(e) Patients with old inactive disease who are assessed to have received inadequate therapy.

The standard drug for chemoprophylaxis of TB is H 300 mg (10 mg/kg in children) daily for 6–12 months. This is as effective in HIV patients as in those with normal immune function. However, because of spread of INH resistance, a combination of H (5 mg/kg) and R (10 mg/kg) daily given for 6 months is preferred in some areas. The CDC (USA) recommends 4 months R prophylaxis in case H cannot be used. An alternative regimen is daily R + Z for 2 months, but this carries risk of severe liver damage, and needs close monitoring. Therefore, it is reserved for contacts of resistant TB cases. Another regimen for subjects exposed to MDR-TB is E + Z with or without a FQ.

Role of corticosteroids Corticosteroids should not be ordinarily used in tubercular patients. However, they may be used under adequate chemotherapeutic cover:

- (a) In seriously ill patients (miliary or severe pulmonary TB) to buy time for drugs to act.
- (b) When hypersensitivity reactions occur to antitubercular drugs.
- (c) In meningeal or renal TB or pleural effusion—to reduce exudation and prevent its organisation, strictures, etc.
- (d) In AIDS patients with severe manifestations of tuberculosis.

Corticosteroids are contraindicated in intestinal tuberculosis—silent perforation can occur.

Corticosteroids, if given, should be gradually withdrawn when the general condition of the patient improves.

Tuberculosis in AIDS patients The association of HIV and TB infection is a serious problem. HIV positive cases have more severe and more infectious TB. HIV infection is the strongest risk factor for making latent TB overt. Moreover,

adverse reactions to anti-TB drugs are more common in HIV patients.

On the other hand, institution of 'highly active antiretroviral therapy' (HAART) and improvement in CD4 cell count markedly reduces the incidence of TB among HIV-AIDS patients. When CD4 count is <150 cells/ μL , extrapulmonary and dual TB is more commonly encountered.

In case of *M. tuberculosis* infection, drugs used are the same as in non-HIV cases, but the duration is longer and at least 4 drugs are used. Initial therapy with 2 month HRZE is started immediately on the diagnosis of TB, and is followed by a continuation phase of HR for 7 months (total 9 months). Alternatively, 3 drugs (HRE) are given for 4 months in the continuation phase. Pyridoxine 25–50 mg/day is routinely given along with H to counteract its neurological side effects, which are more likely in AIDS patients.

Consideration also has to be given to possible drug interactions between anti-TB and antiretroviral (ARV) drugs. Rifampin, a potent inducer of CYP isoenzymes, markedly enhances the metabolism of protease inhibitors (PIs, *viz.* indinavir, nelfinavir, ritonavir) and of NNRTIs, *viz.* nevirapine, efavirenz, to a lesser extent, making them ineffective. In patients receiving these drugs, rifabutin (a less potent enzyme inducer) given for 9–12 months may be substituted for rifampin. The metabolism of nucleoside reverse transcriptase inhibitors (NRTIs, zidovudine, etc.) is not induced by rifampin—no dose adjustment is needed. An alternative regimen of 3 NRTIs (zidovudine +

lamivudine + abacavir) has been advocated for patients who are to be treated by rifampin.

MDR-TB in HIV-AIDS patients should be treated for a total of 18–24 months or for 12 months after sputum smear negativity.

Mycobacterium avium complex (MAC) infection is common in HIV-AIDS patients, particularly when the CD4 count drops to <100 cells/ μL . Clarithromycin/azithromycin are the most active drugs against MAC. A favoured regimen consists of an intensive phase of at least 4 drugs—clarithromycin/azithromycin + ethambutol + rifabutin + one FQ/clofazimine/ethionamide given for 2–6 months (duration is response based), followed by 2 drug maintenance phase with clarithromycin/azithromycin + ethambutol/one FQ/rifabutin for at least 12 months or even lifelong. However, any additional benefit of the initial 4 drug intensive phase is unproven. Clarithromycin inhibits the metabolism of rifabutin.

Prophylaxis of MAC in AIDS patients by clarithromycin/azithromycin (or rifabutin if these drugs cannot be given) is advocated when the CD4 count falls below 100 cells/ μL . After institution of HAART, this is continued till near complete suppression of viral replication is achieved and CD4 count rises above 100 cells/ μL . Otherwise, prophylaxis is continued lifelong.

CHAPTER 56

Antileprotic Drugs

Leprosy, caused by *Mycobacterium leprae*, has been considered incurable since ages and bears a social stigma. Due to availability of effective antileprotic drugs now, it is entirely curable, but deformities/defects already incurred may not reverse.

Chaulmoogra oil with weak antileprotic property had been used in Indian medicine for centuries. Shortly after the demonstration of antibacterial property of sulfonamides, congeners were tested and dapsone, the parent sulfone, was found to be active antileprotic. Demonstration of its efficacy in experimental tuberculosis and leprosy led to clinical trials in the 1940s, and since then it is the sheet-anchor of treatment of leprosy. Few other sulfones were added, but none could excel dapsone. Some antitubercular drugs and clofazimine were subsequently found to be useful adjuncts. Recently good antileprotic activity has been detected in some fluoroquinolones, macrolides and minocycline.

CLASSIFICATION

1. *Sulfone* Dapsone (DDS)
2. *Phenazine derivative* Clofazimine
3. *Antitubercular drugs* Rifampin,
Ethionamide
4. *Other antibiotics* Ofloxacin,
Minocycline,
Clarithromycin

Dapsone (DDS)

It is diamino diphenyl sulfone (DDS), the simplest, oldest, cheapest, most active and most commonly used member of its class. All other sulfones are converted in the body to DDS; many have been used, but none is superior.

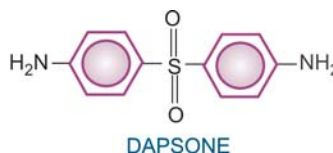

Activity and mechanism Dapsone is chemically related to sulfonamides and has the same mechanism of action, i.e. inhibition of PABA incorporation into folic acid; its antibacterial action is antagonized by PABA. It is leprostatic at low concentrations, and at relatively higher concentrations arrests the growth of many other bacteria sensitive to sulfonamides. Specificity for *M. leprae* may be due to difference in the affinity of its folate synthase. Doses of dapsone needed for the treatment of acute infections are too toxic, so not used.

Dapsone-resistance among *M. leprae*, first noted in 1964, has spread, and has necessitated

the use of multidrug therapy (MDT). It may be *primary*—in untreated patients, i.e. they have acquired infection from a patient harbouring resistant bacilli, or *secondary*—which develops during therapy in an individual patient with a single drug. The incidence of primary dapsone resistance reported from different parts of the world, from time-to-time, has varied from 2.5% to 40%; whereas secondary dapsone resistance occurred in about 20% patients treated with monotherapy. The mechanism of secondary resistance appears to be the same as for *M. tuberculosis*. However, the peak serum concentration of dapsone after 100 mg/day dose exceeds MIC for *M. leprae* by nearly 500 times; it continues to be active against low to moderately resistant bacilli.

Pharmacokinetics Dapsone is completely absorbed after oral administration and is widely distributed in the body, though penetration in CSF is poor. It is 70% plasma protein bound, but more importantly concentrated in skin (especially lepromatous skin), muscle, liver and kidney.

Dapsone is acetylated as well as glucuronide and sulfate conjugated in liver. Metabolites are excreted in bile and reabsorbed from intestine, so that ultimate excretion occurs mostly in urine. The plasma $t_{1/2}$ of dapsone is variable, though often > 24 hrs. The drug is cumulative due to retention in tissues and enterohepatic circulation. Elimination takes 1–2 weeks or longer.

DAPSONE 25, 50, 100 mg tab.

Adverse effects Dapsone is generally well tolerated at doses 100 mg/day or less.

Mild haemolytic anaemia is common. It is a dose-related toxicity—reflects oxidising property of the drug. Patients with G-6-PD deficiency are more susceptible; doses > 50 mg/day produce haemolysis in them.

Gastric intolerance—nausea and anorexia are frequent in the beginning, decrease later.

Other side effects are methaemoglobinaemia, headache, paresthesias, mental symptoms and drug fever.

Cutaneous reactions include allergic rashes, fixed drug eruption, hypermelanosis, phototoxicity and rarely exfoliative dermatitis.

Hepatitis and agranulocytosis are other rare complications.

Lepra reaction and sulfone syndrome (*see* below).

Contraindications Dapsone should not be used in patients with severe anaemia with Hb < 7g%, G-6-PD deficiency and in those showing hypersensitivity reactions.

Other use In combination with pyrimethamine, dapsone can be used for chloroquine-resistant malaria.

Clofazimine (Clo)

It is a dye with leprostatic and antiinflammatory properties; acts probably by interfering with template function of DNA in *M. leprae*. When used alone, resistance to clofazimine develops in 1–3 years. Dapsone-resistant *M. leprae* respond to clofazimine, but apparently after a lag period of about 2 months.

Clofazimine is orally active (40–70% absorbed). It accumulates in many tissues, especially in fat, in crystalline form. However, entry in CSF is poor. The $t_{1/2}$ is 70 days so that intermittent therapy is possible.

CLOFOZINE, HANSEPRAN 50, 100 mg cap.

Clofazimine is used as a component of multidrug therapy of leprosy. Because of its antiinflammatory property, it is valuable in lepra reaction.

Occasionally, it is used as a component of MDT for MAC.

Adverse effects In the doses employed for multidrug therapy (MDT), clofazimine is well tolerated.

Skin The major disadvantage is reddish-black discolouration of skin, especially on exposed parts. Discolouration of hair and body secretions may also occur. Dryness of skin and itching is often troublesome. Acneiform eruptions and phototoxicity have been noted. Conjunctival pigmentation may create cosmetic problem.

GI symptoms Enteritis with intermittent loose stools, nausea, abdominal pain, anorexia and weight loss can occur, particularly when higher doses are used to control lepra reaction. The early syndrome is a reflection of irritant effect of the drug—subsides with dose adjustment and by taking the drug with meals. A late syndrome occurring after few months of therapy—is due to deposition of clofazimine crystals in the intestinal submucosa.

Clofazimine is to be avoided during early pregnancy and in patients with liver or kidney damage.

Rifampin (R)

It is an important antitubercular drug; also bactericidal to *M. leprae*; rapidly renders leprosy patients noncontagious. Up to 99.99% *M. leprae* are killed in 3–7 days. However, it is not satisfactory if used alone—some bacilli persist even after prolonged treatment—resistance develops. It has been included in the multidrug therapy of leprosy: shortens duration of treatment. The 600 mg monthly dose used in leprosy is relatively nontoxic and does not induce metabolism of other drugs. It should not be given to patients with hepatic or renal dysfunction.

The rifampin congener rifabutin is also cidal against *M. leprae*, but not superior to rifampin.

Ethionamide This antitubercular drug has significant antileprotic activity, but causes hepatotoxicity in ~ 10% patients. It has been used as an alternative to clofazimine, but other substitutes are preferred. It should be used (250 mg/day) only when absolutely necessary.

Other antibiotics

Ciprofloxacin is not active against *M. leprae*, but ofloxacin, pefloxacin, gatifloxacin and sparfloxacin are highly active.

Ofloxacin Many trials have evaluated ofloxacin as a component of MDT and found it to hasten the bacteriological and clinical response. Over 99.9% bacilli were found to be killed by 22 daily doses of ofloxacin monotherapy. However, it is

not included in the standard treatment protocols, but can be used in alternative regimens in case rifampin cannot be used, or to shorten the duration of treatment. *Dose*: 400 mg/day.

Minocycline Because of high lipophilicity, this tetracycline is active against *M. leprae*. A dose of 100 mg/day produces peak blood levels that exceed MIC against *M. leprae* by 10–20 times. Its antibacterial activity is much less than that of rifampin, but greater than that of clarithromycin. In one trial minocycline 100 mg daily monotherapy rendered all 8 patients of lepromatous leprosy negative for *M. leprae* after 8 weeks. It is being tried in alternative MDT regimens.

Clarithromycin It is the only macrolide antibiotic with significant activity against *M. leprae*. However, it is less bactericidal than rifampin. Monotherapy with clarithromycin 500 mg daily caused 99.9% bacterial killing in 8 weeks. It is being included in alternative MDT regimens.

TREATMENT OF LEPROSY

Leprosy is a chronic granulomatous infection caused by *Mycobacterium leprae*; primarily affecting skin, mucous membranes and nerves. It is more prevalent among the lowest socio-economic strata. Many patients exploit it for begging and do not come forward for treatment. In India, the National Leprosy Control Programme was launched in 1955, and was changed to National Leprosy Eradication Programme (NLEP) in 1982. With the use of multidrug therapy (MDT), India has achieved elimination of leprosy as a public health problem (prevalence rate < 1 case per 10,000 population) in Dec. 2005, though some states (Bihar, West Bengal, Orissa, Chhatisgarh, Jharkhand, UP) still have >1 case per 10,000.*

Two polar types—lepromatous (LL) and tuberculoid (TT) with 4 intermediate forms—borderline (BB), borderline lepromatous (BL),

* India achieves National elimination of leprosy. *Ind. J. Leprosy* 2006; 78(1): 101.

borderline tuberculoid (BT) and indeterminate (I) of the disease are recognized. The important features of the two polar types are:

Tuberculoid leprosy	Lepromatous leprosy
Anaesthetic patch	Diffuse skin and mucous membrane infiltration, nodules
Cell mediated immunity (CMI) is normal	CMI is absent
Lepromin test—positive	Lepromin test—negative
Bacilli rarely found in biopsies	Skin and mucous membrane lesions teeming with bacilli
Prolonged remissions with periodic exacerbations	Progresses to anaesthesia of distal parts, atrophy, ulceration, absorption of digits, etc.

For operational purposes, leprosy has been divided into:

Paucibacillary leprosy (PBL) (Non-infectious): This includes TT, BT, I and polyneuritic.

Multibacillary leprosy (MBL) (Infectious): This includes LL, BL and BB.

Subsequently the definition of MBL has been widened to include any active patient with > 5 lesions irrespective of results of skin smear tests.

Conventionally, all forms of leprosy had been treated with dapsone alone (monotherapy: MT) 100–200 mg daily, 5 days a week; duration of treatment depending on the type: TT—4 to 5 years, LL—8 to 12 years or lifelong. With this, symptomatic relief occurs in few months, but bacteriological cure is delayed or may not occur. Emergence of dapsone resistance since 1964 threatened the efficacy of monotherapy; upto 20% patients relapsed. Even primary dapsone resistance was increasingly encountered. Monotherapy is no longer used.

Multidrug therapy (MDT) of leprosy

To deal with dapsone resistant strains of *M. leprae* and the problem of microbial persisters (dormant forms), multidrug therapy with rifampin, dapsone and clofazimine was introduced by the WHO in

1981. This was implemented under the NLEP. The MDT is the regimen of choice for all cases of leprosy. Its advantages are:

- Effective in cases with primary dapsone resistance.
- Prevents emergence of dapsone resistance.
- Affords quick symptom relief and renders MBL cases noncontagious.
- Reduces total duration of therapy.

Initially under standard MDT, the PBL cases were treated with dapsone + rifampin for 6 months, while the MBL cases were treated with dapsone + rifampin + clofazimine for a minimum of 2 years or till disease inactivity/skin smear negativity was achieved. The MBL cases were kept under surveillance without treatment for the next 5 years.

A WHO expert group (1994) reviewed the data collected over the past 12 years as well as results of clinical trials, and made the following observations:

- MDT had been highly successful, both in MBL and PBL. The estimated cases of leprosy fell from 10–12 million to 2.7 million.
- Relapse rate after MDT had been 0.74% in MBL and 1.09% in PBL over a period of 9 years.
- The efficacy, safety and acceptability of MDT had been excellent.
- Some reports, mostly from India, had found that for uniformly satisfactory response, treatment of PBL had to be extended beyond the mandatory 6 months (mostly to 12 months). However, no difference in the relapse rate was found among 12000 Indian patients treated with MDT either for 6 months or for 1 year. As such, the WHO expert group recommended continuation of 6 month MDT for PBL.
- No resistance to rifampin developed with MDT: nearly all *M. leprae* isolated from relapse cases remained fully sensitive to rifampin. No resistance to clofazimine had been reported. New cases of drug resistance were not reported after application of MDT. Retreatment of relapse cases with the same MDT had been successful, and was recommended.
- Drug toxicity had not been a major problem in MDT.
- Prevalence of lepra reaction had not increased by MDT.
- No specific association of leprosy with HIV infection had been found. Leprosy in HIV-positive cases is to be treated in the same manner as in others.

On the basis of the above, the WHO (1994) recommended a 'fixed duration therapy' (FDT) of 2 years for MBL and 6 month for PBL, whether disease inactivity or skin smear negativity was attained or not.

MBL Encouraged by the very low relapse rates with 2 yrs FDT and keeping in view operational constraints, studies were undertaken under the aegis of WHO to compare short-duration (12 month) FDT with standard 24 month FDT. In the field situation the two were found to yield similar relapse rates over 3–5 yr follow up. Accordingly, a WHO expert committee on leprosy (1995) recommended shortening of MDT to 12 months. This has been adopted by many countries and Govt. of India has implemented it since 1999.*

Multidrug therapy (MDT) of leprosy

	Multibacillary	Paucibacillary
Rifampin	600 mg once a month supervised	600 mg once a month supervised
Dapsone	100 mg daily self administered	100 mg daily self administered
Clofazimine	300 mg once a month supervised 50 mg daily self administered	—
Duration	12 months	6 months

Doses to be reduced suitably for children.

Blister packs of tablets for 28 day treatment are made available free of cost to all MBL cases, and 12 such blister packs have to be consumed by each MBL patient. Separate blister packs are given to PBL cases and 6 packs are to be taken by each patient.

A few studies, (mostly institutional) have shown that despite 2 yr MDT, some patients continue to harbour viable *M. leprae* (persisters). Relapse rates are higher in the later years of follow up and in the subgroup of patients with large bacillary load, i.e. bacillary index (BI) $\geq 4+$. Thus, the length of MDT could depend on the aim of therapy, resources, and feasibility of follow up.

The primary purpose of mass programmes (WHO Action Programme for the Elimination of leprosy, or NLEP-India) is to render patients non-contagious so as to cut down transmission. For this, 1 yr FDT may be considered adequate. Even if some patients are not totally cured and relapse, they can be treated by reinstating MDT (dormant

bacilli remain sensitive to the same drugs). This is more cost-effective than treating all patients with a longer MDT to prevent a few relapses.

On the other hand, in private or institutional care, the aim is cure of every individual patient. For this extended treatment is required till disease inactivity or skin smear negativity is achieved. Upto 4 years may be needed for this, particularly in highly bacillated patients (BI $\geq 4+$).

PBL For PBL, 6 month 2 drug therapy has now been used for > 20 yrs with very encouraging results. Field studies from various parts of the world suggest that this is adequate, provided the patient is kept on follow up for the subsequent 1–2 years. However, institutional studies have found larger proportion of patients to have active disease after 6 month FDT. Some reports indicate that proportion of patients staying active can be reduced by 12 month MDT. Independent leprologists prefer to extend therapy of PBL for 12 month or longer till disease inactivity is achieved.

It may be concluded that, where feasible, treatment till cure of individual patient should be ensured both in MBL and in PBL.

Highlights of multidrug therapy (MDT) of leprosy

- In 1985, leprosy was endemic in 122 countries (prevalence rate >1 case/10,000 population). By implementing MDT this number was reduced to 9 countries by the beginning of 2004, and the trend is continuing.
- As per WHO, over 14 million cases of leprosy have completed MDT with very few relapses.
- World-over the case load of leprosy has fallen by >90%.
- At the beginning of 2004 only 0.46 million leprosy patients were registered globally, out of which 0.266 million were in India.
- Prevalence of leprosy in India was 57.4 cases/10,000 population before implementing MDT, which fell to 1.3 per 10,000 in March 2005, and to <1 per 10,000 in Dec. 2005.

Alternative regimens Many alternative regimens incorporating newer antileprotic drugs have been investigated. However, these are used only in case of rifampin-resistance or when it is impossible/inadvisable to employ the standard MDT regimen. Some of these are:

* Short Course Treatment of Leprosy: present status; *ICMR Bulletin* 2002; 32(2): 13–19.

- Clofazimine 50 mg + any two of ofloxacin 400 mg/ minocycline 100 mg/clarithromycin 500 mg daily for 6 month, followed by clofazimine 50 mg + any one of ofloxacin 400 mg/minocycline 100 mg daily for additional 18 months.
- Four drug regimen of rifampin 600 mg + sparfloxacin 200 mg + clarithromycin 500 mg + minocycline 100 mg daily for 12 weeks has yielded equivalent/better clinical improvement in MBL cases than standard 12 month MDT.
- In case of refusal to accept clofazimine: ofloxacin 400 mg or minocycline 100 mg daily can be substituted for it in the standard MDT. Use of ethionamide as a substitute is not recommended due to hepatotoxicity of the latter.
- A multicentric trial[@] has shown that PBL cases having few bacteria in the body and only one skin lesion can be treated with a single dose of rifampin 600 mg + ofloxacin 400 mg + minocycline 100 mg (ROM regimen). This regimen has been recommended by the WHO for patients with solitary lesion PBL.

Many other shorter regimens are under evaluation.

Reactions in leprosy

Lepra reaction These occur in LL, usually with institution of chemotherapy and/or intercurrent infection. It is a Jarish Herxheimer (Arthus) type of reaction due to release of antigens from the killed bacilli. It may be mild, severe or life-threatening (erythema nodosum leprosum).

Sufone syndrome It is the reaction which develops 4–6 weeks after dapsone treatment: consists of fever, malaise, lymph node enlargement, desquamation of skin, jaundice and anaemia. It is generally seen in malnourished patients.

Lepra reaction is of abrupt onset; existing lesions enlarge, become red, swollen and painful; several new lesions may appear. Malaise, fever and other constitutional symptoms generally accompany and may be marked.

Temporary discontinuation of dapsone is recommended only in severe cases. Clofazimine (200 mg daily) is highly effective in controlling the reaction (except the most severe one), probably because of its antiinflammatory property.

Other drugs used are—analgesics, antipyretics, antibiotics, etc. according to need. Chloroquine and thalidomide also suppress lepra reaction. Corticosteroids (prednisolone 40–60 mg/day till reaction is controlled, then tapered over 8–12 weeks), should be used only in severe cases.

Reversal reaction This is seen in TT—is a manifestation of delayed hypersensitivity to *M. leprae* antigens. Cutaneous ulceration, multiple nerve involvement with pain and tenderness occur suddenly even after completion of therapy. It is treated with clofazimine or corticosteroids.

[@] Efficacy of single dose MDT for single lesion paucibacillary leprosy. *Ind. J. Leprosy* 1997; 69: 127.



These are drugs used for superficial and deep (systemic) fungal infections.

A disquietening trend after 1950s is the rising prevalence of more sinister type of fungal infections which are, to a large extent, iatrogenic. These are associated with the use of broad-spectrum antibiotics, corticosteroids, anticancer / immunosuppressant drugs, dentures, indwelling catheters and implants, and emergence of AIDS. As a result of breakdown of host defence mechanisms, saprophytic fungi easily invade living tissue.

Many topical antifungals have been available since the antiseptic era. Two important antibiotics: amphotericin B—to deal with systemic mycosis, and griseofulvin—to supplement attack on dermatophytes were introduced around 1960. Antifungal property of flucytosine was noted in 1970, but it could serve only as a companion drug to amphotericin. The development of imidazoles in the mid 1970s and triazoles in 1980s has been an advancement. Some new compounds like *terbinafine* have been added lately.

CLASSIFICATION

1. *Antibiotics*

- A. *Polyenes*: Amphotericin B (AMB), Nystatin, Hamycin, Natamycin (Pimaricin)
- B. *Heterocyclic benzofuran*: Griseofulvin

2. *Antimetabolite* Flucytosine (5-FC)

3. *Azoles*

- A. *Imidazoles* (topical): Clotrimazole, Econazole, Miconazole, Oxiconazole (systemic): Ketoconazole
- B. *Triazoles* (systemic): Fluconazole, Itraconazole, Voriconazole

4. *Allylamine* Terbinafine

5. *Other topical agents*

Tolnaftate, Undecylenic acid, Benzoic acid, Quiniodochlor, Ciclopirox olamine, Butenafine, Sod. thiosulfate.

POLYENE ANTIBIOTICS

The name *polyene* is derived from their highly double-bonded structure. Amphotericin B is described as the prototype.

Amphotericin B (AMB)

It is obtained from *Streptomyces nodosus*.

Chemistry and mechanism of action The polyenes possess a macrocyclic ring, one side of which has several conjugated double bonds and is highly lipophilic, while the other side is hydrophilic with many OH groups. A polar

aminosugar and a carboxylic acid group are present at one end in some. They are all insoluble in water and unstable in aqueous medium.

The polyenes have high affinity for ergosterol present in fungal cell membrane: combine with it, get inserted into the membrane and several polyene molecules together orient themselves in such a way as to form a 'micropore'. The hydrophilic side forms the interior of the pore through which ions, amino acids and other water-soluble substances move out. The micropore is stabilized by membrane sterols which fill up the spaces between the AMB molecules on the lipophilic side—constituting the outer surface of the pore. Thus, cell permeability is markedly increased.

Cholesterol, present in host cell membranes, closely resembles ergosterol; the polyenes bind to it as well, though with lesser affinity. Thus, the selectivity of action of polyenes is low, and AMB is one of the most toxic systemically used antibiotics, though it is the least toxic polyene. Bacteria do not have sterols and are unaffected by polyenes. It has been found that AMB enhances immunity in animals, and this may aid immunocompromised individuals in handling fungal infection.

Antifungal spectrum AMB is active against a wide range of yeasts and fungi—*Candida albicans*, *Histoplasma capsulatum*, *Cryptococcus neoformans*, *Blastomyces dermatitidis*, *Coccidioides immitis*, *Torulopsis*, *Rhodotorula*, *Aspergillus*, *Sporothrix*, etc. Dermatophytes are inhibited *in vitro*, but concentrations of AMB attained in infected skin are low and ineffective. It is fungicidal at high and static at low concentrations.

Resistance to AMB during therapy has been rarely noted among *Candida* in a selected group of leucopenic cancer patients, but it is not a problem in the clinical use of the drug.

AMB is also active on various species of *Leishmania*.

Pharmacokinetics AMB is not absorbed orally; it can be given orally for intestinal candidiasis without systemic toxicity. Administered i.v. as a

suspension made with the help of deoxycholate (DOC), it gets widely distributed in the body, but penetration in CSF is poor. It binds to sterols in tissues and to lipoproteins in plasma and stays in the body for long periods. The terminal elimination $t_{1/2}$ is 15 days. About 60% of AMB is metabolized in the liver. Excretion occurs slowly both in urine and bile, but urinary concentration of active drug is low.

Administration and dose Amphotericin B can be administered orally (50–100 mg QID) for intestinal moniliasis; also topically for vaginitis, otomycosis, etc.: **FUNGIZONE OTIC 3% ear drops**.

For systemic mycosis, it is available as dry powder along with DOC for extemporaneous dispersion before use: **FUNGIZONE INTRAVENOUS, MYCOL 50 mg vial**. It is first suspended in 10 ml water and then diluted to 500 ml with glucose solution (saline tends to make the suspension coarse). Initially 1 mg test dose is injected i.v. over 20 minutes. If no serious reaction follows, 0.3 mg/kg is infused over 4–8 hours. Daily dose may be gradually increased to 0.7 mg/kg depending on tolerance of the patient. The total dose of AMB for majority of cases is 3–4 g given over 2–3 months.

Intrathecal injection of 0.5 mg twice weekly has been given in fungal meningitis.

New amphotericin B formulations In an attempt to improve tolerability of i.v. infusion of AMB, reduce its toxicity and achieve targeted delivery, 3 new lipid formulations of AMB have been produced.

(a) **Amphotericin B lipid complex (ABLC)**: Contains 35% AMB incorporated in ribbon like particles of dimyristoyl phospholipids.

(b) **Amphotericin B colloidal dispersion (ABCD)**: Disc shaped particles containing 50% each of AMB and cholesteryl sulfate are prepared as aqueous dispersion.

(c) **Liposomal amphotericin B (small unilamellar vesicles; SUV)**: Consists of 10% AMB incorporated in uniform sized (60–80 nm) unilamellar liposomes made up of lecithin and other biodegradable phospholipids.

The special features of these preparations are:

- They, except ABCD, produce milder acute reaction (especially liposomal formulation) on i.v. infusion.
- They can be used in patients not tolerating infusion of conventional AMB formulation.
- They have lower nephrotoxicity.
- They cause minimal anaemia.
- The liposomal preparation delivers AMB particularly to reticuloendothelial cells in liver and spleen—especially valuable for kala azar and in immunocompromised patients.

However, some preparations, especially ABLC and ABCD, produce lower AMB levels and their clinical efficacy

relative to conventional formulation appears to be lower. Though none of the above formulations is more effective in deep mycosis than conventional AMB, the *liposomal-AMB* produces equivalent blood levels, has similar clinical efficacy with less acute reaction and renal toxicity. It thus appears more satisfactory, can be infused at higher rates (3–5 mg/kg/day), but is many times costlier than conventional AMB. Its specific indications are—as empirical therapy in febrile neutropenic patients not responding to antibacterial antibiotics, critically ill deep mycosis cases and in kala azar.

FUNGISOME (liposomal AMB) 10 mg, 25 mg, 50 mg per vial inj.

Adverse effects The toxicity of AMB is high.

(a) *Acute reaction* This occurs with each infusion and consists of chills, fever, aches and pain all over, nausea, vomiting and dyspnoea lasting for 2–5 hour, probably due to release of cytokines (IL, TNF α). When these are severe—the dose is increased gradually. Usually the intensity of reaction decreases with continued medication. Injection of hydrocortisone 0.6 mg/kg with the infusion may reduce the intensity of reaction. Thrombophlebitis of the injected vein can occur.

(b) *Long-term toxicity* Nephrotoxicity is the most important. It occurs fairly uniformly and is dose-related: manifestations are—azotemia, reduced g.f.r., acidosis, hypokalaemia and inability to

concentrate urine. It reverses slowly and often incompletely after stoppage of therapy.

Anaemia: Most patients develop slowly progressing anaemia which is due to bone marrow depression. It is largely reversible.

CNS toxicity: occurs only on intrathecal injection—headache, vomiting, nerve palsies, etc.

Uses Amphotericin B can be applied topically for oral, vaginal and cutaneous candidiasis and otomycosis.

It is the most effective drug for various types of systemic mycoses and is the gold standard of antifungal therapy. However, because of higher toxicity of AMB, the azole antifungals are now preferred in conditions where their efficacy approaches that of AMB (see Table 57.1).

Leishmaniasis: AMB is the most effective drug for resistant cases of kala azar and mucocutaneous leishmaniasis (see Ch. 60).

Interactions Flucytosine has supra-additive action with AMB in the case of fungi sensitive to both (AMB increases the penetration of 5-FC into the fungus).

Rifampin and minocycline, though not antifungal in their own right, potentiate AMB action.

Table 57.1: Choice of drugs for systemic mycoses

Disease	Drugs	
	1st Choice	2nd Choice
1. Candidiasis		
oral/vaginal/cutaneous	FLU/NYS/CLO	ITR
disseminated	AMB/VORI	FLU
2. Cryptococcosis	AMB \pm 5-FC	FLU
3. Histoplasmosis	ITR/AMB	FLU
4. Coccidioidomycosis	AMB/FLU	ITR/KTZ
5. Blastomycosis	ITR/AMB	KTZ/FLU
6. Sporotrichosis (disseminated)	AMB	ITR
7. Paracoccidioidomycosis	ITR	AMB
8. Aspergillosis	AMB/VORI	ITR
9. Mucormycosis	AMB	—
10. Chromomycosis	ITR	KTZ/5-FC

AMB—Amphotericin B; 5-FC—Flucytosine; KTZ—Ketoconazole; FLU—Fluconazole; ITR—Itraconazole; NYS—Nystatin; CLO—Clotrimazole; VORI—Voriconazole

Aminoglycosides, vancomycin, cyclosporine and other nephrotoxic drugs enhance the renal impairment caused by AMB.

Nystatin

Obtained from *S. noursei*, it is similar to AMB in antifungal action and other properties. However, because of higher systemic toxicity, it is used only locally in superficial candidiasis and is generally preferred over AMB for these purposes.

MYCOSTATIN 5 lac U tab, 1 lac U vaginal tab, 1 lac U/g oint, NYSTIN EYE 1 lac U/g ophthalmic oint.

Given orally, it is not absorbed; can be used for monilial diarrhoea (due to superinfection or otherwise), 5 lac U TDS (1 mg = 2000 U). Nausea and bad taste in mouth are the only side effects.

Nystatin is effective (but less than azoles) in monilial vaginitis—1 lac U tab inserted twice daily. For oral thrush, the vaginal tab may be sucked or it may be crushed and suspended in glycerine for application in mouth. Corticosteroid aerosols (e.g. beclomethasone) can cause oral candidiasis: nystatin is effective in preventing as well as treating it.

Similarly, it is used for corneal, conjunctival and cutaneous candidiasis in the form of an ointment. No irritation or other side effect is ordinarily seen.

Candidal resistance to nystatin is not a clinical problem. It is ineffective in dermatophytosis.

Hamycin It was isolated from *S. pimprina* and developed by Hindustan Antibiotics at Pimpri. It is similar to nystatin, but more water soluble. A fraction of the orally administered dose is absorbed, but cannot be relied upon for the treatment of systemic mycosis: use is restricted to topical application for oral thrush, cutaneous candidiasis, monilial and trichomonas vaginitis and otomycosis by *Aspergillus*. HAMYCIN, IMPRIMA 5 lac U/g oint, 2 lac U/ml susp for topical use, 4 lac U vaginal ovules.

Natamycin (Pimaricin) It is similar to nystatin; has a broader spectrum of action, and is used only topically. A 5% suspension or 1% ointment is non-irritating to the eye, and has been used particularly in *Fusarium solani* keratitis. Both monilial and trichomonas vaginitis are amenable to natamycin.

NATAMYCIN 2% cream, 25 mg vaginal tab, PIMAFUSIN VAGINAL 100 mg vaginal tab.

HETEROCYCLIC BENZOFURAN

Griseofulvin

It was one of the early antibiotics extracted from *Penicillium griseofulvum*. However, because of lack of antibacterial activity, little attention was paid to it: clinical utility in dermatophytosis was demonstrated only around 1960.

Griseofulvin is active against most dermatophytes, including *Epidermophyton*, *Trichophyton*, *Microsporum*, etc., but not against *Candida* and other fungi causing deep mycosis. Bacteria are also insensitive. Dermatophytes actively concentrate it: this feature probably accounts for its selective toxicity. Resistance can be induced *in vitro* and this is associated with loss of concentrating ability. However, emergence of resistance during clinical use is rare.

Griseofulvin interferes with mitosis—multi-nucleated and stunted fungal hyphae result from its action. It also causes abnormal metaphase configurations. However, unlike the typical mitotic inhibitors (colchicine, vinca alkaloids), it does not cause metaphase arrest; rather the daughter nuclei fail to move apart or move only a short distance. It does not inhibit polymerization of tubulin (microtubular protein which pulls the chromosomes apart), but binds to polymerized microtubules and somehow disorients them.

Pharmacokinetics The absorption of griseofulvin from g.i.t. is somewhat irregular because of its very low water solubility. Absorption is improved by taking it with fats and by microfining the drug particles; now ultramicrofine particle preparations from which absorption is still better are available.

Griseofulvin gets deposited in keratin forming cells of skin, hair and nails; it is especially concentrated and retained in tinea infected cells. Because it is fungistatic and not cidal, the newly formed keratin is not invaded by the fungus, but the fungus persists in already infected keratin, till it is shed off. Thus, the duration of treatment is dependent upon the site of infection, thickness of infected keratin and its turnover rate.

Griseofulvin is largely metabolized, primarily by methylation, and excreted in urine. Plasma $t_{1/2}$ is 24 hrs, but it persists for weeks in skin and keratin.

Adverse effects Toxicity of griseofulvin is low and usually not serious. Headache is the commonest complaint, followed by g.i.t. disturbances. CNS symptoms and peripheral neuritis are occasional.

Rashes, photoallergy may warrant discontinuation.

Transient leukopenia and albuminuria (without renal damage) are infrequent.

Use Griseofulvin is used orally only for dermatophytosis. It is ineffective topically. Systemic azoles and terbinafine are equally or more efficacious; preferred now.

Dose: 125–250 mg QID with meals; duration depends on the site of infection (turnover rate of keratin).

Body skin	3 weeks
Palm, soles	4 to 6 weeks
Finger nails	4 to 6 months
Toe nails	8 to 12 months

Majority of localized tinea infections are treated with topical agents. Griseofulvin should be reserved for cases with nail, hair or large body surface involvement. It is effective in athlete's foot, but not in pityriasis versicolor.

GRISOVIN-FP, WALAVIN, GRISORAL 250 mg tab.

Interactions Griseofulvin induces warfarin metabolism and reduces efficacy of oral contraceptives.

Phenobarbitone reduces the oral absorption and induces the metabolism of griseofulvin—failure of therapy may occur.

Griseofulvin can cause intolerance to alcohol.

FLUCYTOSINE (5-FC)

It is a pyrimidine antimetabolite which is inactive as such. It is taken up by fungal cells and converted into 5-fluorouracil and then to 5-fluorodeoxyuridylic acid which is an inhibitor of thymidylate synthesis. Thymidylic acid is a component of DNA. The fungal selectivity of 5-FC depends on the fact that mammalian cells (except some marrow cells) have low capacity to convert 5-FC into 5-fluorouracil.

It is a narrow spectrum fungistatic, active against *Cryptococcus neoformans*, *Torula*, *Chromoblastomyces*; and a few strains of *Candida*. Other fungi and bacteria are insensitive.

Adverse effects Toxicity of 5-FC is lower than that of AMB; consists of dose-dependent bone marrow depression and gastrointestinal disturbances, particularly enteritis and diarrhoea.

Liver dysfunction is mild and reversible.

Use Flucytosine is not employed as the sole therapy except occasionally in chromoblastomycosis. Rapid development of resistance limits its utility in deep mycosis. In cryptococcosis (both meningeal and nonmeningeal) its synergistic action with AMB is utilized to reduce the total dose of the more toxic latter drug.

IMIDAZOLES AND TRIAZOLES

These are presently the most extensively used antifungal drugs.

Four imidazoles are entirely topical, while ketoconazole is used both orally and topically. Two triazoles fluconazole and itraconazole have largely replaced ketoconazole for systemic mycosis because of greater efficacy, longer $t_{1/2}$, fewer side effects and drug interactions.

The imidazoles and triazoles have broad-spectrum antifungal activity covering dermatophytes, *Candida*, other fungi involved in deep mycosis (except mucor), *Nocardia*, some gram-positive and anaerobic bacteria, e.g. *Staph. aureus*, *Strep. faecalis*, *Bac. fragilis* and *Leishmania*.

The mechanism of action of imidazoles and triazoles is the same. They inhibit the fungal cytochrome P450 enzyme 'lanosterol 14-demethylase' and thus impair ergosterol synthesis leading to a cascade of membrane abnormalities in the fungus. The lower host toxicity of triazoles compared to imidazoles has correlated with their lower affinity for mammalian CYP450 enzymes and lesser propensity to inhibit mammalian sterol synthesis. However, because they are active against certain bacteria as well (which do not have ergosterol), other mechanisms of action also appear to be involved.

Development of fungal resistance to azoles has been noted among *Candida* infecting advanced

AIDS patients, but has not so far posed significant clinical problem.

Clotrimazole It is effective in the topical treatment of tinea infections like ringworm: 60–100% cure rates are reported with 2–4 weeks application on a twice daily schedule. Athletes' foot, otomycosis and oral/cutaneous/vaginal candidiasis have responded in >80% cases. It is particularly favoured for vaginitis because of a long lasting residual effect after once daily application. A 7 day course is generally used. For oropharyngeal candidiasis 10 mg troche of clotrimazole is allowed to dissolve in the mouth 3–4 times a day, or the lotion/gel is applied/swirled in the mouth for as long as possible. It is also effective in skin infections caused by *Corynebacteria*.

Clotrimazole is well tolerated by most patients. Local irritation with stinging and burning sensation occurs in some. No systemic toxicity is seen after topical use.

SURFAZ, CLOTRIN, CLODERM 1% lotion, cream, powder; 100 mg vaginal tab. **CANDID** 1% cream, gel, lotion, powder.

Econazole It is similar to clotrimazole; penetrates superficial layers of the skin and is highly effective in dermatophytosis, otomycosis, oral thrush, but is somewhat inferior to clotrimazole in vaginitis. No adverse effects, except local irritation in few is reported.

ECONAZOLE 1% oint, 150 mg vaginal tab; **ECODERM** 1% cream.

Miconazole It is a highly efficacious (>90% cure rate) drug for tinea, pityriasis versicolor, otomycosis, cutaneous and vulvovaginal candidiasis. Because of its good penetrating power, it has been found effective, though partially, even in onychomycosis; single application on skin acts for a few days.

Irritation after cutaneous application is infrequent. No systemic adverse effects are seen. However, a higher incidence of vaginal irritation is reported in comparison to clotrimazole; even pelvic cramps have been experienced.

DAKTARIN 2% gel, 2% powder and solution; **GYNODAKTARIN** 2% vaginal gel; **ZOLE** 2% oint, lotion, dusting powder and spray, 1% ear drops, 100 mg vaginal ovules.

Oxiconazole Another recently marketed topical imidazole antifungal effective in tinea and other dermatophytic infection, as well as vaginal candidiasis. Local irritation can occur in some patients.

OXIZON, ZODERM: oxiconazole 1% with benzoic acid 0.25% cream/lotion; apply topically once or twice daily.

Ketoconazole (KTZ)

It is the first orally effective broad-spectrum antifungal drug, useful in both dermatophytosis and deep mycosis. The oral absorption of KTZ is facilitated by gastric acidity because it is more soluble at lower pH. Hepatic metabolism is extensive; metabolites are excreted in urine and faeces. Elimination of KTZ is dose dependent: $t_{1/2}$ varies from 1½ to 6 hours. Penetration in CSF is poor: not effective in fungal meningitis. However, therapeutic concentrations are attained in the skin and vaginal fluid.

In spite of relatively short $t_{1/2}$, a single daily dose is satisfactory in less severe cases. The usual dose is 200 mg OD or BD; higher doses are sometimes required.

FUNGICIDE, NIZRAL, FUNAZOLE, KETOVATE 200 mg tab.

FUNGINOC 2% oint, 2% shampoo (for dandruff), **KETOVATE** 2% cream. **NIZRAL** 2% cream, 2% lotion; **DANRUF** 2% shampoo, **HYPHORAL** 2% lotion.

Adverse effects Ketoconazole is much less toxic than AMB, but more side effects occur than with itraconazole or fluconazole, that have largely replaced it for systemic use.

The most common side effects are nausea and vomiting; can be reduced by giving the drug with meals. Others are—loss of appetite, headache, paresthesia, rashes and hair loss.

Ketoconazole decreases androgen production from testes, and it displaces testosterone from protein binding sites. Gynaecomastia, loss of hair and libido, and oligozoospermia may be the

manifestations. Menstrual irregularities occur in some women due to suppression of estradiol synthesis.

A dose-dependent decrease in serum hydrocortisone due to synthesis inhibition has also been noted, but without any clinical manifestations in normal individuals.

Mild and asymptomatic elevation of serum transaminases occurs in ~5% patients, but serious hepatotoxicity is infrequent.

It is contraindicated in pregnant and nursing women.

Interactions H₂ blockers, proton pump inhibitors and antacids decrease the oral absorption of KTZ by reducing gastric acidity.

Rifampin, phenobarbitone, carbamazepine and phenytoin induce KTZ metabolism and reduce its efficacy.

Ketoconazole inhibits cytochrome P450, especially CYP3A4, and raises the blood levels of several drugs including:

Phenytoin	Digoxin
Diazepam	Cyclosporine
Haloperidol	Nifedipine and other DHPs
Warfarin	HIV protease inhibitors
Sulfonylureas	Statin hypolipidaemics

The dangerous interaction with terfenadine, astemizole and cisapride resulting in polymorphic ventricular tachycardia due to excessive rise in plasma levels of these drugs has resulted in withdrawal of these drugs from the market in many countries.

Use Orally administered KTZ is effective in *dermatophytosis* because it is concentrated in the stratum corneum; is an alternative to griseofulvin, but use is restricted due to potential adverse effects.

Though effective in *monilial vaginitis*, oral therapy (for 5–7 days) with KTZ is reserved for recurrent cases or those not responding to topical agents.

Systemic mycosis: Administered orally, KTZ is effective in several types of systemic mycosis, but itraconazole and fluconazole, being more active

with fewer side effects, have largely replaced it for these indications except for considerations of cost.

KTZ is occasionally used in dermal leishmaniasis and *kala azar*.

High-dose KTZ has been used in Cushing's syndrome to decrease corticosteroid production.

Fluconazole It is a water-soluble triazole having a wider range of activity than KTZ; indications include cryptococcal meningitis, systemic and mucosal candidiasis in both normal and immunocompromised patients, coccidioidal meningitis and histoplasmosis.

Fluconazole is 94% absorbed; oral bioavailability is not affected by food or gastric pH. It is primarily excreted unchanged in urine with a $t_{1/2}$ of 25–30 hr. Fungicidal concentrations are achieved in nails, vagina and saliva; penetration into brain and CSF is good. Dose reduction is needed in renal impairment.

Adverse effects Fluconazole produces few side effects: mostly nausea, vomiting, abdominal pain, rash and headache.

Selectivity for fungal cytochrome P450 is higher; unlike KTZ, it does not inhibit steroid synthesis in man: antiandrogenic and other endocrine side effects have not occurred.

Elevation of hepatic transaminase has been noted in AIDS patients.

It is not recommended in pregnant and lactating mothers.

Interactions Though it affects hepatic drug metabolism to a lesser extent than KTZ, increased plasma levels of phenytoin, astemizole, cisapride, cyclosporine, warfarin, zidovudine and sulfonylureas have been observed. A few cases of ventricular tachycardia have been reported when fluconazole was given with cisapride. The same caution as with KTZ or itraconazole needs to be applied in coadministering other drugs. H₂ blockers and proton pump inhibitors do not effect its absorption.

Use Fluconazole can be administered orally as well as i.v. (in severe infections).

A single 150 mg oral dose can cure vaginal candidiasis with few relapses.

Oral fluconazole (150 mg/day for 2 weeks) is highly effective in oropharyngeal candidiasis, but is reserved for cases not responding to topical antifungals.

Most tinea infections and cutaneous candidiasis can be treated with 150 mg weekly fluconazole for 4 weeks, while tinea unguium requires weekly treatment for up to 12 months.

For disseminated candidiasis, cryptococcal/coccidioidal meningitis and other systemic fungal infections the dose is 200–400 mg/day for 4–12 weeks or longer. It is the preferred drug for fungal meningitis, because of good CSF penetration. Long-term fluconazole maintenance therapy is needed in AIDS patients with fungal meningitis.

An eye drop is useful in fungal keratitis.

Fluconazole is ineffective in aspergillosis and mucormycosis, and inferior to itraconazole for histoplasmosis, blastomycosis and sporotrichosis.

SYSCAN, ZOCON, FORCAN, FLUZON 50, 100, 150, 200 mg caps, 200 mg/100 ml i.v. infusion.
SYSCAN 0.3% eye drops.

Itraconazole This newer orally active triazole antifungal has a broader spectrum of activity than KTZ or fluconazole; includes some moulds like *Aspergillus*. It is fungistatic, but effective in immunocompromised patients. Steroid hormone

synthesis inhibition is absent in itraconazole, and serious hepatotoxicity is rare.

Oral absorption of itraconazole is variable. It is enhanced by food and gastric acid. Itraconazole is highly protein bound, has a large volume of distribution (10L/Kg), accumulates in vaginal mucosa, skin and nails, but penetration into CSF is poor. It is largely metabolized in liver by CYP3A4; an active metabolite is produced which is excreted in faeces; $t_{1/2}$ varies from 30–64 hours.

Itraconazole is well tolerated in doses below 200 mg/day. Gastric intolerance is significant at > 400 mg/day. Dizziness, pruritus, headache and hypokalaemia are the other common side effects. Unsteadiness and impotence are infrequent. Plasma transaminase may rise transiently. However, antiandrogenic and other hormonal adverse effects are not seen. Impaired left ventricular function has been worsened in some patients.

Drug interactions Oral absorption of itraconazole is reduced by antacids, H_2 blockers and proton pump inhibitors.

Rifampin, phenobarbitone, phenytoin and carbamazepine induce itraconazole metabolism and reduce its efficacy.

On the other hand, clarithromycin and HIV protease inhibitors reduce the metabolism of itraconazole and raise its blood levels.

Table 57.2: Properties of drugs used for systemic mycoses

Characteristic	AMB	5-FC	KTZ	FLU	ITR
Antifungal spectrum	Broad	Narrow	Broad	Broad	Broad
Water soluble	No	Yes	Yes	Yes	Yes
Absorbed orally	No	Yes	Yes	Yes	Yes
Administered i.v.	Yes	Yes	No	Yes	Yes
Resistance (<i>in vivo</i>)	No	Yes	No	No	No
Nephrotoxicity	Yes	No	No	No	No
Anaemia	Yes	Mild	No	No	No
Leucopenia	No	Yes	No	No	No
Gastrointestinal upset	Yes	Yes	Mild	Mild	Moderate
Overall toxicity	High	Medium	Low	Lowest	Lowest

AMB—AmphotericinB; 5-FC—Flucytosine; KTZ—Ketoconazole; FLU—Fluconazole; ITR—Itraconazole

Itraconazole inhibits CYP3A4; drug interaction profile is similar to KTZ; ventricular arrhythmias have occurred with terfenadine, astemizole, cisapride and class III antiarrhythmics. Phenytoin, digoxin, sulfonyleureas, statins, dihydropyridines, protease inhibitors, warfarin and cyclosporine levels are also increased.

Uses Itraconazole is the preferred azole antifungal for most systemic mycosis (see Table 57.1) that are not associated with meningitis. It is superior to fluconazole for histoplasmosis, blastomycosis, sporotrichosis and is the drug of choice for paracoccidioidomycosis and chromomycosis. It also affords some relief in aspergillosis. A dose of 200 mg OD/BD with meals is used for 3 months or more.

Vaginal candidiasis: 200 mg OD for 3 days: as effective as intravaginal clotrimazole.

Dermatophytosis: 100–200 mg OD for 7–15 days: more effective than griseofulvin, but less effective than fluconazole.

Onychomycosis: 200 mg/day for 3 months. An intermittent pulse regimen of 200 mg BD for 1 week each month for 3 months is equally effective. Relapses have occurred after itraconazole therapy, though it remains in the nail for few months after completion of the course.

SPORANOX, CANDITRAL, CANDISTAT, ITASPOR, FLUCOVER 100 mg cap.

Important features of drugs used for systemic mycosis are compared in Table 57.2.

Voriconazole It is a second generation broad-spectrum triazole introduced lately for difficult to treat fungal infections like invasive aspergillosis, disseminated infections caused by fluconazole resistant *Candida*, *Fusarium* infections, and febrile neutropenia not responding to antibacterial therapy. Serious cases are first treated i.v. followed by oral voriconazole. It is metabolized by several CYP isoenzymes (CYP2C19, CYP3A4, etc) and inhibits them as well. The drug interaction profile is similar to itraconazole. Rashes, visual disturbances, QTc prolongation and an acute reaction on i.v. injection are the significant adverse effects.

TERBINAFINE

This orally and topically active drug against dermatophytes and *Candida* belongs to a new allylamine class of antifungals. In contrast to azoles which are primarily fungistatic, terbinafine is fungicidal: shorter courses of therapy are required and relapse rates are low. It acts as a non-competitive inhibitor of 'squalene epoxidase', an early step enzyme in ergosterol biosynthesis by fungi. Accumulation of squalene within fungal cells appears to be responsible for the fungicidal action. The mammalian enzyme is inhibited only by 1000-fold higher concentration of terbinafine.

Approximately 75% of oral terbinafine is absorbed, but only 5% or less from unbroken skin. First pass metabolism further reduces oral bioavailability. It is lipophilic, widely distributed in the body, strongly plasma protein bound and concentrated in sebum, stratum corneum and nail plates. It is inactivated by metabolism and excreted in urine (80%) and faeces (20%); elimination $t_{1/2}$ of 11–16 hr is prolonged to 10 days after repeated dosing.

Side effects of oral terbinafine are gastric upset, rashes, taste disturbance. Some cases of hepatic dysfunction, haematological disorder and severe cutaneous reaction are reported. Enzyme inducers lower, and enzyme inhibitors raise its steady-state plasma levels. Terbinafine does not inhibit CYP450.

Topical terbinafine can cause erythema, itching, dryness, irritation, urticaria and rashes.

Use Terbinafine applied topically as 1% cream or orally 250 mg OD is indicated in tinea pedis/corporis/cruris/capitis and pityriasis versicolor; 2–6 weeks treatment is required according to the site. Onychomycosis is treated by 3–12 months oral therapy. Efficacy in toe nail infection is 60–80%, which is higher than griseofulvin and itraconazole.

It is less effective against cutaneous and mucosal candidiasis: 2–4 weeks oral therapy may be used as an alternative to fluconazole.

LAMISIL, SEBIFIN, DASKIL 250 mg tab, 1% topical cream. **EXIFINE** 125, 250 mg tabs, 1% cream; **TERBIDERM** 1% cream.

OTHER TOPICAL ANTIFUNGALS

All these drugs are used for dermatophytosis.

1. Tolnaftate It is an effective drug for tinea cruris and tinea corporis—most cases respond in 1–3 weeks. Because of poor penetrability, it is less effective in tinea pedis and other hyperkeratinized lesions. For the same reason, it is ineffective in tinea capitis—involving scalp and tinea unguium—involving nails.

Symptomatic relief occurs early, but if applications are discontinued before the fungus bearing tissue is shed—relapses are common. Resistance does not occur. Salicylic acid can aid tolnaftate by keratolytic action.

Tolnaftate causes little irritation, but is inferior in efficacy to imidazoles. It is not effective in candidiasis or other types of superficial mycosis. **TINADERM, TINAVATE 1% lotion, TOLNADERM 1% cream.**

2. Ciclopirox olamine It is a newer drug effective in tinea infections, pityriasis versicolor and dermal candidiasis: high cure rates are reported. It penetrates superficial layers and reaches hair roots but systemic absorption is negligible. Local tolerance without irritation is good. Sensitization occurs occasionally. Formulated as nail lacquer, it has been used in onychomycosis. Also used for vaginal candidiasis.

BATRAFEN 1% cream, 1% topical solution, 1% vaginal cream, OLAMIN 1% cream.

3. Undecylenic acid It is fungistatic used topically, generally in combination with its zinc salt. It is inferior to the drugs described above; cure rates are low even after prolonged treatment. However, it is still used for tinea pedis, nappy rash and tinea cruris. Irritation and sensitization are infrequent.

TINEAFAX: Zinc undecenoate 8%, zinc naphthenate 8%, mesulphen 8%, methyl salicylate 2.5%, terpineol 2.5% oint.

4. Benzoic acid It has antifungal and antibacterial property in slightly acidic medium. It is fungistatic—weaker than tolnaftate; eradication of the fungus needs prolonged application till infected keratin is shed.

On hyperkeratotic lesions, it is used in combination with salicylic acid (as Whitfield's ointment: benzoic acid 5%, salicylic acid 3%). The latter, by its keratolytic action, helps to remove the infected tissue and promotes the penetration of benzoic acid into the lesion. Irritation and burning sensation is experienced by many patients.

RINGCUTTER ointment.

5. Butenafine It is a benzylamine congener of terbinafine with the same mechanism of action. However, it is used only topically in dermatophytosis. Efficacy in tinea cruris/corporis/pedis is similar to that of topical terbinafine.

BUTOP, FINTOP 1% cream; apply locally once or twice daily.

6. Quiniodochlor By the oral route, it is used as a luminal amoebicide (Ch. 60). It also has weak antifungal and antibacterial activity. By external application, it has been used for dermatophytosis, mycosis barbae, seborrhoeic dermatitis, infected eczema, furunculosis and pityriasis versicolor.

It is also used in vaginal creams for monilial and trichomonas vaginitis.

VIOFORM 3% cream; DERMOQUINOL 4%, 8% cream.

7. Sodium thiosulfate It is a weak fungistatic, active against *Malassezia furfur*. A 20% solution applied twice daily for 3–4 weeks is effective in pityriasis versicolor. However, normal pigmentation of the skin takes longer to return. It is not useful in other superficial mycosis.

in **KARPIN LOTION 20%.**



Viruses are the ultimate expression of parasitism: they not only take nutrition from the host cell but also direct its metabolic machinery to synthesize new virus particles. Viral chemotherapy, therefore, is difficult, as it would require interference with cellular metabolism in the host. However, virus directed enzymes have been identified in the infected cell and some viruses have few enzymes of their own which may have higher affinities for some antimetabolites or inhibitors than the regular cellular enzymes. Drugs could also target virus specific steps like cell penetration, uncoating, reverse transcription, virus assembly or maturation. Another stumbling block is that in majority of acute infections viral replication is already at its peak when symptoms appear. To be effective, therefore, therapy has to be started in the incubation period, i.e. has to be prophylactic.

CLASSIFICATION

1. *Anti-Herpes virus*

Idoxuridine, Acyclovir, Valacyclovir, Famciclovir, Ganciclovir*, Foscarnet*

2. *Anti-Retrovirus*

(a) *Nucleoside reverse transcriptase inhibitors (NRTIs)*: Zidovudine (AZT), Didanosine, Zalcitabine*, Stavudine, Lamivudine, Abacavir

(b) *Nonnucleoside reverse transcriptase inhibitors (NNRTIs)*: Nevirapine, Efavirenz, Delavirdine*
 (c) *Protease inhibitors*: Ritonavir, Indinavir, Nelfinavir, Saquinavir, Amprenavir*, Lopinavir

3. *Anti-Influenza virus*

Amantadine, Rimantadine*

4. *Nonselective antiviral drugs*

Ribavirin, Lamivudine, Adefovir dipivoxil, Interferon α

* Not yet marketed in India.

ANTI-HERPES VIRUS DRUGS

Idoxuridine It is 5-iodo-2-deoxyuridine (IUDR); acts as a thymidine analogue. It was the first pyrimidine antimetabolite to be used as antiviral drug. It competes with thymidine, gets incorporated in DNA so that faulty DNA is formed which breaks down easily. It is effective only against DNA viruses and clinical utility is limited to topical treatment of *Herpes simplex* Keratitis, labial and genital herpes. However, because of low virus selectivity, higher local toxicity and rapid development of viral resistance, it has been superseded by acyclovir.

Trifluridine and *vidarabine* are other pyrimidine antimetabolites effective against *H. simplex*.

Acyclovir

This deoxyguanosine analogue antiviral drug requires a virus specific enzyme for conversion to

the active metabolite that inhibits DNA synthesis and viral replication.

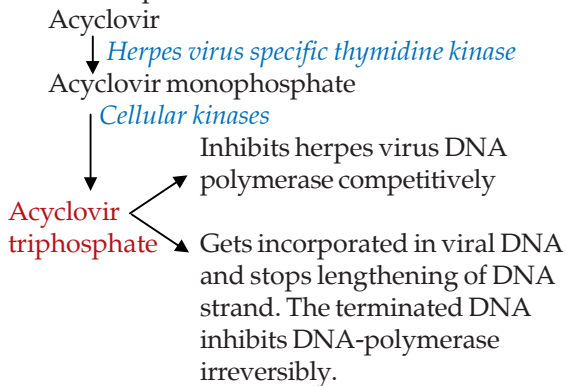

Acyclovir is preferentially taken up by the virus infected cells. Because of selective generation of the active inhibitor in the virus infected cell and its greater inhibitory effect on viral DNA synthesis, acyclovir has low toxicity for host cells: a several hundred-fold chemotherapeutic index has been noted.

Acyclovir is active only against herpes group of viruses; *H. simplex* type I is most sensitive followed by *H. simplex* type II > varicella-zoster virus=Epstein-Barr virus; while cytomegalovirus (CMV) is practically not affected. Both *H. simplex* and *varicella-zoster* virus have been found to develop resistance to acyclovir during therapy; the former primarily due to mutants deficient in thymidine kinase activity and the latter primarily by change in specificity of virus directed enzyme so that its affinity for acyclovir is decreased.

Pharmacokinetics Only about 20% of an oral dose of acyclovir is absorbed. It is little plasma protein bound and is widely distributed attaining CSF concentration that is 50% of plasma concentration. It penetrates cornea well. Acyclovir is primarily excreted unchanged in urine, both by glomerular filtration and tubular secretion; plasma $t_{1/2}$ is 2–3 hours. Renal impairment necessitates dose reduction.

ZOVIRAX 200 mg tab, 250 mg/vial for i.v. inj; CYCLOVIR 200 mg tab, 5% skin cream; HERPEX 200 mg tab, 3% eye oint, 5% skin cream; OCUVIR 200, 400, 800 mg tab, 3% eye oint, ACIVIR-DT 200, 400, 800 mg tab. ACIVIR EYE 3% oint.

Use Acyclovir is effective in patients with normal as well as deficient immune status.

1. *Genital Herpes simplex* Generally caused by type II virus; can be treated by topical, oral or parenteral acyclovir depending on stage and severity of disease.

Primary disease: 5% ointment is applied locally 6 times a day for 10 days. This is effective only if started early and in mild cases. Late and more severe cases should receive oral therapy (1 g/day in 5 divided doses or 400 mg TDS for 10 days) in addition to local therapy. Both local and oral therapies afford symptomatic relief and rapid healing of lesions, but do not prevent recurrences.

Recurrent disease: Topical therapy is totally ineffective. Response to oral treatment is slow and incomplete; severe cases may be treated parenterally—5 mg/kg i.v. infused over 1 hr, repeated 8 hourly for 10 days. Suppressive oral therapy with 400 mg BD has been shown to prevent recurrences as long as given. It is recommended to stop treatment after 1 yr and ascertain whether the patient is still having recurrences; if so restart treatment. After prolonged therapy frequency of recurrences is reduced. Continuous acyclovir prophylaxis is generally advocated in patients with > 8 recurrences per year. However, suppressive therapy reduces, but does not totally prevent, disease transmission to sexual partner.

2. *Mucocutaneous H. simplex* is a type I virus disease, remains localized to lips and gums; does not usually require specific treatment, but acyclovir skin cream may provide some relief. Spreading lesions may be treated with 10 day oral acyclovir. Prophylactic oral therapy may prevent sun exposure related recurrences. The disease often gets disseminated in immunocompromised individuals and may be treated with oral or i.v. acyclovir (15 mg/kg/day) for 7 days, but recurrences are not prevented.

3. *H. simplex encephalitis* (type I virus): Acyclovir 10 to 20 mg/kg/8 hr i.v. for ≥ 10 days is the drug

of choice. Treatment is effective only if started early: delay precludes salutary effect on mortality and neurological complications.

4. *H. simplex (type I) keratitis*: Acyclovir is equally effective as idoxuridine in superficial dendritic corneal ulcer, and may be better for deep stromal infections because of good corneal penetration. Though acyclovir eye ointment acts slower than idoxuridine eye drops, blindness can be prevented. The eye ointment should be applied 5 times daily till 3 days after healing.

5. *Herpes zoster*: The varicella-zoster virus is less susceptible to acyclovir. As such, higher doses are needed and it should be used only in immunodeficient individuals or in severe cases: 10 mg/kg/8 hr i.v. for 7 days. Oral therapy with 800 mg 5 times daily is beneficial only if started early. It affords symptomatic relief and faster healing of lesions. Postherpetic neuralgia is not prevented, though its duration may be shortened. Acyclovir skin cream may be applied on herpetic ulcers.

6. *Chickenpox*: in patients with immunodeficiency and in neonates only calls for specific therapy. Acyclovir (15 mg/kg/day i.v. × 7 days) is the drug of choice: reduces fever, eruptions, hastens healing and prevents visceral complications.

Oral acyclovir 400 mg 4 times a day for 7 days given during the incubation period may abort chickenpox in susceptible contacts.

Adverse effects

Topical: stinging and burning sensation after each application.

Oral: The drug is well tolerated; headache, nausea, malaise and some CNS effects are reported.

Intravenous: rashes, sweating, emesis and fall in BP occur only in few patients.

Dose-dependent decrease in g.f.r. is the most important toxicity; occurs especially in those with kidney disease; normalises on discontinuation of the drug.

Reversible neurological manifestations (tremors, lethargy, disorientation, hallucinations, convulsions and coma) have been ascribed to higher doses.

No teratogenic potential has been noted.

Valaciclovir It is an ester prodrug of acyclovir with improved oral bioavailability (55–70%) due to active transport by peptide transporters in the intestine. During passage through intestine and liver, it is completely converted to acyclovir in the first passage by esterases. Thus, higher plasma levels of acyclovir are obtained improving clinical efficacy in certain conditions; e.g. it is the drug of choice in herpes zoster. Valaciclovir is excreted in urine as acyclovir with a $t_{1/2}$ of 3 hours.

Dose: For genital herpes simplex—first episode 0.5–1.0 g BD × 10 days; recurrent episode 0.5 g BD × 3 days; suppressive treatment 0.5 g OD × 6–12 months.

For orolabial herpes 2 g BD × 1 day; in immunocompromised patient 1 g BD × 5 days.

For herpes zoster 1 g TDS × 7 days.

VALVIR 0.5 g, 1.0 g tabs.

Famciclovir It is an ester prodrug of a guanine nucleoside analogue *penciclovir* , which has good oral bioavailability and prolonged intracellular $t_{1/2}$ of the active triphosphate metabolite. Like acyclovir, it needs viral thymidine kinase for generation of the active DNA polymerase inhibitor. Famciclovir inhibits *H. simplex*, *H. zoster* but not acyclovir-resistant strains. Some activity against hepatitis B virus (HBV) has been noted. It is used as an alternative to acyclovir for genital or orolabial herpes and herpes zoster. Early treatment of herpes zoster reduces the duration of post herpetic neuralgia, but not its incidence.

Dose: Genital herpes (1st episode) 250 mg TDS × 5 days; recurrent cases 250 mg BD for up to 1 year. Herpes zoster and orolabial herpes 500 mg TDS for 7–10 days.

FAMTREX 250, 500 mg tabs.

Famciclovir is a less active alternative to lamivudine in chronic hepatitis B, but not in resistant cases. Side effects are headache, nausea, loose motions, itching, rashes and mental confusion.

Ganciclovir It is an analogue of acyclovir which is active against all herpes viruses including *H. simplex*, *H. zoster*,

E-B virus and cytomegalovirus (CMV). It is more active than acyclovir against CMV. The active triphosphate metabolite of ganciclovir attains much higher concentrations inside CMV infected cells. The plasma $t_{1/2}$ of ganciclovir is 2–4 hrs, but that of its triphosphate inside CMV infected cells is > 24 hrs. These factors account for its high activity against CMV infections. CMV can develop ganciclovir resistance by mutation.

Systemic toxicity of ganciclovir is high (bone marrow depression, rash, fever, vomiting, neuropsychiatric disturbances) and use is restricted to severe CMV infections (pneumonia/colitis) in immunocompromised (AIDS, transplant recipient) patients. Intravenous infusion of 10 mg/kg/day has prevented blindness in AIDS patients with CMV retinitis. Ganciclovir therapy has been found to lower HBV titre in chronic hepatitis B.

Foscarnet It is a simple straight chain phosphonate unrelated to any nucleic acid precursor which inhibits viral DNA polymerase and reverse transcriptase. It is active against *H. simplex* (including strains resistant to acyclovir), CMV (including ganciclovir resistant ones) and HIV. Viral resistance to foscarnet is minimal. However, viral selectivity of foscarnet is low. Oral absorption is poor. Its $t_{1/2}$ is 4–8 hours, and it is not metabolised.

Toxicity of foscarnet is high: damages kidney—produces a renal diabetes like condition, acute renal failure can also occur. Anaemia, phlebitis, tremor, convulsions and other neurological as well as constitutional symptoms due to hypocalcaemia are frequent. Administered by i.v. infusion, foscarnet has been used for:

1. CMV retinitis and other CMV infections in AIDS patients; efficacy is similar to ganciclovir, but includes resistant cases.
2. Acyclovir-resistant mucocutaneous *H. simplex* type II and varicella-zoster infections in AIDS patients.

When used to treat associated CMV/*H. simplex*/varicella-zoster infection in AIDS patient, it decreases HIV viral titre, but is not used primarily for HIV infections.

ANTI-RETROVIRUS DRUGS

These are drugs active against human immunodeficiency virus (HIV) which is a retrovirus. They are useful in prolonging and improving the quality of life and postponing complications of acquired immunodeficiency syndrome (AIDS) or AIDS-related complex (ARC), but do not cure the infection. The clinical efficacy of antiretrovirus drugs is monitored primarily by plasma HIV-RNA assays and CD4 lymphocyte count carried out at regular intervals.

The first antiretrovirus (ARV) drug *Zidovudine* was developed in 1987. Over the past 20 years,

> 20 drugs belonging to 3 classes have been introduced and a large number of others are under development.

Nucleoside reverse transcriptase inhibitors (NRTIs)

Zidovudine It is a thymidine analogue (azidothymidine, AZT), the prototype NRTI. After phosphorylation in the host cell—zidovudine triphosphate selectively inhibits viral reverse transcriptase (RNA-dependent DNA polymerase) in preference to cellular DNA polymerase.

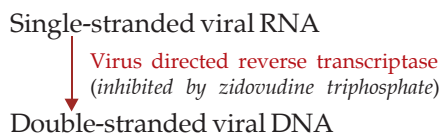

On the template of single-stranded RNA genome of HIV a double-stranded DNA copy is produced by viral reverse transcriptase. This DNA translocates to the nucleus and is integrated with chromosomal DNA of the host cell, which then starts transcribing viral genomic RNA as well as viral mRNA. Under the direction of viral mRNA, viral regulatory and structural proteins are produced. Finally, viral particles are assembled and matured. Zidovudine thus prevents infection of new cells by HIV, but has no effect on virus directed DNA that has already integrated into the host chromosome. It is effective only against retroviruses. Zidovudine itself gets incorporated into the growing viral DNA and terminates chain elongation. Resistance to AZT occurs by point mutations which alter reverse transcriptase enzyme. In the past, when AZT was used alone, >50% patients became nonresponsive to AZT within 1–2 years therapy due to growth of resistant mutants.

Pharmacokinetics The oral absorption of AZT is rapid, but bioavailability is ~65%. It is quickly cleared by hepatic glucuronidation ($t_{1/2}$ 1 hr); 15–20% of the unchanged drug along with the metabolite is excreted in urine. Plasma protein binding is 30% and CSF level is ~50% of that in plasma. It crosses placenta and is found in milk.

Dose Adults 300 mg BD; Children 180 mg/m² (max 200 mg) 6–8 hourly.

RETROVIR, ZIDOVIR 100 mg cap, 300 mg tab, 50 mg/5 ml syr VIRO-Z, ZIDOMAX, ZYDOWIN 100 mg cap, 300 mg tab. (to be taken with plenty of water).

Adverse effects Toxicity is mainly due to partial inhibition of cellular DNA polymerase. Anaemia and neutropenia are the most important and dose-related adverse effects.

Nausea, anorexia, abdominal pain, headache, insomnia and myalgia are common at the start of therapy but diminish later.

Myopathy, lactic acidosis, hepatomegaly, convulsions and encephalopathy are infrequent.

Interactions Paracetamol increases AZT toxicity, probably by competing for glucuronidation. Azole antifungals also inhibit AZT metabolism. Other nephrotoxic and myelosuppressive drugs and probenecid enhance toxicity. Stavudine and zidovudine exhibit mutual antagonism by competing for the same activation pathway.

Use Zidovudine is used in HIV infected patients only in combination with at least 2 other ARV drugs. However, its efficacy as monotherapy in AIDS has been confirmed in the past. HIV-RNA titer is reduced to undetectable levels and CD4 count increases progressively. Immune status is improved and opportunistic infections become less common. There is a sense of well-being and patients gain weight. AZT also reduces neurological manifestations of AIDS and new Kaposi's lesions do not appear. Mortality among AIDS patients is reduced. It has also been shown to slow the progression of HIV infection, including escalation of ARC to full blown AIDS. However, beneficial effects are limited from a few months to a couple of years after which progressively non-responsiveness develops.

AZT, along with one or two other ARV drugs is the standard choice for post exposure prophylaxis of HIV, as well as mother to offspring transmission.

Didanosine (ddI) It is a purine nucleoside analogue which after intracellular conversion to

didanosine triphosphate competes with ATP for incorporation in viral DNA, inhibits HIV reverse transcriptase and terminates proviral DNA. Antiretroviral activity of didanosine is equivalent to AZT. Mutational resistance develops, but only few AZT resistant mutants are non-responsive to didanosine also. Now it is used only in combination regimens.

Dose: 200 mg BD (for \geq 60 kg BW), 125 mg BD (< 50 kg BW) 1 hour before or 2 hour after meals.

DINEX EC, DDRETRO, VIROSINE DR 250 mg, 400 mg tabs.

Oral absorption of didanosine is somewhat erratic due to acid lability. It is metabolized as well as excreted unchanged; $t_{1/2}$ 1 to 1.5 hr. In contrast to AZT, it does not cause myelosuppression. The major dose-related toxicity is peripheral neuropathy and rarely pancreatitis. Diarrhoea, abdominal pain and nausea are the side effects.

Stavudine (d4T) It is also a thymidine analogue which acts in the same way as AZT. By utilizing the same thymidine kinase for activation, AZT antagonises the effect of stavudine. Resistance to stavudine develops as for other NRTIs.

It is well absorbed orally and rapidly metabolized ($t_{1/2}$ 1.5 hr). The anti-HIV efficacy of stavudine is comparable to AZT, and it is used in combination regimens. Peripheral neuropathy, lipodystrophy and rarely pancreatitis are the serious toxicities which have restricted its use.

Dose: 40 mg BD (> 60 kg BW), 30 mg BD (< 60 kg BW)
STAG, STAVIR, VIROSTAV 30, 40 mg caps.

Lamivudine (3TC) This deoxycytidine analogue is phosphorylated intracellularly and inhibits HIV reverse transcriptase as well as hepatitis B virus (HBV) DNA polymerase. Its incorporation into DNA results in chain termination. Most human DNA polymerases are not affected and systemic toxicity of 3TC is low. Point mutation in HIV-reverse transcriptase and HBV-DNA polymerase gives rise to rapid lamivudine resistance. Certain lamivudine-resistant mutants become slow growing. Some cross-resistance with ddI has been noted among HIV.

Oral bioavailability of 3TC is high and plasma $t_{1/2}$ longer (6–8 hours). Intracellular $t_{1/2}$ is still longer (> 12 hr). It is mainly excreted unchanged in urine.

Lamivudine is used in combination with other anti-HIV drugs, and appears to be as effective as AZT. It is also frequently used for chronic hepatitis B. HBV-DNA titre is markedly reduced and biochemical as well as histological indices of liver function improve. However, viral titres rise again after discontinuation. Even with continued medication HBV viraemia tends to return after 1 year due to emergence of resistant mutants.

Dose: For chronic hepatitis B—100 mg OD

For HIV infection—150 mg BD.

LAMIVIR 150 mg tab, 150 mg/ 5 ml soln; LAMIVIR-HBV 100 mg tab; HEPTAVIR, LAMIDAC, LAMUVID, VIROLAM 100, 150 mg tabs;

Lamivudine is generally well tolerated. Side effects are few—headache, fatigue, nausea, anorexia, abdominal pain. Pancreatitis and neuropathy are rare. Hematological toxicity does not occur.

Abacavir (ABC) This guanosine analogue is a potent ARV drug that acts after intracellular conversion to carbovir triphosphate. Resistance to ABC develops slowly, and it exhibits little cross resistance with other NRTIs. Its oral bioavailability is 80% and it is mainly eliminated by metabolism. The plasma $t_{1/2}$ is 1–1.5 hour, but intracellular $t_{1/2}$ of active metabolite is >12 hours. Hypersensitivity reactions such as rashes, fever, flu-like symptoms are the major problems. Some fatalities have occurred when patients developing the reaction were given further doses of ABC. Avoidance of alcohol is advised.

Dose: 300 mg BD or 600 mg OD.

ABAVIR, ABAMUNE 300 mg tab.

Non-nucleoside reverse transcriptase inhibitors (NNRTIs)

Nevirapine (NVP) and Efavirenz (EFV) These are nucleoside unrelated compounds which directly inhibit HIV reverse transcriptase without the need for intracellular phosphorylation. Their

locus of action on the enzyme is also different. They are more potent than AZT on HIV-1, but do not inhibit HIV-2. Viral resistance to these drugs develops by point mutation and cross resistance is common among different NNRTIs, but not with NRTIs or PIs.

Nevirapine is well absorbed orally and is extensively metabolized in liver with a $t_{1/2}$ of 30 hours. Oral absorption of efavirenz is incomplete (50%), but $t_{1/2}$ is longer (48 hours) and it is totally metabolized. Both NVP and EFV modestly induce CYP 3A4, 2D6 enzymes and enhance their own metabolism as well as that of other drugs.

The NNRTIs are indicated in combination regimens for HIV, and have succeeded in reducing HIV-RNA levels when an earlier regimen has failed.

Nevirapine *Dose* 200 mg/day, may be increased later to 200 mg BD.

NEVIMUNE, NEVIVIR, NEVIPAN, NEVIRETRO 200 mg tab

Rashes (commonest), nausea, headache are the usual side effects. Fever and rise in liver enzymes can occur. Nevirapine is potentially hepatotoxic. Avoid enzyme inducers (rifampin) and enzyme inhibitors (ketoconazole).

Efavirenz: *Dose* 600 mg OD on empty stomach.

EFAVIR, VIRANZ 200 mg tab., EVIRENZ 200 mg cap, 600 mg tab.

Side effects are headache, rashes, dizziness, insomnia and a variety of neuropsychiatric symptoms. It induces the metabolism of certain drugs and inhibits that of others.

Retroviral protease inhibitors (PIs)

An aspartic protease enzyme encoded by HIV is involved in the production of structural proteins and enzymes (including reverse transcriptase) of the virus. The large viral polyprotein is broken into various functional components by this enzyme. This protease acts at a late step in HIV replication, i.e. maturation of the new virus particles when the RNA genome acquires the core proteins and enzymes. Five protease inhibitors—*Indinavir (IDV)*, *Nelfinavir (NFV)*, *Saquinavir (SQV)*, *Ritonavir (RTV)* and *Lopinavir*

(in combination with ritonavir LPV/r) have been marketed in India for use against HIV. They bind to the protease molecule, interfere with its cleaving function, and are more effective viral inhibitors than AZT. Because they act at a late step of viral cycle, they are effective in both newly and chronically infected cells. Under their influence, HIV-infected cells produce immature noninfectious viral progeny—hence prevent further rounds of infection.

Oral bioavailability of PIs is variable (IDV and RTV ~65%, NFV >20%, SQV 15%) and their plasma $t_{1/2}$ ranges from 2–5 hours. All are extensively metabolized by CYP3A4 and other CYP isoenzymes. All (especially ritonavir and lopinavir) are potent inhibitors of CYP3A4, while few other CYP isoenzymes are induced. The PIs interact with many drugs. Nelfinavir and ritonavir induce their own metabolism.

Monotherapy with one of these drugs in previously AZT treated patients reduced HIV viral levels, increased CD4 cell count and improved the clinical condition. However, viral resistance developed against the PIs over months due to selection of resistant mutants in a stepwise manner. Combination of NRTIs with PIs has been found more effective than either drug given alone, and triple therapy is more effective than double therapy. Current recommendations are to use a PI in combination with either two NRTIs or one NRTI + one NNRTI.

Because different PIs both inhibit and induce specific CYP isoenzymes to different extents, drug interactions with them are common and often unpredictable. Manufacturer's package inserts should be consulted while coprescribing any other drug. Specifically, metabolism of PIs is induced by rifampin and other enzyme inducers rendering them ineffective. Another problem in their use is the large tablet load. In case of different PIs, 6–18 tablets are to be taken daily, some on empty stomach, but others with meals; and this has to go on for months and years. Patient acceptability and compliance are often low. One of the strategies adopted to reduce the dose of IDV, LPV and SQV is to combine them with a low

and subtherapeutic dose (100 mg) of ritonavir. By reducing first pass metabolism, ritonavir increases the bioavailability of the companion PI. This 'boosted PI regimen' permits reduction in the number/frequency of tablets to be taken each day. Lopinavir is marketed only in combination with ritonavir. Nelfinavir is not to be combined with ritonavir.

The most prominent adverse effects of PIs are gastrointestinal intolerance, asthenia, headache, dizziness, limb and facial tingling, numbness and rashes. Of particular concern are lipodystrophy (abdominal obesity, buffalo hump with wasting of limbs and face) and dyslipidaemia (raised triglycerides and cholesterol) which may necessitate hypolipidaemic drugs. Diabetes may be exacerbated. Indinavir crystallises in urine and increases risk of urinary calculi.

Indinavir It is to be taken on empty stomach; g.i. intolerance is common; excess fluids must be consumed to avoid nephrolithiasis.

Dose: 800 mg TDS (BD if taken with 100 mg RTV).

INDIVAN, INDIVIR, VIRODIN 400 mg cap.

Nelfinavir It is to be taken with meals and bioavailability is erratic. Often produces diarrhoea and flatulence; clinical efficacy may be somewhat lower than other PIs.

Dose: 750 mg TDS; NELFIN, NELVIR, NEIVEX 250 mg tab.

Ritonavir It is a potent PI; also a potent CYP3A4 inhibitor. Drug interactions, nausea, diarrhoea, paresthesias, fatigue and lipid abnormalities are prominent.

Dose: 600 mg BD, to be taken with food.

RITOMUNE, RITOMAX 100 mg cap; RITOVIR 250 mg tab.

Saquinavir Two types of formulations (hard gel and soft gel capsules) with differing, but low oral bioavailability have been produced. The tablet load is large and side effects are frequent; photosensitivity can occur. It is a weak inhibitor of CYP3A4.

Dose: 1200 mg TDS on full stomach; 1000 mg BD (with RTV 100 mg).

SAQUIN 200 mg tab.

Lopinavir It is available only in combination with RTV to improve bioavailability. Diarrhoea, abdominal pain, nausea and dyslipidaemias are more common.

Dose: 400 mg (with ritonavir 100 mg) BD with food.

RITOMAX-L: lopinavir 133.3 mg + ritonavir 33.3 mg cap.

FUSION INHIBITOR

Enfuvirtide This recently introduced HIV-derived synthetic peptide acts by binding to HIV-1 envelope glycoprotein (gp41) and preventing fusion of viral and cellular membranes. Entry of the virus into the cell is thus blocked. It is not active against HIV-2. No cross resistance with other classes of ARV drugs occurs. Administered s.c., it is used as add on drug to an optimized regimen in patients who have failed many earlier regimens.

Some antiretroviral combinations

1. Lamivudine 150 mg + Zidovudine 300 mg tab (1 tab BD); **COMBIVIR, CYTOCOM, DUOVIR, LAMUZID tab.**
2. Lamivudine 150 mg + Stavudine 30 mg or 40 mg tab (1 tab BD); **LAMIVIR-S, LAMOSTAD, VIROLIS tab.**
3. Lamivudine 150 mg + Zidovudine 300 mg + Nevirapine 200 mg tab (1 tab BD); **DUOVIR-N, CYTOCOM-N, NEXIVIR-Z.**
4. Lamivudine 150 mg + Stavudine 30 mg or 40 mg + Nevirapine 200 mg tab (1 tab BD); **LAMOSTAD-N, TROMUNE, VIROLANS.**
5. Lamivudine 150 mg + Zidovudine 300 mg 2 tab and Efavirenz 600 mg 1 tab kit; **CYTOCOM-E kit.**

HIV TREATMENT GUIDELINES

The treatment of HIV infection and its complications is complex, prolonged, needs expertise, strong motivation and commitment of the patient, resources and is expensive. Antiretroviral therapy is only 20 years old, and strategies are still evolving. Initially, anti-HIV drugs were used singly one after the other as each failed in a patient due to emergence of resistance. Understanding the biology of HIV infection and availability of several potent drugs belonging to different classes has mandated 'highly active antiretroviral therapy' (HAART) with combination of 3 or more drugs whenever indicated. Monotherapy is contraindicated.

It has been realized that even with HAART, which rapidly kills > 99% virions, a small number survive within

the resting CD4 lymphocytes and invariably give rise to relapse when treatment is discontinued despite complete absence of detectable viraemia and normal CD4 cell count for years. Moreover, HIV reverse transcriptase is highly copying error prone, implying that viral replication produces changes at some base pairs (and codons) with high frequency—rate of mutation is high. Some mutations confer resistance to one or the other antiretroviral drugs. The resistant mutants are selected by anti-HIV therapy and in time an apparently sensitive population is replaced by resistant virions. As the disease progresses in the individual (and several anti-HIV drugs are used) the HIV population becomes genetically complex and diverse with respect to susceptibility to drugs. Each failing regimen limits future treatment options. Even primary drug resistance (i.e. in untreated patients) is being detected in ~10% HIV patients.

Since none of the currently available regimens can eradicate HIV from the body of the patient, the goal of therapy is to maximally and durably inhibit viral replication so that the patient can attain and maintain effective immune response towards potential microbial pathogens. Greater the suppression of viral replication, lesser is the chance of emergence of drug resistant virus.

Initiating antiretroviral therapy Although it is attractive to treat all symptomatic and asymptomatic HIV positive patients, no long-term clinical benefit has been demonstrated in asymptomatic cases with reasonable immune competence (CD4 cell count > 350/μl). Arguments against early treatment in asymptomatic stable patients include—deleterious effect of anti-HIV drugs on quality of life, their side effects and toxicity, especially lipid abnormalities, drug interactions, risk of drug resistance limiting future treatment options, limited durability of available regimens, risk of dissemination of resistant virus and high cost. The best time to initiate anti-HIV therapy remains uncertain. Various professional bodies and health authorities have framed treatment guidelines from time-to-time. A summary of current consensus is presented below.

1. CD4 cell count is the major determinant of initiating therapy in asymptomatic cases. Increased mortality occurs when treatment is begun after CD4 count has fallen below 200/μl, because the patient is at high risk of serious opportunistic infection, and response to anti-HIV drugs is suboptimal.

2. All cases of symptomatic HIV disease—treatment recommended.
3. Asymptomatic HIV disease with CD4 count $\leq 200/\mu\text{l}$ —treatment recommended.
4. Asymptomatic HIV disease with CD4 count $> 200/\mu\text{l}$ —treatment decision to be individualized based on:
 - CD4 cell count and rate of decline: Most authorities agree that patients with > 350 CD4 cells/ μl need not be treated. Thus, treatment may be initiated at CD4 count between 200–350/ μl depending on other considerations. A decline of > 100 CD4 cells/ μl per annum is considered high—and an indication for initiating therapy.
 - HIV-RNA level: $> 50,000$ copies of HIV-RNA/ml is considered high. However, many authorities recommend treatment in patients even with $> 20,000$ copies/ml.
 - Patient's interest and potential to adhere to therapy.
 - Individual risks of drug toxicity and interactions.

Therapeutic regimens Whenever treatment is instituted, it should be aggressive (HAART) aiming at suppressing plasma viral load to undetectable levels (< 50 copies of HIV-RNA/ml). Therapy with 3 antiretroviral drugs is considered optimal. Addition of a 4th drug to treatment-naïve patients affords no additional benefit; may be tried in failed patients. Due to availability of multiple drugs, a variety of combination regimens are possible and have been employed. However, no specific combination can be considered optimal initial regimen for all patients. Choice has to be made on the basis of efficacy, durability, tolerability, convenience, drug interactions, impact on future options and cost.

Some of the preferred and alternative regimens for initial treatment (employing ARV drugs currently available in India) are given in the box. The important general points are:

- The 3 drugs in the regimen should belong to at least 2 different classes. Single class regimens are inferior. There is convincing evidence that 3NRTI regimens are clinically less effective than those which include a NNRTI or a PI.
- The 3 NRTI regimen is employed only when a NNRTI or PI cannot be used; such as in patients receiving rifampin or other interacting drugs.

Preferred and alternative anti-HIV regimens

Preferred regimens

2 NRTI + NNRTI (PI sparing)

1. Zidovudine + lamivudine + efavirenz

2 NRTI + PI

1. Zidovudine + lamivudine + lopinavir/r

Alternative regimens

2 NRTI + NNRTI (PI sparing)

1. Zidovudine + lamivudine + nevirapine
2. Lamivudine + stavudine + efavirenz
3. Lamivudine + stavudine + nevirapine
4. Lamivudine + abacavir + efavirenz
5. Lamivudine + abacavir + nevirapine

2 NRTI + PI

1. Lamivudine + zidovudine + indinavir
2. Lamivudine + stavudine + ritonavir
3. Lamivudine + abacavir + lopinavir/r
4. Lamivudine + abacavir + nelfinavir

3 NRTI*

1. Zidovudine + lamivudine + abacavir

* Only when a NNRTI or PI cannot be used; as in patient receiving rifampin.

- The PI sparing regimens (2 NRTI + NNRTI) are more convenient with lower pill burden, simpler dosing schedules, more acceptable, better tolerated and produce less metabolic complications; are preferred by many.
- The 3 class regimen (NRTI + NNRTI + PI) is reserved for advanced cases who have failed multiple earlier regimens, so as to avoid multiclass resistance and higher toxicity.
- If drug toxicity develops, either the entire regimen should be interrupted or the offending drug should be changed. No dose reduction should be tried.
- 'Drug holidays' or 'structured treatment interruptions' may briefly improve well being (by absence of side effects), but allow viral replication and increase risk of drug resistance; are not recommended.
- Treatment is practically life-long.
- Pregnancy in women does not contraindicate anti-HIV therapy. Drugs considered relatively safe during pregnancy are: Zidovudine, lamivudine, nevirapine, nelfinavir, saquinavir.

- The ARV drug combinations that should not be employed are given in the box.

Antiretroviral drug combinations to be avoided

- Zidovudine + stavudine: Pharmacodynamic antagonism
- Stavudine + didanosine: Increased toxicity (lactic acidosis)
- Lamivudine + didanosine: Clinically not additive

Durability of the regimens depends mainly on adherence of the patient to it. Compliance is a major determinant of outcome. Therapy should not be discontinued during an acute opportunistic infection, except in case of intolerance, interactions or toxicity. Since multiple antiretroviral, anti-*P. jiroveci*, antitoxoplasma, anti-CMV / herpes virus, antitubercular, antifungal or other drugs may have to be used in a patient, careful attention to drug interactions and toxicities has to be paid.

Changing a failing regimen Change of regimen may be considered if:

- Less than 10 fold reduction in plasma viral load occurs by 4 weeks therapy.
- Failure to suppress plasma viral load to undetectable level within 6 months of therapy.
- Repeated detection of virus (> 400 copies/ml) in plasma after initial suppression to undetectable levels.
- Clinical deterioration, fall in CD4 cell count, serious opportunistic infection.

Treatment failures are to be anticipated and occur within the first year or in successive years with nearly all regimens. Optimally, the regimen should be changed entirely (all 3 drugs changed) to drugs that have not been administered earlier. A single drug should not be changed or added to a failed regimen. In designing second line regimens, drugs with known overlapping viral resistance should be avoided, e.g. indinavir should not be substituted for nelfinavir or saquinavir; efavirenz should not be replaced by nevirapine. Viral resistance testing is recommended for selecting the salvage regimen. With repeated failures it may become more difficult to construct an active combination. The goal of therapy in this situation is to retard clinical progression of the disease rather than complete suppression of viraemia.

Prophylaxis of HIV infection

Post-exposure prophylaxis (PEP) Health care workers and others who get accidentally exposed to the risk of HIV infection by needlestick or other sharp injury, contact with blood/biological fluid of patients or blood transfusion should be considered for PEP. The aim of PEP is to suppress local viral replication prior to dissemination, so that the infection is aborted. However, PEP is not necessary when the contact is only with intact skin, or with mucous membrane by only a few drops for short duration. It is also not indicated when the source is known to be HIV negative. The National AIDS Control Organization (NACO, India) recommends 2 types of regimens (see box) for PEP depending on the magnitude of risk of HIV transmission.

Post-exposure prophylaxis of HIV

<i>Basic (2 drug) regimen</i>	(for low risk)*
Zidovudine 300 mg + Lamivudine 150 mg }	Twice daily for 4 weeks
<i>Expanded (3 drug) regimen</i>	(for high risk) [§]
Zidovudine 300 mg + Lamivudine 150 mg + Indinavir 800 mg (or another PI)	Twice daily Thrice daily All for 4 weeks

*Low risk

- When the source is HIV positive, but asymptomatic with low HIV-RNA titre and high CD4 cell count.
- Exposure is through mucous membrane, or superficial scratch, or through thin and solid needle.

§High risk

- When the source is symptomatic AIDS patient with high HIV-RNA titre or low CD4 count.
- Exposure is through major splash or large area contact of longer duration with mucous membrane or abraded skin or through large bore hollow needle, deep puncture, visible patient's blood on the needle.

In developed countries, where a large number of source HIV patients have received one or more anti-HIV regimens and may be harbouring drug-resistant virus, alternative prophylactic regimens using stavudine, didanosine, abacavir, efavirenz or other drugs with which the source has not been treated, have also been used. Nevirapine is not

recommended for PEP due to its hepatotoxic potential.

When indicated, PEP should be started as soon as possible, preferably within 1–2 hours of exposure. The likelihood of preventing infection declines with the delay; some guidelines do not recommend starting it beyond 72 hours of exposure. According to others, in case of default, PEP may even be started even 1–2 weeks later. Though HIV infection may not be prevented, onset of AIDS may be delayed by the late-start PEP.

Perinatal prophylaxis HIV may be transmitted from the mother to the child either through the placenta, or during delivery, or by breastfeeding. The highest risk of transmission is during the birth process. In HIV positive women who are not receiving ART, zidovudine (300 mg BD) started during 2nd trimester and continued through delivery to postnatal period, with treatment of the neonate for 6 weeks has been found in clinical trials to reduce the chances of mother-to-child transmission by 2/3rd. Combination therapy is even more effective. Even if not started earlier, zidovudine administered during labour and then to the infant is also substantially protective. Many obstetricians offer 3 drug ART to HIV positive asymptomatic women after the 1st trimester. Breastfeeding by HIV positive mother should be discouraged, as it may transmit the virus to the infant.

ANTI-INFLUENZA VIRUS DRUGS

Amantadine

Chemically, it is a tricyclic amine unrelated to any nucleic acid precursor, but inhibits replication of influenza A virus (a myxovirus). It appears to act at an early step (possibly uncoating) as well as at a late step (viral assembly) in viral replication. A protein designated 'M2' which acts as an ion channel has been identified as one of its targets of action. Resistance to amantadine develops by mutation causing amino acid substitutions in the M2 protein. Amantadine is well absorbed orally

and excreted unchanged in urine over 2–3 days ($t_{1/2}$ 16 hr).

Adverse effects Generally well tolerated; nausea, anorexia, insomnia, dizziness, nightmares, lack of mental concentration, rarely hallucinations have been reported. Ankle edema occurs due to local vasoconstriction.

Uses

1. Prophylaxis of influenza A₂ during an epidemic or seasonal, especially in high risk patients. It does not interfere with antibody response to influenza vaccination; both may be given together. If the vaccine is given, amantadine can be stopped after 2 weeks. It is quite virus specific: influenza B is unaffected.

2. Treatment of influenzal (A₂) illness: a modest therapeutic effect (reduction in fever, congestion and cough) occurs if the drug is given quickly after the symptoms appear. A 5 day treatment is advised.

3. Parkinsonism (*see* Ch. 31)

Dose: 100 mg BD, elderly—half dose, children 5 mg/kg/day; **AMANTREL, NEAMAN 100 mg tab.**

Contraindications: epilepsy and other CNS disease; gastric ulcer, pregnancy.

Rimantadine It is a more potent, long-acting ($t_{1/2}$ 30 hr) and better tolerated congener of amantadine. Oral bioavailability is higher and it is largely metabolized. Dose and clinical application is similar to amantadine. Amantadine resistant virus is resistant to rimantadine as well.

Oseltamivir (TAMIFLU) This recently developed anti-influenza virus drug has a broader-spectrum activity covering influenza A (amantadine sensitive as well as resistant), influenza B and avian-influenza (bird flu) H5N1 and other strains. It is an ester prodrug that is rapidly and nearly completely hydrolysed during absorption in intestine and by liver to the active form *oseltamivir carboxylate*. The active metabolite is not further metabolized and is excreted by the kidney with a $t_{1/2}$ of 6–10 hours. It acts by inhibiting influenza virus neuraminidase enzyme which is needed for release of progeny virions from the infected cell. Spread of the virus in the body is thus checked.

Oseltamivir is indicated both for prophylaxis as well as treatment of influenza A, B and bird flu. Started at the onset of symptoms, it reduces the severity and duration

of illness. However, considering the cost, and to preserve its efficacy, use should be restricted to high risk subjects. *Dose:* therapeutic 75 mg oral BD for 5 days; prophylactic 75 mg OD.

Side effects are nausea and abdominal pain due to gastric irritation (reduced by taking the drug with food), headache, diarrhoea, cough and insomnia. Skin reactions have been reported.

Zanamivir (RELENZA) Another influenza virus (A, B, avian strains) neuraminidase inhibitor that is administered by inhalation as a powder due to very low oral bioavailability. Small amount that is absorbed after inhalation is excreted by the kidney with a $t_{1/2}$ of 2–5 hours. The mechanism of action, clinical utility and efficacy of zanamivir are similar to that of oseltamivir. Though viral resistance against both is not clinically significant, some variants resistant to oseltamivir remain sensitive to zanamivir and *vice versa*.

Dose: 10 mg through breath actuated inhaler, BD \times 5 days for treatment, and OD for prophylaxis.

The inhaled powder can induce bronchospasm in some individuals. This may be severe in asthmatics; contraindicated in them. Headache, dizziness, nausea and rashes are mild and infrequent side effects.

NONSELECTIVE ANTIVIRAL DRUGS

Ribavirin This purine nucleoside analogue has broad-spectrum antiviral activity, including that against influenza A and B, respiratory syncytial virus and many other DNA and double stranded RNA viruses. Its mono- and triphosphate derivatives generated intracellularly inhibit GTP and viral RNA synthesis and have other sites of action as well. No viral resistance to ribavirin has yet been observed.

Oral bioavailability of ribavirin is ~50%. It is partly metabolized and eliminated in a multi-exponential manner; accumulates in the body and persists months after discontinuation.

Administered orally or i.v. ribavirin has been used in influenza A/B and measles in immunosuppressed patients as well as for herpes virus infections, acute hepatitis, but is not a first line drug for any of these. Combined with interferon α , ribavirin is the standard treatment for chronic hepatitis C. Nebulized ribavirin has been used for respiratory syncytial virus bronchitis in infants and children, particularly those with congenital heart disease, prematurity or other high

risk conditions. It has also shown efficacy in some rare viral infections.

Dose: 200 mg QID (children 10 mg/kg/day).

VIRAZIDE, RIBAVIN 100, 200 mg caps, 50 mg/5 ml syr.

Prominent toxic effects are anaemia, haemolysis, CNS and g.i. symptoms. It is also teratogenic. The aerosol can cause irritation of mucosae and bronchospasm.

Adefovir dipivoxil It is the diester prodrug of AMP analogue *adefovir* which is active against hepatitis B virus (HBV) and some other DNA viruses. Esterases in the intestine and liver release the active drug during absorption to attain oral bioavailability of ~60% in terms of adefovir, which is then distributed in whole body water. On entering cells, adefovir (a monophosphate) is phosphorylated to the diphosphate which has high affinity for HBV DNA polymerase. This enzyme is inhibited and adefovir itself gets incorporated in the viral DNA resulting in termination of the DNA chain. While plasma $t_{1/2}$ of adefovir is ~7 hours (due to renal excretion), intracellular $t_{1/2}$ of the diphosphate is upto 18 hours.

Adefovir is indicated in chronic hepatitis B, including lamivudine-resistant cases and those having concurrent HIV infection. There is no cross resistance between adefovir and lamivudine. Clinical, biochemical (liver function tests), histological, serological and virological response occurs in nearly 50% patients within 1 year. More cases respond with continued treatment. The optimum duration of treatment is uncertain at present.

Dose: 10 mg/day; **ADESERA, ADFOVIR 10 mg tab.**

At 10 mg/day dose adefovir is well tolerated. Side effects are sore throat, headache, weakness, abdominal pain and flu syndrome. Nephrotoxicity occurs at higher doses and in those with preexisting renal insufficiency. Lactic acidosis is a risk in patients receiving anti-HIV drugs.

Interferon α

Interferons are low molecular weight glycoprotein cytokines produced by host cells in

response to viral infections and some other inducers. They have nonspecific antiviral as well as other complex effects on immunity and cell proliferation. Interferons bind to specific cell surface receptors and affect viral replication at multiple steps: viral penetration, synthesis of viral mRNA, assembly of viral particles and their release, but the most widespread effect is direct or indirect suppression of viral protein synthesis, i.e. inhibition of translation. Interferon receptors are JAK-STAT tyrosine protein kinase receptors which on activation phosphorylate cellular proteins. These then migrate to the nucleus and induce transcription of 'interferon-induced-proteins' which exert antiviral effects.

Interferons inhibit many RNA and DNA viruses, but they are host specific: those produced by another species have poor activity in man. Three types of human interferons (α , β and γ) have been produced by recombinant DNA technology. Only interferon α_{2A} and α_{2B} have antiviral activity. After i.m./s.c. injection, interferon is distributed to tissues and is degraded; may be detectable in plasma for 24 hours. However, cellular effects are longer lasting and it is generally administered thrice weekly. Complexed with polyethylene glycol (*pegylated interferon*), it is absorbed more slowly—exerts more sustained effects, permitting weekly administration and improving clinical efficacy.

ALFERON: Interferon α_{2A} 3MU/vial inj.

REALFA-2B, SHANFERON, VIRAFERON: Interferon α_{2B} 3MU, 5MU vials for inj.

Uses

1. Chronic hepatitis B and C: Interferon causes disappearance of HBV-DNA from plasma and improvement in liver function tests/histology in nearly half of the patients. High doses (10 MU) injected thrice weekly for 6 months often produce prolonged remission, but relapses do occur. The

newer pegylated interferons produce better and more sustained responses. Addition of ribavirin has the potential to further decrease chances of relapse.

2. AIDS-related Kaposi's sarcoma (but not to treat HIV as such). However, interferon accentuates haematological toxicity of zidovudine.

3. Condyloma acuminata caused by papilloma virus is usually treated with topical podophyllin. Intralesional interferon injection may be used in refractory cases.

4. *H. simplex*, *H. zoster* and CMV infections in immunocompromised patients: interferon is inferior to acyclovir/ganciclovir; may be used as second line/adjuvant drug.

5. Rhinoviral cold: intranasal interferon is prophylactic, but not beneficial in those already having cold.

Interferons are also used in chronic myelogenous leukaemia and multiple myeloma.

Interferon is not effective orally. Clinical utility of s.c. or i.m. injected interferon is limited by substantial adverse effects.

Adverse effects

Flu-like symptoms—fatigue, aches and pains, malaise, fever, dizziness, anorexia, taste and visual disturbances: develop a few hours after each injection, but become milder later.

Neurotoxicity—numbness, neuropathy, tremor, sleepiness, rarely convulsions.

Myelosuppression (dose limiting)—neutropenia, thrombocytopenia.

Thyroid dysfunction (hypo as well as hyper).

Hypotension, transient arrhythmias, alopecia and liver dysfunction.



These are drugs used for prophylaxis, treatment and prevention of relapses of malaria.

Malaria, caused by 4 species of the protozoal parasite *Plasmodium*, is endemic in most parts of India and other tropical countries. It is one of the major health problems. As per latest WHO estimates there are 300–500 million new clinical cases globally and >1 million deaths occur due to malaria each year, 90% of which are in Africa. In India the National Malaria Eradication Programme (NMEP), started in 1958, achieved near complete disappearance of the disease in 1960s (from 75 million cases in 1950s to 0.1 million cases in 1960s). However, due to the development of insecticide resistance among mosquitoes and other factors, it staged a comeback in the mid 1970s (6.47 million cases in 1976), and continues to prevail in endemic/subendemic proportions in different areas. Conceding that eradication of malaria is not possible, NMEP was renamed National Antimalaria Programme (NAMAP). Its scope has now been widened to include other vector borne diseases, and it is called 'National vector borne diseases control programme' (NVBDCP). For the year 2005, the NVBDCP has reported 1.8 million slide proven malaria cases in India, out of which ~ 44% were falciparum

malaria with 963 deaths. The WHO estimates that actual number of malaria cases in India is 6 times more, i.e. ~12 million.

The bark of *Cinchona* tree, growing in Peru, was introduced in Europe in the early 17th century as a cure for fevers. Later it was realized to be a specific remedy for malaria. *Quinine*, isolated from *Cinchona* bark in 1820, replaced the crude preparation and continued to be the major antimalarial drug till 1942. The world's supply of *Cinchona* bark for producing quinine was met by Java and neighbouring countries. This was cut off from the Germans during World War I and from the Allies during World War II. Due to enormous military importance of malaria and its treatment, intense activity was initiated for the development of antimalarial drugs. *Mepacrine* was produced in Germany in 1926 and extensively field tested by the Allies during World War II. *Chloroquine* was produced in USA soon after as a less toxic alternative to mepacrine. It had already been synthesized and used by Germans in 1934 as 'Resochin'. *Proguanil* was introduced in 1945 by the British as a well tolerated clinical curative.

None of the above drugs were found to be capable of preventing relapses in vivax malaria. *Pamaquine* was the first 8-aminoquinoline to be tested in Germany in the 1920s. However, no attention was paid to it because of its poor schizontocidal action. This class of drugs was retested during World War II as radical curative and *Primaquine* emerged as the most desirable drug. *Pyrimethamine* was produced in 1951 under a planned post-war research programme for antimalarial drugs. The important additions of the recent years are *Mefloquine*, *Artemisinin* and its derivatives/congeners, *pyronaridine* and few other synthetic compounds for resistant falciparum malaria.

CLASSIFICATION

1. *4-Aminoquinolines* Chloroquine, Amodiaquine, Piperaquine.
2. *Quinoline-methanol* Mefloquine.
3. *Cinchona alkaloid* Quinine, Quinidine
4. *Biguanides* Proguanil (Chloroguanide) Chlorproguanil
5. *Diaminopyrimidines* Pyrimethamine
6. *8-Aminoquinoline* Primaquine, Bulaquine
7. *Sulfonamides and sulfone* Sulfadoxine Sulfamethopyrazine Dapsone

8. *Tetracyclines* Tetracycline, Doxycycline
9. *Sesquiterpine lactones* Artesunate, Artemether, Arteether
10. *Amino alcohols* Halofantrine, Lumefantrine
11. *Mannich base* Pyronaridine
12. *Naphthoquinone* Atovaquone

OBJECTIVES AND USE OF ANTIMALARIALS

The aims of using drugs in relation to malarial infection are:

- (i) To prevent and treat clinical attack of malaria.

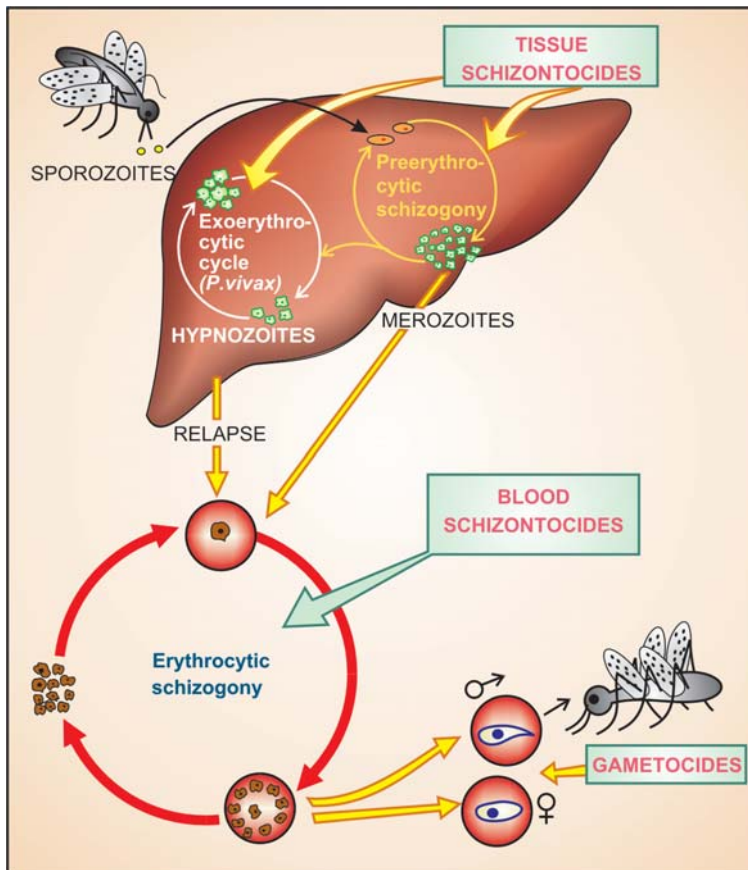

Fig. 59.1: The life cycle of malarial parasite in man. Stages and forms of the parasite at which different types of antimalarial drugs act are indicated.

Table 59.1: Comparative properties of antimalarial drugs

DRUG	PRE-ERYTHRO.		ERYTHROCYTIC		PHASE	EXO ERYTHRO.		GAMETES		RESISTANCE	TOXICITY GRADING
	Fal.	Viv.	Activity	Onset	Duration	Viv.	Fal.	Viv.			
1. Chloroquine	-	-	+	Fast	Long	-	-	+	Slow	±	
2. Mefloquine	-	-	+	Int	Long	-	-	-	Minor	++	
3. Quinine	-	-	+	Int	Short	-	-	+	Minor	+++	
4. Proguanil	+	±	+	Slow	Short	-	*	*	Rapid	±	
5. Pyrimethamine	-	-	+	Slow	Long	-	*	*	Rapid	+	
6. Primaquine	+	+	±	-	-	+	+	+	Minor	++	
7. Sulfonamides	-	-	±	Slow	Long	-	-	-	Minor	±±	
8. Tetracyclines	+	-	+	Slow	Short	-	-	-	Nil	+	
9. Artemisinin	-	-	+	Fastest	Short	-	+	+	Nil	+	
10. Lumefantrine	-	-	+	Int	Long	-	-	-	Nil	+	

*Do not kill gametes but inhibit their development in mosquito.

Pre-erythro. — Preerythrocytic stage; Exo-erythro. — Exoerythrocytic stage

Fal. — *P. falciparum*; Viv — *P. vivax*; Int — Intermediate

- (ii) To completely eradicate the parasite from the patient's body.
- (iii) To reduce the human reservoir of infection — cut down transmission to mosquito.

These are achieved by attacking the parasite at its various stages of life cycle in the human host (see Fig. 59.1). Antimalarials that act on erythrocytic schizogony are called *erythrocytic schizontocides*, those that act on preerythrocytic as well as exoerythrocytic (*P. vivax*) stages in liver are called *tissue schizontocides*, while those which kill gametocytes in blood are called *gametocides*. Antimalarial drugs exhibit considerable stage selectivity of action (see Table 59.1). Antimalarial therapy is given in the following forms.

1. Causal prophylaxis The preerythrocytic phase (in liver), which is the *cause* of malarial infection and clinical attacks, is the target for this purpose.

- Proguanil is a causal prophylactic, primarily for *P. falciparum*, but is not employed routinely because it has to be given daily and is not very effective against *P. vivax*.

- Primaquine is a causal prophylactic for all species of malaria, but has not been used in mass programmes, because of its toxic potential. Trials in Kenya and Irian Jaya have successfully used primaquine 0.5 mg/kg daily against both *P. falciparum* and *P. vivax* in subjects with normal G-6-PD levels. The CDC (USA) recommends it only for subjects who cannot take any other prophylactic drug.

2. Suppressive prophylaxis The schizontocides which suppress the erythrocytic phase and thus attacks of malarial fever can be used as prophylactics. Though the exoerythrocytic phase in case of vivax and other relapsing malarials continues, clinical disease does not appear.

- Chloroquine 300 mg (base*) or 5 mg/kg weekly. In travellers, start one week before with a loading dose of 10 mg/kg and continue till one month after return from endemic area. The last dose should be 25 mg/kg over 3 days along with primaquine 15 mg/day for 14 days. It

* All doses expressed in terms of base, e.g. chloroquine phosphate 250 mg = 150 mg base.

should not be given for > 3 yr for fear of cumulative toxicity.

- Proguanil 200 mg daily with chloroquine 300 mg weekly affords substantial protection against moderately chloroquine-resistant *P. falciparum*, but less than that afforded by mefloquine. This has been successfully used in Africa. In India NVBDCP recommends it for visitors to areas with chloroquine resistance.
- Mefloquine 250 mg weekly till 4 weeks after return from endemic area has been used for areas where chloroquine-resistant *P. falciparum* is prevalent. In India use of mefloquine for prophylaxis is not allowed among residents, but may be used by travellers.
- Doxycycline 100 mg daily starting day before travel and taken till 4 weeks after return from endemic area for chloroquine resistant *P. falciparum*, is an alternative regimen for individuals unable to take mefloquine. It is contraindicated in pregnant women and children < 8 yr.

Chemoprophylaxis of malaria should be limited to short-term use in special risk groups, such as — nonimmune travellers, nonimmune persons living in endemic areas for fixed periods (army units, labour forces) and pregnant women (falciparum malaria has serious consequences in the pregnant). Start prophylaxis after 1st trimester and continue till 1 month after delivery.

3. Clinical cure The erythrocytic schizontocides are used to terminate an episode of malarial fever. The available drugs can be divided into:

(a) **Fast-acting high-efficacy drugs:** Chloroquine, amodiaquine, quinine, mefloquine, halofantrine, lumefantrine, atovaquone, artemisinin; they can be used singly to treat attacks of malarial fever.

(b) **Slow-acting low-efficacy drugs:** Proguanil, pyrimethamine, sulfonamides, tetracyclines; they are used only in combination for clinical cure.

The faster acting drugs are preferred, particularly in falciparum malaria where delay in treatment may result in death even if the parasites are cleared from blood by the drug. The exoerythrocytic phase of vivax and ovale persists

which can cause *relapses* subsequently without reinfection. Thus, the above drugs are radical curatives for falciparum, but not for relapsing malaria. *Recrudescences* occur in falciparum infection if the blood is not totally cleared of the parasites by the drug.

The drugs and regimens used for uncomplicated falciparum and vivax malaria are detailed in the box. Only oral drugs are used for uncomplicated malaria.

Treatment of uncomplicated malaria

A. Vivax malaria

1. Chloroquine 600 mg (10 mg/kg) followed by 300 mg (5 mg/kg) after 8 hours and then for next 2 days (total 25 mg/kg over 3 days) + Primaquine 15 mg (0.25 mg/kg) daily × 14 days

In occasional case of chloroquine resistance

2. Quinine 600 mg (10 mg/kg) 8 hourly × 7 days + Doxycycline 100 mg daily × 7 days + Primaquine (as above)

B. Chloroquine-sensitive falciparum malaria

1. Chloroquine (as above) + Primaquine 45 mg (0.75 mg/kg) single dose (as gametocidal)

In case of intolerance to chloroquine

2. Sulfadoxine 1500 mg (25 mg/kg) + Pyrimethamine 75 mg (1.25 mg/kg) single dose + Primaquine 0.75 mg/kg single dose

C. Chloroquine-resistant falciparum malaria

- 1.* Artesunate 100 mg BD (4 mg/kg/day) × 3 days + Sulfadoxine[#] 1500 mg (25 mg/kg) + Pyrimethamine 75 mg (1.25 mg/kg) single dose
or
2. Artesunate 100 mg BD (4 mg/kg/day) × 3 days + Mefloquine[#] 750 mg (15 mg/kg) on 2nd day and 500 mg (10 mg/kg) on 3rd day.
or
3. Artemether 80 mg + Lumefantrine 480 mg twice daily × 3 days (child 25–35 kg BW $\frac{3}{4}$ dose; 15–25 kg BW $\frac{1}{2}$ dose; 5–15 kg BW $\frac{1}{4}$ dose)
or
- 4.[§] Quinine 600 mg (10 mg/kg) 8 hourly × 7 days + Doxycycline 100 mg daily × 7 days.

*First line ACT under NVBDCP

[§]Second line drug under NVBDCP

[#]Sulfadoxine-pyrimethamine (S/P) alone and mefloquine alone are also used, but should preferably be combined with artesunate.

Relapses of vivax/ovale malaria are treated in the same way as the primary attack because the parasite remains sensitive to the drug. Recrudescence in falciparum malaria indicates resistant infection: should be treated with an alternative drug as per local needs.

Severe and complicated falciparum malaria This includes *P. falciparum* infection attended by any one or more of—hyperparasitaemia, hyperpyrexia, fluid and electrolyte imbalance, acidosis, hypoglycaemia, prostration, cardiovascular collapse, jaundice, severe anaemia, spontaneous

bleeding, pulmonary edema, haemoglobinuria, black water fever, renal failure and cerebral malaria. Parenteral (i.m./i.v.) drugs have to be used; oral drugs may be substituted when the condition improves. Drugs and regimens employed are detailed in the box.

Treatment of severe and complicated falciparum malaria*

1. *Artesunate*: 2.4 mg/kg i.v. or i.m., followed by 2.4 mg/kg after 12 and 24 hours, and then once daily for 7 days. Switchover to 3 day oral ACT inbetween whenever the patient can take and tolerate oral medication.
or
2. *Artemether*: 3.2 mg/kg i.m. on the 1st day, followed by 1.6 mg/kg daily for 7 days. Switchover to 3 day oral ACT inbetween whenever the patient is able to take oral medication.
or
3. *Arteether*: 3.2 mg/kg i.m. on the 1st day, followed by 1.6 mg/kg daily for the next 4 days. Switchover to 3 day oral ACT inbetween whenever the patient is able to take oral medication.
or
4. *Quinine diHCl*: 20 mg/kg (loading dose) diluted in 10 ml/kg 5% dextrose/dextrose-saline and infused i.v. over 4 hours, followed by 10 mg/kg (maintenance dose) i.v. infusion over 4 hours (in adults) or 2 hours (in children) every 8 hours, until patient can swallow. Switchover to oral quinine 10 mg/kg 8 hourly to complete the 7 day course.

(Volume of fluid for i.v. infusion of quinine should be reduced in patients with volume overload/pulmonary edema).

(If possible, oral quinine should be substituted by 3 day oral ACT, or doxycycline 100 mg daily should be combined with it).

(Chloroquine HCl i.v. to be used only if none of the above is available and only in adults).

* Adopted from Regional guidelines for the management of severe falciparum malaria in large hospitals (2006); WHO, Regional office for South-East Asia, New Delhi.

4. Radical cure Drugs which attack the exoerythrocytic stage (hypnozoites) given together with a clinical curative achieve total eradication of the parasite from the patient's body. A radical curative is needed in relapsing malaria, while in falciparum malaria — adequate treatment of clinical attack leaves no parasite in the body (there is no secondary exoerythrocytic tissue phase).

Drug of choice for radical cure of vivax and ovale malaria is:

- Primaquine 15 mg daily for 14 days. A shorter course of 5 days used earlier by NAMP in India has been found inadequate, and is no longer recommended. This treatment should be given concurrently with or immediately after chloroquine/other schizontocide only to individuals who test negative for G-6-PD deficiency.

There is no point in antirelapse treatment in highly endemic areas, because chances of reinfection would be high; a subsequent attack may be erroneously labelled as failure of radical cure. Antirelapse treatment of vivax malaria should be restricted to:

- (a) Areas with very low level of transmission (where only sporadic cases occur).
- (b) Patients treated during an epidemic along with effective vector control measures to cut down transmission.

5. Gametocidal This refers to elimination of the male and female gametes of *Plasmodia* formed in the patient's blood. Gametocidal action is of no benefit to the patient being treated, but will reduce the transmission to mosquito.

Primaquine and artemisinins are gametocidal to all species of *Plasmodia*, while chloroquine and quinine are active against vivax but not falciparum gametes. Gametes exposed to proguanil

or pyrimethamine fail to carry on the life cycle normally in the mosquito. Adequate control of clinical attacks will reduce formation of gametes.

- A single 45 mg (0.75 mg/kg) dose of primaquine is employed immediately after clinical cure of falciparum malaria to kill the gametes and cut down transmission to mosquito. This is not necessary when an artemisinin is used for clinical cure.

CHLOROQUINE

It is a rapidly acting erythrocytic schizonticide against all species of plasmodia; controls most clinical attacks in 1–2 days with disappearance of parasites from peripheral blood in 1–3 days. Therapeutic plasma concentrations are in the range of 15–30 ng/ml. However, it has no effect on pre- and exo-erythrocytic phases of the parasite—does not prevent relapses in vivax and ovale malaria.

The mechanism of action of chloroquine is not completely known. It is actively concentrated by sensitive intraerythrocytic plasmodia: higher concentration is found in infected RBCs. By accumulating in the acidic vesicles of the parasite and because of its weakly basic nature, it raises the vesicular pH and thereby interferes with degradation of haemoglobin by parasitic lysosomes. Polymerization of toxic haeme to nontoxic parasite pigment hemozoin is inhibited by formation of chloroquine-heme complex. Heme itself or its complex with chloroquine then damages the plasmodial membranes. Clumping of pigment and changes in parasite membranes follow. Other related antimalarials like quinine, mefloquine, lumefantrine appear to act in an analogous manner.

Chloroquine-resistance among *P. vivax* has been slow in developing. However, *P. falciparum* has acquired significant resistance and resistant strains have become prevalent especially in eastern part of India, South East Asia, Africa and South America. Some of these have also acquired resistance to proguanil and S/P (multidrug resistant strains). Because *P. falciparum* produces

the more severe forms of malaria with considerable mortality, emergence of such strains is the biggest threat to the antimalaria programmes, and is the focus of attention for current research efforts.

Chloroquine-resistance among *P. falciparum* is now widespread in India, but is mostly low grade (RI or late clinical failure). Higher grade resistance (RII, RIII or early treatment failure) averaged 8.7% over the period 1978–2002. The largest number of chloroquine-failures are reported from the North eastern part of India where 24–83% *P. falciparum* cases are resistant to chloroquine, and some of these (particularly in areas bordering Myanmar) are multidrug resistant. In 73 districts (mostly North eastern states, Orissa, Karnataka, Gujarat) the NVBDCP has switched over to the 2nd line treatment (sulfa-pyrimethamine ACT), due to high rates of chloroquine resistance.

Resistance in *P. falciparum* is associated with a decreased ability of the parasite to accumulate chloroquine. Verapamil, a Ca²⁺ channel blocker, has been found to restore both the chloroquine concentrating ability as well as sensitivity to this drug.

A chloroquine transporter glycoprotein encoded by the *Pf mdr1* gene appears to play a role in chloroquine-resistance of *P. falciparum* but not that of *P. vivax*. However, other mechanisms of resistance also appear to be involved.

Chloroquine-resistance among *P. vivax* was first reported from Papua New Guinea in 1989. It has now been confirmed from Columbia, Indonesia, Myanmar and detected in India, but is focal and sporadic, reported from Chennai, Mathura, tribal areas of Madhya Pradesh, Mumbai and Bihar. It manifests as recrudescence within 1–3 weeks of treating vivax malaria with standard dose of chloroquine. Such cases can be treated by quinine given along with doxycycline, followed by primaquine to effect radical cure. Mefloquine is the 2nd alternative.

Other actions Chloroquine is active against *Entamoeba histolytica* and *Giardia lamblia* also. It has antiinflammatory, local irritant and local anaesthetic (on injection), weak smooth muscle

relaxant, antihistaminic and antiarrhythmic properties.

Pharmacokinetics Oral absorption of chloroquine is excellent. About 50% gets bound in the plasma. It has high affinity for melanin and nuclear chromatin: gets tightly bound to these tissue constituents and is concentrated in liver, spleen, kidney, lungs (several hundred-fold), skin, leucocytes and some other tissues. Its selective accumulation in retina is responsible for the ocular toxicity seen with prolonged use. Absorption after i.m. injection is also good.

Chloroquine is partly metabolized by liver and slowly excreted in urine. The early plasma $t_{1/2}$ varies from 3–10 days. Because of tight tissue binding, small amounts persist in the body with a terminal $t_{1/2}$ of 1–2 months.

Adverse effects Toxicity of chloroquine is low, but side effects are frequent and unpleasant: nausea, vomiting, anorexia, uncontrollable itching, epigastric pain, uneasiness, difficulty in accommodation and headache. Suppressive doses have been safely given for 3 years.

- Parenteral administration can cause hypotension, cardiac depression, arrhythmias and CNS toxicity including convulsions (more likely in children).
- Prolonged use of high doses (as needed for rheumatoid arthritis, DLE, etc.) may cause loss of vision due to retinal damage. Corneal deposits may also occur and affect vision, but are reversible on discontinuation.
- Loss of hearing, rashes, photoallergy, mental disturbances, myopathy and graying of hair can occur on long-term use.

Chloroquine can be used for treatment of malaria during pregnancy: no abortifacient or teratogenic effects have been reported.

Caution is to be exercised in the presence of liver damage, severe g.i., neurological and haematological diseases. Attacks of seizures, porphyria and psoriasis may be precipitated.

Chloroquine should not be coadministered with mefloquine, amiodarone and other antiarrhythmics.

Preparations and administration

Chloroquine phosphate: (250 mg = 150 mg base) bitter, tablet should not be chewed. **RESOCHIN, CLOQUIN, LARIAGO, NIVAQUIN-P** 250 mg tab, 500 mg forte tab, 100 mg (base) per 10 ml oral susp., 40 mg (base)/ml inj in 2 and 5 ml amp, 30 ml vial.

Parenteral chloroquine (as HCl salt 250 mg = 200 mg base) is used only for severe cases of falciparum malaria and in cerebral malaria with comatose patient as third choice to i.v. quinine/artesunate when the parasite is known or expected to be chloroquine sensitive. Its cardiovascular adverse effects can be prevented by slow i.v. infusion: 10 mg/kg diluted in 5% dextrose and infused over 8 hr, followed by 15 mg/kg infused over 24 hr. Switch over to oral therapy as soon as possible. It can also be given by deep i.m. injection (3 mg/kg 6 hourly). Parenteral chloroquine is contraindicated in children — convulsions and deaths have occurred.

Uses

1. Chloroquine is the drug of choice for clinical cure and suppressive prophylaxis of all types of malaria, except that caused by resistant *P. falciparum*. Uncomplicated cases are treated orally, while i.v. chloroquine is rarely employed for complicated/cerebral malaria in adults. It completely cures sensitive falciparum disease, but relapses in vivax and ovale malaria are not prevented. In short time visitors to chloroquine-sensitive endemic areas, suppressive doses should be started 1 week before and continued for 4 weeks after returning.
2. Extraintestinal amoebiasis (Ch. 60).
3. Rheumatoid arthritis (Ch. 15).
4. Discoid lupus erythematosus—very effective; less valuable in systemic LE.
5. Lepra reactions (Ch. 56).
6. Photogenic reactions.
7. Infectious mononucleosis: affords symptomatic relief.

Amodiaquine It is almost identical to chloroquine in properties and is less bitter.

Studies over the past 20 years in Africa have found it to be somewhat faster acting than chloroquine.

In the mid 1980s some fatal cases of toxic hepatitis and agranulocytosis were reported among travellers using

amodiaquine for prophylaxis, and WHO in 1990 recommended that it should not be used for prophylaxis of malaria as well as for treatment of chloroquine failures. The 19th WHO expert committee on malaria (1992) did not accept this recommendation totally, and permitted use of amodiaquine for treatment of clinical attacks. Countries which had continued to use amodiaquine did not report any severe reaction.

Experience in Africa over the past 2 decades supports continued use of amodiaquine in uncomplicated falciparum malaria, but it is still not recommended for prophylaxis. There is evidence now that amodiaquine may be effective even in areas with chloroquine-resistant *P. falciparum*. In combination with artesunate, it is being tried as ACT for chloroquine-resistant falciparum malaria. Side effects of amodiaquine are similar to chloroquine; itching may be less common, but neutropenia has been associated with it in children.

Dose: for treatment of acute attack of malaria: 25–35 mg/kg over 3 days; CAMOQUIN 200 mg (as HCl = 150 mg base) tab; BASOQUIN 150 mg (base) per 5 ml susp.

Piperaquine (see under ACT)

MEFLOQUINE

It is a drug developed to deal with the problem of chloroquine-resistant *P. falciparum*, and has emerged from reinvestigation of quinoline methanols that were originally tested during World War II. Mefloquine is a relatively fast-acting erythrocytic schizonticide, slower than chloroquine or quinine; effective against chloroquine-sensitive as well as resistant plasmodia. In field trials, single dose (15 mg/kg, max 1 g) has rapidly controlled fever and eliminated circulating parasites in infections caused by *P. falciparum* or *P. vivax* in partially immune as well as non-immune individuals. However, like chloroquine, relapses occur subsequently in vivax malaria. It is also an efficacious suppressive prophylactic for multiresistant *P. falciparum* and other types of malaria. Mefloquine-resistance among *P. falciparum* has become common in Thailand, Cambodia and Myanmar, but is sporadic in Africa, South America and Middle east. Since it

has not been extensively used in India, mefloquine-resistance is not a problem yet, but due to its long $t_{1/2}$ chances of selection of resistant strains are high; mefloquine-resistant *P. falciparum* isolates have been reported from Gujarat and Andhra Pradesh. Resistance to mefloquine confers cross resistance to quinine and halofantrine.

The mechanism of action of mefloquine is not known, but the morphological changes produced in the intraerythrocytic parasite resemble quinine. It is actively taken up even by chloroquine-resistant *P. falciparum* and, like chloroquine raises intravesicular pH. It appears to bind to haeme and the complex damages membranes of the parasite. Resistant organisms accumulate less mefloquine.

Pharmacokinetics Oral absorption of mefloquine is good but quite slow. It is highly plasma protein bound and concentrated in many organs including liver, lung and intestines. Extensive metabolism occurs in liver and it is primarily secreted in bile. Considerable enterohepatic circulation of mefloquine and its tissue binding accounts for the long $t_{1/2}$ which is 2–3 weeks.

Adverse effects Mefloquine is bitter in taste; common reaction is dizziness, nausea, vomiting, diarrhoea, abdominal pain and sinus bradycardia. These are usually mild and largely dose related, but may be severe in some. Major concern has been a variety of neuropsychiatric reactions (disturbed sense of balance, ataxia, errors in operating machinery, strange dreams, anxiety, hallucinations, rarely convulsions) occurring in some recipients. These are dose related and subside in 1–3 weeks. Rare events are haematological, hepatic and cutaneous toxicity. Mefloquine appears to be safe during pregnancy, but should be avoided in 1st trimester unless absolutely essential.

Interactions Halofantrine or quinidine/quinine given to patients who have received mefloquine cause QTc lengthening—cardiac arrests are reported. Exaggerated bradycardia or arrhyth-

mias were apprehended when mefloquine is given to patients on β blockers, Ca^{2+} channel blockers, digitalis and antidepressants, but no such reactions have occurred and comedication with these drugs is no longer contraindicated (WHO 1996).

Use Mefloquine is an effective drug for multi-resistant *P. falciparum*. Because of its potential toxicity, cost and long $t_{1/2}$, its use is being restricted to areas where such strains are prevalent. To check the spread of mefloquine-resistance, current recommendation is to use it only along with the rapidly acting drug artesunate, as ACT for uncomplicated chloroquine as well as S/P resistant falciparum malaria. For vivax malaria, it should be used only in the rare case of the parasite being both chloroquine and quinine + doxycycline resistant. Mefloquine cannot be given parenterally and is not used in complicated/cerebral malaria.

For prophylaxis of malaria among travellers to areas with multidrug resistance; 5 mg/kg (adults 250 mg) per week is started preferably 2–3 weeks before travel to assess side effects in the individual. Not recommended for prophylaxis in residents of the endemic area.

MEFLOTAS, MEFLIAM, CONFAL, FACITAL 250 mg tab; to be taken with plenty of water after meals.

Mepacrine (Quinacrine, Atabrine) It is an acridine derivative erythrocytic schizonticide, more toxic and less effective than chloroquine. It is obsolete as an antimalarial, but is also active against giardia and tapeworms.

QUININE

Quinine is the levo rotatory alkaloid obtained from cinchona bark. Its *d*-isomer quinidine is used as an antiarrhythmic (and for malaria in some countries).

Quinine is an erythrocytic schizonticide for all species of plasmodia; less effective and more toxic than chloroquine. Resurgence of interest in quinine is due to the fact that most chloroquine and multidrug-resistant strains of *P. falciparum* still respond to it. However, even quinine-resistance has been described in certain parts of

Southeast Asia and Brazil where quinine + tetracycline has been the standard treatment of complicated malaria. Quinine-resistance has been encountered sporadically in India, particularly along Myanmar border where in a sample study 6% falciparum malaria cases did not respond sequentially to chloroquine, S/P and quinine. There is partial cross resistance between quinine and mefloquine, but many mefloquine-resistant cases respond to quinine. Though effective in terminating an acute attack of falciparum malaria, it may not prevent recrudescence — indicating incomplete clearance of the parasites.

Quinine has no effect on preerythrocytic stage and on hypnozoites of relapsing malaria, but kills vivax gametes. Like chloroquine, it is a weak base: gets concentrated in the acidic vacuoles of the blood schizonts and causes pigment changes; inhibits polymerization of haeme to hemozoin; free haeme or haeme-quinine complex damages parasite membranes and kills it. However, the exact mechanism of action is not known.

Quinine has many other actions:

1. **Local irritant and anaesthetic** Quinine is intensely bitter and irritant. Orally it causes nausea, vomiting, epigastric discomfort. Injections can cause pain and local necrosis in the muscle and thrombosis in the vein. Local inflammation may be followed by fibrosis.
2. **Systemic actions** Gastric secretion is increased. Quinine is a weak analgesic and antipyretic; affects hearing and vision at higher doses. Cardiodepressant, antiarrhythmic and hypotensive actions are similar to quinidine (see Ch. 38). Rapid i.v. injection can produce marked fall in BP and cardiovascular collapse.

Quinine directly decreases contractile power of the muscle fibre. It stimulates the myometrium and can cause abortion in early pregnancy. However, it is not a dependable abortifacient. Blood sugar is slightly lowered due to release of insulin from the pancreas. Rapid i.v. injection of quinine has caused hypoglycaemia.

Pharmacokinetics Quinine is rapidly and completely absorbed orally. It is 70% bound to plasma proteins, especially α_1 acid glycoprotein. Such binding increases during acute malarial infection. CSF concentrations are low. A large fraction of the dose is metabolized in the liver by

CYP3A4 and excreted in urine with a $t_{1/2}$ of 10–12 hours. Quinine is noncumulative.

Adverse effects Toxicity of quinine is high and dose related; 8–10 g taken in a single dose may be fatal.

Cinchonism A large single dose or higher therapeutic doses taken for a few days produce a syndrome called cinchonism. It consists of ringing in ears, nausea, vomiting (due to both gastric irritation and CTZ stimulation), headache, mental confusion, vertigo, difficulty in hearing and visual defects (due to direct neurotoxicity as well as constriction of retinal and auditory vessels). Diarrhoea, flushing and marked perspiration may also appear. The syndrome subsides completely if the drug is stopped.

Poisoning with still higher doses results in the above symptoms in an exaggerated form. In addition, delirium, fever, tachypnoea followed by respiratory depression, marked weakness and prostration can occur. Hypotension, cardiac arrhythmias develop only on rapid i.v. injection — the patient may die.

Few individuals are idiosyncratic/hypersensitive to quinine; cinchonism may appear after a single therapeutic dose. Purpura, rashes, itching, angioedema of face and bronchoconstriction may also develop.

Quinine occasionally causes haemolysis, especially in pregnant women and in patients of falciparum malaria, resulting in haemoglobinuria (black water fever) and kidney damage.

During pregnancy it should be used only for life-threatening infection, with special care to prevent hypoglycaemia.

Uses

1. **Malaria** Quinine is used orally for uncomplicated chloroquine-resistant malaria, and i.v. for complicated/cerebral malaria (chloroquine-sensitive or resistant).

(a) *Uncomplicated resistant falciparum malaria:* Quinine may be used orally as an alternative to

S/P-ACT in uncomplicated chloroquine-resistant falciparum malaria. It acts more rapidly than S/P alone. The 7 day quinine + doxycycline regimen is the 2nd line treatment of chloroquine-resistant malaria (both falciparum and vivax) under NVBDCP. Certain chloroquine-resistant strains are also resistant to S/P, but respond to quinine.

(b) *Complicated and severe malaria including cerebral malaria:* Quinine (i.v.) has been used as the drug of choice for cerebral malaria (falciparum malaria with impaired consciousness) and other forms of complicated malaria. However, some recent studies indicate that parenteral artemisinins are faster acting, more effective, better tolerated and more conveniently administered. Many experts now prefer i.v./i.m. artesunate/artemether/artether over quinine for severe malaria. The dosage and schedule for i.v. infusion of quinine for severe malaria is given in the box on p. 784. Hypoglycaemia due to hyperinsulinemia is the most important side effect: can be prevented by 5% dextrose infusion.

Supportive treatment — cooling for fever, i.v. diazepam for convulsions, correction of fluid and electrolyte balance and acidosis is of vital importance. Corticosteroids have been used but are of no benefit; may be harmful — avoid them.

2. Nocturnal muscle cramps: a single tablet of quinine (300 mg) at bed time affords benefit in some but not all cases. It is also effective in myotonia congenita.

3. Diagnosis of myasthenia gravis: a single dose of quinine precipitates weakness in myasthenia gravis. However, this provocative test is dangerous — not recommended.

4. Varicose veins: injected along with urethane, it causes thrombosis and fibrosis of the varicose vein mass.

REZ-Q, Q-SET, QUINARSOL 100, 300, 600 mg tab, 600 mg/2 ml inj.

BIGUANIDES

Proguanil (Chloroguanide)

It is a slow-acting erythrocytic schizontocide which also inhibits the preerythrocytic stage of *P. falciparum*. Gametocytes exposed to proguanil

are not killed but fail to develop properly in the mosquito. It is cyclized in the body to a triazine derivative (cycloguanil) which inhibits plasmodial DHFRase in preference to the mammalian enzyme. Resistance to proguanil develops rapidly due to mutational changes in the plasmodial DHFRase enzyme.

Proguanil is slowly but adequately absorbed from the gut; is partly metabolized and excreted in urine; $t_{1/2}$ is 16–20 hr; noncumulative. It is very well tolerated; side effects are less compared to chloroquine; mild abdominal upset, vomiting, occasional stomatitis, haematuria, rashes and transient loss of hair are reported.

In the late 1940s and early 1950s it was extensively used as a clinical curative for vivax malaria. Such use is discouraged by its slow response (cannot be depended upon in the nonimmune subject), and chances of rapid resistance. Current use of proguanil is restricted to prophylaxis of malaria in combination with chloroquine in areas of low level chloroquine-resistance among *P. falciparum*. It can be employed during pregnancy.

Dose for malaria prophylaxis: 200 mg daily with chloroquine 300 mg weekly till 4 weeks after exposure; **LAVERAN, PROGUNAL 100 mg tab.**

Because it potentiates atovaquone, a combination of the two has been used in Thailand and some other countries for treatment of multidrug-resistant falciparum malaria.

Chlorproguanil It is proguanil with an additional chlorine substitution, but with similar properties. Combined with dapsone, it has been used for prophylaxis and treatment of chloroquine-resistant malaria. Along with artesunate, the combination is being evaluated as ACT.

PYRIMETHAMINE

It is a directly acting inhibitor of plasmodial DHFRase (does not require conversion to a cyclic triazine, as is the case with proguanil). Selective antimalarial action depends on high affinity for plasmodial enzyme (~2000 times greater than for the mammalian enzyme). In contrast to trimethoprim, it has very poor action on bacterial DHFRase. Under the influence of pyrimethamine, schizogony of malarial parasite in blood gradually stops. At high doses, it inhibits *Toxoplasma gondii*.

Pyrimethamine is more potent. It is a slowly acting erythrocytic schizontocide, but does not eliminate the preerythrocytic phase of *P. falciparum*. It is not a radical curative, but by extended treatment, the secondary tissue phase of *P. vivax* may be exhausted. If used alone, resistance develops rather rapidly by mutation in the DHFRase enzyme of the parasite. These organisms exhibit cross resistance to proguanil.

Pharmacokinetics Absorption of pyrimethamine from g.i.t. is good but slow. Certain organs like liver, spleen, kidney and lungs concentrate pyrimethamine. It is metabolized and excreted in urine with a $t_{1/2}$ of 4 days. Prophylactic concentrations remain in blood for 2 weeks.

Adverse effects Pyrimethamine is relatively safe. The only side effects are occasional nausea and rashes. Folate deficiency is rare; megaloblastic anaemia and granulocytopenia may occur with higher doses, especially in those with marginal folate stores. This can be treated by folic acid.

Use Pyrimethamine is used only in combination with a sulfonamide (S/P) or dapsone (see below) for treatment of falciparum malaria.

SULFONAMIDE-PYRIMETHAMINE (S/P) COMBINATION

Sulfonamides/dapsone are not particularly effective antimalarial drugs in their own right; have some inhibitory influence on the erythrocytic phase, especially of *P. falciparum*. However, they form supra-additive synergistic combination with pyrimethamine due to sequential block (as in case of cotrimoxazole: p. 685). Though, both components are slow acting, the combination acts faster, so that it can be employed as a clinical curative, particularly for *P. falciparum*. Efficacy against *P. vivax* is rather low. By the addition of sulfonamide, development of resistance to pyrimethamine is retarded. There is no cross-resistance with other groups of antimalarial drugs. The popular combinations are:

Sulfadoxine 500 mg + pyrimethamine 25 mg tab: RIMODAR, FANCIDAR, LARIDOX, MALOCIDE; REZIZ 500 mg + 25 mg tab and per 10 ml susp; REZIZ FORTE 750 mg + 37.5 mg tab.

Sulfamethopyrazine 500 mg + pyrimethamine 25 mg tab: METAFIN, MALADEX.

Dapsone 100 mg + pyrimethamine 25 mg tab; MALOPRIM.

As clinical curative: Sulfadoxine 1500 mg + pyrimethamine 75 mg (3 tab) single dose (children 9–14 yr 2 tab, 4–8 yr 1 tab, 1–4 yr ½ tab).

Sulfadoxine and sulfamethopyrazine are ultra-long acting sulfonamides — attain low blood concentrations, but are able to synergise with pyrimethamine which also has long $t_{1/2}$. The combination has the potential to cause serious adverse effects (exfoliative dermatitis, Stevens-Johnson syndrome, etc.) due to the sulfonamide. Therefore, use is restricted to single dose treatment of uncomplicated chloroquine-resistant falciparum malaria, or in patients intolerant to chloroquine. Prophylactic use, needing multiple unsupervised doses is not approved. It is contraindicated in infants and in individuals allergic to sulfonamide. There is no evidence that single dose of the combination used for treating malaria harms the foetus during pregnancy, but should be avoided if possible.

The major importance of this combination is due to its efficacy against chloroquine-resistant *P. falciparum*. Compliance is good due to single dose therapy and few acute side effects. Resistance to S/P among *P. falciparum* was first noted in 1980, and has spread globally now. It is high in South East Asia, South America and Southern Africa, so much as to preclude its clinical use. In India, S/P resistance has not been systematically measured, but appears to be sporadic, except in the North east. A sample study from Aasam found 9% chloroquine-resistant *P. falciparum* cases to be nonresponsive to S/P as well, while in the area bordering Myanmar 35–44% S/P failures have been recorded. To contain further spread of S/P resistance, the National drug policy on malaria mandates compulsory use of artesunate along with S/P for treatment of chloroquine-resistant

falciparum malaria. It is not an effective drug for vivax malaria.

S/P is the first choice treatment for toxoplasmosis, which mainly occurs in immunocompromised patients.

PRIMAQUINE

In contrast to other antimalarial drugs, primaquine is a poor erythrocytic schizonticide: has weak action on *P. vivax*, but blood forms of *P. falciparum* are totally insensitive. On the other hand, it is more active against the preerythrocytic stage of *P. falciparum* than that of *P. vivax*. Primaquine differs from all other available antimalarials in having a marked effect on primary as well as secondary tissue phases of the malarial parasite. It is highly active against gametocytes and hypnozoites.

The mechanism of action of primaquine is not known. However, it is different from that of chloroquine. Though, resistance among *P. vivax* against primaquine can be induced, it is not a clinical problem.

Pharmacokinetics Primaquine is readily absorbed after oral ingestion. It is oxidized in liver with a plasma $t_{1/2}$ of 3–6 hrs and excreted in urine within 24 hours. It is not a cumulative drug.

Adverse effects The usual doses of primaquine produce only abdominal pain, g.i. upset, weakness or uneasiness in chest as side effect. These can be minimized by taking the drug with meals. CNS and cardiovascular symptoms are infrequent. Leucopenia occurs rarely with larger doses.

The most important toxic potential is dose related haemolysis, methaemoglobinaemia, tachypnoea and cyanosis. These are due to the oxidant property of primaquine. Its metabolites are more potent in this regard. However, in normal individuals doses < 60 mg (base) produce little haemolysis. Those with G-6-PD deficiency are highly sensitive and haemolytic anaemia can occur with 15–30 mg/day. The incidence of

G-6-PD deficiency is low among Indians, except in some tribal people of Jharkhand, Andhra Pradesh, Madhya Pradesh and Assam. It is high among black races and Mediterranean people. Spot tests are available for detecting G-6-PD deficiency. Passage of dark urine is an indication of haemolysis; primaquine should be promptly stopped if it occurs. The risk of haemolysis and leucopenia is increased in patients of rheumatoid arthritis, SLE and in those acutely ill.

Primaquine should be avoided during pregnancy, because foetus is G-6-PD deficient.

Use The primary indication of primaquine is for radical cure of relapsing (vivax) malaria: 15 mg (children 0.25 mg/kg) daily for 2 weeks is given with full curative dose of chloroquine (to cover the erythrocytic phase). Relapse rate with 5 day primaquine treatment employed earlier by NAMP (India) has been found similar to no treatment; therefore not recommended now. The G-6-PD status of the patient should be tested before giving 14 day primaquine course.

An alternative regimen is primaquine 45 mg (0.75 mg/kg) + chloroquine 300 mg once a week for 8–10 weeks. This does not require G-6-PD testing; has been found to effect radical cure without inducing significant haemolysis.

Falciparum malaria: A single 45 mg dose of primaquine is given with the curative dose of chloroquine to kill the gametes and cut down transmission to mosquito. This use is restricted to low transmission areas or where effective vector control is implemented.

PRIMALINE (as phosphate 26 mg = 15 mg base) 7.5, 15 mg tab., **PRIMALEX**, **MALIRID** 7.5, 15 mg tabs.

Primaquine 15 mg/day given with clindamycin 600 mg TDS is an alternative drug for *Pneumocystis jirovecii* pneumonia in AIDS patients.

Bulaquine This congener of primaquine, developed in India, has shown comparable antirelapse activity in vivax malaria when administered for 5 days along with a course of chloroquine. It is partly metabolized in the body to primaquine. Whether the activity is due to bulaquine itself or due to primaquine produced from it is not clear. Bulaquine is claimed to be better tolerated, especially by G-6-PD deficient individuals, but without any convincing evidence. Precautions and contraindications are the same

as for primaquine. Since 5 day antirelapse treatment has been discontinued, the status of bulaquine is uncertain. *Dose*: 25 mg/day for 5 days starting on 2nd day of chloroquine therapy.

AABLAQUINE 25 mg cap + chloroquine tablets.

TETRACYCLINES

These antibiotics have slowly acting and weak erythrocytic schizontocidal action against all plasmodial species. In addition, preerythrocytic stage of *P. falciparum* is inhibited. They are never used alone to treat malaria, but only in combination with quinine or S/P for the treatment of chloroquine-resistant falciparum malaria. Tetracycline 250 mg QID or doxycycline 100 mg OD are equally efficacious. Doxycycline 200 mg/day has also been combined with artesunate to treat mefloquine/chloroquine/S/P-resistant falciparum malaria in Thailand.

Doxycycline 100 mg/day is used as a 2nd line prophylactic for travellers to chloroquine-resistant *P. falciparum* areas.

ARTEMISININ DERIVATIVES

Artemisinin is the active principle of the plant *Artemisia annua* used in Chinese traditional medicine as 'Qinghaosu'. It is a sesquiterpene lactone active against *P. falciparum* resistant to all other antimalarial drugs as well as sensitive strains. Potent and rapid blood schizontocidal action is exerted eliciting quicker defervescence and parasitaemia clearance (<48 hr) than chloroquine or any other drug. In the erythrocytic schizogony cycle of the malarial parasite, artemisinins exert action on a wide range of stages—from ring forms to early schizonts; thus have the broadest time window of antimalarial action.

Artemisinin is poorly soluble in water as well as oil. Several derivatives have been produced, of which three are marketed in India: *Artemether* is soluble in oil, while *Artesunate* (sod.) is water soluble. Another compound *Arteether* has been developed in India. Artemisinins do not kill hypnozoites but have some action on falciparum

gametes. The duration of action is short and recrudescence rate is high when they are used alone in short courses. Recrudescence depends upon the dose and duration of therapy as well as severity of disease. So far no resistance among *P. falciparum* patients to artemisinin has been noted, but can be developed in animal models.

Because artemisinins are short acting drugs, monotherapy needs to be extended beyond the disappearance of the parasites to prevent recrudescence. After 5 days treatment recrudescence rate is ~10%, while with a 3 day course it is ~50%. Recrudescence can be totally prevented by combining 3 day artesunate/artemether with a long-acting drug (see ACT later).

Mechanism of action of artemisinin is not definitely known. The endoperoxide bridge in its molecule appears to interact with haeme in the parasite. Iron-mediated cleavage of the bridge releases a highly reactive free radicals species that binds to membrane proteins, causes lipid peroxidation, damages endoplasmic reticulum, inhibits protein synthesis and ultimately results in lysis of the parasite.

Pharmacokinetics Data on pharmacokinetics of artemisinin derivatives is limited and incomplete. Both artesunate and artemether are prodrugs.

Artesunate Its sodium salt is water-soluble and is administered by oral, i.m. or i.v. routes. After oral ingestion, absorption is incomplete but fast, reaching peak in <60 min. It is rapidly converted to the active metabolite dihydroartemisinin (DHA) with a $t_{1/2}$ of 30–60 min. The $t_{1/2}$ of DHA is 2–4 hours. After repeated dosing, artesunate causes autoinduction of its own metabolite.

FALCIGO, FALCYNATE, ARTINATE 50 mg tab, 60 mg/ vial inj; LARINATE, ARNATE 50 mg tab.

Artemether It is lipid-soluble and is administered orally or i.m., but not i.v. Oral absorption is slower taking 2–4 hours, but is enhanced by food. It undergoes substantial first pass metabolism and is converted to DHA. Extensive metabolism by CYP3A4 yields a variable $t_{1/2}$ of 3–10 hours. **PALUTHER, LARITHER, MALITHER, METHILEX 40 mg cap, 80 mg inj (in 1 ml arachis oil).**

α/β Arteether This compound developed in India has been released for institutional use only, for i.m. administration in complicated/cerebral malaria. Because

of its longer elimination $t_{1/2}$ (23 hours), it is effective in a 3 day schedule with a recrudescence rate of 5%.

Dose: 150 mg i.m. daily for 3 days in adults.

E-MAL, FALCY, RAPITHER 150 mg/2 ml amp (box of 3 amp).

[Note: The recent (2006) WHO Regional guidelines for South East Asia recommend a 5 day course of i.m. arteether (3.2 mg/kg on 1st day, followed by 1.6 mg/kg daily for the next 4 days), see box on p. 784].

Adverse effects Data from >10000 monitored patients shows that artesunate/artemether produce few adverse effects; most are mild: nausea, vomiting, abdominal pain, itching and drug fever. Abnormal bleeding, dark urine, S-T segment changes, Q-T prolongation, first degree A-V block, transient reticulopenia and leucopenia have been noted but subside when the patient improves or drug is stopped. Millions of patients have been treated so far without any serious neurological or other toxicity, but close monitoring of the patient is advocated. Intravenous artesunate is much safer than i.v. quinine.

Interactions Concurrent administration of artemisinin compounds with terfenadine, astemizole, antiarrhythmics, tricyclic antidepressants and phenothiazines may increase the risk of cardiac conduction defects.

Use Oral artemisinins are indicated only for the treatment of uncomplicated chloroquine/multidrug-resistant falciparum malaria. Parenterally they are used in severe and complicated falciparum malaria. There is no justification of using them for uncomplicated chloroquine or S/P sensitive falciparum malaria or for vivax malaria. Because of their short duration of action and availability of better tolerated/cheaper drugs, use of artemisinins for prophylaxis of malaria is irrational, and is not allowed.

Uncomplicated resistant falciparum malaria: Oral artemisinins are almost 100% effective, but recrudescence rates are high. In order to protect their powerful antimalarial activity and to reduce recrudescence rates, current recommendation is to use them only in combination with a longer-

acting drug (see box on p. 783 and ACT below). Their gametocidal action cuts down transmission and spread of resistant *P. falciparum*.

Severe and complicated falciparum malaria: Parenteral artemisinins are highly effective and are indicated irrespective of chloroquine-resistant status. Though i.v. quinine is still advocated as the 1st line drug in complicated/cerebral malaria, i.v. artesunate offers several advantages:

- It causes faster parasite clearance than i.v. quinine.
- It is safer and better tolerated than i.v. quinine.
- Its dosing schedule is simpler.
- Recent evidence indicates higher efficacy and lower mortality.

In a recent randomized trial* on 1461 severe/complicated falciparum malaria patients conducted in India, Indonesia, Myanmar and Bangladesh, mortality in artesunate treated patients was 15% compared to 22% in quinine recipients. Also artesunate produced fewer adverse effects.

AMINO-ALCOHOLS

Halofantrine It is a phenanthrene methanol blood schizonticide having activity comparable to mefloquine with which it exhibits cross resistance. It is effective against *P. falciparum* resistant to chloroquine and S/P, as well as against *P. vivax*. It is not active against gametocytes or hepatic stages of the malarial parasite.

Oral absorption of halofantrine is low and erratic. The plasma $t_{1/2}$ is 1 day, but that of its active metabolite is 3 days. Side effects are abdominal pain, diarrhoea, itching, rashes and occasional elevation of serum transaminase. Prolongation of QTc interval is seen even at therapeutic doses and few cases of serious ventricular arrhythmia (some fatal) are on record.

It is not approved in India, but in other countries it has been used for multiresistant falciparum malaria when no other effective alternative is available.

Lumefantrine (see below under ACT)

Pyronaridine (see below under ACT)

Atovaquone This synthetic naphthaquinone is a rapidly acting erythrocytic schizonticide for *P. falciparum* and other plasmodia. *Pneumocystis jiroveci* and *Toxoplasma gondii* are also susceptible to atovaquone. It collapses plasmodial

mitochondrial membranes and interferes with ATP production. Proguanil potentiates its antimalarial action and prevents emergence of resistance. A fixed dose oral combination of the two drugs is used for 3 day treatment of uncomplicated chloroquine-resistant *P. falciparum* as well as *P. vivax* malaria in the USA and some other countries, but not in India.

Atovaquone is also approved as a second line drug for opportunistic infections with *P. jiroveci* and *T. gondii* in AIDS patients. It produces few side effects—diarrhoea, vomiting, headache, rashes and fever.

Artemisinin-based combination therapy (ACT)

Noting that use of antimalarial drugs singly has failed to curtail the prevalence of malaria globally, particularly due to emergence of chloroquine-resistant followed by multidrug-resistant *P. falciparum*, the WHO has recommended that acute uncomplicated resistant falciparum malaria should be treated only by combining one of the artemisinin compounds with another effective erythrocytic schizonticide. In choosing the companion drug, the most important consideration is its elimination $t_{1/2}$ (governing stay in the body), because effective concentrations in blood must be maintained for at least 3 asexual cycles of the parasite, i.e. 6 days, to exhaust the parasite burden. Therefore, short $t_{1/2}$ drugs have to be given for 7 days, while longer acting drugs can be given for 1–3 days. However, long $t_{1/2}$ drugs allow subinhibitory concentrations to persist in the blood facilitating selection of resistant mutants. Combining a short $t_{1/2}$ drug with a long $t_{1/2}$ drug in the conventional 3 day regimen runs the risk of *de facto* monotherapy after the short $t_{1/2}$ drug is eliminated. This risk is minimized by choosing a short $t_{1/2}$ drug that reduces the parasite load rapidly and drastically. Artemisinin compounds fill in this requirement, as they rapidly kill > 95% plasmodia. They leave only a small biomass of the parasites to be eliminated by the long $t_{1/2}$ drug, reducing the chances of selecting resistant mutants. Advantages of ACT over other antimalarials are:

- Rapid clinical and parasitological cure.
- High cure rates (>95%) and low recrudescence rate.

* Artesunate versus quinine for treatment of severe falciparum malaria: a randomized trial. *Lancet*, 2005; 366: 717-25.

ACT regimens for uncomplicated falciparum malaria*

ACT regimens in use

1. *Artesunate-mefloquine (AS/MQ)*
Artesunate 100 mg BD (4 mg/kg/day) × 3 days + Mefloquine 750 mg (15 mg/kg) on 2nd day and 500 mg (10 mg/kg) on 3rd day (total 25 mg/kg).
2. *Artemether-lumefantrine (1:6)*
Artemether (80 mg BD) + lumefantrine (480 mg BD) × 3 days
COARTEM, LUMERAX (artemether 20 mg + lumefantrine 120 mg tab.) to be taken with fatty meal.
Adult and child >35 kg 4 tab BD; child 25–35 kg 3 tab BD; 15–25 kg 2 tab BD; 5–15 kg 1 tab BD, all for 3 days.
3. *Artesunate-sulfadoxine + pyrimethamine (AS/S/P)*
Artesunate 100 mg BD (4 mg/kg/day) × 3 days + Sulfadoxine 1500 mg (25 mg/kg) and pyrimethamine 75 mg (1.25 mg/kg) single dose.

ACT regimens under development

1. *Dihydroartemisinin (DHA)-piperaquine (1:8) ARTEKIN*
DHA 120 mg (2 mg/kg) + piperaquine 960 mg (16 mg/kg) daily × 3 days
2. *Artesunate-amodiaquine (AS/AQ)*
Artesunate 200 mg (4 mg/kg) + amodiaquine 600 mg (10 mg/kg) per day × 3 days
3. *Artesunate-pyronaridine (1:3)*
Artesunate 100–200 mg (2–4 mg/kg) + pyronaridine 300–600 mg (6–12 mg/kg) per day × 3 days
4. *Arterolane (RBx 11160)-piperaquine*: (dose titration underway).
5. *Artesunate-lapdap (chlorproguanil + dapson)*: dose titration underway

* All drugs are administered orally

- Absence of parasite resistance (the components prevent development of resistance to each other).
- Good tolerability profile.

The ACT regimens for oral treatment of uncomplicated resistant falciparum malaria that are already in use in India, and those being clinically evaluated are given in the box. They are not to be used in severe or complicated malaria, for which parenteral drugs are needed.

1. Artesunate-sulfadoxine + pyrimethamine (AS/S/P) This ACT has been adopted as the first line drug for falciparum malaria in chloroquine-resistant areas under the 'National antimalaria drug policy' of India, and has replaced chloroquine in 73 districts. However, this does not imply that it is the most effective/best ACT, because it is not effective against multidrug-resistant strains which are nonresponsive to

S/P. Moreover, no comparative evaluation of this regimen against AS/MQ or artemether/lumefantrine, etc. has been done to establish the relative efficacy/tolerability.

2. Artesunate-mefloquine (AS/MQ) It has been extensively used in Thailand, Myanmar and several other countries; found to be highly effective, well tolerated and is now the first line treatment for uncomplicated falciparum malaria in Southeast Asia. Many areas in the far East already have mefloquine-resistant *P. falciparum*. By combining with artesunate, further spread of mefloquine-resistance has been prevented.

3. Artemether-lumefantrine Lumefantrine is an orally active, high efficacy, long-acting erythrocytic schizonticide, related chemically and in mechanism of action to halofantrine and mefloquine. It acts in the food vacuole of plasmodia to inhibit haeme polymerization.

Additionally, nucleic acid and protein synthesis of the parasite is affected. Like the others, vivax hypnozoites are not affected. Lumefantrine is highly lipophilic; absorption starts after 2 hours of ingestion and peaks at 6–8 hours; action is slower than chloroquine. Plasma protein binding is 99%, and it is metabolized predominantly by CYP3A4. It inhibits the isoenzyme CYP2D6. Terminal $t_{1/2}$ is 2–3 days, which is prolonged to 4–6 days in malaria patients.

Lumefantrine has been used only in combination with artemether, and is the only ACT currently available as fixed dose combination tablets. The two components protect each other from plasmodial resistance. As such, no clinically relevant resistance has developed so far. Clinical efficacy is high (>95% cure rate) and comparable to artesunate-mefloquine. It is active even in multidrug-resistant areas, including mefloquine-resistant. While artemether quickly reduces parasite biomass and resolves symptoms, lumefantrine prevents recrudescence. Gametocytes are rapidly killed, cutting down transmission.

Lumefantrine-artemether is administered with food, preferably fatty food or milk, which markedly enhances lumefantrine (and to some extent artemether) absorption. It is generally well tolerated; side effects are—headache, dizziness, sleep disturbances, abdominal pain, arthralgia, pruritus and rash. Some studies indicate that it is better tolerated than artesunate-mefloquine. Lumefantrine-artemether should not be given with drugs metabolized by CYP2D6 (metoprolol, neuroleptics, tricyclic antidepressants, etc), or with drugs which prolong QTc interval. It is contraindicated in first trimester of pregnancy and during breastfeeding.

4. Dihydroartemisinin (DHA)-piperazine Piperazine is a bisquinoline congener of chloroquine developed in China as a high efficacy long-acting ($t_{1/2}$ 2–3 weeks) erythrocytic schizonticide with a slower onset of action. The mechanism of action is similar to chloroquine, and it is equally active against sensitive, but more active against chloroquine resistant *P. falciparum*. In 1978, piperazine replaced chloroquine in China, where it has been extensively used for mass prophylaxis as well as treatment of malaria.

Piperazine has been combined with DHA in a dose ratio of 8:1 (ARTEKIN) and extensively evaluated in multidrug resistant areas of Cambodia, Thailand, Vietnam, etc. with high success rate. In clinical trials, efficacy of DHA-piperazine fixed dose combination has been found comparable to artemether-lumefantrine or artesunate-mefloquine. Safety profile of DHA-piperazine is good and it is well tolerated even by children. However, dizziness, vomiting and other g.i. symptoms are common; rashes are rare. It is undergoing clinical trials in India.

5. Artesunate-pyronaridine Pyronaridine is a water-soluble Mannich base erythrocytic schizonticide with high efficacy and mechanism of action similar to chloroquine, that has been used in China for > 30 years. It is active against both chloroquine-sensitive and resistant *P. falciparum* and other malarial species. The onset of action is slower and duration long. It is concentrated in RBCs and metabolized with a terminal $t_{1/2}$ of 7 days. Weak analgesic, antipyretic actions are produced at higher doses.

Clinical efficacy of artesunate-pyronaridine fixed dose combination (dose ratio 1:3) has been tested in falciparum malaria in China and Africa with >95% success and no recrudescence in 28 days. Multidrug-resistant *P. falciparum* and *P. vivax* also respond. Phase II clinical trials have been completed in India. Artesunate-pyronaridine is well tolerated. Side effects noted are abdominal pain, vomiting, headache, dizziness, loss of appetite, palpitation and transient ECG changes, but no serious reactions have occurred.

6. Artesunate-amodiaquine (AS/AQ) Though the extent of cross resistance between chloroquine and amodiaquine is uncertain, several trials in Africa have found amodiaquine to cure 41–79% *P. falciparum* infections in chloroquine resistant areas. Addition of artesunate improved the cure rate to 68–85%. Administered as separate tablets, the two drugs have been effectively used to treat resistant falciparum malaria in Africa. A fixed-dose combination of the two has been produced and is being tested for efficacy and tolerability in Africa, Southeast Asia and India. Early results are encouraging, and it is likely to emerge as a low cost ACT.

7. Arterolane (RBx 11160)-piperazine Arterolane is an orally active synthetic trioxolane congener of artemisinin with rapid and potent erythrocytic schizontocidal action on plasmodia, including multidrug-resistant *P. falciparum*. Like artemisinins, it is short-acting ($t_{1/2}$ 2–4 hours) and has shown efficacy in treating falciparum malaria. Trials are being conducted in India and it is likely to be combined with piperazine to yield a low cost and well tolerated ACT.

8. Artesunate-chlorproguanil-dapsone Since chlorproguanil-dapsone combination (Lap-dap) is already in use for treatment of malaria in several countries, a fixed dose combination by addition of artesunate is being clinically tried as an alternative low cost ACT.

CHAPTER 60

Antiamoebic and Other Antiprotozoal Drugs

ANTIAMOEBIIC DRUGS

These are drugs useful in infection caused by the protozoa *Entamoeba histolytica*.

Amoebiasis has a worldwide distribution (over 40 million people are infected), but it is endemic in most parts of India and other developing countries. Poor environmental sanitation and low socio-economic status are important factors in the spread of the disease,

which occurs by faecal contamination of food and water. Amoebic cysts reaching the intestine transform into trophozoites which either live on the surface of colonic mucosa as commensals—form cysts that pass into the stools (luminal cycle) and serve to propagate the disease, or invade the mucosa—form amoebic ulcers (Fig. 60.1) and cause acute dysentery (with blood and mucus in stools) or chronic intestinal amoebiasis (with vague abdominal symptoms, amoeboma).

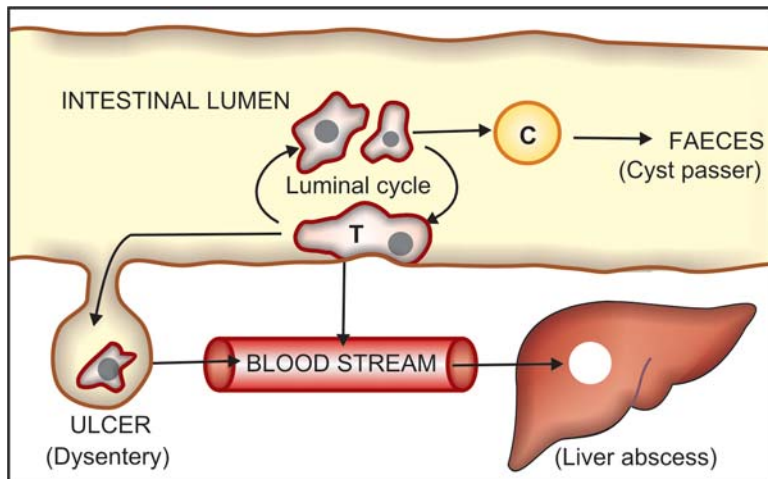

Fig. 60.1: The luminal cycle and invasive forms of amoebiasis. T—trophozoite; C—cyst

Occasionally the trophozoites pass into the blood stream, reach the liver *via* portal vein and cause amoebic liver abscess. Other organs like lung, spleen, kidney and brain are rarely involved in extraintestinal amoebiasis. In the tissues, only trophozoites are present; cyst formation does not occur. Tissue phase is always secondary to intestinal amoebiasis, which may be asymptomatic. In fact, most chronic cyst passers are asymptomatic. In the colonic lumen, the *Entamoebae* live in symbiotic relationship with bacteria, and a reduction in colonic bacteria reduces the amoebic population.

The 'Brazil root' or *Cephaelis ipecacuanha* was used for the treatment of dysentery in the 17th century. The pure alkaloid emetine obtained from it was found to be a potent antiamoebic in 1912 and remained the most efficacious and commonly used drug till 1960. Many 8-hydroxyquinolines (quiniodochlor, etc.) became very popular drugs for diarrhoeas and amoebic dysentery, but have come under a cloud since they were held responsible for causing epidemics of SMON in Japan in 1970. Soon after its triumph as an antimalarial in 1948, chloroquine was found to be an effective and safe drug for hepatic amoebiasis. Diloxanide furoate was a useful addition in 1960, covering mainly chronic intestinal form of the disease. However, the most remarkable development was the demonstration of antiamoebic property of metronidazole in the early 1960s. This drug had been introduced a few years back as a well tolerated, orally effective agent for trichomonas vaginitis. Of the many congeners of metronidazole that were tested, tinidazole has emerged in the 1970s as a good alternative, and others have been added subsequently.

CLASSIFICATION

1. Tissue amoebicides

- (a) For both intestinal and extraintestinal amoebiasis:

Nitroimidazoles: Metronidazole, Tinidazole, Secnidazole, Ornidazole, Satranidazole

Alkaloids: Emetine, Dehydroemetine

- (b) For extraintestinal amoebiasis only:
Chloroquine

2. Luminal amoebicides

- (a) *Amide*: Diloxanide furoate, Nitazoxanide

- (b) *8-Hydroxyquinolines*: Quiniodochlor (Iodochlorohydroxyquin, Clioquinol), Diiodohydroxyquin (Iodoquinol)

- (c) *Antibiotics*: Tetracyclines

METRONIDAZOLE

It is the prototype nitroimidazole introduced in 1959 for trichomoniasis and later found to be a highly active amoebicide. It has broad-spectrum cidal activity against protozoa, including *Giardia lamblia* in addition to the above two. Many anaerobic bacteria, such as *Bact. fragilis*, *Fusobacterium*, *Clostridium perfringens*, *Cl. difficile*, *Helicobacter pylori*, *Campylobacter*, peptococci, spirochetes and anaerobic *Streptococci* are sensitive. Though, it does not directly inhibit the helminth *Dracunculus medinensis*, extraction of the worm from under the skin is facilitated. Metronidazole does not affect aerobic bacteria. Clinically significant resistance has not developed among *E. histolytica*, but decreased responsiveness of *T. vaginalis* has been observed in some areas. Anaerobic bacteria and *G. lamblia* also can develop metronidazole resistance, but this is a clinical problem only in the case of *H. pylori*.

Metronidazole is selectively toxic to anaerobic microorganisms. After entering the cell by diffusion its nitro group is reduced by certain redox proteins operative only in anaerobic microbes to highly reactive nitro radical which exerts cytotoxicity. The nitro radical of metronidazole acts as an electron sink which competes with the biological electron acceptors of the anaerobic organism for the electrons generated by the pyruvate: ferredoxin oxidoreductase (PFOR) enzyme pathway of pyruvate oxidation. The energy metabolism of anaerobes is, thus, disrupted. Aerobic environment attenuates cytotoxicity of metronidazole by inhibiting its reductive activation. Anaerobes which develop metronidazole resistance become deficient in the mechanism that generates the reactive nitro radical from it.

Metronidazole has been found to inhibit cell mediated immunity, to induce mutagenesis and to cause radiosensitization.

Pharmacokinetics Metronidazole is almost completely absorbed from the small intestines; little unabsorbed drug reaches the colon. It is

widely distributed in the body, attaining therapeutic concentration in vaginal secretion, semen, saliva and CSF. It is metabolized in liver primarily by oxidation and glucuronide conjugation, and excreted in urine. Plasma $t_{1/2}$ is 8 hrs.

Adverse effects Side effects to metronidazole are relatively frequent and unpleasant, but mostly nonserious.

- Anorexia, nausea, metallic taste and abdominal cramps are the most common. Looseness of stool is occasional.
- Less frequent side effects are—headache, glossitis, dryness of mouth, dizziness, rashes and transient neutropenia.
- Prolonged administration may cause peripheral neuropathy and CNS effects. Seizures have followed very high doses.
- Thrombophlebitis of the injected vein occurs if the solution is not well diluted.

Contraindications Metronidazole is contraindicated in neurological disease, blood dyscrasias, first trimester of pregnancy (though no teratogenic effect has yet been demonstrated, its mutagenic potential warrants caution), and chronic alcoholism.

Interactions A disulfiram-like intolerance to alcohol occurs in some patients taking metronidazole; they should be instructed to avoid drinking. Enzyme inducers (phenobarbitone, rifampin) may reduce its therapeutic effect.

Cimetidine can reduce metronidazole metabolism: its dose may need to be decreased.

Metronidazole enhances warfarin action by inhibiting its metabolism. It can decrease renal elimination of lithium.

Preparations

FLAGYL, METROGYL, METRON, ARISTOXYL ALDEZOLE 200, 400 mg tab, 200 mg/5 ml susp. (as benzoyl metronidazole: tasteless); 500 mg/100 ml i.v. infusion; UNIMEZOL 200, 400 mg tabs, 200 mg/5 ml susp.

Uses

1. Amoebiasis: Metronidazole is a first line drug for all forms of amoebic infection. Many dosage

regimens have been tried; the current recommendations are:

For invasive dysentery and liver abscess—800 mg TDS (children 30–50 mg/kg/day) for 7–10 days. In serious cases of liver abscess 1 g may be infused i.v. slowly followed by 0.5 g every 8–12 hr till oral therapy is instituted.

For mild intestinal disease—400 mg TDS for 5–7 days. Metronidazole is less effective than many luminal amoebicides in eradicating amoebic cysts from the colon, because it is nearly completely absorbed from the upper bowel.

2. Giardiasis It is highly effective in a dose of 400 mg TDS for 7 days. A shorter course of 3 days with 2 g/day is equally effective.

3. Trichomonas vaginitis It is the drug of choice; 400 mg TDS for 7 days achieves nearly 100% cure. Additional intravaginal treatment has been given, but is not necessary except in refractory cases. The male partner should be treated concurrently in cases of recurrent infections.

Nonspecific bacterial vaginosis also responds.

4. Anaerobic bacterial infections They occur mostly after colorectal or pelvic surgery, appendectomy, etc. Brain abscesses and endocarditis may be caused by anaerobic organisms.

Metronidazole is an effective drug for these and is generally used in combination with gentamicin or cephalosporins (many are mixed infections). For serious cases i.v. administration is recommended: 15 mg/kg infused over 1 hr followed by 7.5 mg/kg every 6 hrs till oral therapy can be instituted with 400–800 mg TDS. Prophylactic use in high risk situations (colorectal surgery) is recommended.

Other drugs effective in anaerobic infections are clindamycin and chloramphenicol.

5. Pseudomembranous enterocolitis due to *Cl. difficile* is generally associated with use of antibiotics. Oral metronidazole 800 mg TDS is more effective, more convenient, less toxic, and therefore preferred over vancomycin.

6. **Ulcerative gingivitis, trench mouth** 200–400 mg TDS (15–30 mg/kg/day) is quite effective because anaerobes are involved. Metronidazole/tinidazole are the drugs of choice for acute necrotizing ulcerative gingivitis, in which they are often combined with amoxicillin, tetracycline or erythromycin. The response is rapid with disappearance of the spirochete-fusobacterium complex from the lesions and resolution of pain, bleeding, ulceration and bad breath within 2–3 days; but treatment must be continued for at least 5 days.

7. **Helicobacter pylori gastritis/peptic ulcer** (see p. 637) Metronidazole or tinidazole alone are relatively ineffective in eradicating *H. pylori*; resistance develops. However, metronidazole 400 mg TDS or tinidazole 500 mg BD is frequently used along with amoxicillin/clarithromycin and a proton pump inhibitor in triple drug 2 week regimens.

8. **Guinea worm infestation** Niridazole is considered to be the drug of choice, but because it is not available in India, metronidazole is used. A 7 day course with 200–400 mg TDS produces symptomatic relief. The local reaction to the worm may be suppressed by its antiinflammatory action, and extraction is facilitated.

Tinidazole It is an equally efficacious congener of metronidazole, similar to it in every way except:

- Metabolism is slower; $t_{1/2}$ is ~12 hr; duration of action is longer; dosage schedules are simpler. Thus, it is more suited for single dose or once daily therapy.

- Some comparative trials in amoebiasis have reported higher cure rates.
- It appears to be better tolerated; the incidence of side effects is lower: metallic taste (2%), nausea (1%), rash (0.2%).

TINIBA 300, 500, 1000 mg tabs; 800 mg/400 ml i.v. infusion; TRIDAZOLE 300, 500 mg tab; FASIGYN 0.5 g and 1 g tab.

Recommended schedules are—

Amoebiasis: 2 g OD for 3 days (children 30–50 mg/kg/day) or 0.6 g BD for 5–10 days.

Trichomoniasis and giardiasis: 2 g single dose or 0.6 g OD for 7 days.

Anaerobic infections:

- prophylactic—2 g single dose before colorectal surgery;
- therapeutic—2 g followed by 0.5 g BD for 5 days.

H. pylori: 500 mg BD for 2 weeks in triple combination.

Secnidazole A congener of metronidazole with the same spectrum of activity and potency. Absorption after oral administration is rapid and complete, but metabolism is slower resulting in a plasma $t_{1/2}$ of 17–29 hours. After 48 hr of a single 2 g dose, plasma secnidazole concentration still remains within the range of MIC values against sensitive organisms. A single 2 g dose has been found to yield cure rates equal to multiple doses of metronidazole and tinidazole. Side effect profile is similar to metronidazole and reported incidence is 2–10%.

Dose: 2 g single dose (children 30 mg/kg) for intestinal amoebiasis, giardiasis, trichomonas vaginitis and nonspecific bacterial vaginosis; 1.5 g/day for 5 days in hepatic amoebiasis.

SECNIL, SEZOL 0.5, 1.0 g tabs; NOAMEBA-DS 1.0 g tab.

Ornidazole Activity similar to metronidazole, but it is slowly metabolized—has longer $t_{1/2}$ (12–14 hr). Dose and duration of regimens for amoebiasis, giardiasis, trichomoniasis, anaerobic infections and bacterial vaginosis resemble those for tinidazole. Side effect profile is also similar.

DAZOLIC 500 mg tab, 500 mg/100 ml vial for i.v. infusion.

ORNIDA 500 mg tab, 125 mg/5 ml susp.

Satranidazole Another nitroimidazole having longer $t_{1/2}$ (14 hr). Advantages claimed are: better tolerability—no nausea, vomiting or metallic taste, absence of neurological and disulfiram-like reactions and that it does not produce the acetamide metabolite which is a weak carcinogen.

Dose: Amoebiasis 300 mg BD for 3–5 days, giardiasis and trichomoniasis 600 mg single dose.

SATROGYL 300 mg tab.

EMETINE

It is an alkaloid from *Cephaelis ipecacuanha*. Emetine is a potent and directly acting amoebicide—kills trophozoites

but has no effect on cysts. It acts by inhibiting protein synthesis in amoebae by arresting intraribosomal translocation of tRNA-amino acid complex.

The stool in acute dysentery is rapidly cleared of the trophozoites and symptomatic relief occurs in 1–3 days (even faster than metronidazole), but it is not curative in the sense that the patient continues to pass cysts in the stool. It is highly efficacious in amoebic liver abscess also.

Emetine cannot be given orally because it will be vomited out. It is administered by s.c. or i.m. injection: 60 mg OD. It should be given only till acute symptoms subside; not more than 10 days in any case. It is concentrated in liver, kidney, spleen and lungs. Emetine is very slowly excreted in urine taking 1–2 months. Thus, a second course should not be repeated within 6 weeks, otherwise cumulative toxicity can occur.

Toxicity of emetine is high.

Local: It is an irritant; pain, stiffness and eczematous lesions occur at the site of injection.

- Nausea and vomiting are frequent. After parenteral administration this is central in origin due to stimulation of CTZ. Vomiting due to oral dose of emetine is primarily because of gastric irritation.
- Abdominal cramps and diarrhoea due to emetine toxicity may be confused with that due to intestinal amoebiasis itself.
- Weakness and stiffness of muscles; a myositis like picture may be present.
- Hypotension, tachycardia, ECG changes and myocarditis are the most serious complications. To avoid these, strict bed rest must be imposed during emetine therapy and exercise should be prohibited for another 1–2 months.

Emetine is contraindicated in presence of cardiac or renal disease and during pregnancy.

Use Because of the above drawbacks, emetine is now seldom used as a *reserve drug* in severe intestinal or extraintestinal amoebiasis, or for patients not responding to or not tolerating metronidazole. A luminal amoebicide must always follow emetine to eradicate the cyst forming trophozoites.

It is also effective in liver fluke infestation.

EMETINE HCl: 60 mg /2 ml inj.

Dehydroemetine It is a semisynthetic derivative of emetine; equally effective but less cumulative and less toxic to the heart. Thus, it is preferred over emetine by most physicians.

Dose: 60–100 mg s.c./i.m.OD for not more than 10 days.
DEHYDROEMETINE HCl: 30 mg/ml inj, 1 and 2 ml amps.

CHLOROQUINE

The pharmacology of chloroquine is described in Ch. 59. It kills trophozoites of *E. histolytica* and is

highly concentrated in liver. Therefore, it is used in hepatic amoebiasis only. Because it is completely absorbed from the upper intestine and not so highly concentrated in the intestinal wall—it is neither effective in invasive dysentery nor in controlling the luminal cycle (cyst passers).

Efficacy of chloroquine in amoebic liver abscess approaches that of emetine, but duration of treatment is longer and relapses are relatively more frequent. Amoebae do not develop resistance to chloroquine.

Because of the relative safety of chloroquine it may be given concurrently or immediately after a course of metronidazole to ensure complete eradication of the trophozoites in liver. A luminal amoebicide must always be given with or after chloroquine to abolish the luminal cycle.

Dose for amoebic liver abscess: 600 mg (base) for two days followed by 300 mg daily for 2–3 weeks. It is now employed only when metronidazole is not effective or not tolerated.

AMIDES

Diloxanide furoate

It is a highly effective luminal amoebicide: directly kills trophozoites responsible for production of cysts. The furoate ester is hydrolysed in intestine and the released diloxanide is largely absorbed. Diloxanide is a weaker amoebicide than its furoate ester: no systemic antiamoebic activity is evident despite its absorption. It is primarily metabolized by glucuronidation and is excreted in urine.

Diloxanide furoate exerts no antibacterial action. It is less effective in invasive amoebic dysentery, because of poor tissue amoebicidal action. However, a single course produces high (80–90%) cure rate in mild intestinal amoebiasis and in asymptomatic cyst passers.

Dose: 500 mg TDS for 5–10 days; children 20 mg/kg/day.

FURAMIDE 0.5 g tab; in **TINIBA-DF** 250 mg + 150 mg tinidazole and **TINIBA-DF FORTE** 500 mg + 300 mg tabs; in **ENTAMIZOLE** 250 mg + 200 mg metronidazole and **ENTAMIZOLE FORTE** 500 mg + 400 mg tabs.

Diloxanide furoate is very well tolerated; the only side effects are flatulence, occasional nausea, itching and rarely urticaria. It is the drug of choice for mild intestinal/asymptomatic amoebiasis, and is given after any tissue amoebicide to eradicate cysts. Combined use with metronidazole/tinidazole is quite popular. Some chronic cases require repeat courses for eradication.

Nitazoxanide This salicylamide congener of the anthelmintic niclosamide, recently introduced for the treatment of giardiasis is also active against *E. histolytica*, *T. vaginalis*, *Cryptosporidium*, *H. pylori*, *Ascaris*, *H. nana* and some other protozoa and helminths. It is a prodrug which on absorption is converted to the active form *tizoxanide*, an inhibitor of PFOR enzyme that is an essential pathway of electron transport energy metabolism in anaerobic organisms. Activity against metronidazole-resistant *Giardia* has also been demonstrated. Tizoxanide produced in the body is conjugated and excreted in urine and bile.

Nitazoxanide is indicated in giardiasis, cryptosporidiasis, as well as in amoebic dysentery as luminal amoebicide. Abdominal pain, vomiting and headache are mild and infrequent side effects.

Dose: 500 mg (children 7.5 mg/kg) BD × 3 days
NITACURE, TITCOL, NITARID 200 mg, 500 mg tabs,
100 mg/5 ml dry syrup.

8-HYDROXYQUINOLINES

The 8-hydroxyquinolines were widely employed in the past: have similar properties; are active against *Entamoeba*, *Giardia*, *Trichomonas*, some fungi (dermatophytes, *Candida*) and some bacteria. They kill the cyst forming trophozoites in the intestine, but do not have tissue amoebicidal action. Like diloxanide furoate, they are not very effective in acute amoebic dysentery but afford relief in chronic intestinal amoebiasis. Their efficacy in eradicating cysts from asymptomatic carriers is rated lower than that of diloxanide furoate. They are totally valueless in extra-intestinal amoebiasis.

Absorption of 8-hydroxyquinolines from the intestine is variable. Least absorbed (10–30%) and probably safer drug is diiodohydroxyquin. The absorbed fraction is conjugated in liver with glucuronic acid and sulfate and excreted in urine; $t_{1/2}$ ~12 hours. Therapeutic concentrations are not attained in the intestinal wall or in liver. The unabsorbed part reaches lower bowel and acts on luminal cycle of amoebae.

These drugs have been widely and injudiciously used for the prophylaxis and treatment of nonspecific diarrhoeas, traveller's diarrhoea, dietary indiscretion, etc. An apparent therapeutic effect is frequently noted in mild cases, probably because most such conditions are self-limiting any way. This has fostered repeated and prolonged usage, which is irrational and may be harmful.

8-Hydroxyquinolines are well tolerated: produce few side effects—nausea, transient loose and green stools, pruritus, etc. Goiter has been reported after prolonged medication.

Iodism (furunculosis, inflammation of mucous membranes) may occur due to chronic iodine overload. Individuals sensitive to iodine may experience acute reaction with chills, fever, angioedema and cutaneous haemorrhages.

Prolonged/repeated use of relatively high doses of quiniodochlor caused a neuropathic syndrome called 'subacute myelo-optic neuropathy' (SMON) in Japan in an epidemic form, affecting several thousand people in 1970. Other 8-hydroxyquinolines have also produced neuropathy and visual impairment. However, despite widespread use in the past, only sporadic and unconfirmed cases have been reported from India. These drugs have been banned in Japan and few other countries, but in India they are banned only for pediatric patients, because their use for chronic diarrhoeas in children has caused blindness. Their fixed dose combinations, except those used for diarrhoea, dysentery and for external application are banned in India, and a cautionary note is inserted that use of high doses for more than 14 days can cause neuritis and optic damage.

8-Hydroxyquinolines are cheap and have good patient acceptability. They may be employed in intestinal amoebiasis as alternative to diloxanide furoate.

Other uses are—giardiasis; local treatment of monilial and trichomonas vaginitis, fungal and bacterial skin infections.

Quiniodochlor (Iodochlorohydroxyquin, Clioquinol): 250–500 mg TDS;

ENTEROQUINOL, QUINOFORM, DEQUINOL 250 mg tab.

Diiodohydroxyquin (Iodoquinol): 650 mg TDS;
DIODOQUIN 650 mg tab, 210 mg/5 ml susp.

Tetracyclines They directly inhibit amoebae only at higher concentrations. The older tetracyclines are incompletely absorbed in the small intestine, reach the colon in large amounts and inhibit the bacterial flora with which *Entamoebae* live symbiotically. Thus, they indirectly reduce proliferation of entamoebae in the colon and are especially valuable in chronic, difficult to treat cases with only the luminal cycle and little mucosal invasion. Tetracyclines have an adjuvant role in the management of such cases, in conjunction with a more efficacious luminal amoebicide. They are not good for acute dysentery and for hepatic amoebiasis.

NOTES ON THE TREATMENT OF AMOEBIASIS

1. Invasive intestinal amoebiasis Most cases of amoebic dysentery respond to a single adequate course of treatment. Metronidazole/tinidazole are the drugs of choice. Secnidazole, ornidazole, satranidazole are the alternatives. Adjuvant measures for diarrhoea and abdominal pain may be needed. Dehydroemetine is rarely used in the most severe cases to accord faster symptomatic relief. It should be discontinued as soon as acute symptoms are controlled (2–3 days) and metronidazole started. Emetine may also be needed when metronidazole is contraindicated or produces rashes/neurotoxicity.

The above treatment should be followed by a course of luminal amoebicide to eradicate

E. histolytica from the colon and to prevent carrier (cyst passing) state.

2. Chronic intestinal amoebiasis/asymptomatic cyst passers These cases are more difficult to treat, two or more repeated courses may be needed. Diloxanide furoate produces high cure rates and is the drug of choice. Nitazoxanide is an alternative. Metronidazole/tinidazole may be given in alternating courses, but are less effective in clearing cysts; they would though cure any latent hepatic infection. A single course of a hydroxyquinoline not extending beyond 2 weeks may be used as third choice.

A tetracycline may be given concurrently with the luminal amoebicide in cases which fail to clear completely.

3. Amoebic liver abscess It is a serious disease; complete eradication of trophozoites from the liver is essential to avoid relapses. Metronidazole/tinidazole are the first choice drugs effective in >95% cases. Dehydroemetine is to be used only if metronidazole cannot be given for one reason or the other, and in patients not cured by metronidazole. If a big abscess has formed, it may be aspirated.

A luminal amoebicide must be given later to finish the intestinal reservoir of infection. A course of chloroquine may be administered after that of metronidazole/dehydroemetine in those with incomplete response or to ensure that no motile forms survive in the liver.

DRUGS FOR GIARDIASIS

Giardia lamblia is a flagellate protozoon which mostly lives as a commensal in the intestine. It sometimes invades the mucosa and causes diarrhoea requiring treatment. Many drugs useful in amoebiasis are also effective in giardiasis.

1. Metronidazole 200 mg TDS (children 15 mg/kg/day) for 7 days or 2 g daily for 3 days or *tinidazole* 0.6 g daily for 7 days or 2 g single dose or secnidazole 2 g single dose may be considered as the drugs of choice.

2. **Nitazoxanide** (see p. 802) This prodrug of the PFOR enzyme inhibitor tizoxanide has recently become available for the treatment of diarrhoea and dysentery caused by *Giardia lamblia*, *E. histolytica*, *C. parvum*. The dosage schedule is convenient—500 mg (children 7.5 mg/kg) twice daily for 3 days, efficacy high (80–90%) and tolerability good.

3. **Quiniodochlor** 250 mg TDS for 7 days is a somewhat less effective alternative.

4. **Furazolidone** It is a nitrofurantoin compound active against many gram-negative bacilli including *Salmonella* and *Shigella*, also *Giardia* and *Trichomonas*.

For giardiasis 100 mg TDS for 5–7 days is inferior to metronidazole or tinidazole. It has also been used in bacterial enteritis, food poisoning diarrhoeas and bacillary dysentery, but is not a first line treatment for any of these.

Furazolidone is partly absorbed from intestines and excreted in urine which turns orange—patients should be told about it. Side effects are mild and infrequent—nausea, headache, dizziness.

FUROXONE 100 mg tab, 25 mg/5 ml susp.

DRUGS FOR TRICHOMONIASIS

Trichomonas vaginalis is another flagellate protozoon which causes vulvovaginitis. A large number and variety of drugs are effective by vaginal application, but may not entirely clear the infection; recurrences are frequent; repeat courses are required.

1. Drugs used orally

Metronidazole 400 mg TDS for 7 days or 2 g single dose, or **Tinidazole** 600 mg daily for 7 days or 2 g single dose or **Secnidazole** 2 g single dose, are the drugs of choice. They produce >90% cure. However, vaginitis due to nitroimidazole resistant *T. vaginalis* is being reported from some parts of the world. Additional intravaginal treatment is required only in refractory cases. A hard core of recurrent cases may remain. A repeat course can

be given after 6 weeks, and additional treatment for nonspecific vaginosis often helps. In some cases recurrences are due to reinfection from the male partner who harbours the parasite in the seminal vesicles but remains asymptomatic. In such cases, both partners should be treated concurrently to prevent cross infection of each other.

Nimorazole: It is another orally effective nitroimidazole; 2 g single dose taken with meals has produced satisfactory response in trichomonas vaginitis.

FLOSOGYN 250 mg tab.

2. Drugs used intravaginally

1. **Diiodohydroxyquin** 200 mg inserted intravaginally at bed time for 1–2 weeks;

FLORAQUIN 100 mg vaginal pessaries.

2. **Quiniodochlor** 200 mg inserted in the vagina every night for 1–3 weeks;

GYNOSAN 200 mg vaginal tab.

3. **Clotrimazole** 100 mg inserted high up in vagina every night for 6–12 days;

SURFAZ 100 mg vaginal tab.

4. **Hamycin** 4–8 lac U intravaginally daily for 15 days;

HAMYCIN VAGINAL 4 lac U ovules.

5. **Natamycin** 25 mg nightly intravaginal application for 10 days;

NATAMYCIN 25 mg vaginal tab.

6. **Povidone-iodine** 400 mg inserted in the vagina daily at night for 2 weeks;

BETADINE VAGINAL 200 mg pessaries.

DRUGS FOR LEISHMANIASIS

Visceral leishmaniasis (kala-azar) caused by *Leishmania donovani* occurs in several tropical and subtropical regions of the world. According to current estimates, ~15 lakh people world-wide suffer from the disease, of which nearly 2 lakh die every year. In India, it is estimated that 2 lakh new infections occur annually, of which 90% are in Bihar, but the disease is also present in eastern UP, West Bengal, Assam and Tamil Nadu. In north Bihar it is a serious health problem because

many cases are resistant to the first choice drug sodium stibogluconate (SSG).

Leishmaniasis is transmitted by the bite of the female sandfly phlebotomus. In the fly the parasite exists in the flagellate extracellular (*promastigote*) form, while in man it is found only intracellularly within macrophages in the nonflagellate (*amastigote*) form. Mucocutaneous and dermal leishmaniasis are caused respectively by *L. braziliensis* and *L. tropica* (also other species).

Drugs used in the treatment of leishmaniasis are:

Antimonial	Sodium stibogluconate (SSG)
Diamidine	Pentamidine
Antifungal drugs	Amphotericin B (AMB) Ketoconazole (KTZ)
Others	Miltefosine, Paromomycin Allopurinol

Sodium stibogluconate It is the drug of choice for kala-azar, but no longer useful in Bihar because of extensive resistance. It is a water-soluble pentavalent antimonial containing 1/3 antimony by weight. The mechanism of action and the basis of selective toxicity to the leishmania amastigotes is unclear; probably -SH dependent enzymes are inhibited and bioenergetics of the parasite is interfered with. It is thought to be acting by blocking glycolytic and fatty acid oxidation pathways. Recent evidence indicates that a specific enzyme, present in leishmania amastigotes, reduces pentavalent-Sb of SSG to the toxic trivalent form, which then promotes efflux of glutathione and other reduced thiols from the parasite exposing it to oxidative damage. Resistance to SSG may involve reduced capacity of the parasite to convert it to the trivalent form, and/or alteration in thiol metabolism of the parasite.

Sod. stibogluconate is rapidly absorbed from the site of i.m. injection and excreted unchanged in urine within 6–12 hrs. A small fraction enters tissues and remains stored for long periods. Repeated doses are cumulative.

It is available as aqueous solution:

ABANTE, STIBO 100 mg (antimony)/ml in 30 ml vials.

Dose: 20 mg/kg (max. 850 mg) daily by i.m. (in buttocks) or i.v. injection for 20–30 days or more. The duration of treatment is adjusted according to clinical response. Patients are considered cured when no parasites are detected in splenic or bone marrow aspirates.

Patients who relapse after responding initially should be retreated immediately using the same doses. In poor health patients and those who experience adverse effects, the injections may be given on alternate days. In India, SSG failure rate now is high (>60% in Bihar); it has been largely replaced by AMB and other drugs.

Adverse effects In general, antimonials are toxic drugs, but the pentavalent compounds (particularly SSG) are better tolerated. Nausea, vomiting, metallic taste, cough, pain abdomen, pain and stiffness of injected muscle, sterile abscesses, and mental symptoms often occur. Pancreatitis, liver and kidney damage, myelosuppression, ECG changes are possible, but are seldom severe. Few cases of shock and death are on record.

Sod. stibogluconate, nevertheless, is less toxic than amphotericin B or pentamidine.

Pentamidine The diamidines are active against *L. donovani*, *Trypanosomes*, *Pneumocystis jiroveci*, some bacteria and fungi (*Blastomyces*). Their mechanism of action is not properly understood. Pentamidine probably interacts with kinetoplast DNA and inhibits topoisomerase II, or interferes with aerobic glycolysis and/or utilization of polyamines.

Dose: 4 mg/kg deep i.m. or slow i.v. injection (over 1 hr) on alternate days for 5–15 weeks till no parasites are demonstrated in two splenic aspirates taken 2 weeks apart. Now, upto 40 injections are needed. It is supplied in 200 mg and 300 mg vials, only through Government agencies. The dry powder in vials should be dissolved to yield 10% solution just before injection.

After absorption from the site of injection it is rapidly taken up by tissues, especially liver and kidney and stored for months, during which time it is slowly excreted in urine, mostly in the unchanged form. Penetration into brain is poor.

Toxicity of pentamidine is high. Because of its strong basic nature, it causes histamine release

which is responsible for much of the acute reaction.

Acute reaction: sharp fall in BP, cardiovascular collapse, dyspnoea, palpitation, fainting, vomiting, rigor and fever occur frequently after i.v. injection; these are less severe with i.m. route, but i.m. route may cause local tissue necrosis. Patients must remain supine for ½ to 1 hr after injection. Other adverse effects are rashes, mental confusion, kidney and liver damage, ECG changes, rarely cardiac arrhythmias.

Pentamidine causes cytolysis of pancreatic β cells: insulin is released initially causing hypoglycaemia. Later on, permanent insulin-dependent diabetes mellitus can result in some cases.

Use

Kala-azar: Pentamidine should be used only for salvage therapy of antimonial failure cases. Amphotericin B is generally preferred over pentamidine, because of still higher toxicity of the latter. Though, proper use of pentamidine has achieved up to 98% cure rate in antimonial unresponsive or relapse cases, it is often used irregularly so that up to 25% pentamidine resistance is reported from Bihar. It is no longer the 2nd line drug in kala-azar.

Pneumocystis jiroveci pneumonia in AIDS patients: Pentamidine 3 mg/kg/day i.m. or slow i.v. injection for 3 weeks is an alternative drug to cotrimoxazole. It can also be given by inhalation (of nebulized solution) for treatment of established infection in AIDS patients.

Trypanosomiasis: May be used before CNS is involved.

Amphotericin B (AMB) Like fungi, leishmania has high percentage of ergosterol and is susceptible to this antifungal antibiotic. Presently, AMB is the drug with highest cure rate in kala-azar: up to 98% clinical and parasitological cure has been reported in SSG-resistant cases. However, high toxicity and need for prolonged hospitalization, monitoring and repeated slow i.v. infusions limit its application. Currently, it is

indicated in resistant kala-azar, and is being increasingly employed. In Bihar, it has become almost the standard treatment due to high incidence of SSG resistance.

Liposomal AMB is particularly suitable for kala-azar because it delivers the drug inside the reticuloendothelial cells in spleen and liver where the amastigotes live, but high cost is prohibitive. AMB is also useful in mucocutaneous leishmaniasis.

Dose: 0.5–1.0 mg/kg/day slow i.v. infusion till 15–20 mg/kg is administered.

Ketoconazole Another antifungal drug found to kill leishmania by inhibiting conversion of lanosterol to ergosterol: membrane function is impaired due to lowered ergosterol content. It is quite effective in dermal leishmaniasis. Limited trials with 600 mg/day for 4 weeks have found lower efficacy in kala-azar: it may be useful as add on drug.

Miltefosine It is the first oral antileishmania drug that has been under clinical study in India for the last 15 years, but has not yet been marketed commercially. A 4 week course of 100 mg/day has achieved >95% cure in kala-azar as well as cutaneous leishmaniasis. Stibogluconate-resistant leishmania are susceptible to miltefosine. Though vomiting and diarrhoea occur in over ½ of the patients, its toxicity is low. Reversible derangement of liver and kidney function has been observed.

Paromomycin This aminoglycoside antibiotic was introduced in the 1960s as a luminal amoebicide by oral route, but was soon withdrawn. Over the past decade it has been widely tried in India and Africa for kala-azar by i.m. injection and found to be effective in SSG-resistant cases.

In a recent phase III trial on 667 kala-azar patients in Bihar,* paromomycin 11 mg/kg/day \times 21 days has yielded 95% cure rate, which was not inferior to 99% cure rate obtained with AMB 1 mg/kg \times 15 injections over 30 days. Mortality was <1% with both the drugs. In Sudan, a 17 day course of SSG + paromomycin has become the 1st choice treatment of kala-azar, because it yielded higher initial cure rate and better survival than monotherapy with 30 day course of SSG. However, in India, combination of SSG + paromomycin has not been encouraging.

* Sundar S *et al.*: Injectable paromomycin for visceral leishmaniasis in India. *N Engl J Med.* 2007;356: 2571-2581.

Though paromomycin produces ototoxicity, elevated serum transaminase and injection site pain, it may prove to be an effective and easier to use alternative to AMB in resistant kala-azar. The Drugs Controller General of India has recently approved it for use in kala-azar.

Dose: 10–15 mg/kg/day i.m. × 21 days.

Allopurinol This hypoxanthine analogue and uric acid synthesis inhibitor exerts selective toxic effect on amastigotes. The unique purine salvage pathway present in *Leishmania* metabolizes allopurinol into the corresponding nucleotides which are incorporated in RNA—resulting in interference with protein synthesis. These allopurinol derived analogues may also compete with ATP.

Allopurinol has been tried in kala-azar in India and Africa at a dose of 4–12 mg/kg TDS for 3–4 weeks. Failure

rate has been high and it may be used only as a companion drug to antimonials in cases which do not respond to the latter alone.

Drugs used locally for dermal leishmaniasis (oriental sore)

1. *Sodium stibogluconate*: Infiltrate 2 ml of the solution (100 mg antimony/ml) round the sore.
2. *Paromomycin ointment*: applied topically on the sore.

Small and mild lesion may heal by itself in a few months. Multiple sores and severe cases should be treated by systemic drugs as for kala-azar. Ketoconazole is quite effective.

Antibiotics may be needed for secondary infection of the sore.



Anthelmintics are drugs that either kill (vermicide) or expel (vermifuge) infesting helminths.

Helminthiasis is prevalent globally (1/3rd of world's population harbours them), but is more common in developing countries with poorer personal and environmental hygiene. Multiple infestations in the same individual are not infrequent. In the human body, g.i.t. is the abode of many helminths, but some also live in tissues, or their larvae migrate into tissues. They harm the host by depriving him of food, causing blood loss, injury to organs, intestinal or lymphatic obstruction and by secreting toxins. Helminthiasis is rarely fatal, but is a major cause of ill health.

Malefern and chenopodium had been used for worm infestations for centuries. Many drugs were discovered in the early part of the present century. However, over the past 4 decades many new, highly efficacious and well tolerated anthelmintics have been developed. These have largely replaced the older drugs. The choice of drug for each worm infestation is based not only on efficacy, but also on lack of side effects/toxicity, ease of administration (preferably single dose) and low cost.

Development of resistance has not been a problem in the clinical use of anthelmintics. The current choice of drugs for worm infestations common in the Indian subcontinent is given in Table 61.1.

Mebendazole

It is a benzimidazole introduced in 1972. This congener of thiabendazole became very popular because it retained the broad-spectrum anthelmintic activity but not the toxicity of its predecessor. It has produced nearly 100% cure rate/reduction in egg count in roundworm, hook worm (both species), *Enterobius* and *Trichuris* infestations, but is much less active on *Strongyloides*. Upto 75% cure has been reported in tapeworms, but *H. nana* is relatively insensitive. It expels *Trichinella spiralis* from intestines, but efficacy in killing larvae that have migrated to muscles is uncertain. Prolonged treatment has been shown to cause regression of hydatid cysts in the liver. Treatment after resection of the cyst may prevent its regrowth.

The immobilizing and lethal action of mebendazole on worms is rather slow: takes 2–3 days to develop. It acts probably by blocking glucose uptake in the parasite and depletion of its glycogen stores. Intracellular microtubules in the cells of the worm are gradually lost. The site of action of mebendazole appears to be the microtubular protein 'β-tubulin' of the parasite. It binds to β-tubulin of susceptible worms with high affinity and inhibits its polymerization.

Table 61.1: Choice of drugs for helminthiasis

Worm	First choice drugs	Alternative drugs
1. ROUNDWORM <i>Ascaris lumbricoides</i>	Mebendazole, Albendazole, Pyrantel	Piperazine, Levamisole Ivermectin
2. HOOKWORM <i>Ancylostoma duodenale</i> <i>Necator americanus</i>	Pyrantel, Mebendazole, Albendazole Mebendazole, Albendazole	Levamisole Pyrantel
3. THREADWORM <i>Enterobius (Oxyuris) vermicularis</i>	Pyrantel, Mebendazole, Albendazole	Piperazine
4. <i>Strongyloides stercoralis</i>	Ivermectin	Albendazole
5. WHIPWORM <i>Trichuris trichiura</i>	Mebendazole	Albendazole
6. <i>Trichinella spiralis</i>	Albendazole	Mebendazole
7. FILARIA <i>Wuchereria bancrofti</i> , <i>Brugia malayi</i>	Diethyl carbamazine, Ivermectin	Albendazole
8. GUINEAWORM <i>Dracunculus medinensis</i>	Metronidazole	
9. TAPEWORMS <i>Taenia saginata</i> <i>Taenia solium</i> <i>Hymenolepis nana</i> Neurocysticercosis	Praziquantel, Niclosamide Praziquantel Praziquantel Albendazole	Albendazole Niclosamide, Albendazole Niclosamide Praziquantel
10. HYDATID DISEASE <i>Echinococcus granulosus</i> , <i>E. multilocularis</i>	Albendazole Albendazole	Mebendazole

Hatching of nematode eggs and their larvae are also inhibited. *Ascaris* ova are killed.

Pharmacokinetics Absorption of mebendazole from intestines is minimal; 75–90% of an oral dose is passed in the faeces. The fraction absorbed is excreted mainly as inactive metabolites in urine/faeces.

Adverse effects Mebendazole is well tolerated even by patients in poor health. Diarrhoea, nausea and abdominal pain have attended its use in heavy infestation. Incidents of expulsion of *Ascaris* from mouth or nose have occurred, probably due to starvation of the parasite and their slow death. Allergic reactions, loss of hair and granulocytopenia have been reported with high doses.

Safety of mebendazole during pregnancy is not known, but it is contraindicated on the basis of animal data.

Uses and administration Mebendazole is available as: **MEBEX**, **WORMIN 100 mg chewable tab** and **100 mg/5 ml suspension**. **MEBAZOLE 100 mg tab** The dose and duration of treatment is the same for children above 2 years as for adults; ½ dose for 1–2 yr age.

Roundworm } 100 mg twice a day for 3 consecutive
Hookworm } days. No fasting, purging or any other
Whipworm } preparation of the patients is needed.

Enterobius: 100 mg single dose, repeated after 2–3 weeks (to kill the ova that have developed later). Strict hygienic measures and simultaneous

treatment of all children in the family or class is advocated to cut down autoinfection and person to person infection. This holds true of enterobiasis, irrespective of drug used.

Trichinella spiralis: 200 mg BD for 4 days; less effective than albendazole.

Hydatid disease: 200–400 mg BD or TDS for 3–4 weeks; less effective than albendazole.

Mebendazole is one of the preferred drugs for treatment of multiple infestations and is more effective than albendazole in trichuriasis. It has also been used for mass treatment, but need for multiple doses is a drawback.

Albendazole

It is a subsequently introduced congener of mebendazole: retains the broad-spectrum activity and excellent tolerability of its predecessor, and has the advantage of single dose administration in many cases. One dose treatment has produced cure rates in ascariasis, hookworm (both species) and enterobiasis which are comparable to 3 day treatment with mebendazole. Results in trichuriasis have been inferior to mebendazole. In strongyloidosis, it is more effective than mebendazole: a 3 day course has achieved nearly 50% cure, and a second course repeated after 3 weeks cured practically all patients. Three day treatment has been found necessary for tapeworms including *H. nana*. Results in hydatid disease and hookworm have been superior to mebendazole. Albendazole has weak microfilaricidal action, kills cysticerci, hydatid larvae, ova of ascaris/hookworm and is also effective in cutaneous larva migrans. The mechanism of action of albendazole is similar to that of mebendazole.

Absorption of albendazole after oral administration is moderate, but inconsistent. It is enhanced when the drug is taken with fatty meal (may help in treating neurocysticercosis and hydatid disease). The fraction absorbed is converted by first pass metabolism to its sulfoxide metabolite which is active in contrast to the metabolites of mebendazole and thiabendazole. Albendazole

sulfoxide is widely distributed in the body, enters brain and is excreted in urine with a $t_{1/2}$ of 8.5 hours. Thus, albendazole is able to exert antihelmintic activity in tissues as well.

Albendazole is well tolerated; only gastrointestinal side effects have been noted. Few patients have felt dizziness. Prolonged use, as in hydatid or in cysticercosis, has caused headache, fever, alopecia, jaundice and neutropenia.

ZENTEL, ALMINTH, ALBEZOLE, COMBANTRIN-A 400 mg tab, 200 mg/5 ml suspension.

No preparation or postdrug fasting/purging is required. For intestinal worms it should be given on empty stomach, while for cysticercosis, hydatid and cutaneous larva migrans it should be given with a fatty meal.

- *Ascaris*, hookworm, *Enterobius* and *Trichuris*: a single dose of 400 mg (for adults and children above 2 yrs, 200 mg for 1–2 yr age).
- Tapeworms and strongyloidosis: 400 mg daily for 3 consecutive days.
- Trichinosis: Three day treatment expels the adult worm from intestine, but has limited effect on larvae that have migrated to muscles. They are not killed but symptomatic relief occurs. Corticosteroids are added if systemic manifestations are severe.
- Neurocysticercosis: Albendazole is the anthelmintic of choice for the treatment of neurocysticercosis (see later). Usually 8–15 days course of 400 mg BD (15 mg/kg/day) is employed. Cysticercosis of other tissues (muscles, subcutaneous area) also responds, but no drug should be given for ocular cysticercosis—blindness can occur due to the reaction.
- Cutaneous larva migrans: Albendazole 400 mg daily for 3 days is the drug of choice; kills larvae and relieves symptoms.
- Hydatid disease: 400 mg BD for 4 weeks, repeat after 2 weeks (if required), up to 3 courses. It is the preferred treatment given before and after surgery as well as to inoperable cases.
- Filariasis: Added to diethylcarbamazine (DEC) or ivermectin, albendazole has adjuvant value

in treating lymphatic filariasis. A single dose of its combination with either DEC or ivermectin given yearly has been used in mass programmes to suppress microfilaraemia and disease transmission.

Because it has exhibited embryotoxicity in animals, use in pregnant women is contraindicated. It should be given with caution to patients with hepatic or renal disease.

Thiabendazole

It was the first benzimidazole polyanthelmintic introduced in 1961, which covered practically all species of nematodes infesting the g.i.t.—roundworm, hookworm, *Enterobius*, *Trichuris*, *Strongyloides* and *Trichinella spiralis*. It also inhibits development of the eggs of worms and kills larvae. Thiabendazole affords symptomatic relief in cutaneous larva migrans and skeletal muscle symptoms produced by migration of *Trichinella spiralis* larvae to muscles. Symptomatic relief also occurs in guinea worm disease.

The mechanism of action of thiabendazole is the same as described for mebendazole. Thiabendazole has anti-inflammatory, analgesic and antipyretic actions. These may contribute to its effect in cutaneous larva migrans and other inflammatory conditions produced by larvae or worms in tissues.

Since thiabendazole is well absorbed from g.i.t., systemic adverse effects are frequent and often interfere with normal activity.

Nausea, vomiting, loss of appetite, headache, giddiness are most common. It can impair alertness—driving and operation of machinery should be prohibited. Itching, abdominal pain, diarrhoea and a variety of other symptoms are also produced.

Dose 25 mg/kg/day in two divided doses taken after meals. Tablets must be chewed;

Uses Because of frequent side effects and poor patient acceptability, thiabendazole is used only when other better tolerated drugs are ineffective.

- | | | |
|---|---|--|
| <ol style="list-style-type: none"> 1. Strongyloidosis 2. Cutaneous larva migrans 3. Trichinosis—intestinal infestation and larvae in muscles | } | <p>Give a 2 day course.
If inadequate, repeat after a gap of 2 days.</p> |
|---|---|--|

Trichinella larvae in muscles are often not killed, but symptomatic relief occurs quickly.

Pyrantel pamoate

It was introduced in 1969 for threadworm infestation in children; use soon extended to

roundworm and hookworm as well. Efficacy against *Ascaris*, *Enterobius* and *Ancylostoma* is high and comparable to that of mebendazole. Lower cure rates (about 60%) have been obtained in case of *Necator* infestation. It is less active against *Strongyloides* and inactive against *Trichuris* and other worms.

Pyrantel causes activation of nicotinic cholinergic receptors in the worms resulting in persistent depolarization → slowly developing contracture and spastic paralysis. Worms are then expelled. An anticholinesterase action has also been demonstrated. Because piperazine causes hyperpolarization and flaccid paralysis, it antagonizes the action of pyrantel. Cholinergic receptors in mammalian skeletal muscle have very low affinity for pyrantel.

Only 10–15% of an oral dose of pyrantel pamoate is absorbed: this is partly metabolized and excreted in urine.

Adverse effects Pyrantel pamoate is remarkably free of side effects: occasional g.i. symptoms, headache and dizziness is reported. It is tasteless, nonirritant; abnormal migration of worms is not provoked. Its safety in pregnant women and in children below 2 years has not been established.

Use and administration For *Ascaris*, *Ancylostoma* and *Enterobius*: a single dose of 10 mg/kg is recommended. A 3 day course for *Necator* and for *Strongyloides* has been suggested.

No fasting, purging or other preparation of the patient is needed.

NEMOCID, ANTIMINTH, EXPENT 250 mg tab, 50 mg/ml suspension (10 ml bottle).

Piperazine

Introduced in 1950, it is a highly active drug against *Ascaris* and *Enterobius*; achieves 90–100% cure rates. However, it is now considered a second choice drug even for these worms. Piperazine causes hyperpolarization of *Ascaris* muscle by a GABA agonistic action opening Cl⁻ channels that causes relaxation and depresses responsiveness to contractile action of ACh. Flaccid paralysis

occurs and worms are expelled alive. They recover if placed in piperazine free medium. Therefore, often a purgative (senna) is given with it, but is not necessary. No fasting or patient preparation is required. Piperazine does not excite *Ascaris* to abnormal migration. It does not affect neuromuscular transmission in man.

Pharmacokinetics A considerable fraction of the oral dose of piperazine is absorbed. It is partly metabolized in liver and excreted in urine.

Adverse effects Piperazine is safe and well tolerated. Nausea, vomiting, abdominal discomfort and urticaria are occasional.

Dizziness and excitement occur at high doses; toxic doses produce convulsions; death is due to respiratory failure. It is contraindicated in renal insufficiency and in epileptics, but is safe in the pregnant.

Dose: For roundworm infestation 4 g once a day for 2 consecutive days; children 0.75 g/year of age (max. 4 g) is considered curative. Because of its capacity to relax ascarids, it is of particular value in intestinal obstruction due to roundworms. It can be used during pregnancy while other drugs cannot be used.

Enterobiasis—50 mg/kg (max. 2 g) once a day for 7 days or 75 mg/kg (max. 4 g) single dose, repeated after 3 weeks.

PIPERAZINE CITRATE 0.75 g/5 ml elixir in 30 ml, 115 ml bottle; 0.5 g (as phosphate) tablets;

Combination of any other anthelmintic (except piperazine) with a purgative in the same formulation is banned in India.

Levamisole, Tetramisole

Tetramisole was developed in the late 1960s. It is recemic; its levo isomer (levamisole) was found to be more active and is preferred now. Both are active against many nematodes, but use is restricted to ascariasis and ancylostomiasis, because action on other worms is poor. *Strongyloides* larvae are killed, but adult worms are not sensitive. The ganglia in worms are stimulated causing tonic paralysis and expulsion of live worms. Interference with carbohydrate metabolism (inhibition of fumarate reductase) may also be contributing.

Uses For *Ascaris* infestation a single dose of levamisole 50 mg for children 10–19 kg body weight, 100 mg for 20–39 kg and 150 mg for >40 kg and adults is advocated. It achieves >90% cure rate.

Levamisole is a second line drug for *A. duodenale*; 2 doses at 12 hour interval are suggested—achieves 70–90% cure. It is less efficacious against *Necator*.

Tetramisole: DECARIS 50, 150 mg tab.

Levamisole: DEWORMIS, VERMISOL 50, 150 mg tab, 50 mg/5 ml syr.

Levamisole is an immunomodulator as well: restores depressed T cell function. It was used as a disease modifying drug in rheumatoid arthritis and as an adjunct in malignancies, aphthous ulcers and recurrent herpes, but repeated doses produce severe reactions; not used now.

Adverse effects One or two doses used in helminthiasis are well tolerated. Incidence of side effects—nausea, abdominal pain, giddiness, fatigue, drowsiness or insomnia is low.

Diethyl carbamazine citrate (DEC)

Developed in 1948, it is the first drug for filariasis. DEC is absorbed after oral ingestion, distributed all over the body ($V = 3\text{--}5\text{ L/kg}$), metabolized in liver and excreted in urine. Excretion is faster in acidic urine. Plasma $t_{1/2}$ of usual clinical doses is 4–12 hours, depending on urinary pH.

Diethylcarbamazine has a highly selective effect on microfilariae (Mf). A dose of 2 mg/kg TDS clears Mf of *W. bancrofti* and *B. malayi* from peripheral blood in 7 days. However, Mf present in nodules and transudates (hydrocoele) are not killed. The most important action of DEC appears to be alteration of Mf membranes so that they are readily phagocytosed by tissue fixed monocytes, but not by circulating phagocytes. Muscular activity of the Mf and adult worms is also affected causing hyperpolarization due to the piperazine moiety, so that they are dislodged. Prolonged treatment may kill adult *B. malayi* and probably *W. bancrofti* worms also.

DEC is active against Mf of *Loa loa* and *Onchocerca volvulus*. The adult worm of *L. loa* but not *O. volvulus* is killed. DEC reduces worm burden in ascariasis, but efficacy is low.

Uses

1. *Filariasis*: 2 mg/kg TDS produces rapid symptomatic relief; Mf disappear from blood and patient becomes noninfective to mosquitoes in 7 days. However, the adult worm survives in the lymphatics and gives rise to intermittent microfilaraemia and symptoms. Prolonged treatment with different schedules has been found to achieve radical cure in most patients. A total dose of 72–126 mg/kg spread over 12 days to 3 weeks has been found satisfactory; more than one course may be needed with a gap of 3–4 weeks. Elephantiasis due to chronic lymphatic obstruction is not affected by DEC, because fibrosis of lymphatics is irreversible. Yearly treatment with a combination of DEC and albendazole on mass scale has brought down transmission of filariasis by reducing microfilaraemia.

2. *Tropical eosinophilia*: DEC (2–4 mg/kg TDS) for 2–3 weeks produces dramatic improvement in the signs and symptoms of eosinophilic lung or tropical eosinophilia. The benefit probably reflects anti-microfilarial action: the symptoms of the disease being presumably due to reaction to the Mf. **HETRAZAN**, **BANOCIDE** 50, 100 mg tab, 120 mg/5 ml syr; 50 mg/ 5 ml pediatric syr; to be taken after meals.

Loa loa and *O. volvulus* infections can also be treated with DEC, but it is imperative to give small (25–50 mg) test dose initially to avoid severe reaction to dying Mf. Ivermectin does not produce such severe reactions and is preferred for initial treatment.

Adverse effects These are common but generally not serious. Nausea, loss of appetite, headache, weakness and dizziness are the usual complaints.

A febrile reaction with rash, pruritus, enlargement of lymph nodes and fall in BP may occur due to mass destruction of Mf and adult worms. This is usually mild, but may be severe. The

reaction can be minimized by starting with a low dose (0.5 mg/kg). When it occurs, DEC should be temporarily withheld and antihistaminics and/or corticosteroids given. Subsequent administration of DEC does not cause such reaction. Leukocytosis and mild albuminuria are also noted.

Ivermectin It is an extremely potent semisynthetic derivative of the antinematodal principle obtained from *Streptomyces avermitilis*, that has been used in other countries for long, but marketed in India only recently. Ivermectin is the drug of choice for single dose treatment of onchocerciasis and strongyloidosis, and is comparable to DEC for bancroftian and brugian filaria. It is also highly effective in cutaneous larva migrans and ascariasis, while efficacy against *Enterobius* and *Trichuris* is moderate. Certain insects, notably scabies and head lice are killed by ivermectin.

Nematodes develop tonic paralysis when exposed to ivermectin. It acts through a special type of glutamate gated Cl⁻ channel found only in invertebrates. Such channels are not involved in the motor control of flukes and tapeworms which are unaffected by ivermectin. Potentiation of GABAergic transmission in the worm has also been observed. The lack of GABA-related actions in man could be due to its low affinity for mammalian GABA receptors and its exclusion from the brain, probably by P-glycoprotein mediated efflux at the blood brain-barrier.

A single 10–15 mg (0.2 mg/kg) oral dose of ivermectin, preferably with 400 mg albendazole, given annually for 5–6 years has been used for filariasis. Single 0.15–0.2 mg/kg dose has yielded highest cure rate in strongyloidosis and reduces burden of other intestinal nematodes as well.

Ivermectin has replaced DEC for onchocerciasis and has been used in the 'river blindness' control programme of WHO in Africa and Latin America. One dose of ivermectin is given at 6–12 month intervals—produces long lasting reduction of Mf counts in eye and skin, without affecting the adult worm. Though it does not cure *O. volvulus* infection, ocular inflammation/damage as well as lymphadenopathy are suppressed with only mild ocular or systemic reactions.

Ivermectin is the only drug effective orally in scabies and pediculosis. Single 0.2 mg/kg dose cures most patients.

IVERMECTOL, IVERMEC, VERMIN 3, 6 mg tabs; to be taken on empty stomach.

Ivermectin is well absorbed orally, widely distributed in the body, but does not enter CNS, sequestered in liver and fat, and has a long terminal $t_{1/2}$ of 48–60 hours. Side effects have been mild—pruritus, giddiness, nausea, abdominal pain, constipation, lethargy and transient ECG changes, but more important are the reactions due to degeneration products of the Mf, which are similar to those occurring after DEC.

Niclosamide

Niclosamide is a highly effective drug against cestodes infesting man—*Taenia saginata*, *T. solium*, *Diphyllobothrium latum* and *Hymenolepis nana*, as well as threadworm. The drug appears to act by inhibiting oxidative phosphorylation in mitochondria and interfering with anaerobic generation of ATP by the tapeworm. Injured by niclosamide, the tapeworms are partly digested in the intestine. In cases of *T. solium*, digestion of the dead segments can be hazardous, because the ova released from them may develop into larvae in the intestine, penetrate its wall and cause visceral cysticercosis. Many experts do not use niclosamide now for *T. solium* infestation.

Regimen for tapeworm Niclosamide is available as 0.5 g tab (**NICLOSAN**). After a light breakfast, 2 tablets are to be chewed and swallowed with water, followed by another 2 tablets after 1 hr (total 2 g); total dose for children 2–6 years is 1 g. A saline purge is given 2 hours after the later dose to wash off the worm. The scolex should be searched in the stools to be sure that the worm will not grow again. Cure rate of 85–95% has been obtained by one day treatment. A thorough purge is essential in the cases of *T. solium* so that all segments are passed out and cysticercosis does not occur. Because praziquantel does not lead to digestion of the worm and kills encysted larvae as well, it is the drug of choice for *T. solium*.

For *H. nana*, the 2 g dose is repeated daily for 5 days. This is needed because cysticerci of *H. nana* (which are not affected by niclosamide) develop in the jejunal villi of the same host and worms appear in the intestinal lumen after 4 days. However, no purgative is required. In some cases

treatment may have to be repeated after 10 days. Praziquantel is now preferred due to single dose treatment.

Adverse effects Niclosamide is tasteless and nonirritating. It is minimally absorbed from g.i.t.—no systemic toxicity occurs. It is well tolerated; minor abdominal symptoms are produced occasionally. Malaise, pruritus and light headedness are rare. Niclosamide is safe during pregnancy and in patients with poor health.

Praziquantel

This novel anthelmintic has wide ranging activity against *Schistosomes*, other trematodes, cestodes and their larval forms but not nematodes. It is rapidly taken up by susceptible worms and appears to act by causing leakage of intracellular calcium from the membranes → contracture and paralysis. The tapeworms lose grip of the intestinal mucosa and are expelled. Flukes and schistosomes are also dislodged in tissues and veins. Praziquantel is active against adult as well as juvenile and larval stages of tapeworms.

At relatively higher concentrations, it causes vacuolization of the tegument and release of the contents of tapeworms and flukes followed by their destruction by the host. This action appears to be more important in cases of schistosomes and flukes.

Pharmacokinetics Praziquantel is rapidly absorbed from intestines and absorption is enhanced by ingesting it with food. It undergoes high first pass metabolism in liver which limits its systemic bioavailability. Phenytoin, carbamazepine and possibly dexamethasone induce praziquantel metabolism and further reduce its bioavailability. Patients of neurocysticercosis are often receiving these drugs—may contribute to therapeutic failure of praziquantel. It crosses blood-brain barrier and attains therapeutic concentrations in the brain and CSF. The plasma $t_{1/2}$ is short (1.5 hours). Metabolites are excreted chiefly in urine.

Adverse effects Despite systemic absorption, praziquantel has exhibited no systemic toxicity.

It tastes bitter: can produce nausea and abdominal pain. Other side effects are headache, dizziness and sedation. When used for schistosomes and visceral flukes, symptoms like itching, urticaria, rashes, fever and bodyache occur as a reaction to the destroyed parasites.

No interaction with food, alcohol or tobacco has been noted.

Uses

1. *Tapeworms*: Praziquantel administered as a single dose has achieved 90–100% cure rate in all human tapeworms. This level of activity is similar to that of niclosamide and even better in case of *H. nana*.

T. saginata, *T. solium*: 10 mg/kg single dose in morning. It is especially valuable in case of *T. solium*, because it kills the tapeworm larvae within the cysts and there are no chances of systemic cysticercosis developing.

H. nana, *D. latum*: 15–25 mg/kg single dose in morning. This is much simpler compared to 5 day treatment needed with niclosamide for eradication of *H. nana*. In case of heavy infestation, retreatment after one week is desirable.

2. *Neurocysticercosis*: Praziquantel was the first drug found to be effective in neurocysticercosis: 50–100 mg/kg daily in 3 divided doses for 15 days kills the larvae lodged in brain and other tissues. However, it is now the 2nd choice drug to albendazole (see below).

Praziquantel or albendazole are contraindicated in ocular cysticercosis.

3. *Schistosomes*: All 3 species can be treated with 40–75 mg/kg given once or in instalments in one day.

4. *Other flukes*: Praziquantel is the drug of choice for all schistosome and fluke infestations except *Fasciola hepatica*. The flukes respond to 75 mg/kg/day given for one day in most and two days in some cases.

CYSTICIDE 500 mg tab, DISTOCIDE 600 mg tab.

Anthelmintic treatment of neurocysticercosis

Cysticercosis of various organs, including brain, occurs in *T. solium* infestation due to migration of the larvae from the gut to various tissues *via* blood stream. Anthelmintic treatment of neurocysticercosis is considered optional, because the cysts do not cause any problem unless the larva dies and its products induce an intense focal reaction resulting in seizures and other neurological symptoms. The anthelmintic kills the larvae and precipitates a reaction, but prevents future episodes due to spontaneous death of the cysticerci. The decision whether or not to give the anthelmintic may be taken depending on the number, location and viability of the cysts. Multiple, live, parenchymal cysts are better treated; while solitary (or few), ventricular or calcified cysts are better left alone.

Out of the two anthelmintics effective in killing cysticerci, albendazole is now preferred over praziquantel for the following reasons:

- The course of treatment is shorter (8–15 day) compared to praziquantel (15–30 days).
- Cure rates in terms of resolution of symptoms and disappearance of cysts are higher (75–85% with albendazole) than praziquantel (50–60%).
- Corticosteroids (which have to be given concurrently) enhance the absorption of albendazole, but lower the blood levels of praziquantel.
- Albendazole is cheaper.

Whichever anthelmintic is used, corticosteroids (prednisolone 40–60 mg/day or dexamethasone 8–12 mg/day) must be started 2 days before and continued till 2 weeks after completing the anthelmintic course. This is necessary to suppress the neurological reaction to the products of killed larvae. Absorption of both albendazole and praziquantel is enhanced by ingesting them with food, particularly fatty food. For patients with seizures (as most of them are), adequate anticonvulsant treatment should be given beforehand and the fits controlled.

Phenytoin and carbamazepine are the most commonly used drugs. They induce the metabolism of praziquantel, which may necessitate use of higher doses. The anticonvulsant must be continued through the course of anthelmintic medication and for an indefinite period (mostly

1–6 months) after it. While parenchymal cysts respond to albendazole in 8–15 days, intraventricular and subarachnoid cysts may require treatment for a month or longer. It is very important to kill and expel the adult worm from the gut to eliminate the source of future cysticerci.

Chemotherapy of Neoplastic Diseases

SECTION
13

CHAPTER 62

Anticancer Drugs

The anticancer drugs either kill cancer cells or modify their growth. However, selectivity of majority of drugs is limited and they are one of the most toxic drugs used in therapy.

Treatment of malignant diseases with drugs is a rather recent development—started after 1940 when nitrogen mustard was used, but progress has been rapid, both in revealing pathobiology of the diseases and in discovery of new drugs. In addition, attempts have been made to define optimal combinations, treatment strategies and patient support measures. Cancer chemotherapy is now of established value and a highly specialized field; only the general principles and an outline will be presented here.

In addition to their prominent role in leukaemias and lymphomas, drugs are used in conjunction with surgery, radiotherapy and immunotherapy in the *combined modality approach* for many solid tumours, especially metastatic. In malignant diseases, drugs are used with the aim of:

1. **Cure or prolonged remission** Chemotherapy is the primary treatment modality that can achieve cure or prolonged remission in:

Acute leukemias	} in children	Choriocarcinoma
Wilm's tumour		Hodgkin's disease
Ewing's sarcoma		Lymphosarcoma
Retinoblastoma		Burkitt's lymphoma
Rhabdomyosarcoma		Testicular teratomas
		Seminoma
		Mycosis fungoides

2. **Palliation** Gratifying results are obtained (shrinkage of evident tumour, alleviation of symptoms) and life is prolonged by chemotherapy in:

Breast cancer	Chronic lymphatic leukemia
Ovarian carcinoma	Chronic myeloid leukemia
Endometrial carcinoma	Non-Hodgkin lymphomas
Myeloma	Head and neck cancers
Prostatic carcinoma	Lung (small cell) cancer

Many other malignant tumours are less sensitive to drugs—life may or may not be prolonged by chemotherapy. Tumours that are largely refractory to presently available drugs are:

Colorectal carcinoma	Malignant melanomas
Carcinoma pancreas	Bronchogenic carcinoma
Carcinoma stomach	(non small cell)
Carcinoma esophagus	Hepatoma
Renal carcinoma	Sarcoma

3. **Adjuvant chemotherapy** Drugs are used to mop up any residual malignant cells (micro metastases) after surgery or radiotherapy. This is routinely employed now.

CLASSIFICATION

A. Drugs acting directly on cells (Cytotoxic drugs)

1. **Alkylating agents**
 - Nitrogen mustards*
 - Mechlorethamine (Mustine HCl)
 - Cyclophosphamide,
 - Ifosfamide,
 - Chlorambucil,
 - Melphalan

<i>Ethylenimine</i>	Thio-TEPA
<i>Alkyl sulfonate</i>	Busulfan
<i>Nitrosoureas</i>	Carmustine (BCNU), Lomustine (CCNU)
<i>Triazine</i>	Dacarbazine (DTIC)
2. Antimetabolites	
<i>Folate antagonist</i>	Methotrexate (Mtx)
<i>Purine antagonist</i>	6-Mercaptopurine (6-MP), 6-Thioguanine (6-TG), Azathioprine, Fludarabine
<i>Pyrimidine antagonist</i>	5-Fluorouracil (5-FU), Cytarabine (cytosine arabinoside)
3. Vinca alkaloids	Vincristine (Oncovin), Vinblastine
4. Taxanes	Paclitaxel, Docetaxel
5. Epipodophyllo toxin	Etoposide
6. Camptothecin analogues	Topotecan, Irinotecan
7. Antibiotics	Actinomycin D (Dactinomycin) Doxorubicin Daunorubicin (Rubidomycin) Mitoxantrone Bleomycins, Mitomycin C
8. Miscellaneous	Hydroxyurea, Procarbazine, L-Asparaginase, Cisplatin Carboplatin Imatinib

B. Drugs altering hormonal milieu

1. Glucocorticoids	Prednisolone and others
2. Estrogens	Fosfestrol, Ethinylestradiol
3. Selective estrogen receptor modulators	Tamoxifen, Toremifene
4. Selective estrogen receptor down regulators	Fulvestrant

5. Aromatase inhibitors	Letrozole, Anastrozole, Exemestane
6. Antiandrogen	Flutamide, Bicalutamide
7. 5-α reductase inhibitor	Finasteride, Dutasteride
8. GnRH analogues	Nafarelin, Triptorelin
9. Progestins	Hydroxyprogesterone acetate, etc.

GENERAL TOXICITY OF CYTOTOXIC DRUGS

Majority of the cytotoxic drugs have more profound effect on rapidly multiplying cells, because the most important target of action are the nucleic acids and their precursors; rapid nucleic acid synthesis occurs during cell division. Many cancers (especially large solid tumours) have a lower growth fraction (lower percentage of cells are in division) than normal bone marrow, epithelial linings, reticuloendothelial (RE) system and gonads. These tissues are particularly affected in a dose-dependent manner by majority of drugs; though, there are differences in susceptibility to individual members.

1. Bone marrow Depression of bone marrow results in granulocytopenia, agranulocytosis, thrombocytopenia, aplastic anaemia. This is the most serious toxicity; often limits the dose that can be employed. Infections and bleeding are the usual complications.

2. Lymphoreticular tissue Lymphocytopenia and inhibition of lymphocyte function results in suppression of cell mediated as well as humoral immunity.

Because of action (1) and (2) + damage to epithelial surfaces, the host defence mechanisms (specific as well as nonspecific) are broken down \rightarrow susceptibility to all infections is increased. Of particular importance are the opportunistic infections due to low pathogenicity organisms. Infections by fungi (*Candida* and others causing

deep mycosis), viruses (*Herpes zoster*, cytomegalo virus), *Pneumocystis jiroveci* (a fungus) and *Toxoplasma* are seen primarily in patients treated with anticancer drugs.

3. Oral cavity: The oral mucosa is particularly susceptible to cytotoxic drugs because of high epithelial cell turnover. Many chemotherapeutic drugs produce stomatitis as an early manifestation of toxicity. The gums and oral mucosa are regularly subjected to minor trauma, and breaches are common during chewing. Oral microflora is large and can be the source of infection. Neutropenia and depression of immunity caused by the drug indirectly increase the chances of oral infections. Thrombocytopenia may cause bleeding gums. Xerostomia due to the drug may cause rapid progression of dental caries.

4. GIT Diarrhoea, shedding of mucosa, haemorrhages occur due to decrease in the rate of renewal of the mucous lining. Drugs that frequently cause mucositis are—bleomycin, actinomycin D, daunorubicin, doxorubicin, fluorouracil and methotrexate.

Nausea and vomiting are prominent with many cytotoxic drugs. This is due to direct stimulation of CTZ by the drug as well as generation of emetic impulses/mediators from the upper g.i.t. and other areas (see Ch. 47).

Emetogenic potential of cytotoxic drugs

High	Moderate	Mild
Cisplatin	Carboplatin	Bleomycin
Mustine	Cytarabine	Chlorambucil
Cyclophosphamide	Procarbazine	Busulfan
Actinomycin D	Vinblastine	Fluorouracil
Dacarbazine	Doxorubicin	6-Thioguanine
Lomustine	Daunorubicin	Hydroxyurea
	Ifosfamide	Vincristine
	6-Mercaptopurine	Methotrexate
		Etoposide
		l-Asparaginase

5. Skin Alopecia occurs due to damage to the cells in hair follicles. Dermatitis is another complication.

6. Gonads Inhibition of gonadal cells causes oligozoospermia and impotence in males; inhibition of ovulation and amenorrhoea are common in females.

Damage to the germinal cells may result in mutagenesis.

7. Foetus Practically all cytotoxic drugs given to pregnant women profoundly damage the developing foetus → abortion, foetal death, teratogenesis.

8. Carcinogenicity Secondary cancers, especially leukaemias, lymphomas and histocytic tumours appear with greater frequency many years after the use of cytotoxic drugs. This may be due to depression of cell mediated and humoral *blocking factors* against neoplasia.

9. Hyperuricaemia This is secondary to massive cell destruction (uric acid is a product of purine metabolism). Gout and urate stones in the urinary tract may develop. Allopurinol is protective by decreasing uric acid synthesis.

In addition to these general toxicities, individual drugs may produce specific adverse effects, e.g. neuropathy by vincristine, cardiomyopathy by doxorubicin, cystitis and alopecia by cyclophosphamide.

NOTES ON INDIVIDUAL DRUGS

ALKYLATING AGENTS

These compounds produce highly reactive carbonium ion intermediates which transfer alkyl groups to cellular macromolecules by forming covalent bonds. The position 7 of guanine residues in DNA is especially susceptible, but other molecular sites are also involved. Alkylation results in cross linking/abnormal base pairing/scission of DNA strand. Cross linking of nucleic acids with proteins can also take place.

Alkylating agents have cytotoxic and radiomimetic (like ionizing radiation) actions. Many are cell cycle non-specific, i.e. act on dividing as well as resting cells. Some have CNS stimulant and cholinergic properties.

Mechlorethamine (Mustine HCl) It is the first nitrogen mustard; highly reactive and local vesicant—can be given only by i.v. route. It produces many acute effects like nausea, vomiting and haemodynamic changes. Extravasation during i.v. injection may cause sloughing.

Dose: 0.1 mg/kg i.v. daily × 4 days; courses may be repeated at suitable intervals.

MUSTINE 10 mg dry powder in vial.

Cyclophosphamide It is inactive as such; produces few acute effects and is not locally damaging. Transformation into active metabolites (aldophosphamide, phosphoramidate mustard) occurs in the liver, and a wide range of antitumour actions is exerted. It has prominent immunosuppressant property. Thus, it is one of the most popular anticancer drugs. It is less damaging to platelets, but alopecia and cystitis (due to another metabolite acrolein) are prominent. Chloramphenicol retards the metabolism of cyclophosphamide.

Dose: 2–3 mg/kg/day oral; 10–15 mg/kg i.v. every 7–10 days, i.m. use also possible.

ENDOXAN, CYCLOXAN 50 mg tab; 200, 500, 1000 mg inj.

Ifosfamide This congener of cyclophosphamide has a longer and dose-dependent $t_{1/2}$. It has found utility in bronchogenic, breast, testicular, bladder, head and neck carcinomas, osteogenic sarcoma and some lymphomas. The dose limiting toxicity of ifosfamide is haemorrhagic cystitis. To prevent the same *mesna* is routinely given with it. Mesna is a –SH compound that is excreted in urine—binds and inactivates the vasitotoxic metabolites of ifosfamide and cyclophosphamide. Ifosfamide causes less alopecia and is less emetogenic than cyclophosphamide.

HOLOXAN-UROMITEXAN 1 g vial + 3 amps of mesna 200 mg inj.; HOLOXAN, IPAMIDE 1 g inj.

Chlorambucil It is a very slow acting alkylating agent, especially active on lymphoid tissue: Myeloid tissue is largely spared. It is the drug of choice for long-term maintenance therapy for chronic lymphatic leukaemia; Hodgkin's disease and some solid tumours also resolve. It has some immunosuppressant property.

Dose: 4–10 mg (0.1–0.2 mg/kg) daily for 3–6 weeks, then 2 mg daily for maintenance; **LEUKERAN 2, 5 mg tab.**

Melphalan It is very effective in multiple myeloma and has been used in advanced ovarian cancer. Bone marrow depression is the most important toxicity. Infections, diarrhoea and pancreatitis are the complications.

Dose: 10 mg daily for 7 days or 6 mg/day for 2–3 weeks—4 weeks gap—2 to 4 mg daily for maintenance orally. Also used for regional perfusion in malignant melanoma. **ALKERAN 2, 5 mg tab, 50 mg per vial for inj.**

Thio-TEPA It is an ethylenimine: does not require to form an active intermediate. It has high toxicity: seldom used now.

Dose: 0.3–0.4 mg/kg i.v. at 1–4 week intervals.

THIOTEPA 15 mg per vial inj.

Busulfan It is highly specific for myeloid elements; granulocyte precursors being the most sensitive, followed by those of platelets and RBC. It produces little effect on lymphoid tissue and g.i.t. Hyperuricaemia is common and pulmonary fibrosis is a specific adverse effect. Sterility also occurs. It is the drug of choice for chronic myeloid leukaemia.

Dose: 2–6 mg/day (0.06 mg/kg/day) orally.

MYLERAN, BUSUPHAN 2 mg tab.

Nitrosoureas These are highly lipid soluble alkylating agents with a wide range of antitumour activity. They cross blood-brain barrier—are effective in meningeal leukaemias and brain tumours. Nausea, vomiting are common and CNS effects also occur. Bone marrow depression is peculiarly delayed, taking nearly 6 weeks to develop. Visceral fibrosis and renal damage can occur:

Lomustine (CCNU): 100–130 mg/m² BSA single oral dose every 6 weeks; **LOMUSTINE 40, 100 mg cap.**

Dacarbazine (DTIC) It is different from other alkylating agents in having primary inhibitory action on RNA and protein synthesis (others mainly affect DNA). It is activated in the liver. The most important indication is malignant melanoma; also used in Hodgkin's disease. Nausea and vomiting are prominent side effects.

Dose: 3.5 mg/kg/day i.v. for 10 days, repeat after 4 weeks. **DACARIN 100, 200, 500 mg inj; DACARZINE 200 mg/vial inj.**

ANTIMETABOLITES

These are analogues related to normal components of DNA or of coenzymes involved in nucleic acid synthesis. They competitively inhibit utilization of the normal substrate or get themselves incorporated forming dysfunctional macromolecules.

1. Folate antagonist

Methotrexate (Mtx)

It is one of the oldest and highly efficacious antineoplastic drugs; inhibits dihydrofolate reductase (DHFRase)—blocking the conversion of dihydrofolic acid (DHFA) to tetrahydrofolic acid (THFA) which is an essential coenzyme required for one carbon transfer reactions in *de novo* purine synthesis and amino acid interconversions. The inhibition is pseudoirreversible because Mtx has 50,000 times higher affinity for the enzyme than the normal substrate.

Methotrexate has cell cycle specific action—kills cells in S phase; primarily inhibits DNA synthesis, but also affects RNA and protein synthesis. It exerts major toxicity on bone marrow—low doses given repeatedly cause megaloblastic anaemia, but high doses produce pancytopenia. Desquamation and bleeding may occur in g.i.t.

Methotrexate is absorbed orally, 50% plasma protein bound, little metabolized and largely excreted unchanged in urine. Salicylates, sulfonamides, dicumerol displace it from protein binding sites. Aspirin and sulfonamides enhance toxicity of Mtx by decreasing its renal tubular secretion.

The toxicity of Mtx cannot be overcome by folic acid, because it will not be converted to the active coenzyme form. However, *Folinic acid* (N5 formyl THFA, cirtrovorum factor) rapidly reverses the effects. Thymidine also counteracts Mtx toxicity.

Methotrexate is apparently curative in choriocarcinoma: 15–30 mg/day for 5 days orally or 20–40 mg/m² BSA i.m. or i.v. twice weekly. It is

highly effective in maintaining remission in children with acute leukaemias, but not good for inducing remission: 2.5–15 mg/day. It is also useful in other malignancies, rheumatoid arthritis, psoriasis and as immunosuppressant. **NEOTREXATE** 2.5 mg tab, 50 mg/2 ml inj; **BIOTREXATE** 2.5 mg tab, 5, 15, 50 mg/vial inj.

The use of folic acid *rescue* has permitted much higher doses of Mtx and has enlarged its scope to many difficult-to-treat neoplasms. A nearly 100 times higher dose (250–1000 mg/m² BSA) of Mtx is infused i.v. over 6 hours, followed by 3–15 mg i.v. calcium leucovorin within 3 hours, repeated as required. This procedure can be repeated weekly.

2. Purine antagonists

Mercaptopurine (6-MP) and thioguanine (6-TG)

These are highly effective antineoplastic drugs. They are converted in the body to the corresponding monoribonucleotides which inhibit the conversion of inosine monophosphate to adenine and guanine nucleotides. There is also feedback inhibition of *de novo* purine synthesis.

They are especially useful in childhood acute leukaemia, choriocarcinoma and have been employed in some solid tumours as well. In acute leukaemia, both have been used in combination regimens to induce remission and 6-MP to maintain it as well.

Azathioprine It has marked effect on T-lymphocytes; suppresses cell mediated immunity (CMI) and is used primarily as immunosuppressant in organ transplantation, rheumatoid arthritis, etc.

All antipurines are absorbed orally (though incompletely). Azathioprine and 6-MP are metabolized by xanthine oxidase; their metabolism is inhibited by allopurinol; dose has to be reduced to ¼–½ if allopurinol is given concurrently. Thioguanine is not a substrate for xanthine oxidase; follows a different (S-methylation) metabolic path and its dose need not be reduced if allopurinol is given.

Methylation by thiopurine methyl transferase (TPMT) is an additional pathway of 6-MP metabolism. Genetic deficiency of TPMT makes the individual more susceptible to 6-MP toxicity, while over expression of TPMT is an important mechanism of 6-MP resistance by acute leukaemia cells. Toxicity of azathioprine is also enhanced in TPMT deficiency.

The main toxic effect of antipurines is bone marrow depression, which develops slowly. Mercaptopurine causes more nausea and vomiting than 6-TG. It also produces a high incidence of reversible jaundice. Hyperuricaemia occurs with both; can be reduced by allopurinol. 6-Mercaptopurine: 2.5 mg/kg/day, half dose for maintenance; **PURINETHOL, EMPURINE 50 mg tab.** 6-Thioguanine: 100–200 mg/m²/day for 5–20 days; 6-TG 40 mg tab. Azathioprine: 3–5 mg/kg/day, maintenance 1–2 mg/kg/day; **IMURAN, TRANSIMUNE, AZOPRINE 50 mg tab.**

Fludarabine This newer purine antimetabolite is phosphorylated intracellularly to the active triphosphate form which then inhibits DNA polymerase as well as gets incorporated to form dysfunctional DNA. Tumour cell apoptosis is promoted by multiple mechanisms conferring activity even in slow growing neoplasm. It is indicated in chronic lymphatic leukaemia and non-Hodgkin's lymphoma that have recurred after treatment. Prominent adverse effects are chills, fever and vomiting after injection, myelosuppression and opportunistic infections. *Dose:* 25 mg/m² BSA daily for 5 days every 28 days by i.v. infusion **FLUDARA 50 mg/vial inj.**

3. Pyrimidine antagonists

Pyrimidine analogues have varied applications as antineoplastic, antifungal and antipsoriatic agents.

Fluorouracil (5-FU) is converted in the body to the corresponding nucleotide 5-fluoro-2-deoxyuridine monophosphate, which inhibits thymidylate synthase and blocks the conversion of deoxyuridilic acid to deoxythymidyllic acid. Selective failure of DNA synthesis occurs due to

non-availability of thymidylate: thymidine can partially reverse its toxicity. Fluorouracil itself gets incorporated into nucleic acids and this may contribute to its toxicity. Even resting cells are affected, though rapidly multiplying ones are more susceptible.

Dose: 1 g orally on alternate days (6 doses) then 1 g weekly or 12 mg/kg/day i.v. for 4 days—6 mg/kg i.v. on alternate days; **FLURACIL, FIVE FLURO 250 mg cap, 250 mg/5 ml for i.v. inj, also 1% topical solution.**

It has been particularly used for many solid tumours—breast, colon, urinary bladder, liver, etc. Topical application in cutaneous basal cell carcinoma has yielded gratifying results.

Cytarabine It is phosphorylated in the body to the corresponding nucleotide which inhibits DNA synthesis. The triphosphate of cytarabine is an inhibitor of DNA polymerase and blocks generation of cytidilic acid. However, it is now believed that its incorporation into DNA is more important for the expression of cellular toxicity. It also interferes with DNA repair. Cytarabine is cell cycle specific and acts primarily during S phase. Its main use is to induce remission in acute leukaemia in children, also in adults. Other uses are—Hodgkin's disease and non-Hodgkin lymphoma.

Dose: 1.5–3 mg/kg i.v. BD for 5–10 days (also by continuous i.v. infusion): **CYTARABIN, CYTROSAR, CYTABIN, 100, 500, 1000 mg inj.**

Both 5-FU and cytarabine exert primary toxicity on bone marrow and g.i.t. Genetic deficiency of dihydropyrimidine dehydrogenase (DPD) predisposes to severe 5-FU toxicity.

VINCA ALKALOIDS

These are mitotic inhibitors, bind to microtubular protein—'tubulin', prevent its polymerization and assembly of microtubules, cause disruption of mitotic spindle and interfere with cytoskeletal function. The chromosomes fail to move apart during mitosis: metaphase arrest occurs. They are cell cycle specific and act in the mitotic phase. Vincristine and vinblastine, though closely

related chemically, have somewhat different spectrum of antitumour activity and toxicity.

Vincristine (oncovin) It is a rapidly acting drug, very useful for inducing remission in childhood acute leukaemia, but is not good for maintenance therapy. Other indications are lymphosarcoma, Hodgkin's disease, Wilms' tumour, Ewing's sarcoma and carcinoma lung. Prominent adverse effects are peripheral neuropathy and alopecia. Bone marrow depression is minimal.

Dose: 1.5–2 mg/m² BSA i.v. weekly.

VINCRISTIN, CYTOCRISTIN 1 mg/vial inj.

Vinblastine It is primarily employed with other drugs in Hodgkin's disease and testicular carcinoma. Bone marrow depression is more prominent while neurotoxicity and alopecia are less marked than with vincristine.

Dose: 0.1–0.15 mg/kg i.v. weekly × 3 doses.

VINBLASTIN, CYTOBLASTIN 10 mg/vial inj.

TAXANES

Paclitaxel It is a complex diterpin taxane obtained from bark of the Western yew tree, which exerts cytotoxic action by a novel mechanism. It enhances polymerization of tubulin: a mechanism opposite to that of vinca alkaloids. The microtubules are stabilized and their depolymerization is prevented. This stability results in inhibition of normal dynamic reorganization of the microtubule network that is essential for vital interphase and mitotic functions. Abnormal arrays or 'bundles' of microtubules are produced throughout the cell cycle. Cytotoxic action of paclitaxel emphasizes the importance of tubulin-microtubule dynamic equilibrium.

The approved indications of paclitaxel are metastatic ovarian and breast carcinoma after failure of first line chemotherapy and relapse cases. It has also shown efficacy in advanced cases of head and neck cancer, small cell lung cancer, esophageal adenocarcinoma and hormone refractory prostate cancer.

Dose: 175 mg/m² by i.v. infusion over 3 hr, repeated every 3 weeks.

INTAXEL, PAXTAL 30 mg in 5 ml cremophor emulsion (polyoxyethylated castor oil + alcohol + water) per vial. Acute anaphylactoid reactions occur because of the cremophor solvent. Pretreatment with dexamethasone, H₁ and H₂ antihistaminics is routinely used to suppress the reaction.

The major toxicity is reversible myelosuppression and 'stocking and glove' neuropathy. Chest pain, arthralgia, myalgia, mucositis and edema can be troublesome.

Docetaxel More potent congener of paclitaxel with the same mechanism of action. It has been found effective in breast and ovarian cancer refractory to first line drugs. Small cell cancer lung, pancreatic, gastric and head/neck carcinomas are the other indications. Major toxicity is neutropenia, but neuropathy is less frequent. Arrhythmias, fall in BP and heart failure are also reported.

Dose: 100 mg/m² i.v. over 1 hr; repeat at 3 weeks.

DAXOTEL 20 mg, 80 mg inj.

EPIPODOPHYLLOTOXINS

Etoposide It is a semisynthetic derivative of podophyllotoxin, a plant glycoside. It is not a mitotic inhibitor, but arrests cells in the G₂ phase and causes DNA breaks by affecting DNA topoisomerase II function. While the cleaving of double stranded DNA is not interfered, the subsequent resealing of the strand is prevented. It has been primarily used in testicular tumours, lung cancer, Hodgkin's and other lymphomas, carcinoma bladder. Alopecia, leucopenia and g.i.t. disturbances are the main toxicity.

Dose: 50–100 mg/m²/day i.v. or oral for 5 days.

PELTASOL 100 mg in 5 ml inj., LASTET 25, 50, 100 mg cap, 100 mg/5 ml inj, ETOCID 50 mg cap, 100 mg/5 ml inj.

CAMPTOTHECIN ANALOGUES

Topotecan and *Irinotecan* are two recently introduced semisynthetic analogues of camptothecin, an antitumour principle obtained from a Chinese tree. They act in a manner similar to etoposide, but interact with a different enzyme (DNA

topoisomerase I). Their binding to this nuclear enzyme allows single strand breaks in DNA, but not its resealing after the strand has untwisted. They damage DNA during replication; act in the S phase and arrest cell cycle at G₂ phase.

Topotecan is used in metastatic carcinoma of ovary and small cell lung cancer after primary chemotherapy has failed. The major toxicity is bone marrow depression, especially neutropenia. Other adverse effects are pain abdomen, vomiting, anorexia and diarrhoea.

Dose: 1.5 mg/m² i.v. over 30 min daily for 5 days;
TOPOTEL 2.5 mg and 4.0 mg inj.

Irinotecan It is a prodrug; is decarboxylated in liver to the active metabolite. Cholinergic effects are produced in some patients because it inhibits AChE. These effects can be suppressed by prior atropinization. Irinotecan is indicated in metastatic/advanced colorectal carcinoma, cancer lung/cervix/ovary, etc. Dose limiting toxicity is diarrhoea; neutropenia, thrombocytopenia, haemorrhage, bodyache and weakness are the other adverse effects.

Individuals expressing the UGT1A1*28 allele of glucuronyl transferase enzyme are more susceptible to irinotecan induced diarrhoea and neutropenia.

Dose: 125 mg/m² i.v. over 90 min, weekly for 4 weeks.
IRINOTEL 40 mg (2 ml), 100 mg (5 ml) inj.

ANTIBIOTICS

These are products obtained from microorganisms and have prominent antitumour activity. Practically all of them intercalate between DNA strands and interfere with its template function.

Actinomycin D (Dactinomycin) It is a very potent antineoplastic drug, highly efficacious in Wilms' tumour and rhabdomyosarcoma. It has also produced good results in Mtx resistant choriocarcinoma and few other malignancies. Prominent adverse effects are vomiting, stomatitis, diarrhoea, erythema and desquamation of skin, alopecia and bone marrow depression.

Dose: 15 µg/kg i.v. daily for 5 days.
DACMOZEN 0.5 mg/vial inj.

Daunorubicin (Rubidomycin), Doxorubicin

These are antitumour antibiotics with quite similar chemical structures. However, utility of daunorubicin is limited to acute leukaemia (in which it is highly active) while doxorubicin, in addition, is effective in many solid tumours. They are capable of causing breaks in DNA strands by activating topoisomerase II and generating quinone type free radicals. They have mutagenic and carcinogenic potential. Maximum action is exerted at S phase, but toxicity is usually exhibited in G₂ phase.

Both these antibiotics produce cardiotoxicity as a unique adverse effect. This can manifest either acutely with ECG changes, arrhythmias and hypotension which are reversible, or be delayed—congestive heart failure (related to the total dose administered). CHF is due to cardiomyopathy and may be fatal. Marrow depression, alopecia, stomatitis, vomiting and local tissue damage (on extravasation) are other adverse effects.

Daunorubicin: 30–60 mg/m² BSA i.v. daily for 3 days, repeat weekly.

DAUNOCIN, DAUNOMYCIN 20 mg/vial inj.

Doxorubicin: 60–75 mg/m² BSA slow i.v. injection every 3 weeks; **ADRIAMYCIN, DOXORUBICIN, ONCODRIA 10 mg, 50 mg per vial inj.**

Mitoxantrone A recently introduced analogue of doxorubicin with lower cardiotoxicity, probably because it does not produce quinone type free radicals. It has a narrow range of utility: in acute nonhaemolytic leukaemia, chronic myelogenous leukaemia, non-Hodgkin lymphoma and carcinoma breast. Though cardiomyopathy can occur, major toxicity is marrow depression and mucosal inflammation.

ONCOTRON 20 mg/10 ml inj; 14 mg/m² single i.v. dose, repeat at 3 weeks.

Bleomycin This is a mixture of closely related glycopeptide antibiotics having potent antitumour activity. It chelates copper or iron, produces superoxide ions and intercalates between DNA strands—causes chain scission and inhibits repair. It is highly effective in testicular tumour and squamous cell carcinoma of skin, oral cavity, head and neck, genitourinary

tract and esophagus; also useful in Hodgkin's lymphoma.

Mucocutaneous toxicity and pulmonary fibrosis, but little myelosuppression are the special features.

Dose: 30 mg twice weekly i.v. or i.m. (total dose 300–400 mg); **BLEOCIN, ONCOBLEO 15 mg inj.**

Mitomycin C This highly toxic drug is used only in resistant cancers of stomach, cervix, colon, rectum, bladder, etc. It is transformed intracellularly to a form which acts as an alkylating agent and kills cells in G₁-M phases. Bone marrow and g.i.t. are the primary targets of toxicity.

Dose: 10 mg/m² BSA, infused i.v. in one day or divided in 5 and infused over 5 days. **MITOMYCIN-C 2, 10 mg inj.**

MISCELLANEOUS CYTOTOXIC DRUGS

These drugs (except L-asparaginase) have been developed by random synthesis and testing for antitumour activity.

Hydroxyurea It blocks the conversion of ribonucleotides to deoxyribonucleotides by inhibiting the enzyme ribonucleoside diphosphate reductase—thus interferes with DNA synthesis; exerts S-phase specific action. Its primary therapeutic value is in chronic myeloid leukaemia, psoriasis, polycythaemia vera and in some solid tumours. Myelosuppression is the major toxicity.

Dose: 20–30 mg/kg daily or 80 mg/kg twice weekly; **CYTODROX, HYDAB 500 mg cap.**

Procarbazine After metabolic activation (it is inactive as such), procarbazine depolymerizes DNA and causes chromosomal damage. Inhibition of nucleic acid synthesis also occurs. Because of damage to DNA, mutagenic and carcinogenic action is noted experimentally. Procarbazine is a component of the popular MOPP regimen for Hodgkin's disease. It is also useful in non-Hodgkin lymphomas and oat cell carcinoma of lung.

Procarbazine is a weak MAO inhibitor, produces some CNS effects and interacts with foods and drugs. Alcohol causes hot flushing and a disulfiram like reaction in patients receiving

procarbazine. Vomiting, leucopenia, thrombocytopenia and dermatitis are the prominent toxicities.

Dose: 100–300 mg oral daily; maintenance dose 1–2 mg/kg/day.

L-Asparaginase It was introduced on the basis of a qualitative difference observed between normal cells and those from childhood lymphoblastic leukemia—the leukaemia cells are deficient in L-asparagine synthase and depend on the supply of L-asparagine from the medium. The enzyme L-asparaginase (from *E. coli*) degrades L-asparagine to L-aspartic acid, depriving leukaemic cells of an essential metabolite—may cause cell death. However, the clinical response to L-asparaginase has been disappointing. Though, remission is induced in acute leukaemia, it is short lasting. Thus, it is now used when other drugs have failed to induce remission. It is ineffective in solid tumours.

Many of the typical adverse effects of anticancer drugs are not seen with L-asparaginase (no leucopenia, alopecia or mucosal damage); but it produces liver damage, pancreatitis and CNS symptoms (due to defective protein synthesis). Being a foreign protein, it produces allergic reactions in a significant percentage of patients—even anaphylaxis can occur.

Dose: 50–200 KU/kg i.v. daily for 2–4 weeks.

LEUNASE 10,000 KU per vial inj.

Cisplatin It is a platinum coordination complex that is hydrolysed intracellularly to produce a highly reactive moiety which causes cross linking of DNA. The favoured site is N⁷ of guanine residue. It can also react with –SH groups in proteins and has radiomimetic property. It is bound to plasma proteins, enters tissues and is slowly excreted unchanged in urine with a t_{1/2} about 72 hrs. Negligible amounts enter brain.

Cisplatin is very effective in metastatic testicular and ovarian carcinoma. It has found use in many other solid tumours as well.

It is administered by slow i.v. infusion 50–100 mg/m² BSA every 3–4 weeks; **CISPLATIN, CISPLAT, PLATINEX 10 mg/10 ml, 50 mg/50 ml vial.**

Cisplatin is a highly emetic drug. Antiemetics are routinely administered before infusing it. The most important toxicity is renal impairment which is dependent on total dose administered. Renal toxicity can be reduced by maintaining good hydration. Tinnitus, deafness, neuropathy and hyperuricaemia are other problems. Shock like state sometimes occurs during i.v. infusion.

Carboplatin It is a less reactive second generation platinum compound that is better tolerated and has a toxicity profile different from cisplatin. Nephrotoxicity, ototoxicity and neurotoxicity are low. Nausea and vomiting is milder and is delayed: only infrequently limits the dose. The dose-limiting toxicity is thrombocytopenia and less often leucopenia. Because of less plasma protein binding, it is rapidly eliminated by the kidney ($t_{1/2}$ 4–6 hr). It is primarily indicated in ovarian carcinoma of epithelial origin, and has shown promise in squamous carcinoma of head and neck, small cell lung cancer and seminoma. **ONCOCARBIN** 150 mg inj, **KEMOCARB** 150, 450 mg/vial inj. 400 mg/m² as an i.v. infusion over 15–60 min, to be repeated only after 4 weeks.

Imatinib This novel antineoplastic drug inhibits the tyrosine protein kinases in chronic myeloid leukaemia (CML) cells and the ones that are activated by platelet derived growth factor (PDGF) receptor, stem cell receptor and *c-kit* receptor found in gastrointestinal stromal tumour (GIST), a rare tumour. Striking success has been obtained in chronic phase of CML as well as in accelerated phase, and in metastatic *kit*-positive GIST. Adverse effects are fluid retention, edema, vomiting, abdominal pain, myalgia and liver damage.

Dose: 400 mg/day with meal; accelerated phase of CML 600–800 mg/day.

IMATIB- α , **SHANTINIB** 100 mg cap.

HORMONES

They are not cytotoxic, but modify the growth of hormone-dependent tumours. All hormones are only palliative.

Glucocorticoids They have marked lympholytic action—are primarily used in acute child-

hood leukaemia and lymphomas. They induce remission rapidly but relapses inevitably occur after variable intervals and gradually the responsiveness is lost. Considerable palliative effects are obtained in Hodgkin's disease. Glucocorticoids have a secondary role in some hormone responsive breast cancers.

Corticosteroids are also valuable for the control of complications like hypercalcaemia, haemolysis, bleeding due to thrombocytopenia, increased intracranial tension and mediastinal edema due to radiotherapy. Moreover, they afford symptomatic relief by antipyretic and mood elevating action and potentiate the antiemetic action of ondansetron/metoclopramide. Prednisolone/dexamethasone are most commonly used; doses are high—hypercorticism may occur (*see* Ch. 20).

Estrogens They produce symptomatic relief in carcinoma prostate (*see* p. 303), which is an androgen-dependent tumour. However, relapses occur, but life is prolonged. Estrogens have been superseded in carcinoma prostate by GnRH agonists used with an antiandrogen.

Fosfestrol It is the phosphate derivative of stilbestrol; has been specifically used in carcinoma prostate. *Dose:* 600–1200 mg i.v. initially, maintenance 120–240 mg orally. **HONVAN** 120 mg tab, 300 mg/5 ml inj.

Selective estrogen receptor modulators
(tamoxifen)

Selective estrogen receptor down regulators
(fulvestrant)

Aromatase inhibitors (letrozole, etc).

The above three classes of drugs are the sheet anchor of adjuvant and palliative therapy of carcinoma breast, as well as for primary and secondary prevention of breast cancer (*see* Ch. 22).

Antiandrogen Flutamide and bicalutamide (*see* p. 294) antagonise androgen action on prostate carcinoma and have palliative effect in advanced/metastatic cases. Because they increase androgen levels, combination with orchiectomy or GnRH analogues is required to produce full therapeutic effect.

5- α reductase inhibitor Finasteride and dutasteride (*see p. 294*) inhibit conversion of testosterone to dihydrotestosterone in prostate (and other tissues), have palliative effect in advanced carcinoma prostate; occasionally used.

GnRH agonists (*see p. 239*) They indirectly inhibit estrogen/androgen secretion by suppressing FSH and LH release from pituitary and have palliative effect in advanced estrogen/androgen dependent carcinoma breast/prostate. They are generally used in combination with antiandrogens or SERMS.

Progestins (*see p. 310*) They bring about temporary remission in some cases of advanced, recurrent (after surgery/radiotherapy) and metastatic endometrial carcinoma. High doses are needed. They have also been used in palliative treatment of metastatic carcinoma breast that has become unresponsive to tamoxifen.

GENERAL PRINCIPLES IN CHEMOTHERAPY OF CANCER

1. In cancer chemotherapy, analogy is drawn with bacterial chemotherapy; the malignant cell being viewed as an invader. However, there are two main differences—

- (a) Bacterial metabolism differs markedly from that of the host, while malignant cells are in fact host cells with deranged regulation of growth and differentiation and only minor other differences. Therefore, selectivity of drugs is limited. A number of measures which enhance selectivity of drugs for the tumour need to be exploited. However, lately some unique tumour antigens and oncogenes (like the CML-tyrosine protein kinase gene) have been identified, which provide specific targets for drug therapy.
- (b) Infecting microorganisms are amenable to immunological and other host defence mechanisms. This is absent or minimal against cancer cells.

Human interferon α -2 (*see p. 779*) and other cytokines (interleukin-2, tumour necrosis factor, etc.) that can modify the biological responses to tumour cells are being used as adjuvants in treating neoplasms. They appear to have some direct inhibitory effect on malignant cells, in addition to reinforcing immunological defence against these.

2. A single clonogenic malignant cell is capable of producing progeny that can kill the host. To effect cure, all malignant cells must be killed or removed. Survival time is related to the number of cells that escape chemotherapeutic attack.

3. In any cancer, subpopulations of cells differ in their rate of proliferation and susceptibility to cytotoxic drugs. These drugs kill cancer cells by first order kinetics, i.e. a certain fraction of cells present are killed by one treatment.

4. Drug regimens or number of cycles of combined chemotherapy which can effectively palliate large tumour burdens may be curative when applied to minute residual tumour cell population after surgery and/or irradiation. This is the basis of the combined modality approach (*see Fig. 62.1*).

5. Whenever possible, complete remission should be the goal of cancer chemotherapy: drugs are often used in maximum tolerated doses. Intensive regimens used earlier yield better results.

6. Formerly cancers were treated with one drug at a time. Now a combination of 2–5 drugs is given in intermittent pulses to achieve *total tumour cell kill*, giving time in between for normal cells to recover (*Fig. 62.1*).

Synergistic combinations and rational sequences are devised by utilizing:

- (a) Drugs which are effective when used alone.
- (b) Drugs with different mechanisms of action.
- (c) Drugs with differing toxicities.
- (d) Empirically by trial and error; optimal schedules are mostly developed by this procedure.
- (e) Drugs with different mechanisms of resistance.
- (f) Drugs with known synergistic biochemical interactions.

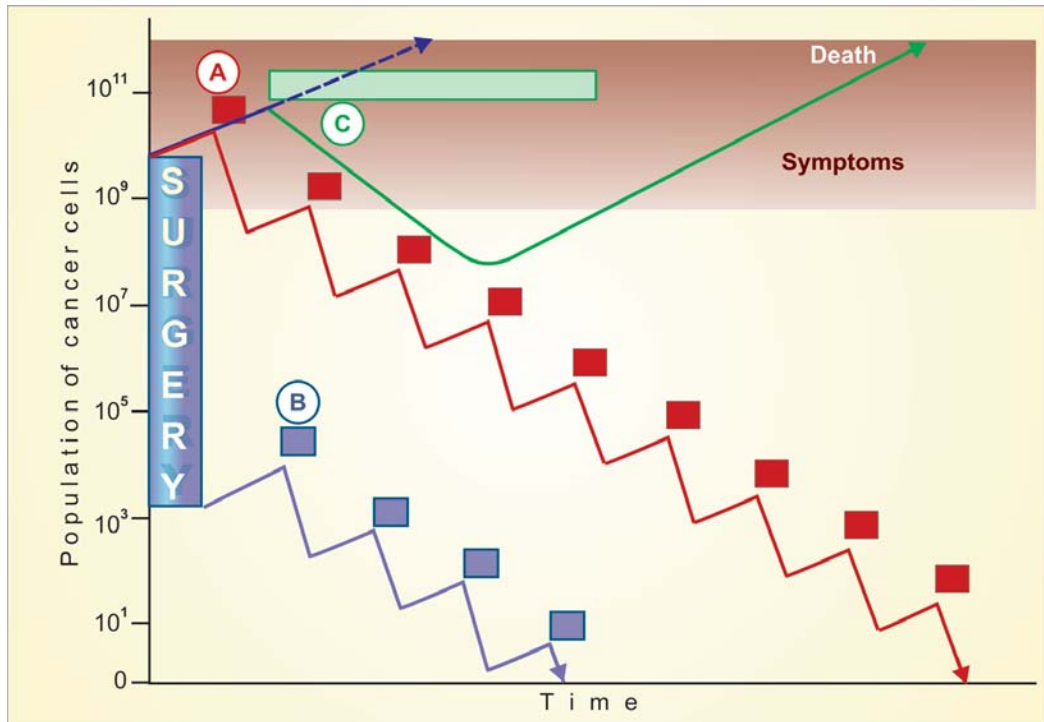

Fig. 62.1: Illustration of cancer cell dynamics with three chemotherapeutic approaches. The shaded area depicts symptoms, before which the cancer remains subclinical. The broken green line indicates no treatment.

A. A rationally designed combination of 2–5 chemotherapeutic drugs (red bar) is given cyclically. Each cycle kills 99% tumour cells, reducing the tumour cell mass by 2 log units each time. Some regrowth occurs during the rest interval, but the rate of cell kill is more than regrowth and resistance does not develop. If the cycles are continued well beyond all symptoms disappear, cure may be achieved. Radiation may be used to supplement chemotherapy.

B. The cancer (in case of solid tumours) is resected surgically and the small number of residual cancer cells (at the primary site or in metastasis) are killed by relatively few cycles of adjuvant combination chemotherapy (purple bar). This may be supplemented by radiation (in case of radiosensitive tumours).

C. The chemotherapy is begun relatively late with a single but effective drug given continuously (blue bar). It causes slower tumour cell kill, but symptom relief may occur. Resistance soon develops, and the tumour starts regrowing even with continued chemotherapy. Symptoms reappear and increase in severity. Ultimately failure of therapy and death occur.

(g) *Kinetic scheduling:* On the basis of cell cycle specificity/nonspecificity of the drugs and the phase of cell cycle (*see box*) at which the drug exerts its toxicity.

Cytotoxic drugs are either cell cycle specific (CCS) or cell cycle nonspecific (CCNS).

(a) *Cell cycle nonspecific* Kill resting as well as dividing cells, e.g. nitrogen mustard, cyclophosphamide, chlorambucil, carmustine, dacarbazine, busulfan, L-asparaginase, cisplatin, procarbazine, actinomycin D.

(b) *Cell cycle specific* Kill only actively dividing cells. Their toxicity is generally expressed in S phase. However, these drugs may show considerable phase selectivity, e.g.—

G₁: Vinblastine.

S: Mtx, cytarabine, 6-TG, 6-MP, 5-FU, hydroxyurea, mitomycin C, doxorubicin, daunorubicin.

G₂: Daunorubicin, bleomycin, etoposide, topotecan.

M: Vincristine, vinblastine, paclitaxel, docetaxel.

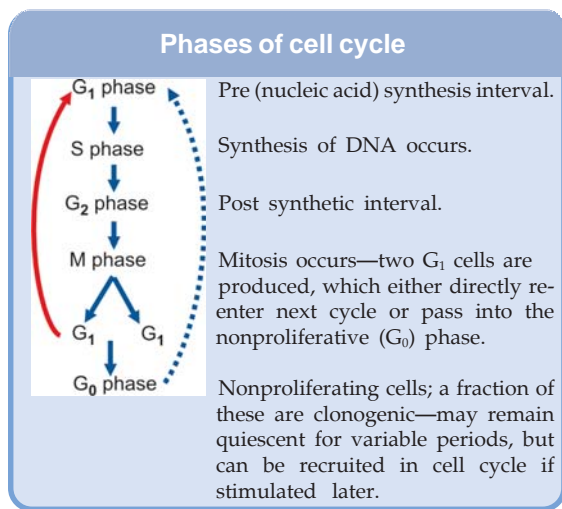

It is logical to use cell cycle specific drugs in short courses (pulses) of treatment. This allows non-cycling cells (which are generally less susceptible to drugs) to re-enter the cycle between drug courses. The CCS drugs are generally scheduled after a course of CCNS drug(s) to improve the cell kill. The CCS drugs are more effective in haematological malignancies and in solid tumours with a large growth fraction, while the CCNS drugs are effective in these as well as in solid cancers with a small growth fraction.

Many regimens have been devised by taking into consideration the above factors and by observing patient response.

One popular combination has been the MOPP regimen, which has yielded over 80% response rate in Hodgkin's disease. It is illustrated in Fig. 62.2. For optimum remission 6–11 cycles may be needed. Maintenance therapy thereafter does not produce additional benefit.

Another combination that has produced almost 100% response in Ewing's sarcoma is illustrated in Fig. 62.3.

Similarly many other regimens have been devised for different tumours.

VAMP: Vincristine + Amethopterin (Mtx) + 6-MP + Prednisolone: used in acute leukaemia.

COAP: Cyclophosphamide + Oncovin (Vincristine) + Ara-C (Cytarabine) + Prednisolone.

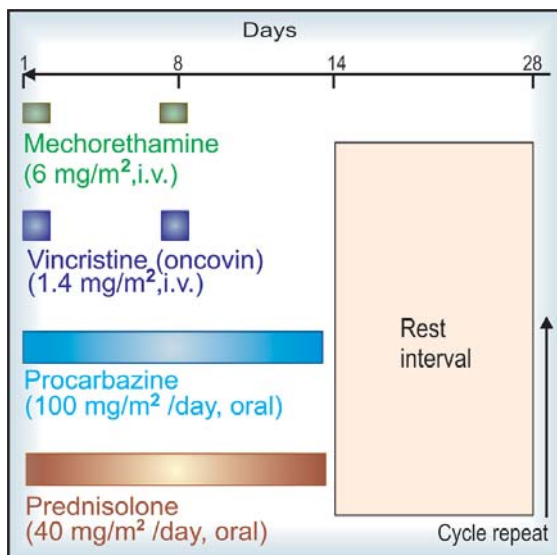

Fig. 62.2: MOPP regimen for Hodgkin's disease

POMP: Prednisolone + Oncovin + Mtx + Purinethol (6-MP).

CART: Cytarabine + Asparaginase + Rubidomycin (Daunorubicin) + 6-TG.

BACOP: Bleomycin + Adriamycin (Doxorubicin) + Cyclophosphamide + Vincristine + Prednisolone.

7. Tumours often become resistant to any drug that is used repeatedly due to selection of less responsive cells. Such selection is favoured if low dose of a single drug is used.

Several mechanisms of tumour resistance have been recognized. Mutations altering the target biomolecule confer specific (to single drug) resistance. An important mechanism of multidrug resistance is overexpression of MDR 1 gene which increases the concentration of P-glycoprotein (an efflux transporter) on the surface of cancer cells, resulting in pumping out of the chemotherapeutic agents, especially natural products like vinca alkaloids, anthracycline antibiotics, taxanes, etc.

The currently preferred drugs in chemotherapy-responsive malignancies are listed in Table 62.1.

Toxicity amelioration

High doses and intensive regimens are being employed aiming at cure of the malignancy. The

Table 62.1: Current choice of drugs in malignancy

<i>Malignancy</i>	<i>First line drugs</i>	<i>Second line drugs</i>
1. Acute (Induction) leukaemias (Maintenance)	VAMP combination Daunorubicin, 6-TG, 6-MP Cyclophosphamide	Cytarabine l-Asparaginase, Mtx, Doxorubicin
2. Ch. lymphatic leukaemia	Chlorambucil, Fludarabine Cyclophosphamide Prednisolone	Cytarabine, Doxorubicin
3. Ch. myeloid leukaemia	Busulfan, Imatinib Mitoxantrone, Interferon	6-MP, 6-TG, Hydroxyurea, Vincristine Cyclophosphamide, Melphalan
4. Hodgkin's disease	MOPP combination Vinblastine, Dacarbazine	Bleomycin, Procarbazine Lomustine, Ifosphamide Doxorubicin, Cytarabine, Prednisolone
5. Multiple myeloma	Melphalan, Prednisolone Cyclophosphamide	Carmustine, Doxorubicin, Chlorambucil, Vincristine
6. Ewing's sarcoma	Doxorubicin, Vincristine Actinomycin D Cyclophosphamide	Carmustine Daunorubicin
7. Wilms' tumour	Actinomycin D Vincristine	Cyclophosphamide, Mtx Doxorubicin
8. Choriocarcinoma	Mtx., Etoposide Cisplatin	6-MP, Chlorambucil, Doxorubicin Vinblastine
9. Prostate carcinoma	Bicalutamide/Flutamide + GnRH agonist (orchiectomy)	Doxorubicin, Cisplatin, 5-FU Cyclophosphamide
10. Breast carcinoma	Tamoxifen, Mtx., 5-FU Letrozole, Fulvestrant	Prednisolone, Vincristine, Paclitaxel, Docetaxel Cyclophosphamide, Mitoxantrone
11. Ovarian carcinoma	Cisplatin, Carboplatin, Paclitaxel, Cyclophosphamide, Doxorubicin	Melphalan, Chlorambucil, 5-FU, Mtx., Vincristine, Topotecan
12. Ca. endometrium	Progestin, Tamoxifen	Doxorubicin, Cisplatin
13. Testicular tumours	Mtx., Bleomycin, Etoposide Cisplatin, Carboplatin	Actinomycin D, Ifosphamide Doxorubicin, Vinblastine, Melphalan
14. Cancer lung (small cell)	Cyclophosphamide Vincristine, Doxorubicin	Mustine HCl, Carboplatin Mtx., Lomustine, Topotecan, Docetaxel Etoposide
15. Carcinoma cervix	Mitomycin C, Cisplatin Mtx., Carboplatin	Cyclophosphamide, Bleomycin, Lomustine, Irinotecan, Vincristine Doxorubicin
16. Osteogenic sarcoma	Mtx. with rescue Doxorubicin, Vincristine	Cisplatin, Ifosphamide Dacarbazine

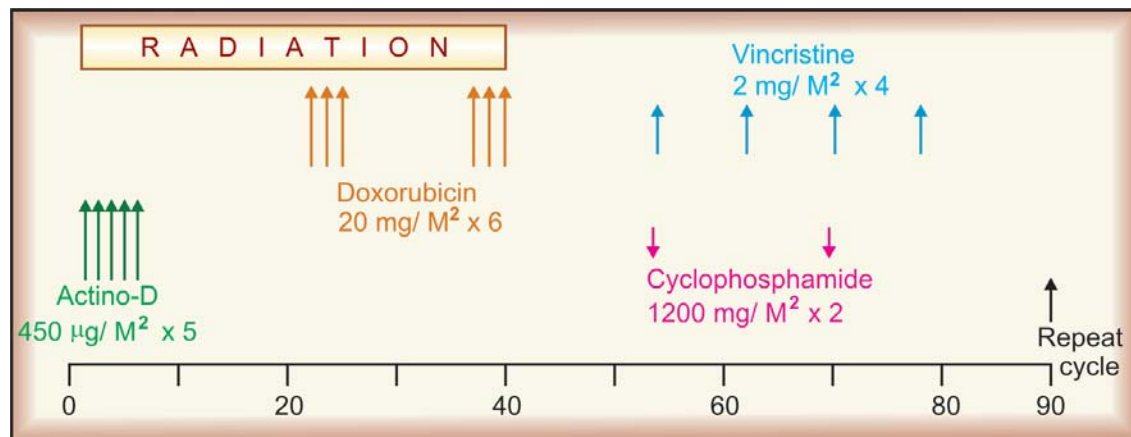

Fig. 62.3: Combined modality treatment for Ewing's sarcoma

associated toxicity may be ameliorated to some extent by—

1. Toxicity blocking drugs: *Folinic acid* rescue has permitted administration of > 100 fold dose of Mtx (see p. 823). It is professed that normal cells are rescued more than the cancer cells—therapeutic index is increased.

- Cystitis caused by cyclophosphamide and ifosphamide can be blocked by systemically administered *mesna* and by irrigating the bladder with *acetylcysteine*. Both these are -SH containing compounds that combine with and detoxify the toxic metabolites in the bladder. Generous fluid intake and frequent bladder voiding also helps.

- For controlling cytotoxic drug induced vomiting, *ondansetron*, a 5-HT₃ antagonist, has surpassed the efficacy of metoclopramide, which nevertheless is still used (see Ch. 47). Addition of dexamethasone and/or lorazepam further enhances the protection against vomiting.

2. Hyperuricaemia occurring as a consequence of rapid destruction of bulky tumour masses and degradation of large amount of purines can be reduced by *allopurinol*, alkalization of urine and plenty of fluids. Corticosteroids also reduce hyperuricemia.

3. Hypercalcaemia occurring as a complication of certain malignancies like myeloma, cancer breast/prostate, etc. may be aggravated by chemotherapy. It is treated by vigorous hydration and i.v. bisphosphonates (see Ch. 24).

4. Drugs given in pulses with 2–3 week intervals for normal cells to recover improve the efficacy of therapy: malignant cells recovering more slowly.

5. Selective exposure of tumour to the drug by intraarterial infusion into a limb or head and neck; intrapleural/intraperitoneal injection—especially for rapidly accumulating pleural effusion or ascitis; topical application on the lesion—on skin, buccal mucosa, vagina, etc. may reduce systemic toxicity.

6. Platelet and/or granulocyte transfusion after treatment—to prevent bleeding or infection.

7. Use of *biological response modifiers* like recombinant GM-CSF/G-CSF hastens recovery from cytotoxic drug induced myelosuppression.

Molgramostim (LEUCOMAX 150, 300, 400 µg/vial for s.c./i.v. inj) is a colony stimulating factor. Injected daily beginning one day after last dose of myelosuppressant chemotherapy, it hastens recovery of neutrophil count.

Interleukin-2 (IL-2) is a cytokine biological response modifier that itself has antitumour property by amplifying killer T-cell response.

8. Bone marrow transplantation after treatment with high doses of myelosuppressant drugs.
9. *Thalidomide* (banned in 1960 for its teratogenic effect) has anxiolytic, antiemetic, adjuvant analgesic/antipyretic properties and has been found to counteract cancer associated cachexia. It probably acts by suppressing TNF α and by modulating IL-2.

Miscellaneous Drugs

SECTION
14

CHAPTER 63

Immunosuppressant Drugs, Gene Therapy

IMMUNOSUPPRESSANT DRUGS

These are drugs which inhibit cellular/humoral or both immune response and have their major use in organ transplantation and autoimmune diseases. The drugs are:

1. **Calcineurin inhibitors** (Specific T-cell inhibitors)
Cyclosporine (Ciclosporin), Tacrolimus
2. **Antiproliferative drugs** (Cytotoxic drugs)
Azathioprine, Cyclophosphamide,
Methotrexate, Chlorambucil,
Mycophenolate mofetil (MMF)
3. **Glucocorticoids**
Prednisolone and others
4. **Antibodies**
Muromonab CD3, Antithymocyte globulin
(ATG), Rho (D) immunoglobulin

The development of immune response and the sites of action of different immunosuppressants is summarized in Fig. 63.1.

Calcineurin inhibitors (Specific T-cell inhibitors)

Cyclosporine It is a cyclic polypeptide with 11 amino acids, obtained from a fungus and introduced in 1977 as a highly selective immunosuppressant which has markedly increased the

success of organ transplantations. It profoundly and selectively inhibits T lymphocyte proliferation, IL-2 and other cytokine production and response of inducer T cells to IL-1, without any effect on suppressor T-cells. Lymphocytes are arrested in G_0 or G_1 phase.

The CD4 molecule associated with T cell receptor on helper T cells anchors the major histocompatibility complex class II (MHC II) carrying the antigen peptide so that it is able to activate the T cell receptor (Fig. 63.2). Stimulation of T cell receptor produces a cascade of Ca^{2+} dependent events and protein kinase C (PKC) activation. The Ca^{2+} ions after binding to calmodulin activate a membrane associated serine/threonine phosphatase called *calcineurin* which dephosphorylates regulatory protein 'nuclear factor of activated T-cell' (NFAT), permitting its intranuclear migration and transcription of cytokine genes leading to production of IL-2 along with other interleukins, GM-CSF, $TNF\alpha$, interferon, etc. Cyclosporine enters target cells and binds to *cyclophilin*, an immunophilin class of protein. The complex then binds to and inactivates calcineurin \rightarrow response of the helper T cell to antigenic stimulation fails. Cyclosporine also enhances expression of an inhibitor of IL-2 which attenuates IL-2 stimulated T-cell proliferation and production of killer lymphocytes. Cyclosporine

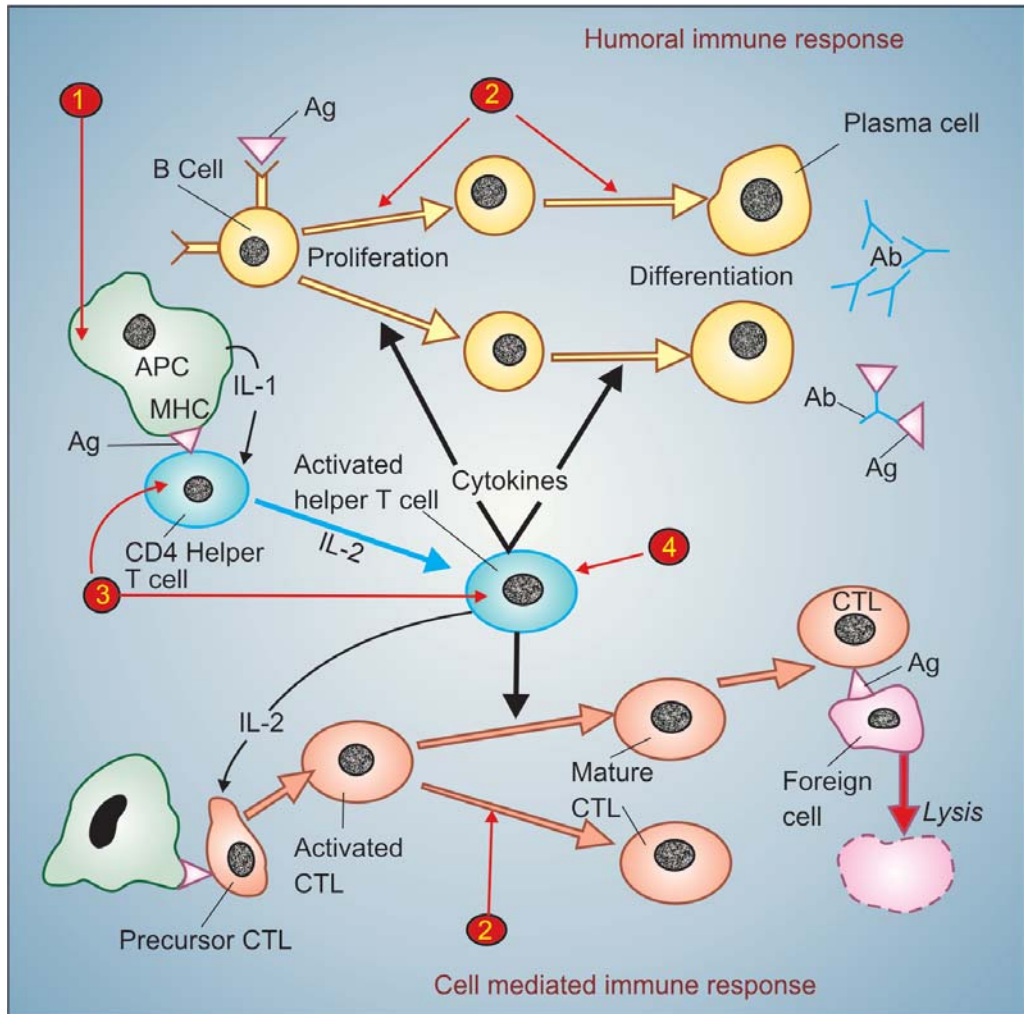

Fig. 63.1: Generation of humoral and cell-mediated immune response and sites of action of immunosuppressant drugs

The antigen (Ag) is processed by macrophages or other antigen presenting cells (APC), coupled with class II major histocompatibility complex (MHC) and presented to the CD4 helper cell which are activated by interleukin-1 (IL-1), proliferate and secrete cytokines—these in turn promote proliferation and differentiation of antigen activated B cells into antibody (Ab) secreting plasma cells. Antibodies finally bind and inactivate the antigen.

In cell-mediated immunity—foreign antigen is processed and presented to CD4 helper T cell which elaborate IL-2 and other cytokines that in turn stimulate proliferation and maturation of precursor cytotoxic lymphocytes (CTL) that have been activated by antigen presented with class I MHC. The mature CTL (Killer cells) recognize cells carrying the antigen and lyse them.

1. Glucocorticoids inhibit MHC expression and IL-1, IL-2, IL-6 production so that helper T-cells are not activated.
2. Cytotoxic drugs block proliferation and differentiation of T and B cells.
3. Cyclosporine and tacrolimus inhibit antigen stimulated activation and proliferation of helper T cells as well as expression of IL-2 and other cytokines by them.
4. Antibodies like muromonab CD3, antithymocyte globulin specifically bind to helper T cells, prevent their response and deplete them.

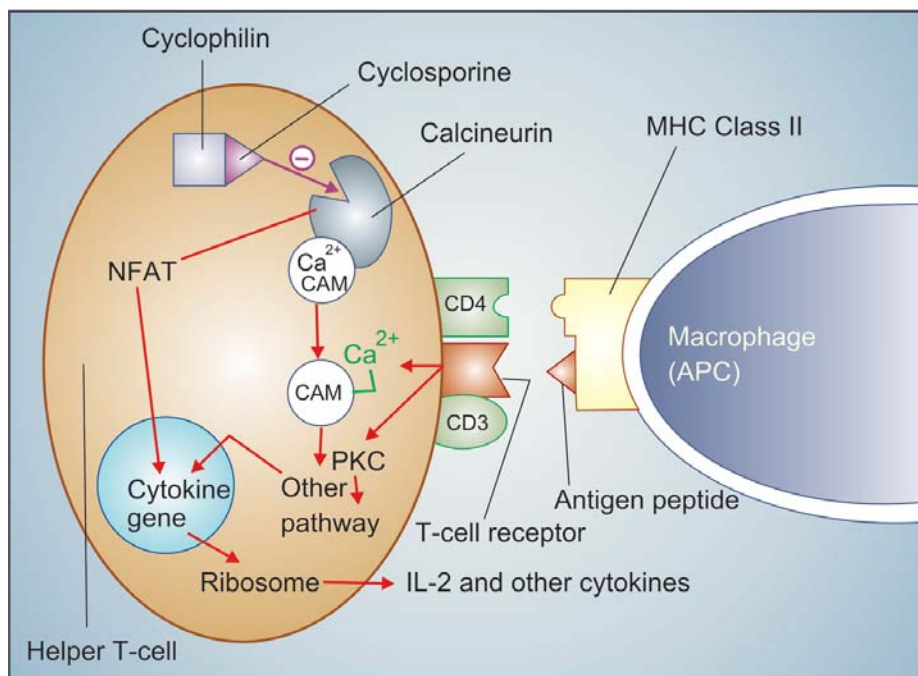

Fig. 63.2: Interaction between macrophage antigen presenting cell (APC) and helper T-cell in the immune response and mechanism of action of cyclosporine.

Cyclosporine binds to an intracellular protein 'Cyclophilin' and this complex inhibits Ca^{2+} -Calmodulin (Ca^{2+} -CAM) activated enzyme 'Calcineurin'. Normally, after activation through T-Cell receptor calcineurin activates cytokine genes through a 'Nuclear factor of activated T-cells' (NFAT) resulting in transcription of cytokine genes and production of IL-2 and other cytokines. These pathways become unoperational in the presence of cyclosporine

is most active when administered before antigen exposure, but can, in addition, suppress the responses of primed helper T cells; hence useful in autoimmune diseases as well.

Cyclosporine selectively suppresses cell-mediated immunity, prevents graft rejection and yet leaves the recipient with enough immune activity to combat bacterial infection. Unlike cytotoxic immunosuppressants, it is free of toxic effects on bone marrow and RE system. Humoral immunity remains intact. However, it is nephrotoxic—the major limitation, and impairs liver function. Other adverse effects are sustained rise in BP, precipitation of diabetes, anorexia, lethargy, hyperkalaemia, opportunistic infections, hirsutism, gum hyperplasia, tremor and seizures.

Cyclosporine is the most effective drug for prevention and treatment of graft rejection reaction. It is routinely used in renal, hepatic, cardiac, bone marrow and other transplantations. For induction it is started orally 12 hours before the transplant and continued for as-long-as needed. When graft rejection has started, it can be given i.v., because oral bioavailability is low, dependent on presence of bile and is highly variable. It is concentrated in WBCs and RBCs, metabolized in liver by CYP3A4 and excreted in bile. The plasma $t_{1/2}$ is biphasic 4–6 hr and 12–18 hr.

Dose: 10–15 mg/kg/day with milk or fruit juice till 1–2 weeks after transplantation, gradually reduced to maintenance dose of 2–6 mg/kg/day. Therapy may be started with 3–5 mg/kg i.v. infusion.

IMUSPORIN 25, 50, 100 mg soft gelatin cap. Absorption from this preparation is slower and more variable. A newer microemulsion formulation **SANDIMMUN NEORAL, PANIMUN BIORAL 25, 50, 100 mg caps**, has more consistent bioavailability. For i.v. use cyclosporine is dispersed in cremaphor emulsion: **SANDIMMUN, PANIMUN 100 mg/ml inj in 1 ml, 5 ml, 50 ml vial**, which is diluted and infused over 4–6 hours. An acute reaction consisting of chills, fever, bodyache and dyspnoea often occurs because of the solvent; i.v. cyclosporine is used only in emergency, and is substituted by oral medication as soon as possible.

Cyclosporine is a second line drug in autoimmune diseases, like severe rheumatoid arthritis, uveitis, bronchial asthma, inflammatory bowel disease, dermatomyositis, etc. and in psoriasis, especially to suppress acute exacerbations. It is often used along with corticosteroids or Mtx. Good results have been obtained in some cases of aplastic anaemia. For these conditions, lower doses (2–5 mg/kg/day) are needed and adverse effects are mild. However, it is not curative and relapses occur when the drug is withdrawn.

Drug interactions with a large number of drugs occur. All nephrotoxic drugs like aminoglycosides, vancomycin, amphotericin B and NSAIDs enhance its toxicity. By depressing renal function, it can reduce excretion of many drugs. Phenytoin, phenobarbitone, rifampin and other enzyme inducers lower its blood levels so that transplant rejection may result. On the other hand, CYP3A4 inhibitors erythromycin, ketoconazole and related drugs inhibit its metabolism to increase bioavailability and cause toxicity. Pot. supplements and K⁺ sparing diuretics can produce marked hyperkalaemia in patients on cyclosporine.

Tacrolimus (FK506) It is a newer immunosuppressant chemically different from cyclosporine, but having the same mechanism of action, and is ~100 times more potent. It binds to a different cytoplasmic immunophilin protein labelled 'FKBP', but the subsequent steps are the same, i.e. inhibition of helper T cells *via* calcineurin.

Tacrolimus is administered orally as well as by i.v. infusion. Oral absorption is variable and decreased by food. It is metabolized by CYP3A4

and excreted in bile with a longer $t_{1/2}$ of 12 hour. Therapeutic application, clinical efficacy as well as toxicity profile are similar to cyclosporine. It is particularly valuable in liver transplantation because its absorption is not dependent on bile. Because of more potent action, it is also suitable for suppressing acute rejection that has set in. Hypertension, hirsutism and gum hyperplasia are less marked than cyclosporine, but tacrolimus is more likely to precipitate diabetes, cause neurotoxicity, alopecia and diarrhoea. Dose limiting toxicity is renal.

Dose: 0.05–0.1 mg/kg BD oral (for renal transplant), 0.1–0.2 mg/kg BD (for liver transplant).

TACROMUS, PANGRAF 1, 5 mg cap.

Antiproliferative drugs

(Cytotoxic immunosuppressants)

Certain cytotoxic drugs used in cancer chemotherapy exhibit prominent immunosuppressant action, mainly by preventing clonal expansion of T and B lymphocytes (*see* Fig. 63.1).

Azathioprine (*see* p. 823) It is a purine antimetabolite which has more marked immunosuppressant than antitumour action. The basis for this difference is not clear, but may be due to its selective uptake into immune cells and intracellular conversion to the active metabolite 6-mercaptopurine, which then undergoes further transformations to inhibit *de novo* purine synthesis and damage to DNA. It selectively affects differentiation and function of T cells and inhibits cytolytic lymphocytes; cell-mediated immunity is primarily depressed.

The most important application of azathioprine is prevention of renal and other graft rejection, but it is less effective than cyclosporine; generally combined with it or used in patients developing cyclosporine toxicity. It has also been used in progressive rheumatoid arthritis and some other autoimmune diseases.

Cyclophosphamide (*see* p. 822) This cytotoxic drug has more marked effect on B cells and humoral immunity compared to that on T cells and cell-mediated immunity. It has been parti-

cularly utilized in bone marrow transplantation in which a short course with high dose is generally given. In other organ transplants it is employed only as a reserve drug. In rheumatoid arthritis, it is rarely used, only when systemic manifestations are marked. Low doses are occasionally employed for maintenance therapy in pemphigus, systemic lupus erythematosus and idiopathic thrombocytopenic purpura.

Methotrexate (Mtx. *see* p. 823) This folate antagonist is a potent immunosuppressant which markedly depresses cytokine production and cellular immunity, and has antiinflammatory property. It has been used as a first line drug in many autoimmune diseases like rapidly progressing rheumatoid arthritis (*see* p. 203), severe psoriasis, pemphigus, myasthenia gravis, uveitis, chronic active hepatitis. Low dose Mtx maintenance therapy is relatively well tolerated.

Chlorambucil It has relatively weak immunosuppressant action which is sometimes utilized in autoimmune diseases and transplant maintenance regimens.

Mycophenolate mofetil (MMF) It is a new immunosuppressant; prodrug of mycophenolic acid which selectively inhibits *inosine monophosphate dehydrogenase* an enzyme essential for *de novo* synthesis of guanosine nucleotides in the T and B cells (these cells, unlike others, do not have the purine salvage pathway). Lymphocyte proliferation, antibody production and cell-mediated immunity are inhibited. As 'add on' drug to cyclosporine + glucocorticoid in renal transplantation, it has been found as good or even superior to azathioprine, but should not be combined with azathioprine. It can help to reduce the dose of cyclosporine and thus its toxicity. Vomiting, diarrhoea, leucopenia and predisposition to CMV infection, g.i. bleeds are the prominent adverse effects.

Dose: 1.0 g BD oral; **CELLMUNE, MYCEPT, MYCOFIT** 250, 500 mg tab/cap.

Glucocorticoids (*see* Ch. 20)

Glucocorticoids have potent immunosuppressant and antiinflammatory action, inhibit several components of the immune response (*see* p. 279). They particularly inhibit MHC expression (Fig. 63.1) and proliferation of T lymphocytes. Expression of several IL and other cytokine genes is regulated by corticosteroids and production of adhesion molecules is depressed. The short-lived rapid lymphopenic effect of steroids is due to sequestration of lymphocytes in tissues. Accordingly, they have a more marked effect on CMI.

The corticosteroids are widely employed as companion drug to cyclosporine in various organ transplants. In case graft rejection sets in—large doses of corticoids i.v. are employed for short periods. They are used in practically all cases of severe autoimmune diseases, especially during exacerbation. Long-term complications are the greatest limitations of steroid use.

Immunosuppressant antibodies

Muromonab CD3 It is a murine monoclonal antibody against the CD3 glycoprotein located near to the T cell receptor on helper T cells (*see* Fig. 63.2). Binding of muromonab CD3 to the CD3 antigen obstructs the binding of MHC II-antigen complex to the T cell receptor: antigen recognition is interfered, so that participation of T cells in the immune response is prevented and T cells rapidly disappear from circulation leading to an immune blocked state. The response to this monoclonal antibody is less variable than to the polyclonal antithymocyte globulin. It is also less likely to produce allergic reactions.

Muromonab CD3 has been used as induction therapy together with corticosteroids and azathioprine with delayed use of cyclosporine in 'sequential regimen' for organ transplantation. This serves to postpone potential nephro- and hepatotoxicity of cyclosporine. This sequential regimen has been found to be more effective than the standard triple therapy in renal and hepatic, but not in cardiac transplant recipients. It is also valuable for steroid-resistant rejection reactions and has been used to deplete T cells from the donor bone marrow before transplantation.

The initial doses of muromonab CD3 are associated with 'cytokine release' syndrome with flu like symptoms: chills, rigor and wheezing. Occasionally aseptic meningitis, intragraft thrombosis, pulmonary edema, seizures and a shock like state are produced. High dose corticosteroid pretreatment reduces the reaction.

Antithymocyte globulin (ATG) It is a polyclonal antibody purified from horse or rabbit immunized with human thymic lymphocytes which binds to T lymphocytes and depletes them. It is a potent immunosuppressant and has been used primarily to suppress acute allograft rejection episodes, especially in steroid-resistant cases or is combined with them. It can also be used in induction regimens, but responses are less consistent than with muromonab CD3, and it has the potential to produce serum sickness or anaphylaxis, but is less expensive than muromonab CD3.

LYMPHOGLOBULIN (equine) 100 mg/vial inj.; 10 mg/kg/day i.v.;

THYMOGLOBULIN (rabbit) 25 mg/vial inj.; 1.5-2.5 mg/kg/day.

ATG 100 mg inj; 200 mg i.v./day.

Anti-D immunoglobulin It is human IgG having a high titer of antibodies against Rh (D) antigen. It binds the Rho antigens and does not allow them to induce antibody formation in Rh negative individuals. It is used for prevention of postpartum/post-abortion formation of antibodies in Rho-D negative, DU negative women who have delivered or aborted an Rho-D positive, DU positive baby/foetus. Administered within 72 hours of delivery/abortion, such treatment prevents Rh haemolytic disease in future offspring. It has also been given at 28th week of pregnancy.

Dose: 250–350 µg i.m. of freeze dried preparation.

RHIGGAL 100, 350 µg vial, **RHESUMAN**, **RHOGAM** 300 µg/vial inj.

Higher doses (1000–2000 µg) are needed for Rh negative recipients of inadvertently administered Rh positive blood. It should never be given to the infant or to Rho-D positive, DU positive individuals.

Immunosuppression in organ transplantation

Use of immunosuppressants is essential for successful organ transplantation. In general 3 types of regimens are used depending upon the stage of transplantation.

1. **Induction regimen** This is given in the perioperative period: starting just before the transplant to about 2–12 weeks after it. Accelerated rejection develops in the first week, while acute rejections are most likely from 2–12 weeks. The most common regimens include triple therapy cyclosporine + prednisolone + azathioprine (with or without muromonab CD3/ATG), but 2 drug and single drug regimens are also used. Many experts do not give cyclosporine preoperatively, and try to delay its induction as far as possible to avoid nephrotoxicity, particularly in renal transplantation. If no rejection develops, the doses are gradually reduced after 2 weeks and this phase merges imperceptibly with maintenance phase.

2. **Maintenance regimen** This is given for prolonged periods, may be life-long. Triple drug regimen is favoured because each component is needed in lower doses—reduces toxicity and cost. Cyclosporine is the most costly and its nephrotoxicity is often the limiting factor. Long-term steroid therapy has its own problems. The component which produces toxicity in a given patient is curtailed or dropped. Two drug and one drug regimens are also used, but are associated with more episodes of acute rejection. After 1 year, cyclosporine is generally dropped, but its continuation is associated with fewer acute rejections. In case of intolerance to the first line drugs cyclosporine, azathioprine and prednisolone, the second line drugs like cyclophosphamide, MMF, chlorambucil are substituted.

3. **Antirejection regimen** This is given to suppress an episode of acute rejection. Steroid pulse therapy (methylprednisolone 0.5–1 g i.v. daily for 3–5 days) is effective in majority of cases. In case of no response, muromonab CD3/ATG is given as rescue therapy or the antibodies are combined with steroids. Tacrolimus, MMF have also been used in rescue therapy of steroid resistant rejection. If the maintenance regimen had not included cyclosporine, its addition can treat acute rejection, but can be damaging to the transplanted kidney.

Adverse effects The two general untoward effects of immunosuppressant therapy are:

- (a) Increased risk of bacterial, fungal, viral (especially CMV) as well as opportunistic infections.
- (b) Development of lymphomas and related malignancies after a long latency.

GENE THERAPY

Gene therapy refers to the introduction of functional genetic material into target cells to replace or supplement defective genes, or to modify target cells so as to achieve therapeutic goals. In contrast to all other drugs, this kind of therapy can impart new functions to a cell. Conceived in the 1960s and started in the 1980s gene therapy is still experimental, but holds great promise for curing a number of diseases which at present can, at best, be only palliated or controlled. Gene defects result in failure to synthesize a functional protein or in the synthesis of a dysfunctional protein. Equipping the cell (especially the one which physiologically expresses it) with a normal copy of the defective gene would overcome the deficiency at the site where it is needed on a long-term (may be permanent) basis. Apart from inherited genetic disorders with single nucleotide polymorphism (SNP), the major thrust area of gene therapy are a number of acquired diseases such as malignancies, immunological disorders, including AIDS, cardio-vascular, neurological and infective diseases, in many of which even short-term expression of the introduced gene could be therapeutic.

APPROACHES IN GENE THERAPY

Gene therapy endeavours to either modify or transfer genes.

A. Gene modification This involves correction of the defective portion of a genomic sequence or removal of the whole defective gene and its replacement by the normal copy, or alteration of the sequences controlling its expression. These are technically quite difficult in the *in vivo* setting.

B. Gene transfer This involves introduction of one or more genomic expression cassettes without removing or altering the existing ones. Significant progress has been made in this approach. Gene transfer is carried out by

using various physical, chemical or biological delivery methods (vectors).

1. **Physical methods** are microinjection in a single cell, introduction of DNA complexed with gold particles/dextran/lipids, use of microprojectiles or direct parenteral injection of uncomplexed DNA. However, efficiency of gene transfer is low and duration of expression is short.

2. **Chemical methods** use liposomes or other specific cellular ligands. The liposomes can carry genes to the intracellular location in large amounts, are nonimmunogenic and technically simpler, but the level of gene transfer achieved is lower than by use of viral vectors. Liposomal delivery has been used in certain human gene therapy trials.

3. **Biological methods** involve fusion of recipient cell with bacterial spheroplasts, erythrocyte membrane vesicles, whole cell fusion, etc, but the most efficient and widely used are the viral vectors. Adenoviruses, Lenti virus, Herpes simplex virus have been utilized, but retroviruses are the most popular vectors. For using viral vector, its 'gag', 'pol', and 'env' genes which carry out viral replication are removed and replaced by the genes to be transferred using recombinant DNA technology. These viral particles are then introduced into a packaging cell line previously equipped with the 'gag', 'pol', and 'env' genes which then produce multiple viral particles carrying the desired gene. The retroviral vector is then allowed to infect host cells so that the desired DNA is inserted into a random site in the host genome which subsequently expresses the transferred gene. However, the duration of expression of the transferred gene is variable.

Gene transfer could be carried out into:

- **Germline cells** The new gene is introduced into embryonal cells so that it passes into the next generation. This is ethically not applicable to humans at present.
- **Somatic cells** Certain somatic cells like the bone marrow stem cells, fibroblasts, hepatocytes or myocytes of the recipient receive the new gene. This is being extensively pursued.
- **Specific organ directed delivery** of genes to the tissues that actually require it is being tried. Success has been achieved in transferring genes into liver cells, vascular smooth muscle and endothelial cells, pulmonary cells, etc.

The techniques of gene therapy may utilize either *ex vivo* or *in vivo* gene transfer.

Ex vivo gene transfer: The patient's tissue cells are isolated and maintained in tissue culture. These are then transfected with the vector carrying the relevant gene and injected back into the patient. This method has been widely utilized in the treatment of single gene defects, metabolic, haematological and immune disorders.

In vivo gene transfer: The vector, usually a retrovirus carrying the gene is injected systemically or directly into

the concerned organ. The property of retrovirus to transduce only dividing cells, such as tumor cells, is utilized for selective delivery of the gene leaving nondividing cells unaffected. However, this is a relatively inefficient method of gene therapy.

APPLICATIONS OF GENE THERAPY

Diverse applications of gene therapy are being pursued—mostly in experimental animals, but some have been tried clinically. Inherited single gene disorders appear simpler to correct or cure. In addition, several innovative strategies against cancer, viral diseases, acquired lifestyle diseases, etc. are being applied. The prominent ones are:

- Cystic fibrosis: by insertion of cystic fibrosis transport regulator (CFTR) gene into respiratory epithelial cells. This gene regulates expression of an apical chloride channel which is dysfunctional in cystic fibrosis. The limitation is that airway epithelial cells are rapidly shed off.
- Severe combined immunodeficiency disease (SCID): by introducing gene for adenosine deaminase which is deficient.
- Growth hormone deficiency: by implanting cultured myoblasts transfected with GH gene.
- Familial hypercholesterolemia: by introducing LDL receptor gene into hepatocytes.
- Lesch-Nyhan syndrome: by introducing hypoxanthine phosphoribosyl transferase gene to correct deficiency of this enzyme in the CNS which causes severe neuropsychiatric disorder.
- Parkinsonism: by introducing the gene for tyrosine hydroxylase to augment dopamine production in basal ganglia.
- Alzheimer's disease, Huntington's chorea, familial amyotrophic lateral sclerosis, Gaucher's disease: by supplementing the defective genes.
- Stroke, head injury, multiple sclerosis: by delivering nerve growth factor gene.
- Duchenne muscular dystrophy: by administering muscle dystropin gene.

- Cancer:
 - (i) By genetic introduction of an enzyme (viral thymidine kinase) into tumour cells followed by a prodrug that is converted to the toxic metabolite—tumour cells are selectively killed.
 - (ii) By inserting TNF α , IL-2 and other cytokine genes into tumour cells to increase their immune recognition and destruction by tumour infiltrating lymphocytes.
 - (iii) By introducing promoter 'antisense' gene or 'suppressor' gene which negatively regulate tumour growth.
 - (iv) By introducing multidrug resistance MDR-1 gene into bone marrow cells and render them less susceptible to destruction by myelosuppressant drugs. Thus, a limiting toxicity of many anticancer drugs can be overcome.
- Prevention of restenosis of grafted coronary vessels: by introducing genes which inhibit growth of intimal cells.
- Anaemia: by myoblast mediated introduction of human erythropoietin gene.
- Sickle cell anaemia: by introducing beta/delta sickle cell inhibitor hybrid gene.
- Haemophilia: by introducing factor VIII gene.
- Insulin dependent diabetes mellitus: by introducing insulin-1 gene into liver to act as an ectopic site for insulin production.
- HIV infection: by injecting fibroblasts expressing HIV envelope glycoprotein gene to augment immunity against HIV.

However, as yet gene therapy is only a research modality and in clinical trial stage. A number of technological, toxicological and ethical problems have to be solved before it could be available for mass application.

Another promising approach is to block expression of particular defective gene by *antisense oligonucleotides*, which are 15–25 base pair single strand nucleotides that interact with certain segments of specific genes and prevent their translation. *Fomivirsen* is an antisense oligonucleotide which has been approved for use in CMV retinitis.

CHAPTER 64

Drugs Acting on Skin and Mucous Membranes

A variety of drugs applied topically to the skin or mucous membranes produce therapeutic effects localized to the site of application. They act primarily by virtue of their physical/mechanical/chemical/biological attributes and may be divided into several categories designated by the most prominent action.

DEMULCENTS

Demulcents are inert substances which soothe inflamed/denuded mucosa or skin by preventing contact with air/irritants in the surroundings. They are, in general, high molecular weight substances and are applied as thick colloidal/viscid solutions in water. Some, like *gum acacia*, *gum tragacanth* produce foam with water, reduce surface tension and act as suspending/emulsifying agents.

Glycyrrhiza is a sweet tasting root (licorice); used in cough lozenges to soothe the throat and as sweetening/flavouring agent in mixtures. It contains a glycoside *glycyrrhizin* which has steroid like salt retaining action when taken orally.

Methylcellulose It is a synthetic cellulose derivative used as bulk purgative, in nose drops and contact lens solutions.

CADILOSE 0.5% drops in 10 ml bottle.

Propylene glycol is a clear, viscous liquid, miscible with water as well as some oils that is used in cosmetics and as occlusive dressing for ichthyosis, etc.

Glycerine is a clear, sweet, viscous liquid. Undiluted glycerine has dehydrating property—produces a warm sensation and irritates mucous membranes. Applied to anal canal as suppository it induces evacuation. Applied to dry skin and cracked lips (50% in water) it acts as emollient and is a popular vehicle for gum/throat paints. It is also used orally/per rectum (50–75%) or intravenously (10%) to reduce intraocular/intracranial tension.

EMOLLIENTS

Emollients are bland oily substances which soothe and soften skin. They form an occlusive film over the skin, preventing evaporation, thus restoring elasticity of cracked and dry skin. Olive oil, arachis oil, sesame oil, cocoa butter, hard and soft paraffin, liquid paraffin, wool fat, bees wax and spermaceti are the commonly employed emollients. They are also used as vehicles for topically applied medicaments and as ointment bases.

Wool fat may cause allergy in some patients.

ADSORBANTS AND PROTECTIVES

Adsorbants are finely powdered, inert and insoluble solids capable of binding to their surface (adsorbing) noxious and irritant substances. They are also called protectives because they afford physical protection to the skin or mucosa. Other protectives form a continuous, adherent and flexible occlusive coating on the skin. Demulcents and emollients also serve as protectives.

Magnesium/zinc stearate They have very smooth surface—prevent friction, and are not water wettable—can be used on exuding surfaces because they allow evaporation of water and do not form a crust.

Talc It is native hydrous magnesium silicate, which spreads easily—used in talcum/face powders. Entering raw surfaces, it can form granulomas—should not be sprinkled on wound or used for surgical gloves.

Calamine It is native zinc carbonate tinted pink with ferric oxide. Calcined calamine is zinc oxide. It has mild astringent and antiseptic action and is a good soothing and protective agent. Used in calamine lotion along with zinc oxide and bentonite (native hydrated aluminium silicate) which have similar properties, as cosmetic, on sunburn, insect bite, urticaria and contact dermatitis.

CALACREME 5% cream, CALAMINOL 5% and CALAMYL 10% emulsion, CALAK 15% with zinc oxide 5%, bentonite 3% sodium citrate 0.5%, glycerol 5% (calamine lotion).

Starch It is used in dusting powders and for surgical gloves, but should not be used on exuding surfaces because it absorbs moisture, crusts on drying and encourages fermentation.

Boric acid It is a smooth and fine powder: has mild antiseptic (*see* Ch. 65), antipruritic and deodorant actions. It is a common ingredient of prickly heat powders.

Aloe vera gel It is a mucilaginous preparation from the fleshy leaves of *Aloe vera* plant with soothing and moisturising property, widely

included in cosmetic and skin care products. Therapeutic claims in acne, psoriasis and many other conditions have been made.

ALOVIT: Aloe extract 10% + vit E 0.5% cream.

Polyvinyl polymer On drying its solution forms an occlusive pellicle-like coating on abraded skin. Used as a spray on abrasions and minor cuts, it protects from dust and exposure.

HEALEX SPRAY: 2.5% + benzocaine 0.36% as aerosol wound dressing.

Feracrylum It is a water-soluble biodegradable polymer which forms gel-like complexes on coming in contact with blood. Applied to fresh abrasions, it stops oozing of blood and protects the wound by acting as a physical barrier. A mild antiseptic action is also exerted.

SEPGARD GEL: 1% gel, to be applied as a thin film on the abrasion/wound.

Dimethicone (Dimethyl polysiloxane, Simethicone) It is a silicone polymer—a viscous, amphiphilic liquid. It is pharmacologically inert, has water repellent and surface tension reducing properties (collapses froth). Applied to the skin, it adheres and protects it; special use—to prevent maceration and excoriation of skin due to soiling with urine (suprapubic cystostomy). Also used on bedsores, ulcers and burns.

BARRIER-SF: Dimethicone 15%, vit E 0.18% cream.

Sucralfate (topical) This aluminium salt of sulfated sucrose used primarily as peptic ulcer protective (*see* p. 636), has been formulated as a topical gel. Applied on burns, bedsores, diabetic/radiation/aphthous ulcers, excoriated skin, sores, etc. it adheres and serves to protect damaged tissue—facilitates healing.

PEPSIGARD LIGHT GEL 10% gel; to be applied on the ulcer 3-4 times a day.

ASTRINGENTS

Astringents are substances that precipitate proteins, but do not penetrate cells, thus affecting the superficial layer only. They toughen the surface making it mechanically stronger and decrease exudation. Drugs are:

Tannic acid and tannins Tannic acid is present in many plants but is generally obtained from nutgalls of oak. Tannins are found in tea, catechu, nutmeg, areca nut (betel nut), etc. They denature proteins forming protein tannate. Uses are:

Bleeding gums—as glycerine of tannic acid.

Bleeding piles—as tannic acid suppository.

Alkaloidal poisoning—precipitates ingested alkaloids as tannates.

(Its use on burns has been abandoned because it forms a crust under which bacteria could grow. Sufficient systemic absorption often occurred to cause centrilobular necrosis of the liver.)

Alcohol Ethanol and methanol are good astringents at 50–90% concentration. Denatured spirit rubbed on the skin prevents bedsores, but should not be applied on the sores once these have formed, as it is highly irritating to raw surfaces. Ethanol is also used as after-shave and on minor cuts.

Mineral astringents Heavy metal ions are astringent and antiseptic. Alum has been used as after-shave and as local haemostatic on minor cuts. Other aluminium, zinc and zirconium salts are used as antiperspirants. They diffuse through the sweat ducts, reduce secretion from glands and partially block the ducts as well. Their antibacterial action prevents decomposition of sweat by bacteria, reducing body odor.

IRRITANTS AND COUNTER-IRRITANTS

Irritants stimulate sensory nerve endings and induce inflammation at the site of application. Depending on their nature, concentration and sensitiveness of the site, they produce cooling sensation or warmth, pricking and tingling, hyperaesthesia or numbness and local vasodilatation. Irritants which cause local hyperemia with little sensory component are called *Rubefacients*. Stronger irritants which in addition increase capillary permeability and cause collection of fluid under the epidermis (forming raised vesicles) are termed *Vesicants*. Certain irritants also produce a remote effect which tends

to relieve pain and inflammation in deeper organs—called *Counter-irritants*.

Mechanism of counterirritation Cutaneous sensations are precisely localized. Deeper sensations from muscles, joints and viscera are perceived more diffusely. A spinal segment, receiving afferent impulses from the surface as well as from deeper organs, modulates them—preferentially conducting the former to the higher centers. When a counter-irritant is applied to the area of skin supplied by nerves from the same segment as the deeper organ from which pain impulses are coming, the cutaneous impulses obscure the deeper sensation.

Irritation of afferent nerve endings produces arteriolar dilatation in the adjoining areas of skin by axon reflex (which mediates flare in triple response). Through segmental association of afferents, vasodilatation also occurs in the corresponding deeper organ. Increased blood supply helps to fight the cause of pain and inflammation in the deeper organ.

Counterirritants are generally massaged to relieve headache, muscular pain (torticollis, backache, sprain), joint pain, pleural/peritoneal pain, colics, etc. Drugs are:

Volatile oils (essential oils) are terpene hydrocarbons of plant origin having a characteristic odour. They have variable properties, but all are irritants. Stearoptenes are solid volatile oils.

Turpentine oil Obtained by distilling *Pinus* oleoresin; used as counterirritant in the form of liniment or 'stupes'.

Clove oil Applied by cotton swab for toothache.

Eucalyptus oil Used in pain balms.

Camphor It is obtained from the bark of *Cinnamomum camphora* or produced synthetically. Produces cooling sensation on skin and is mildly anaesthetic—relieves itching. It is added in liniments and pain balms. Taken internally—small doses produce a warm and comforting sensation in epigastrium; large doses are emetic.

Systemically it produces excitement and convulsions (especially in children).

Thymol Obtained from *Thymus vulgaris*, has a pungent taste. It is included in pain balms.

Menthol From mint or prepared synthetically, has cooling and soothing action. It is added to pain balms, throat paints, throat lozenges and inhalers for relief of nasal congestion. It is also a carminative.

Mustard seeds It contains a glycoside *sinigrin* and an enzyme *myrosin*. When ground seeds are soaked in water, myrosin hydrolyses sinigrin to release *allyl isothiocyanate* which is a strong irritant. Mustard plaster has been used as rubefacient and counterirritant. As a suspension in water 4–8 g, of ground seeds are emetic.

Capsicum (Chillies) It is a powerful irritant, hot in taste. The active principle is *capsaicin*. It is a popular condiment in Indian cooking, and is included in some counterirritant preparations. After initial stimulation, capsaicin depletes afferent nerve endings of the transmitter substance P; may relieve post-herpetic neuralgia on local application.

Canthridin A crystalline solid obtained from Spanish fly. It is a strong irritant, higher concentrations damage the epithelium and cause vesication—has been used to remove warts, etc. It is added to hair tonics—claimed to increase vascularity of scalp and promote hair growth.

Methyl salicylate (oil of wintergreen) In contrast to other salicylates, it is not used internally (induces vomiting, gastritis and systemic toxicity). It is combined with other irritants in liniments and ointments for muscle and joint pain.

Alcohol Produces rubefaction when rubbed on skin and is a vehicle for liniments.

Some counterirritant combinations

ALGIPAN: Capsicum oleoresin 0.1%, histamine 0.1%, methyl nicotinate 1%, glycol salicylate 5% cream.

ARJET SPRAY: Methyl salicylate 875 mg, menthol 1.6 g, camphor 1.5 g, benzyl nicotinate 20 mg, squalance 250 mg, glycol salicylate 875 mg per 50 ml spray.

EUTHERIA: Eucalyptol 7.2%, menthol 4.7%, methylsalicylate 11.25% balm.

MEDICREME: Methylsalicylate 8%, menthol 2%, adrenaline 0.03%, mephenesin 2.5%, chlorpheniramine 0.2%, cream.

RELAXYL: Capsicum oleoresin 0.05%, mephenesin 10% methyl nicotinate 1% ointment.

VICKS VAPORUB: Menthol 2.8%, camphor 5.25%, thymol 0.1% turpentine oil 5.5% ointment.

IODEX: Methylsalicylate 5%, iodine 4% nonstaining ointment.

AMRUTANJAN: Eucalyptus oil 17%, camphor 10%, thymol 1%, menthol 4.5%, methylsalicylate 7% ointment.

CAPSIGYL-D: Capsaicin 0.075%, methyl salicylate 20%, menthol 10%, camphor 5%, eucalyptus oil 5%, diclofenac 1% gel.

CAUSTICS AND ESCHAROTICS

Caustic means corrosive and *Escharotic* means cauterizer. These chemicals cause local tissue destruction and sloughing. An escharotic, in addition, precipitates proteins that exude to form a scab—gets fibrosed to form a tough scar. They are used to remove moles, warts (including genital warts) condylomata, papillomas and on keratotic lesions. Care is needed in their application to avoid ulceration. It is believed that all microorganisms are killed during cauterization, but this is not always so.

Podophyllum resin As 10–25% alcoholic solution or suspension in mineral oil.

PODOWART 20% paint; CONDYLINE 0.5% podophyllotoxin soln.

Silver nitrate As toughened silver nitrate sticks or pencils.

Phenol As 80% w/w solution.

Trichloroacetic acid As crystals or 10–20% solution to cauterise adenoids; dilute solution is used to promote peeling of frackled skin.

Glacial acetic acid Undiluted.

KERATOLYTICS

Keratolytics dissolve the intercellular substance in the horny layer of skin. The epidermal cells swell, soften and then desquamate. These drugs are used on hyperkeratotic lesions like corns,

warts, psoriasis, chronic dermatitis, ring worm, athletes foot, etc.

Salicylic acid As 10–20% solution in alcohol or propylene glycol for dissolving corns. More effective when applied under occlusive dressing. *Propylene glycol* is hygroscopic. Applied under polyethylene occlusive dressing, it causes maceration of skin and acts as a keratolytic, supplementing the action of salicylic acid.

CORNAC 16.5% liquid, CORN CAP 40% oint in adhesive tape.

Lower concentrations (3–5%) are used in other conditions, e.g. in Whitfield's ointment.

RINGCUTTER 3% ointment with 5% benzoic acid.

It is also mildly antiseptic and antifungal.

Resorcinol Has antiseptic, antifungal, local irritant and keratolytic properties; 3–10% is used in eczema, seborrheic dermatitis, ringworm, etc.

Urea Applied at a concentration of 5–20% in cream/ointment base, urea acts as a humectant by its hygroscopic and water retaining property. It causes softening and solubilization of keratin, facilitating its removal from hyperkeratinized lesions like ichthyosis, lichen planus. Inclusion of urea enhances the penetration of the concurrently applied topical steroid.

ANTI-SEBORRHEICS

These are drugs effective in seborrheic dermatitis which affects areas rich in sebaceous glands (scalp, face, trunk) and is characterized by erythematous, scaling lesions. Dandruff is the commonest complaint. A causal role of the yeast *Pityrosporum ovale* has been shown, but various trigger factors like change in quantity and composition of sebum, increase in alkalinity of skin (due to increased sweating), external local factors, emotional stress, genetic predisposition appear to be needed to transform the yeast from a commensal to a noninvasive pathogenic organism. Drugs used are:

Selenium sulfide Applied to the scalp as a 2.5% lotion or shampoo, it slows epidermal prolifera-

tion and scaling. It is also antikeratolytic and fungicidal to *P. ovale*. Dryness, folliculitis and dandruff are benefited, but > 50% patients relapse on discontinuation. Systemic absorption and toxicity can occur if it is applied to inflamed or damaged skin. Some individuals develop sensitivity reactions.

SELSUN 2.5% susp., SELDRUFF PLUS 2.5% susp. with clotrimazole 1%.

Zinc pyrithione It reduces epidermal turnover and inhibits *P. ovale*. Weekly shampoo (1%) reduces dandruff, but symptoms do not resolve completely.

It is often combined with ketoconazole.

SCALPE: Zinc pyrithione 1%, Ketoconazole 2% shampoo.

Corticosteroids Massaged in the scalp as a lotion, topical steroids are highly effective in relieving symptoms of seborrheic dermatitis including dandruff. Pityrosporal yeasts are reduced in the affected skin. However, relapse rates are high on discontinuation and prolonged use can produce adverse effects like atrophy, poor healing, purpura, etc.

Imidazole antifungals Among several of these compounds, ketoconazole (KTZ) was found to be the most effective against *P. ovale*. Orally (200 mg/day for 4 weeks) it has been found to improve seborrhoea. But because this is often a chronic relapsing condition and prolonged oral KTZ therapy is considered unwarranted, KTZ has been formulated into 2% cream/shampoo/scalp gel. Good to excellent results have been obtained with these preparations without skin irritation, contact sensitivity, phototoxicity or systemic adverse effects.

KETOVATE, NIZRAL, OCONA 2% cream, 2% shampoo.

Clotrimazole 1% solution may be used in its place.

Sulfur, Resorcinol, Coaltar, Ammoniated mercury These drugs are mildly effective. They have minimal antiyeast action: may benefit seborrhoea by keratolytic and antiseptic properties.

Salicylic acid It is keratolytic, has mild effect in seborrhoea, probably by removing the scales and by improving penetration of other drugs.

MELANIZING AGENTS

Melanizing agents are drugs that increase sensitivity to solar radiation and promote repigmentation of vitiliginous areas of skin. Psoralens are furocoumarins which on photoactivation stimulate melanocytes and induce their proliferation.

Psoralen It is obtained from fruit of *Ammi majus*. MANADERM 10 mg tablet, 1% ointment, PSORLINE 5 mg tablet, 0.25% solution and ointment.

Methoxsalen (MACSORALEN 10 mg tab, 1% solution, MALANOCYL 10 mg tab, 0.75% soln.) and **Trioxsalen** (NEOSORALEN 5 mg, 25 mg tablets and 0.2% lotion) are synthetic psoralens.

They sensitize the skin to sunlight which then induces erythema, inflammation and pigmentation. They are applied topically as well as given orally. Methoxsalen is absorbed better, undergoes less first pass metabolism and is more effective than trioxsalen. Their plasma $t_{1/2}$ is short (~ 1 hr); sensitization of skin is maximal at 1–2 hours, but lasts for 8 hours or more.

Topical therapy The solution/ointment is carefully painted on the small well defined vitiliginous lesion—which is then exposed to sunlight for 1 minute and then occluded by bandage or sun screen ointment. Weekly treatment with longer exposures is given. Pigmentation usually begins to appear after a few weeks; months are needed for satisfactory results. Then periodic maintenance treatment may be needed. This therapy should be undertaken only under direct supervision of physician because longer exposure causes burning and blistering.

Oral therapy On alternate days after 2 hours of a 0.3–0.6 mg/kg (usually 20 mg) oral dose of a psoralen, skin is exposed to sunlight (or artificial UV light), initially for 15 minutes—gradually increasing to 30 minutes over days. Eyes, lips and other normally pigmented areas should be protected during exposure to sunlight.

DRUGS FOR PSORIASIS

Psoriasis is an immunological disorder manifesting as localized or widespread erythematous scaling lesions or plaques. There is excessive epidermal proliferation attended by dermal inflammation. Periodic flareups are common. Drugs can diminish the lesions, but cannot cure the disease. Therapy has to be prolonged and adjusted to the severity of disease. Topically applied emollients, keratolytics, antifungals afford variable symptomatic relief, but *topical corticosteroids* are the primary drugs used. They are very effective in mild-to-moderate disease, and initially even in severe cases. Most patients respond within 3 weeks, and the response may be hastened by applying the steroid under occlusion. Therapy is started with a potent steroid which is substituted after improvement by either weekly application or by a milder preparation. However, they carry their own local and systemic adverse effects, and lesions may progressively become refractory. Systemic therapy with corticosteroids and/or immunosuppressants is reserved for severe and refractory cases. Other topically used drugs are:

Calcipotriol It is a synthetic nonhypercalcaemic vit D analogue effective topically in plaque type psoriasis. It binds to the intracellular vit D receptor in epidermal keratinocytes and suppresses their proliferation while enhancing differentiation. On absorption through the skin, it is inactivated rapidly by metabolism so that little systemic effect on calcium metabolism is exerted. Benefit in psoriasis is slow; but most cases respond in 4–8 weeks. Response is maintained till treatment is continued. Efficacy of calcipotriol in psoriasis is rated comparable to a moderate potency topical steroid. Combination with a steroid is more effective than either drug alone. Side effects are skin irritation, erythema and scaling. Hypercalcaemia is rare. It is a safe and effective alternative to steroids, but expensive.

DAIVONEX 0.005% oint; apply over psoriatic lesions twice daily.

Tazarotene This synthetic retinoid applied as a topical gel (0.05–0.1%) is moderately effective in psoriasis. It is a prodrug which is hydrolysed in the skin to tazarotenic acid that exerts antiproliferative and antiinflammatory action by binding to the intracellular retinoic acid receptor and modification of gene function. Combination with a topical steroid/calcipotriol may benefit refractory cases. Skin irritation, burning sensation, peeling are common. These can be minimized by careful application to the plaques only. It is teratogenic.

Coaltar This crude preparation containing many phenolic compounds exerts a phototoxic action on the skin when exposed to light, especially UVA, and retards epidermal turnover. Applied as ointment or alcoholic solution on psoriatic plaques (generally with salicylic acid) and exposed to sunlight daily, it induces resolution of psoriatic lesions in majority of cases, but relapses are common. Its use has declined now because of strong smell, cosmetic unacceptability, skin irritation, allergy, and potential for photosensitivity and carcinogenicity.

EXETAR: coaltar 6%, salicylic acid 3%, sulfur ppt. 3%, oint.

TARSYL: coaltar 1%, salicylic acid 3% lotion. **IONAX-T:** coaltar 4.25%, salicylic acid 2% scalp lotion.

Photochemotherapy (PUVA: Psoralen ultra-violet A) Photoactivated psoralen undergoes O₂ independent as well as O₂ dependent reactions and binds to pyrimidine bases—interferes with DNA synthesis and epithelial cell turnover. PUVA therapy has produced gratifying results in severely debilitating psoriasis, but relapses occur when treatment is stopped. Oral methoxasalen is followed 1–2 hours later by UVA exposure on alternate days. There are serious concerns regarding potential of PUVA to cause skin cancer, cataracts and immunological damage. Being inconvenient and carrying risks, it is reserved for severe cases of psoriasis only.

Psoralens have also been used to accelerate tanning—a maximum of 2 weeks treatment has been advised for this purpose. Other applications of PUVA are in lichen planus, urticaria pigmentosa, atopic dermatitis and cutaneous T cell lymphoma.

Adverse effects: Mottling, erythema, burns, blistering, premature ageing of skin, gastric discomfort, nervousness and insomnia.

Acitretin It is a synthetic retinoid for oral use in psoriasis, lichen planus, severe ichthyosis, etc. It acts by binding to ‘retinoic acid receptor’ in epidermal cells and regulating their proliferation and maturation. Inflammation is suppressed. Because of frequent and potentially serious adverse effects, use of acitretin is restricted to recalcitrant, pustular and other forms of severe psoriasis. Combination with topical antipsoriatic drugs is advised.

Dose: 0.5–0.75 mg/kg/day oral;

ACITRIN 10, 25 mg tab.

Dryness of skin and eyes, gingivitis, erythema and scaling of skin, alopecia, arthralgia, myalgia, lipid abnormalities and liver damage are the important adverse effects. Elimination of acitretin is very slow (taking months) because of accumulation in body fat. It is highly teratogenic. Women taking acitretin must not conceive during and till 3 years after stopping it. Drinking alcohol should be prohibited during and till 3 months after acitretin use.

DEMELANIZING AGENTS

They lighten hyperpigmented patches on skin.

Hydroquinone It is a weak hypopigmenting agent. It inhibits tyrosinase and other melanin forming enzymes, decreases formation of and increases degradation of melanosomes. Regular application (as 2–6% lotion or cream) for months is required in melasma, chloasma of pregnancy, etc. The response is often incomplete and pigmentation may recur when it is discontinued, especially if exposed to sunlight; sunscreens are frequently combined. Skin irritation, rashes and allergy are possible. Care is to be taken to avoid its entry in eyes.

EUKROMA 4% cream, MELALITE: Hydroquinone 2% with glycerylester of PABA 2.8% cream. **BRITE:** hydroquinone 4%, glyceryl PABA 2.8% cream.

Monobenzone A derivative of hydroquinone; potent demelanizing agent—destroys melanocytes and may cause permanent depigmentation. Full effect takes 4–6 months; treated areas should be protected from sunlight by a sunscreen. Its bleaching action is somewhat irregular: ugly depigmented patches can appear. Erythema and eczema may also result. Therefore, its use should be restricted to patients with widespread vitiligo—to reduce the colour contrast between pigmented and nonpigmented areas and for post-inflammatory melasma; 5% lotion or 20% ointment is applied 2–3 times daily.

BENOQUIN 20% ointment.

Azelaic acid It is a drug for acne (see p. 853) that is also effective in hyperpigmentary disorders including melasma. It appears to act by inhibiting the melanin forming enzyme tyrosinase. However, it is a weak demelanizing agent with reversible hypopigmentary action.

Azelaic acid is used as a 10%, 20% cream. The only side effect is mild and transient local irritation.

AZIDERM 10%, 20% cream.

SUNSCREENS

Sunscreens are substances that protect the skin from harmful effects of exposure to sunlight.

(a) Chemical sunscreens They absorb and scatter UV rays that are responsible for sunburn and phototoxicity, but allow longer wave lengths to penetrate, so that tanning occurs.

Efficacy of a sunscreen formulation is quantified by its 'Sun protection factor' (SPF) which is the ratio of the dose of UVB radiation that will produce minimal erythema on protected skin to the dose required for the same on unprotected skin. Most commercial preparations have a SPF of 15. Period for which they remain effective depends on the vehicle.

Para-aminobenzoic acid (PABA) and its esters: glyceryl mono amino benzoate. They absorb UVB (290–320 nm). PABA is used as 5% solution in alcohol/propylene glycol (**PABALAK**) or as 10% cream (**PARAMINOL**).

Benzophenones (such as oxybenzone 2–6%) block UVA (320–400 nm); are highly protective; thus higher concentrations prevent tanning also.

Cinnamates (such as octyl methoxy cinnamate) are included in sunscreens.

SUNSHIELD: Octyl methoxy cinnamate 5%, vit E 0.25% lotion. **EUKROMA-SG:** Oxybenzone 3%, Octylmethoxy cinnamate 5%, hydroquinone 2% cream.

Uses Chemical sunscreens are used as adjuncts in vitiligo therapy, drug induced phototoxicity and to facilitate tanning while preventing sunburn. There is some evidence that they can prevent skin cancer and premature ageing of skin.

(b) Physical sunscreens Heavy petroleum jelly, titanium dioxide, zinc oxide and calamine are opaque substances that stop and scatter not only UV but also visible light. They are also called 'sun shades' and have to be applied as a thick lotion/cream which may be cosmetically disagreeable. They withhold longer wave lengths also, which are mostly involved in photoallergy. Not only sunburn, but tanning as well is prevented.

Chloroquine taken orally is effective in actinic eruptions, but should be reserved for severe cases only.

DRUGS FOR ACNE VULGARIS

Acne vulgaris is the most common skin disease in adolescent boys and girls. Under androgenic stimulation the sebaceous follicles of face and neck produce excess of sebum and get colonized by bacteria and yeast (*Propionibacterium acnes*, *Staph. epidermidis*, *Pityrosporum ovale*). Bacterial lipases produce fatty acids which irritate the follicular ducts causing retention of secretions and hyperkeratosis—'comedones' are formed which may rupture into the dermis causing inflammation and pustulation.

1. TOPICAL THERAPY

1. Benzoyl peroxide It is one of the most effective and widely used drugs in acne: gradually liberates oxygen (in the presence of water) which

kills bacteria, especially anaerobic/microaerophilic ones: used almost exclusively for acne because of its high efficacy against *P. acnes* and additional keratolytic and comedolytic properties. *P. acnes* or other bacteria do not develop resistance to benzoyl peroxide. It induces mild desquamation, the comedone caps are shed and production of irritant fatty acids in the sebum is reduced. Benzoyl peroxide is a mild irritant of the skin—burning and stinging sensation is often felt initially, localized erythema may occur. Most patients gradually develop tolerance to these actions; if not, use should be discontinued. Avoid contact with eyes, lips, mucous membranes and denuded skin. It can bleach hair and coloured fabric.

Adverse effects are excessive dryness of skin, marked scaling, erythema, edema and contact sensitization (in 1–2% patients). It is used as 5–10% cream, gel or lotion; duration and frequency of application is guided by the degree of irritation produced and tolerated; start with 15 min once daily.

PERSOL, PERNOX, BENZAC-AC 2.5% and 5% gel; in PERSOL FORTE 10% cream with sulfur ppt. 5%.

2. Retinoic acid (all trans vitamin A acid, Tretinoin) It is a potent comedolytic: promotes lysis of keratinocytes, prevents horny cells from binding to each other, hence comedones, which are horny impactions in follicles, cannot form. Epidermal cell turnover is stimulated resulting in peeling. No antibacterial action is exerted. It is highly efficacious in acne, but response is delayed (may take 6–10 weeks). Tretinoin has the potential to irritate the skin; start with the lower concentration applied once daily.

Side effects are feeling of warmth, stinging, excessive redness, edema and crusting. Used as a 0.025–0.05% gel or cream, it can be alternated with benzoyl peroxide (one in the morning the other at night), but both should not be applied together because benzoyl peroxide accelerates degradation of tretinoin. Teratogenic risk with topical retinoic acid is minor because of low blood levels produced; but it should be used during pregnancy only if essential.

Tretinoin has been shown to prevent photoageing of skin. Dry scaly surface, mottling, wrinkles, rough and leathery texture, sagging of loose skin that develop due to excessive exposure to sun are arrested and pigmented spots tend to fade. However, the risk-benefit ratio of long-term prophylactic therapy is not clear.

EUDYNA 0.05% cream. RETINO-A 0.025% and 0.05% cream.

3. Adapalene It is a newer synthetic tretinoin-like drug which binds directly to the nuclear retinoic acid receptor and modulates keratinization and differentiation of follicular epithelial cells. It also exerts antiinflammatory action; comedone formation is suppressed. In acne vulgaris it is as effective but less irritating than tretinoin. It remains stable in the presence of benzoyl peroxide; can be combined with it.

ADAFERIN, ADAPEN, ADAPLE, ACLENE 0.1% gel; apply once daily at bed time.

Tazarotene (see p. 851) is another topical retinoid with therapeutic effect in acne vulgaris as well.

4. Topical antibiotics Clindamycin, erythromycin and tetracyclines are less effective against *P. acnes* than benzoyl peroxide. They are appropriate for cases with inflamed papules, rather than in non-inflamed comedones. They do not irritate skin but can cause sensitization.

Erythromycin: ACNEDERM 2% lotion and oint; ERYTOP 3% lotion and cream; ACNESOL 4% gel, 2% lotion, ACNELAK-Z 4% lotion and gel with zinc acetate 2%.

Clindamycin: CLINDAC-A, CLINCIN 1% gel.

Nadifloxacin is a newer topical quinolone broad-spectrum antibiotic which has exerted therapeutic benefit in inflamed acne and folliculitis.

NADIBACT, NADOXIN 1% cream for topical application.

5. Azelaic acid It is a natural product from *Pityrosporum ovale* that has been developed for topical treatment of acne. Many aerobic and anaerobic microorganisms, especially *P. acnes* present on acne bearing skin are inhibited. Azelaic acid reduces cutaneous bacterial density, free fatty acid content of skin surface lipids and proliferation of keratinocytes. Used as 10%, 20% cream, its efficacy in acne approaches that of

benzoyl peroxide, but response is delayed. It has also benefited melasma.

AZIDERM 10%, 20% cream

II. SYSTEMIC THERAPY

Systemic use of drugs in acne is indicated only in severe cases with cysts and pustules which are likely to form scars.

1. Antibiotics Tetracycline, minocycline or erythromycin have been used. After initial control, smaller maintenance doses may be continued for months. However, long-term systemic antibiotic therapy has its own complications. Recently risk of intracranial hypertension after use of tetracyclines for > 2 months has been emphasized.

2. Isotretinoin (13-cis retinoic acid) is an orally administered retinoid that reduces production of sebum (skin bacteria decrease secondarily), corrects abnormal keratinization of follicles and causes dramatic improvement. A 20 week course of 0.5–1 mg/kg daily brings about remission in most cases of cystic acne. Relapses occur after variable intervals; can be treated similarly. Side effects are frequent—cheilitis, dryness of skin, eyes, nose and mouth, epistaxis, pruritus, conjunctivitis, paronychia, rise in serum lipids and intracranial tension, and musculoskeletal symptoms. Therefore, it should be reserved for unresponsive cases of severe acne.

Isotretinoin is highly teratogenic; upto 25% exposed foetuses had birth defects—craniofacial, heart and CNS abnormalities (ACCUTANE embryopathy). It is contraindicated in women likely to become pregnant during therapy and one month after. The $t_{1/2}$ of isotretinoin is ~18 hours, and it is not accumulated like other retinoids.

ISOTROTIN 10, 20 mg cap, IRET 20 mg cap.

Isotretinoin is also effective in the prevention and treatment of skin cancers. Oral leucoplakia, actinic keratoses and other premalignant lesions can be treated, but benefit-risk ratio is not clear.

TOPICAL STEROIDS

Glucocorticoids are used topically for a large variety of dermatological conditions. They bene-

fit by virtue of their antiinflammatory, immunosuppressive, vasoconstrictor and antiproliferative (for scaling lesions) actions. The intensity of action depends on the extent of absorption to the deeper layers, thus lipophilicity of the compound determines potency to a great extent. Fluorinated compounds and lipid soluble esters, e.g. hydrocortisone butyrate are potent. The available preparations may be roughly graded as:

Potent

Beclomethasone dipropionate	0.025%	BECLATE cream.
Betamethasone benzoate	0.025%	TOPICASONE cream, oint.
Betamethasone valerate	0.12%	BETNOVATE cream, oint. BETASONE cream.
Halcinonide	0.1%	CORTILATE, HALOG, cream
Clobetasol propionate	0.05%	LOBATE, TENOVATE, DERMOTYL cream
Dexamethasone sod. phosphate	0.1%	DECADRON cream (with Neomycin 0.35%).
Dexamethasone trimethyl-acetate	0.1%	MILLICORTENOL cream.
Fluocinolone acetonide	0.025%	FLUCORT oint., LUCI oint.
Fluocortolone	0.5%	ULTRALAN oint.
Triamcinolone acetonide	0.1%	LEDERCORT oint.

Moderately potent

Fluocinolone acetonide	0.01%	FLUCORT-H oint. and skin lotion.
Clobetasol butyrate	0.05%	EUMOSONE cream
Fluocortolone	0.25%	COLSIPAN oint.
Mometasone	0.1%	MOMATE, CUTIZONE oint, cream
Fluticasone propionate	0.05%	FLUTIVATE, MOLIDERM cream
Prednicarbate	0.1-0.25%	DERMATOP, STEROTOP cream
Triamcinolone acetonide	0.05%	DESOWEN, DESONIDE cream/ lotion
Hydrocortisone + urea 12%	1%	COTARYL-H cream.
Hydrocortisone acetate	2.5%	WYCORT oint.

Mild

Hydrocortisone acetate	0.1–1.0%	LYCORTIN 1% oint., in CORTOQUINOL 1% with quiniodochlor 4% cream, GENTACYN-HC TOPICAL 1% with gentamicin 0.1%. CORTISON-KEMICETINE 0.5% with chloramphenicol 0.5%. LOCOID cream
Hydrocortisone butyrate	0.001%	

General guidelines for the use of topical steroids

(i) Penetration of the steroid at different sites differs markedly—high at axilla, groin, face, scalp and scrotum; medium at limbs and trunk; low at palm, sole, elbow and knee. Areas of high penetration easily develop adverse effects—potent preparations should be avoided. Areas of low penetration do not generally respond to milder agents.

(ii) Absorption into the skin also depends on the nature of lesion—high in atopic and exfoliative dermatitis, low in hyperkeratinized and plaque forming lesions. Milder drugs should be used on acute lesions, stronger ones reserved for chronic lesions.

(iii) Choice of vehicle is important. Lotions and creams (to some extent) are better for exudative lesions—they allow evaporation, have a cooling, drying and antipruritic effect. Sprays and gels are appropriate for hairy regions. Ointments form an occlusive film and are good for chronic, scaly conditions.

(iv) Occlusive dressing markedly enhances absorption of the steroid (as much as 10 fold), retains moisture and results in maceration of the horny layer. Chronic, hypertrophied lesions may be occluded intermittently (12 hours at a time). Continuous occlusion promotes bacterial and fungal growth.

(v) Absorption is greater in infants and young children—milder agents should be used.

(vi) Routine use of potent steroids is not justified. Very potent preparations should be restricted to severe inflammatory conditions, unresponsive eczema, psoriasis, etc., and that too only for short periods till the lesion resolves. The mildest preparation that will control the lesion should be used.

(vii) Use of potent preparations should be short term or intermittent to prevent adverse effects and tachyphylaxis. Sudden discontinuation should be avoided. Upon improvement a less potent preparation may be substituted or the steroid may be alternated with an emollient till the lesion resolves.

(viii) More than 2 applications a day do not afford additional benefit. Generally twice daily application is satisfactory.

Indications for topical steroids

<i>Lesions that usually respond well</i>	<i>Lesions requiring potent steroids, respond slowly</i>
Atopic eczema	Cystic acne
Allergic contact dermatitis	Alopecia areata
Lichen simplex	Discoid LE
Primary irritant dermatitis	Hypertrophied scars, keloids
Seborrheic dermatitis	Lichen planus
Psoriasis of face, flexures	Nail disorders
Varicose eczema	Psoriasis of palm, sole, elbow, knee

A combination of steroid with an antimicrobial may be used for—impetigo, furunculosis, secondary infected dermatoses, napkin rash, otitis externa, intertriginous eruptions.

Local adverse effects of topical steroids

Thinning of epidermis	} Related to the potency of preparation and duration of treatment; skin of face is more susceptible. Potent halogenated steroids not to be used on face.
Dermal changes—atrophy	
Telangiectasia, Striae	
Easy bruising	
Hypopigmentation	
Delayed wound healing	
Fungal and bacterial infections	

Systemic adverse effects of topical steroids

Adrenal pituitary suppression can occur if large amounts are applied repeatedly. Infants and children are particularly susceptible. Rarely, Cushing's syndrome has been reported. With proper use, the systemic risks are minimal.

Popular combinations are:

Containing Neomycin (0.3–0.5%): **BECLATE-N, BETASONE-N, COLSIPAN-N, DECADRON, KENACOMB, KENALOG-S SKIN, TOPICASONE.**

Containing Chinoform or Quiniodochlor (3–4%):

BECLATE-C, BETASONE-C, BETNOVATE-C, CORTOQUINOL, FLUCORT-C

Containing Gentamicin (0.1%): **GENTICYN-HC TOPICAL, DERMOTYL-G, LOBATE-G**

Containing Chloramphenicol (1%): **CORTISON-KEMICETINE**

Containing Providone iodine (1%): **ECZO-BETADINE**

Containing Miconazole (2%): **FLUCORT-MZ, TENOVATE-M**

Containing Clotrimazole (1%): **CLOBEN**

CHAPTER 65

Antiseptics, Disinfectants and Ectoparasiticides

ANTISEPTICS AND DISINFECTANTS

The terms *antiseptic* and *disinfectant* connote an agent which inhibits or kills microbes on contact. Conventionally, agents used on living surfaces (skin, mouth) are called *antiseptics* while those used for inanimate objects (instruments, privies, water supply) are called *disinfectants*. There is considerable overlap and many agents are used in either way. A practical distinction between the two on the basis of a *growth inhibiting versus direct lethal* action is futile because these are often concentration dependent actions. The term *Germicide* covers both category of drugs.

There, however, is difference between 'disinfection' and 'sterilization'. While sterilization means complete killing of all forms of microorganisms, disinfection refers to reduction in the number of viable pathogenic microbes to a level that they do not pose a risk to individuals with normal host defence. Thus, in ordinary usage, disinfectants do not eliminate all microbes.

The era of antiseptics and disinfectants was heralded by Semmelweiss (washing of hands in chlorinated lime) and Lister (antiseptic surgery by the use of phenol) in the 19th century. These germicides differ from systemically used antimicrobials by their low parasite selectivity—are too toxic for systemic use. However, many systemic antimicrobials are applied topically as well, and some antibiotics (bacitracin, neomycin) are restricted to topical

use, but are generally not enumerated with the antiseptics. A strict distinction is thus impossible.

A good antiseptic / disinfectant should be:

- (i) Chemically stable.
- (ii) Cheap.
- (iii) Nonstaining with agreeable colour and odour.
- (iv) Cidal and not merely static, destroying spores as well.
- (v) Active against all pathogens—bacteria, fungi, viruses, protozoa.
- (vi) Require brief time of exposure.
- (vii) Able to spread through organic films and enter folds and crevices.
- (viii) Active even in the presence of blood, pus, exudates and excreta.

A disinfectant in addition should not corrode or rust instruments and be easily washable. An antiseptic in addition should be:

- (i) Rapid in action and exert sustained protection.
- (ii) Nonirritating to tissues, should not delay healing.
- (iii) Nonabsorbable, produce minimum toxicity if absorbed.
- (iv) Nonsensitizing (no allergy).
- (v) Compatible with soaps and other detergents.

Spectrum of activity of majority of antiseptic-disinfectants is wide, reflecting nonselectivity of action. However, some are rather selective, e.g. hexachlorophene, chlorhexidine, quaternary ammonium antiseptics, gentian violet and acriflavin are more active on gram-positive than gram-negative bacteria; silver nitrate is highly active against gonococci and benzoyl peroxide against *P. acnes*.

Mechanisms of action of germicides are varied, but can be grouped into:

- (a) Oxidation of bacterial protoplasm.
- (b) Denaturation of bacterial proteins including enzymes.
- (c) Detergent like action increasing permeability of bacterial membrane.

Factors which modify the activity of germicides are:

- (i) Temperature and pH.
- (ii) Period of contact with the microorganism.
- (iii) Nature of microbe involved.
- (iv) Size of inoculum.
- (v) Presence of blood, pus or other organic matter.

Potency of a germicide is generally expressed by its *phenol coefficient* or *Rideal Walker coefficient*, which is the ratio of the minimum concentration of test drug required to kill a 24 hour culture of *B. typhosa* in 7.5 minute at 37.5°C to that of phenol under similar conditions. This test has only limited validity, particularly in relation to antiseptics which have to be tested on living surfaces.

Therapeutic index of an antiseptic is defined by comparing the concentration at which it acts on microorganisms with that which produces local irritation, tissue damage or interference with healing.

CLASSIFICATION

1. **Phenol derivatives:** Phenol, Cresol, Hexylresorcinol, Chloroxylenol, Hexachlorophene.

2. **Oxidizing agents:** Pot. permanganate, Hydrogen peroxide, Benzoyl peroxide.
3. **Halogens:** Iodine, Iodophores, Chlorine, Chlorophores.
4. **Biguanide:** Chlorhexidine.
5. **Quaternary ammonium (Cationic):** Cetrimide, Benzalkonium chloride, Dequalinium chloride.
6. **Soaps:** of Sod. and Pot.
7. **Alcohols:** Ethanol, Isopropanol.
8. **Aldehydes:** Formaldehyde, Glutaraldehyde.
9. **Acids:** Boric acid, Acetic acid.
10. **Metallic salts:** Merbromin, Silver nitrate, Silver sulfadiazine, Mild silver protein, Zinc sulfate, Calamine, Zinc oxide.
11. **Dyes:** Gentian violet, Acriflavine, Proflavine.
12. **Furan derivative:** Nitrofurazone.

1. PHENOLS

Phenol (Carbolic acid) It is one of the earliest used antiseptics and still the standard for comparing other germicides. It is a relatively weak agent (static at 0.2%, cidal at >1%, poor action on bacterial spores). It is a general *protoplasmic poison*, injuring microbes and tissue cells alike—at higher concentrations causes skin burns and is a caustic. It acts by disrupting bacterial membranes and denaturing bacterial proteins. Organic matter diminishes its action slightly while alkalies and soaps do so profoundly (carbolic soaps are not more germicidal than soap itself). It is now seldom employed as an antiseptic, but being cheap, it is used to disinfect urine, faeces, pus, sputum of patients and is sometimes included in antipruritic preparations because of its mild local anaesthetic action.

Cresol It is methyl-phenol; more active (3–10 times) and less damaging to tissues. Used for disinfection of utensils, excreta and for washing hands.

LYSOL is a 50% soapy emulsion of cresol.

Hexylresorcinol It is a more potent derivative of the phenolic compound resorcinol that is odourless and nonstaining; used as mouthwash, lozenge and as antifungal.

Chloroxyleneol It has a phenol coefficient of 70; does not coagulate proteins, is noncorrosive, nonirritating to intact skin, but efficacy is reduced by organic matter. It is poorly water soluble; the commercial 4.8% solution (**DETTOL**) is prepared in 9% terpinol and 13% alcohol; used for surgical antiseptics. A 0.8% skin cream and soap, 1.4% lubricating obstetric cream (for vaginal examination, use on forceps, etc.), and a mouthwash (**DETTOLIN 1%**) are also available. These preparations lose activity if diluted with water and kept for a time.

Hexachlorophene This chlorinated phenol acts by inhibiting bacterial enzymes and (in high concentration) causing bacterial lysis. It is odourless, nonirritating and does not stain. Its activity is reduced by organic matter but not by soap. It is commonly incorporated in soap and other cleansing antiseptics for surgical scrub, patient's skin, etc., but is narrow spectrum; kills gram-positive but not gram-negative bacteria or spores. The degerming action is slow but persistent due to deposition on the skin as a fine film that is not removed by rinsing with water.

Use of a 3% solution for baby bath markedly reduced the incidence of staphylococcal infections, but produced brain damage (especially in premature neonates). Around 1970 several fatalities occurred in USA. Since then use of preparations containing > 2% hexachlorophene have been banned. It is a good deodorant and is incorporated in many toilet products.

2. OXIDIZING AGENTS

Potassium permanganate It occurs as purple crystals, highly water soluble, liberates oxygen which oxidizes bacterial protoplasm. The available oxygen and germicidal capacity is used up if much organic matter is present—the solution gets decolourised. A 1:4000 to 1:10,000 solution (Condy's lotion) is used for gargling, douching,

irrigating cavities, urethra and wounds. The action is rather slow and higher concentrations cause burns and blistering—popularity therefore has declined.

It has also been used to disinfect water (wells, ponds) and for stomach wash in alkaloidal poisoning (except atropine and cocaine which are not efficiently oxidized). It promotes rusting and is not good for surgical instruments.

Hydrogen peroxide It liberates nascent oxygen which oxidizes necrotic matter and bacteria. A 30% solution produces 10 volumes of oxygen, much of which escapes in the molecular form. Catalase present in tissues speeds decomposition resulting in foaming—helps in loosening and removing slough, ear wax, etc. Hydrogen peroxide has poor penetrability and a weak, transient action. It loses potency on keeping. Use therefore is much restricted.

Benzoyl peroxide It is specifically active against *P. acnes* and used on acne vulgaris (see p. 852).

3. HALOGENS

Iodine It is a rapidly acting, broad-spectrum (bacteria, fungi, viruses) microbicidal agent; has been in use for more than a century. Acts by iodinating and oxidizing microbial protoplasm. A 1 : 20,000 solution kills most vegetative forms within 1 min. Even bacterial spores are killed with higher concentrations/longer contact. Organic matter retards but does not abolish its germicidal action.

Solid iodine is corrosive, stronger solutions (> 5%) cause burning and blistering of skin. *Tincture iodine* (2% in alcohol) stings on abrasions. It is used on cuts, for degerming skin before surgery, and to treat ring worm, etc. *Mandel's paint* (1.25% iodine dissolved with the help of Pot. iodide forming soluble I_3^- -ions) is applied on sore throat. A *nonstaining iodine ointment* (**IODEX 4%**) is popular as antiseptic and counterirritant. Some individuals are sensitive to iodine—rashes and systemic manifestations occur in them.

Iodophores These are soluble complexes of iodine with large molecular organic compounds that serve as carriers—release free iodine slowly.

The most popular—*Povidone (Polyvinylpyrrolidone) iodine*: is nonirritating, nontoxic, nonstaining and exerts prolonged germicidal action. Treated areas can be bandaged or occluded without risk of blistering. It is used on boils, furunculosis, burns, otitis externa, ulcers, tinea, monilial/trichomonal/nonspecific vaginitis and for surgical scrubbing, disinfection of endoscopes and instruments.

BETADINE 5% solution, 5% ointment, 7.5% scrub solution, 200 mg vaginal pessary; **PIODIN** 10% solution, 10% cream, 1% mouthwash; **RANVIDONE AEROSOL** 5% spray with freon propellant.

Chlorine A highly reactive element and a rapidly acting potent germicide, 0.1–0.25 ppm kills most pathogens (but not *M. tuberculosis*) in 30 sec. However, the degerming action is soon exhausted, and it lacks substantivity. It is used to disinfect urban water supplies. Organic matter binds chlorine, so that excess has to be added to obtain free chlorine concentration of 0.2–0.4 ppm. This is known as the ‘chlorine demand’ of water. Chlorine is more active in acidic or neutral medium.

Chlorophores These are compounds that slowly release hypochlorous acid (HOCl). Because of ease of handling, they are used in preference to gaseous chlorine.

(i) *Chlorinated lime (bleaching powder)* It is obtained by the action of chlorine on lime; resulting in a mixture of calcium chloride and calcium hypochlorite. On exposure, it decomposes releasing 30–35% W/W chlorine. It is used as disinfectant for drinking water, swimming pools and sanitizer for privies, etc.

(ii) *Sodium hypochlorite solution* Contains 4–6% sodium hypochlorite. It is a powerful disinfectant used in dairies for milk cans, other equipment and for infant feeding bottles. It is unstable and too irritant to be used as antiseptic, except for root canal therapy in dentistry.

4. BIGUANIDE

Chlorhexidine A powerful, nonirritating, cationic antiseptic that disrupts bacterial cell

membrane. A secondary action is denaturation of microbial proteins. It is relatively more active against gram-positive bacteria. Like hexachlorophene it persists on the skin. Present in **SAVLON** (see below), it is extensively used for surgical scrub, neonatal bath, mouthwash, obstetrics and as general skin antiseptic.

Chlorhexidine is the most widely employed antiseptic in dentistry. As 0.12–0.2% oral rinse or 0.5–1% toothpaste, it is highly active in preventing/treating gingivitis. Twice daily chlorhexidine oral rinse markedly reduces oral infections in immunocompromised patients, including AIDS. However, it may leave an unpleasant after taste, and repeated application causes brownish discolouration of teeth.

5. QUATERNARY AMMONIUM (CATIONIC) ANTISEPTICS

These are detergents; cidal to bacteria, fungi and viruses. However, many gram-negative bacteria (especially *Pseudomonas*), *M. tuberculosis* and bacterial spores are relatively resistant. They act by altering permeability of cell membranes and denaturing of bacterial proteins. Soaps, being anionic, neutralize their action, while alcohol potentiates. They spread through oil and grease, have cleansing and emulgent properties. They are nonirritating and mildly keratolytic. However, the germicidal action is rather slow and bacteria may thrive under a film formed by them on the skin. Pus, debris and porous material like cotton, polyethylene reduce their activity. Occasionally sensitization occurs. These disadvantages notwithstanding, they are widely used as sanitizers, antiseptic and disinfectant for surgical instruments, gloves, etc, but should not be considered sterilizing.

Cetrimide A soapy powder with a faint fishy odour. Used as 1–3% solution, it has good cleansing action, efficiently removing dirt, grease, tar and congealed blood from road side accident wounds. Alone or in combination with chlorhexidine, it is one of the most popular hospital

antiseptic and disinfectant for surgical instruments, utensils, baths, etc.

CETAVLON CONCENTRATE: Cetrimide 20%

SAVLON LIQUID ANTISEPTIC: Chlorhexidine gluconate 1.5% + Cetrimide 3%.

SAVLON/CETAVLEX CREAM: Chlorhexidine HCl 0.1% + Cetrimide 0.5%.

SAVLON HOSPITAL CONCENTRATE: Chlorhexidine gluconate 7.5% + Cetrimide 15%.

Benzalkonium chloride (Zephiran) It is highly soluble in water and alcohol. A 1:1000 solution is used for sterile storage of instruments and 1 in 5000 to 1 in 10,000 for douches, irrigation, etc.

Dequalinium chloride Has been used in gum paints and lozenges.

DEQUADIN 0.25 mg lozenges.

6. SOAPS

Soaps are anionic detergents; weak antiseptics, affect only gram-positive bacteria. Their usefulness primarily resides in their cleansing action. Washing with soap and warm water is one of the most effective methods of preventing transmission of infection by removing/diluting pathogenic bacteria. Soaps can be medicated by other antiseptics.

7. ALCOHOLS

Ethanol It is an effective antiseptic and cleansing agent at 40–90% concentration. The rapidity of action increases with concentration upto 70% and decreases above 90%. It acts by precipitating bacterial proteins. A cotton swab soaked in 70% ethanol rubbed on the skin kills 90% bacteria in 2 min.; has been used before hypodermic injection and on minor cuts. Low concentrations enhance the antiseptic activity of iodine and chlorhexidine when used as solvent for these. It is an irritant and should not be applied to mucous membranes or to delicate skin (scrotum), ulcers, etc. On open wounds it produces a burning sensation, injures the surface and forms a coagulum under which bacteria could grow. It is a poor disinfectant for instruments—does not kill spores and promotes rusting.

Isopropanol It is less volatile; can be used in place of ethanol.

8. ALDEHYDES

Formaldehyde It is a pungent gas—sometimes used for fumigation. A 37% aqueous solution called *Formalin* is diluted to 4% and used for hardening and preserving dead tissues. It denatures proteins and is a general protoplasmic poison, but acts slowly. A broad-spectrum germicide, but use as antiseptic is restricted by its irritating nature and pungent odour. It is occasionally employed to disinfect instruments and excreta. Those who handle formalin can develop eczematoid reactions. The urinary antiseptic methenamine acts (*see* p. 735) by releasing formaldehyde in acidic urine. Formaline is also used to precipitate *toxoids* from toxins.

Glutaraldehyde It is less volatile, less pungent, less irritating and better sterilizing agent than formalin, but needs to be activated by alkalization of the solution. It exerts broad-spectrum activity against bacteria, fungi and viruses. Organic matter does not inactivate it. A 2% solution is used to disinfect surgical instruments and endoscopes, but prolonged contact is needed. Repeated application on skin can cause sensitization. The alkalized solution has a short shelf life (2 weeks) unless stabilizing agents are added.

9. ACIDS

Boric acid It is only bacteriostatic and a very weak antiseptic. But being nonirritating even to delicate structures, saturated aqueous solutions (4%) have been used for irrigating eyes, mouthwash, douche, etc. Boroglycerine paint (30%) is used for stomatitis and glossitis. A 10% ointment (**BOROCIDE**) is available for cuts and abrasion. It is included in prickly heat powders and ear drops. However, boric acid is not innocuous; systemic absorption causes vomiting, abdominal pain, diarrhoea, visual disturbances and kidney damage. Hence its use for irrigating bladder, large wounds, as ointment on extensive

burnt areas, liberal use of powder for infants is not recommended.

Acetic acid It is a relatively weak antiseptic, bactericidal only above 5%. *Pseudomonas* is especially susceptible. It is occasionally used for burn dressing and for douche in 1–3% strength.

10. METALLIC SALTS

Mercury compounds They act as bacteriostatic by inactivating SH enzymes. Though, generally considered potent, mercurials are actually poor antiseptics with low therapeutic index. Mercury is considered an environmental hazard, and use of mercurial antiseptics is not recommended.

Silver compounds These are astringent and caustic. They react with SH, COOH, PO₄ and NH₂ groups of proteins.

Water stored in silver vessels is said to become sterile. As the concentration of Ag⁺ ions is very low, this has been called '*Oligodynamic action*'.

(i) **Silver nitrate** rapidly kills microbes, action persisting for long periods because of slow release of Ag⁺ ions from silver proteinate formed by interaction with tissue proteins. Tissues get stained black due to deposition of reduced silver. Silver nitrate touch is used for hypertrophied tonsillitis and aphthous ulcers. It is highly active against gonococci—1% solution is used for ophthalmia neonatorum.

(ii) **Silver sulfadiazine** (see p. 684) is highly active against *Pseudomonas* and has been used on burns.

Zinc salts They are astringent and mild antiseptics.

(i) **Zinc sulfate**: is highly water soluble, 0.1–1% is used for eyewash and in eye/ear drops (Zinc-boric acid drops—in **ZINCO-SULFA 0.1% eye drop**). Applied to skin, it decreases perspiration. *White lotion* containing 4% each of zinc sulfate and sulfurated potash has been used for acne and impetigo; (**THIOSOL 2.5%**, **THIOSOL FORTE 4% lotion**).

(ii) **Calamine and zinc oxide**: are insoluble. In addition to being mildly antiseptic, they are popular dermal protectives and adsorbants.

11. DYES

Gentian violet (crystal violet) A rosaniline dye active against staphylococci, other gram-positive bacteria and fungi, but gram-negative organisms and mycobacteria are insensitive. Aqueous or alcoholic solution (0.5–1%) is used on furunculosis, bedsores, chronic ulcers, infected eczema, thrush, Vincent's angina, ringworm, etc. It has become unpopular due to deep staining.

Acriflavine and Proflavine These are orange-yellow acridine dyes active against gram-positive bacteria and gonococci. Their efficacy is not reduced by organic matter and is enhanced in alkaline medium. Solutions lose efficacy on exposure to light—store in amber bottles. They are nonirritant and do not retard healing—particularly suitable for chronic ulcers and wounds. Bandage impregnated with acriflavine-vaseline is used for burn dressing;

ACRINOL 0.1% acriflavine cream.

The *triple dye lotion* contains gentian violet 0.25% + brilliant green 0.25% + acriflavine 0.1% (**TRIPLE DY**), has been used for burns and for dressing umbilical stump in neonates.

12. FURAN DERIVATIVES

Nitrofurazone It is cidal to both gram-positive and negative, aerobic and anaerobic bacteria, even in high dilutions, but activity is reduced in the presence of serum. Acts by inhibiting enzymes necessary for carbohydrate metabolism in bacteria. It is highly efficacious in burns and for skin grafting. Its local toxicity is negligible—but sensitization occurs frequently.

FURACIN 0.2% cream, soluble ointment, powder.

Nitrofurantoin and Furazolidone are other furan derivatives used for urinary and intestinal infections respectively.

ECTOPARASITICIDES

These are drugs used to kill parasites that live on body surface. Lice (*Pediculus sp.*—wingless insects) and mites (*Sarcoptes/Acarus scabiei*—arachnids) are minute arthropods infesting human skin and hair.

Scabies It is highly contagious; the mite burrows through the epidermis, laying eggs which form papules that itch intensely. Lesions may get secondarily infected requiring systemic antimicrobial therapy. The finger webs are the preferred sites of entry, but may soon spread to forearms, trunk, genitals and lower legs. Other members of the patient's family should be treated concurrently; garments and bed linen should be washed in hot water and put in sun to prevent cross infection and re-infection.

Pediculosis The lice thrive on head (*P. capitis*), body (*P. corporis*) or pubic region (*P. pubis*). They cause itching, suck blood and transmit typhus and relapsing fever. The eggs called *nits* get attached to the hair and clothing by a chitin like cement.

Drugs used are:

Permethrin	Sulfur
Lindane (BHC)	Dicophane (DDT)
Benzyl benzoate	Ivermectin
Crotamiton	

1. Permethrin This broad-spectrum and potent pyrethoid insecticide is currently the most efficacious and most convenient drug for both scabies and lice. It causes neurological paralysis in insects, probably by delaying depolarization. Toxicity of permethrin in humans is very low; apparently 40–400 times lower than that of lindane. After application, permethrin persists on the skin for days; systemic absorption is minimal. Nearly 100% cure rates have been obtained in scabies and pediculosis; comparative studies have found it to be more effective than lindane, benzyl benzoate and crotamiton. Single application is needed in most cases. Resistance to permethrin is very rare and it is effective in lindane nonresponsive cases. Few patients may experience mild and transient burning, itching, tingling, erythema or rash.

For scabies: PERMITE, OMITE, NOMITE 5% cream; apply all over the body except face and head; wash after 8–12 hours. SCABERID 5% cream, 1% soap; SCABPER 5% lotion.

For head lice: PERLICE, KERALICE 1% cream rinse, ELICE 5% lotion, SCALTIX 1% lotion; massage about 30 g into the scalp, washoff after 10 min.

Thus, permethrin is now the 1st choice drug for scabies and pediculosis

2. Lindane (Gamma benzene hexachloride, BHC) Another broad-spectrum insecticide which kills lice and mites by penetrating through their chitinous cover and affecting the nervous system. Lindane is highly effective in treating headlice (67–92% cure) and scabies (84–92% cure) by single treatment. However, efficacy is lower than permethrin. Both lice and mites can develop resistance to lindane. Combining it with benzyl benzoate precludes resistance and improves cure rate to nearly 100%.

GAB 1% lotion, ointment; GAMADERM, SCABOMA 1% lotion; GAMASCAB 1% lotion, cream; ASCABIOL 1% emulsion with cetrimide 0.1%; BENZO 1% lotion, 1% soap.

For pediculosis: apply to scalp and hair (taking care not to enter eyes), leave for 12–24 hr. (a shower cap may be used for long hair) and then wash off. If lice are still present, repeat treatment after 1 week.

For scabies: the lotion/cream is rubbed over the body (below neck) and a scrub bath taken 12–24 hr later. Single treatment suffices in most patients; can be repeated only after a week, if the mite is still present.

The disadvantages of lindane are:

Being highly lipid soluble it can be absorbed through the skin (especially from oily vehicles and in small children)— can produce systemic toxicity—CNS stimulation, vertigo, convulsions (especially in children) and cardiac arrhythmias.

Absorbed lindane is widely distributed in the body, especially in fat; is metabolised and eliminated with a $t_{1/2}$ ~24 hr. It can induce CYP isoenzymes in liver and affect metabolism of many drugs.

Though well tolerated by most patients if instructions are followed, it is less favoured for treatment of scabies—because application over large body surface is required—possibility of systemic absorption is more. It should be avoided in infants, young children and during pregnancy. Skin irritation is not prominent.

3. Benzyl benzoate It is an oily liquid with faint aromatic smell; has been popular for treatment of scabies. The emulsion is applied all

over except face and neck after a cleansing bath. A second coat is applied next day which is washed after 24 hours. The treatment is convenient and does not interfere with routine activities. It has achieved 76–100% cure in scabies. Benzyl benzoate is minimally absorbed through the skin; systemic toxicity is low, but neurological symptoms have occurred in children—contraindicated in them. Skin irritation is common, especially in children. Contact dermatitis is possible.

BENZYL BENZOATE APPLICATION 25% lotion; **DERMIN** 25% lotion; **SCABINDON** 25% oint with DDT 1% and benzocaine 2%

For pediculosis, it can be applied to the scalp, taking care not to enter eyes, and is washed off after 24 hours. Benzyl benzoate is now a 2nd choice drug for scabies and seldom used for pediculosis. Its combination with lindane is highly effective.

4. Crotamiton It is an effective scabicide, pediculocidal and antipruritic, but has produced lower cure rates (60–88%) in scabies. Better results have been obtained by extended 5 day application in children. It is less prone to cause skin irritation and has low systemic toxicity despite absorption through the skin—may be preferred for children. It is applied twice at 24 hr interval and washed off day after that.

CROTORAX, CROTON 10% cream, lotion

Because of lower efficacy and need for repeat application, it is a second choice drug for scabies and pediculosis.

5. Sulfur It is the oldest scabicide and weak pediculocidal, antiseptic, fungicide and keratolytic. Applied to skin it is slowly reduced to H₂S and oxidized to SO₂ and *pentathionic acid*. These, especially the latter, dissolve the

cuticle of itch mite and kill it. The reactions are carried out by epidermal cells and the arthropods themselves.

Sublimed sulfur or precipitated sulfur is used as a 10% ointment. After a warm scrubbing bath (to open the burrows) the ointment is massaged over the entire body (below the neck) for 3 consecutive days, followed by soap water bath on the fourth day. It is cheap but has disadvantages:

- (a) Treatment is messy.
 - (b) Produces bad odour—socially unacceptable—may interfere with patient's vocation.
 - (c) Repeated applications are required.
- Sulfur has been superseded by better drugs.

6. Dicophane (DDT) It has been a popular insecticide for mosquitoes, flies and other pests. For this purpose, it is used in the dust or watery suspension form, which is poorly absorbed through skin. For pediculosis and scabies a 1–2% lotion or ointment is applied and washed off after 12–24 hours. It penetrates through the exoskeleton and acts as a neurotoxin for the arthropods. When oily vehicles are used, significant amounts may be absorbed through the skin and cause rashes, muscle weakness, tremor. Very high doses produce BHC like convulsions. It gets stored in body fat and induces microsomal enzymes. Combination with benzyl benzoate (**SCABINDON oint**) is more effective. It is rarely used.

7. Ivermectin This anthelmintic drug (*see* p. 813) has been found highly effective in scabies and pediculosis as well. It is the only orally administered drug used for ectoparasitosis. A single 0.2 mg/kg (12 mg in adults) dose has cured upto 91–100% patients of scabies. AIDS patients with scabies also respond. Most cases of head/body lice have been successfully treated.

Ivermectin is very well tolerated by scabies/pediculosis patients, with few if any side effects. However, it is not to be given to children < 5 yr, pregnant and lactating women. Though experience is still limited, ivermectin appears to have the potential of a first line drug for scabies and pediculosis.



These are drugs which complex metallic ions, forming ring structures within their molecule (Greek *Chele* = Crab; the compound holds the metal like a crab's claw). They are primarily used in heavy metal poisonings.

Those compounds which form stable, non-toxic and easily excreted complexes with toxic metals are valuable in poisonings. The useful agents contain two or more reactive groups (ligands) which can hold the metal from at least two sides so that a ring is formed. When the ring is 5–7 membered, it is most stable.

Ligand is a functional group capable of forming coordinate bond, i.e. a covalent bond in which both the shared electrons are donated by the ligand—generally O, N, or S atoms in hydroxyl, carboxyl, keto, sulphydryl, disulfide, amino or phosphate groups.

Heavy metals exert their toxic effects by combining with and inactivating functional groups (ligands) of enzymes or other critical biomolecules. Chelating agents compete with body ligands for the heavy metal. They differ in their affinity for different metals. Clinically useful agents should have a higher affinity for the toxic metal than for calcium, because Ca^{2+} is readily available in plasma and extracellular fluid. They

should also have higher affinity than the body ligands for the toxic metal. Moreover, to be effective in metal poisoning, their distribution in the body should correspond to that of the metal to be chelated, and they should be water soluble.

Efficacy of all chelating agents in promoting excretion of the toxic metal and in reversing toxic manifestations declines rapidly as the interval between entry of the metal in the body and the administration of the chelator increases.

Chelating agents useful as drugs are:

Dimercaprol (BAL)	Calcium disodium DTPA
Dimercaptosuccinic acid (Succimer)	Penicillamine
Disodium edetate	Desferrioxamine
Calcium disodium edetate	Deferiprone

Dimercaprol (British antilewisite; BAL)

It is an oily, pungent smelling, viscous liquid, developed during World War II by Britishers as an antidote to the arsenical war gas *lewisite*. The two SH groups of dimercaprol bind those metals which produce their toxicity by interacting with sulphydryl containing enzymes in the body, i.e. As, Hg, Au, Bi, Ni, Sb, Cu. The complex of 2

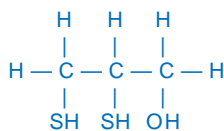

DIMERCAPROL

molecules of dimercaprol with one metal ion is more stable than 1:1 complex. It is, therefore, desirable to maintain excess of dimercaprol in plasma to allow formation of 2 : 1 complex. The dimercaprol-metal complex spontaneously dissociates releasing the metal at a slow rate; also dimercaprol is partly oxidized in the body: further emphasizing the necessity to have excess dimercaprol available. But due to dose dependent toxicity of dimercaprol, large amounts should not be given at a time.

Uses

- Poisoning by As, Hg, Au, Bi, Ni, Sb: it is administered i.m., 5 mg/kg *stat*, followed by 2–3 mg/kg every 4–8 hours for 2 days, then once or twice a day for 10 days. It is partly oxidized and glucuronide conjugated, but mainly excreted as such in 4–6 hours. Earlier the treatment is instituted, the better it is. Because the dimercaprol-metal complex dissociates faster in acidic urine and the released metal can damage the kidney, urine is alkalinized during dimercaprol therapy.
- As an adjuvant to Cal. disod. edetate in lead poisoning.
- As an adjuvant to penicillamine in Cu poisoning and in Wilson's disease—300 mg/day i.m. for 10 days every second month.

BAL INJ 100 mg/2 ml (in arachis oil) inj.

It is contraindicated in iron and cadmium poisoning, because the dimercaprol-Fe and dimercaprol-Cd complex is itself toxic.

Adverse effects These are frequent, dose related and distressing, but generally not damaging. Rise in BP, tachycardia, vomiting, tingling and burning sensations, inflammation of mucous membranes, sweating, cramps, headache and anxiety.

Antihistaminics given 30 min before dimercaprol injection, reduce the intensity of adverse effects.

Dimercaptosuccinic acid (Succimer) It is similar to dimercaprol in chelating properties, water soluble, less toxic and orally effective. Its efficacy has been demonstrated in As, Hg and Pb poisoning. It has been marketed in USA and some other countries, but not in India for the treatment of lead intoxication. Side effects are nausea, anorexia and loose motions.

Disodium edetate (Na₂EDTA) It is the disodium salt of ethylene diamine tetraacetic acid (EDTA). It is a potent chelator of calcium—causes tetany on i.v. injection. When a slow infusion is given, tetany does not occur, because calcium is withdrawn from bones. It can be used for emergency control of hypercalcaemia: 50 mg/kg i.v. infusion over 2–4 hours, but bisphosphonates are preferred.

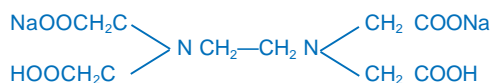

DISODIUM EDETATE

Calcium disodium edetate (Ca Na₂ EDTA)

It is the calcium chelate of Na₂ EDTA. Because this chelating agent has higher affinity for metals like Pb, Zn, Cd, Mn, Cu and some radioactive metals, it can remove them from the body by exchanging with Ca held by it. It is highly ionized, therefore distributed only extracellularly and rapidly excreted in urine by glomerular filtration ($t_{1/2} \leq 1$ hour) carrying the toxic metal along. It is not metabolized. Because of its ionic nature, Ca Na₂ EDTA is not absorbed from the g.i.t.—must be given parenterally. Since i.m. injection is painful, preferred route is i.v. It does not enter brain or CSF. Thus, it can remove toxic metals only from accessible sites.

Uses

- Lead poisoning** This is the most important indication for CaNa₂EDTA; 1 gm is diluted to 200–300 ml in saline or glucose solution and infused i.v. over 1 hour twice daily for 3–5 days. The urinary excretion of Pb is promptly increased, but declines quickly as the metal is removed from accessible sites (primarily bone). A second course of CaNa₂EDTA may be repeated after 5–7 days,

allowing time for Pb to redistribute to extracellular sites.

2. It is also useful in Fe, Zn, Cu, Mn and radioactive metal, but not Hg poisoning, because Hg is more firmly bound to body constituents and is localized in areas not accessible to CaNa_2EDTA .

Adverse effects CaNa_2EDTA does not produce tetany and is relatively safe.

Kidney damage with proximal tubular necrosis is the most important problem. This is roughly dose-related and may be due to the toxic metal partly dissociating in the tubule. It can be minimized by maintaining high urine flow.

An acute febrile reaction with chills, bodyache, malaise, tiredness occurs in some individuals.

Anaphylactoid reaction with fall in BP and congestion of eyes and nose is also reported.

Calcium disodium DTPA Diethylene triamine penta acetic acid (DTPA, Pentetic acid) is a congener of EDTA. It has higher affinity for many heavy metals than EDTA. Its calcium chelate has been used in metal poisonings (especially radioactive metals like uranium, plutonium) which do not respond to CaNa_2EDTA . However, because of its limited distribution in the body, results are not impressive.

Penicillamine

It is dimethyl cysteine, obtained as a degradation product of penicillin. It was found to have strong copper chelating property and was used in 1956 for Wilson's disease. It selectively chelates Cu, Hg, Pb and Zn. The d-isomer is used therapeutically, because the l-isomer and the racemate produce optic neuritis and are more toxic. It is adequately absorbed after oral administration, little metabolized in the body and excreted in urine and faeces. When given to patients with heavy metal toxicity, excretion of the metal is enhanced.

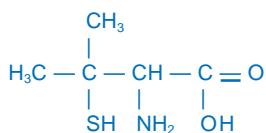

PENICILLAMINE

Uses

1. Wilson's disease (Hepatolenticular degeneration): This is due to genetic deficiency of ceruloplasmin, a protein which normally binds and disposes off Cu from the body. In its absence, plasma concentration of free Cu is high which gets deposited in liver, substantia nigra, basal ganglia of brain, and causes local degeneration. Life long therapy is needed to prevent progression of the disease.

Dose: 0.5–1 g daily in divided doses 1 hour before or 2 hour after meals to avoid chelation of dietary metals.

ARTAMIN, CILAMIN 250 mg cap, ARTIN 150, 250 mg cap.

Pot. sulfide 20–40 mg may be given with each meal to decrease the absorption of dietary copper.

2. Copper/mercury poisoning: 1–1.5 g/day is given for a few days. It is the drug of choice for Cu poisoning and alternative drug to dimercaprol/succimer for Hg poisoning.

3. Chronic lead poisoning: It may be used as an adjuvant to CaNa_2EDTA , but succimer is preferred.

4. Cystinuria and cystine stones: It promotes the excretion of cysteine and prevents its precipitation in the urinary tract, because penicillamine-cysteine complex is more soluble than dicysteine (cystine).

5. Scleroderma: Penicillamine benefits by increasing soluble collagen.

It was used as a disease modifying drug in rheumatoid arthritis, but has been replaced now by safer drugs (*see p. 204*).

Adverse effects Short-term administration (as metal chelator) of penicillamine does not cause much problem. Various cutaneous reactions, itching and febrile episodes may occur. However, long-term use produces pronounced toxicity. Dermatological, renal, haematological and collagen tissue toxicities are prominent.

Desferrioxamine

Ferrioxamine is a long chain iron containing complex obtained from an actinomycete. Chemical removal of iron from it yields deser-

rioxamine which has very high affinity for iron: 1g is capable of chelating 85 mg of elemental iron. The straight chain desferrioxamine molecule winds round ferric iron and forms a stable nontoxic complex which is excreted in urine. It removes loosely bound iron as well as that from haemosiderin and ferritin, but not from haemoglobin or cytochrome. Another desirable property is its low affinity for calcium.

Little of orally administered desferrioxamine is absorbed. Parenterally administered desferrioxamine is partly metabolized and rapidly excreted in urine.

Uses

1. Acute iron poisoning: mostly in children. This is the most important indication—may be life saving (*see* p. 587).
2. Transfusion siderosis: occurs in thalassemia patients who receive repeated blood transfusion. Desferrioxamine 0.5–1 g/day i.m. helps to excrete the chronic iron overload; may also be infused i.v. concurrently with blood transfusion—2 g per unit of blood.

Adverse effects Desferrioxamine can cause histamine release → fall in BP, flushing, itching,

urticaria, rashes. A variety of allergic reactions are reported. Changes in lens and retina can occur on repeated use.

Other side effects are abdominal pain, loose motions, muscle cramps, fever and dysuria.

DESFERAL 0.5 g/vial inj.

Deferiprone

It is an orally active iron chelator which has simplified the treatment of transfusion siderosis in thalassemia patients. Excessive haemolysis occurs in these patients, and they have to be given repeated blood transfusions. An iron chelator has to be used to clear the resulting iron overload. Oral deferiprone is a somewhat less effective alternative to injected desferrioxamine. Side effects and cost of treatment are reduced. Deferiprone has also been indicated for acute iron poisoning (less effective than desferrioxamine) and for iron load in liver cirrhosis.

Dose: 50–100 mg/kg daily in 2–4 divided doses.

KELFER 250, 500 mg caps.

Side effects are anorexia, vomiting, altered taste, joint pain, reversible neutropenia, rarely agranulocytosis. However, long-term safety is not yet known.

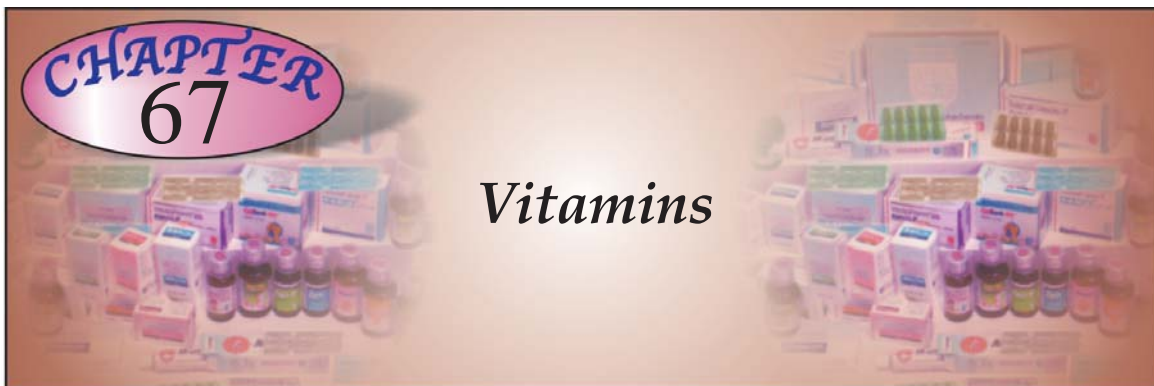

Vitamins are nonenergy producing organic compounds, essential for normal human metabolism, that must be supplied in small quantities in the diet. This definition excludes the inorganic essential trace minerals and essential amino acids and fatty acids which are required in much larger quantities. Other substances needed for proper growth of microorganisms or cells in culture are called 'growth factors'. The different chemical forms and precursors of a vitamin can be called its *Vitimers* (analogy—isomers).

The importance of vitamins as drugs is primarily in the prevention and treatment of deficiency diseases. Some vitamins do have other empirical uses in pharmacological doses. Vitamin deficiencies occur due to inadequate intake, malabsorption, increased tissue needs, increased excretion, certain genetic abnormalities and drug-vitamin interactions.

Vitamins, as a class, are over-promoted, over-prescribed and over-used. Myths like 'they energise the body', 'any physical illness is accompanied by vitamin deficiency', 'vitamin intake in normal diet is precariously marginal', 'they are harmless' are rampant.

Vitamins are traditionally divided into two groups:

(a) **Fat-soluble** (A, D, E, K): These (except vit K) are stored in the body for prolonged periods and are liable to cause cumulative toxicity after regular ingestion of large amounts. Some interact with specific cellular receptors analogous to hormones.

(b) **Water-soluble** (B complex, C): These are meagerly stored: excess is excreted with little chance of toxicity. They act as cofactors for specific enzymes of intermediary metabolism.

Vitamin D (Ch. 24), K (Ch. 44), folic acid and B₁₂ (Ch. 43) have already been considered. Some relevant information is tabulated in Table 67.1.

FAT-SOLUBLE VITAMINS

VITAMIN A

Chemistry and source Vitamin A occurs in nature in several forms. *Retinol* (Vit. A₁) is an unsaturated alcohol containing an 'ionone' ring. Marine fish (cod, shark, halibut) liver oils are rich sources. Appreciable amounts are present in egg yolk, milk and butter.

Dehydroretinol (Vit A₂) is present in fresh water fishes. *Carotenoids* are pigments found in green plants (carrot, turnip, spinach), β *Carotene* is the most important carotenoid. It is inactive as such,

one molecule splits to provide two molecules of retinol. Man on normal diet gets half of his vit A as retinol esters and half from carotenoids.

1 μ g of retinol = 3.3 IU of vit. A activity

It is now called 1 *Retinol Equivalent* = 6 μ g of dietary carotene (because of incomplete utilization of the provitamin).

Absorption and fate Retinyl palmitate, the chief retinyl ester in diet, is hydrolysed in intestines to retinol which is absorbed by carrier transport and reesterified. Aided by bile, it passes into lacteals. Absorption is normally complete, but not in steatorrhoea, bile deficiency and from protein poor diet. Retinol ester circulates in chylomicrons and is stored in liver cells. Free retinol released by hepatocytes combines with *retinol binding protein* (RBP a plasma globulin) and is transported to the target cells. On entering them, it gets bound to the *cellular retinol binding protein* (CRBP). Small amount is conjugated with glucuronic acid, excreted in bile, undergoes enterohepatic circulation. Minute quantities of water soluble metabolites are excreted in urine and faeces.

In contrast to retinol, only 30% of dietary β carotene is absorbed. It is split into two molecules of *retinal* in the intestinal wall; only half of this is reduced to retinol and utilized.

Physiological role and actions

(a) **Visual cycle** Retinal generated by reversible oxidation of retinol is a component of the light sensitive pigment *Rhodopsin* which is synthesized by rods during dark adaptation. This pigment gets bleached and split into its components by dim light and in the process generates a nerve impulse through a G-protein called *Transducin*. Retinal so released is reutilized. A similar pigment (Iodopsin) is synthesized in the cones—responsible for vision in bright light, colour vision and primary dark adaptation. In vit. A deficiency rods are affected more than cones; irreversible structural changes with permanent night blindness occur if the deprivation is long-term.

(b) **Epithelial tissue** Vit. A promotes differentiation and maintains structural integrity of epithelia all over the body. It also promotes mucus secretion, inhibits keratinization and improves resistance to infection. It appears to have the

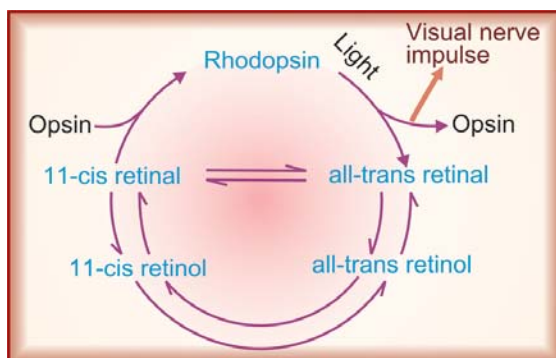

Fig. 67.1: The role of vit. A in visual cycle

ability to retard development of malignancies of epithelial structures. Vit A is also required for bone growth.

(c) **Reproduction** Retinol is needed for maintenance of spermatogenesis and foetal development.

(d) **Immunity** Increased susceptibility to infection occurs in vit A deficiency. Physiological amount of vit A appears to be required for proper antibody response, normal lymphocyte proliferation and killer cell function.

Deficiency symptoms Since vit. A is stored in liver, deficiency symptoms appear only after long-term deprivation, but vit A deficiency is quite prevalent, especially among infants and children in developing countries. Manifestations are:

- Xerosis (dryness) of eye, 'Bitot's spots', keratomalacia (softening of cornea), corneal opacities, night blindness (nyctalopia) progressing to total blindness.
- Dry and rough skin with papules (phrynoderma), hyperkeratinization, atrophy of sweat glands.
- Keratinization of bronchopulmonary epithelium, increased susceptibility to infection.
- Unhealthy gastrointestinal mucosa, diarrhoea.
- Increased tendency to urinary stone formation due to shedding of ureteric epithelial lining which acts as a nidus.
- Sterility due to faulty spermatogenesis, abortions, foetal malformations.

- Growth retardation, impairment of special senses.

Therapeutic uses

1. Prophylaxis of vit A deficiency during infancy, pregnancy, lactation, hepatobiliary diseases, steatorrhoea: 3000–5000 IU/day.
2. Treatment of established vit A deficiency: 50,000–100,000 IU i.m or orally for 1–3 days followed by intermittent supplemental doses.
3. Skin diseases like acne, psoriasis, ichthyosis. Retinoic acid (*see below*) and 2nd or 3rd generation retinoids are used.

Interactions

- (i) Vit E promotes storage and utilization of retinol and decreases its toxicity.
- (ii) Regular use of liquid paraffin by carrying through with it vit A can result in deficiency.
- (iii) Long-term oral neomycin induces steatorrhoea and interferes with vit A absorption.

Hypervitaminosis A Regular ingestion of gross excess of retinol (100,000 IU daily for months) has produced toxicity—nausea, vomiting, itching, erythema, dermatitis, exfoliation, hair loss, bone and joint pains, loss of appetite, irritability, bleeding, increased intracranial tension and chronic liver disease. Excess retinol is also teratogenic in animals and man. Daily intake should not exceed 20,000 IU.

Acute poisoning has been described after consumption of polar bear liver which contains 30,000 IU/g vit A. Single massive ingestion (> one million IU) produces intense headache, drowsiness, irritability, rise in intracranial tension, vomiting, liver enlargement and shedding of skin. Due to saturation of RBP, excess retinol esters circulate in the free state or loosely associated with lipoprotein. These have surfactant property which damages tissues.

Treatment consists of stopping further ingestion, supportive measures, and vit E which promotes storage of retinol in tissues and speeds recovery. Most signs regress in a week, some persist for months. Excess intake of carotenoids does not produce hypervitaminosis A, because conversion to retinol has a ceiling.

Retinoic acid (vit A acid) Retinoic acid has vit A activity in epithelial tissues and promotes

growth, but is inactive in eye and reproductive organs. All-trans retinoic acid (Tretinoin) is used topically, while 13-cis retinoic acid (Isotretinoin) is given orally for acne (*see Ch. 64*). Unlike retinol, it is not stored but rapidly metabolized and excreted in bile and urine.

The *cellular retinoic acid binding protein (CRABP)* is different from CRBP, is present in skin and other tissues but not in retina—this may be the reason for the inability of retinoic acid to participate in visual cycle.

Retinoid receptors Retinol and retinoic acid act through *nuclear retinoid receptors* which function in a manner analogous to the steroid receptors: activation results in modulation of protein synthesis. In the target cells (epithelial, gonadal, fibroblast) synthesis of certain proteins is enhanced while that of other proteins is depressed—accounting for the structural and functional changes. Two distinct families of retinoid receptors, *viz. Retinoic acid receptors (RARs)* and *Retinoid X receptors (RXRs)* have been identified with differing affinities for different retinoids.

VITAMIN E

Chemistry and source A number of tocopherols, of which α tocopherol is the most abundant and potent, have vit E activity. The *d*-isomer is more potent than *l*-isomer. Wheat germ oil is the richest source, others are cereals, nuts, spinach and egg yolk.

1 mg of *d* α -tocopherol is called α -tocopherol equivalent = 1.49 IU of vit E.

The daily requirement of vit. E is estimated at 10 mg. It is increased by high intake of polyunsaturated fats.

Absorption and fate Vit. E is absorbed from intestine through lymph with the help of bile; it circulates in plasma in association with β -lipoprotein, is stored in tissues and excreted slowly in bile and urine as metabolites.

Physiological role and actions Vit E acts as *antioxidant*, protecting unsaturated lipids in cell membranes, coenzyme Q, etc. from free radical oxidation damage and curbing generation of toxic

peroxidation products. Feeding animals with polyunsaturated fats increases vit E requirement, while antioxidants like cystein, methionine, selenium, chromenols prevent some vit E deficiency symptoms in animals. However, vit E might be having some more specific action or a structural role in biological membranes, because other deficiency symptoms are not relieved by these unrelated antioxidants.

Deficiency symptoms Experimental vit E deficiency in animals produces recurrent abortion, degenerative changes in spinal cord, skeletal muscles and heart, and haemolytic anaemia. No clear-cut vit E deficiency syndrome has been described in humans, but vit E deficiency has been implicated in certain neuromuscular diseases in children, neurological defects in hepatobiliary disease and some cases of haemolytic anaemia.

Therapeutic uses

1. Primary vit E deficiency does not occur clinically. Supplemental doses (10–30 mg/ day) may be given to patients at risk (*see above*).
2. G-6-PD deficiency—prolonged treatment with 100 mg/day increases survival time of erythrocytes.
3. Acanthocytosis—100 mg /week i.m: normalizes oxidative fragility of erythrocytes.
4. The risk of *retrolental fibroplasia* in premature infants exposed to high oxygen concentrations can be reduced by 100 mg/kg/day oral vitamin E.
5. Alongwith vit A to enhance its absorption and storage, and in hypervitaminosis A to reduce its toxicity.
6. Large doses (400–600 mg/day) have been reported to afford symptomatic improvement in intermittent claudication, fibrocystic breast disease and nocturnal muscle cramps.

For its antioxidant property, vit E has been promoted for recurrent abortion, sterility, menopausal syndrome, toxemia of pregnancy, atherosclerosis, ischaemic heart disease, cancer prevention, several skin diseases, prevention of neurodegenerative disorders, postherpetic neuralgia, scleroderma and many other conditions, but without convincing evidence of benefit.

Toxicity Even large doses of vit E for long periods have not produced any significant toxicity, but

creatinuria and impaired wound healing have been reported; abdominal cramps, loose motions and lethargy have been described as side effects of vit. E.

Vit E can interfere with iron therapy.

Antioxidant vitamins (vit E, β carotene, vit C) in prevention of cardiovascular disease and cancer

Antioxidants are believed to quench free radicals. Free radicals are atoms or molecules with 'singlet', i.e. unpaired electron which makes them highly reactive. Oxidative free radicals are generated by metabolic reactions—create a chain reaction leading to membrane lipid peroxidation, DNA damage, etc. Free radical oxidation has been implicated in atherosclerosis (oxidized LDL is more atherogenic), cancers, neurodegenerative diseases and inflammatory bowel diseases. Many endogenous and dietary compounds like superoxide dismutase, ferritin, transferrin, ceruloplasmin, α tocopherol, β carotene and ascorbic acid have antioxidant and free radical scavenging properties. On this theoretical basis supported by some epidemiological observations, cohort studies and prospective trials β carotene, vit C and especially vit E have been claimed to protect against atherosclerosis leading to coronary artery disease as well as many types of cancers (lung, breast, mouth, skin, esophagus, stomach, etc.). As a result, vit E and others are being aggressively promoted and many physicians are prescribing them for prophylaxis of these conditions. Learning from mass media, people on their own also are consuming them on a large scale. However, the evidence of a beneficial effect is highly contradictory.

Several large observational studies (involving tens of thousands of subjects) and their meta-analysis have failed to demonstrate any benefit of antioxidant vitamins in terms of cardiovascular event/cancer prevention in well nourished population. On the other hand, there is some indication of increased risk of CHF with

>400 mg/day α tocopherol and increased risk of hip fracture among postmenopausal women with high dose of vit A. Therefore, it would be well advised to adopt a healthy lifestyle, *viz.* eating sufficient fruits and vegetables, doing regular exercise, avoiding overweight and smoking, rather than consuming antioxidant medications.

A large number of antioxidant proprietary preparations (**ANTOXID**, **CAROFIT**, **GLACE**, **VITOXID**, **REVOX**, **CARNITOR**, **CARNIVIT-E**, etc.) containing widely variable amounts of β -carotene, vit A acetate, vit E, vit C, selenium, zinc, copper, manganese, carnitine (a substance synthesized in liver and kidney, and involved in intracellular transport of long-chain fatty acids) are briskly promoted and consumed, but with no credible evidence of benefit, and may be some potential harm.

WATER-SOLUBLE VITAMINS

THE VITAMIN B COMPLEX GROUP

Thiamine (Aneurine, vit B₁)

Chemistry and source A colourless, crystalline compound containing a pyrimidine and a thiazole ring. It is present in the outer layers of cereals (rice polishing), pulses, nuts, green vegetables, yeasts, egg and meat.

Absorption and fate Physiological amounts are absorbed by active transport. When large doses are given orally, some passive diffusion also occurs. Limited amounts are stored in tissues. About 1 mg/day is degraded in the body, excess is rapidly excreted in urine.

Physiological role After conversion in the body to *Thiamine pyrophosphate*, it acts as a coenzyme in carbohydrate metabolism: decarboxylation of ketoacids and hexose monophosphate shunt. Requirement is dependent upon carbohydrate intake—about 0.3 mg/ 1000 K cal. It also appears to play some role in neuromuscular transmission.

Pyrrithiamine and *oxythiamine* are synthetic thiamine antagonists. Tea also contains a thiamine antagonist.

Deficiency symptoms The syndrome of thiamine deficiency beriberi is seen in *dry* and *wet* forms:

Dry beriberi: Neurological symptoms are prominent—polyneuritis with numbness, tingling, hyperesthesia, muscular weakness and atrophy resulting in ‘wrist drop’, ‘foot drop’, paralysis of whole limb, mental changes, sluggishness, poor memory, loss of appetite and constipation.

Wet beriberi: Cardiovascular system is primarily affected—palpitation, breathlessness, high output cardiac failure and ECG changes. Protein deficiency is commonly associated and adds to the generalised anasarca due to CHF.

Therapeutic uses

1. Prophylactically (2–10 mg daily) in infants, pregnant women, chronic diarrhoeas, patients on parenteral alimentation. Glucose infusion unmasks marginal thiamine deficiency.
2. Beriberi—100 mg/day i.m. or i.v. till symptoms regress—then maintenance doses orally.
3. Acute alcoholic intoxication: thiamine 100 mg is added to each vac of glucose solution infused. Most neurological symptoms in chronic alcoholics are due to thiamine deficiency—peripheral neuritis, Wernick’s encephalopathy, Korsakoff’s psychosis: give 100 mg/day parenterally.
4. In neurological and cardiovascular disorders, hyperemesis gravidarum, chronic anorexia and obstinate constipation—thiamine has been used even without definite proof of its deficiency—symptoms improve dramatically if thiamine deficiency has been causative.

Adverse effects Thiamine is nontoxic. Sensitivity reactions sometimes occur on parenteral injection.

Riboflavin (vit B₂)

Chemistry and source A yellow flavone compound found in milk, egg, liver, green leafy vegetables, grains.

Absorption and fate Well absorbed by active transport and phosphorylated in the intestine. Riboflavin phosphate (Flavin mononucleotide: FMN) is formed in other tissues as well. Body does not significantly store riboflavin; larger

Table 67.1: Chemical forms, stability, daily allowance and non-combination preparations of vitamins

<i>Vitamin</i>	<i>Chemical forms</i>	<i>Thermostability</i>	<i>Daily allowance (adult males)</i>	<i>Preparations</i>
Fat-Soluble Vitamins				
A	Retinol (A ₁) Dehydroretinol (A ₂) β-Carotene (provit)	Stable in absence of air	1000 µg (4000 IU)	AQUASOL-A 50,000 IU cap, 100,000 IU in 2 ml inj. AROVIT 50,000 IU tab, 150,000 IU/ml drops, 100,000 IU / 2 ml inj. CAROFRAL 50,000 IU tab, 100,000 IU/2 ml inj.
D	Calciferol (D ₂) Cholecalciferol (D ₃) Calcitriol	Stable	5 µg (200 IU) 1 µg	ACRACHITOL, OSTELIN FORTE 300,000 IU/ml & 600,000 IU/ml inj (1 ml amp.), CALCIROL 60,000 IU in 1 g granules. CALTROL, ROCALTROL 0.25 µg cap, CALCIBEST 1 µg/ml inj.
E	α-Tocopherol	Stable; air & UV light decompose	10 mg	EVION 100, 200, 400, 600 mg pearls, 50 mg/ml paed. drops. VITEOLIN, ECAP 200, 400 mg pearls, cap., EROVIT, ETOPLEX, EPHYNA 200, 400 mg caps.
K	Phytonadione (K ₁) (Phylloquinone) Menaquinones (K ₂) Menadione (K ₃) Acetomenaphthone	Stable, decomposed by light	50–100 µg	VITAMIN-K, KENADIONE 10 mg/ml inj. KAPILIN 10 mg tab., ACETOMENADIONE 5, 10 mg tab.
Water-Soluble Vitamins				
B ₁	Thiamine	Relatively labile	1.5 mg	BERIN 50, 100 mg tab, 100 mg/ml inj. (10 ml vial) BENEURON 5 mg cap., BETABION 100 mg tab.
B ₂	Riboflavin	Relatively stable	1.7 mg	LIPABOL 20 mg tab. RIBOFLAVIN 10 mg/ml inj.
B ₃	Nicotinic acid } Nicotinamide } Niacin Tryptophan (provit.) }	Stable	20 mg	NICOTINIC ACID 25, 50 mg tab., NIALIP 250, 375, 500 mg tab NICOTINAMIDE 25, 50 mg tab.
B ₆	Pyridoxine Pyridoxal Pyridoxamine	Stable in absence of air	2 mg	PYRIDOXINE HCl 50 mg/2 ml inj., 10 mg tab. BENADON 40 mg tab, PYRICONTIN 100 mg tab
	Pantothenic acid	Labile	4–7 mg	CALCIUM PANTOTHENATE 50 mg tab., 50 mg/2 ml inj.
	Biotin	Stable	0.1–0.2 mg	
	Folic acid Folinic acid	Labile	0.2 mg	FOLVITE, FACITAB 5 mg tab. CALCIUM LEUCOVORIN 3 mg/ml inj.
B ₁₂	Cyanocobalamin Hydroxocobalamin Methylcobalamin	Stable	2 µg	MACRABIN 35 µg/ml liq: 100, 500, 1000 µg inj., REDISOL-H, MACRABIN-H 500, 1000 µg inj. VITAMIN B ₁₂ 500, 1000 µg in 10 ml vial. METHYLCOBAL, BIOCOBAL, DIACOBAL, 500 µg cap
C	Ascorbic acid	Labile in solution	60 mg	CECON 500 mg tab, 100 mg/ml drops. CELIN 50, 100, 500 mg tab., CHEWCEE 500 mg tab REDOXON 200, 500 mg tab, 500 mg/5 ml inj.

doses are excreted unchanged in urine. Thiamine and riboflavin are both synthesized by colonic bacteria but this does not become available to the host.

Actions and physiological role Flavin adenine dinucleotide (FAD) and flavin mononucleotide (FMN) are coenzymes for flavoproteins involved in many oxidation-reduction reactions. Thiamine and riboflavin are devoid of pharmacological actions.

Deficiency symptoms Riboflavin deficiency generally occurs in association with other deficiencies. Characteristic lesions are angular stomatitis; sore and raw tongue, lips, throat, ulcers in mouth; vascularization of cornea. Dry scaly skin, loss of hair; anaemia and neuropathy develop later.

Therapeutic uses To prevent and treat ariboflavinosis (2–20 mg/day oral or parenteral),

generally along with other B complex members. There is no proof of benefit in any other condition.

Niacin (vit B₃)

Chemistry and source Niacin refers to *Nicotinic acid* as well as *Nicotinamide*—pyridine compounds, initially termed pellagra preventing factor. Sources are liver, fish, meat, cereal husk, nuts and pulses.

The amino acid *tryptophan* (mainly from animal protein) can be regarded as a provitamin, as it is partially converted in the body to nicotinic acid (60 mg tryptophan = 1 mg nicotinic acid). Maize eaters have suffered from pellagra because corn flour is poor in tryptophan and it is believed to contain a niacin antagonist. Thus, daily requirement of niacin is affected by the amount of tryptophan in diet.

Absorption and fate Niacin is completely absorbed from gastrointestinal tract. Physiological amounts are metabolized in the body, while large doses are excreted unchanged in urine. Modest amounts are stored in liver.

Physiological role and actions Nicotinic acid is readily converted to its amide which is a component of the coenzyme *Nicotinamide-adenine-dinucleotide* (NAD) and its *phosphate* (NADP) involved in oxidation-reduction reactions. These pyridine nucleotides act as hydrogen acceptors in the electron transport chain in tissue respiration, glycolysis and fat synthesis. Flavoproteins regenerate them by oxidizing NADH and NADPH.

Nicotinic acid (but not nicotinamide) in large doses is a vasodilator, particularly of cutaneous vessels. It also lowers plasma lipids (see Ch. 45).

Deficiency symptoms Niacin deficiency produces 'Pellagra', cardinal manifestations of which are:

Dermatitis—sunburn like dermal rash on hands, legs and face which later turn black, crack and peel.

Diarrhoea—with enteritis, stomatitis, glossitis, salivation, nausea and vomiting.

Dementia—with hallucinations preceded by headache, insomnia, poor memory, motor and sensory disturbances.

Anaemia and hypoproteinaemia are common in pellagra. Chronic alcoholics are particularly at risk of developing pellagra, because in addition to dietary deficiency, niacin absorption is impaired in them. Other B vitamin deficiencies are often associated.

Therapeutic uses

1. Prophylactically (20–50 mg/day oral) in people at risk of developing pellagra.
2. Treatment of pellagra—200 to 500 mg/day in divided doses orally or parenterally. Striking improvement occurs in 1–2 days, but skin lesions take weeks to months. Nicotinamide is preferred, especially for injection, because it does not cause flushing and other side effects seen with nicotinic acid.
3. Hartnup's disease: in which tryptophan transport is impaired, and in carcinoid tumours which use up tryptophan for manufacturing 5-HT, need niacin supplementation.
4. Nicotinic acid (not nicotinamide) has been used in peripheral vascular disease and as hypolipidaemic (Ch. 45).

Adverse effects Nicotinic acid, in pharmacological doses, has many side effects and toxicities (p. 618). Nicotinamide is innocuous.

Pyridoxine (vit B₆)

Chemistry and source *Pyridoxine*, *Pyridoxal* and *Pyridoxamine* are related naturally occurring pyridine compounds that have vit B₆ activity. Dietary sources are—liver, meat, egg, soybean, vegetables and whole grain.

Absorption and fate All three forms of the vitamin are well absorbed from the intestine. They are oxidized in the body and excreted as pyridoxic acid. Little is stored.

Physiological role and actions Pyridoxine and pyridoxamine are readily oxidized to pyridoxal, which is then phosphorylated to *pyridoxal*

phosphate—the coenzyme form. Pyridoxal dependent enzymes include transaminases and decarboxylases involved in synthesis of nonessential amino acids, tryptophan and sulfur containing amino acid metabolism, formation of 5-HT, dopamine, histamine, GABA and aminolevulinic acid (first step in the synthesis of haeme). High protein diet increases pyridoxine requirement.

Pyridoxine has been shown to interact with steroid hormone receptors, but its clinical implication is not clear. Prolonged intake of large doses of pyridoxine can give rise to dependence, and mega doses (0.2–2.0 g/day) have been linked with sensory neuropathy. Otherwise, pyridoxine is free from pharmacological actions and side effects. However, suppression of lactation has been noted in nonsuckling postpartal women given high doses of pyridoxine: may be due to increased dopamine action on pituitary lactotropes.

Drug interactions

1. Isoniazid reacts with pyridoxal to form a hydrazone, and thus inhibits generation of pyridoxal phosphate. Isoniazid also combines with pyridoxal phosphate to interfere with its coenzyme function. Due to formation of hydrazones, the renal excretion of pyridoxine compounds is increased. Thus, isoniazid therapy produces a pyridoxine deficiency state.
2. Hydralazine, cycloserine and penicillamine also interfere with pyridoxine utilization and action.
3. Oral contraceptives reduce pyridoxal phosphate levels in some women.
4. Pyridoxine, by promoting formation of dopamine from levodopa in peripheral tissues, reduces its availability in the brain, abolishing the therapeutic effect in parkinsonism, but not when a peripheral decarboxylase inhibitor is combined with it.
5. 4-deoxypyridoxine is a vit B₆ antagonist.

Deficiency symptoms Deficiency of vit B₆ usually occurs in association with that of other B

vitamins. Symptoms ascribed to pyridoxine deficiency are—seborrheic dermatitis, glossitis, growth retardation, mental confusion, lowered seizure threshold or convulsions (due to fall in brain GABA levels), peripheral neuritis and anaemia.

Therapeutic uses

1. Prophylactically (2–5 mg daily) in alcoholics, infants and patients with deficiency of other B vitamins.
2. To prevent and treat (10–50 mg/day) isoniazid, hydralazine and cycloserine induced neurological disturbances. Acute isoniazid poisoning has been successfully treated with massive doses (in grams) of pyridoxine.
3. To treat mental symptoms in women on oral contraceptives (50 mg daily).
4. Pyridoxine responsive anaemia (due to defective haeme synthesis) and homocystinuria are rare genetic disorders that are benefited by large doses of pyridoxine (50–200 mg/day).
5. Convulsions in infants and children.

Pantothenic acid

Pantothenic acid is an organic acid, widely distributed in food sources, especially liver, mutton, egg yolk and vegetables. It is quickly absorbed and excreted unchanged in urine with little storage.

It is a component of coenzyme-A which functions in carbohydrate, fat, steroid and porphyrin metabolism by catalysing acetate transfer reactions. Clinical deficiency of pantothenic acid is not known. Experimental deficiency in man causes insomnia, intermittent diarrhoea, flatulence, vomiting, leg cramps and paresthesias. Calcium/ sodium pantothenate is included in B complex and multivitamin preparations. Intravenous calcium pantothenate has been tried in paralytic ileus.

Biotin

Biotin is a sulfur containing organic acid found in egg yolk, liver, nuts and many other articles of food. Some of the biotin synthesized by intestinal bacteria is also absorbed. It is well absorbed from intestine and excreted mainly unchanged in urine. Not much is stored in the body. *Avidin*, a heat labile protein in egg white, binds and prevents the absorption of biotin. Some other biotin antagonists are also known.

Table 67.2: Combination preparations of vitamins

Proprietary name	Dose unit	Vit. A (IU)	Vit. D (IU)	Vit. E (mg)	Thiamine (mg)	Riboflavin (mg)	Niacin (mg)	Pyridoxine (mg)	Pantothenic (mg)	Biotin (mg)	Folic acid (mg)	B ₁₂ (µg)	Vit. C (mg)
ABDEC DROPS	per 0.6 ml	5,000	400	-	1	1	10	0.6	3	-	-	-	50
ADEXOLIN	cap	5,000	400	-	-	-	-	-	-	-	-	-	-
AQUASOL-A-D	drops	24,000	1,000	-	-	-	-	-	-	-	-	-	-
AQUASOL-A-E	cap	30,000	-	50	-	-	-	-	-	-	-	-	-
BEGOSULES	cap	-	-	-	10	10	50	3	12.5	-	1	5	150
"	syrup	-	-	-	2	2.5	20	2	6	-	-	-	75
BECOZYME C FORTE	tab.	-	-	-	15	15	50	3	16.3	0.15	-	10	150
BEJECTAL	inj.	-	-	-	10	2	75	5	5	-	-	-	-
EDINOL	cap	10,000	1,000	15	10	10	50	3	10	-	1	5	150
MACRABERIN	tab.	-	-	-	10	-	-	3	-	-	-	15	-
MACRABERIN FORTE	inj.	-	-	-	100	-	-	50	-	-	-	1000	-
MULTIVITAPLEX	elixir	2,500	200	-	2	2.5	20	1	5	-	-	-	50
" FORTE	cap.	10,000	400	15	5	5	50	1.5	5	-	1	5	75
COBADEX FORTE	cap.	-	-	-	10	10	100	3	50	-	1.5	15	-
COBADEX SYRUP	syr	-	-	-	5	2.5	50	1.5	5	-	-	-	-
KINETONE	liq.	2000	200	7.5	2	3	-	1.5	-	-	-	1	-
OPTINEURON	inj.	-	-	-	100	5	100	100	50	-	-	1000	-
STRESSCAPS	cap.	-	-	-	10	10	100	2	20	-	-	5	150
NEUROXIN-12	inj.	-	-	-	30	-	-	14	-	-	-	500	-
" FORTE	inj.	-	-	-	100	-	-	100	-	-	-	1000	-
POLYBION	tab.	-	-	-	10	10	50	3	25	-	-	15	150
"	inj.	-	-	-	10	4	40	4	6	-	-	8	-
ROYVIGON	tab.	10,000	-	70	-	-	-	-	-	-	-	-	-
SCLEROBION	tab.	10,000	-	25	-	-	-	3	-	-	-	-	-
TRIREDISOL	tab.	-	-	-	100	-	-	5	-	-	-	50	-
TRIREDISOL-H	inj.	-	-	-	50	-	-	25	-	-	-	500	-
VIMAGNA	drops	2,000	200	-	0.8	0.8	13	0.8	1.7	-	-	-	20

Combined formulations of vitamins with analgesics, anti-inflammatory drugs, tranquilizers and antitubercular drugs (except isoniazid + pyridoxine) are banned in India.

Biotin is a coenzyme for several carboxylases involved in carbohydrate and fat metabolism. Deficiency symptoms include seborrheic dermatitis, alopecia, anorexia, glossitis and muscular pain. Spontaneous deficiency of biotin has been noted only in subjects consuming only raw egg white and in patients on total parenteral nutrition. Except for these unusual instances and rare genetic abnormalities of biotin dependent enzymes, there are no clearly defined therapeutic uses of biotin. It is present in some multivitamin preparations.

VITAMIN C (ASCORBIC ACID)

Chemistry and source Ascorbic acid is a 6 carbon organic acid with structural similarity to glucose. It is a potent reducing agent and *l*-form is biologically active. Citrus fruits (lemons, oranges) and black currants are the richest sources; others are tomato, potato, green chillies, cabbage and other vegetables. Human milk is richer in vit C (25–50 mg/L) than cow's milk.

Absorption and fate It is nearly completely absorbed from g.i.t. and widely distributed extra- and intracellularly. Plasma concentration and total body store of vit C is related to daily intake. The usual 60 mg/day intake results in about 0.8 mg/dl in plasma and 1.5 g in the body as a whole. Increasing proportions are excreted in urine with higher intakes. Body is not able to store more than 2.5 g. It is partly oxidized to active (dehydroascorbic acid) and inactive (oxalic acid) metabolites.

Physiological role and actions Vit C plays a role in many oxidative and other metabolic reactions, e.g. hydroxylation of proline and lysine residues of procollagen—essential for formation and stabilization of collagen triple helix; hydroxylation of carnitine, conversion of folic acid to folinic acid, biosynthesis of adrenal steroids, catecholamines, oxytocin and vasopressin and metabolism of cyclic nucleotides and prostaglandins. It directly stimulates collagen synthesis and is very important for maintenance of intercellular connective tissue. A number of ill-defined actions have been ascribed to ascorbic acid in mega doses, but none is proven.

Deficiency symptoms Severe vit C deficiency *Scurvy*, once prevalent among sailors is now seen only in malnourished infants, children, elderly, alcoholics and drug addicts. Symptoms stem

primarily from connective tissue defect: increased capillary fragility—swollen and bleeding gums, petechial and subperiosteal haemorrhages, deformed teeth, brittle bones, impaired wound healing, anaemia and growth retardation.

Therapeutic uses

1. Prevention of ascorbic acid deficiency in individuals at risk (*see above*) and in infants: 50–100 mg/day. Vit C or orange juice can be routinely included in infant diet.
2. Treatment of scurvy—0.5–1.5 g/day.
3. Postoperatively (500 mg daily): though vit C does not enhance normal healing, suboptimal healing can be guarded against. It has also been found to accelerate healing of bedsores and chronic leg ulcers. Requirement of ascorbic acid is increased in postinjury periods.
4. Anaemia: Ascorbic acid enhances iron absorption and is frequently combined with ferrous salts (maintains them in reduced state). Anaemia of scurvy is corrected by ascorbic acid, but it has no adjuvant value in other anaemias.
5. To acidify urine (1 g TDS–QID) in urinary tract infections (*see Ch. 54*).
6. Large doses (2–6 g/day) of ascorbic acid have been tried for a variety of purposes (common cold to cancer) with inconsistent results. No definite beneficial effect has been noted in asthma, cataract, cancer, atherosclerosis, psychological symptoms, infertility, etc. However, severity of common cold symptoms may be somewhat reduced, but not the duration of illness or its incidence. Improved working capacity at submaximal workloads has been found in athletes but endurance is not increased.

Adverse effects Ascorbic acid is well tolerated in usual doses. Mega doses given for long periods can cause 'rebound scurvy' on stoppage—probably due to enhancement of its own metabolism or tissue acclimatization. The risk of urinary oxalate stones may be increased. High doses may also be cytotoxic when added to iron preparations.

CHAPTER 68

Vaccines and Sera

Vaccines and sera are biological products which act by reinforcing the immunological defence of the body against foreign agencies (mostly infecting organisms or their toxins).

Vaccines impart *active immunity*—act as antigens which induce production of specific antibodies by the recipient himself.

Antisera and *Immunoglobulins* impart *passive immunity*—readymade antibodies (produced by another person or animal who has been actively immunized) are transferred.

Active immunization is more efficacious and longer lasting than passive immunization, but the former needs a latent period of one to many weeks, whereas the latter affords immediate protection. Antisera are, therefore, curative also, whereas vaccines are only prophylactic. Acutely ill, debilitated or immunocompromised individuals may not be able to generate an adequate antibody response and require passive protection.

Vaccines and sera are potentially dangerous products and mostly used in public health programmes—their manufacture, quality control, distribution and sale is strictly supervised by State health authorities. These biologicals are standardized by bioassay and need storage in cold to maintain potency.

VACCINES

Vaccines are antigenic materials consisting of the whole microorganism or one of its products. Vaccines are of 3 types:

- (i) *Killed (Inactivated) vaccines*: consist of microorganisms killed by heat or chemicals.
- (ii) *Live attenuated vaccines*: consist of live bacteria or viruses which have been rendered avirulent. They nevertheless grow and multiply in the body of the host to a limited extent. In individuals with impaired host defence, e.g.
 - (a) Leukaemia or other malignancies, especially those receiving cytotoxic chemotherapy.
 - (b) Systemic lupus erythematosus.
 - (c) Corticosteroid recipients.
 - (d) AIDS and other immune deficiency states.

The limited virulence of organisms in the live vaccine may be sufficient to cause a disease; live vaccines are contraindicated in them.

Two live vaccines, if not given together, should preferably be administered with a gap of 1 month.

- (iii) *Toxoids*: are modified bacterial exotoxins so that toxicity is lost but antigenicity is retained. The term 'vaccine' is sometimes restricted to preparations of whole microorganisms and toxoids are enumerated separately.

Killed (inactivated) vaccines	Live attenuated vaccines
	BACTERIAL
Typhoid-paratyphoid (TAB)	Bacillus Calmette-Guérin (BCG)
Vi Typhoid polysaccharide	Typhoid-Ty 21a
Cholera	
Whooping cough (Pertussis)	
Meningococcal	
Haemophilus influenzae type b	
Plague	
	VIRAL
Poliomyelitis inactivated (IPV, Salk)	Poliomyelitis oral live (OPV, Sabin)
Rabies (Neural tissue)	Mumps (live attenuated)
Rabies (Chick embryo cell, PCEV)	Measles (live attenuated)
Rabies (Human diploid cell, HDCV)	Rubella (live attenuated)
Rabies (Vero cell, PVRV)	Varicella (live attenuated)
Influenza	
Hepatitis B	
Hepatitis A	
	TOXOIDS
	Tetanus (fluid / adsorbed)
	Diphtheria (adsorbed)
	COMBINED VACCINES
	Double antigen (DT-DA)
	Triple antigen (DPT)
	Measles, mumps, rubella (MMR)

Active immunization with vaccines may fail to 'take' during corticosteroid or immunosuppressant medication and should be avoided. Vaccination should be deferred in the presence of any acute (especially respiratory) infection and during pregnancy. Antibiotics added during production of vaccines and present in trace amounts in viral vaccines may cause reaction in individuals sensitive to these. Egg proteins (in vaccines prepared on chick embryo) and other materials used for vaccine culture may be responsible for allergic reactions. Adrenaline injection (1 in 1000) should be available to control allergic reaction to the vaccine, if it occurs.

The antibodies developed in response to live or killed vaccines inactivate the bacteria/virus when it subsequently enters the body, while those induced by toxoids neutralize the elaborated

exotoxin. The latent period between vaccination and development of immunity and the period for which it lasts depends primarily on the organism, but varies somewhat in different individuals. Viral vaccines and toxoids generally afford more prolonged protection than bacterial vaccines. The important vaccines are described briefly.

BACTERIAL VACCINES

1. Typhoid-Paratyphoid A, B (TAB vaccine) It is a sterile suspension, 1 ml containing 1×10^9 *S. typhi* and 7.5×10^8 each of *S. paratyphi* A and B organisms in 5, 10 ml vials. *Dose*—0.5 ml s.c., 2–3 injections at 2–4 weeks intervals. Local tenderness, fever and malaise lasting 1–2 days are common after the first dose. It is estimated to be 70% effective in preventing enteric fever for 1 year. Booster doses may be given every 2–3 years.

2. Vi Typhoid polysaccharide vaccine It contains purified Vi capsular antigen of *S. typhi*. A single 0.5 ml s.c./i.m. dose affords 72% protection at 18 months and 60% protection at 3 years. It produces much less local and systemic side effects than TAB and induces longer lasting immunity, but does not protect against paratyphoid A and B. Thus, it is an improvement over the whole cell TAB vaccine. However, it is not approved for use in children below 2 years and in pregnant women.

VACTYPH, TYPHIM Vi, TYPHIVAX 0.025 mg in 0.5 ml inj; repeat after 3 years.

3. 'Typhoid-Ty21a' oral vaccine This is a newer live oral typhoid vaccine prepared from Ty 21a attenuated strain of *S. typhi* which lacks the Vi polysaccharide and is nonpathogenic. The attenuation is due to absence of the enzyme Uridine diphosphate galactose-4 epimerase which is essential for the production of lipopolysaccharide 'O' antigens. It is avirulent. By lodging in the intestinal mucosa it protects against *S. typhi* invasion of the gut in addition to imparting systemic immunity. High cell mediated and modest antibody mediated immunity is produced. Administered as 3 doses on alternate days in the form of enteric coated capsules it affords protection for 3 years. Efficacy is better than TAB. Trials in India and other countries have reported 67–90% protection at 3 years. Side effects are negligible: only 2% cases have reported diarrhoea, abdominal pain or rashes. It is much more convenient, safer and longer acting. It is not approved for use in children below 5 years and in pregnant women.

TYPHORAL *S. typhi* strain Ty21A 10^9 organism per cap; 3 caps taken in 3 doses on alternate days in between meals.

4. Cholera vaccine It is a suspension of phenol/formalin killed Inaba and Ogawa strains of *V. cholerae*, each ml containing 8×10^9 organisms in 5, 10, 30 ml vials. Dose: 0.5 ml s.c. or i.m. followed by 1 ml 1–4 weeks later, or a single dose of 1 ml for mass inoculation. Immunity, sufficient to prevent clinical disease, is produced only in 50% of those inoculated, and lasts 6 months or

so—sufficient to tide over an epidemic. Cholera inoculation during congregations (*melas*) has not reduced the incidence of the disease (because it takes 2–3 weeks for immunity to develop): this practice has been discontinued. It also does not prevent carrier state. Transient local soreness, low grade fever, aches and pains lasting 1–2 days are common. Neurological complications are rare.

Two new oral cholera vaccines have been produced: killed whole cell/recombinant B subunit (WC/r BS) and live CVD-103 HgR vaccine. Both these vaccines are highly immunogenic, safer than the present cholera vaccine and provide immunity upto 3 years. Cumulative protective efficacy of 86% at 3 weeks and 50% at 3 years have been estimated. They have been made available in Europe, but not yet in India.

5. Whooping cough (pertussis) vaccine It is killed 2×10^{10} organisms/ml suspension of *B. pertussis* organisms. Dose 0.25–0.5 ml s.c. or i.m. thrice at 4 week intervals in infants and children below 5 years (whooping cough is very rare after 5 years age).

It also induces a state of diminished β adrenergic reactivity and aids sensitization to other antigens.

In addition to local pain and induration, severe systemic (even fatal) reactions have been reported, but extremely rarely—high fever with hypotonic hyporesponsive child, convulsions, alterations of consciousness and focal neurological signs. Once any such reaction has occurred, further doses are contraindicated. It is also contraindicated in children with history of convulsions or other neurological disease.

It is a component of triple antigen: seldom used separately.

6. Meningococcal A&C vaccine It contains purified capsular polysaccharide of *N. meningitidis* group A and C, 50 μ g of each per unit in single dose and 10 dose vials. One dose (0.5 ml s.c. or i.m.) is indicated for prophylaxis of meningitis during an epidemic caused by group A or C meningococci.

MENINGOCOCCAL A & C, MENCEVAX A & C 0.5 ml amp, 5 ml vial.

7. Haemophilus influenzae type b (Hib) vaccine

It contains medium oligosaccharide of *H. influenzae* type b (10 µg) conjugated with nontoxic protein (25 µg) of CRM₁₉₇ mutant *C. diphtheriae* toxin along with alum. hydrox. adjuvant. It is indicated for protection of infants and children against *H. influenzae* meningitis, pneumonia, etc. Infants 2–6 months are given 3 doses (0.5 ml i.m.) at 8 week gaps, 7–11 months 2 doses, while those older than 1 yr require only 1 dose. Good antibody response and protection has been obtained in > 90% recipients.

VAXEM-HIB, HIB-TITER 0.5 ml and 5 ml vials

8. Antiplague vaccine formalized It contains 2×10^9 *Y. pestis* organisms per ml, killed by formaline, in 10 ml vial. *Dose*—1 ml i.m. twice 1–2 weeks apart or 2 ml single dose. Local and systemic reactions are relatively frequent and increase with the number of booster doses. Immunity lasts 6–8 months—sufficient to cover an epidemic. Plague is now rare, so is the need for this vaccine.

9. Bacillus Calmette-Guérin (BCG) vaccine It is a live vaccine bearing an attenuated bovine strain of *M. tuberculosis*, developed in 1921 by Calmette and Guérin in France. It is supplied as 0.5–1 mg dry powder ($1-2.5 \times 10^7$ colony forming units) in ampules to be suspended in 1 ml of sterile water; 0.05 ml (in neonate) 0.1 ml (older individuals) is injected intracutaneously in the left deltoid region at birth. In children and adults tuberculin testing is done beforehand and BCG is given only to negative responders.

A red painless papule appears after 7–10 days; reaches about 8 mm diameter in 5 weeks with swelling of axillary lymph node; may ulcerate, but scales and dries in 3 months; totally heals in 6 months. The protection afforded by BCG is partial and neither permanent nor entirely predictable. It has been widely used to enhance resistance to tubercular infection, but doubt has been cast about its utility in adults, though children appear to be benefited.

BCG has also been used to enhance immunity nonspecifically by stimulating the reticuloendothelial system: employed as adjuvant in immunotherapy of cancer and some other conditions. It is contraindicated in tuberculin positive

individuals, in those with compromised host defence including HIV positive children, and during pregnancy.

VIRAL VACCINES

1. Poliomyelitis The virus (type 1, 2, 3) is grown in monkey kidney cell culture and two vaccines are prepared from it.

(a) Oral poliovirus vaccine (OPV; Sabin vaccine)

It is the live virus available in 10 ml and 50 ml vials; each dose is 2 drops, dropped directly in the mouth. The virus multiplies in the intestines and produces active immunity, simulating natural infection, without producing symptoms of the disease. For primary immunization OPV is now generally given at birth and then at 6, 10 and 14 weeks. Booster doses are given between 15–18 months and at school entry. OPV is the vaccine of choice for active immunization of children because it is simple to administer, is well accepted, induces systemic as well as intestinal immunity (the portal of entry of disease virus) and is highly efficacious. The intestinal immunity also eliminates carrier state and thus limits spread of the disease. It is advised to postpone the vaccine in presence of vomiting and diarrhoea. Vaccine associated paralysis occurs extremely rarely.

Simultaneous vaccination of all infants and children upto 5 years age (pulse polio programme) has eradicated the wild virus in many countries by colonizing all susceptible intestines by the vaccine virus. This programme is underway in India.

(b) Inactivated poliomyelitis vaccine (IPV, Salk vaccine) It is inactivated suspension of the virus which is preferred over OPV only for :

- (i) primary immunization in adults (risk of vaccine associated paralysis following OPV is higher in adults).
- (ii) in persons with compromised immune system.

Three doses of 1 ml each are injected s.c. in the deltoid region at 4–6 week intervals and a fourth is given 6–12 months later. Booster doses are given every 5 years. Fever and local pain are common. Allergic reactions sometimes occur, probably to the animal protein present in the vaccine.

2. Rabies Four rabies vaccines have been produced.

a. Antirabic vaccine carbolized (Semple vaccine) Also called 'Neural tissue vaccine' (NTV), it is a 5% suspension of sheep brain substance containing carbolic acid fixed rabies virus. Though long considered obsolete because of poorer efficacy, need for 14 daily painful large volume (2–5 ml) injections into the anterior abdominal wall, and risk of serious (even fatal) vaccine associated allergic encephalomyelitis, it continued to be used in Government hospitals in India till mid 2005, after which it has been discontinued.

b. Purified chick embryo cell vaccine (PCEV) It consists of Flury-LEP strain of rabies virus grown on chick fibroblasts and inactivated by β -propiolactone; available as 2.5 IU in 1 ml amp (RABIPUR). The efficacy of this vaccine is nearly equal to HDCV, and it produces local reactions in ~5% cases. However, rare neuromyolytic complications have been reported. Local pain, erythema, swelling and lymph node enlargement can occur.

c. Human diploid cell vaccine (HDCV) It is lyophilized inactivated rabies virus grown in human diploid cell culture. The vial containing 2.5 IU is freshly suspended in 1 ml of diluent.

A local reaction—redness and slight induration lasting 1–2 days occurs in 10% cases. Fever and arthralgia is reported in 1%. HDCV is ~100% effective and well tolerated. Vaccine associated encephalitis does not occur.

d. Purified vero cell rabies vaccine (PVRV) This contains inactivated wistar rabies PM/WI38-1-503-3M strain grown on vero continuous cell line (VERORAB 1 ml; VEROVAX-R 0.5 ml).

Post-exposure prophylaxis: This is given to all nonimmunised animal-bite cases suspected to have been exposed to the rabies virus. The intradermal (i.d.) regimen for all tissue culture rabies vaccines called the 'Thai regimen' that has been recommended by the WHO since 1992, has only recently (in 2006) been approved and notified by the Government of India. This regimen requires only 1/5 dose of the earlier used i.m. regimen, is less expensive, more convenient and equally

efficacious. In this regimen 0.1 ml of PCEV or PVRV or 0.2 ml of HDCV is injected i.d. at 2 sites (over deltoid of both arms) on days 0, 3 and 7 followed by 1 site injection on day 28 (or 30) and day 90, (2 + 2 + 2 + 1 + 1 = 8 injections). Thus, no injection is given on day 14 as in earlier i.m. regimen which employed 1 ml PCEV/HDCV or 0.5 ml PVRV per injection on days 0, 3, 7, 14, 30, 90.

Because rabies vaccines take 10–14 days to develop protective antibodies, concurrent administration of rabies immunoglobulin (RIG) is recommended in category III bites, where risk of contacting rabies is high.

An alternative 8 site i.d. regimen (Oxford regimen) is advocated for an earlier antibody response, particularly when RIG is not available for postexposure treatment. In this regimen 0.1 ml of PCEV or HDCV (but not PVRV) is injected at 8 sites (over both deltoids, suprascapular region, thighs and abdomen) on day 0. On 7th day 4 sites are injected followed by one site injection on day 28 and 90 (total 14 injections).

Pre-exposure prophylaxis (Primary vaccination): This is usually recommended for veterinary workers and animal handlers, who are at high risk of animal bites. Three i.d. injections of 0.1 ml each of PCEV/HDCV/PVRV are given on days 0, 7 and 28. Booster doses are recommended every 2 years so long as the person remains at risk.

Post-exposure prophylaxis in already vaccinated subjects: This is given when an immunized person is bitten by a suspected animal. Three 0.1 ml i.d. injections are given on days 0, 3 and 7.

Local treatment of bite wound: Early local treatment of bite wound is essential in addition to the vaccine \pm RIG. The wound should be thoroughly washed with soap under running water for at least 5 min, followed by application of an antiseptic (alcohol/povidone iodine/cetrimide). Cauterization with carbolic acid is contraindicated. In category III bites, RIG should be infiltrated locally in the depth and around the wound to inactivate the locally present virus. Suturing of the wound should be avoided, at least for 2 days.

3. Influenza virus vaccine Contains inactivated influenza virus A and B. Immunization may be done annually or during an epidemic: 2 injections of 0.5–1 ml i.m. 1–2 months apart. Influenza virus undergoes frequent antigenic changes; hence the efficacy of the vaccine is inconsistent. It is indicated only in high risk cases.

Adverse reactions are commoner in children—local tenderness and induration occurs in 30%. Fever, malaise and myalgia lasting 1–2 days is less frequent. Allergic reactions to the egg protein present in the vaccine occur rarely.

4. Hepatitis B vaccine The new hepatitis B vaccine (**ENGERIX-B**) is prepared in yeast cells by recombinant DNA technique and contains aluminium hydroxide adsorbed hepatitis B virus surface antigen 20 µg in 1 ml suspension. Three 1 ml injections in the deltoid muscle given at 0, 1 and 6 months produce protective antibody titers in 99% subjects. Children <10 yr are given 0.5 ml doses in the thigh. Now included in universal immunization for all, but is especially indicated in persons who come in contact with blood, blood products and other body fluids (surgeons, dentists, blood bank personnel, laboratory technicians and other health care workers, haemophiliacs, haemodialysis patients, drug addicts, etc). Induration and soreness at injection site and occasional fever and malaise are the adverse effects.

5. Hepatitis A vaccine It is prepared by inactivating with formaldehyde hepatitis A virus grown in human diploid cell culture. A single 0.5 ml i.m. injection in deltoid muscle affords protection, but a booster dose after 6 months is recommended.

AVAXIM 0.5 ml prefilled syringe, HAVRIX 0.5 ml inj.

6. Mumps virus vaccine live attenuated It is prepared from mumps virus grown in cell culture of chick embryo. A single dose of 5000 TCID₅₀ (tissue culture infectious dose 50%) affords protection for 10 years; revaccination is not required. Clinical disease may occur if the vaccine is given *after exposure* to natural mumps. It is generally combined with measles and rubella vaccine (MMR), and is not recommended below 1 year of age. A mild febrile reaction occurs occasionally.

7. Measles vaccine live attenuated This is also a vaccine grown on chick embryo; available in single dose vials containing 1000 TCID₅₀ of *Edmonston Schwarz* strain (**ROUVAX**, **RIMEVAX**) or *Edmonston zagreb* strain (**M-VAC**) for s.c. injection over right deltoid region. It produces a modified infection—fever, rash and coryza may appear after 5–10 days; immunity lasts 8 years and no booster doses are required. It is recommended in children 9 months or older. Ordinarily, adults need not be immunized. Malnourished, chronically ill and tuberculous children must be protected to minimize the risk of serious complications of natural measles. Some protection is afforded even if given after exposure. It should be given with caution to children with history of febrile convulsions or parental history of epilepsy.

8. Rubella vaccine (**R-VAC**) It contains live attenuated rubella virus Wistar RA27/3 strain 1000 TCID₅₀ per 0.5 ml inj. for deep s.c. or i.m. injection in upper arm. It is used especially in girls from 1 yr age to puberty—for immunization against German measles; mostly as combined MMR vaccine. It is contraindicated during pregnancy, febrile illness and in untreated tuberculosis patients. Reactions are fever, malaise, sore throat, joint pain and lymphadenopathy.

9. Measles-Mumps-Rubella (MMR) vaccine Two preparations of this combined live vaccine are available: have similar efficacy.

TRIMOVAX lyophilized measles 1000 TCID₅₀ of Schwarz strain, mumps 5000 TCID₅₀ and rubella 1000 TCID₅₀ per unit dose (0.5 ml) vial.

TRESIVAC lyophilized measles 5000 TCID₅₀ of Edmonston Zagreb strain, mumps 5000 TCID₅₀ and rubella 4000 TCID₅₀ per unit dose (0.5 ml) vial.

A single dose injected s.c. over right deltoid is indicated in children older than 12 months for protection against these 3 diseases. Mild fever, rash, enlargement of cervical/occipital lymph nodes and parotid glands and local induration may occur after ~5 days. It is absolutely contraindicated during pregnancy; adult female vaccinees should not conceive for at least 2 months.

10. Varicella vaccine It is lyophilised live attenuated OKa strain of varicella-zoster virus grown in human diploid cell culture, containing $10^{3.3}$ PFU (plaque forming units) of the virus. A single dose induces antibody response in > 98% children and affords protection for 10 years.

Dose: 0.5 ml s.c. single dose for children 1–12 years, and 2 doses 6–10 weeks apart in those > 12 years.

VRILRIX, OKAVAX 0.5 ml inj.

Contraindicated during pregnancy, in those with lymphocytopenia and within 1 month of measles vaccination. Mild local reaction, papular eruption and short-lasting fever occurs in 4–5% children.

TOXOIDS

1. Tetanus toxoid It is formaline treated exotoxin of tetanus bacilli; indicated for routine immunization in all children and adults. Two types of preparations—*fluid* and *adsorbed* are available. The adsorbed toxoid is superior—induces higher antibody titers and more prolonged immunity. *Dose:* 0.5 ml, preferable route is i.m., can also be given s.c.

For primary immunization—Tetanus toxoid adsorbed (0.5 ml amp. 10 ml vial), 2 doses are given 4–6 weeks apart, or Tetanus toxoid fluid (1 ml amp, 10 ml vial) 3 doses at interval of 3–4 weeks. Booster dose should be given after 1 year and then every 10 years. In non-immunized or inadequately immunized individuals the toxoid should be given after any injury likely to introduce tetanus bacilli. Concomitant administration of chloramphenicol is avoided, as it may interfere with antibody response.

Reactions—Local erythema, pain and induration is not uncommon. Axillary lymph nodes may enlarge. Fever, chills, malaise, aches and pains occur occasionally, especially in adults. Paresis and other neurological complications are rare.

2. Diphtheria toxoid adsorbed It is modified diphtheria exotoxin adsorbed onto aluminium hydroxide. It is indicated in infants and children below 6 years of age. Older individuals seldom require protection against diphtheria. For primary immunization 2–3 injections of 0.5 ml i.m. are

given 4–6 weeks apart, booster dose after 1 year and then at school entry. Reactions are similar to those caused by tetanus toxoid.

MIXED ANTIGENS

1. Double antigen (DT-DA) It consists of alum precipitated toxoids of tetanus and diphtheria, available in 0.5 ml ampule and 5 ml vial (**DUAL ANTIGEN**). It is used in children above 5 years and in younger children in place of triple antigen when pertussis vaccine is contraindicated.

Dose: 0.5 ml i.m.

2. Triple antigen (DPT) It is a mixture of toxoids of tetanus and diphtheria with pertussis vaccine (**TRIPVAC**: Diphtheria toxoid 25 Lf, tetanus toxoid 5 Lf, *B. pertussis* 20,000 million in 0.5 ml amp; also 10 ml multidose vial).

Routine immunization schedule for infants and children

At birth	BCG + OPV (first dose) + Hepatitis B (after 12–24 hours)
At 6 weeks	DPT + OPV + Hepatitis B
At 10, 14 weeks	DPT + OPV
At 6 months	Hepatitis B
At 9 months	Measles
At 15–18 months	DPT + MMR + OPV (booster dose)
At 4–5 years (School entry)	DT-DA + OPV (booster dose) Typhoid (TAB 2 doses/ Vi 1 dose/Ty 21a 3 doses) optional
At 10 years	TT + TAB/Vi/Ty 21a (optional)
At 16 years	TT

For pregnant women

16–24 weeks	TT (1st dose)
24–34 weeks	TT (2nd dose)

It is the preparation of choice for primary active immunization against the 3 diseases in children below 5 years age. *Dose*—0.5 ml i.m. in the anterolateral aspect of mid thigh or right deltoid, 2–3 injections 4–8 weeks apart, between 3–9 months age and one at 18 months. Reactions, precautions and contraindications mentioned under the individual vaccines apply to triple antigen as well.

A routine immunization schedule for infants and children is given in the box (p. 885).

ANTISERA AND IMMUNEGLOBULINS

Antisera are purified and concentrated preparations of serum of horses actively immunized against a specific antigen.

Immediate type of allergic reactions (urticaria, angioedema, respiratory distress, anaphylaxis) can occur with any antiserum; adrenaline (1:1000 amp.) should be at hand while injecting them. Prior to each administration, history of reaction to any 'serum' preparation should be elicited and an intracutaneous/scratch test should be performed. A positive test contraindicates administration but a negative test does not completely rule out systemic sensitivity.

Serum sickness with fever, rash, joint pain, lymphadenopathy appearing 7–12 days later is more frequent after large doses and repeated administration. An overall incidence of 5–10% is reported.

Local pain, erythema and arthus type reaction without constitutional symptoms may also occur 7–10 days after i.m. injection.

Immune globulins (IGs) are separated human gamma globulins which carry the antibodies. These may be nonspecific (normal) or specific (hyperimmune) against a particular antigen. These are *more efficacious* than the corresponding antisera. Hypersensitivity reactions are very rare with IGs. Skin tests may be misleading and are not needed. However, large doses and repeated injections do increase risk; adrenaline should be available. Transient local tenderness and stiffness

of injected muscle is occasional. Serum sickness does not occur with human IGs.

Antisera (from horse)

Tetanus antitoxin (ATS)
Gas gangrene antitoxin (AGS)
Diphtheria antitoxin (ADS)
Antirabies serum (ARS)
Antisnake venom polyvalent

Immune globulins (human)

Normal human gamma globulin
Anti-D immune globulin
Tetanus immune globulin
Rabies immune globulin
Hepatitis-B immune globulin

1. Normal human gamma globulin It is concentrated IG obtained by fractionation in cold from pooled human plasma. Indications for its use are—viral hepatitis A and B (prophylaxis), measles, mumps, poliomyelitis and chickenpox (prophylaxis and modification of course of illness), and has some beneficial action in burns. It is especially valuable in agammaglobulinemia, premature infants and in patients of leukemia or those undergoing immunosuppression. It can augment the response to antibiotics in debilitated patients with bacterial infections. *Dose*: 0.02–1 ml/kg i.m. for different indications.

GAMMALIN, GLOBUNAL, Sii GAMMA GLOBULIN, GAMAFINE 10%, 16.5% injection in 1, 2 ml amps.

An intravenous preparation (Sii I.V.GG 0.1–0.4 g/kg/day) has been made available for conditions requiring high doses which cannot be injected i.m.

2. Anti-D immune globulin (see p. 842).

3. Tetanus

(a) *Tetanus immune globulin (human)* It is indicated for prophylaxis in non-immunized persons receiving a contaminated wound who are at high risk of developing tetanus. The $t_{1/2}$ of this antitoxin is 4 weeks and significant blood levels

are maintained for upto 14 weeks. It is more efficacious and longer acting than the equine antitoxin (ATS). If tetanus toxoid is given at the same time (but at a different site), development of primary immune response to the toxoid is not interfered with. It has also been used for the treatment of clinical tetanus, but the efficacy is variable. Intrathecal administration has also been tried.

Dose: prophylactic 250–500 IU, therapeutic 3000–6000 IU i.m. and/or 250–500 IU intrathecal.

Sii TIG 250 IU (liquid), 500 IU (lyophilized), TETNAL 250 IU/2 ml inj., TETAGAM 250 IU/ml inj.

(b) *Tetanus antitoxin (antitetanic serum, ATS)* It is obtained from horse; is inferior to human antitoxin and should be used for the above indications only when tetanus immunoglobulin is not available.

Dose: prophylactic 1500–3000 IU, i.m. or s.c.;

therapeutic 50,000–100,000 IU part i.v. and rest i.m.

TETANUS ANTITOXIN 750 IU, 1500 IU, 5000 IU, 10,000 IU, 20,000 IU, and 50,000 IU in 1–10 ml ampoules.

TETANUS IMMUNE SERUM (enzyme refined, equine) 10,000 and 20,000 IU vials.

4. Rabies

(a) *Antirabies serum (ARS)* Also called 'equine rabies immunoglobulin' (ERIG) is refined, concentrated and lyophilized serum from horses hyperimmunized by repeated injections of fixed rabies virus. It is indicated promptly after suspected exposure and is given simultaneously with rabies vaccine to nonimmunized individuals. *Dose*—40 IU/kg infiltrated round the wound and excess is injected i.m.; single dose at the initiation of antirabic therapy along with rabies vaccine. It is inferior to HRIG and should be used only when HRIG is not available.

IMORAB 1000 IU/5 ml inj.

(b) *Rabies immunoglobulin human (HRIG)* It is used in the same manner as ARS and is superior to it with longer $t_{1/2}$. *Dose*—20 IU/kg, on day 0 only, infiltrated round the bite; excess may be injected i.m. elsewhere. Passive protection with HRIG or ARS is needed because active immunity takes 2 or more weeks to develop.

BERIR AB-P 300 IU/2 ml and 750 IU/5 ml inj; RABGLOB 300 IU/2 ml inj.

5. Hepatitis B immunoglobulin It is 10–18% solution of human IG containing a high titer of antibody to hepatitis B surface antigen. It is a better prophylactic than normal human gamma globulin: indicated in individuals acutely exposed to HBsAg positive blood or blood products. Hepatitis B vaccine should be given concurrently. *Dose:* 1000–2000 IU (adults), 32–48 IU/kg (children) to be administered within 7 days of exposure.

HEPAGLOB 100 IU (0.5 ml) 200 IU (1 ml) per vial for i.m. inj.

6. Diphtheria antitoxin (Antidiphtheritic serum ADS) It is obtained from horse and is used therapeutically in clinical diphtheria without waiting for bacteriological report, because each hour's delay increases the dose requirement and decreases beneficial effects: damage already caused by the toxin is not reversed. The antitoxin neutralizes the exotoxin released at the site of infection and that circulating in blood but not that fixed to tissues.

Dose: 20,000–40,000 IU i.m. or i.v. for pharyngeal/laryngeal disease of upto 48 hour duration. Higher dose (upto 100,000 IU may be needed).

DIPHThERIA ANTITOXIN 10,000 IU in 10 ml amp.

Appropriate antimicrobials should also be given. Unprotected child contacts should be given ADS (1000 IU) along with diphtheria toxoid for prophylaxis.

7. Gas gangrene antitoxin (Anti gas gangrene serum, AGS) It is enzyme refined equine antitoxin against *Cl. edematiens*, *Cl. perfringens* and *Cl. septicum*.

Dose: prophylactic 10,000 IU; therapeutic 30,000–75,000 IU s.c./i.m./i.v.

AGGS 10,000 IU amp.

8. Antisnake venom (ASV) serum polyvalent It is available as purified, enzyme refined and concentrated equine globulins in lyophilized vials with 10 ml ampule of distilled water. After reconstitution, each ml neutralizes:

0.6 mg of standard Cobra (*Naja naja*) venom.

0.6 mg of standard Russel's viper (*Vipera russelli*) venom.

0.45 mg of standard Sawscaled viper (*Echis carinatus*) venom.

0.45 mg of standard Krait (*Bungarus caeruleus*) venom.

ANTISNAKE VENOM SERUM POLYVALENT, ASVS

Dose: 20 ml i.v. (1 ml/min injection) repeated at 1–6 hourly intervals till symptoms of envenomation disappear: upto 300 ml may be required in viper bites, while still larger amounts (upto 900 ml) have been used in cobra bites, but it is

important to continue ASV treatment till evidence of envenomation persists. In case of viper bite some serum should also be infiltrated around the site to prevent venom induced gangrene.

Allergic reactions, including anaphylactic shock, to the serum are possible. When time permits, sensitivity test should be done; otherwise adrenaline may be injected s.c. concurrently. An antihistaminic and a glucocorticoid may also be given prophylactically.

CHAPTER 69

Drug Interactions

Drug interaction refers to modification of response to one drug by another when they are administered simultaneously or in quick succession. The modification is mostly quantitative, i.e. the response is either increased or decreased in intensity, but sometimes it is qualitative, i.e. an abnormal or a different type of response is produced. The possibility of drug interaction arises whenever a patient concurrently receives more than one drug, and the chances increase with the number of drugs taken.

Many medical conditions are treated with a combination of drugs. The components of the combination are so selected that they complement each other's action, e.g. an antibiotic is used along with an analgesic to treat a painful infective condition; adrenaline is combined with lidocaine for local anaesthesia; antitubercular drugs are combined to prevent drug resistance; mixed aerobic-anaerobic bacterial infections, are treated with a combination of antimicrobials. More commonly, multiple drugs are used to treat a patient who is suffering from two or more diseases at the same time. The chances of unintended/adverse drug interactions are greater in this later situation, because an assortment of different drugs may be administered to a patient depending on his/her diseases/symptoms.

Several drug interactions are desirable and deliberately employed in therapeutics, e.g. the

synergistic action of ACE inhibitors + diuretics to treat hypertension or sulfamethoxazole + trimethoprim to treat bacterial infection or furosemide + amiloride to prevent hypokalaemia. These are well-recognized interactions and do not pose any undue risk to the patient. The focus of attention in this chapter are drug interactions which may interfere with the therapeutic outcome or be responsible for adverse effects, or may even be fatal (bleeding due to excessive anticoagulant action).

The severity of drug interactions in most cases is highly unpredictable. However the doctor must

Regular medication drugs

(Likely to be involved in drug interactions)

1. Antidiabetics
2. Antihypertensives
3. Antianginal drugs
4. Antiarthritic drugs
5. Antiepileptic drugs
6. Antiparkinsonian drugs
7. Oral contraceptives
8. Anticoagulants
9. Antiasthmatic drugs
10. Psychopharmacological agents
11. Antipeptic ulcer drugs
12. Corticosteroids
13. Antitubercular drugs
14. Anti-HIV drugs

know which drugs are not to be prescribed concurrently. More importantly, a large section of patients may be receiving one or several drugs for their chronic medical conditions like hypertension, diabetes, arthritis, etc. (*see box* for regular medication drug classes employed commonly). The physician may prescribe certain drugs which may interact with those already being taken by the patient and result in adverse consequences. It is, therefore, imperative for the doctor to elicit a detailed drug history of the patient and record all the medication that he/she is currently on. The list of potential adverse drug interactions is already quite long and constantly growing. It is practically impossible for anyone to know/remember all possible drug interactions. Fortunately, the clinically important and common drug interactions that may be encountered in routine practice are relatively few. Some of these are listed in Table 69.1. More exhaustive compilations and documentation are available in specialized books, monographs, review articles and computer database on the subject, but these also need constant updating.

Certain types of drugs (*see box*) can be identified that are most likely to be involved in clinically important drug interactions. The physician may take special care and pay attention to the possibility of drug interactions when the patient is receiving one or more of such medications, or when the doctor intends to prescribe any of such drugs.

Types of drugs most likely to be involved in clinically important drug interactions

- Drugs with narrow safety margin, e.g. aminoglycoside antibiotics, digoxin, lithium.
- Drugs affecting closely regulated body functions, e.g. antihypertensives, antidiabetics, anticoagulants.
- Highly plasma protein bound drugs like NSAIDs, oral anticoagulants, sulfonyleureas.
- Drugs metabolized by saturation kinetics, e.g. phenytoin, theophylline.

MECHANISM OF DRUG INTERACTIONS

Drug interactions can be broadly divided into *pharmacokinetic* and *pharmacodynamic* interactions. In certain cases, however, the mechanisms are complex and may not be well understood. Few interactions take place even outside the body when drug solutions are mixed before administration.

Pharmacokinetic interactions

These interactions alter the concentration of the object drug at its site of action (and consequently the intensity of response) by affecting its absorption, distribution, metabolism or excretion.

Pharmacokinetic interactions

- Alteration of absorption or first-pass metabolism
- Displacement of plasma protein bound drug
- Alteration of drug binding to tissues affecting volume of distribution and clearance
- Inhibition/induction of metabolism
- Alteration of excretion

Absorption Absorption of an orally administered drug can be affected by other concurrently ingested drugs. This is mostly due to formation of insoluble and poorly absorbed complexes in the gut lumen, as occurs between tetracyclines and calcium/iron salts, antacids or sucralfate. Phenytoin absorption is decreased by sucralfate due to binding in the g.i. lumen. Such interactions can be minimized by administering the two drugs with a gap of 2–3 hours so that they do not come in contact with each other in the g.i.t. Ketoconazole absorption is reduced by H₂ blockers and proton pump inhibitors because they reduce gastric acidity which promotes dissolution and absorption of ketoconazole. Antibiotics like ampicillin, tetracyclines, cotrimoxazole markedly reduce gut flora that normally deconjugates oral contraceptive steroids secreted in the bile as glucuronides and permits their enterohepatic circulation. Several instances of contraceptive failure have been reported with concurrent use of these

antibiotics due to lowering of the contraceptive blood levels. Alteration of gut motility by atropinic drugs, tricyclic antidepressants, opioids and prokinetic drugs like metoclopramide or cisapride can also affect drug absorption.

Distribution Interactions involving drug distribution are primarily due to displacement of one drug from its binding sites on plasma proteins by another drug. Drugs highly bound to plasma proteins that have a relatively small volume of distribution like oral anticoagulants, sulfonylureas, certain NSAIDs and antiepileptics are particularly liable to displacement interactions. Another requirement is that the displacing drug should bind to the same sites on the plasma proteins with higher affinity. Displacement of bound drug will initially raise the concentration of the free and active form of the drug in plasma that may result in toxicity. However, such effects are usually brief, because the free form rapidly gets distributed, metabolized and excreted, so that steady-state levels are only marginally elevated. The clinical outcome of displacement interactions is generally significant only when displacement extends to tissue binding sites as well, or is accompanied by inhibition of metabolism and/or excretion. Quinidine has been shown to reduce the binding of digoxin to tissue proteins as well as its renal and biliary clearance by inhibiting the efflux transporter P-glycoprotein, resulting in nearly doubling of digoxin blood levels and toxicity.

Metabolism Certain drugs reduce or enhance the rate of metabolism of other drugs. They may thus affect the bioavailability (if the drug undergoes extensive first pass metabolism in liver) and the plasma half-life of the drug (if the drug is primarily eliminated by metabolism). Inhibition of drug metabolism may be due to competition for the same CYP450 isoenzyme or cofactor, and attains clinical significance mostly for drugs that are metabolized by saturation kinetics. Macrolide antibiotics, azole antifungals, chloramphenicol, omeprazole, SSRIs, HIV-protease inhibitors,

cimetidine, ciprofloxacin and metronidazole are some important inhibitors of metabolism of multiple drugs. Risk of statin induced myopathy is increased by fibrates, niacin, erythromycin, azole antifungals and HIV-protease inhibitors, probably due to inhibition of statin metabolism. Because lidocaine metabolism is dependent on hepatic blood flow, propranolol has been found to prolong its $t_{1/2}$ by reducing blood flow to the liver.

A number of drugs induce microsomal drug metabolizing enzymes and enhance biotransformation of several drugs (including their own in many cases). Induction involves gene mediated increased synthesis of certain CYP450 isoenzymes; takes 1–2 weeks of medication with the inducer to produce maximal effect (contrast inhibition of metabolism which develops quickly) and regresses gradually over 1–3 weeks after discontinuation of the inducer. Barbiturates, phenytoin, carbamazepine, rifampin, cigarette smoking, chronic alcoholism and certain pollutants are important microsomal enzyme inducers. Instances of failure of antimicrobial therapy with metronidazole, doxycycline or chloramphenicol have occurred in patients who are on long-term medication with an inducing drug. Contraceptive failure and loss of therapeutic effect of many other drugs have occurred due to enzyme induction. On the other hand, the toxic dose of paracetamol is lower in chronic alcoholics and in those on enzyme inducing medication, because one of the metabolites of paracetamol is responsible for its overdose hepatotoxicity.

Excretion Interaction involving excretion are important mostly in case of drugs actively secreted by tubular transport mechanisms, e.g. probenecid inhibits tubular secretion of penicillins and cephalosporins and prolongs their plasma $t_{1/2}$. This is particularly utilized in the single dose treatment of gonorrhoea. Aspirin blocks the uricosuric action of probenecid and decreases tubular secretion of methotrexate. Change in the pH of urine can also affect excretion of weakly acidic or weakly basic drugs. This has been

Table 69.1: Selected clinically important drug interactions

<i>Precipitant drug*</i>	<i>Object drug[‡]</i>	<i>Likely interaction and comments</i>
1. Ampicillin } Amoxicillin }	Oral contraceptives Oral anticoagulants	Interruption of enterohepatic circulation of the estrogen → failure of contraception; Advise alternative contraception. Inhibition of gut flora → decreased vit K production in gut → risk of bleeding; Monitor INR and reduce anticoagulant dose if needed.
2. Probenecid	Penicillin } Ampicillin } Cephalosporins }	Inhibition of tubular secretion → prolongation of antibiotic action; Desirable interaction utilized for single dose therapy.
3. Allopurinol	Ampicillin } 6-Mercaptopurine } Azathioprine } Warfarin } Theophylline }	Increased incidence of rashes; Avoid concurrent use. Inhibition of metabolism; Reduce dose of 6-MP/azathioprine to 1/3. Inhibition of metabolism; Monitor and reduce dose of object drug.
4. Carbenicillin } Ticarcillin }	Aspirin and other antiplatelet drugs	Perturbation of surface receptors on platelets → additive platelet inhibition → risk of bleeding; Avoid concurrent use.
5. Ceftriaxone } Cefoperazone }	Oral anticoagulants	Additive hypoprothrombinaemia → bleeding; Monitor INR and reduce dose of anticoagulant.
6. Sulfonamides } Cotrimoxazole }	Phenytoin Warfarin Sulfonylureas Thiazide diuretics Oral contraceptives	Displacement [§] + inhibition of metabolism → phenytoin toxicity; Avoid concurrent use. Displacement + inhibition of metabolism + decreased production of vit K in gut → risk of bleeding; Monitor INR and reduce dose of warfarin. Displacement + inhibition of metabolism → hypoglycaemia; Avoid concurrent use. Increased incidence of thrombocytopenia; Avoid concurrent use. Interruption of enterohepatic circulation of the estrogen → failure of contraception; Advise alternative contraception.
7. Metronidazole } Tinidazole } Cefoperazone }	Alcohol	Accumulation of acetaldehyde → disulfiram-like or bizarre reactions; Warn the patient not to drink alcohol.
8. Metronidazole } Tinidazole }	Lithium salts Warfarin	Decreased excretion → Li ⁺ toxicity; Monitor Li ⁺ level and reduce lithium dose. Inhibition of metabolism → risk of bleeding; Avoid concurrent use.
9. Ciprofloxacin } Norfloxacin } Pefloxacin }	Theophylline } Warfarin }	Inhibition of metabolism → toxicity of object drug; Monitor and reduce dose of object drug.
10. Erythromycin } Clarithromycin } Ketoconazole } Itraconazole } Fluconazole } Protease inhibitors }	Terfenadine } Astemizole } Cisapride } Phenytoin } Carbamazepine } Warfarin } Sulfonylureas } Diazepam } Theophylline } Cyclosporine } HIV protease inhibitors } Statins }	Inhibition of metabolism by CYP3A4 → rise in blood level of object drug → dangerous ventricular arrhythmia; Concurrent use contraindicated. Inhibition of metabolism by CYP3A4 → toxicity of object drug; Avoid concurrent use or readjust dose of object drug. Inhibition of metabolism, higher risk of myopathy; Avoid concurrent use.

* Precipitant drug is the drug, which alters the action/pharmacokinetics of the other drug.

‡ Object drug is the drug whose action/pharmacokinetics is altered.

§ Displacement of plasma protein bound drug.

Contd...

Contd...

Precipitant drug	Object drug	Likely interaction and comments
11. Gemfibrozil Nicotinic acid	Statins	Increased risk of myopathy; Caution in concurrent use.
12. Tetracyclines	Oral contraceptives	Interruption of enterohepatic circulation of the estrogen → failure of contraception; Advise alternative contraception.
	Lithium salts	Rise in plasma Li ⁺ level due to decreased excretion; Avoid use of tetracycline or monitor and reduce dose of lithium.
13. Iron salts Calcium salts Antacids Sucralfate	Tetracyclines Fluoroquinolones	Decreased absorption due to formation of complexes in g.i.t. → failure of antibiotic therapy; Stagger drug administration by 2–3 hours.
14. Furosemide	Minocycline	Enhanced vestibular toxicity; Avoid concurrent use.
	Aminoglycoside antibiotics	Additive ototoxicity and nephrotoxicity; Avoid concurrent use.
15. Diuretics	Tetracycline	Antianabolic effect of tetracycline increases urea production which is retained by the diuretic; Avoid concurrent use.
	Lithium	Decreased excretion—rise in Li ⁺ level—toxicity; Reduce dose of lithium and monitor level.
	Digoxin	Hypokalaemia caused by diuretic increases digoxin toxicity; Give K ⁺ sparing diuretic/K ⁺ supplements.
16. Tetracyclines Chloramphenicol Macrolide antibiotics Clindamycin	Penicillins Cephalosporins	Bactericidal action of penicillins and cephalosporins may be antagonized by the bacteriostatic antibiotics; Avoid concurrent use.
17. Clindamycin	Erythromycin Clarithromycin Azithromycin Chloramphenicol	Mutual antagonism of antibacterial action due to proximal binding sites on bacterial ribosomes; Avoid concurrent use.
18. Phenobarbitone Phenytoin Carbamazepine Rifampin	Metronidazole Doxycycline Chloramphenicol Protease inhibitors Warfarin Corticosteroids Oral contraceptives Sulfonyl ureas Antidepressants	Induction of metabolism → loss of efficacy of object drug; Avoid concurrent use or increase dose of object drug with monitoring.
19. Chloramphenicol	Warfarin Phenytoin Sulfonylureas	Inhibition of metabolism → toxicity of the object drug. Avoid concurrent use or monitor and reduce dose of object drug.
20. NSAIDs	Ciprofloxacin and other fluoroquinolones	Enhanced CNS toxicity, seizures; Avoid concurrent use.
21. Aspirin and other NSAIDs	Sulfonylureas Phenytoin Valproate Methotrexate	Displacement and/or reduced elimination → toxicity of object drug; Avoid concurrent use/substitute NSAID with paracetamol.
	Warfarin	Enhanced risk of bleeding due to antiplatelet action and gastric mucosal damage; Avoid concurrent use.
	Heparin	Reduced antihypertensive effect due to inhibition of renal PG synthesis; Avoid concurrent use.
	ACE inhibitors	
	β blockers	
	Thiazide diuretics	
	Furosemide	Reduced diuretic action due to PG synthesis inhibition in kidney; Avoid concurrent use.

Contd...

Contd...

<i>Precipitant drug</i>	<i>Object drug</i>	<i>Likely interaction and comments</i>
22. Aspirin and other NSAIDs	Alcohol Corticosteroids Spironolactone	} Increased risk of gastric mucosal damage and gastric bleeding; Concurrent use contraindicated. Reduced K ⁺ conserving action due to decreased tubular secretion of canrenone (active metabolite of spironolactone); Avoid concurrent use.
23. Chronic alcoholism	Paracetamol	
24. Chlorpromazine Imipramine and other TCAs	} Morphine Pethidine Codeine	} Enhanced CNS and respiratory depression; Avoid concurrent use.
25. Chlorpromazine Haloperidol Metoclopramide		
26. Levodopa-carbidopa	ACE inhibitors Vasodilators Prazosin	} Excessive postural hypotension; Reduce dose of antihypertensives.
27. TCAs	Adrenaline (added to local anaesthetic)	
28. Promethazine Alcohol Opioids Antipsychotics	} Diazepam and other benzodiazepines	} Additive CNS and respiratory depression, motor impairment; Avoid concurrent use.
29. Cimetidine Isoniazid		
30. Sildenafil Tadalafil	} Nitrates	} Inhibition of metabolism → exaggerated CNS depression; Avoid concurrent use or reduce benzodiazepine dose. Marked potentiation → precipitous fall in BP; Concurrent use contraindicated.
31. Propranolol		
32. Lidocaine	Lidocaine	Reduced hepatic clearance of lidocaine; Ceiling amount used in local anaesthesia is reduced.
	β-blockers	Enhanced bradycardia and hypotension; Avoid concurrent use.
	Quinidine and other antiarrhythmic drugs	Exaggerated cardiac depression, precipitation of arrhythmias; Avoid concurrent use.

NSAIDs: Nonsteroidal antiinflammatory drugs

TCAs: Tricyclic antidepressants

utilized in the treatment of poisonings. Diuretics and to some extent tetracyclines, ACE inhibitors and certain NSAIDs have been found to raise steady-state blood levels of lithium by promoting its tubular reabsorption.

Pharmacodynamic interactions

These interactions derive from modification of the action of one drug at the target site by another drug, independent of a change in its concentration. This may result in an enhanced response

(synergism), an attenuated response (antagonism) or an abnormal response. The phenomena of synergism and antagonism are described in Chapter 4, and are deliberately utilized in therapeutics for various purposes. Of clinical significance are the in-advertent concurrent administration of synergistic or antagonistic pair of drugs with adverse consequences. Some examples are:

1. Excessive sedation, respiratory depression, motor incoordination due to concurrent administration of a benzodiazepine

- (diazepam), a sedating antihistaminic (promethazine), a neuroleptic (chlorpromazine), an opioid (morphine) or drinking alcoholic beverage while taking any of the above drugs.
2. Excessive fall in BP and fainting due to concurrent administration of α_1 adrenergic blockers, vasodilators, ACE inhibitors, high ceiling diuretics and cardiac depressants.
 3. Pronounced and asymptomatic hypoglycaemia can occur when propranolol is administered to diabetics receiving insulin/sulfonylureas, due to blockade of β adrenoceptors which contribute to recovery from hypoglycaemia as well as some hypoglycaemic symptoms.
 4. Additive prolongation of prothrombin time and bleeding by administration of ceftriaxone or cefoperazone to a patient on oral anticoagulants.
 5. Excessive platelet inhibition resulting in bleeding due to simultaneous use of aspirin/ticlopidine/clopidogrel and carbenicillin.
 6. Increased risk of bleeding due to concurrent use of antiplatelet drugs (aspirin, clopidogrel) with anticoagulants (warfarin).
 7. Marked bradycardia due to administration of propranolol in digitalized patients.
 8. Precipitous fall in BP and myocardial ischaemia due to use of sildenafil by patients receiving organic nitrates, because nitrates increase generation of cGMP, while sildenafil prevents its degradation by inhibiting PDE 5.
 9. Severe hyperkalaemia by concurrent use of ACE inhibitors and K^+ sparing diuretics.
 10. Additive ototoxicity due to use of an aminoglycoside antibiotic in a patient receiving furosemide.
 11. Antagonism of bactericidal action of β -lactam antibiotic by combining it with a bacteriostatic drug like tetracycline, erythromycin or clindamycin.
 12. Mutual antagonism of antibacterial action of macrolides, clindamycin and chloramphenicol due to interference with each other's binding to the bacterial 50S ribosome.
 13. Reduction in antihypertensive action of clonidine by chlorpromazine and imipramine, possibly due to blockade of central action of clonidine.
 14. Attenuation of antihypertensive effect of ACE inhibitors/ β blockers/diuretics by NSAIDs due to inhibition of renal PG synthesis.
 15. Blunting of K^+ conserving action of spironolactone by aspirin, because it inhibits the tubular secretion of canrenone (an active metabolite of spironolactone).
 16. Blockade of antiparkinsonian action of levodopa by neuroleptics and metoclopramide having antidopaminergic action.
- Abnormal responses sometimes result from pharmacodynamic interaction between certain drugs, e.g. metronidazole and cefoperazone inhibit the enzyme aldehyde dehydrogenase resulting in bizarre distressing symptoms if the patient drinks alcohol. The basis of certain interactions is not explained, e.g. ampicillin has produced high incidence of skin rashes in patients treated with allopurinol.

Drug interactions before administration

Certain drugs react with each other and get inactivated if their solutions are mixed before administration. In combined oral or parenteral formulations, the manufacturers take care that such incompatibilities do not take place. In practice situations, these *in vitro* interactions occur when injectable drugs are mixed in the same syringe or infusion bottle. Some examples are:

- Penicillin G or ampicillin mixed with gentamicin or another aminoglycoside antibiotic.
- Thiopentone sodium when mixed with succinylcholine or morphine.
- Heparin when mixed with penicillin/gentamicin/hydrocortisone.
- Noradrenaline when added to sodium bicarbonate solution.

In general, it is advisable to avoid mixing of any two or more parenteral drugs before injecting.

Comment Not all patients taking interacting drugs experience adverse consequences, but it is advisable to take due precautions to avoid mishaps in all cases where interactions are possible. That two drugs have the potential to interact does not necessarily contraindicate their concurrent use. In many cases, knowledge of the nature and mechanism of the possible interaction

may permit their concurrent use provided appropriate dose adjustments are made or other corrective measures are taken. A list of significant and common drug interactions that may be encountered in clinical practice is given in Table 69.1, along with the suggested corrective measure. However, it is prudent to consider the possibility of drug interaction whenever two or more drugs are prescribed to a patient, or any drug is added to what the patient is already taking.

Selected References for Further Reading

1. Brunton LL, Lazo JS, Parker KL (Eds.): Goodman and Gilman's *The Pharmacological Basis of Therapeutics*: 11th edn: McGraw-Hill, New York, **2006**.
2. Tierney LM Jr, Mc Phee SJ, Papadakis MA (Eds): *Current Medical Diagnosis and Treatment 2006*: Lange Medical Books/McGraw-Hill, New York, **2006**.
3. Sweetman SC (Eds). *Martindale, The Complete Drug Reference*: 35th edn: The Pharmaceutical Press, The Royal Pharmaceutical Society of Great Britain, London, **2007**.
4. *British National Formulary*, No 53; BMJ Publishing Group and RPS Publishing, London, **2007**.
5. *Drug: Facts and Comparisons*: 56th edn: Facts and Comparisons (Wolters Kluwer Health, Inc), St. Louis, **2002**.
6. *Essential Medicines, WHO Model List*: 15th edn, WHO, Geneva (March **2007**).
7. *National List of Essential Medicines* (2003). Govt. of India, Ministry of Health & Family Welfare, Directorate General of Health Services, New Delhi, **2003**.
8. Katzung BG (Eds): *Basic and Clinical Pharmacology*: 10th edn: McGraw-Hill, Boston, **2007**.
9. Rang HP, Dale MM, Ritter JM, Moore PK: *Pharmacology*: 5th edn: Churchill Livingstone, Edinburgh, **2003**.
10. Sharma S, Sethi GR, Sachdev GK, Gupta U, Gulati RK (Eds): *Standard Treatment Guidelines*: 2nd edn: Delhi Society for Promotion of Rational Use of Drugs, BI Publications, New Delhi, **2005**.
11. Agarwal AK, Singhal RK, Jain DG, Upadhyay R, Rewari BB (Eds): *Emergency Medicine*; Association of Physicians of India, Delhi State Chapter, Jaypee Brothers, New Delhi, **2005**.
12. Rubin P (Eds): *Prescribing in Pregnancy*: 3rd edn: BMJ Books, London, Jaypee Brothers, New Delhi (Indian edition 2001), **2000**.
13. Page CP, Curtis MJ, *et al* (Eds.): *Integrated Pharmacology*: 2nd edn: Mosby, London, **2002**.
14. Project Team of the Resuscitation Council (UK): Emergency medical treatment of anaphylactic reactions: consensus guidelines; *Resuscitation* **41**: 93-99, **1999**.
15. Hoyng PFJ, Van Beek LM: Pharmacological therapy for glaucoma; *Drugs* **59**: 411-434, **2000**.
16. Tfelt-Hansen P, De Vries P, Saxena PR: Triptans in migraine: a comparative review of pharmacology, pharmacokinetics and efficacy; *Drugs* **60**: 1259-1287, **2000**.
17. Bresler RS, *et al*: Cardiovascular events associated with rofecoxib in a colorectal adenoma chemoprevention trial, Adenomatous polyp prevention on viox (APPROVE). *N Engl J Med* **352**: 1092-1102, **2005**.
18. Kearney PM, *et al*: Do selective COX-2 inhibitors and traditional NSAIDs increase the risk of atherothrombosis? Meta-analysis of randomized trials. *BMJ* **332**: 1302-1308, **2006**.
19. Schnitzer TJ. Update on guidelines for the treatment of chronic musculoskeletal pain. *Clin Rheumatol* **25**: (Suppl 7) 22-29, **2006**.
20. Heyneman CA, Lawless-Liday C, Wall GC: Oral versus topical NSAIDs in rheumatic diseases: a comparison; *Drugs* **60**: 555-574, **2000**.
21. Diabetes control and complications trial (DCCT) Group: Effect of intensive therapy on the microvascular complications of type 1 diabetes mellitus; *JAMA* **287**: 2563-2569, **2002**.
22. UK Prospective Diabetes Study Group: Intensive blood-glucose control with sulfonylureas or insulin compared with conventional regimen and risk of complications in patients with type 2 diabetes (UKPDS 33); *Lancet* **352**: 837-853, **1998**.
23. Diabetes Prevention Programme (DPP) research group: Reduction in the incidence of type 2 diabetes with lifestyle intervention or metformin. *N Engl J Med* **346**: 393-403, **2002**.
24. Chaisson JL, *et al*. Acarbose treatment and risk of cardiovascular disease and hypertension in patients with impaired glucose tolerance: The Stop-NIDDM Trial. *JAMA* **290**: 486, **2003**.
25. Dormandy JA, *et al*: Secondary prevention of macrovascular events in patients with type 2 diabetes in the PROactive study: A randomized controlled trial. *Lancet* **366**: 1280, **2005**.
26. Scheen AJ. Prevention of type 2 diabetes mellitus through inhibition of the renin-angiotensin system. *Drugs* **64**: 2537-2565, **2004**.
27. Dellinger RP, *et al*. Surviving sepsis campaign guidelines for management of severe sepsis and septic shock. *Crit Care Med* **32**: 858-873, **2004**.
28. Anderson GL, *et al*: The Women's Health Initiative (WHI) randomized controlled trial: Effect of conjugated equine estrogens in post-menopausal women with hysterectomy. *JAMA* **291**: 1701-1712, **2004**.

29. Espeland MA, *et al*: The WHI-memory study: Conjugated equine estrogens and global cognitive function in postmenopausal women. *JAMA* 291: 2959-2968, 2004.
30. Rossouw JE, *et al*: The WHI trial, risks and benefits of estrogens + progestin in healthy postmenopausal women; principal results. *JAMA* 288: 321-333, 2002.
31. Beral V, *et al*: Million Women Study (MWS): Breast cancer and hormone replacement therapy. *Lancet* 362: 419-427, 2003.
32. Simpson D, Curran MP, Perry CM: Letrozole: A review of its use in postmenopausal women with breast cancer. *Drugs* 64: 1213-1230, 2004.
33. Grady D, Herrington D, *et al*: Cardiovascular disease outcomes during 6.8 years of hormone therapy: Heart and estrogen/progestin replacement study follow-up (HERS II); *JAMA* 288: 49-57, 2002.
34. Johnston CC Jr, Bjarnason NH, *et al*: Long term effects of raloxifene on bone mineral density, bone turnover, and serum lipid levels in early postmenopausal women; *Arch Intern Med* 160: 3444-3450, 2000.
35. Child TJ, Tan SL: Endometriosis: aetiology, pathogenesis and treatment; *Drugs* 61: 1735-1760, 2001.
36. The Magpie Trial Collaborative Group: Do women with pre eclampsia and their babies benefit from magnesium sulfate? The Magpie trial: a randomized placebo-controlled trial. *Lancet* 359: 1877-1890, 2002.
37. Sharpe M, Noble S, Spencer CM: Alendronate: an update of its use in osteoporosis; *Drugs* 61: 999-1039, 2001.
38. Sparr HJ, Beaufort TM, Fuchs-Buder T: Newer neuromuscular blocking agents: how do they compare with established agents; *Drugs* 61: 919-942, 2001.
39. Holm KJ, Goa KL: Zolpidem: an update of its pharmacology, therapeutic efficacy and tolerability in the treatment of insomnia; *Drugs* 59: 865-889, 2000.
40. Baskett JJ, *et al*: Does melatonin improve sleep in older people? A randomized crossover trial. *Age Ageing* 32: 164, 2003.
41. Sabers A, Gram L: Newer anticonvulsants: comparative review of drug interactions and adverse effects; *Drugs* 60: 23-33, 2000.
42. Parkinson Study Group: Pramipexole *vs* levodopa as initial treatment for Parkinson's disease, A randomized controlled trial. *JAMA* 284: 1931-1938, 2000.
43. Matheson AJ, Spencer CM: Ropinirole: a review of its use in the management of Parkinson's disease; *Drugs* 60: 115-137, 2000.
44. Lieberman JA, *et al*: Effectiveness of antipsychotic drugs in patients with chronic schizophrenia. *N Engl J Med* 353: 1209, 2005.
45. Hadjipavlou G, Mok H, Yatham LN: Pharmacotherapy of bipolar II disorder: a critical review of current evidence. *Bipolar Disord* 6: 14-25, 2004.
46. Lee F, Cundiff D: Meperidine *vs* morphine in pancreatitis and cholecystitis; *Arch Intern Med* 158: 2399, 1998.
47. Wilkinson D: Drugs for the treatment of Alzheimer's disease; *Int J Clin Pract* 55: 129-134, 2001.
48. Reisberg B, *et al*: Memantine in moderate to severe Alzheimer's disease. *New Engl J Med* 348: 1333-1341, 2003.
49. Yusuf S, Sleight P, *et al*: Effects of an angiotensin-converting enzyme inhibitor ramipril, on cardiovascular events in high risk patients. The Heart Outcomes Prevention Evaluation (HOPE) study investigators; *N Engl J Med* 342: 145-153, 2000.
50. Packer M, Poole-Wilson PA, *et al*: Comparative effects of low and high doses of the angiotensin converting enzyme inhibitor, lisinopril, on morbidity and mortality in chronic heart failure. ATLAS study Group; *Circulation* 100: 2312-2318, 1999.
51. EUROPA investigators: Efficacy of perindopril in reduction of cardiovascular events among patients with stable coronary artery disease; European trial on the reduction of cardiac events with perindopril in stable coronary artery disease. *Lancet* 362: 782-788, 2003.
52. Pfeffer MA, *et al*: Valsartan, captopril or both in myocardial infarction complicated by heart failure, left ventricular dysfunction or both; Valsartan in acute myocardial infarction trial (VALIANT). *New Engl J Med* 349: 1893-1896, 2003.
53. Mc Murray JJ, *et al*: Effect of candesartan in patients with chronic heart failure and reduced left ventricular systolic function taking ACE inhibitors. The CHARM-Added Trial. *Lancet* 362: 767-771, 2003.
54. Pitt B, Zannad F, *et al*: The effect of spironolactone on morbidity and mortality in patients with severe heart failure. Randomized Aldactone Evaluation study (RALES) investigators; *N Engl J Med* 341: 709-717, 1999.
55. Packer M, Coats AJS, *et al*: Effect of Carvedilol on survival in severe chronic heart failure; *N Engl J Med* 344: 1651-1658, 2001.
56. Furberg C, *et al*: Nifedipine: Dose related increase in mortality in patients with coronary heart disease; *Circulation* 92: 1326-1331, 1996.
57. Mc Clellan KJ, Plosker GL: Trimetazidine: a review of its use in stable angina pectoris and other coronary conditions; *Drugs* 58: 143-157, 1999.
58. Simpson D, Wellington K: Nicorandil: A review of its use in the management of stable angina pectoris, including high risk patients. *Drugs* 64: 1941-1955, 2004.
59. Chaitman BR: Ranolazine for the treatment of chronic angina and potential use in other

- cardiovascular conditions. *Circulation* 113: 2462-2472, 2006.
60. Opie LH, Yusuf S, Kübler W: Current status of safety and efficacy of calcium channel blockers in cardiovascular diseases: A critical analysis based on 100 studies. *Prog Cardiovasc Dis* 43: 171-196, 2000.
 61. Chobanian AV, *et al*: The 7th report of the Joint National Committee on prevention, detection, evaluation and treatment of high blood pressure: The JNC7 report; *JAMA* 289: 2560-2572, 2003.
 62. Whitworth JA: World Health Organization (WHO)/International Society of Hypertension (ISH) statement on management of hypertension. *J Hypertens* 21: 1983, 2003.
 63. Hansson L, Lindholm LH, *et al*: Randomised trial of old and new antihypertensive drugs in elderly patients: Cardiovascular mortality and morbidity, the swedish trial in old patients with hypertension - 2 (STOP-Hypertension-2) Study; *Lancet* 354: 1751-1756, 1999.
 64. Bousquet P, Feldman J: Drugs acting on imidazoline receptors; *Drugs* 58: 779-812, 1999.
 65. ALLHAT officers, *et al*: Major outcomes in high-risk hypertensive patients randomized to ACE inhibitor or calcium channel blocker *vs* diuretic. The antihypertensive and lipid-lowering treatment to prevent heart attack trial. *JAMA* 288: 2981-2997, 2002.
 66. Arnold JMO, *et al*: Prevention of heart failure in patients, in the HOPE study. *Circulation* 107: 1284-1290, 2003.
 67. Walraven CV, Hart RG, *et al*: Oral anticoagulant *vs* aspirin in nonvalvular atrial fibrillation: an individual patient meta-analysis; *JAMA* 288: 2441-2448, 2002.
 68. Hirsh J, Fuster V, Ansell J, Halperin JL: American Heart Association/American College of Cardiology Foundation guide to warfarin therapy. *Circulation* 107: 1692-1711, 2003.
 69. Mehta SR, Yusuf S, *et al*: The clopidogrel in unstable angina to prevent recurrent events (CURE) trial including a metaanalysis. *Eur Heart J* 21: 2033-2041, 2000.
 70. The GUSTO IV-ACS investigators: Effect of GP II_b/III_a receptor blocker abciximab on outcome in patients with acute coronary syndromes without early coronary revascularization. *Lancet* 357: 1915-1924, 2001.
 71. Hcumha DL, *et al*: European stroke prevention study (ESPS2). *J Neurol Sci* 143: 1-13, 1996.
 72. Braunwald E, *et al*: ACC/AHA 2002 guideline update for the management of patients with unstable angina and non-ST elevation myocardial infarction. *J Am Coll Cardiol* 40: 1366-1379, 2002.
 73. Jarvis B, Simpson K: Clopidogrel: A review of its use in the prevention of atherothrombosis; *Drugs* 60: 347-377, 2000.
 74. Jones P, Kafonek S, *et al*: Comparative dose efficacy study of atorvastatin *vs* simvastatin, pravastatin, lovastatin and fluvastatin in patients with hypercholesterolemia (the CURVES study). *Am J Cardiol* 81: 582-587, 1998.
 75. Grundy SM, *et al*: Implications of recent clinical trials for the National Cholesterol Education Programme, ATPIII guidelines. *Circulation* 110: 227-239, 2004.
 76. Heart Protection Study collaborative group: Effects of cholesterol lowering with simvastatin on stroke and other major vascular events in 20,536 people with cerebrovascular disease or other high-risk conditions. *Lancet* 363: 757-767, 2004.
 77. Peitz U, Hackelsberger A, Malfertheiner: A practical approach to patients with refractory *Helicobacter pylori* infection, or who are reinfected after standard therapy. *Drugs* 57: 905-917, 1999.
 78. New Formula (reduced osmolarity) oral rehydration salts: *WHO Drug Information* 16(2): 121-122, 2002.
 79. Clemett D, Markham A: Linezolid. *Drugs* 59: 815-827, 2000.
 80. Treatment of Tuberculosis: Guidelines for National Programmes, 2nd edn: WHO, Geneva, 1997.
 81. Balasubramanian R: Directly observed treatment short-course: Tuberculosis cure for all. *ICMR Bulletin* 31(3): 37-43, 2001.
 82. Girdhar BK, Girdhar A: Short course treatment of leprosy: present status. *ICMR Bulletin* 32(2): 13-19, 2002.
 83. WHO Global strategy for further reducing the leprosy burden and sustaining leprosy control activities. *Ind J Leprosy* 78: 7-31, 2006.
 84. India achieves National elimination of leprosy. *Ind J Leprosy* 78: 101, 2006.
 85. Yeni PG, Hammer SM, *et al*: Antiretroviral treatment for adult HIV infection in 2002: updated recommendations of the International AIDS Society-USA Panel. *JAMA* 288: 222-235, 2002.
 86. Updated US Public Health Service Guidelines for management of occupational exposures to HBV, HCV and HIV and recommendations for post exposure prophylaxis. *Morb Mortal Wkly Rep (MMWR)* 50(RR-11): 1-42, 2001.
 87. Jefferson T, Demicheli, V, *et al*: Antivirals for influenza in healthy adults: systematic review. *Lancet* 367: 303-313, 2006.
 88. Expert Committee on Malaria: 20th Report; *WHO Technical Report Series* No. 892: 2000.
 89. National Drug Policy on Malaria (2007), Directorate of National Vector Borne Disease Control Programme (DGHS), Govt. of India, 2007.
 90. Mohapatra PK, *et al*: Evaluation of chloroquine and sulphadoxine/pyrimethamine therapy in uncomplicated falciparum malaria in Indo-Myanmar border

- areas. *Trop Med and Internat Health* 10: 478-483, **2005**.
91. White NJ for SEAQUAMAT group: Artesunate versus quinine for treatment of severe falciparum malaria: a randomized trial. *Lancet* 366: 717-725, **2005**.
 92. Melaku Y, *et al*. Treatment of kala-azar in Southern Sudan using a 17-day regimen of sodium stibogluconate combined with paromomycin: a retrospective comparison with 30-day sodium stibogluconate monotherapy. *Am J Trop Med Hyg* 77: 89-94, **2007**.
 93. Sundar S, *et al*: Injectable paromomycin for visceral leishmaniasis in India. *N Engl J Med* 356: 2571-2581, **2007**.
 94. Roos TC, Alam M, *et al*: Pharmacotherapy of ectoparasitic infections; *Drugs* 61: 1067-1088, **2001**.
 95. Breastfeeding and maternal medication; *WHO/CDR* 95.11, **1995**.

Appendices



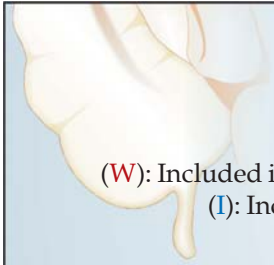

Appendix - 1

List of Essential Medicines

(W): Included in WHO Model List of Essential Medicines (15th edition, March 2007)

(I): Included in National List of Essential Medicines (2003), India

A

Abacavir (ABC)	(W)
Acenocoumarol	(I)
Acetazolamide	(W,I)
Acetylcysteine	(W)
Acetyl salicylic acid (Aspirin)	(W,I)
Acriflavin + Glycerine	(I)
Actinomycin D (Dactinomycin)	(W,I)
Activated charcoal	(W,I)
Acyclovir	(W,I)
Adenosine	(I)
Albendazole	(W,I)
Albumin	(I)
Alcuronium	(W)
Allopurinol	(W,I)
Alpha interferon	(I)
Alprazolam	(I)
Aluminium diacetate	(W)
Aluminium hydroxide + Magnesium hydroxide	(I)
Amikacin	(W,I)
Amiloride	(W)
Aminophylline	(I)
<i>p</i> -Aminosalicylic acid	(W)
Amiodarone	(I)
Amitriptyline	(W,I)
Amlodipine	(W,I)
Amodiaquine	(W)
Amoxicillin	(W,I)
Amoxicillin + Clavulanic acid	(W)
Amphotericin B	(W,I)
Ampicillin	(W,I)
Anti-snake venom serum	(W,I)
Anti-D immunoglobulin (Human)	(W,I)
Anti-Tetanus immunoglobulin (Human)	(W,I)
Artemether	(W)
Artemether + Lumefantrine	(W)
Artesunate	(W,I)
Ascorbic acid	(W,I)
Atenolol	(W,I)
Atracurium	(I)
Atropine	(W,I)
Azathioprine	(W,I)
Azithromycin	(W,I)

B

B.C.G. vaccine	(W,I)
Beclomethasone dipropionate	(W,I)
Benzathine benzylpenicillin	(W,I)
Benzoic acid + Salicylic acid	(W,I)
Benzoin compound	(I)
Benzoyl peroxide	(W)
Benzyl benzoate	(W,I)
Benzyl Penicillin	(W,I)
Betamethasone dipropionate	(W,I)
Betaxolol	(I)
Biperiden	(W)
Bisacodyl	(I)
Bleaching powder	(I)
Bleomycin	(W,I)
Bretylium tosylate	(I)
Bromocriptine	(I)
Bupivacaine	(W,I)
Busulfan	(I)

C

Caffeine	(W)
Calamine (lotion)	(W,I)
Calcium salts (gluconate)	(W,I)
Capreomycin	(W)
Carbamazepine	(W,I)
Carbimazole	(I)
Cefazolin	(W)
Cefixime	(W)
Cefotaxime	(I)
Ceftazidime	(W,I)
Ceftriaxone	(W,I)
Cefuroxime	(I)
Centchroman	(I)
Cephalexin	(I)
Cetrimide	(I)
Chlorambucil	(W)
Chloramphenicol	(W,I)
Chlorhexidine	(W,I)
Chloroquine	(W,I)
Chloroxylenol	(W)
Chlorpheniramine	(W,I)
Chlorpromazine	(W,I)

Chlorthalidone	(I)	Emtricitabine	(W)
Cholera vaccine	(W)	Emtricitabine + tenofovir	(W)
Ciprofloxacin	(W,I)	Enalapril	(W,I)
Cisplatin	(W,I)	Ephedrine	(W)
Clarithromycin	(I)	Epinephrine (adrenaline)	(W,I)
Clindamycin	(W)	Ergometrine	(W)
Clofazimine	(W,I)	Erythromycin	(W,I)
Clomiphene	(W,I)	Estradiol cypionate	(W)
Clomipramine	(W,I)	Esmolol	(I)
Clotrimazole	(W)	Ethambutol	(W,I)
Cloxacillin	(W,I)	Ether, anaesthetic	(I)
Coal tar	(W,I)	Ethinylestradiol	(W,I)
Codeine	(W,I)	Ethinylestradiol + Levonorgestrel	(W,I)
Colchicine	(W,I)	Ethinylestradiol + Norethisterone	(W,I)
Concentrated vit. A solution	(W,I)	Ethionamide	(W)
Co-trimoxazole	(W,I)	Ethosuximide	(W)
(Trimethoprim + Sulphamethoxazole)		Ethyl alcohol 70%, denatured	(W,I)
Cyclophosphamide	(W,I)	Ethyl chloride	(I)
Cycloserine	(W)	Etoposide	(W,I)
Cyclosporine	(W,I)		
Cytosine arabinoside (cytarabine)	(W,I)		
		F	
D		Factor IX complex	(W,I)
D.P.T. vaccine	(W,I)	(coagulation factors II,VII,IX,X)	
Dacarbazine	(W)	Factor VIII concentrate	(W,I)
Danazol	(I)	Ferrous salt	(W,I)
Dapsone	(W,I)	Ferrous salt + folic acid	(W)
Daunorubicin	(W)	Fluconazole	(W,I)
Deferoxamine	(W,I)	Flucytosine	(W,I)
Dexamethasone	(W,I)	Flumazenil	(I)
Dextran-40	(I)	Fluorescein	(W,I)
Dextran 70	(W,I)	5-Fluorouracil	(W,I)
Dextromethorphan	(I)	Fluoxetine	(W,I)
Diazepam	(W,I)	Fluphenazine	(W)
Diclofenac	(I)	Flutamide	(I)
Dicyclomine HCl	(I)	Folic acid	(W,I)
Didanosine (ddl)	(W,I)	Folinic acid	(I)
Diethylcarbamazine	(W,I)	Formaldehyde IP	(I)
Digoxin	(W,I)	Framycetin sulfate	(I)
Dihydro ergotamine	(I)	Fresh frozen plasma	(I)
Diloxanide furoate	(W,I)	Furazolidone	(I)
Diltiazem	(I)	Furosemide	(W,I)
Dimercaprol	(W,I)		
Diphtheria antitoxin	(W,I)	G	
Dithranol	(W,I)	Gamma benzene hexachloride	(I)
Dobutamine	(I)	Gemcitabine	(I)
Domperidone	(I)	Gentamicin	(W,I)
Dopamine	(W,I)	Gentian violet	(W,I)
Doxapram	(I)	Glibenclamide	(W,I)
Doxorubicin	(W,I)	Glucagon	(I)
Doxycycline	(W,I)	Glucose	(W,I)
		Glucose with sodium chloride	(W,I)
E		Glutaraldehyde (Glutaral)	(W,I)
Efavirenz (EFV or EFZ)	(W,I)	Glycerine IP	(I)
Efavirenz + emtricitabine + tenofovir	(W)	Glyceryl trinitrate	(W,I)
		Griseofulvin	(W,I)

H		
Haemophilus influenzae (b) vaccine	(W)	
Haloperidol	(W,I)	
Halothane	(W,I)	
Heparin sodium	(W,I)	
Hepatitis A vaccine	(W)	
Hepatitis B vaccine	(W,I)	
Homatropine	(I)	
Hydralazine	(W)	
Hydrochlorothiazide	(W,I)	
Hydrocortisone	(W)	
Hydrocortisone sodium succinate	(I)	
Hydrogen peroxide	(I)	
Hydroxocobalamin	(W)	
Hydroxyethyl starch (Hetastarch)	(I)	
Hyoscine N butylbromide	(I)	
I		
Ibuprofen	(W,I)	
Imipenem + Cilastatin	(W)	
Imipramine	(I)	
Immunoglobulin (human, normal)	(W)	
Indinavir	(W,I)	
Influenza vaccine	(W)	
Insulin injection (soluble)	(W,I)	
Intermediate acting insulin (Lente/NPH insulin)	(W,I)	
Intraperitoneal dialysis solution	(W,I)	
Iodine	(W,I)	
Ipratropium bromide	(W)	
Iron dextran	(W,I)	
Isoflurane	(I)	
Isoniazid	(W,I)	
Isoniazid + Ethambutol	(W)	
Isoniazid + Rifampicin	(W)	
Isoniazid + Rifampicin + Pyrazinamide	(W)	
Isoniazid + Rifampicin + Pyrazinamide + Ethambutol	(W)	
Isoprenaline	(I)	
Isosorbide dinitrate	(W)	
Isosorbide-5-mononitrate	(I)	
Isosuprine	(I)	
Isphagula	(I)	
IUD containing Copper	(W,I)	
Ivermectin	(W)	
K		
Kanamycin	(W)	
Ketamine	(W,I)	
Ketoconazole	(I)	
L		
Lamivudine (3TC)	(W,I)	
Lamivudine + zidovudine	(W,I)	
Lamivudine + Nevirapine + Stavudine	(W,I)	
L-Asparaginase	(W,I)	
Levamisol	(W)	
Levodopa + Carbidopa	(W,I)	
Levonorgestrel	(W)	
Levothyroxine	(W,I)	
Lidocaine (Lignocaine)	(W,I)	
Lidocaine + Epinephrine	(W,I)	
Lithium carbonate	(W,I)	
Local anaesthetic, astringent and antiinflammatory drugs (antihaemorrhoidal)	(I)	
Loperamide	(I)	
Lopinavir	(W)	
Lopinavir + Ritonavir (LPV/r)	(W)	
Losartan	(I)	
Lumefantrine	(W)	
M		
Magnesium hydroxide	(W)	
Magnesium sulfate	(W,I)	
Mannitol	(W,I)	
Measles vaccine	(W,I)	
Mebendazole	(W,I)	
Melphalan	(I)	
Medroxy progesterone acetate (depot)	(W)	
Medroxy progesterone acetate + Estradiol cypionate	(W)	
Mefloquine	(W)	
Meglumine antimonate	(W)	
Melarsoprol	(W)	
Menadione sod. sulphite	(I)	
Meningococcal vaccine	(W)	
Mercaptopurine	(W,I)	
Metformin	(W,I)	
Methotrexate	(W,I)	
Methyl cellulose	(I)	
Methyldopa	(W)	
Methyl ergometrine	(I)	
Methylprednisolone	(I)	
Methylthionium chloride (methylene blue)	(W,I)	
Metoclopramide	(W,I)	
Metoprolol	(I)	
Metronidazole	(W,I)	
Mexiletine	(I)	
Miconazole	(W,I)	
Midazolam	(I)	
Mifepristone	(W,I)	
Mitomycin-C	(I)	
Morphine	(W,I)	
Multivitamins	(I)	
Mumps vaccine	(W)	
N		
Nalidixic acid	(I)	
Naloxone	(W,I)	

Nelfinavir (NFV)	(W,I)	Procainamide	(W,I)
Neomycin	(W)	Procaine benzylpenicillin	(W,I)
Neomycin + Bacitracin	(W,I)	Procarbazine	(W,I)
Neostigmine	(W,I)	Prochlorperazine	(I)
Nevirapine (NVP)	(W,I)	Progauil	(W)
Niclosamide	(W,I)	Promethazine	(W,I)
Nicotinamide	(W,I)	Propranolol	(W,I)
Nifedipine	(W,I)	Propylthiouracil	(W)
Nitrazepam	(I)	Protamine sulfate	(W,I)
Nitrofurantoin	(W,I)	Prussian blue	(W)
Nitrous oxide	(W,I)	Pyrantel pamoate	(W,I)
Norethisterone	(W,I)	Pyrazinamide	(W,I)
Norfloxacin	(I)	Pyridostigmine	(W,I)
Nystatin	(W,I)	Pyridoxine	(W,I)
		Pyrimethamine + Sulfadoxine	(W,I)
O		Q	
Ofloxacin	(W,I)	Quinidine	(W,I)
Omeprazole	(I)	Quinine	(W,I)
Ondansetron	(I)		
Oral Poliomyelitis vaccine (live attenuated)	(W,I)	R	
Oral rehydration salts	(W,I)	Rabies immunoglobulin	(W,I)
Oxamniquine	(W)	Rabies vaccine	(W,I)
Oxygen	(W,I)	Raloxifene	(I)
Oxytocin	(W,I)	Ranitidine HCl	(I)
		Reserpine	(W)
P		Retinol (Vit A)	(W,I)
Paclitaxel	(I)	Riboflavin	(W,I)
Pancuronium	(I)	Rifampicin	(W,I)
Paracetamol	(W,I)	Ringer lactate solution	(I)
Paromomycin	(W)	Ritonavir (r)	(W,I)
Penicillamine	(W,I)	Roxithromycin	(I)
Pentamidine isothionate	(W,I)	Rubella vaccine	(W)
Pentazocine	(I)		
Permethrin	(W)	S	
Pertussis vaccine	(W)	Salbutamol	(W,I)
Pethidine	(I)	Salicylic acid	(W,I)
Pheniramine	(I)	Saquinavir (SQV)	(W,I)
Phenobarbital	(W,I)	Selenium sulfide	(W)
Phenylephrine	(I)	Senna	(W)
Phenoxyethyl penicillin	(W)	Silver nitrate	(I)
Phenytoin sodium	(W,I)	Silver sulphadiazine	(W,I)
Physostigmine	(I)	Simvastatin	(W)
Phytomenadione	(W,I)	Sodium calcium edetate	(W)
Pilocarpine	(W,I)	Sodium chloride	(W)
Pneumococcal vaccine	(W)	Sodium fluoride	(W)
Podophyllum resin	(W)	Sodium hydrogen carbonate	(W,I)
Polygeline	(I)	Sodium lactate	(W)
Potassium chloride	(W,I)	Sodium nitrite	(W,I)
Potassium iodide	(W)	Sodium nitroprusside	(W,I)
Potassium permanganate	(W,I)	Sodium stibogluconate	(I)
Povidone iodine	(W,I)	Sodium thiosulfate	(W,I)
Pralidoxime (2-PAM)	(I)	Sodium valproate (valproic acid)	(W,I)
Praziquantel	(W,I)	Spectinomycin	(W)
Prednisolone	(W,I)	Spironolactone	(W,I)
Primaquine	(W,I)	Stavudine (d4T)	(W,I)

Streptokinase	(W,I)	Tuberculin purified protein derivative	(W,I)
Streptomycin	(W,I)	Typhoid vaccine	(W)
Succinyl choline (Suxamethonium)	(W,I)	U	
Sulfacetamide sod.	(I)	Urea	(W)
Sulfadiazine	(W,I)	Urokinase	(I)
Sulfadoxine	(W)	V	
Sulfamethoxazole	(W)	Vancomycin	(W,I)
Sulfasalazine	(W,I)	Varicella vaccine	(W)
Suramin sod.	(W)	Vecuronium	(W)
T		Verapamil	(W,I)
Tamoxifen	(W,I)	Vinblastine	(W,I)
Tenofovir disoproxil fumarate	(W)	Vincristine	(W,I)
Terazosin	(I)	Vit B ₁₂ (Cyanocobalamin)	(W,I)
Terbutaline	(I)	Vit D ₃ (ergocalciferol)	(W,I)
Testosterone propionate	(W,I)	W	
Tetanus toxoid	(W,I)	Warfarin	(W,I)
Tetracaine	(W,I)	X	
Tetracycline	(W,I)	Xylometazoline	(I)
Theophylline compounds	(I)	Z	
Thiamine	(W,I)	Zidovudine	(W,I)
Thiacetazone + Isoniazid	(I)	Zidovudine + lamivudine + nevirapine	(W)
Thiopental Sodium	(W,I)	Zinc oxide	(I)
Timolol	(W,I)	Zinc sulfate	(W)
Tinidazole	(I)		
Triclabendazole	(W)		
Trifluoperazine	(I)		
Trihexyphenidyl	(I)		
Trimethoprim	(W,I)		
Tropicamide	(W,I)		



Appendix - 2

Prescribing in Pregnancy

There are major concerns of permanent harm to the baby whenever any drug is administered to pregnant women. Maternal medication can also increase the incidence of abortion, foetal death, premature/delayed labour or create perinatal problems. Moreover, there are pronounced and progressive physiological changes during pregnancy which can affect drug disposition (*see* p. 63). As such, prescribing for the pregnant woman requires a lot of skill and restraint. Possible harm to the foetus by the administered drug has to be weighed against harm to both mother and the baby due to untreated disease. There is paucity of data about safety of majority of drugs during pregnancy; largely because prospective drug trials in pregnant women are fraught with ethical, legal, emotional and practical difficulties. Information is mostly derived from anecdotal reports and retrospective studies.

Principles of prescribing during pregnancy

- Where possible use nondrug therapy.
- Prescribe drugs only when definitely needed.
- Choose the drug having the best safety record over time.
- Avoid newer drugs, unless safety is clearly established.
- Over-the-counter drugs cannot be assumed to be safe.
- As far as possible, avoid medication in the initial 10 weeks of gestation.
- Use the lowest effective dose.
- Use drugs for the shortest period necessary.
- If possible, give drugs intermittently.

While insufficient data are available to make definitive recommendations regarding choice of drugs for treating common problems likely to be encountered during pregnancy, the table below attempts to delineate the relatively/probably safer alternatives. The list is not exhaustive and manufacturers literature/package inserts or other authoritative texts should be consulted. Drugs marked (X) are contraindicated during pregnancy.

Choice of drugs for common problems during pregnancy

<i>Drug class (condition)</i>	<i>Safety uncertain/unsafe</i>	<i>Safer alternative</i>	
1. Antiemetics (morning sickness, other types of vomiting)	Domperidone (X) Ondansetron	Promethazine, Cyclizine Dicyclomine, Prochlorperazine Metoclopramide, Doxylamine	
2. Drugs for peptic ulcer and GERD	Cimetidine, Omeprazole Pantoprazole, Lansoprazole (X) Cisapride (X), Mosapride	Ranitidine Famotidine	
3. Laxatives (constipation)	Senna, Bisacodyl, Docusates Saline purgatives	Dietary fibre, Ispaghula Lactulose	
4. Antidiarrhoeals	Diphenoxylate-atropine, Loperamide	Oral rehydration salts	
5. Analgesics (headache, bodyache, joint pain, visceral pain)	Aspirin, Metamizol, NSAIDs COX-2 inhibitors, Codeine Dextropropoxyphene, Morphine (X) Pethidine, Tramadol	Paracetamol Ibuprofen (low dose)	
6. Cold-cough remedies	Codeine, Dextromethorphan Bromhexine, Expectorants	Xylometazoline Oxymetazoline Budesonide Cromoglycate	} Nasal drops
7. Antiallergics	Cetirizine, Loratadine Fexofenadine, Astemizole (X)	Chlorpheniramine Promethazine	
8. Antibacterials (systemic bacterial infections)	Cotrimoxazole, Fluoroquinolones (X), Tetracycline (X), Doxycycline (X), Chloramphenicol (X), Gentamicin, Streptomycin (X), Kanamycin (X), Tobramycin (X), Clarithromycin, Azithromycin, Clindamycin, Vancomycin, Nitrofurantoin	Penicillin G, Ampicillin Amoxicillin-Clavulanate Cloxacillin, Piperacillin Cephalosporins Erythromycin	
9. Antitubercular	Pyrazinamide, Ethambutol Streptomycin (X)	Isoniazid Rifampicin	
10. Antiamoebic	Metronidazole, Tinidazole (X) Quiniodochlor	Diloxanide furoate	
11. Antimalarial	Quinine (X), Mefloquine Pyrimethamine + sulfadoxine (X) Artemether, Artesunate Primaquine (X)	Chloroquine Proguanil	
12. Anthelmintic	Albendazole (X), Mebendazole (X) Ivermectin, Pyrantel pamoate Praziquantel, Diethylcarbamazine (X)	Piperazine Niclosamide	

Contd.

<i>Drug class (condition)</i>	<i>Safety uncertain/unsafe</i>	<i>Safer alternative</i>
13. Antifungal (superficial and deep mycosis)	Amphotericin B (X), Fluconazole Itraconazole (X), Ketoconazole (X) Griseofulvin (X), Terbinafine	Clotrimazole Nystatin Tolnaftate } Topical
14. Antiretroviral (HIV-AIDS)	Didanosine, Abacavir, Indinavir Ritonavir, Efavirenz	Zidovudine, Lamivudine, Nevirapine, Nelfinavir, Saquinavir
15. Antiviral (other than HIV)	Acyclovir, Ganciclovir (X) Foscarnet (X), Amantadine (X) Vidarabine (X), α -interferon (X)	—
16. Antihypertensives	ACE inhibitors (X), Angiotensin antagonists (X), Thiazide diuretics Furosemide, Propranolol Nitroprusside	Methyldopa, Hydralazine, Atenolol Metoprolol, Pindolol, Nifedipine Prazosin, Clonidine
17. Antianaemic	—	Iron salts (oral), Iron dextran (i.m.) Folic acid, Vit B ₁₂
18. Antidiabetics	Sulfonylureas (X), Metformin (X) Pioglitazone, Rosiglitazone Repaglinide, Nateglinide Acarbose (X)	Insulin (preferably human insulin)
19. Corticosteroids	Betamethasone, Dexamethasone (high dose and prolonged use)	Inhaled corticosteroids Topical corticosteroids Prednisolone oral (low dose)
20. Thyroid hormone	—	Thyroxine
21. Antithyroid drugs (thyrotoxicosis)	Carbimazole, Radioactive iodine (X) Iodide	Propylthiouracil
22. Antipsychotic (schizophrenia)	Chlorpromazine, Fluphenazine (X) Clozapine, Olanzapine, Risperidone	Haloperidol Trifluoperazine
23. Antimanic (bipolar illness)	Lithium carbonate, Valproate Carbamazepine	—
24. Antidepressants	Trimipramine (X), Dothiepin (X) Sertraline, Paroxetine, Citalopram Trazodone, Venlafaxine Moclobemide	Amitriptyline, Imipramine Clomipramine, Fluoxetine
25. Anticoagulants (thromboembolism)	Warfarin (X), Acenocoumarol Phenindione (X)	Heparin (unfractionated) Heparin (LMW)
26. Asthmatic	Theophylline, Ketotifen (X) Montelukast, Zafirlukast Systemic corticosteroids	Salbutamol/Salmeterol Ipratropium bromide Beclomethasone/ Budesonide Sod. cromoglycate } Inhaled



Appendix - 3

Drugs in Breastfeeding

Administration of drugs to women who are breastfeeding may have ill effects on the suckling infant, and/or affect lactation. Toxic effects on the infant are largely dependent on entry of the drug in milk in pharmacologically significant amounts. Currently available data are insufficient to make specific recommendations in the case of many drugs and the list given below is not exhaustive. Manufacturer's recommendations/package inserts should be consulted.

A. Drugs whose amount in milk is too small to be harmful to the infant, or those found to be safe in ordinary doses

Acetazolamide	Insulins
Albendazole	Ipratropium Br. (inhalation)
Antacids	Iron dextran (i.m.)
Antifungal drugs (topical)	Iron salts (oral)
Aspirin (low dose)	Ketoprofen
Baclofen	Lidocaine
Beclomethasone (Inhaled)	Loperamide
Benzyl benzoate (topical)	Mebendazole
Bupivacaine	Methyldopa
Buprenorphine	Mexiletine
Cephalosporins	Naproxen
Cisapride	Nefopam
Cloxacillin	Niclosamide
Codeine	Paracetamol
Cromoglycate sod.	Permethrin (topical)
Dextropropoxyphene	Piperacillin
Diclofenac	Piperazine
Digoxin	Piroxicam
Domperidone	Praziquantel
Ergometrine	Pyrantel
Erythromycin	Pyrazinamide
Ethambutol	Salbutamol
Folic acid	Sucralfate
Gentamicin	Terbutaline
Heparin	Valproate sod.
Hydralazine	Vitamins (maintenance dose)
Ibuprofen	Warfarin

B. Drugs to be used with special precaution in breastfeeding women or drugs contraindicated

<i>Drug</i>	<i>Comment / possible adverse effect on breast-fed infant</i>
ACE inhibitors (Enalapril, Lisinopril)	: S/P amount in milk small, magnitude of risk not known, watch for hypotension
Acenocumarol	: S/P; give prophylactic vit K to infant
Acyclovir	: S/P; significant amount in milk
Alcohol	: Intoxication, reduced suckling
Allopurinol	: S/P; secreted in milk; no data on risk to infant
Amiloride	: C/I; no information on risk to infant; may reduce lactation
Aminoglycosides	: S/P; risk not known, most manufacturers advise caution
Amiodarone	: C/I; risk of hypothyroidism from released iodine
Amlodipine	: S/P; no data on risk to infant
Amphetamines	: C/I; significant amount in milk
Ampicillin/Amoxicillin	: S/P; diarrhoea, candidiasis
Androgens	: C/I; masculinization of female infant, precocious development of male infant, reduced lactation
Anthraquinones (senna, etc.)	: C/I; diarrhoea
Anticancer drugs	: C/I; anaemia, diarrhoea, immunosuppression
Anticonvulsants	: S/P; monitor infant for side effects
Antidepressants (tricyclic)	: S/P; use doses < 150 mg amitriptyline or equivalent; monitor infant for side effects, sedation, respiratory depression
Antihistamines (H ₁)	: S/P; significant amount in milk, watch for drowsiness
Antihistamines (2nd generation)	: No data on risk to infant; manufacturers advise avoid
Antipsychotics	: S/P; drowsiness, muscle dystonia; avoid chlorpromazine, haloperidol, clozapine; amount in milk small, but long-term effect on developing nervous system not known
Aspirin	: S/P; Avoid high doses, bleeding, Reye's syndrome
Atorvastatin	: Avoid; no data on risk to infant
Atropine	: S/P; monitor for anti-muscarinic effects
Azathioprine	: C/I; immunosuppression
Azithromycin	: Avoid; no information on risk to infant
Barbiturates	: S/P; drowsiness, lethargy, withdrawal symptoms
Benzodiazepines	: S/P; compatible in single dose; avoid repeated doses; lethargy, hypotonia, reduced suckling, weight loss
Beta blockers	: S/P; amount in milk generally small; bradycardia, hypotension, cyanosis
Bromocriptine	: Suppresses lactation
Buspirone	: Avoid; no information on risk to infant
Caffeine	: Avoid regular consumption of large amounts; irritability, CNS effects
Carbamazepine	: S/P; amount in milk small but monitor infant
Carbimazole	: S/P; hypothyroidism, use lowest effective dose, or suspend breastfeeding
Carisoprodol	: S/P; concentrated in milk; avoid
Chloral hydrate	: C/I; sedation
Chloramphenicol	: C/I; diarrhoea, bone marrow depression, gray baby syndrome (unlikely)

C/I=Contraindicated or suspend breastfeeding

S/P = Use with special precaution while breastfeeding and monitor infant

Contd.

<i>Drug</i>	<i>Comment / possible adverse effect on breast-fed infant</i>
Chloroquine	: S/P; amount in milk small; haemolysis in < 1 month old infant and in G-6-PD deficient
Cimetidine	: S/P; significant amount in milk, but no harmful effect reported
Ciprofloxacin	: C/I; high concentration in milk, theoretical risk of arthropathy
Clindamycin	: S/P; amount in milk small, but risk of diarrhoea, watch for blood in stools
Clofazimine	: S/P; skin discolouration
Clonidine	: S/P; sedation, hypotension
Corticosteroids	: S/P; compatible in single doses; pituitary-adrenal suppression possible with >10 mg prednisolone daily to mother, impaired growth
Cotrimoxazole	: S/P; folate deficiency, risk of kernicterus, haemolysis in G-6-PD deficient; safe for healthy older infants
Cyclosporine	: C/I; significant amount in milk
Dapsone	: S/P; haemolytic anaemia, jaundice
Depot medroxyprogesteron acetate (i.m.)	: Compatible with breastfeeding from 6 weeks postpartum
Diltiazem	: S/P; significant amount in milk
Disopyramide	: S/P; small amount in milk, antimuscarinic effects
Doxepin	: S/P; sedation, respiratory depression
Ephedrine	: S/P; irritability, sleep disturbance
Ergotamine	: C/I; ergotism, may suppress lactation
Estrogens	: C/I; gynaecomastia in male infant, may suppress lactation
Ethosuccimide	: C/I; hyperexcitability, poor suckling
Famotidine	: S/P; present in milk, but harm to infant not known
Fluconazole	: C/I; secreted in milk, but harm to infant not known
Fluoxetine	: S/P; small amount in milk, but can accumulate in infant; avoid if possible
Furosemide	: S/P; small amount in milk, electrolyte disturbances
Gemfibrozil	: Avoid; no information on risk to infant
Gold salts	: C/I; rashes and other reactions
Indomethacin	: C/I; CNS effects, convulsions
Iodine/Iodides	: C/I; concentrated in milk, hypothyroidism and goiter
Iodine radioactive	: C/I; suspend breastfeeding for 24 hr after diagnostic dose and for long-term after therapeutic dose
Isoniazid	: S/P; neuropathy, convulsions, jaundice, give prophylactic pyridoxine
Itraconazole	: Avoid unless essential; amount in milk small
Ketoconazole	: C/I; secreted in milk but harm to infant not known.
Ketorolac	: Avoid as no data on safety
Lansoprazole	: Avoid unless essential; no data on safety
Levodopa/Carbidopa	: S/P; no data on safety
Lithium carbonate	: C/I; intoxication, cardiac arrhythmias
Losartan	: S/P; magnitude of risk not known; avoid if possible
Mefloquine	: S/P; secreted in milk, but harm to infant unlikely
Metformin	: C/I; secreted in milk; hypoglycaemia, lactic acidosis
Mesalazine	: S/P; amount in milk small; watch for diarrhoea
Methotrexate	: C/I; toxicity in infant
Metoclopramide	: S/P; watch for diarrhoea, dystonia in infant

Contd.

<i>Drug</i>	<i>Comment / possible adverse effect on breast-fed infant</i>
Metronidazole	: Significant amount in milk: avoid high doses; suspend breastfeeding for 12 hr after single dose
Montelukast	: Avoid; no data on risk to infant
Morphine (and other opioids)	: S/P; usual doses unlikely to affect infant; lethargy, poor growth, withdrawal symptoms in infants of dependent mothers
Nalidixic acid	: S/P; small risk of haemolytic anaemia; avoid if possible
Neostigmine	: S/P; small amount in milk but monitor infant
Nifedipine	: S/P; small amount in milk but monitor infant
Nitrofurantoin	: S/P; small amount in milk, haemolysis in G-6-PD deficient infant
Norfloxacin	: Avoid; no information on risk to infant
Omeprazole	: Avoid unless essential; no data on safety
Oral contraceptives	: Avoid until 6 month after birth, <i>see</i> estrogens
Penicillins	: Toxicity unlikely but risk of allergy
Phenolphthalein	: C/I; diarrhoea, rashes
Phenytoin	: S/P; small amount in milk, but monitor infant
Progestins	: Low doses safe, may suppress lactation at high doses
Propylthiouracil	: S/P; hypothyroidism with high doses only
Pyrimethamine-sulfadoxine	: S/P; significant amount in milk; appears safe if infant is older
Quinidine	: S/P; significant amount in milk but harm to infant not known
Ranitidine	: S/P; significant amount in milk but harm to infant not known
Rifampin	: S/P; amount in milk small, but monitor infant for jaundice
Sertraline	: S/P; present in milk but no harm reported in short-term
Spirolactone	: S/P; drowsiness, hirsutism, gynaecomastia
Streptomycin	: Compatible with breastfeeding; monitor infant for diarrhoea and thrush
Sulfonamides	: S/P; rashes, small risk of kernicterus in neonate, haemolysis in G-6-PD deficient; safer for older infants
Sulfonylureas	: S/P; no adverse effect reported, but watch for hypoglycaemia
Tetracyclines	: C/I; growth retardation, candidiasis, tooth discolouration
Theophylline	: S/P; irritability, CNS effects
Thiazide diuretics	: S/P; amount in milk small; may reduce lactation
Thyroxine	: S/P; monitor for hyperthyroidism
Tinidazole	: S/P; present in milk; suspend breastfeeding till 3 days after stopping
Vancomycin	: S/P; present in milk, but absorption from infant's gut unlikely
Verapamil	: S/P; small amount in milk, but monitor infant
Vigabatrin	: C/I; present in milk, no data on risk to infant
Vitamin A and D	: Avoid high doses, risk of hypervitaminosis
Zolpidem	: Avoid unless essential; amount in milk small, but watch for sedation in infant



Appendix - 4

Drugs and Fixed Dose Combinations Banned in India

(updated till Aug 2007)

A. Single drug preparations (or combinations of)

1. Amidopyrine.
2. Phenacetin.
3. Nialamide.
4. Methaqualone.
5. Methapyriline (and its salts).
6. Practolol.
7. Penicillin skin/eye ointment.
8. Tetracycline/Oxytetracycline/Demeclocycline liquid oral preparations.
9. Chloral hydrate.
10. Dover's powder and Dover's powder tablets I.P.
11. Chloroform exceeding 0.5% w/w or v/v in pharmaceutical preparations.
12. Mepacrine HCl (Quinacrine and its salts) in any dosage form for use for female sterilization or contraception.
13. Fenfluramine
14. Dexfenfluramine
15. Terfenadine
16. Astemizole
17. Phenformin
18. Rofecoxib
19. Valdecocixib

B. Fixed dose combination with any other drug

1. Corticosteroids with any other drug for internal use.
2. Chloramphenicol with any other drug for internal use.
3. Sodium bromide/chloral hydrate with other drugs.
4. Ergot with any drug except preparations containing ergotamine, caffeine, analgesics, antihistamines for treatment of migraine.
5. Anabolic steroids with other drugs.

6. Metoclopramide with other drugs (except with aspirin/paracetamol).
7. Pectin and/or kaolin with any drug which is systemically absorbed from g.i. tract, except for combination of pectin and/or kaolin with drugs not systemically absorbed.
8. Hydroxyquinolines with any other drug except in preparations for external use.
9. Oxyphenbutazone or phenylbutazone with any other drug.
10. Dextropropoxyphene with any other drug except antispasmodics and/or NSAIDs.
11. Analgin (metamizol) with any other drug.

C. Fixed dose drug combinations of

1. Penicillins with Sulfonamides.
2. Tetracyclines with vitamin C.
3. Antitubercular drugs with Vitamins (except Isoniazid with Pyridoxine HCl).
4. Vitamins with Analgesics/Anti-inflammatory drugs.
5. Vitamins with Tranquillisers.
6. Atropine and Analgesic-antipyretics.
7. Yohimbine and Strychnine with Testosterone and Vitamins.
8. Strychnine and Caffeine in tonics.
9. Iron with Strychnine, Arsenic and Yohimbine.
10. Antihistaminics with Antidiarrhoeals.
11. More than one Antihistamine in the same preparation.
12. Sedatives/Hypnotics/Anxiolytics with Analgesic-antipyretics.
13. H₂ receptor antagonists with Antacids (except those combinations approved by Drugs Controller, India).
14. Anthelmintics (except Piperazine) with a Cathartic/Purgative.
15. Salbutamol (or any other bronchodilator) with centrally acting Antitussive and/ or an Antihistamine.

16. Centrally acting Antitussives with Antihistamines having atropine like activity in expectorants.
17. Centrally acting Antitussive and/or Antihistamine in preparations for cough associated with asthma.
18. Laxatives and/or antispasmodic drugs in enzyme preparations.
19. Glycerophosphates and/or other phosphates, and/or CNS stimulant in liquid oral tonics.
20. Estrogen and Progestin (other than oral contraceptives) containing per tablet estrogen more than 50 µg ethinylestradiol (or equivalent) and progestin more than 3 mg of norethisterone acetate (or equivalent), and all fixed dose combination injectable preparations containing synthetic estrogen and progesterone.
21. Ethambutol with Isoniazid, except in the following daily doses:
Isoniazid 200 mg + Ethambutol 600 mg or
Isoniazid 300 mg + Ethambutol 800 mg.
22. Pyrazinamide with other antitubercular drugs, except that which provide the following daily doses:

Rifampicin	450 to 600 mg
Isoniazid	300 to 400 mg
Pyrazinamide	1000 to 1500 mg
23. Essential oils with Alcohol having percentage higher than 20% proof (except preparations given in the I.P.).
24. Liquid oral tonic preparations containing alcohol more than 20% proof.
25. Streptomycin with penicillin in parenteral preparation.
26. Antidiarrhoeals containing adsorbants like kalolin, pectin, attapulgate, activated charcoal etc.
27. Antidiarrhoeals containing phthalylsulfathiazole, succinyl sulfathiazole, sulfaguanidine, neomycin, streptomycin, dihydrostreptomycin.
28. Antidiarrhoeal formulations for pediatric use containing diphenoxylate, loperamide, atropine, hyoscyamine, halogenated hydroxyquinolines.
29. Antidiarrhoeals with electrolytes.
30. Fixed dose combinations of haemoglobin in any form.
31. Pancreatine or pancrelipase containing amylase, protease and lipase with any other enzyme.
32. Oral rehydration salts other than those conforming to the following parameters:
 - (a) Oral rehydration salts on reconstitution to one litre shall contain: sodium—50 to 90 mM; total osmolarity—240 to 290 mOsm; dextrose: sodium molar ratio—not less than 1:1 and not more than 3:1.
 - (b) Cereal based ORS on reconstitution to one litre shall contain: total osmolarity not more than 2900 mOsm. Precooked rice equivalent to not less than 50 g and not more than 80 g as total replacement of dextrose.
 - (c) ORS may contain amino acids in addition to ORS conforming to the parameters specified above and labelled with the indication for “Adult Cholera Diarrhoea” only.
 - (d) ORS shall not contain mono or polysaccharides or saccharin sweetening agent.
33. A drug, standards of which are prescribed in the 2nd schedule to Drugs and Cosmetics Act with an Ayurvedic, Siddha or Unani drug.
34. Vitamin B₁, vit B₆, and vit B₁₂ for human use.
35. Diazepam with diphenhydramine HCl.
36. Nitrofurantoin with trimethoprim.
37. Phenobarbitone with any antispasmodic drug, or with hyoscine and/or hyoscyamine, or ergotamine and/or belladonna.
38. Haloperidol with any anticholinergic agent including propantheline Br.
39. Nalidixic acid with any antiamebic including metronidazole.
40. Loperamide with furazolidone.
41. Cyproheptadine with lysine or peptone.

Index

A

- Abacavir, 767, 772, 775, 776
ABC (ATP-binding cassette) transporters, 14-15
Abciximab, 610, 611
Abortion: drugs for, 180-81, 322-23
Absorbants, 661, 662
Absorption of drugs, 15-18
Acamprostate, 385
Acarbose, 266, 270
Acebutolol, 136, 137, 140, 141
Aceclofenac, 184, 194
Acenocoumarol, 596, 601-02
Acetaminophen. *See* Paracetamol
Acetazolamide, 147, 561, 568-69, 573
Acetic acid, 848, 862
Acetomenaphthone, 594, 595
Acetylation, 25, 740
Acetylcholine (ACh), 93-98
Acetylcholinesterase (AChE), 93, 94, 95, 100
Acetylsalicylic acid. *See* Aspirin
Acid neutralizing capacity (ANC), 634
Acitretin, 851
Acne vulgaris: drugs for, 715, 852-54
Acriflavine, 862
Acromegaly, 234, 236
ACTH (Adrenocorticotrophic hormone), 240-41, 275, 276
Actinomycin D, 821, 826, 830, 832
Action potential (AP)
 effect of digitalis on, 495
 fast channel; slow channel, 477
 in heart, 476
 in nerve, 352
Activation of drugs, 23, 24
Active transport of drugs, 14-15
Acute coronary syndromes, 191, 526-27, 528
Acute left ventricular failure, 461-62, 504, 527, 554, 562, 563
Acyclovir, 737, 767-69
Adalimumab, 203, 205
Adapalene, 853
Addiction: to drugs, 84
Addison's disease, 283
Adefovir dipivoxil, 767, 778
Adenosine, 511, 518, 519
Adenylyl cyclase: cAMP pathway, 46, 47, 48, 124
Adrenaline (Adr), 82, 116-25, 146, 518
Adrenergic
 blockers, 132-44, 145, 146
 drugs, 120-31, 323
 neurone blockers, 121, 132, 133, 549
 receptors, 118-20, 121, 122, 124-25
 transmission, 116-20
Adrenochrome monosemicarbazone, 594, 596
Adriamycin. *See* Doxorubicin
Adult treatment panel III (ATP III), 619, 620
Adverse drug effects, 78-86
Adverse drug event (ADE), 78
Adverse drug reaction (ADR), 78
Aeromatic chest rub, 215
Affinity, 42
Agonist, 41, 42
AIDS: drugs for. *See* Antiretrovirus drugs
Akathisia, 431
Albendazole, 809, 810-11, 815, 816
Albumin (human), 622
Alcohol
 drinking: motivation for, 384-85
 drinking: safe guidelines, 384
 ethyl, 380-86, 387, 395, 847, 861
 methyl, 386-87
Alcoholic beverages, 380
Alcoholism, 384-85, 591
Aldehyde dehydrogenase inhibitors, 386
Aldosterone, 276, 277, 282
 antagonist, 506, 569-70, also *see* Spironolactone
Aldosterone induced protein (AIP), 277, 569, 570
Alendronate, 333, 334, 335
Alfa adrenergic blockers, 132-36, 545
Alfacalcidol, 332, 333
Alfa glucosidase inhibitors, 266, 268, 270
5-Alfa reductase inhibitors, 294-95
Alkylating agents, 821-22
Allergy (hypersensitivity) to drugs, 81-83, 160, 697-98
Allopurinol, 205, 208-10, 807
Allylestrenol, 307, 309
Aloe vera gel, 846
Alopecia: drugs for, 294, 548
Alprazolam, 389, 396, 450-51
Alprostadil, 182, 296
Alteplase (rt-PA), 606, 607
Alum, 846
Aluminium hydroxide, 635
Alzheimer's disease: drugs for, 104, 471-73
Amantadine, 415, 421, 422, 777
Ambroxol, 213, 214
Amethocaine. *See* Tetracaine
Amikacin (Am), 721, 724, also *see* Aminoglycoside antibiotics
Amiloride, 540, 542, 561, 571, 572, 573, 574, 578

- Amineptine, 439, 447
- Aminoglycoside antibiotics, 719-26
 - common properties, 719
 - mechanism of action, 711, 719-20
 - shared toxicities, 720-22
- Aminopenicillins, 700-01
- Aminophylline, 221, 227, also *see* Theophylline
- 5-Aminosalicylic acid (5-ASA). *See* Mesalazine
- Amiodarone, 511, 515-16, 519
- Amitriptyline, 172, 439, 442, also *see* Tricyclic antidepressants
- Amlodipine, 522, 531, 532, 543, 553
- Ammonium chloride, 213
- Amodiaquine, 781, 783, 786-87, 795, 796
- Amoebiasis: treatment of, 799, 800, 801, 802, 803
- Amoxapine, 439, 442, 445
- Amoxicillin, 637, 638, 681, 699, 701, 703, 736, 737
- Amphetamine, 125, 126-27, 130, 470
- Amphotericin B (AMB), 757-60, 764, 806
 - new formulations, 758-59
- Ampicillin, 661, 681, 699, 700-01, 703, 736, 737, 738
- Amrinone, 507
- Anabolic steroids, 292-93
- Anaemia: drugs for, 581, 586-87, 589, 591, 592
- Anaesthesia: general, 365
 - complications of, 377-78
 - local *vs* general, 351
 - mechanism of, 365-66
 - pharmacokinetics of : inhalational, 368-69
 - stages of, 367-68
 - techniques of: inhalational, 369-70
 - techniques of: local, 358-61
- Anakinra, 203, 205
- Analeptics, 469, 470
- Analgesic: definition, 453
 - combinations, 201
 - nonopioid, 184-201
 - opioid, 453-62
- Analgesic nephropathy, 198
- Anandamide, 175, 438
- Anaphylactic reaction, 82, 697
- Anaphylactic shock: treatment of, 82, 284
- Anastrozole, 305, 306
- Ancrod, 597, 600
- Androgens, 288-92
 - transdermal, 291
- Androsterone, 288
- Angina pectoris, 521, 526, 528, 532-33, 535
- Angiotensin (A-II), 479-82
 - antagonists, 488-90, 504, 505, 538, 540, 542-43, 551, 552, 553
 - converting enzyme (ACE) inhibitors, 483-87, 503, 504, 505, 538, 540, 542, 551, 552, 553
 - receptor blockers (ARBs). *See* Angiotensin antagonists
- Anorectic drugs, 125, 128-29, 130
- Antacid, 634-36, 648
 - combinations, 635
 - in peptic ulcer, 636
- Antagonism, 56-58
 - among antimicrobials, 677
- Antagonist: competitive, 42, 56-58
 - non competitive, 57, 58
- Anterior pituitary hormones, 231, 233-41
- Anthelmintic drugs, 808-16
- Anthraquinone purgatives, 654
- Anti *H. pylori* drugs, 637-38
- Antiamoebic drugs, 797-803
- Antiandrogens, 293-94
- Antianginal drugs, 521-36
- Antianxiety drugs, 424, 449-52
- Antiarrhythmic drugs, 510-20
 - choice of, 519
- Antibiotic : definition, 667
 - sources of, 669
- Anticancer: drugs, 819-29
 - antibiotics, 826-27
 - choice of, 832
 - general principles in use of, 829-34
 - general toxicity, 820-21
- Anticholinergic drugs, 106-14, 222, 421, 422
- Anticholinesterases, 99-105
 - poisoning, 104-05
- Anticoagulants, 597-605
- Anticonvulsants. *See* Antiepileptic drugs
- Antidepressants, 424, 439-49
 - atypical, 439, 442, 447-48
- Antidiarrhoeal drugs, 660-64
- Anti-D immunoglobulin, 842
- Antidiuretics, 574-78
- Antidiuretic hormone (ADH), 319, 559, 574-77
- Antiemetics, 433, 641-47
- Antiepileptic drugs, 402-13
- Antiestrogens, 303-04
- Antifibrinolytics, 608
- Antifungal drugs, 756-66
- Antihaemophilic factor, 594, 596
- Antihistamines
 - H₁ blockers, 153, 155-61, 215
 - H₂ blockers, 153, 162, 379, 629-31, 648
 - H₃ blockers, 153, 162
 - second generation, 156, 158-59
- Antihypertensive drugs, 539-54
 - combinations of, 552-53
 - in pregnancy, 553, 910
- Antileptotic drugs, 751-56
- Antimalarial drugs, 780-96
 - causal prophylactics, 782
 - clinical curatives, 783-84
 - for chloroquine resistant falciparum malaria, 783, 788, 789, 791, 793, 794-96

- gametocidal, 784-85
 radical curative, 784
 suppressive prophylactics, 782-83
- Antimanic drugs, 424, 434-37
- Antimetabolites, 823-24
- Antimicrobial agent (AMA): definition, 667
 choice of, 673-76
 combinations, 676-78
 failure of, 681
 in liver disease, 673, 674
 in pregnancy, 674, 909
 in renal failure, 673
 mechanisms of action, 668-69
 prophylactic use of, 678-81
 resistance to, 670-72
- Antimotility drugs, 663-64
- Antineoplastic. *See* Anticancer
- Antioxidant vitamins, 872-73
- Antiparkinsonian drugs, 106, 414-22
- Antiplatelet drugs, 608-11
- Antiprogesterin, 310-11
- Antipsychotic drugs, 424-33
- Antipyretic-analgesics, 184-201
- Anti-retrovirus (ARV) drugs, 767, 770-77
- Antiseborrheics, 849
- Antisense oligonucleotide, 844
- Antiseptics, 857-62
 definition, 857
 mechanism of action of, 858
 potency of, 858
 properties of ideal, 857
 therapeutic index of, 858
- Antisera, 886-88
 diphtheria antitoxin (ADS), 887
 gasgangrene antitoxin (AGS), 887
 rabies (ARS), 887
 snake venom polyvalent, 887-88
 tetanus antitoxin (ATS), 887
- Antithrombotic. *See* Antiplatelet drugs
- Antithymocyte globulin (ATG), 842
- Antithyroid drugs, 249-51
- Antitubercular drugs, 739-50
- Antitussives, 214-15
- Antiviral drugs, 767-79
- Anxiety, 424, 449
 drugs for 446, 448, 449-52
- Apomorphine, 639, 640
- Apraclonidine, 146, 148
- Aprotinin, 608
- Ardeparin, 600
- Arecoline, 97, 99
- Aripiprazole, 425, 427, 430, 433, 437
- Aromatase inhibitors, 305-06
- Arteether, 781, 784, 793
- Artemether, 781, 783, 784, 793, 795
- Artemisinin, 782, 783, 793-96
- Artemisinin-based combination therapy (ACT), 783, 784, 794-96
- Arterolane, 795, 796
- Artesunate, 781, 783, 784, 793, 794, 795, 796
- Ascariasis: drugs for, 809-13
- Ascorbic acid, 874, 878
- Aspirin, 184, 187-91, 527, 537, 607, 609, 610, 611
- Astemizole, 158
- Asthma
 bronchial, 216, 226-27
 cardiac, 461, also *see* Acute left ventricular failure
- Astringents, 846-47
- Atenolol, 136, 137, 140, 141, 528, 544
- Atorvastatin, 614, 615, also *see* Statins
- Atosiban, 323-24
- Atovaquone, 781, 794
- Atracurium, 339, 343, 345
- Atrial fibrillation (AF), 502, 509, 510, 519, 605
- Atrial flutter (Afl), 502, 510, 519
- Atrial natriuretic peptide (ANP), 560
- Atropine, 94, 104-05, 106-14, 379, 518
- Atropine methonitrate, 106, 109
- Attention deficit disorder, 130, 448-49, 470
- Atypical antidepressants, 439, 442, 447-48
- Atypical antipsychotics, 425, 427, 429-30, 433, 437
- Auranofin, 202, 204
- Autacoids: definition, 150
- Autonomic influences on heart, 478
- Autoreceptors, 91, 117
- A-V block, 130, 499, 510, 511, 518-19
- AVP (Arginine-vasopressin), 574-76, 577
- Azathioprine, 202, 203, 663, 823, 824, 840, 842
- Azelastine, 156, 159
- Azithromycin, 681, 730-31, 737, 740, 744, 750
- Azleic acid, 852, 853-54
- AZT (Azidothymidine). *See* Zidovudine
- Aztreonam, 708

B

- Bacampicillin, 701
- Bacitracin, 734
- Baclofen, 348, 349
- Bactericidal AMAs, 669
- Bacteriological sensitivity testing, 675
- Bacteriostatic AMAs, 669
- BAL. *See* Dimercaprol
- Balsalazine, 663
- Bambuterol, 217, 218
- BAN (British approved name), 4
- Banned drugs, 915-16
- Barbiturates, 366, 374, 389, 390-92, 402, 403
- Barbiturate poisoning, 392
- Beclomethasone dipropionate, 217, 225, 854
- Belladonna poisoning, 104, 113-14
- Benazepril, 485
- Benidipine, 522, 532

- Benign hypertrophy of prostate (BHP): drugs for, 136, 294
 Benoxinate, 351, 358, 359
 Benserazide, 415, 418, 419
 Bentonite, 846
 Benzalkonium chloride, 861
 Benzathine penicillin, 697, 698, 699, 737
 Benzhexol. *See* Trihexyphenidyl
 Benzocaine, 351, 358, 359
 Benzodiazepines (BZDs), 366, 370, 375-76, 385, 389, 393-97, 398, 399, 402, 408-09, 449-52, 647
 antagonist, 394, 395, 399-400
 Benzoic acid, 757, 766
 Benzothiadiazines. *See* Thiazides
 Benzoyl peroxide, 852-53, 859
 Benzthiazide, 561, 566, 571
 Benzyl benzoate, 863-64
 Beta adrenergic blockers, 136-44, 172, 253, 451, 503, 505-06, 522, 527-28, 533-34, 537, 544, 551, 552, 553
 ocular, 144-45
 Beta-lactam antibiotics, 694-709
 Beta-lactamase, 696, 702
 inhibitors, 702-03
 Betahistine, 155, 160
 Betamethasone, 281, 282, also *see* Corticosteroids
 benzoate, 854
 valarate, 854
 Betaxolol, 145, also *see* Beta blockers: ocular
 Bethanechol, 97, 98
 Bezafibrate, 614, 617, also *see* Fibric acid derivatives
 Bhang, 438
 Bicalutamide, 294, 828
 Bicuculline, 395, 469
 Biguanides, 266, 267, 268, 269, 272
 Bile acid sequestrants. (Resins), 614, 616
 Bioavailability, 17-18
 Biologic response modifiers (BRMs), 202, 204-05
 Biological membrane, 11-12
 Biotin, 874, 876, 878
 Biotransformation, 23-29
 Biperiden, 106, 415, 422
 Bipolar disorder, 424, 436, 437, 439
 drugs for, 434-37
 Bird flu (avian-influenza): drugs for, 777-78
 Bisacodyl, 653, 656
 Bishydroxycoumarin, 597, 601
 Bismuth
 colloidal, 636-37
 subsalicylate, 663
 Bisoprolol, 136, 137, 140, 141
 Bisphosphonates, 333-35
 Bleaching powder, 860
 Bleomycin, 821, 826-27, 830, 832
 Blood-brain barrier, 19, 20
 Boric acid, 846, 861
 Botulinus toxin, 93
 Bradykinin, 490-92
 antagonists, 492
 Brain natriuretic peptide (BNP), 507
 Bran, 652
 Breast feeding and drugs, 29, 911-14
 Bretylum, 511, 516
 Brimonidine, 146
 Brinzolamide, 147
 Broad spectrum antibiotics, 669, 710-18
 Bromhexine, 213, 214
 Bromocriptine, 167, 168, 236-37, 415, 419, 422, 431
 Bronchial asthma: drugs for, 112, 216-27, 284
 drug therapy, 226-27
 Bronchodilators, 112, 215, 217-23
 Buclizine, 156
 Budesonide, 217, 225
 Buerger's disease. *See* Peripheral vascular disease
 Bufotenin, 438
 Bulaquine, 792
 Bumetanide, 503, 561, 563
 Bupivacaine, 351, 352, 353, 355, 356, 357, 360, 361
 Buprenorphine, 463, 464, 465-66
 Bupropion, 439, 442, 448
 Buspirone, 163, 164, 449, 451, 452
 Busulfan, 821, 822, 830, 832
 Butamben, 351, 358, 359
 Butenafine, 757, 766
 Butorphanol, 463, 464, 465
 Butyrylcholinesterase (BuChE). *See* Pseudocholinesterase
- C**
- Cabergoline, 237
 Caffeine, 218, 219, 220, 471
 Calamine, 846
 Calciferol, 331-33, also *see* vit D
 Calcineurin inhibitors (T-cell inhibitors), 837-40
 Calcipotriol, 333, 850
 Calcitonin, 242, 329, 330
 Calcitriol, 329, 331-33
 Calcium, 325-27
 carbonate, 327, 635
 channel blockers, (CCBs), 323, 504, 522, 528-34, 540, 543-44, 551, 552
 channels, 528
 daily allowance, 327
 edetate (calcium EDTA), 865, 866-67
 gluconate, 326, 327
 lactate, 327
 Camphor, 847
 Cancer chemotherapy. *See* Anticancer drugs
 Candesartan, 488-89
 Candidiasis: drugs for, 759
 Cannabinoid receptors, 438
 Cannabinoids, 438, 647
 Cannabis, 438
 Canthridin, 848
 Capreomycin (Cpr), 744, 748
 Capsicum, 848

- Captopril, 483-84, 486-87
Captopril test, 487
Carbachol, 97, 98
Carbamazepine, 402, 404, 405-06, 411, 412, 437, 578, 816
Carbapenems, 708-09
Carbaryl, 99
Carbenicillin, 699, 702
Carbidopa, 415, 418, 419, 422
Carbimazole, 249, 250, 251
Carbocysteine, 213, 214
Carbolic acid. *See* Phenol
Carbonic anhydrase inhibitors, 146, 147, 561, 568-69, 573
 topical, 147
Carboplatin, 821, 828, 832
Carboprost (15-methyl PGF_{2α}), 181
Carcinogenicity, 76, 86
Carcinoid syndrome, 165, 166, 235
Cardiac arrhythmias, 508-10
 drugs for, 142, 510-20
Cardiac electrophysiology, 476-78
Cardiac glycosides, 493-502
Cardiotonic drugs, 493-502, also *see* Digitalis
Carisoprodol, 348
Carminatives, 649
Carrier transport, 13-15
Carvedilol, 136, 143-44, 545
Casara sagrada, 651, 654
Case-control study, 74
Castor oil, 651, 654
Catecholamines (CAs), 116-18, also *see* Individual drugs
Cathartics, 651, also *see* Laxatives
Caudal anaesthesia, 361
Caustics, 848
CCNU. *See* Lomustine
Cefaclor, 704, 705
Cefadroxil, 681, 704, 705
Cefazolin, 680, 681, 704, 708
Cefdinir, 704, 706
Cefepime, 704, 707
Cefixime, 704, 706
Cefoperazone, 704, 706, 707, 708
Cefotaxime, 704, 705, 708
Cefpirome, 704, 707
Cefpodoxime proxetil, 704, 706, 736
Ceftamet pivoxil, 704, 707
Ceftazidime, 704, 706, 708
Ceftibuten, 704, 706-07
Ceftizoxime, 681, 704, 706
Ceftriaxone, 704, 706, 707, 708, 737
Cefuroxime, 704, 705
Cefuroxime axetil, 704, 705
Celecoxib, 184, 197, also *see* COX-2 inhibitors
Celiprolol, 136, 137, 141
Cell cycle, 831
 nonspecific drugs, 830
 specific drugs, 830
Centchroman, 317
Cephalexin, 681, 704-05, 736
Cephalosporins, 703-08, 738
Cephalothin, 704
Cephradine, 704, 705
Cerebral malaria, 784, 789, 794
Cerebroactive drugs. *See* Cognition enhancers
Cervical priming, 181
Cervical ripening, 311
Cetirizine, 156, 158
Cetrimide, 860
Chancroid: drugs for, 686, 690, 708, 715, 729, 731, 737
Charas, 438
Charcoal activated, 81
Cheese reaction, 135, 440, 545, 554
Chelating agents, 865-68
Chemotherapy, also *see* Antimicrobial agents
 definition, 4, 667
 failure of, 681
 history of, 667-68
 of cancer, 819, 829-34
Chenodeoxy cholic acid (chenodiol), 649-50
Chickenpox: drug for, 769
Child dose calculation, 61-62
Chlamydia trachomatis urethritis, 715, 729, 731, 737
Chlophedianol, 215
Chloral hydrate, 389
Chlorambucil, 822, 830 832, 841
Chloramphenicol, 711, 715-18
 palmitate, 717
 succinate, 717
Chlordiazepoxide, 385, 389, 450
Chlorhexidine, 860
Chlorinated lime, 860
Chlorine, 860
Chlormezanone, 348
Chloroguanide. *See* Proguanil
Chlorophores, 860
Chloroprocaine, 351, 353
Chloroquine, 202, 203-04, 756, 781, 782, 783, 784, 785-87,
 852
Chloroxylenol, 859
Chlorpheniramine, 156, 157, 160, 215
Chlorproguanil, 781, 790, 795, 796
Chlorpromazine (CPZ), 379, 424, 425-28, 430-33
Chlorpropamide, 266, 268, 271, 578
Chlorthalidone, 540, 561, 565, 566
Chlorzoxazone, 348
Cholecalciferol, 330, 331, 332, also *see* Vit D
Cholera: drugs for, 661, 690, 715
 composition of stools in, 658
 vaccine, 881
Cholestyramine, 614, 616
Choline esters, 97, 98
Cholinergic
 crisis/weakness, 103-04
 drugs, 96-105
 transmission, 93-96

- Cholinesterase reactivators, 100, 105
 Cholinesterases, 93, 95, 99, 100
 Choline theophyllinate, 217, 221
 Cholinoceptors, 94-96
 Cholinomimetic alkaloids, 97, 98
 Choriongonadotropin (rHCG), 238
 Chorionic gonadotropin (human, HCG), 238
 Chronic obstructive pulmonary disease (COPD), 112, 216, 218, 222, 225, 715
 Ciclesonide, 217, 226
 Ciclopirox olamine, 757, 766
 Cilomilast, 220
 Cimetidine, 628, 629-30, also *see* H₂ antagonists
 Cinacalcet, 329
 Cinchonism, 511-12, 789
 Cinnamates, 852
 Cinnarizine, 156, 160, 642
 Ciprofloxacin, 660, 661, 688-91, 736, 737, 744, 748
 Circus movement reentry, 509
 Cisapride, 163, 641, 645, also *see* Prokinetic drugs
 Cisatracurium, 339, 343, 345
 Cisplatin, 821, 827-28, 830, 832
 Citalopram, 439, 442, 446
 Citrovorum factor (folinic acid) rescue, 592, 823, 833
 Clarithromycin, 636, 637, 681, 730, 740, 744, 750, 751, 756
 Clavulanic acid, 681, 702-03
 Clearance of drug (CL), 31, 32, 33
 Clemastine, 156
 Clidinium, 106, 110
 Clindamycin, 681, 711, 731-32, 853
 Clinical pharmacology, 4, 71-74, 77
 Clinical trial, 71-73, 77
 Clioquinol. *See* Quiniodochlor
 Clobazam, 389, 408-09, 411, 412
 Clobetasol butyrate, 854
 Clobetasol propionate, 854
 Clofazimine (Clo), 752, 754, 755, 756
 Clofibrate, 614, 617
 Clomiphene citrate, 303-04
 Clomipramine, 439, 442, 448, also *see* Tricyclic antidepressants
 Clonazepam, 389, 408, 411, 412
 Clonidine, 119, 121, 546-47
 Clopamide, 561, 566
 Clodogrel, 610, 611
 Clorgyline, 121, 439
 Clotrimazole, 757, 762, 804, 849
 Clove oil, 847
 Cloxacillin, 699, 700, 736
 Clozapine, 167, 425, 427, 429, 431, 433
 CNS stimulants, 469-71
 Coagulants, 593-96
 Coal tar, 849, 851
 Cobalt, 587
 Cobra bite, 104, 887-88
 Cocaine, 121, 351, 352, 356-57
 Codeine, 214, 458, 664
 Codergocrine. *See* Dihydroergotoxine
 Coffee, 219
 Cognition-enhancers, 471-74
 Cohort study, 73-74
 Colchicine, 205, 206-07
 Colestipol, 614, 616
 Colistin, 661, 734
 Colloidal bismuth subcitrate (CBS), 636-37
 Common cold, 129, 160, 779, 878
 COMT (Catechol-O-methyl transferase), 117, 118 inhibitors 121, 421, 442
 Conditioned avoidance response (CAR), 426
 Congenital adrenal hyperplasia, 283
 Congestive heart failure (CHF), 500
 drugs for, 130, 142, 486, 489, 500-01, 503-07, 527, 563, 570
 effect on drug kinetics, 67
 treatment of, 502-07
 Conjugation reactions, 25-26
 Conscious sedation, 377
 Constipation: treatment of, 655-56
 Contraceptives, 311-18
 emergency (postcoital), 311, 312, 313
 for females, 311-17
 for males, 317-18
 hormonal, 311-17
 implants, 314
 injectable, 312-14
 once a month (oral), 311
 Controlled ovarian hyperstimulation, 238, 239
 Controlled release tablet/capsule, 35-36
 Convulsants, 469-70
 Copper, 587, 873
 Coronary artery disease (CAD)
 hypolipidaemic drugs in, 619, 620, 621
 risk factors, 619
 Coronary chemoreflex, 164
 Coronary steal, 533, 535
 Corticosteroids, 103, 205, 207, 224-26, 275-87, 647, 663, 756, 815, 816
 Corticotropin. *See* ACTH
 Cortisol. *See* Hydrocortisone
 Co-transmission, 91-92
 Cotrimazine, 686
 Cotrimoxazole, 660, 661, 685-87, 736, 737, 738
 Cough: drugs for, 160, 213-16
 specific treatment approaches, 214
 Counter-irritants, 847-48
 COX-1/COX-2 (cyclooxygenase) isoenzymes, 174-75, 185
 COX-2 (cyclooxygenase-2) inhibitors, 175, 185, 186, 187, 197-98, 200
 Cresol, 858-59
 Cretinism, 245, 248
 Cromoglycate sod (Cromolyn sod), 217, 223-24, 226
 Cross resistance, 671-72
 Cross tolerance, 68

- Crotamiton, 864
 Cryptorchism, 238
 Cumulation, 67
 Curare, 339, also *see* Tubocurarine
 Cutaneous larva migrans, 810, 811
 Cyanide poisoning, 527
 Cyanocobalamin, 588-90, also *see* Vit. B₁₂
 Cyclandelate, 536
 CyclicAMP(cAMP), 46, 47, 48, 124, 151, 153, 220, 328, 575, 627, 657
 Cyclic GMP (cGMP), 295, 523, 524, 657
 Cyclizine, 156, 157, 160, 642
 Cyclooxygenase (COX) inhibitor, 175, 185-87, also *see* Nonsteroidal antiinflammatory drugs
 Cyclopentolate, 106, 111, 113
 Cyclophosphamide, 821, 822, 830, 832, 840-41, 842
 Cycloserine (Cys), 740, 744
 Cyclosporine, 202, 203, 663, 837-40, 842
 Cyproheptadine, 156, 157, 166
 Cyproterone acetate, 293
 Cytarabine, 821, 824, 830, 832
 Cytochrome P 450(CYP) isoenzymes, 24-25
 Cytotoxic drugs, 819-28, 840-41
- D**
- Dacarbazine (DTIC), 821, 822, 830, 832
 Dactinomycin. *See* Actinomycin D
 Dalfopristin/Quinupristin, 733
 Dalteparin, 600
 DAM (Diacetyl monoxime), 105
 Danaparoid, 597, 600
 Danazol, 293
 Dantrolene, 339, 347, 431
 Dapsone (DDS), 751-52, 754, 755, 756
 Daunorubicin (Rubidomycin), 821, 826, 830, 832
 DDS. *See* Dapsone
 DDT. *See* Dicophane
 Decamethonium (C-10), 339, 340
 Deep vein thrombosis, 603, 607, 611
 Deferiprone, 868
 Dehydroemetine, 801
 Demeclocycline, 712, 713
 Demelanizing agents, 851-52
 Dementia, 471
 drugs for, 472-74
 Demulsants, 845
 Depot preparations, 10, 36
 Deprenyl. *See* Selegiline
 Depression (of function), 37
 mental, 424, 439, 448
 Dequalinium chloride, 861
 Dermatophytosis: drugs for, 761, 762, 763, 764, 765, 766
 Dermojet, 10
 Desamino oxytocin, 321
 Desensitization, 50, 52
 Desferrioxamine, 587, 867-68
 Desflurane, 370, 371, 373
 Desloratadine, 156, 158
 Desmopressin, 474, 475, 476, 477, 596
 Desogestrel, 307, 309, 312, 313
 Dexamethasone, 281, 282, 647, also *see* Corticosteroids
 sod. phosphate, 282, 854
 trimethyl acetate, 854
 Dexamphetamine, 125, 126, 127
 Dexchlorpheniramine, 156
 Dexfenfluramine, 125, 129
 Dexmedetomidine, 377
 Dextran, 622
 Dextromethorphan, 213, 215
 Dextropropoxyphene, 460
 DFP. *See* Dyflos
 DHE (Dihydroergotamine), 132, 167, 168, 170
 Diabetes
 insipidus, 574, 577, 578
 mellitus, 254-55, 262-63, 270-72
 Diabetic hyperosmolar (nonketotic) coma, 264-65
 Diabetic ketoacidosis (Diabetic coma), 263-64
 Diabetic nephropathy, 487, 489
 Diacetylmorphine (Heroin), 458
 Diarrhoea: management of, 658-64
 antimicrobials in, 660-61
 Diastase, 649
 Diazepam, 349, 376, 377, 378, 389, 393-96, 409, 411, 413, 450
 Diazinon (TIK-20), 99 (*See* organophosphates)
 Diazoxide, 274, 548, 554
 Dibucaine, 351, 352, 356, 358, 359, 360
 Diclofenac sod., 184, 193-94, 200, 206
 Dicophane (DDT), 864
 Dicumarol. *See* Bishydroxycoumarin
 Dicyclomine, 106, 110, 641
 Didanosine, 667, 771, 776
 Dienestrol, 297, 300
 Dietary fibre, 651, 652
 Diethyl carbamazine (DEC), 809, 812-13
 Diethylstilbestrol (Stilbestrol), 297, 298, 300
 Diffusion: of drugs, 12-13
 Diffusion hypoxia, 369, 371
 Digestants, 649
 Digitalis, 493-502, 503, 505, 511, 518, 519
 toxicity, 498-99
 Digitalization, 501
 Digitoxin, 493, 497, 498, 499
 Digoxin, 493, 497, 498, 499, also *see* Digitalis
 antibodies, 499
 Dihydralazine. *See* Hydralazine
 Dihydroartemisinin (DHA) 793, 795, 796
 Dihydroergotamine (DHE) 132, 167, 168, 170
 Dihydroergotamine (DHE) 132, 167, 168, 473
 Dihydrofolate reductase (DHFRase) inhibitors, 685, 790, 823
 Dihydropyridines (DHPs), 522, 529, 531-32, 533, 543, 544, 551

- Dihydrotestosterone, 288, 289, 290, 294
 Diiodohydroxyquin, 798, 802, 803, 804
 Dilling's formula, 61
 Diloxanide furoate, 661, 798-99, 803
 Diltiazem, 253, 518, 522, 528, 529, 530-31, 532, 534
 Dilutional hyponatremia, 567
 Dimenhydrinate, 156, 157, 160, 641
 Dimercaprol (BAL), 885-86
 Dimercapto succinic acid (Succimer), 886
 Dimethicone, 649, 846
 Dimethindene, 156
 Dinoprost (PGF_{2α}), 181
 Dinoprostone (PGE₂), 181
 Dioctyl sulfo succinate (DOSS). *See* Docusates
 Diphenhydramine, 156, 157, 160, 215, 640
 Diphenoxylate, 664
 Diphenylhydantoin. *See* Phenytoin
 Dipivefrine, 146
 Dipyrindamole, 525, 609, 611
 Dipyrone. *See* Metamizol
 Disinfectants, 857-62
 Disopyramide, 511, 512-13, 519
 Dissociative anaesthesia, 376
 Disulfiram, 385
 Diuretic therapy: complications of, 566-67
 Diuretics, 503-04, 505, 540-42, 551, 552, 553, 561-73
 Divalproex, 402, 408
 DMCM, 394, 395
 DMPA (Depot Medroxy progesterone acetate), 309, 313
 DMPP (Dimethyl phenyl piperazinium), 94, 114
 Dobutamine, 126, 129, 507
 DOCA (Desoxycorticosterone acetate), 280, 282, also *see* Mineralocorticoid
 Docetaxel, 825, 830
 Docusates, 652, 656
 Dofetilide, 511, 517, 519
 Dog (animal) bite: treatment of, 883
 Domperidone, 641, 645, also *see* Prokinetic drugs
 Donepezil, 99, 102, 472-73
 Donovanosis. *See* Granuloma inguinale
 Dopamine (DA), 116, 126, 129, 416, 507
 receptor subtypes, 415
 transporter (DAT), 15, 40, 91
 Dorzolamide, 147
 Dose: of drug, 33-35, 59-60
 for child, 61-62
 for elderly, 62
 loading, 34
 maintenance, 34
 Dose-response relationship, 52-55
 DOTS (Directly observed treatment short course), 746
 Dothiepin, 439, 442, also *see* Tricyclic antidepressants
 Doxacurium, 339, 343, 345
 Doxapram, 470
 Doxazosin, 132, 134, 136, 545
 Doxepin, 439, 442, also *see* Tricyclic antidepressants
 Doxophylline, 217, 221
 Doxorubicin, 821, 826, 830, 832
 Doxycycline, 660, 710, 712, 713, 714, 715, 737, 783, 792
 Doxylamine, 641-42
 Dronabinol, 647
 Drotaverine, 111
 Drug
 absorption, 15-18
 abuse, 84
 action, 37, 38, 44
 activation, 23, 24
 addiction, 84
 adverse effects, 78-86
 allergy, 81-83
 combinations (fixed dose), 60
 combined effect of, 55-58
 definition, 4
 dependence, 83-84
 development, 74-77
 diffusion, 12-13
 distribution, 18-22
 dosage, 33-35, 59-60
 effect, 44-45, 47
 efficacy, 42, 53-54
 essential, 5-6, 903-07
 excretion, 29-31
 factors modifying action of, 61-68
 habituation, 84
 induced diseases, 86
 interactions, 16, 21, 28, 30-31, 55-58, 889-96
 nomenclature, 4-5
 orphan, 6
 penetration into brain, 19, 20
 potency, 53-54
 resistance, 68, 670-72
 routes of administration, 6-10
 selectivity, 54-55
 storage in body, 21, 22
 targets of action, 38-40
 withdrawal reactions, 83, 84
 DTPA cal. disod., 587, 867
 Duloxetine, 439, 442, 447
 Dutasteride, 294-95
 Dydrogesterone, 307, 309
 Dyflos, 99, 102, also *see* Organophosphates
 Dynorphins, 463, 467, 468
 Dysfunctional uterine bleeding, 303, 309
 Dysmenorrhoea, 112, 131, 176, 186, 303

E

- Ebastine, 156, 159
 Echothiophate, 99, 102
 Econazole, 757, 762
 Ecstasy, 438
 Ectoparasiticides, 862-64
 Edema: drugs for, 503, 563, 565-66

- Edrophonium, 99, 101, 104
EDTA (sod./cal. edetate), 587, 866
EDRF (Endothelium dependent relaxing factor), 97, 164
Efavirenz, 767, 772, 774, 775
Eicosanoids, 173-82
Elimination rate constant (K), 32
Emergency contraception, 311, 312, 313
Emesis, 639, 640
 drugs for, 641-47
Emetine HCl, 798, 800-01, 803
Emetics, 639-40
Emollients, 845
Enalapril, 484, 485, also *see* Angiotensin converting enzyme inhibitors
Endogenous (major) depression: treatment, 448
Endometriosis, 239, 293, 309
Endorphins, 463, 467, 468
Enflurane, 370, 371, 372
Enfuvirtide, 774
Enkephalins, 463, 467, 468
Enoxaparin, 599
Entacapone, 415, 417, 421
Enteric fever. *See* Typhoid fever
Enteric nervous system (ENS), 88, 643
Enterobiasis: drugs for, 809, 810, 811, 812
Enuresis (bed wetting): drugs for, 131, 449, 577
Enzyme
 induction, 27-28, 39
 inhibition, 27, 28, 39, 40
 stimulation, 38-39
Ephedrine, 125, 126, 129, 218
Epidural anaesthesia, 361
Epilepsies, 401
 experimental models of, 401-02
 treatment, 411-13
Epinephrine. *See* Adrenaline
Eplerenone, 506, 571
Epoetin. *See* Erythropoietin
Epoprostenol (PGI₂), 182,
Epsilon amino caproic acid (EACA), 608
Erectile dysfunction: drugs for, 295-96
Ergometrine (Ergonovine), 134, 168, 321-22
Ergot alkaloids, 132, 134, 167-68, 170
Ergotamine, 132, 134, 167, 168, 170
Ergotoxine, 132, 134, 167
Erythema nodosum leprosum, 756
Erythryl tetranitrate, 522, 526
Erythromycin, 660, 711, 727-29, 737, 853
 estolate, 728
 ethylsuccinate, 728
 stearate, 728
Erythropoietin (EPO), 592
Escharotics, 848
Escitalopram, 439, 442, 446
Eserine. *See* Physostigmine
Esmolol, 136, 137, 141, 511, 515, 519, 554
Esomeprazole, 633, also *see* Proton pump inhibitors
Esophagitis. *See* Gastroesophageal reflux
Essential medicines (drugs), 5-6, 903-07
Estradiol, 297, 299, also *see* Estrogens
Estradiol TTS (transdermal), 300
Estriol, 297, 300
Estrogens, 297-303, also *see* Oral contraceptives
 conjugated, 299, 300, 301
Estrone, 297
Etanercept, 203, 205
Ethacridine, 322-23
Ethambutol (E), 739, 742-43, 745-49, 750
Ethamsylate, 594, 596
Ethanol. *See* Alcohol ethyl
Ethanolamine oleate, 597
Ether, 370, 371
Ethinyl estradiol, 297, 300, 312, 313, also *see* Oral contraceptives
Ethinyl estranol. *See* Lynestrenol
Ethionamide (Etm), 740, 743, 751, 753
Ethosuccimide, 402, 404, 406-07, 411, 412
Ethyl alcohol, 380-86, also *see* Alcohol ethyl
Ethylbiscoumacetate, 597, 601, 602
Ethylene glycol poisoning, 387
Etidronate, 333, 334-35
Etophylline, 221
Etoposide, 825, 832
Etoricoxib, 184, 197, 198, 206, also *see* COX-2 inhibitors
Eucalyptus oil, 847
Eutectic lidocaine/prilocaine, 357, 359
Evidence based medicine 71-74
Excretion: of drugs, 29-31
Exemestane, 305, 306
Exenatide, 273
Exocytosis, 91, 117
Expectorants, 213, 214, 215-16
Expiry date of pharmaceuticals, 71
Extensively drug resistant (XDR) TB, 690, 748
Ezetimibe, 614, 618-19
- F**
- Facilitated diffusion, 13
Factors modifying drug action, 61-68
False transmitter, 121, 547
Famciclovir, 737, 767, 769
Famotidine, 628, 630, also *see* H₂ antagonists
Faropenem, 709
Febrile convulsions, 409, 411, 412-13
Felodipine, 522, 531, 532
Fenamate, 193
Fenofibrate, 614, 617, also *see* Fibric acid derivatives
Fenfluramine, 125, 129
Fentanyl, 370, 376, 459
 transdermal, 459, 461
Feracrylum, 846

- Ferric
 ammonium citrate, 584
 glycerophosphate, 584
 hydroxide, 584
- Ferritin curtain, 583
- Ferrous
 aminoate, 584
 fumarate, 584
 gluconate, 584
 succinate, 584
 sulfate, 584
- Fexofenadine, 156, 157, 158
- Fibric acid derivatives (Fibrates), 614, 616-17, 621
- Fibrin, 596
- Fibrinogen, 594, 596
- Fibrinolytic drugs, 538, 605-08
- Filariasis: drugs for, 809, 810-11, 813
- Filtration: of drugs, 12, 13, 29
- Finasteride, 294
- First dose effect, 134, 484, 545
- First pass metabolism, 28-29
- Fixed dose ratio combinations, 60
- Flavoxate, 106, 111
- Flecainide, 511, 514-15
- Fluconazole, 757, 759, 763, 764
- Flucytosine (5-FC), 757, 759, 761, 764
- Fludarabine, 824
- Fludrocortisone, 281, 282, 283
- Flumazenil, 394, 395, 399-400
- Flunarizine, 172
- Flunisolide, 217, 226
- Fluocinolone acetonide, 854
- Fluocortolone, 854
- Fluoroquinolones (FQs), 688-693, 744, 748, 749, 750
- 5-Fluorouracil (5-FU), 821, 824, 830, 832
- Fluoxetine, 439, 442, 446
- Flupenthixol, 425, 427, 429
- Fluphenazine, 424, 427, 428
 decanoate, 428
- Flurazepam, 389, 396
- Flurbiprofen, 184, 192, 193
- Flutamide, 294, 828
- Fluticasone propionate, 217, 225-26
- Fluvoxamine, 439, 442, 446
- Folic acid, 412, 589-91
 antagonists. *See* Dihydrofolate reductase inhibitor
- Folinic acid (THFA, leucovorin), 387, 590, 591
- Follitropin α/β (rFSH), 238
- Fomepizole, 387
- Fondaparinux, 600
- Formalin (Formaldehyde), 861
- Formoterol, 125, 127, 217, 218
- Foscarnet, 770
- Fosfestrol, 300, 828
- Fosinopril, 484, 485
- Fosphenytoin, 402, 405, 411
- Framycetin, 726
- Free radicals, 872
- Frovatriptan, 171
- Frusemide. *See* Furosemide
- FSH (Follicle stimulating hormone), 231, 237, 238, 298
- Fulvestrant, 304
- Furazolidone, 804
- Furosemide, 503, 540-41, 554, 560, 561-64, 566-68, 573,
 also *see* High ceiling diuretics
- Fusidic acid (Fusidate sod.), 734
- Fusion inhibitor, 774

G

- GABA_A-benzodiazepine receptor, 349, 391, 394, 395
 drugs affecting, 395
- GABA_B receptor, 349
- GABA-transporter (GAT), 40, 404, 410
- Gabapentin, 402, 404, 409-10, 411, 412
- Galantamine, 99, 102, 473
- Gallium nitrate, 335
- Gall stone dissolving drugs, 649-50
- Gamma benzene hexachloride (BHC, Lindane), 863
- Ganciclovir, 767, 769-70
- Ganglionic
 blocking agents, 115-16
 stimulants, 114-15
- Ganja, 438
- Gastric acid secretion: regulation of, 627, 628
- Gastric hurrying agent, 642, 644
- Gastroesophageal reflux disease (GERD), 647
 drugs for, 631, 632, 644-45, 648
- Gatifloxacin, 688, 690, 692
- Gelatin
 degraded polymer, 622
 foam, 596
- Gemeprost, 181
- Gemfibrozil, 614, 617, also *see* Fibric acid derivatives
- General anaesthetics (GA), 365-78
 properties of ideal, 370
- Gene therapy, 843-44
 applications of, 844
- Genetics: and drug action, 63-64
- Gentamicin, 681, 721, 723-24, 738, also *see*
 Aminoglycoside antibiotics
- Gentamicin-PMMA chains, 724
- Gentian violet, 862
- Gepirone, 449
- Germicide, 857
- Gestodene, 307, 312
- Giardiasis: drugs for, 799, 800, 803-04
- Ginkgo biloba (Ginkgolide), 472, 474
- Glaucoma: drugs for, 144-48
- Glibenclamide, 266, 268, 271, also *see* Oral
 hypoglycaemic drugs
- Gliclazide, 266, 268, 271
- Glimepiride, 266, 268, 271
- Glipizide, 266, 268, 271

- Glucagon, 256, 273-74
 Glucocorticoids, 175, 275, 276, 277-80, 282, 285-87, 335, 828, 841, 842, also *see* Corticosteroids
 antagonist, 287, 310
 Glucomannan, 273
 Glucuronide conjugation, 25
 Glutaraldehyde, 861
 Glyburide. *See* Glibenclamide
 Glycerol (Glycerine), 213, 573, 845
 Glyceryl trinitrate (GTN), 522, 525, 526, 527, 554, also *see* Nitrates
 Glycopeptide antibiotics, 732-33
 Glycoprotein (GP) II_b/III_a antagonists, 610
 Glycopyrrolate, 106, 110, 112, 379
 Glycyrrhiza, 845
 GnRH agonists, 239, 294, 829
 GnRH antagonists, 239-40
 Goiter, 248, 249
 Goitrin, 249
 Goitrogens, 249
 Gold, 202, 204
 Gonadotropins (Gns), 231, 237-39
 Gonadotropin releasing hormone (GnRH, Gonadorelin), 231, 237, 239
 Gonorrhoea: drugs for, 690, 698, 701, 708, 715, 729, 731, 737
 Good clinical practice (GCP), 77
 Gossypol, 318
 Gout: drugs for, 205-10, 284
 acute, 205-07
 chronic, 207-10
 G-6-PD deficiency: and drugs, 64, 684, 687, 752, 792
 G-proteins, 45, 46
 G-protein coupled receptor (GPCR), 45-48, 52
 Granisetron, 647
 Granuloma inguinale (Donovanosis), 715, 731, 737
 Grave's disease, 249, 250, 251, 252, 253
 Gray baby syndrome, 717
 Griseofulvin, 757, 760-61
 Growth hormone (GH), 231, 233-34
 Guaiaphenesin, 213
 Guanethidine, 120, 121, 549
 Guar gum, 273
 Gugulipid, 614, 619
 Guinea worm: drugs for, 800, 809
 Gum acacia, 845
 Gum tragacanth, 845
- H**
- HAART (Highly active antiretroviral therapy), 774, 775
 H₁ antagonists, 153, 155-61
 H₂ antagonists, 153, 162, 379, 629-31, 648
 H₃ antagonists, 153, 162
 Habituation, 84
 Haematinics, 581-92
 Haemostatics: local, 596-97
 Haemophilia, 577
 Halcinonide, 854
 Half life (*t*_{1/2}), 32
 Hallucinogens, 424, 437-38
 Halofantrine, 781, 794
 Haloperidol, 426, 427, 428-29, 432
 Halothane, 324, 370, 371, 372
 Hamycin, 757, 760, 804
 Harmine, 437
 Heart block. *See* A-V block
 Heavy metal antagonists (Chelating agents), 865-68
 Hemicholinium (HC3), 93, 94
 Heparan sulfate, 597, 600
 Heparin, 597-99, 603-05, 606, 607
 antagonist, 600
 low molecular weight, 599-600
 Hepatic coma: drugs for, 655, 725
 Hepatitis B virus (HBV): drugs for, 769, 771-72, 778, 779
 Hereditary angioneurotic edema, 292
 Heroin, 458
 Herpes simplex: drugs for, 767-70
 genital, 737, 768, 769
 Herpes zoster : drugs for, 769
 Hetastarch (*See* Hydroxyethyl starch)
 Hexachlorophene, 859
 Hexamethonium, 94, 96, 115
 Hexamine. *See* Methenamine
 Hexyl resorcinol, 859
 High-ceiling diuretics, 503, 540-41, 560, 561-64, 566-68
 Histamine, 151-55
 receptors, 151-52, 153
 releasers, 155
 Hit and run drugs, 35
 HIV infection: drugs for, 770-74
 prophylaxis of, 776-77
 treatment guidelines, 774-76
 HMG-CoA reductase inhibitors (Statins), 538, 614-16, 619, 620, 621
 Hofmann elimination, 27, 345
 Homatropine, 106
 Hook worm: drugs for, 809, 810, 811, 812
 Hormone: definition, 231
 sites and mechanisms of action, 232
 Hormone replacement therapy (HRT), 301-03
 Human diploid cell vaccine (HDCV) 880, 883
 Human insulin, 225, 260-61
 Human teratogenic drugs, 85
 Hydatid disease: drugs for, 809, 810
 Hydralazine, 504, 505, 540, 547-48, 553, 554
 Hydrochloric acid, 649
 Hydrochlorothiazide, 540, 541, 551, 561, 566, 578, also *see* Thiazide diuretics
 Hydrocortisone, 227, 275, 276, 280, 281, 283, 285, also *see* Corticosteroids
 acetate, 281, 854, 855
 butyrate, 855
 Hydroflumethiazide, 561, 566, 570

- Hydrogen peroxide, 859
Hydrolysis: of drugs, 25
Hydroquinone, 851
Hydroxocobalamin, 588, 589, 590, also *see* Vit B₁₂
Hydroxychloroquine, 202, 203-04
Hydroxyethyl starch (HES), 622
Hydroxyethyl theophylline, 217, 221
Hydroxyprogesterone caproate, 307, 309
8-Hydroxyquinolines, 798, 802-03
5-Hydroxytryptamine (5-HT), 162-66
 receptor subtypes, 163-64
5-HT antagonists, 166-68
Hydroxyurea, 827, 830
Hydroxyzine, 156, 157, 161, 451
Hyoscine, 106, 109, 112, 113, 641
 butyl bromide, 106, 109
Hypercalcaemia, 330, 334, 335, 564
Hyperglycaemics, 273-74
Hyperkinetic children. *See* Attention deficit disorder
Hyperparathyroidism, 328-29
Hypersensitivity (allergic) reactions, 81-83, 160
 to penicillin, 697-98
Hypertension: drugs for, 135, 142, 486, 489, 539-49,
 564, 566, 570
 treatment of, 549-53
Hypertensive emergencies/urgencies, 553-54
Hyperthyroidism, 245, 249-53, also *see* Thyrotoxicosis
Hypertrophic obstructive cardiomyopathy, 143, 533
Hypervitaminosis A, 871
Hypervitaminosis D, 332
Hypnotics, 388-99
Hypoglycaemia, 261, 262, 267
Hypolipidemic drugs, 612-21
Hypoparathyroidism, 328, 329, 333
Hypothalamic hormones/factors, 231, 234, 239
Hypothyroidism, 245, 248
- I**
- Ibandronate, 333
Ibuprofen, 184, 192, 193, 200
Ibutilide, 511, 517
Icatibant, 492
Idiosyncrasy, 81
Idoxuridine, 767
Ifosfamide, 821, 822
IL-1 antagonist, 203, 205
Imatinib, 828, 832
Imidapril, 485
Imidazole antifungals, 761-63
Imidazoline receptors, 546
Imipenem, 708-09
Imipramine, 439, 441, 442, 444, also *see* Tricyclic
 antidepressants
Immunoglobulins (IGs), 886-88
 antiD, 842
 hepatitis B, 887
 normal human, 886
 rabies (HRIG), 887
 tetanus, 886-87
Immunization schedule for infants and children, 885
Immunosuppressant drugs, 837-43
 in inflammatory bowel disease, 663
 in organ transplantation, 842-43
 in rheumatoid arthritis, 202, 203
Impeded androgens, 293
Implants, 10, 314
Inamrinone. *See* Amrinone
Indapamide, 540, 542, 561, 565, 566
Indinavir, 767, 772, 773, 775, 776
Indomethacin, 184, 195, 200, 206, 578
Infantile spasms, 413
Infertility: drugs for, 236, 238, 239, 293, 303-04
Inflammatory bowel disease (IBD): drugs for, 661-63
Infliximab, 203, 205, 663
Influenza virus : drugs for, 767, 777-78
INH. *See* Isoniazid
Inhaled asthma medication, 226
Inhaled steroids, 224-26, 227
Inhalation of drugs, 9, 368
Inhibin, 237, 289
Inhibition of drug metabolism, 27
Inodilator, 507
Insomnia: drugs for, 388, 397, 398-99
Insulin, 254, 255-66, 272
 analogues, 259, 261-62
 aspart, 259, 261
 assay, 255
 delivery devices, 265-66
 glargine, 259, 261-62
 glulisine, 259, 261
 human, 255, 260-261
 lispro, 259, 261
 preparations, 259-61
 reactions to, 262
 receptor, 258
 resistance, 265
Insulin like growth factors (IGFs), 233-34
Interaction: among drugs, 889-96, also *see* Drug
 interactions
 before administration, 895-96
 clinically important, 892-94
 pharmacodynamic, 894-95
 pharmacokinetic, 890-91
Interferon α , 778-79
Intolerance, 81
Intraarterial injection, 7
Intradermal (i.d.) injection, 10, 882, 883
Intramuscular injection (i.m.), 10
 absorption from, 16-17
Intravenous anaesthetics, 370, 374-77
Intravenous injection (i.v.), 10
Intravenous regional anaesthesia, 361
Intrinsic activity, 42

- Inverse agonists, 41, 42, 43, 395
 Iodide. *sod./pot.*, 213, 249, 251-52, 253
 Iodine, 249, 251-52, 253, 859
 radioactive (¹³¹I), 249, 252-53
 Iodochlorohydroxyquin. *See* Quiniodochlor
 Iodophores, 859-60
 Iodoquinol. *See* Diiodohydroxyquin
 Ion channels : as target of drug action, 40
 Ion trapping, 13
 IP₃ (Inositol trisphosphate), 46, 47, 48
 IP₄ (Inositol tetrakisphosphate), 47
 Ipecacuanha (Ipecac), 639, 640
 Ipratropium bromide, 106, 109, 112, 222, 227
 Irbesartan, 489
 Irinotecan, 825, 826, 832
 Iron, 581-87
 absorption, 582-83
 choline citrate, 584
 calcium complex, 584
 dextran, 585-86
 dietary sources, 582
 hydroxy polymaltose, 585
 poisoning, 587
 sorbitol-citric acid, 585-86
 Irritable bowel syndrome (IBS), 648, 654, 662
 Irritants, 847
 Irritation, 37
 Ischaemic preconditioning, 534
 Isoflurane, 370, 371, 373
 Isoniazid (INH; H), 739, 740-41, 745-50
 Isoprenaline, 116-22, 125, 130, 518
 Isopropamide, 106, 110
 Isopropanol, 861
 Isosorbide, 573
 Isosorbide dinitrate, 522, 525, 526
 Isosorbide mononitrate, 522, 525, 526
 Isotretinoin, 854
 Isoxsuprine, 125, 128, 131, 323
 Ispaghula, 652, 662
 Ispapirone, 449
 Itraconazole (ITR), 757, 759, 764-65
 Ivermectin, 809, 813-14, 864
- J**
- JAK-STAT kinase binding receptors, 49, 50, 233, 779
 Jarisch-Herxheimer reaction, 698, 756
- K**
- Kala-azar. *See* Leishmaniasis
 Kallidin, 490-92
 Kallikreins, 490, 491, 605
 Kanamycin (Kmc), 721, 724, 740, 744
 Keratolytics, 848-49
 Ketamine, 336, 370, 376
 Ketanserin, 163, 164, 167
 Ketoconazole (KTZ), 757, 759, 762-63, 764, 806, 807, 849
 Ketoprofen, 184, 192, 193
 Ketorolac, 184, 194, 200
 Ketotifen, 217, 224
 Kidney disease and drugs, 66, 673
 Kinetics of drug elimination, 31-34
 Kinins: plasma, 490-92
 receptors, 491
 Kinin antagonists, 492
- L**
- Labetalol, 136, 140, 143, 544-45, 554
 Labour: induction/augmentation, 181, 311, 320, 321
 Labour: suppression, 323-24
 Lacidipine, 522, 531-32
 Lactulose, 655, 656
 Lamivudine, 767, 774-75, 776
 Lamotrigine, 402, 404, 409, 411, 412, 437
 Lansoprazole, 628, 633, 637, also *see* Proton pump
 inhibitors
 L-Asparaginase, 827, 830, 832
 Latanoprost, 146, 147, 182
 Laxatives, 651-56
 L-Dopa. *See* Levodopa
 Lead poisoning, 866
 Leflunomide, 202, 204
 Leishmaniasis: drugs for, 210, 759, 763, 804-07
 dermal, 763, 807
 Lepirudin, 597, 600
 Lepra reaction, 756
 Leprosy: drugs for, 751-53
 alternative regimens, 755-56
 multidrug therapy (MDT), 753-55
 Leptin, 131
 Leptospirosis: drugs for, 699, 715, 729
 Lercanidipine, 522, 532
 Letrozole, 305-06
 Leucovorin. *See* Folinic acid
 Leukotrienes (LTs), 173, 174, 175, 179-80
 antagonists, 180, 222-23, 227
 Levamisole, 809, 812
 Levarterenol. *See* Noradrenaline
 Levetiracetam, 402, 410
 Levobunolol, 145-46
 Levobupivacaine, 358
 Levocetirizine, 156, 159
 Levodopa, 415-18, 419, 422
 Levofloxacin, 688, 690, 692
 Levonorgestrel, 307, 309, 312, 313, 314
 LH (Luteinizing hormone), 231, 237, 238, 298
 Lidocaine, 351-61, 498, 511, 513-14, 519
 Ligand, 41, 865
 Lignocaine. *See* Lidocaine
 Lincomycin, 732
 Lincosamide antibiotics, 731-32
 Lindane, 863

Linezolid, 733
 Liothyronine. *See* Triiodothyronine
 Liposomal amphotericin B, 758, 759, 806
 Liquid paraffin, 653, 656, 845
 Liqueurice, 213
 Lisinopril, 484, 485, also *see* Angiotensin converting enzyme inhibitors
 Lithium, 434-36, 575
 alternatives to, 436-37
 Liver disease and drugs, 65-66, 674
 Loading dose: of drug, 34
 Lobeline, 114
 Local anaesthetics (LAs), 351-61
 with adrenaline, 354, 360
 Lomefloxacin, 688, 690, 692
 Lomustine (CCNU), 822
 Loperamide, 664
 Lopinavir, 767, 772, 774, 775
 Loratadine, 156, 158
 Lorazepam, 376, 378, 389, 409, 413, 450
 Losartan, 488, also *see* Angiotensin antagonists
 Lovastatin, 614, 615, also *see* Statins
 Loxapine, 425, 427, 429
 Lugol's solution, 252
 Lumefantrine, 781, 782, 783, 795-96
 Lutropin (rLH), 238
 Lymphogranuloma venereum, 715, 729, 731, 737
 Lypressin, 474, 476, 477
 Lynestrenol, 307, 309
 Lysergic acid amide, 437
 Lysergic acid diethylamide (LSD), 166, 437

M

MAC (*Mycobacterium avium* complex): drugs for, 730, 731, 744, 750
 Macrolide antibiotics, 727-31
 Mafenide, 682, 684
 Magaldrate, 635
 Magnesium
 hydroxide, 634, 635, 655
 stearate, 846
 sulfate, 323, 655
 trisilicate, 634, 635
 Maintenance dose of drug, 34
 Malaria
 drugs for, 780-96
 prophylaxis of, 782-83
 radical cure of, 784, 792
 treatment of severe and complicated, 784, 789, 794
 treatment of uncomplicated, 783
 Malathion, 99, also *see* Organophosphates
 Male contraceptive, 317-28
 Malignant hyperthermia, 346, 347, 372
 Malignant neuroleptic syndrome, 347, 431
 Mania, 424, 430, 433, 434-37
 Manic depressive illness (MDI). *See* Bipolar disorder

Mannitol, 147, 561, 572, 573
 Marijuana, 438
 Masking of infection, 673
 Mast cell stabilizers, 223-24
 Maturation factors, 587-92
 MDMA. *See* Ecstasy
 MDR1 (Multidrug resistance1) gene, 15, 831
 Mebendazole, 808, 809, 810
 Mecamylamine, 115
 Mechanism of drug action, 37-52
 Mechlorethamine (Mustine HCl), 821, 822, 830, 832
 Meclizine (Meclizine), 156, 642
 Medroxyprogesterone acetate (MPA), 301, 307, 309, 313, 314
 Mefloquine, 781, 782, 783, 787-88, 795
 Megaloblastic anaemia, 589, 590, 591
 Megestrol acetate, 307
 Meglitinide analogue, 266, 268, 272
 Melanizing agents, 850
 Melatonin, 400
 Meloxicam, 184, 196
 Melfalan, 822, 830, 832
 Memantine, 472, 473
 Menadione, 594, 595
 sodium bisulfite, 594, 595, 596
 Ménière's disease, 160
 Menopausal hormone therapy (MHT). *See* Hormone replacement therapy
 Menotropins, 238
 Menthol, 848
 Mepacrine, 788
 Meperidine. *See* Pethidine
 Mephenamic acid, 184, 193
 Mephesisin, 348
 Mephentermine, 125, 127
 Mercaptopurine (6-MP), 821, 823, 824, 830, 832
 Meropenem, 709
 Mesalazine (5-ASA, Mesalamine), 662
 enema, 662
 Mescaline, 438
 Mesterolone, 289, 291
 Mestranol, 297, 300
 Meta analysis, 73
 Metabolism. *See* Biotransformation
 Metabolism: presystemic (first pass), 28-29
 Metamizol, 184, 195-96
 Metformin, 266, 267-69, 271, also *see* Biguanides
 Methacholine, 97, 98
 Methadone, 457, 459-60
 Methamphetamine, 125, 126, 127
 Methandienone, 292
 Methanol. *See* Alcohol methyl
 Methdilazine, 156
 Methenamine, 735, 736, 738
 Methicillin, 699, 700
 Methicillin resistant *Staphylococcus aureus* (MRSA), 696, 700
 drugs for, 708, 732, 733

- Methimazole, 249, 250
 Methocarbamol, 348-49
 Methohexitone, 370, 375, 389
 Methotrexate (Mtx), 202, 203, 592, 663, 823, 830, 832, 841
 Methoxamine, 125, 127
 Methoxsalen, 850
 Methyl alcohol, 386-87
 Methyl cellulose, 652, 662, 845
 Methyl cobalamin, 588, 589
 Methyl dopa, 540, 547, 553
 Methylergometrine, 319, 321-22
 Methylphenidate, 469, 470
 Methyl polysiloxane, 649
 Methyl prednisolone, 281, 282
 Methyl salicylate, 848
 Methyl testosterone, 288, 291, 292
 Methyl xanthines, 217, 218-22
 Methysergide, 166-67, 172
 Metoclopramide, 169, 379, 642-45, 648
 Metolazone, 503, 561, 565, 566
 Metoprolol, 136, 137, 140, 141, 528
 Metronidazole, 637, 638, 661, 681, 798-800, 803, 804
 Metyrapone, 287
 Mexiletine, 511, 514, 519
 Mezlocillin, 702
 Mianserin, 439, 442, 447
 Miconazole, 757, 762
 Microsomal enzymes, 26
 induction, 27-28
 Midazolam, 370, 376, 378
 Mifepristone, 181, 287, 310-11, 312
 Miglitol, 266, 270
 Migraine, 143, 165, 169-72, 449
 Milk-alkali syndrome, 635
 Milk ejection reflex, 320
 Milk: excretion of drugs in, 29, 911-14
 Milk of magnesia, 634, 655
 Milrinone, 507
 Miltefosine, 806
 Mineralocorticoid, 275, 276, 277
 Minimal alveolar concentration (MAC), 365, 368, 371
 Minimal brain dysfunction. *See* Attention deficit disorder
 Minimum bactericidal concentration (MBC), 675
 Minimum inhibitory concentration (MIC), 675
 Minocycline, 710-14, 753, 756
 Minoxidil, 540, 548
 Miotic, 102, 147, 148
 Mirtazapine, 439, 442, 447
 Misoprostol, 181, 310, 311, 322, 634
 Mithramycin, 335
 Mitomycin C, 827, 830, 832
 Mitoxantrone, 826, 832
 Mivacurium, 339, 343, 345
 Mizolastine, 156, 159
 Moclobemide, 121, 439, 440, 448
 Modafinil, 469, 470-71
 Molgramostim, 833
 Mometasone, 854
 Monoamine oxidase (MAO), 117, 118, 162, 439
 non selective inhibitors (MAOI), 121, 440
 selective MAO-A inhibitor, 121, 440
 selective MAO-B inhibitor, 121, 420
 subtypes of, 162, 420, 439-40
 Monobactams, 708
 Monobenzene, 852
 Montelukast, 217, 222-23
 Mood stabilizer, 434-37
 MOPP regimen, 831
 Moricizine, 511, 513
 Morning sickness, 160, 641, 644
 Morphine, 378, 453, 454-58, 461-62, 463, 537
 dependence, 457
 epidural/intrathecal, 461
 poisoning, 456-57
 Mosapride, 641, 645-46, also *see* Prokinetic drugs
 Motion sickness, 113, 160, 641
 Moxifloxacin, 688, 693, 744
 MPTP, 414
 MRP (Multidrug resistance associated protein), 15
 Mucokinetics. *See* Expectorants
 Mucolytics, 213
 Mupirocin, 733-34
 Muromonab CD3, 841, 842
 Muscarine, 97, 98
 Muscarinic
 actions, 97
 receptor, 94-96
 Muscimol, 395
 Muscle relaxants, 339-50
 centrally acting, 348-50
 Mushroom poisoning, 98
 Mustard seeds, 848
 Mutagenicity of drugs, 76, 86
 Mustine. *See* Mechlorethamine
 Myasthenia gravis, 102-04
Mycobacterium avium complex (MAC) infection, 739, 750
 Mycophenolate mofetil (MMF), 837, 841, 842
 Mydriatics, 106, 111, 112-13
 Myocardial infarction (MI): drugs for, 142, 191, 487,
 489, 527, 528, 533, 537-38, 604, 606, 610-11
 Myxoedema, 248, also *see* Hypothyroidism
 Myxoedema coma, 248
- N**
- Nabilone, 647
 Nabumetone, 184, 196
 N-acetyl cysteine, 199, 213, 214
 Nadifloxacin, 853
 Nadroparin, 599
 Nafarelin, 239
 Nalidixic acid, 661, 687, 736, 738
 Nalmefene, 464, 467

- Nalorphine, 463, 464
Naloxone, 456-57, 463, 464, 466-67
Naltrexone, 385, 464, 467
Nandrolone, 292
Naphazoline, 125, 128
Naproxen, 184, 191, 193, 200, 206
Naratriptan, 171
Narcoanalysis, 375
Narcolepsy, 130
Narcotine. *See* Noscapine
Nasal decongestants, 125, 128, 129
Nasal administration, 9, 239, 576
Natamycin, 757, 760, 804
Nateglinide, 266, 268, 269
Natural progesterone, 306, 308, 309
Nebivolol, 136, 148
Needlestick injury: prophylaxis after, 776-77
Nefopam, 184, 199
Nelfinavir, 767, 773, 775
Neomycin, 725-26
Neostigmine, 99, 101, 102, 103, 104, 346
Nerve block anaesthesia, 359
Netilmicin, 721, 725
Neuroadaptation, 83
Neurocysticercosis: drugs for, 285, 810, 815-16
Neurohumoral transmission, 89-92
Neuroleptic drugs, 424, also *see* Antipsychotic drugs
Neuromuscular blocking agents, 339-47
Neuroses, 424
New formula WHO-ORS, 659
Nevirapine, 767, 772, 774, 775
Niacin (Vit B₃), 618, 874, 875
Niclosamide, 809, 814
Nicorandil, 534-35
Nicotinamide. *See* Niacin
Nicotine, 114, 115
 transdermal, 115
Nicotinic acid (Vit B₃), 614, 618, 621, 874, 875
Nicotinic actions, 96, 97
Nicotinic receptors, 96, 114, 340
Nicotinyln xanthinate, 536
Nicoumalone. *See* Acenocoumarol
Nifedipine, 323, 522, 528, 529, 531, 532, 533
Nimesulide, 184, 196, 200
Nimodipine, 522, 532
Nimorazole, 804
Nisiritide, 507
Nitazoxanide, 798, 802, 804
Nitrates, 522-27
Nitrate dependence/tolerance, 524, 525
Nitrazepam, 389, 396
Nitrendipine, 522, 531
Nitric oxide (NO), 97, 295, 490, 523-24, 549, also *see* EDRF
Nitrofurantoin, 735, 736, 738
Nitrofurazone, 862
Nitrogen mustards, 819, 822
Nitroglycerine. *See* Glyceryl trinitrate
Nitroprusside sod., 504, 548-49, 554
Nitrous oxide (N₂O), 366, 370, 371, 377
Nocebo, 65
Nociceptin/Orphanin FQ (N/OFFQ), 468
Nomegestrol acetate, 307
Nonadrenergic-noncholinergic (NANC) transmission, 91, 295, 643
Non-benzodiazepine hypnotics, 389, 394, 397-98
Noncompetitive antagonism, 57, 58
Nonmicrosomal metabolism, 26-27
Nonnucleoside reverse transcriptase inhibitors (NNRTIs), 772, 775
Nonreceptor mediated action, 52
Nonsedating antihistamines, 156, 158, also *see* Antihistamines: second generation
Nonsteroidal antiinflammatory drugs (NSAIDs), 175, 184-201, 202
 and PG synthesis inhibition, 185-87
 choice of, 200-01
 in gout, 206
 interactions with, 191
 shared toxicities, 185, 186, 187
 topical, 199-200
Nootropic drug, 473
Noradrenaline (NA), 116-23, 125, 129
Noradrenergic and specific serotonergic antidepressant (NaSSA), 447
Norepinephrine. *See* Noradrenaline
Norepinephrine transporter (NET), 40, 91, 117, 441
Norethisterone. *See* Norethindrone
Norethindrone, 301, 307, 309
 enanthate (NEE), 309, 313, 314
Norfloxacin, 661, 688, 690, 691, 736, 738
Norgestimate, 307, 312
Norgestrel, 313
Noscapine, 213, 215, 453
Nortriptyline, 439, 442
Nucleoside reverse transcriptase inhibitors (NRTIs), 770-72, 773, 775
Nystatin, 757, 780
-
- OAT (organic anion transporter), 30, 565
OATP (organic anion transporting polypeptide), 15, 20, 29, 207
Obesity: drugs for, 130-31
Obsessive compulsive disorder (OCD), 424, 445, 446, 448
OCT (Organic cation transporter), 15, 29, 30
Octreotide, 235, 577
Ofloxacin, 688, 690, 691, 744, 748, 751, 753, 756
Oil of wintergreen. *See* Methyl salicylate
Olanzapine, 425, 427, 429-30, 433, 437
Olestra, 131
Olive oil, 845
Olsalazine, 662-63
Omalizumab, 217, 226

- Omeprazole, 628, 631-32, 637, 638, also *see* Proton pump inhibitors
- Ondansetron, 163, 164, 167, 379, 646-47, 833
- On-off effect, 418, 422
- Opioid
- agonist-antagonists, 464-66
 - analgesics, 453-62
 - antagonists (pure), 464, 466-67
 - antidiarrhoeals, 662, 663-64
 - antitussives, 214-15
 - peptides, 467-68
 - receptors, 462-64
- Opium, 453
- Oral
- absorption, of drugs, 7, 16-18
 - anticoagulants, 600-04
 - contraceptives (OCs), 311-17
 - hypoglycaemic drugs, 266-73
 - iron preparations, 583-85
 - rehydration salt/solution (ORS), 658-60
 - route of administration, 7
- Organ transplantation: immunosuppressants in, 842-43
- Organophosphates, 99, 100, 102
- poisoning, 104-05
- Orlistat, 131
- Ormeloxifene, 305
- Ornidazole, 798, 800, 803
- Orphan drugs, 6
- Orphenadrine, 415, 422
- Oseltamivir, 767, 777-78
- Osmotic diuretics, 572-73
- Osmotic (saline) purgatives, 654-55, 656
- Osteoarthritis, 191, 192, 193, 194, 199, 200, 284
- Osteomalacia, 331, 332
- Osteoporosis
- anabolic steroids in, 293
 - bisphosphonates in, 333-35
 - calcitonin in, 330
 - calcium in, 327
 - hormone replacement therapy in, 301
 - raloxifene in, 305
 - vit D in, 333
- Oxazepam, 389, 450
- Oxazolidinone antimicrobial, 733
- Oxcarbazepine, 402, 406
- Oxethazaine, 351, 358, 359
- Oxiconazole, 757, 762
- Oxidation, 24-25
- Oximes, 100, 105
- Oxotremorine, 94
- Oxpentifylline. *See* Pentoxifylline
- Oxybenzone, 852
- Oxybutynin, 106, 111, 112
- Oxymetazoline, 125, 128
- Oxymetholone, 292
- Oxyphedrine, 536
- Oxyphenbutazone, 184, 195
- Oxyphenonium, 106, 110, 628, 633
- Oxytetracycline, 712, 713
- Oxytocics, 319-22
- Oxytocin, 319-21
- antagonist, 323-24
- Oxytocin challenge test, 321
- Oxyuresis. *See* Enterobiasis
- P**
- PABA (Para amino benzoic acid), 852
- Paclitaxel, 825, 830, 832
- PAF antagonists, 183
- Paget's disease, 330, 334, 335
- 2-PAM. *See* Pralidoxime
- Pamidronate, 333, 334, 335
- Pamparin, 600
- Pancreatin, 649
- Pancuronium, 339, 343, 344, 345
- Pantoprazole, 628, 632, 633, also *see* Proton pump inhibitors
- Pantothenic acid, 874, 876
- Papain, 649
- Papaverine, 453
- Para aminosalicylic acid (PAS), 740, 743
- Paracetamol, 184, 198-99, 200
- poisoning, 198-99
- Paraffin: soft/hard, 845
- liquid, 653, 656
- Paraldehyde, 389
- Parasympathetic system, 88, 89
- Parasympathomimetic drugs. *See* Cholinergic drugs
- Parathyroid hormone (PTH), 327-29
- Parecoxib, 184, 197, 198
- Parenteral routes, 9-10, 16-17
- Parkinsonism, 414, 431
- drugs for, 106, 236, 415-22
- Paromomycin, 806-07
- Paroxetine, 439, 442, 446
- Paroxysmal supraventricular tachycardia (PSVT), 502, 509, 511, 518, 519
- Partial agonist, 41, 42, 43
- Patient controlled analgesia (PCA), 461
- Pediculosis: drugs for, 814, 862-64
- Pefloxacin, 688, 690, 691
- Pegvisomant, 235
- Pellet implantation, 10
- Pemoline, 471
- Penfluridol, 425, 429
- Penicillamine, 202, 204, 867
- Penicillinase, 694, 696
- Penicillins, 694-702
- acid resistant, 699
 - benzathine, 697, 698, 699, 737
 - benzyl (G), 694, 696-99
 - extended spectrum, 700-702
 - penicillinase resistant, 699-700

- phenoxymethyl (V), 699
- procaine, 697, 698
 - semisynthetic, 699-702
- Pentaerythritol tetranitrate, 522, 526
- Pentamidine, 805-06
- Pentazocine, 463, 464-65
- Pentobarbitone, 389, 391
- Pentolinium, 115
- Pentoxiphylline, 536-37
- Pentylene tetrazole (PTZ), 402, 469-70
- Peppermint oil, 649
- Pepsin, 649
- Peptic ulcer: drugs for, 112, 628-38
 - treatment of, 631, 632, 636, 637-38
- Perchlorate sod/pot., 249
- Perindopril, 484, 485
- Peripheral decarboxylase inhibitors, 415, 418-19, 422
- Peripheral vascular diseases (PVDs), 130, 136, 182, 536-37, 607, 611
- Permethrin, 863
- Pernicious anaemia, 589, 591
- Pethidine, 378, 440, 458-59
- P-glycoprotein, (P-gp), 15, 16, 20, 29, 30, 64, 831
- Pharmaceutics, 4
- Pharmacodynamics, 3, 37-58
- Pharmacogenetics, 63-64
- Pharmacogenomics, 63-64
- Pharmacokinetics, 3, 11-36
- Pharmacology: definition, 3
- Pharmacotherapeutics, 4, 59-70
- Pharmacovigilance, 79
- Pharmacy: definition, 4
- Phenacetin, 198
- Phenazopyridine, 735
- Phencyclidine, 438
- Phenformin, 267
- Phenindione, 597, 601, 602
- Pheniramine, 156, 157
- Phenobarbitone, 389-92, 402-03, 411, 412, 413, also *see* Barbiturates
- Phenol, 597, 848, 858
- Phenolphthalein, 653, 656
- Phenoxybenzamine, 132, 133-34, 135, 136, 545
- Phentolamine, 132, 134, 135, 136, 545, 554
- Phenylbutazone, 184, 195
- Phenylephrine, 120, 125, 127, 129
- Phenyl propanolamine (PPA), 125, 128, 130
- Phenytoin, 402, 403-05, 411, 412, 413, 816
- Pheochromocytoma, 135, 142-43
- Pholcodeine, 215, 458
- Phosphodiesterase-III (PDE-III) inhibitors, 507
- Phosphodiesterase-5 (PDE-5) inhibitors, 295-96
- Phospholipase C-IP₃-DAG pathway, 46, 47, 48, 96, 124
- Photochemotherapy (PUVA), 851
- Photosensitivity, 83
- Phylloquinone. *See* Vit. K₁
- Physical dependence, 83-84
- Physostigmine, 95, 99, 101, 102, 104
- Phytonadione (vit K₁), 593-96, 602
- Picrotoxin, 395, 469
- Pilocarpine, 97, 98, 147
- Pimozide, 425, 426, 427, 429
- Pindolol, 136, 137, 140, 141
- Pinocytosis, 15
- Pioglitazone, 266, 268, 269-70
- Pipecuronium, 339, 343, 345
- Pipenzolate, 106, 110
- Piperacillin, 699, 702, 703
- Piperaquine, 781, 795, 796
- Piperazine, 809, 811-12
- PIPE therapy, 136, 296
- Piracetam, 472, 473
- Pirenzepine, 106, 111, 628, 633
- Piribedil, 472, 474
- Piroxicam, 184, 194, 200, 206
- pKa, 12
- Placebo, 64
- Placental hormones, 232
- Placental transfer of drugs, 20
- Plasma concentration monitoring, 34-35
- Plasma expanders, 621-23
- Plasma half life (t_{1/2}), 32
- Plasma kinins, 490-92
- Plasma protein binding, 20-22
- Plateau principle, 33-34
- Platelet activating factor (PAF), 182-83
 - antagonists, 183
- Pneumocystis jiroveci* pneumonia: drugs for, 686, 732, 792, 806
- Podophyllum resin, 848
- Poisoning, 80-81
- Polyene antibiotics, 757-60
- Polygeline, 622
- Polymyxin B, 734
- Polyptide antibiotics, 734-35
- Polyvinyl polymer, 846
- Polyvinyl pyrrolidone (PVP), 622-23
- Post antibiotic effect (PAE), 675, 720, 723
- Postexposure prophylaxis (PEP)
 - of HIV, 776-77
 - of rabies, 883
- Postmarketing surveillance 77, 79
- Post partum haemorrhage (PPH), 181, 321, 322
- Potassium
 - channel openers, 504, 534-35
 - chloride, 498
 - iodide, 213
 - permanganate, 859
 - sparing diuretics, 540, 542, 561, 569-72
- Potentiation, 56
- Povidone iodine, 804, 860
- Pralidoxime (2-PAM), 105
- Pramipexole, 415, 419-20, 422
- Pramlintide, 273

- Pravastatin, 614, 615, also *see* Statins
 Praziquantel, 809, 814-15, 816
 Prazosin, 119, 132, 134, 135, 136, 545, 552, 553
 Preanaesthetic medication, 112, 378-79
 Preclinical studies, 76
 Prednicarbate, 854
 Prednisolone, 281, 282, 284, 831, 842, also *see*
 Corticosteroids
 Pregnancy: and drugs, 63, 84-86, 908-10
 category of drugs, 85
 termination by drugs, 180-81, 310-11
 Premature labour, 323-24
 Premenstrual dysphoric disorder (tension), 310, 446
 Presystemic (first pass) metabolism, 28-29
 Prilocaine, 351, 352, 357
 Primaquine, 781, 782, 783, 784, 785, 791-92
 Primidone, 402, 403, 411, 412
 Prinzmetal's angina. *See* Variant angina
 Probenecid, 30, 205, 207-08, 701, 737
 Procainamide, 511, 512, 519
 Procaine, 351, 352, 353, 355, 356, 357
 Procarbazine, 821, 827, 830, 832
 Prochlorperazine, 642
 Procyclidine, 106, 415, 422
 Prodrug, 23, 24
 Progesterone, 275, 306, 307-09
 natural, 306, 309
 Progestins, 301, 302, 306-10, 829, also *see* Oral
 contraceptives
 Proguanil (Chloroguanide), 781, 782, 783, 789-90
 Prokinetic drugs, 642-46, 648
 Prolactin, 231, 235-36
 Prolonging drug action, 35-36
 Promethazine, 156, 157, 160, 215, 378, 422, 641
 theoclate, 641
 Propafenone, 511, 514, 519
 Propantheline, 106, 110, 628, 633
 Propionic acid derivatives, 191-93, 200
 Propiphenazone, 184, 195
 Propofol, 366, 370, 375, 377
 Propoxur, 99, 105
 Propranolol, 136-40, 142, 143, 172, 253, 499, 511, 515,
 519, 522, 528, 544
 Propylene glycol, 845, 849
 Propyl thiouracil, 249, 250, 251, 253
 Prostacycline (PGI₂), 173-79, 180, 182
 Prostaglandins (PGs), 173-79, 180-82, 322
 analogues, 146-47, 633
 synthesis inhibitors, 175, 184, 185-87, also *see* Non
 steroidal antiinflammatory drugs
 Prostanoid receptors, 180
 Protamine sulfate, 600
 Protamine zinc insulin (PZI), 259, 260
 Protease inhibitors (PIs): antiretroviral, 772-74, 775
 Protectives, 846
 Proton pump inhibitors (PPIs), 379, 628, 631-33, 637-
 38, 648
 Pseudocholinesterase (BuChE), 93, 95, 98
 deficiency/atypical, 64, 341, 344
 Pseudoephedrine, 125, 128, 130
 Pseudomembranous enterocolitis, 673, 731, 732, 799
 Psilocybin, 437
 Psoralen, 850, 851
 Psoriasis: drugs for, 850-51
 Psychological dependence, 83
 Psychopharmacological agents (Psychotropic drugs),
 423-52
 Psychoses, 423-24, 432-33
 Psychostimulants, 469, 470-71
 Psychotogens. *See* Hallucinogens
 Psychotomimetics. *See* Hallucinogens
 Psyllium, 651, 652, 662
 Pulmonary hypertension: drug for, 295
 Purgatives, 651-56
 abuse, 656
 bulk forming, 651, 652
 mechanism of action, 651-52
 osmotic/saline, 654-55
 stimulant, 653-54
 Purified chick embryo cell vaccine (PCEV), 883
 Purified vero cell rabies vaccine (PVRV), 883
 Purine antagonists, 823-24
 PUVA (Psoralen-Ultraviolet A), 851
 Pyrantel pamoate, 809, 811
 Pyrazinamide (Z), 739, 742, 745-49
 Pyrazolone derivatives, 184, 195-96
 Pyridostigmine, 99, 101, 103
 Pyridoxine (vit B₆), 418, 587, 741, 874, 875-76
 Pyrimethamine, 781, 782, 783, 790
 Pyrimethamine-sulfonamide combination, 783, 790-91,
 795
 Pyrimidine antagonists, 824
 Pyritinol (Pyrithioxine), 472, 473
 Pyronaridine, 781, 795, 796
- Q**
- Quaternary ammonium antiseptics, 860-61
 Quetiapine, 425, 427, 430, 437
 Quinidine, 511-12, 519
 Quinine, 347-48, 781, 782, 783, 784, 788-89
 Quiniodochlor, 766, 798, 802, 803, 804
 Quinolones, 687-93
 Quinupristin/Dalfopristin, 733
- R**
- Rabeprazole, 628, 633, also *see* Proton pump inhibitors
 Racecadotril, 663
 Raloxifene, 305
 Ramelteon, 400
 Ramipril, 484, 485, 487
 Randomization, 72
 Ranitidine, 379, 628, 630, 637, also *see* H₂ antagonists

- Ranolazine, 536
 Rapacuronium, 339
 Rational use of medicines, 68-70
 Rauwolfia alkaloid. *See* Reserpine
 Raynaud's phenomenon, 130, 136, 182, 533, 537, also *see* Peripheral vascular disease
 Reboxetine, 439, 445
 Receptors, 40-52
 desensitization, 50, 52
 enzyme-linked, 49-50
 functions of, 52
 G-protein coupled, 45-48
 JAK-STAT kinase binding, 49, 50
 nature of, 43
 occupation theory, 41-42
 presynaptic (prejunctional), 91, 117
 regulating gene expression, 50, 51
 regulation, 50, 52
 silent, 44
 spare, 42
 subtypes, 43-44
 transducer mechanisms, 45-50
 two-state model, 42-43
 with intrinsic ion channel, 45, 48-49
 Rectal administration, 7, 8
 Redistribution, 19, 374, 394, 396
 Red man syndrome, 732
 Reduction, 25
 Reflux esophagitis. *See* Gastroesophageal reflux
 Refractory asthma. *See* Status asthmaticus
 Rehydration, 658-60
 Renal excretion of drugs, 29-31
 Renin: Angiotensin system (RAS), 479, 560
 drugs inhibiting, 482, 483-90
 Repaglinide, 266, 268, 269
 Renzapride, 164
 Reserpine, 117, 120, 121, 549
 Resistance: to AMAs, 670-72
 prevention of, 672
 Resorcinol, 849
 Respiratory stimulants (Analeptics), 470
 Retriplase, 606
 Retinoic acid, 853, 871
 Retinoid receptors, 871
 Retroviral protease inhibitors (PIs), 772-74, 775
 Reversal reaction: in leprosy, 756
 Reversible inhibitors of MAO-A (RIMAs), 440-41
 Reviparin, 599
 Reye's syndrome, 189
 Rheumatic fever, 190, 284, 699
 Rheumatoid arthritis, 191, 194, 195, 200, 202-05, 283
 disease modifying antirheumatic drugs (DMRDs) in, 202-05
 Ribavirin, 767, 778
 Riboflavin (vit B₂), 587, 873, 874
 Ricketts, 331, 332, 333
 Rickettsial infections, 715, 718
 Rideal-Walker coefficient, 858
 Rifabutin, 744, 748
 Rifampin (Rifampicin, R), 739, 741-42, 745-50, 753, 754, 755, 756
 Rimantadine, 777
 Rimonabant, 115, 131
 Risedronate, 333, 334, 335
 Risk-benefit ratio, 55
 Risperidone, 167, 425, 427, 429, 433
 Ritodrine, 125, 127, 131, 323
 Ritonavir, 767, 772, 773, 775
 Rivastigmine, 99, 102, 472
 Rizatriptan, 171
 Rocuronium, 339, 343, 345
 Rofecoxib, 197
 Roflumilast, 220
 Ropinirole, 415, 419-20, 422
 Ropivacaine, 351, 352, 358
 Rosiglitazone, 266, 268, 269-70
 Rosuvastatin, 614, 615, also *see* Statins
 Round worm (Ascariasis): drugs for, 809, 810, 811, 812, 813
 Routes of administration, 6-10, 64
 Roxatidine, 628, 630, also *see* H₂ antagonists
 Roxithromycin, 730
 Rubefacients, 847
 Rubidomycin. *See* Daunorubicin
 Rupatadine, 156, 159
 Rutin, 594, 596
 Ryanodine receptor (RyR) calcium channel, 64, 347, 372, 496
- S**
- SABE (Subacute bacterial endocarditis), 699, 701, 723, 724
 Salbutamol, 125, 127, 217-18, 227
 Salicylates, 187-91
 Salicylazosulfapyridine. *See* Sulfasalazine
 Salicylic acid, 766, 849
 Saline purgatives. *See* Osmotic purgatives
 Salmeterol, 125, 217, 218
 Saquinavir, 767, 772, 773
 Satranidazole, 798, 800, 803
 Scabies: drugs for, 814, 862-64
 Schistosomiasis, 815
 Schizophrenia, 423
 drugs for, 433-34, also *see* Antipsychotic drugs
 treatment of, 432-33
 Sclerosing agents, 597
 Scopalamine. *See* Hyoscine
 Secnidazole, 798, 800, 803, 804
 Secondary effects, 80
 Second gas effect, 369, 370
 Sedative, 388
 Selective estrogen receptor down regulators (SERDs), 304
 Selective estrogen receptor modulators (SERMs), 304-05

- Selective 5-HT_{1B/1D} agonists, 170-71
Selective serotonin reuptake inhibitors (SSRIs), 166, 439, 442, 445-46, 448, 452
Selegiline, 415, 420, 422
Selenium sulfide, 849
Senile dementia, 471
Senna, 654, 656
Sequential trial, 73
Serotonergic receptors, 163-64
Serotonin. *See* 5-Hydroxytryptamine
Serotonin and noradrenaline reuptake inhibitor (SNRI), 447
Serotonin transporter (SERT), 15, 40, 91, 162, 441
Sertraline, 439, 442, 446
Sevoflurane, 370, 371, 373-74
Sexually transmitted diseases: treatment of, 737, 738
Shelf-life (of drugs), 71
Shock: drugs for, 129, 136, 285, 467, 623
 septic: corticosteroids in, 285
Sialistic implants, 10
Sibutramine, 125, 129, 131
Side effects, 79-80
Sildenafil, 295-96
Silver nitrate, 848, 862
Silver sulfadiazine, 684, 862
Simethicone. *See* Dimethicone
Simvastatin, 614, 615, also *see* Statins
Single enantiomer drugs, 75
Sisomicin, 721, 725
Sitagliptin, 273
Skeletal muscle relaxants, 339-50
SLC (solute carrier), transporter, 14, 15
Sleep, 388-89
Slow acting antirheumatoid drugs (SAARDs), 202-05
Smoking cessation: aid to, 115, 448
SMON (subacute myelo-optic neuropathy), 802
SNP (single nucleotide polymorphism), 64, 843
Sodium
 alginate, 648
 benzoate, 655
 bicarbonate, 264, 387, 537, 634, 649
 citrate, 213, 597, 634
 cromoglycate, 217, 223-24, 226
 edetate (EDTA), 697, 866
 hypochlorite solution, 860
 nitrite, 527
 nitroprusside, 504, 548-49, 554
 oxalate, 697
 phenyl acetate, 655
 phosphate, 655
 picosulfate, 653
 pot. tartrate, 655
 stibogluconate (SSG), 805, 807
 sulfate, 655
 tetradecyl sulfate, 597
 thiosulfate, 766
 valproate. *See* Valproic acid
Somatomedins, 233
Somatostatin, 231, 234, 235, 274
Somatrem, 234
Somatropin, 234
Sotalol, 136, 137, 140, 511, 515
Sources of drugs, 74-76
Sparfloxacin, 688, 690, 692
Spermaceti, 845
SPF (sun protection factor), 852
Spinal anaesthesia, 359-61
Spirits, 380
Spiramycin, 731
Spironolactone, 503, 505, 506, 540, 542, 561, 569-71, 573
SRS-A. *See* Leucotrienes
Stanozolol, 292
Starch, 846
Statins (HMG-CoA reductase inhibitors), 538, 614-16, 619, 620, 621
Status asthmaticus, 227
Status epilepticus, 403, 405, 409, 411, 413
Stavudine, 767, 771, 774, 775, 776
Stimulation, 37
Stokes-Adams syndrome, 130
Streptokinase (Stk), 606, 607
Streptomycin (S), 721, 722-23, 739, 743, 745-49
Streptozocin, 274
Stroke (cerebrovascular disease), 604-05, 607, 611
Strongyloidosis: drugs for, 809, 810, 813
Strophanthin, 493
Strychnine, 469
Styptics, 596-97
Subcutaneous injection (s.c.), 10
 absorption from, 16-17
Sublingual administration, 7, 8
Succimer, 866
Succinyl choline (SCh), 339-344, 346, 347
Sucralfate, 628, 636, 846
Sulbactam, 703
Sulfacetamide sod., 682, 684, 685
Sulfadiazine, 682, 683
Sulfadoxine, 682, 684, 783, 791
Sulfamethoxazole, 682, 683, also *see* Cotrimoxazole
Sulfamethopyrazine, 682, 684, 791
Sulfanilamide, 682
Sulfasalazine, 202, 203, 661-62, 684
Sulfapyrazone, 205, 208
Sulfonamides, 682-85
Sulfone syndrome, 756
Sulfonylureas, 266-67, 268, 271-72
Sulfur, 864
Sultamicillin tosylate, 703
Sumatriptan, 163, 164, 170-71
Sun screens, 852
Superactive Gn-RH agonists, 239
Superinfection (Suprainfection), 672-73
Super ORS, 659-60
Supersensitivity, 50, 81
Surface anaesthesia, 358, 359

- Surface area and drug dose, 61-62
Surgical site infection (SSI): prophylaxis of, 679-81
Suxamethonium. *See* Succinylcholine
Sympathetic nervous system, 88, 89
Sympathomimetics, 120-31, 217
 directly acting, 120
 indirectly acting, 120
Synergism, 55-56
 among antimicrobials, 677
Syphilis: drugs for, 698, 715, 729, 737
- T**
- Tachyphylaxis, 68
Tacrine, 99, 101, 472
Tacrolimus, 837, 840, 842
Tadalafil, 296
Takadiastase, 649
Talc, 846
Tamoxifen citrate, 304-05, 832
Tamsulosin, 132, 135, 136
Tannic acid/Tannins, 597, 847
Tape worm: drugs for, 809, 814, 815
Tardive dyskinesia, 431-32
Target level strategy, 34
Taxanes, 825
Tazarotene, 851, 853
Tazobactam, 703
Tea, 219
Tegaserod, 641, 646, 654, 656
Teicoplanin, 733
Telmisartan, 489
Temazepam, 389, 396, 397
Tenecteplase, 606
Tenoxicam, 184, 194
Teratogenicity, 84-86
Terazosin, 132, 134, 136, 545
Terbinafine, 757, 765
Terbutaline, 125, 127, 217, 218
Terfenadine, 158
Teriparatide, 329
Terlipressin, 474, 476, 477
Testosterone, 288-93, 295
 undecanoate, 288, 291
Tetanus, 350
Tetany, 327
Tetracaine, 351, 352, 353, 356, 357, 359, 360
Tetracyclines, 637, 661, 710-15, 781, 782, 783, 792, 803
 Δ^9 Tetrahydrocannabinol (Δ^9 THC), 438, 647
Tetramethyl ammonium (TMA), 114
Tetramisole, 812
Tetrodotoxin, 91
Thalidomide, 84, 85, 756, 834
Theobromine, 218
Theophylline, 217, 218-22
 ethanolate of piperazine, 221
 ethylene diamine. (Aminophylline), 221, 227
Therapeutic drug monitoring (TDM), 34-35
Therapeutic index, 54, 670
Therapeutic window phenomenon, 53, 443, 546
Thiabendazole, 811
Thiacetazone (Tzn), 740, 743, 746, 747
Thiamine (vit B₁), 873, 874
Thiazide diuretics, 503, 540-42, 551, 552, 560, 561, 564-68, 573, 574, 577-78
Thiazolidinediones, 266, 268, 269-70, 272
Thiocyanate sod./pot, 249
6-Thioguanine (6-TG), 823, 830, 832
Thiopentone sod., 370, 374-75, 389, 391
Thioridazine, 424, 427, 428
Thio-TEPA, 822,
Thread worm. *See* Enterobiasis
Threatened abortion, 128, 310, 323
Thrombin, 596
Thrombolytics. *See* Fibrinolytic drugs
Thromboxane A₂ (TXA₂), 173-79, 180
Thymol, 848
Thyroid disease and drugs, 67
Thyroid hormones, 242-49
Thyroid inhibitors, 249-53
Thyroid storm: treatment of, 143, 252, 253, 285
Thyrotoxicosis (hyperthyroidism), 245, 249
 drugs for, 143, 250, 252, 253
Thyrotropin. *See* TSH
Thyroxine (T₄), 242-49
Tiagabine, 402, 404, 410
Tianeptine, 439, 447
TIAs (Transient ischaemic attacks), 472, 536, 605, 609, 611
Tibolone, 297, 302
Ticarcillin, 702
Ticlopidine, 609-10, 611
TIK-20, 99, also *see* Diazinon
Tiludronate, 333
Timolol, 136, 140, 144-45, 148
Tinea infection: drugs for, 761, 762, 763, 764, 765, 766
Tinidazole, 637, 638, 798, 800, 803, 804
Tiotropium bromide, 106, 110, 222
Tissue type plasminogen activator (rt-PA, Alteplase), 606, 607
Titanium dioxide, 852
Tizanidine, 348, 349
TNF α inhibitors, 203, 204-05
Tobacco, 115
 amblyopia, 590
Tobramycin, 721, 724
Tocolytics, 323-24, also *see* Uterine relaxants
Tolazoline, 132, 134
Tolbutamide, 266, 268, 271
Tolcapone, 415, 417, 421
Tolerance, 67-68
Tolnaftate, 757, 766
Tolterodine, 106, 111
Tolu balsum, 213

- Topical application of drugs, 7, 17
 Topical NSAIDs, 199-200
 Topical steroids, 849, 850, 854-56
 adverse effects of, 855-56
 Topiramate, 172, 402, 404, 410, 411, 412, 437
 Topotecan, 825, 826, 832
 Toremifene, 305
 Torasemide 561, 563
 Torsades de pointes, 158, 510, 512, 516, 519, 692
 Toxic effects, 80
 Toxicity studies, 76
 Toxicology: definition, 4
 Toxoids, 879
 diphtheria, 880, 885
 tetanus (TT), 880, 885
 TPMT-deficiency, 64, 824
 Trachoma: drugs for, 685, 715, 731
 Tramadol, 460-61
 Trandolapril, 485
 Tranexaemic acid, 608
 Tranquillizer, 424
 Transdermal androgen, 291
 Transdermal fentanyl, 459, 461
 Transdermal therapeutic systems (TTS), 9, 36
 Transduction: drug resistance by, 671
 Transformation: drug resistance by, 671
 Transporters, 13-15, 38, 40
 Tranylcypromine, 121, 440
 Traveller's diarrhoea, 660, 663, 664
 Trazodone, 439, 442, 447
 Tretinoin, 853, 871
 Triamcinolone, 281, 282
 acetonide, 282, 854
 Triamterene, 561, 571
 Triazolam, 389, 396, 397
 Triazole antifungals, 761, 763-65
 Trichloroacetic acid, 848
 Trichomoniasis: drugs for, 737, 799, 800, 803, 804
 Tricyclic antidepressants, 172, 441-45, 448-49
 Trifluoperazine, 424, 427, 428
 Trifluoperidol, 425, 427, 429
 Triflupromazine, 424, 427, 428
 Trigeminal neuralgia, 405, 406
 Trihexyphenidyl, 106, 415, 422
 Triiodothyronine (T₃), 242-47, 248
 Trimetazidine, 535-36
 Trimethaphan camforsulfonate, 115
 Trimethoprim, 685, 687
 + sulfamethoxazole. *See* Cotrimoxazole
 Trimipramine, 439, 442, also *see* Tricyclic antidepressants
 Trioxsalen, 850
 Tripotassium dicitrato-bismuthate (CBS), 628, 636-37
 Triprolidine, 156, 157, also *see* H₁ antagonists
 Triptorelin, 239
 Tropical eosinophilia: drug for, 813
 Tropicamide, 106, 111, 113
 TSH (Thyroid stimulating hormone), 231, 240, 243, 245
 Tuberculosis, 739
 biology of infection, 745
 chemoprophylaxis of, 749
 conventional regimen for, 746
 corticosteroids in, 749
 extensively drug resistant (XDR), 748
 in AIDS patients, 749-50
 in breast feeding women, 749
 in pregnancy, 748-49, 909
 multidrug resistant (MDR), 748
 short course chemotherapy (SCC), 746-48
 treatment of, 745-50
 Tubocurarine (d-TC), 96, 339, 343, 344
 Tubular reabsorption/secretion of drugs, 30
 Turpentine oil, 847
 Typhoid fever: drugs for, 686, 690, 691, 701, 706, 708, 718
 Tyramine, 120, 121
 Tyrothricin, 734-35
- U**
- Ulcerative colitis: drugs for, 661-63
 Ulcer protectives, 636-37
 Undecylenic acid, 757, 766
 Unstable angina (UA), 191, 522, 526, 528, 533, 604, 611
 Urea, 849
 Ureido penicillins, 702
 Uricosuric drugs, 207-08
 Urinary antiseptics, 735
 Urinary pH and excretion of drugs, 30
 Urinary tract infection: drugs for, 684, 686, 690, 700, 708, 715, 718, 735, 736, 738
 prophylaxis, 684, 735
 urinary pH and use of AMAs in, 738
 Urofollitropin, 238
 Urokinase, 606, 607
 Ursodeoxycholic acid (Ursodiol), 649-50
 USAN (United States adopted name), 4
 Uterine
 inertia, 321
 relaxants, 125, 131
 stimulants, 319-22
- V**
- Vaccines, 879-86
 bacterial, 880-82
 BCG, 880, 882, 885
 cholera: inactivated, 880, 881
 cholera: oral, 881
 double antigen (DT-DA), 885
 haemophilus influenzae type b (Hib), 880, 882
 hepatitis A, 880, 884
 hepatitis B, 880, 884, 885
 influenza virus, 880, 884
 killed (inactivated), 879

- live attenuated, 879
 measles: live attenuated, 880, 884
 meningococcal A & C, 880, 881
 MMR (measles, mumps, rubella), 880, 884, 885
 mumps: live attenuated, 880, 884
 plague, 880, 882
 polio: inactivated (IPV, Salk), 880, 882
 polio: oral (OPV, Sabin), 880, 882, 885
 rabies: carbolized, (Semple/neural tissue vaccine), 880, 883
 rabies: purified chick embryo cell vaccine (PCEV), 880, 882
 rabies: human diploid cell (HDCV), 880, 882
 rabies: purified vero cell (PVRV), 880, 882
 rubella, 880, 884
 varicella (live attenuated), 880, 885
 TAB, 880, 881, 885
 triple antigen (DPT), 880, 885
 typhoid-Ty21a (oral), 880, 881, 885
 typhoid: Vi polysaccharide, 880, 881, 885
 viral, 882-85
 whooping cough (pertussis), 880, 881
 Valacyclovir, 737, 767, 769
 Valdecoxib, 197
 Valethamate, 106, 110
 Valproic acid, 170, 402, 404, 407-08, 411, 412, 437
 VAMP regimen, 831
 Valsartan, 489, 490
 Vancomycin, 661, 680, 681, 695, 732
 Vardenafil, 296
 Varenicline, 115
 Variant angina, 165, 322, 521, 522, 523, 528, 532-33
 Vasaka, 213
 Vasodilators, 504-05
 Vasomotor reversal, 123, 132
 Vasopressin. *See* AVP
 receptors, 574-75
 Vecuronium, 339, 343, 344, 345
 Venereal diseases: treatment of. *See* Sexually transmitted diseases
 Venlafaxine, 439, 442, 447
 Verapamil, 511, 517, 518, 519, 522, 528, 529, 530, 534
 Vertigo: drugs for, 155, 160
 Vesamicol, 93, 94
 Vesicular monoamine transporter (VMAT), 15, 117, 162
 VIAGRA. *See* Sildenafil
 Vigabatrin, 402, 404, 410
 Vinblastine, 821, 825, 830, 832
 Vinca alkaloids, 824-25
 Vincristine, 821, 825, 830, 832
 VRE (Vancomycin resistant enterococcus), 732, 733
 VRSA (Vancomycin resistant *Staphylococcus aureus*), 732, 733
 Visual cycle: vit A in, 870
 Vitamins, 869-78
 definition, 869
 fat soluble, 869-73, 874
 vit A, 869-71, 874
 vit B complex, 873-78
 vit B₁₂, 588-90, 874
 vit C, 874, 878
 vit D, 330-33, 874
 vit E, 871-72, 874
 vit K, 593-96, 601, 602, 874
 water soluble, 873-78
 Volatile oils, 847-48
 Volume of distribution (V), 18, 19, 31-33
 von Willebrand's factor (vWF), 577
 Voriconazole, 757, 759, 765
- W**
- Warfarin sod., 597, 600-05
 Whip worm (Trichuris): drugs for, 809, 810
 Whitefield's ointment, 766
 Whooping cough, 718, 729, 881, 885
 Wilson's disease: drug for, 867
 Wines, 380, 384
 Withdrawal reactions, 83, 84
 Wool fat, 845
 WPW (Wolff-Parkinson-White syndrome), 510, 512, 515, 516, 517, 519
- X**
- Xantinol nicotinate, 536
 Xenobiotics, 12
 Xipamide, 561, 565, 566
 Xylometazoline, 125, 128
- Y**
- Yohimbine, 119, 132, 135
 Young's formula, 61
 Yuzpe method, 312
- Z**
- Zafirlukast, 217, 222-23
 Zaleplon, 389, 394, 398
 Zanamivir, 767, 778
 Zidovudine (AZT), 767, 770-71, 774, 775, 776, 777
 Zileuton, 175, 223
 Zinc
 oxide, 846
 pyrithione, 849
 stearate, 846
 sulfate, 862
 Ziprasidone, 425, 427, 430, 433
 Zoledronate, 333, 334, 335
 Zollinger-Ellison syndrome, 631, 632
 Zolmitriptan, 171
 Zolpidem, 389, 394, 398
 Zonisamide, 402, 404, 410, 411
 Zopiclone, 389, 397-98