

2nd
Edition

Review of
**FORENSIC MEDICINE
& TOXICOLOGY**

Including Clinical & Pathological Aspects

MCQs of Previous Years
PG Entrance Examinations Included

Gautam Biswas



Forewords
Joseph A Prahlow
Anil Aggrawal

JAYPEE

Review of
Forensic Medicine and Toxicology

Review of
Forensic Medicine and Toxicology

Including Clinical and Pathological Aspects

MCQs of Previous Years
PG Entrance Examinations Included

SECOND EDITION

Gautam Biswas MD (UCMS)

Professor and Head
Department of Forensic Medicine and Toxicology
Dayanand Medical College and Hospital
Ludhiana, Punjab, India

Forewords

Joseph A Prahlow
Anil Aggrawal



JAYPEE BROTHERS MEDICAL PUBLISHERS (P) LTD

New Delhi • Panama City • London



Jaypee Brothers Medical Publishers (P) Ltd.

Headquarter

Jaypee Brothers Medical Publishers (P) Ltd.
4838/24, Ansari Road, Daryaganj
New Delhi 110 002, India
Phone: +91-11-43574357
Fax: +91-11-43574314
Email: jaypee@jaypeebrothers.com

Overseas Offices

J.P. Medical Ltd.
83 Victoria Street, London
SW1H 0HW (UK)
Phone: +44-2031708910
Fax: +02-03-0086180
Email: info@jpmepub.com

Jaypee-Highlights Medical Publishers Inc.
City of Knowledge, Bld. 237, Clayton
Panama City, Panama
Phone: +507-301-0496
Fax: +507-301-0499
Email: cservice@jphmedical.com

Website: www.jaypeebrothers.com
Website: www.jaypeedigital.com

© 2012, Jaypee Brothers Medical Publishers

All rights reserved. No part of this book may be reproduced in any form or by any means without the prior permission of the publisher.

Inquiries for bulk sales may be solicited at: jaypee@jaypeebrothers.com

This book has been published in good faith that the contents provided by the author contained herein are original, and is intended for educational purposes only. While every effort is made to ensure accuracy of information, the publisher and the author specifically disclaim any damage, liability, or loss incurred, directly or indirectly, from the use or application of any of the contents of this work. If not specifically stated, all figures and tables are courtesy of the author. Where appropriate, the readers should consult with a specialist or contact the manufacturer of the drug or device.

Review of Forensic Medicine and Toxicology

First Edition: 2010

Second Edition: **2012**

ISBN 978-93-5025-896-5

Printed at

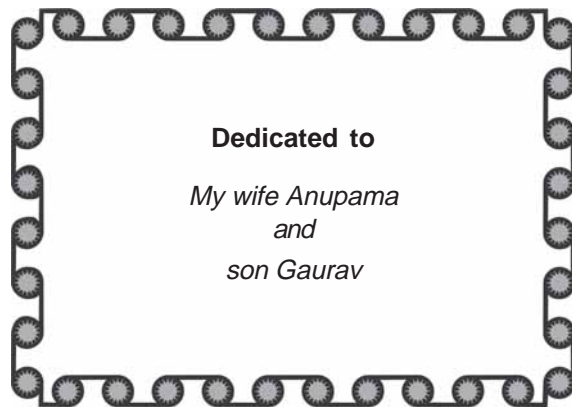

Dedicated to

*My wife Anupama
and
son Gaurav*

Foreword to the Second Edition

The second edition of *Review of Forensic Medicine and Toxicology* by Gautam Biswas represents a truly remarkable accomplishment within the forensic literature. This book is written, specifically for persons in training and studying for board-type examinations, the text is a comprehensive yet concise overview of forensic medicine and toxicology that actually covers many forensic topics that are largely ignored or only briefly mentioned by many other forensic texts. Examples include chapters dedicated to issues, such as decompression, radiation and altitude sickness, starvation, anesthetic deaths, torture and custodial deaths, as well as many individual toxicology chapters, such as arsenic, inorganic metals, war gases and food poisoning among many others. The book represents an excellent resource for forensic medicine practitioners, forensic pathologists, toxicologists and others within the forensic community.



The text is divided into two sections: First, Jurisprudence and Forensic Medicine and second is Toxicology, with a total of 63 Chapters. Each chapter provides basic information, as well as numerous details, in an easy-to-understand, concise, and clear manner. An added plus is the inclusion of clinical and therapeutic information, making the text ideal for persons practicing “living” forensic medicine. As a forensic pathologist, I highly recommend this book to all forensic pathologists, both those who are in-training and seasoned veterans. The book represents an impressive collection of basic forensics intermingled with a multitude of interesting and important facts that are not commonly found together in single resource. As such, the book is must have for everyone's forensic reference library and highly recommended for those studying for forensic board examinations.

My congratulations to Gautam Biswas for this outstanding forensic text.

A handwritten signature in black ink, appearing to read 'J. Prahlow'.

Joseph A Prahlow MD
Forensic Pathologist, South Bend Medical Foundation
Professor
Department of Pathology
Indiana University, School of Medicine-South Bend
at the University of Notre Dame
South Bend, Indiana, USA

Foreword to the Second Edition

Forensic medicine is a vast subject, which needs to be explored by an overburdened student in very little time available to him. There are several textbooks available in the market, but none gives information in clear, concise, pointwise format. Many give archaic information, which is no more relevant in the current scenario. Still worse, several others give mutually conflicting information.

Forensic medicine is a rapidly changing subject, and there was a dire need to look at it from a fresh angle. It has been my belief that existing books have not been able to do justice with this situation. They have existed in the market for a long time, but most authors have provided information with no proper structuring or organization of information. Result is that the student is often left confused.

Gautam Biswas is a young author teeming with energy and fresh ideas, who has written this eminently readable book. Contrary to official wisdom of presenting information in essay style, he has presented information in a clear, concise, pointwise fashion, which is student-friendly. I have gone through the first edition of this book, and found all information authentic, precise and to-the-point. During our theory and viva-voce examinations, I saw several students clutching this book in their hands and I often asked them what they liked about the book. The answer was virtually uniform, they liked the point-by-point approach of author. I dare say that I like precisely the same thing about this book. Whatever information I need for my lectures or court work, I can immediately find it. Such is the clear organization of this book.

I have known Gautam Biswas for more than a decade now, and I have always held him in high esteem as an academic colleague. I am his ardent admirer and have always been struck by his academic brilliance.

I believe, whenever a new textbook comes to the market, the author owes an explanation not only to students but also to all his academic colleagues. The question often asked is, "What was the need of a new book, when a number of textbooks were already available?" But, fortunately, Dr Gautam Biswas will not have to go through this often embarrassing exercise. This book is in many ways different from the existing textbooks, and undoubtedly would come as a succor to all the students of this country and abroad. I, certainly, would keep this book on my desk as a quick, authentic and reliable reference.



A handwritten signature in black ink, appearing to read 'Anil', with a long horizontal line extending to the right.

Professor Anil Aggrawal MD
Director-Professor
Department of Forensic Medicine and Toxicology
Maulana Azad Medical College
New Delhi, India

Foreword to the First Edition

It is almost nine years when Dr Gautam Biswas came to meet me with recommendation from Dr BBL Aggarwal, Principal (now retired), University College of Medical Sciences and Guru Teg Bahadur (GTB) Hospital, Delhi, India.

He joined as Lecturer at Dayanand Medical College and in no time I found out that he is an asset to the Department due to his updated knowledge in the subject. About three years ago, he sought my advice about writing a Textbook of Forensic Medicine and Toxicology for MBBS students. The result is before us in the form of *Review of Forensic Medicine and Toxicology*.

All the chapters are well-written, easy-to-read and in simple English. Definitions are easily understood and wherever required examples have been given.

Chapter on Medico-legal Autopsy is also useful for all those Medical Officers who have to perform medico-legal autopsies and postgraduate (PG) students of Forensic Medicine and Pathology. Chapters on “Injuries, Regional Injuries and Forensic Psychiatry” have been written in a very systematic manner and due consideration has been given to medico-legal aspects of injuries. Forensic Psychiatry is totally updated as per the modern classification of mental illnesses. Subject of “Thanatology” has been dealt with as per the latest trends giving examples. Latest status of Unnatural Sexual Offences in other countries is quite relevant in modern times. Chapter on “Sexual Perversion” gives useful information. “DNA Fingerprinting”—a highly technical subject will be useful for the students and forensic scientists. Detailed discussion in the Identification, Odontology and “Recent Advances” like Polygraph, Brain Fingerprinting and Narcoanalysis are quite informative for the undergraduate students of forensic and other specialties.

Chapters on Autopsy Room Infections, Postmortem Artefacts, Torture and Custodial Deaths and Asphyxial Deaths are very apt and have made the book quite useful even for PG students of other subjects.

The chapters on Toxicology are totally updated as per the current protocol and guidelines. Signs & symptoms and treatment have been given systematically, which will be quite useful for the emergency medical practitioners also.

Lastly, the concept of MCQs from different PG entrance examinations given at the end of each chapter is quite innovative. This will be useful for the 2nd professional students to grasp the subject better as well as for the students who are preparing for various PG entrance examinations.

I have every confidence that this book will receive warm welcome from the students, especially the undergraduates. I wish this book every success, which it admirably deserves.

Maj. Gen. (Dr) Ajit Singh (Retd)

MBBS DCP MD (Pathology) MD (Forensic Medicine) FIAFM
Ex-Professor and Head
Department of Forensic Medicine and Toxicology
Armed Forces Medical College (AFMC)
Pune, Maharashtra, India
Dayanand Medical College and Hospital (DMCH)
Ludhiana, Punjab, India

Preface to the Second Edition

I am overwhelmed by the response of students to the first edition *Review of Forensic Medicine and Toxicology*.

The text is presented in a concise and lucid form with line-diagrams, boxes, tables, differentiations and flow charts designed to make the book interesting-to-read, easy-to-comprehend, recollect and reproduce.

As in the first edition, some topics (Identification, Injuries, Sexual Offences, Forensic Psychiatry, General Toxicology, Alcohol, Snake Bite Poisoning), which are important from PG entrance point of view, are in more details. All topics are updated and recent advances/changes have been incorporated wherever needed. Section two (Toxicology) has been updated and some additional matter has been added.

As a teacher, I am of the view that we should try to prepare the student for the forthcoming PG entrance examination while he/she is going through the curriculum. Hence, like in the previous edition, topic-wise MCQs from the last 10 years are given at the end of the chapters. Answers can be referred in the text which is given as superscripts. This will not only make the subject interesting, but also help the reader to get insight of that topic and prepare for viva-voce.

Question Bank I and II (Q-Bank) give a list of important questions, which the students should prepare for the professional examination and are based on the latest MBBS curriculum prepared by Directorate General of Health Services and Medical Council of India (MCI). There are two separate categories—must know and desirable to know, the student may prepare according to the time and can devote to the subject.

It is my hope that this edition of the book will find favorable response from medical students as earlier and also offer significant help to medical practitioners, in-service doctors and forensic scientists. It has been my endeavor to keep the book error-free, however, there may be some typographical errors. If the reader comes across any such error or wants to send any comment/suggestion, please do write or send an e-mail. It will be duly acknowledged in the subsequent edition.

Gautam Biswas

Preface to the First Edition

During my undergraduate days, I felt that textbooks should contain necessary information, not have too many details and should be understood easily, i.e. they should be comprehensive, clear and concise. Keeping this in mind, this book is written, especially for undergraduates and for those preparing for the PG entrance test. The entire concept of this book is to give information in as few words as possible without omitting necessary details.

Some topics (Identification, Injuries, Sexual Offences, Forensic Psychiatry and Toxicology) which are important from PG entrance point of view, are in more details. All topics are updated and recent advances/changes have been incorporated wherever needed.

Concise and lucid text (bullet's format), line-diagrams, boxes, tables, differentiations and flow charts given at appropriate places, are designed to make the book interesting-to-read, easy-to-comprehend, recollect and reproduce.

The information given in boxes is 'desirable to know', that a student may skip if there is shortage of time or if preparing for the professional examination. Rest of the information is 'must know', i.e. one should go through it definitely.

In section two (Toxicology), all the poisons are given in the same format throughout so that the student is able to understand and reproduce them during the examination. The section is up-to-date and some additional topics have been added for the PG entrance test.

Topic-wise MCQs are given at the end of most of the chapters. They are based on the recall of students who appeared in these exams, and will help the reader to get insight of that topic and prepare for the PG entrance. It will also make preparation for viva-voce easy and interesting for the student.

Appendices I and II give a list of important questions, which the students should prepare for the professional examination and are based on the latest MBBS curriculum prepared by Directorate General of Health Services and Medical Council of India (MCI). There are two categories—must know and desirable to know, the student may prepare according to the time and can devote to the subject.

It is my hope that this new book will find favorable response from medical students and also offer significant help to medical practitioners, in-service doctors and forensic scientists.

It has been my endeavor to keep the book error-free, however, there may be some typographical errors. If the reader comes across any such error or wants to send any comment/suggestion, please do write or send an e-mail. It will be duly acknowledged in the subsequent edition.

Gautam Biswas

Acknowledgments

I am deeply indebted to my teachers late Dr BBL Aggarwal, former Principal and Head; Professor NK Aggarwal, present Head; Professor SK Verma; Professor KK Bannerjee; Professor AK Tyagi, and Dr Anil Kohli, Department of Forensic Medicine, University College of Medical Sciences (UCMS) and Guru Teg Bahadur (GTB) Hospital, Delhi, India who taught me the art of Forensic Medicine and Toxicology.

I am grateful to Maj. Gen. (Dr) Ajit Singh, former Head of Forensic Medicine, Armed Forces Medical College (AFMC), Pune and Dayanand Medical College and Hospital (DMCH), Ludhiana for painstakingly proofreading the manuscript of first edition and suggesting changes wherever necessary.

I am highly grateful to Professor Praveen C Sobti of Pediatrics, DMCH for proofreading the text of first edition, fixing all the grammatical errors and advising sections that needed re-writing for clarity, despite having a very busy schedule and in a different specialty.

Professor Daljit Singh, Principal, DMCH, deserves special mention for his continuous inspiration and encouragement and invaluable suggestions.

I am thankful to Professor Jagjiv Sharma, Director-Principal, Chintpurni Medical College, Pathankot; Professor D Harish, Head, Department of Forensic Medicine, GMC, Chandigarh; Professor AU Sheikh (ASCOMS, Jammu); Professor SK Dhatarwal (PGI, Rohtak); Professor BR Sharma (Santosh Medical College, Ghaziabad), and Dr Gaurav Jain (Vardhman Mahavir Medical College, Safdarjung) for helping me with preparation of the manuscript and for their expert guidance.

I express my thanks to Dr Virender Pal Singh, Associate Professor, Department of Forensic Medicine, DMCH for his valuable suggestions and checking the manuscript whenever needed. He always remained helpful wherever I needed.

I also express my thanks to Professor B Khurana (SGRD, Amritsar); Dr A Chanana (GMC, Amritsar); Dr Parmod Goel (Adesh Institute of Medical Sciences); Dr Rajiv Joshi (GMC, Faridkot); Professor RK Bansal (SGRRMC, Dehradun); Professor Farida Noor (GMC, Srinagar); Professor Anju Gupta (Punjab Institute of Medical Sciences, Jalandhar), and Dr Pardeep Singh (People Medical College, Bhopal) for their valuable suggestions and encouragement.

I deeply appreciate the invaluable suggestions of some of the senior reputed professionals with whom I had lengthy academic communications, which helped me by discussions, exchange of views of the technical aspects of major parts of the book and resulted in thorough revision by inclusion of their viewpoints. The list includes Dr Anil Kohli, Reader, Department of Forensic Medicine, UCMS & GTB Hospital, Delhi whose immeasurable help and wisdom can never be appropriately or adequately acknowledged and contributed to my book in spite of busy schedules in work place; Dr Anil Aggrawal, Director-Professor, Department of Forensic Medicine and Toxicology, Maulana Azad Medical College, New Delhi, and Professor Bhupesh Khajuria, Head, Department of Forensic Medicine, GMC, Jammu for their inspiration, constant encouragement, critical analysis of the text and suggesting modifications wherever required.

I wish to express my solemn sentiments and sincere gratitude to all the authors and researchers of various textbooks and journals articles which was referred to, while preparing the manuscript of the book without which the scientific base of facts mentioned would not have been possible.

It will be an injustice if I do not thank all my students, especially Nipun Bansal and Harnoor Bhardwaj for their innovative ideas and feedback. I am grateful to Mr Ramesh Kumar for typing part of the manuscript and helping me with whatever work assigned to him during the entire process of preparing the manuscript.

I am especially grateful to all those working for M/s Jaypee Brothers Medical Publishers (P) Ltd, New Delhi, India, in particular Shri Jitendar P Vij (Chairman and Managing Director), Mr Tarun Duneja (Director-Publishing) and Ms Sunita Katla (Publishing Manager). Ankush Sharma and Rajesh Gurkundi (Graphic Designers) for making such beautiful line diagrams, Ms Seema Dogra for cover design, Mr Laxmidhar Padhiary for proofreading and Ms Uma Adhikari for shaping up of this book and making all the changes whenever I suggested, without any complaints. I gratefully acknowledge the assistance by this professional team.

I express my gratitude to my parents and in-laws for their constant encouragement, support and blessings. Above all, I acknowledge with gratitude the support of my wife Anupama and my son to bear with patience and calm encouragement during the long hours of my involvement with the manuscript. I want to thank Anupama for her untiring support, resilience and cooperativeness in writing this book.

Last but not least, I wish to offer my apologies to all my colleagues and friends whose name has been omitted inadvertently, for without their constant support, encouragement and well-wishes, the book would not have been completed.

Contents

Section One

Jurisprudence and Forensic Medicine

1. Medical Jurisprudence and Ethics 3	
Medical Council of India (MCI) 3	
Functions of MCI 4	
State Medical Council (SMC) 4	
Duties of a Doctor 5	
Privileged Communication 8	
Medical Malpractice 9	
Unethical Acts 10	
Professional Misconduct (Infamous Conduct) 10	
Erasure of Name 11	
Red Cross Emblem 12	
Types of Physician-Patient Relationship 12	
Professional Negligence 13	
Preventing Medical Litigation 14	
Defenses Against Negligence 16	
Doctrine of Res Ipsa Loquitur 16	
Calculated Risk Doctrine 16	
Doctrine of Common Knowledge 17	
Doctrine of Avoidable Consequence Rule 17	
Medical Maloccurrence 17	
Novus Actus Interveniens 17	
Contributory Negligence 17	
Therapeutic Misadventure/Hazard 17	
Vicarious Liability/Respondeat Superior 18	
Corporate Negligence 18	
Products Liability 18	
Consent 19	
Medical Records 21	
Malingering (Shamming) 21	
Euthanasia (Mercy Killing) 22	
2. Acts Related to Medical Practice 25	
The Transplantation of Human Organs Act, 1994 25	
The Consumer Protection Act, 1986 (CPA) 26	
The Workmen's Compensation Act, 1923 28	
The Medical Termination of Pregnancy (MTP) Act, 1971 28	
The Prenatal Diagnostic Techniques (PNDT) Act, 1994 29	
The Mental Health Act, 1987 31	
3. Legal Procedure 34	
Inquest 34	
Police Inquest 35	
Magistrate Inquest 35	
Courts of Law 36	
Subpoena or Summons 38	
Conduct Money 38	
Medical Evidence 38	
Types of Witness 40	
Recording of Evidence 41	
Conduct and Duties of a Doctor in the Witness Box 42	
4. Identification I 45	
Corpus Delicti 45	
Race and Religion 45	
Sex 47	
Nuclear Sexing 47	
Intersex 48	
Sex from Skeletal Remains 51	
Age 55	
Age from Ossification of Bones 58	
Age Determination in Adults Over 25 Years 60	
Medico-legal Importance of Age 62	
Stature 62	
Scars 64	
Tattoo Marks 65	
5. Identification II 70	
Anthropometry (Bertillon System) 70	
Dactylography (Dactyloscopy) 70	
Poroscopy 73	
Lip Prints (Cheiloscopy) 74	
Hair 74	
Superimposition 78	
Forensic Odontology 78	
Miscellaneous Methods of Identification 80	
6. Medico-legal Autopsy 83	
Purpose/Objectives of Autopsy 83	
Procedure for Medico-legal Autopsies 84	
Instruments for Autopsy Examination 84	
External Examination 84	
Internal Examination 87	
Skin Incisions 87	
Evisceration Methods 87	
Examination Proper 88	

Chest	89		
Heart	90		
Neck	92		
Skull and Brain	92		
Description of an Organ	94		
Report	94		
Demonstration of Pneumothorax	95		
Demonstration of Air Embolus	95		
Collection of Samples	96		
Preservation of Viscera	96		
Preservation of Samples	97		
Samples for Laboratory Investigations	98		
Obscure and Negative Autopsy	99		
Second Autopsy	99		
Examination of Decomposed, Mutilated and Skeletonized Remains	99		
Exhumation	101		
7. Autopsy Room Hazards	104		
Commonly Acquired Infections	104		
Autopsy of HIV Positive and HBV Patients	104		
Autopsy and Disposal of Radioactive Corpse	106		
8. Thanatology	107		
Brain/Brainstem Death	107		
Cause, Mechanism and Manner of Death	109		
Cause of Death	110		
Modes of Death (Proximate Causes of Death)	110		
Anoxia	111		
Sudden Death	112		
Coronary Atherosclerosis	113		
9. Signs of Death	117		
Immediate Changes (Somatic Death)	117		
Suspended Animation (Apparent Death)	118		
Early Changes (Molecular Death)	118		
Cooling of the Dead Body	119		
Postmortem Staining	120		
Rigor Mortis	123		
Cadaveric Spasm	125		
Heat Stiffening	125		
Cold Stiffening	126		
Decomposition/Putrefaction	127		
Decomposition of Submerged Body	130		
Floatation of a Dead Body on Water	130		
Entomology	130		
Adipocere (Saponification)	131		
Mummification	132		
Estimation of Time Since Death (TSD) or Postmortem Interval (PMI)	132		
Preservation of Dead Bodies	135		
Presumption of Survivorship	135		
Presumption of Death	135		
10. Asphyxia	138		
Pathophysiology of Asphyxia	138		
Etiology of Asphyxia	138		
Clinical Effects of Asphyxia	139		
Hanging	140		
Autopsy of Neck (Asphyxial Deaths)	141		
Postmortem Findings in Hanging	142		
Medico-legal Questions	144		
Lynching	144		
Judicial Hanging	145		
Strangulation	145		
Ligature Strangulation	146		
Postmortem Examination	146		
Medico-legal Questions	147		
Throttling or Manual Strangulation	147		
Postmortem Examination	148		
Medico-legal Questions	150		
Hyoid Bone Fractures	150		
Suffocation	151		
Café-coronary	152		
Drowning	154		
Postmortem Examination	157		
Medico-legal Questions	161		
Hyperventilation Deaths	161		
Sexual Asphyxia (Autoerotic Asphyxia/Hypoxyphilia, Asphyxiophilia)	162		
11. Injuries	165		
Classification of Wounds/Injuries	165		
Abrasion	166		
Bruise/Contusion	168		
Lacerated Wound	172		
Incised Wound	174		
Chop Wounds	176		
Stab Wound	176		
Defense Wounds	180		
Therapeutic or Diagnostic Wounds	180		
Fabricated Wounds (Fictitious/Forged Wounds)	180		
12. Firearm Injuries	183		
Classification of Firearms	183		
Rifled Firearms	183		
Smooth Bore Firearms/Shotguns	184		
Bore (Gauge/Calibre)	185		
Bullet	186		
Cartridge	187		
Gunpowders (Propellant Charge)	188		
Mechanism of Discharge of Projectile	189		
Wound Ballistics and Mechanism of Injury	189		
Firearm Wounds	190		
Characteristics of Shotgun Wounds	191		
Characteristics of Rifled Firearms Wounds	192		
Firearm Wounds on Skull	194		
Exit Wounds	194		

Peculiar Effects of Firearms	195
Postmortem Examination	196
Preservation and Marking of Exhibits	197
13. Regional Injuries	204
Craniocerebral Injuries	204
Soft Tissue Injury	204
Skull Fractures	205
Coup and Contre-coup Injury	208
Brain Injury	209
Cerebral Concussion	209
Diffuse Axonal Injury (DAI)	210
Cerebral Contusion and Laceration	211
Intracranial Hematoma	212
Extradural/Epidural Hematoma (EDH)	213
Subdural Hematoma (SDH)	214
Subarachnoid Hematoma (SAH)	216
Intracerebral Hematoma (ICH)	218
Diffuse Injury to the Brain	219
Spinal Cord	221
Neck	222
Vertebral Column	222
Chest	223
Lungs	223
Heart	223
Abdomen	224
Kidneys	225
Bones and Joints	226
14. Thermal Injuries	232
Cold Injury	232
Heat Injury	234
Heat Hyperpyrexia or Heat Stroke	234
Burns	236
Postmortem Examination	238
Medico-legal Questions	241
Scalds	242
Electrical Injuries (Electrocution)	243
Judicial Electrocution	246
Lightning Stroke	246
15. Transportation Injuries	249
Pedestrian Injuries	249
Injuries Sustained by Vehicle Occupants	252
Role of Seat Belts and Air Bags	253
Motorcycle and Cycle Injuries	254
Postmortem Examination	254
Alcohol, Drugs and Trauma	255
Railway Injuries	255
16. Explosion Injuries and Fall from Height ..	257
Explosion Injuries	257
Mechanism of Action	257
Classification of Injuries	257
Medico-legal Aspects	259
Fall from Height	259
Injury Patterns	260
17. Medico-legal Aspects of Injuries	263
Simple Hurt/Injury	264
Grievous Hurt/Injury	264
Punishments	265
Cause of Death from Wounds	265
Medico-legal Questions	269
Injury Report	272
18. Decompression, Radiation and Altitude Sickness	276
Decompression Sickness	276
Autopsy in Decompression Sickness	276
Ionizing Radiation Reactions	276
Altitude Illness	278
19. Starvation Deaths	279
Mode of Starvation	279
Pathophysiology	279
Signs and Symptoms	279
Postmortem Findings	280
Medico-legal Questions	280
20. Infanticide and Child Abuse	282
Postmortem Examination of Infants	282
Age of Fetus	283
Rule of Hasse	285
Demonstration of Centres of Ossification	285
Features of Dead-Born Fetus	285
Signs of Live Birth	286
Postmortem Examination	286
Infant Death	289
Battered Baby Syndrome (Caffey/Maltreatment Syndrome)	290
Sudden Infant Death Syndrome (SIDS, Cot Death or Crib Death)	293
21. Anesthetic Deaths	296
Death during Administration of Anesthesia	296
Deaths Directly Related to Administration of an Anesthetic	296
Postmortem Examination	297
22. Abortion	299
Classification of Abortion	299
Criminal Abortion	300
Complications of Criminal Abortion	302
Duties of a Doctor in Suspected Criminal Abortion	303
Examination of a Woman with Alleged History of Abortion	303
Postmortem Examination	304
Trauma and Abortion	304
23. Impotence and Sterility	306
Causes of Impotence and Sterility in Males	306
Causes of Impotence and Sterility in Females	307

Examination of a Person in an Alleged Case of Impotence and Sterility	307
Sterilization	308
Artificial Insemination (AI)	310
Surrogate Mother	312
24. Virginity, Pregnancy and Delivery	313
Normal Female Anatomy (in Virgins)	313
Medico-legal Aspects	314
Presumptive Signs/Symptoms	315
Probable Signs of Pregnancy	316
Positive/Conclusive Signs of Pregnancy	318
Pseudocyesis (Spurious/False/Phantom Pregnancy)	319
Superfecundation	319
Superfetation	319
Legitimacy and Paternity	319
Signs and Symptoms of Recent Delivery in Living	320
Signs of Remote Delivery in Living	321
Medico-legal Aspects of Pregnancy and Delivery	321
Nullity of Marriage and Divorce	322
25. Natural Sexual Offences	325
Rape	325
Duties of a Doctor in case of an Alleged Victim of Rape	328
Examination of the Rape Victim	328
Examination	329
Corroborative Signs of Rape	333
Rape on Deflorate/Sexually Active Woman	334
Rape on Children	334
Medico-legal Questions	336
Rape Trauma Syndrome	336
Examination of Rape Accused	337
Incest	338
Adultery	338
26. Unnatural Sexual Offences	340
Sodomy	340
Examination of Passive Agent of Sodomy	340
Opinion	342
Examination of Active Agent of Sodomy	342
Tribadism/Lesbianism	343
Bestiality (Zoophilia)	343
Buccal Coitus	343
27. Sexual Perversions/Deviations	345
Sadism (Algolagnia)	345
Masochism (Passive Algolagnia)	345
Transvestic Fetishism (Eonism)	346
Voyeurism (Scotophilia)	346
Exhibitionism	346
Fetishism	346
Frotteurism (Toucherism)	347
Pedophilia	347
Masturbation (Onanism)	347
Indecent Assault	348
28. Postmortem Artifacts	349
Artifacts due to Postmortem Changes	349
Third Party Artifacts	350
Environmental Artifacts	351
Other Artifacts	352
29. Forensic Psychiatry	353
Delusion	353
Hallucination	354
Illusion	354
Impulse	354
Obsession	355
Lucid Interval	355
Role of Forensic Psychiatrist	356
Psychiatric Assessment	357
Classification of Mental and Behavioral Disorders	358
Organic Mental Disorders	358
Schizophrenia	359
Mood (Affective) Disorders	361
Neurotic and Somatoform Disorders	361
Behavioral Syndromes	363
Mental Retardation	363
Mental Disorder and Responsibility	364
30. Bloodstain Analysis	371
Bloodstain Pattern Analysis	371
Presumptive Tests for Blood	371
Confirmatory Tests for Blood	373
Species Identification	374
Genetic Markers in Blood	375
Medico-legal Application of Blood (Groups)	376
31. Seminal Stain and Other Biological Samples	380
Purpose of Seminal Identification	380
Examination of Seminal Stains	380
Confirmatory Tests	382
Identification of Species Origin	383
Individualization of Seminal Stains	384
Identification of Biological Samples and Body Fluids	384
32. DNA Fingerprinting	386
RFLP	386
PCR	388
Specimen Selection and Preservation	390
Uses of DNA Fingerprinting	390
Limitations of DNA Testing	391
33. Torture and Custodial Deaths	393
Types of Torture	393
Medical Practitioner and Torture	395
Custodial Deaths	396

34. Medico-legal Aspects of HIV 397	35. Newer Techniques and Recent Advances 400
HIV Testing Policy 397	Polygraph 400
Health Care Workers and HIV Infection 397	Brain Fingerprinting (Brain Mapping) 400
Partner Notification 398	Narco-Analysis 401
Clinical Trials and HIV 399	<i>Question Bank—I</i> 403
Blood Donation and HIV 399	

Section Two

Toxicology

36. General Toxicology 411	41. Inorganic Metallic Irritants—Copper 446
Medico-legal Aspects of Poisons 411	Signs and Symptoms (Acute Poisoning) 446
Classification of Poisons 412	Treatment 447
Factors Modifying the Action of Poisons 413	Postmortem Findings 447
Diagnosis of Poisoning in Living 413	Chronic Copper Poisoning 447
Diagnosis of Poisoning in Dead 414	42. Inorganic Metallic Irritants—Thallium 449
Failure to Detect Poison 416	Signs and Symptoms 449
Duties of a Doctor in a Case of Suspected Poisoning 416	Treatment 449
Management of Poisoning Cases 417	Postmortem Findings 450
Removal of Unabsorbed Poison 418	43. Other Inorganic Metallic Irritants 451
Administration of Antidotes 420	Cadmium 451
Elimination of Poison by Excretion 421	Barium 452
Samples Preserved for Toxicological Analysis 422	Zinc 452
37. Corrosive Poisons 427	Metal Fume Fever (MFF) 453
Mineral Acids 427	Methemoglobinemia Inducing Agents 453
Vitriolage (Vitriol Throwing) 428	44. Non-metallic and Mechanical Irritants 455
Oxalic Acid (Acid of Sugar) 429	Phosphorus 455
Carbolic Acid (Phenol) 430	Chronic Phosphorus Poisoning 456
Strong Alkalis (Caustic Alkalis) 431	Mechanical Irritants 456
38. Inorganic Metallic Irritants—Arsenic 433	45. Organic Irritants—Vegetable 458
Signs and Symptoms (Acute Poisoning) 433	Ricinus Communis (Castor) 458
Treatment 434	Croton Tiglium (Jamalgota) 459
Postmortem Findings 435	Abrus Precatorius (Rati, Gunchi, Jequirity) 459
Chronic Arsenic Poisoning 435	Suis 460
Postmortem Imbibition of Arsenic 436	Semecarpus Anacardium 460
39. Inorganic Metallic Irritants—Mercury 438	Capsicum Annum 461
Signs and Symptoms (Acute Poisoning) 438	Calotropis ('Rubber Bush') 461
Treatment 439	Ergot 462
Postmortem Findings 439	46. Organic Irritants—Animal 464
Chronic Mercury Poisoning (Hydrargyris) 439	Snakes 464
40. Inorganic Metallic Irritants—Lead 441	Signs and Symptoms of Ophitoxemia 467
Chronic Lead Poisoning (Plumbism/Saturnism) 442	Management 469
Signs and Symptoms 442	Postmortem Findings 471
Treatment 444	Medico-legal Aspects 472
Postmortem Findings 445	Cantharides (Spanish Fly) 472
	Scorpions 472
	Bees and Wasps 473

- 47. Somniferous Poisons (Narcotic Poisons) .. 475**
 Opium 475
 Signs and Symptoms 476
 Treatment 476
 Postmortem Findings 477
 Body Packers 477
 Chasing the Dragon 477
 Chronic Morphine Poisoning (Morphinism) 478
 Fentanyl 478
- 48. Inebriants—Alcohol 479**
 Signs and Symptoms (Acute Poisoning) 481
 Treatment 482
 Postmortem Findings 482
 Medico-legal Aspects 482
 Chronic Alcoholism (Systemic Effects) 482
 Delirium Tremens 483
 Alcoholic Hallucinosis 484
 Wernicke's Encephalopathy 484
 Korsakoff's Psychosis 484
 Drunkenness 485
 Diagnosing a Case of Drunkenness 485
 Laboratory Investigations 486
 Collection of Samples in Living 487
 Methyl Alcohol (Methanol) 488
 Isopropyl Alcohol 490
 Ethylene Glycol 490
- 49. Barbiturates 493**
 Signs and Symptoms 493
 Management 494
 Treatment 494
 Postmortem Findings 494
 Barbiturate Automatism (Self-poisoning) 495
- 50. Deliriant—Dhatura/Datura 496**
 Dhatura/Datura 496
 Signs and Symptoms 496
 Treatment 497
 Postmortem Findings 497
- 51. Deliriant—Cannabis 499**
 Signs and Symptoms 499
 Treatment 500
 Run-amok 500
- 52. Deliriant—Cocaine 501**
 Signs and Symptoms 501
 Treatment 502
 Cocainism (Cocainomania/Cocainophagia) 502
 Magnan's Syndrome/Cocaine Bugs 503
- 53. Spinal and Peripheral Nerve Poisons 504**
 Strychnos Nux-vomica (Kuchila) 504
 Curare 506
 Conium Maculatum (Hemlock) 506
- 54. Cardiac Poisons 507**
 Aconite (Monk's Hood, Mitha Zaher, Bish) 507
 Nicotiana Tabacum (Tobacco) 508
 Digitalis Purpurea (Foxglove) 508
 Nerium Odorum (White Oleander, Kaner) 509
 Cerbera Thevetia (Yellow Oleander, Pila Kaner) 510
 Quinine 510
- 55. Hydrocyanic Acid 512**
 Signs and Symptoms 512
 Treatment 513
 Postmortem Findings 514
 Judicial Execution 514
- 56. Asphyxiants 516**
 Carbon Monoxide (CO) 516
 Carbon Dioxide (CO₂) 518
 Hydrogen Sulphide (H₂S) 518
- 57. War Gases and Biological Weapons 521**
 War Gases 521
 Types of Chemical Warfare Agents (CWAs) 521
 Biological Weapons 522
 Types of Biological Warfare Agents 522
- 58. Agricultural Poisons 525**
 Organophosphorus Compounds (OPCs) 525
 Signs and Symptoms 526
 Treatment 527
 Postmortem Findings 529
 Endrin 530
 Naphthalene 531
 Paraquat 531
 Pyrethrins and Pyrethroids 532
- 59. Alphas (Aluminum Phosphide) 534**
 Signs and Symptoms 534
 Treatment 535
 Postmortem Findings 536
- 60. Medicinal Poisons 538**
 Paracetamol (Acetaminophen) 538
 Iron 539
 Antipsychotic Drugs (Tranquillizers) 539
 Antihistaminics 540
 Tricyclic Antidepressants (TCAs) 541
 Benzodiazepines 541
 Acetylsalicylic Acid (Aspirin) 542
 Chloral Hydrate 543
- 61. Drug Dependence 545**
 Patterns of Drug Use Disorders 545
 DSM-IV Criteria for Diagnosis of Substance
 Dependence 546
 Psychoactive Substances 546

Complications of Drug Abuse	549	Lathyrus Sativus ('Kesari Dhal')	555
Postmortem Findings	550	Mushrooms	556
62. Kerosene Oil Poisoning	552	Argemone Mexicana (Prickly Poppy)	556
Signs and Symptoms	552	<i>Question Bank—II</i>	<i>558</i>
Treatment	553	<i>Index</i>	<i>561</i>
Postmortem Findings	553		
63. Food Poisoning	554		
Bacterial Food Poisoning	554		
Botulism (Allantiasis)	555		

Superscripts in the text refer to answers of the MCQs given at the end of the chapters.

History

Forensic Medicine has Humble and Ancient Origins

- Law-medicine problems are found written in records in Egypt, Sumer, Babylon, India and China dating 4000-3000 BC.
- Manu (3102 BC) was the first traditional king and lawgiver in India. Manusmriti was a famous treatise where rules for marriage, punishment for adultery, incest and sexual offences were formulated.
- Code of Hammurabi specified by King of Babylon (about 2200 BC) is the oldest known medico-legal code.
- Hippocrates (460-377 BC), Father of Western medicine discussed the lethality of wounds and contributed to the field of ethics.
- First descriptions of examination of injuries were found carved on pieces of bamboo dating back to the Qin dynasty in China, from about 220 BC.
- First medico-legal autopsy in history was conducted by the Roman physician Antistius who examined the body of Julius Caesar after his assassination in 44 BC.
- Agnivesa Charaka Samhita was the first treatise on Indian medicine which dates back to 7th BC.
- Shusruta, Father of Indian Surgery gave the Shusruta Samhita in 200-300 AD.
- During the 6th century, Justinian law called medico-legal experts to testify in cases of rape, criminal abortion and murder.
- Chinese publication in the 13th century titled 'Hsi Yuan Lu' or 'Instructions to the Coroner' dealt with findings in cases of infanticide, drowning, hanging, poisoning and assault.
- In Germany, during the 16th century, the code of Bamberg brought about a requirement for medical testimony in forensic cases. This code also allowed the opening of bodies to examine the depth of and damage caused by wounds.
- In 1602, first book on forensic medicine was published by Italian physician, Fortunato Fedele.
- The first recorded medico-legal autopsy performed in India was by Dr Edward Bulkley in 1693 at Chennai on a suspected case of arsenic poisoning.
- The first publication on forensic medicine in UK was by William Hunter in the 18th century. His essays were on injuries found on murdered bastard children.
- In the 18th century, Italian anatomist Giovanni Morgagni (1682-1771) dissected the bodies of the dead and compared the alterations in their organs with the symptoms of the diseases that had caused death. He published a book in 1761 on 640 postmortem he had conducted.
- The three great pioneers of forensic medicine born in the 18th century were Johann Casper (1796-1864), Mathieu Orfila (1787-1853) and Marie Devergie (1798-1879). They devoted their life in the study and development of forensic medicine as we understand it today.
- Dr CTO Woodford is regarded as the first Professor of Medical Jurisprudence in India.

Plate 1

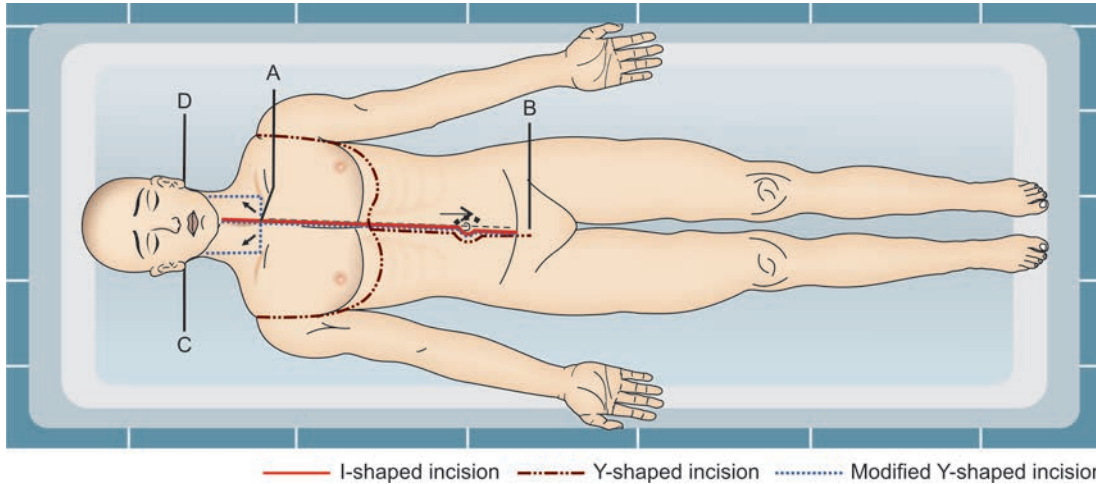

Fig. 6.2: Incision for opening thoracic and abdominal cavities (A) Sternal notch (B) Symphysis pubis (C) Right mastoid process (D) Left mastoid process

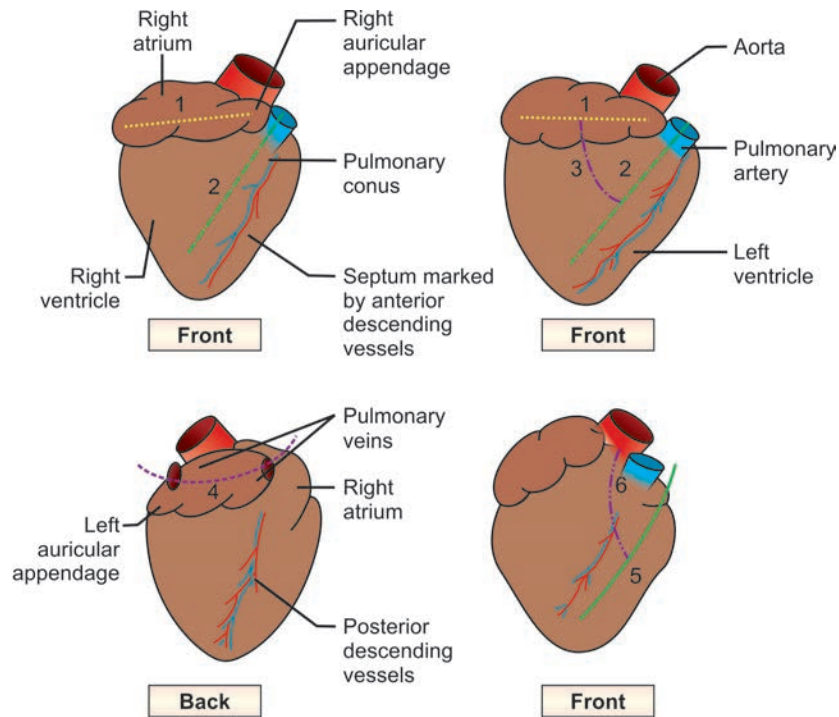

Fig. 6.4: Opening of the heart at autopsy

- Incision 1—Through right atrium
- Incision 2—On the anterior wall of right ventricle parallel to interventricular septum
- Incision 3—Through tricuspid valve
- Incision 4—Through left atrium (after reversing the heart)
- Incision 5—Through mitral valve, parallel to the septum (on anterior wall)
- Incision 6—Through aortic valve

Plate 2

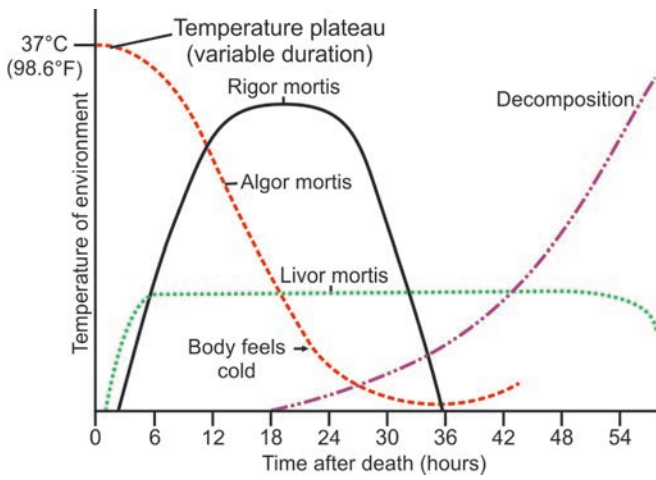

Fig. 9.1: Estimation of time since death

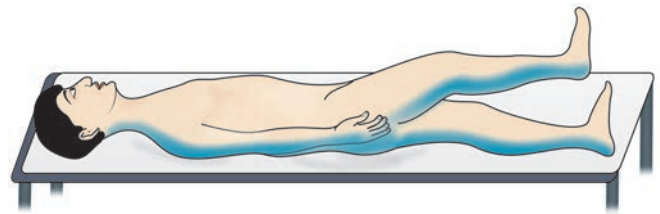

Fig. 9.2: Postmortem staining in dependent parts



Fig. 9.5: 'Marbling' of the skin of lower limbs

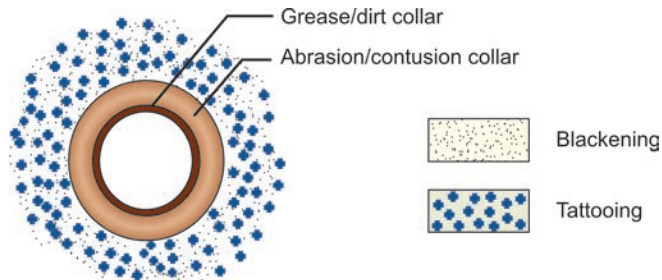

Fig. 12.14: Close shot entry wound of a bullet

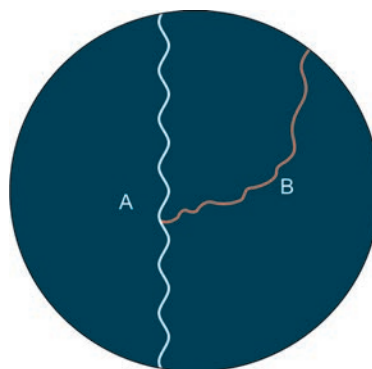

Fig. 12.17: Puppe's rule (A) First (initial) fracture (B) Subsequent (later) fracture

Plate 3

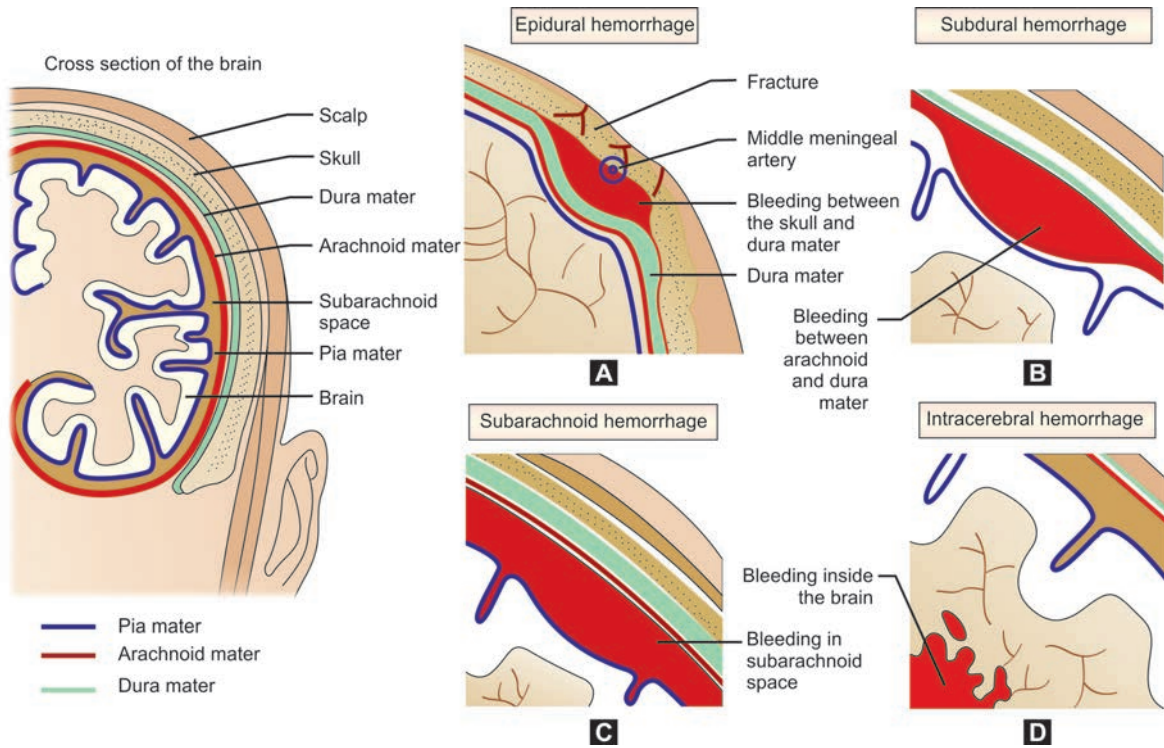

Fig. 13.8: Intracranial hematomas

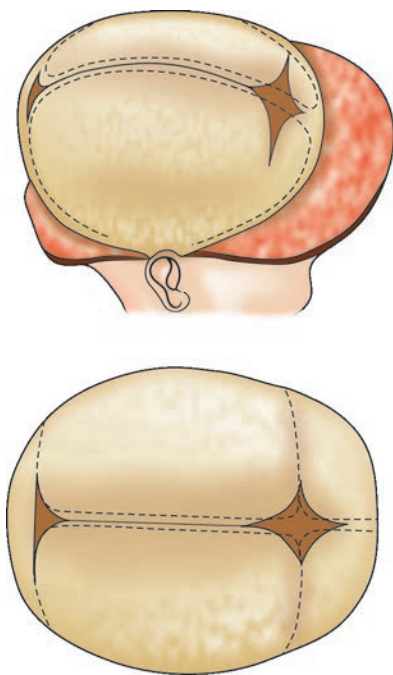

Fig. 20.1: Two methods of opening the calvarium in fetus and neonate (A) Beneke's technique (B) Reflection of cranial bones along the suture lines

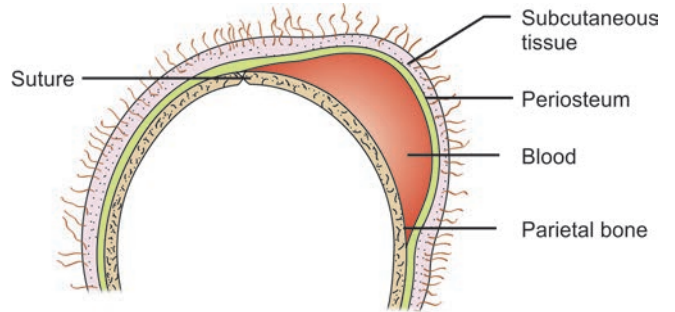

Fig. 20.3: Cephalhematoma

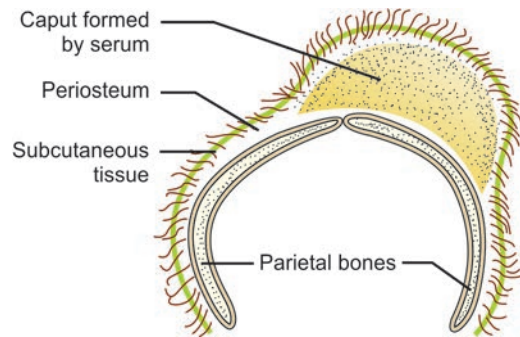

Fig. 20.4: Caput succedaneum

Plate 4

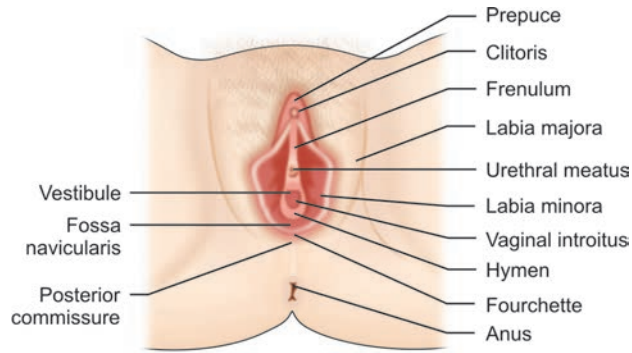

Fig. 24.1: Normal female genitalia (Vulva)

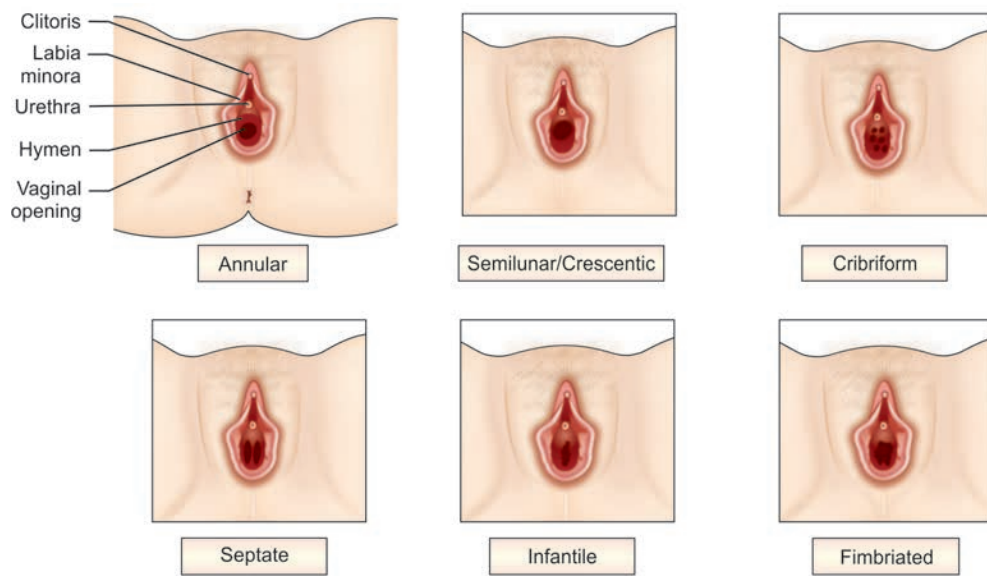

Fig. 24.2: Types of hymen

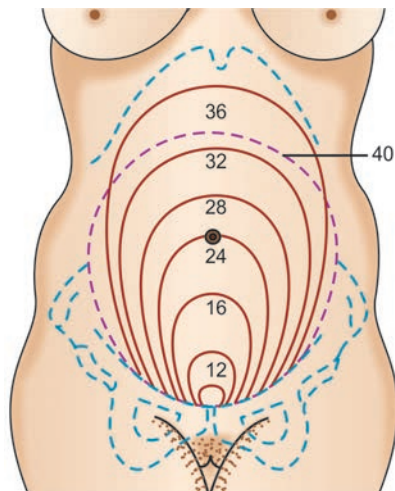

Fig. 24.3: The level of fundus uteri at different weeks

Plate 5

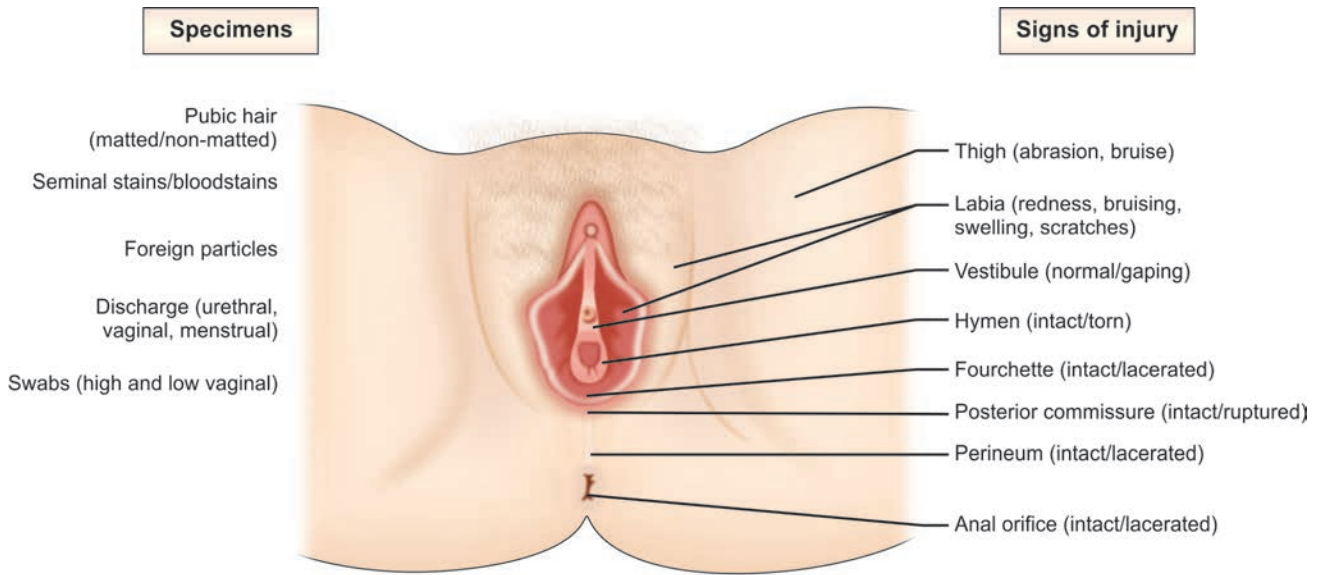

Fig. 25.3: Local examination and specimens to be preserved in a victim of rape

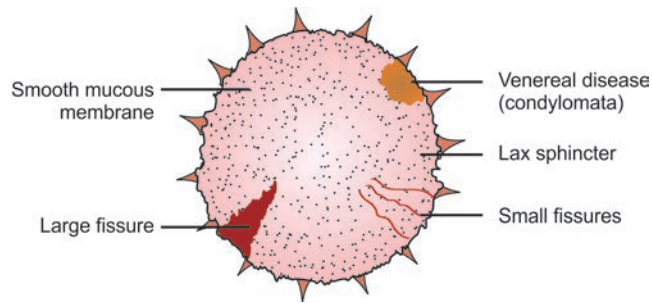

Fig. 26.2: Findings in a habitual passive agent of sodomy

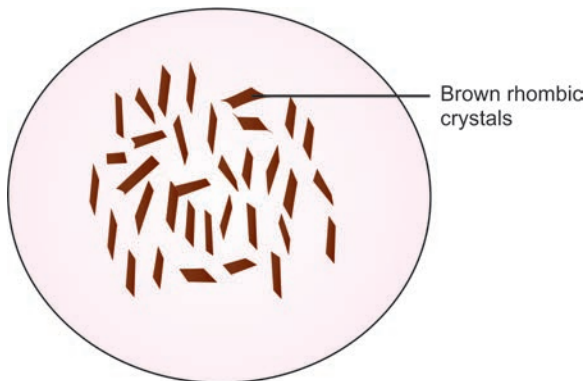

Fig. 30.4: Teichmann test (hemin crystals)

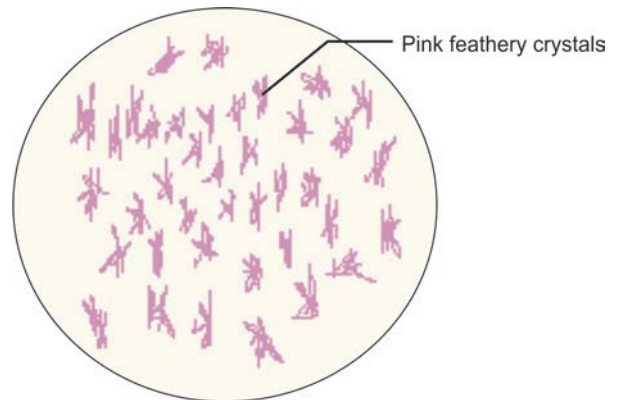

Fig. 30.5: Takayama test (hemochromogen crystals)

Plate 6

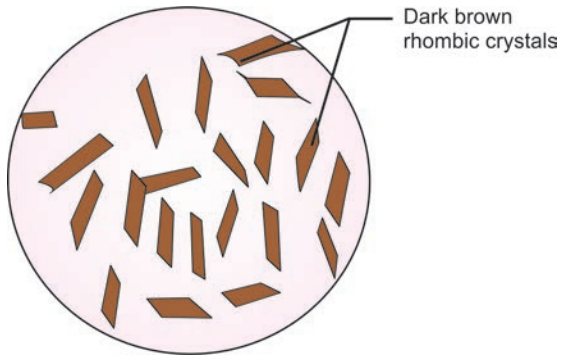

Fig. 31.1: Florence test (choline iodide crystals)

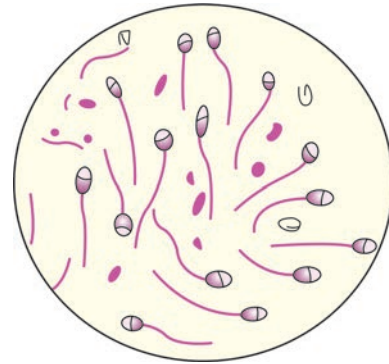

Fig. 31.3: Spermatozoa under light microscope

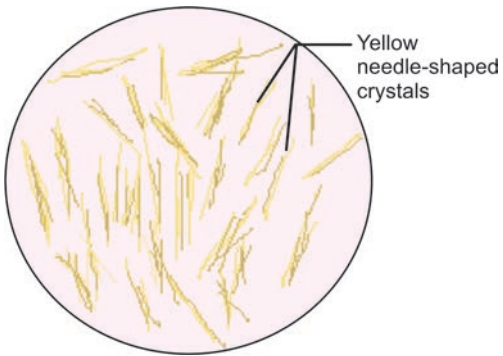

Fig. 31.2: Barberio's test (spermine picrate crystals)

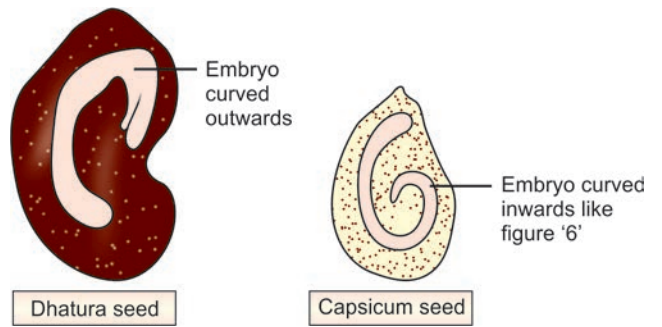

Fig. 50.1: Longitudinal section of dhatura and capsicum seed

Section One



Jurisprudence and Forensic Medicine

1. Medical Jurisprudence and Ethics	3	19. Starvation Deaths	279
2. Acts Related to Medical Practice	25	20. Infanticide and Child Abuse	282
3. Legal Procedure	34	21. Anesthetic Deaths	296
4. Identification I	45	22. Abortion	299
5. Identification II	70	23. Impotence and Sterility	306
6. Medico-legal Autopsy	83	24. Virginity, Pregnancy and Delivery	313
7. Autopsy Room Hazards	104	25. Natural Sexual Offences	325
8. Thanatology	107	26. Unnatural Sexual Offences	340
9. Signs of Death	117	27. Sexual Perversions/Deviations	345
10. Asphyxia	138	28. Postmortem Artifacts	349
11. Injuries	165	29. Forensic Psychiatry	353
12. Firearm Injuries	183	30. Bloodstain Analysis	371
13. Regional Injuries	204	31. Seminal Stains and Other Biological Samples	380
14. Thermal Injuries	232	32. DNA Fingerprinting	386
15. Transportation Injuries	249	33. Torture and Custodial Deaths	393
16. Explosion Injuries and Fall from Height	257	34. Medico-legal Aspects of HIV	397
17. Medico-legal Aspects of Injuries	263	35. Newer Techniques and Recent Advances	400
18. Decompression, Radiation and Altitude Sickness	276		

Medical Jurisprudence and Ethics

1

Definitions

- **Forensic medicine*** (Legal medicine or State medicine): It is the *application of principle and knowledge of medical sciences* to legal purposes and legal proceedings so as to aid in the administration of justice.
- **Medical jurisprudence** (Latin *juris*: law, *prudencia*: knowledge or skill): It is the *application of knowledge of law* in relation to practice of medicine. It includes:
 - i. Doctor-patient relationship
 - ii. Doctor-doctor relationship
 - iii. Doctor-State relationship.
- **Medical etiquette**: These are the *conventional laws and customs of courtesy* which are followed between members of same profession.¹ A doctor should behave with his colleagues, as he would like to have them behave with him, e.g. he should not charge another doctor or members of his family for professional service.
- **Medical ethics**: It is concerned with *moral principles* for the members of the medical profession in their dealings with each other, their patients and the state. It is a self-imposed code of conduct assumed voluntarily by medical professionals.

Forensic science refers to a group of scientific disciplines which are concerned with the application of their particular scientific area of expertise to law enforcement, criminal, civil, legal and judicial matters. Forensic scientists examine objects, substances (including blood/drug samples), chemicals (paints/explosives/toxins), tissue traces (hair/skin) or impressions (fingerprints/tyre marks) left at the scene of crime—a *multidisciplinary subject*.

Medical Council of India (MCI)

The **Medical Council of India** is a statutory body charged with the responsibility of establishing and maintaining uniform standards of medical education and recognition of medical qualifications.

Indian Medical Degrees Act, 1916: This Act was passed to regulate the grant of titles implying qualification in Western Medical Science.

* Latin *forensis*: of or before the forum. In Rome, 'forum' was the meeting place, where civic and legal matters used to be discussed by those with public responsibility

The Indian Medical Council (IMC) Act, 1956: The Medical Council of India was established in 1934 under the Indian Medical Council Act, 1933. In 1956, the old Act was repealed and a new one was enacted. This was further modified in 1964, 1993 and 2001. Recently, the IMC (Amendment) Act, 2010 was approved by the President of India, superseding the previous Council. The Central Government constituted the board of governors (comprising of not more than seven members) with one of them as chairperson till the new council is elected (time frame given is of 2 years).

Constitution of IMC

- i. One member from each state other than a Union Territory, nominated by the Central Government in consultation with the State government concerned.
- ii. One member from each university, to be elected from amongst the members of the medical faculty of the university.
- iii. One member from each state in which a State Medical Register is maintained, to be elected from persons enrolled on such a register.
- iv. Seven members to be elected by persons enrolled in any of the State Medical Registers.
- v. Eight members are nominated by the Central Government.

The President and Vice-President are elected from amongst these members. They hold office for a term of 5 years.

Schedules

- **First Schedule** of the IMC Act contains recognized medical qualifications granted by universities in India.² Any medical Institution which grants a qualification not included in the First Schedule may apply to the Central Government and after consulting the Council may amend the First Schedule, and the same is entered in the last column of the First Schedule.
- **Second Schedule** contains recognized medical qualifications granted outside India.³ The Council may

enter into negotiations with the Authority in any country outside India for the scheme of reciprocity for the recognition of medical qualifications and the Central Government may amend the Second Schedule, and the same is entered in the last column of the Second Schedule.

- **Part I of the 3rd Schedule** contains qualification granted by medical institutions not included in 1st Schedule.
- **Part II of the 3rd Schedule** contains qualification granted outside India, but not included in 2nd schedule.

The Council should:

- Constitute an Executive Committee from amongst its members.
- Appoint a Registrar who will act as Secretary and who may also act as Treasurer.

Functions of MCI

i. Maintenance of Indian Medical Register

- It contains the names, addresses and qualifications of the medical practitioners who are registered with any State Medical Council.
- Removal of the name from the register of the concerned State Medical Council will lead to its removal from Indian Medical Register.

ii. Regulation of standard of undergraduate and postgraduate medical education

- The Council *maintains the standards of undergraduate medical education*. The Council prescribes courses and criteria which a medical institute should fulfill for a particular course of study.
- The Council sends inspectors to see that the college is adequately spaced, staffed and equipped as per MCI stipulations. The inspector may also visit the institution during the examinations to assess the standard of education.
- On the basis of the reports of the inspectors, the MCI recommends the recognition or non-recognition of the medical qualification to the Central Government.
- Such an inspection is held for every medical qualification when it is introduced and every 5 years thereafter.
- The Council has the authority to *prescribe standards of postgraduate medical education* for the guidance of the universities.

iii. Permission for establishment of new medical college, new course of study and increase in seats:

It requires the permission of the Central Government obtained after the recommendations of the Council which may either approve or disapprove the scheme.

iv. **Recognition of medical qualification granted by universities in India:** Any university which grants a medical qualification not included in the 1st Schedule may apply to the Central Government, to have such qualification recognized, and the Central Government, after consulting the Council, may amend the 1st Schedule.

v. **De-recognition of medical qualification:** It can make representation to the Central Government to withdraw recognition of a medical qualification of any college, if on receipt of report from inspectors it feels that the standards of resources, training/teaching are not satisfactory.

vi. **Recognition of foreign medical qualifications under the scheme of reciprocity:** The Council may enter into negotiations with the authority in any country outside India under a scheme of reciprocity for the recognition of medical qualifications.

vii. **Appellate powers:** It advises the Central Health Ministry when an appeal is made by a medical practitioner against the decision of the State Medical Council on disciplinary matters.

viii. **Warning notices:** It may issue warning notices in relation to certain unethical practices which are regarded as '*infamous conduct*' in a professional respect.

ix. **Code of ethics:** The Council prescribes standards of professional conduct, etiquette and a code of ethics for medical practitioners.

x. **Certificates:** It is empowered to issue certificates of good conduct and character to medical students/doctors going abroad for higher studies/service.

xi. **CME programmes:** It sponsors and organizes continuing medical education (CME) programmes for medical practitioners.

xii. **Faculty development programmes:** The Council made it mandatory for all medical colleges to establish medical education departments in order to enable faculty members to avail modern education technology for teaching and to improve the quality of medical teaching by training the teachers.

State Medical Council (SMC)

Composition of the State Medical Council

- Medical teachers from different universities of the state elected by the teachers of different medical institutions.
- Members elected by registered medical practitioners of the state.
- Some members are nominated by the State Government. They elect a President and a Vice-President from amongst themselves.

Functions of SMC

i. Maintenance of Medical Register

- Maintains a register of medical practitioners within its jurisdiction.
- On payment of prescribed fees, the name, address and qualifications are entered in the register.
- A provisional registration is granted to a student who has passed the qualifying examination, but has to undergo a certain period of training (internship for 1 year) in an approved institution and permanent registration is granted after that training period.

ii. Disciplinary control: The Council is entrusted with disciplinary control over the registered medical practitioner (Flow chart 1.1).

- The SMC takes cognizance of any misconduct (professional) in case:
 - The medical practitioner has been convicted by court for any criminal offence
 - A complaint has been lodged against him by some person or body.
- Upon receipt of any complaint, the SMC would hold an enquiry and give opportunity to the registered medical practitioner to be heard.
- If the doctor is found to be guilty of committing professional misconduct, the Council may punish as deemed necessary or may direct the removal of the name of the delinquent practitioner from the register, altogether or for a specified period.⁴
- Decision on complaint against delinquent physician is taken within a time limit of 6 months.
- An inquiry against a doctor can be initiated only by that SMC with which he/she is registered. The MCI has no authority to initiate an inquiry against a doctor. The role of the MCI is only as an appellate authority to the Central Health

Ministry to decide on an appeal against the decision of the SMC on disciplinary matters.⁵

Duties of a Doctor (Flow chart 1.2)

Under the Indian Medical Council Act, 1956, the Medical Council of India, with the approval of the Central Government, made the following regulations which are called the **Indian Medical Council (Professional Conduct, Etiquette and Ethics) Regulations, 2002** (amended in 2009).

Code of Medical Ethics: At the time of registration, all the doctors are self-warned about certain unethical practices (infamous conduct) and the disciplinary action by the SMC (sometimes it is also called as *warning notice*). The applicant should certify that he/she had read and agreed to abide by the declaration and submit a declaration duly signed.

- **Hippocratic Oath:** The Hippocratic Oath is traditionally taken by physicians, in which certain ethical guidelines are laid out. Several parts of the Oath have been removed or re-worded over the years in various countries, schools and societies.
- **Declaration of Geneva:** The Declaration of Geneva was intended as a revision of the Hippocrates Oath to a formulation of that oaths' moral truth that could be comprehended and acknowledged modernly. It was adopted by the General Assembly of the World Medical Association (WMA) at Geneva in 1948 and amended in 1968, 1984, 1994, 2005 and 2006.
- **Declaration of Tokyo:** This was adopted in 1975 (amended in 2005 and 2006) during the assembly of the WMA. It refers to the guidelines for doctors concerning torture, degradation or cruel treatment of prisoners.⁶
- **Declaration of Helsinki:** The WMA originally developed this declaration in 1964 and underwent major revision in 1975. It refers to the ethical principles for medical research involving human subjects, including research on identifiable human material and data.⁷
- **Declaration of Oslo:** It was a statement by the WMA in 1970 on therapeutic abortion and amended in 1983 and 2006.⁸

Flow chart 1.1: Disciplinary functions of State Medical Council

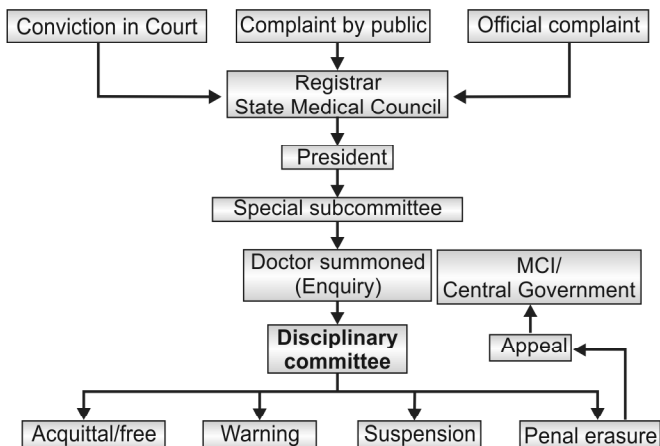

Flow chart 1.2: Duties of a medical practitioner

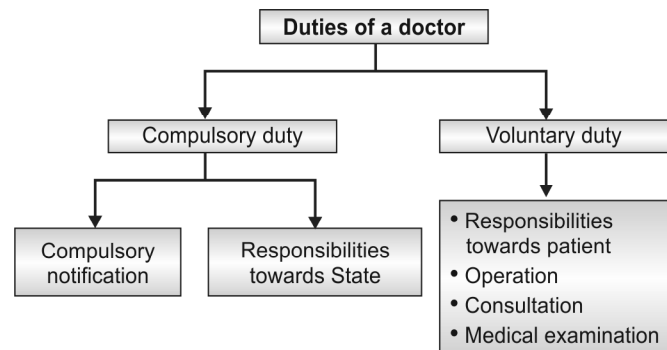

Duties of a Physician in General

- i. **Character of physician:** A physician should uphold the dignity and honor of his profession and render service to humanity; reward or financial gain is a subordinate consideration.
- ii. **Maintaining good medical practice**
 - The physician should try to improve medical knowledge and skills, and should practice methods having scientific basis. He should participate in professional meetings, i.e. CME programmes for *at least 30 hours (h) every 5 years*.
 - *Membership in medical society:* He should affiliate with associations and societies for the advancement of his profession.
- iii. **Maintenance of medical records**
 - Physician should maintain the medical records of his indoor patients for a period of *3 years* from the date of commencement of the treatment.
 - On request for medical records, either by the patients or legal authorities, the same should be issued within the period of *72 h*. This applies to a doctor in his private capacity, in case of indoor patients whom he/she might have treated/operated in hospital/nursing home.
 - He should maintain a register of medical certificates issued. He should record the signature and/or thumb mark, address and at least one identification mark of the patient and keep a copy of the certificate.
- iv. **Display of registration numbers**
 - Physician should display the registration number accorded to him by the SMC in his clinic and in all his prescriptions, certificates, money receipts given to his patients.
 - Physicians should display as suffix to their names only recognized medical degrees or such certificates/diplomas and memberships/honors which confer professional knowledge.
- v. **Use of generic names of drugs:** Physician should prescribe drugs with generic names and ensure that there is a rational prescription and use of drugs.
- vi. **Highest quality assurance in patient care:** He should not employ in connection with his professional practice any attendant who is not registered or permit such persons to attend, treat or perform operations upon patients wherever professional discretion or skill is required.

- vii. **Exposure of unethical conduct:** Physician should expose, without fear or favor, incompetent or corrupt, dishonest or unethical conduct on the part of members of the profession.
- viii. **Payment of professional services**
 - Physician should clearly display his fees in his chamber and/or hospitals he is visiting.
 - He should announce his fees before rendering service and not after the operation or treatment is underway.
- ix. **Evasion of legal restrictions:** Physician should observe the laws of the country in regulating the practice of medicine and should not assist others to evade such laws.

Duties of Physician towards State

- i. **Poisoning cases**
 - He should assist the police in determining whether the poisoning is accidental, suicidal or homicidal.
 - In case of death, death certificate should mention about the poisoning with recommendation for postmortem examination.
- ii. **Notification:** Doctor is bound to give information of communicable diseases, births, deaths and outbreak of an epidemic to public health authorities. Failing which he is not only liable for criminal penalties, but also negligence suits brought by affected persons.
- iii. **Geneva Convention**
 - In 1949, in Geneva, four conventions were agreed upon. Each convention lays down the persons it protects.
 - The wounded or sick of the armed forces (*1st convention*) ship-wrecked (*2nd convention*), prisoners of war (*3rd convention*) or civilians of enemy nationality (*4th convention*) are to be treated by the physician without any adverse distinction based on sex, race and nationality.
- iv. **Responding to emergency military service as and when required.**

Duties of a Physician towards Patients

- i. **Exercise reasonable degree of skill and knowledge**
 - It begins the moment the physician-patient relationship is established (i.e. when the physician agrees to treat the patient).
 - He owes this duty even when the patient is treated free of charge.
 - It neither guarantees cure nor an assured improvement.

- A practitioner (e.g. MBBS) is not liable because some other doctor of greater skill and knowledge (e.g. MD/MS) would have prescribed a better treatment or operated better in the same circumstances.
- ii. **Attendance and examination**
 - When a doctor agrees to attend a patient, he is under an obligation to attend to the case, as long it requires attention.
 - He can withdraw after giving reasonable notice or when he is asked by the patient to withdraw.
 - If the doctor is called by police to attend a case of road side accident, he may give first aid and advice, but no doctor-patient relationship is established.
 - iii. **Furnish proper and suitable medicines**
 - He should give a legible prescription.
 - Doctor is held responsible for any temporary or permanent damage in health, caused to the patient due to wrong prescription.
 - iv. **Instructions:** Doctor should give full instructions to his patients or their attendants regarding use of medicines (quantities and timings) and diet.
 - v. **Prognosis:** The patient or his relatives should have such knowledge of the patient's condition as will serve the best interests of the patient and the family.
 - vi. **Control and warn**
 - Doctor should warn patients of the side-effects involved in the use of prescribed drug, otherwise it might amount to negligence.
 - If the doctor fails to inform the known dangerous effects of a drug/device, he becomes liable not only for the harm suffered by the patient but also for injuries his patient may cause to third parties.
 - vii. **Third parties:** If a patient suffers from an infectious disease, the doctor should warn not only the patient, but also third parties who are close to the patient.
 - viii. **Children and disabled persons** being incapable of taking care of themselves, the doctor should arrange for their proper care, e.g. supervised application of hot water bottles.
 - xi. **Consent:** A mentally sound adult (≥ 18 years) must be told of all the relevant facts in non-medical terms and in a language the patient understands and then obtain consent.
 - x. **Operations**
 - Doctor should explain the nature and extent of operation and take consent of patient.
 - He should take proper care to avoid mistakes, such as operating on the wrong patient or on wrong limb or leave any instrument or swab inside a body cavity.
 - He should not delegate his duty to operate a patient to another doctor.
 - He should not experiment without valid reason or valid consent from the patient.
 - He should avail the assistance of qualified and experienced anesthetists.
 - Death on operation table should be followed by postmortem examination.
 - xi. **Investigations**
 - All cases of accident, unless they are minor, should be X-rayed.
 - For proper diagnosis and to know the progress, the doctor should advise investigations, like biopsy, X-rays, etc.
 - Wrong interpretation of X-ray is liable to be held as negligent.
 - xii. **Emergency cases**
 - He has moral, ethical and humanitarian duty to help the patient in saving his life.
 - In medico-legal injury cases, a doctor is obliged to give medical aid and to save life of the patient.
 - xiii. **Professional secrecy/medical confidentiality**
Definition: The doctor is obliged to maintain the secrets that he comes to know concerning the patient in the course of a professional relationship *except* when he is required by the law to divulge the secrets or when the patient has consented for its disclosure.
 - It is a fundamental tenet that whatever a doctor sees or hears in the life of his patient must be treated as totally confidential. Disclosure would be failure of trust and confidence.
 - The patient can sue the doctor for damages or face disciplinary action by the SMC, if the disclosure is voluntary and has resulted in harm to the patient and is not in the interest of public.

Following principles should be followed:

 - i. Physician should not answer any query by third parties, even when enquired by close relatives, either with regard to the nature of illness or any subsequent effect of such illness on the patient, without his/her consent.
 - ii. If the patient is *major* (≥ 18 years), physician should not disclose any facts about the illness without his consent to parents or relatives even though they may be paying the doctor's fees. In case of minor or insane person, guardians or parents should be informed of the nature of illness.
 - iii. A doctor should not disclose the illness of his patient without his consent, even when requested by a public or statutory body, *except* in case of notifiable diseases. If the patient is minor or insane, consent of the guardian should be taken.

- iv. Even in case of husband and wife, the facts relating to the nature of illness of one must not be disclosed to the other, without the consent of the concerned person. Particular caution is required over the disclosure of sexual matters, such as pregnancy, abortion or venereal disease, as disclosure might cause conflict between them.
- v. In divorce and nullity cases, no information should be given without the consent of the concerned person.
- vi. When a domestic servant is examined at the request of the master, the physician should not disclose any facts about the illness to the master without the consent of servant, even though the master is paying the fees. Similarly, the medical officer of firm or factory should not disclose without the patient's consent.
- vii. Medical officers in government service are also bound by code of professional secrecy, even when the patient is treated free.
- viii. A person in police custody as an undertrial prisoner has the right not to permit the doctor who has examined him, to disclose the nature of his illness to any person. If convicted, he has no such right and physician can disclose the findings to the authorities.
- ix. Any information regarding a dead person may be given only after obtaining the consent from a relative.
- x. In examination of a dead body, certain facts may be found, the disclosure of which may affect the reputation of the deceased or cause mental torture to his relatives, and as such, the autopsy surgeon should maintain secrecy.
- xi. The medical examination for *life insurance policy* is a voluntary act by the examinee and consent to the disclosure of findings may be taken as implied.

Privileged Communication

Definition: It is a statement, made bonafide upon any subject matter by a doctor to the concerned authority, due to his duty to protect the interests of the community or of the state.

- It is an exchange of information between two individuals in a confidential relationship and *an exception to professional secrecy*.
- To be privileged, it must be made to the person who has a duty towards it. If made to more than one person or to a person who has not got a direct interest in it, the plea of privilege fails.

- Physician should first persuade the patient to obtain his consent before notifying the proper authority.

Examples

- i. **Civic benefit:** If a patient poses a potential threat of 'grave harm' to the safety or health of patient and the public, the doctor must decide whether to inform the authority about the condition.
 - For example, a engine or bus driver, pilot or ship navigator may be suffering from epilepsy, hypertension, alcoholism, drug addiction, poor visual acuity or color blindness; or a teacher with tuberculosis or a person with infectious diseases (e.g. enteric infection) working as a cook. In all these cases, the proper course is for the doctor to explain the risks to the patient and to persuade him to allow the doctor to report the problem to his employers. If the patient refuses, then it is always wise to seek the advice of senior colleagues before making any disclosure.
 - A syphilitic taking bath in public pool or a patient with sexually transmitted disease is about to get married is a privileged communication but an impotent person getting married is not.
- ii. **Notifiable clauses:** Doctor has a statutory duty to notify births, deaths, still births, infectious diseases, therapeutic abortions, drug addictions, epidemic and food poisoning to public health authorities.
- iii. **Suspected crime:** If the physician learns of a crime, such as assault, terrorist activity, traffic offence or homicidal poisoning by treating the victim or assailant, he is bound to report it to the nearest Magistrate or police officer.
 - But sometimes, the issue of confidentiality clashes with the need to protect some individual or the public from possible further danger (e.g. a below-age of consent girl came to a doctor with STD). The same issue may arise where a doctor suspects a child being abused, but here the overriding consideration is the safety of the child.
 - At times, assault may occur within a family, e.g. between spouses or close relatives, the victim may not wish to bring criminal charges and so the doctor must not assume that consent for disclosure has been given.
 - The doctor knowing or having reason to believe that an offence has been committed by a patient when he is treating, intentionally omits to inform the police, shall be punished with imprisonment upto 6 months with/without fine (**Sec. 202 IPC**).

- iv. **Patient's own interest:** Doctor may disclose patient's condition to his relatives so that he may be properly treated, e.g. to warn parents/guardians of patient's melancholia or suicidal tendencies.
- v. **Self-interest:** In case of civil and criminal suits by the patient against the physician, evidence about patient's condition may be given.
- vi. **Negligence suits:** When doctor is employed by opposite party to examine a patient who has filed a suit for negligence, the information thus acquired is not a professional secret (no physician-patient relationship) and the doctor may testify to such information.
- vii. **Court of law:** Doctor cannot claim professional secrecy concerning the facts about illness of his patient in court of law.^{9,10} He has to answer the questions about patient's confidential matters to avoid risk penalties for contempt of court.

A doctor can disclose and discuss the medical facts of a case with other doctors and paramedical staff, such as nurses, radiologist and physiotherapist to provide better service to the patient.

Duties of a Physician in Consultation

- i. **Consultation for patient's benefit** is of foremost importance. Unnecessary consultations should be avoided.
- ii. **Statement to patient after consultation** should take place in the presence of the consulting physician, except if otherwise agreed. Differences of opinion should not be divulged unnecessarily.
- iii. **Treatment after consultation:** The attending physician should make subsequent variations in the treatment, if any unexpected change occurs. The attending physician may prescribe medicine at any time for the patient, whereas the consultant may prescribe only in case of emergency or as an expert when called for.
- iv. **Patients referred to specialists:** When a patient is referred to a specialist by the attending physician, a case summary of the patient should be given to the specialist, who should communicate his opinion in writing to the attending physician.

Consultation is advised with a specialist in the following conditions:

- i. In case of emergency.
- ii. If the patient requests consultation.
- iii. If quality of care or management can be considerably enhanced.

- iv. In cases where diagnosis remains obscure.
 - v. In case of homicidal poisoning.
 - vi. In connection with organ transplantation.
 - vii. When treatment or operation involves risk of life.
 - viii. When operation affecting vitality, intellectual or generative functions is to be performed.
 - ix. When an operation involves mutilation or destruction of an unborn child.
 - x. When an operation is to be performed on a patient who has received injuries in a criminal assault.
 - xi. To take decision about termination of pregnancy case, after 12 weeks and upto 20 weeks of pregnancy.
 - xii. While dealing with a criminal abortion or an attempted criminal abortion case.
- A referring physician is relieved of further responsibility when he completely transfers the patient to another physician.
 - The referring physician may be held liable under the *doctrine of negligent choice*, if it can be proved that the consultant was incompetent or had a reputation as an errant physician.

Responsibility of Physicians towards Each Other

- i. **Conduct in consultation:** No insincerity, rivalry or envy should be indulged in. All due respect should be observed towards the physician in-charge of the case and no statement or remark be made, which would impair the confidence the patient has reposed in him.
- ii. **Consultant not to take charge of the case:** Consultant should normally not take charge of the case, especially on the solicitation of the patient or friends.
- iii. **Appointment of substitute:** A physician should accept to attend another physician's patients during his temporary absence from his practice, only when he has the capacity to discharge the additional responsibility along with his other duties.

Medical Malpractice

The term 'medical malpractice' covers all failures in the conduct of doctors, where it impinges upon their professional skills, ability and relationships.

It divided into two broad types: (Diff. 1.1)

- i. Professional misconduct—where the personal, professional behavior falls below that which is expected of a doctor.
- ii. Medical negligence—where the standard of medical care given to a patient is considered to be inadequate.

Differentiation 1.1: Professional negligence and infamous conduct

S.No.	Feature	Professional negligence	Infamous conduct
1.	Offence	Absence of care and skill or willful negligence	Violation of code of Medical Ethics
2.	Duty of care	Should be present	Need not be present
3.	Damage to person	Should be present	Need not be present
4.	Trial by	Courts—civil or criminal	State Medical Council
5.	Punishment	Fine, imprisonment or both	Erasure of name or warning
6.	Appeal	Higher court	MCI and Central Government

Unethical Acts

A medical practitioner should not commit any of the following acts which may be construed as unethical:

- i. **Advertising:** *He should not:*
 - a. Solicit patients directly or indirectly, by a physician or a group of physicians or by institutions.
 - b. Make use his name for any advertising through any mode, so as to invite attention to his professional position.
 - c. Give any recommendation, endorsement or statement with respect of any drug, surgical or therapeutic appliance for use in connection with his name, signature or photograph in any form of advertising (**no association with manufacturing firms**) nor shall he boast of cases, operations or cures or permit the publication of report thereof through any mode.
 - d. Print self-photograph or any such material of publicity in the letterhead or on sign board of the consulting room.

A medical practitioner is however permitted to make a formal announcement in press regarding the following:

 - On starting or resumption or change of type of practice.
 - On changing address.
 - On temporary absence from duty.
 - On succeeding to another practice.
 - Public declaration of charges.
- ii. **Patent and copyrights:** He may patent surgical instruments, appliances, procedures and medicine. However, it shall be unethical, if the benefits of such patents are not made available in situations where the interest of large population is involved.
- iii. He should not **run an open shop for dispensing of drugs and appliances** prescribed by other physicians.

iv. **Rebates and commission (dichotomy/fee splitting):**

He should not give or receive any gift or commission in consideration of referring, recommending or procuring of patient for medical, surgical or other treatment or for getting specimen or material for diagnostic purposes.¹¹

v. **Secret remedies:** He should not prescribe or dispense secret remedial agents of which he does not know the composition. All the drugs prescribed by a physician should always carry a proprietary formula and clear name.vi. **Human rights:** He should not aid or abet torture or be a party to either infliction of psychological or physical trauma.vii. **Euthanasia:** He should not practice euthanasia.viii. **Pharmaceutical and allied health sector industry:** A medical practitioner should not receive any gift, cash or monetary grants, travel facility or accept any hospitality like hotel accommodation from any pharmaceutical industry for vacation or for attending conferences, seminars, workshops or CME programme as a delegate.**Professional Misconduct (Infamous Conduct)**

Definition: Any conduct of the doctor which might reasonably be regarded as disgraceful or dishonorable as judged by professional men of good repute and competence. It involves abuse of professional position.

The following acts of commission or omission on the part of a physician constitutes professional misconduct:

- i. Any **unethical practice** as outlined above.
- ii. If he **does not maintain the medical records** of his indoor patients for a period of 3 years and refuses to provide the same within 72 h when the patient requests for it.

- iii. If he **does not display the registration number** accorded to him by the SMC in his clinic, prescriptions and certificates issued by him.
 - iv. Physician posted in **rural area is found absent on more than two occasions** during inspection by the Head of the District Health Authority or the Chairman, Zila Parishad.
 - v. Physician posted in a **medical college** as teaching faculty or otherwise is **found absent on more than two occasions**; the same shall be construed as misconduct, if it is certified by the Principal/Medical Superintendent.
- Further, he should not:*
- i. **Commit adultery or misbehave** with a patient.
 - ii. Be **drunk and disorderly** so as to interfere with proper practice of medicine.
 - iii. Be **convicted by court of law** for offences involving moral turpitude/criminal acts.
 - iv. Do **sex determination tests** with the intent to terminate the life of a female fetus.
 - v. **Issue false, misleading or improper certificates** for subsequent use in the courts or for administrative purposes.
 - vi. **Violate the provisions of Drugs and Cosmetics Act.** He should not:
 - Sell Schedule 'H' and 'L' drugs and poisons to the public, except to his patient.
 - Prescribe steroids/psychotropic drugs when there is no medical indication.
 - vii. **Supply or sell addiction forming drugs** to a patient other than medical grounds.
 - viii. **Give cover**, i.e. assist someone who has no medical qualification to attend, treat or perform an operation, in cases requiring professional discretion or skill.
 - ix. **Perform an illegal abortion/operation** for which there is no medical, surgical or psychological indication.
 - x. **Issue certificates of efficiency in modern medicine** to unqualified or non-medical person.
 - xi. **Disclose professional secrets.**
 - xii. **Refuse on religious grounds** for sterilization, birth control, circumcision and medical termination of pregnancy when it is indicated.
 - xiii. **Publish photographs/case reports** of his patients **without their consent** in any medical or other journal in a manner by which their identity could be made out.
 - xiv. **Use touts or agents** to entice patients.
 - xv. **Claim to be specialist** when he has no special qualification in that branch.
 - xvi. **Undertake in-vitro fertilization or artificial insemination** without the informed consent of the female patient and her spouse as well as the donor.
 - xvii. Do clinical **drug trials** or other **research** involving patients or volunteers not abiding by the guidelines of ICMR.
 - xviii. Regarding **advertisement**,⁶ *he should not:*
 - a. Contribute to the lay press articles and give interviews regarding diseases and treatments which may have the effect of advertising himself. He can write to the lay press under his own name on matters of public health, hygiene or deliver public lectures, give talks on the radio/TV/internet for the same purpose.
 - b. Use an unusually large signboard and write on it anything other than his name, qualifications, title, name of his speciality and registration number.
 - c. Affix a signboard on a chemist's shop or in places where he does not reside or work.
- The instances of offences and professional misconduct which are given above *do not constitute a complete list of the infamous acts* which calls for disciplinary action. Circumstances may arise from time to time in relation to which there may occur questions of professional misconduct which do not come within any of these categories.
- Important offences can be described as 6 A's¹²*

1. Association with unqualified persons	4. Adultery
2. Advertising	5. Addiction
3. Abortion (criminal)	6. Alcohol
- ### Erasure of Name
- The name of the doctor is removed from the SMC register:
- After the death of registered medical practitioner.
 - When entries of the medical practitioner are erroneous or fraudulent.
 - In case of professional misconduct which is known as *penal erasure*. When the name is permanently removed, it is termed as **professional death sentence**.¹³
 - When the registered medical practitioner is not traceable at the address recorded with the council.
- ### Rights and Privileges of Registered Medical Practitioners
- i. Right to choose his patient—he may refuse any patient without reason, but he should not refuse emergency treatment required by the patient.
 - ii. Right to use title and description of the qualification to his name.
 - iii. Right to practice medicine.
 - iv. Right to dispense medicine to his patient.
 - v. Right to possess and supply dangerous drugs to his patients.

- vi. Right to be exempted from acting as a juror in course of holding an inquest.
- vii. Right to give evidence in court of law, as an expert witness.
- viii. Right to issue medical certificates and medico-legal reports.
- ix. Right to recovery of fees—if the patient does not pay the justified fees, help of court can be taken.
- x. Right for appointment in public and local hospitals.

Red Cross Emblem

Red Cross is an emblem which is used only by those belonging to the Red Cross Movement and Army Medical Services involved in humanitarian work, mainly at times of armed conflicts and natural disasters and it is not an emblem of medical professionals.

As specified by the Geneva Conventions, the emblem can be used only by the following:

- Facilities for the care of injured and sick armed forces members
- Armed forces medical personnel and equipment
- Military chaplains
- International Red Cross Organizations

The use of the emblem by Government medical institutions, like hospitals, clinics and blood banks, doctors, private nursing homes and also on ambulance vehicles is equivalent to abuse and is punishable with a fine of ₹ 500 and forfeiture of the goods or vehicles on which the emblem has been used.¹⁴

Privileges and Rights of Patients

- i. **Access** to health care facilities and emergency services regardless of age, sex, religion, social or economic status.
- ii. **Choice:** To choose his own doctor freely.
- iii. **Continuity:** To receive continuous care for his illness from doctor/institution.
- iv. **Comfort:** To be treated in comfort during illness and follow-up.
- v. **Complaint:** Right to complain and redressal of grievances.
- vi. **Confidentiality:** All information about his illness should be kept confidential.
- vii. **Dignity:** To be treated with care, compassion, respect without any discrimination.
- viii. **Information:** Should receive full information about his diagnosis, investigations, treatment plans, alternative therapy, procedures, diagnosis, complications and side-effects.
- ix. **Privacy:** To be treated in privacy.

- x. **Refusal:** Can refuse any specific or all measures.
- xi. **Records:** Can have access to his records and demand summary or other details.

Duties of a patient

- i. He should furnish the doctor with complete information about the facts and circumstances of his illness.
- ii. He should strictly follow the instructions of the doctor as regards diet, medicine and lifestyle.
- iii. He should pay a reasonable fee to the doctor.

Types of Physician-Patient Relationship

It is of two types:

1. **Therapeutic relationship:** A doctor is free to accept or refuse to treat a patient, subject to constraint of his work *except* in emergencies. He may refuse to treat the patient in following circumstances:
 - i. Beyond his practicing hours.
 - ii. Not belonging to his speciality.
 - iii. Doctor or any other family member is ill.
 - iv. Doctor having important social function in family.
 - v. Illness beyond the competence and qualification of the doctor or beyond the facilities available in his setup.
 - vi. Doctor having alcohol.
 - vii. Patient is malingering.
 - viii. Patient has been defaulting in payment.
 - ix. Patient or his relatives are abusive/uncooperative.
 - x. Patient refuses to give consent.
 - xi. Patient demanding specific drugs, like amphetamine, steroids, etc.
 - xii. Patient rejecting low-cost remedies in favor of high cost alternatives.
 - xiii. At night, on grounds of security, if patient is not brought to him.
 - xiv. An unaccompanied minor or female patient.
 - xv. When doctor remains engaged with an emergency or more serious case.
 - xvi. Any new patient, if he is not the only doctor available.
2. **Formal relationship:** It pertains to the situation where the third party has referred the person/patient for impartial medical examination; e.g.:
 - i. Pre-employment.
 - ii. Insurance policy.
 - iii. Yearly medical checkups.
 - iv. Cases of rape or victims of crimes.
 - v. Intimate body searches and other medico-legal cases.
 - vi. In certain psychiatric illnesses referred by court/police.

Doctor has to comply with the directive of the party demanding such examination.

Professional Negligence

Definition: Absence of reasonable care and skill or willful negligence of a medical practitioner in the treatment of patient which causes bodily injury or death of the patient.

Negligence consists of two acts: Not doing something that a reasonable man, under the circumstances would do (**act of omission**); or doing something which a reasonable prudent man under the circumstances would not do (**act of commission**).

According to Black's Law Dictionary, medical negligence requires that the plaintiff (i.e. patient) establish the following (**4 D's**):

- i. Existence of the physician's *duty* to the plaintiff, based on the existence of the physician-patient relationship.
- ii. Applicable standard of care and its violation (*dereliction of duty*).
- iii. *Damage* (a compensable injury).
- iv. Causal connection between the violation of care and the harm complained of (*direct causation*).

'Damage' should be distinguished from 'damages'. Damage (injury or harm) to the patient may be physical, mental or financial. Damages are assessed by the court based on parameters, like loss of earning, medical and surgical costs or reduction of quality of life.

Potential damages (financial compensation) in negligence suits fall into three categories:

- **Economic** or the monetary costs of an injury (e.g. medical bills or loss of income)
- **Non-economic** (e.g. pain and suffering, loss of ability to have sex)
- **Punitive** or damages to punish a defendant for willful and wanton conduct.

Types: (Diff. 1.2)

- i. Civil
- ii. Criminal.

Civil Negligence

Question of civil negligence arises:

- i. When a patient, or in case of death, any relative brings suit in a civil court for realization of compensation from his doctor, if he has suffered injury due to negligence.

Differentiation 1.2: Civil and criminal negligence

S.No.	Feature	Civil negligence	Criminal negligence
1.	Offence	No specific and clear violation of law	Must have specifically violated a particular criminal law in question
2.	Negligence	Simple absence of care and skill	Gross negligence, inattention or lack of competence
3.	Conduct of physician	Compared to a generally accepted simple standard of professional conduct	Not compared to a single test
4.	Consent for act	Good defense, cannot recover damages	Not a defense, can be prosecuted
5.	Trial by	Civil court	Criminal court
6.	Evidence	Strong evidence is sufficient	Guilt should be proved beyond reasonable doubt
7.	Punishment	Liable to pay damages	Imprisonment, fine or both
8.	Contributory negligence	Defense for doctor	Not a defense
9.	Double jeopardy*	Can be tried twice for crime	Cannot be tried twice for the same crime
10.	Damage	Repairable damage or harm to patient	Irreparable damage to the patient
11.	Dispute	Between two parties in their individual capacities	Between the state and the offending doctor
12.	Complainant	Sufferer party is the complainant	Public prosecutor on behalf of the state is the complainant

* *Double jeopardy* is a procedural defense (in India, US, Canada, Mexico and Japan—a constitutional right) that forbids a defendant from being tried a second time for the same crime

- ii. When doctor brings a civil suit for the realization of his fees from patient or his relatives, who refuse to pay the same, alleging professional negligence.

Civil negligence involves:

- Such act on the part of the treating physician which causes some suffering, harm or damage to the patient
- Damage is such, which can be compensated by paying money
- Does not come under the purview of CrPC and IPC
- Does not demand legal punishment

Criminal Negligence

- Criminal negligence is more serious than civil negligence.
- Practically limited to cases in which the patient has died.
- Mostly associated with drunkenness or impaired efficiency due to the use of drugs by doctors.
- Doctor shows gross incompetency and inattention in the selection and application of remedies, undue interference by him or criminal indifference to the patient's safety.
- **Sec. 304 A IPC** deals with criminal negligence; 'whoever causes the death of any person by doing any rash or negligent act not amounting to culpable homicide should be punished with imprisonment upto 2 years with/without fine'.¹⁵

Examples of Medical Negligence

It is impossible to give a complete list of negligent situations in medical practice. However, some situations that frequently give rise to allegations of negligence are sited in Table 1.1.

A physician may be liable to both civil and criminal negligence by a single act, e.g. if he performs an unauthorized operation on a patient, he may be sued in civil court for damages and prosecuted in criminal court for assault.

The police sometime register the cases of professional negligence deaths under **Sec. 304 IPC** which is non-bailable offence, whereas if it is registered under **Sec. 304-A IPC**, the offence is bailable. The basic difference is that in **Sec. 304** there is intentional act of negligence while in **304-A**, the act is never done with the intention to cause death.

Burden of Proof

The accused (doctor) is innocent until proven guilty, and the prosecution must prove the case against him/her. The plaintiff (patient) bears the burden of proof and must convince the judge by a preponderance of the evidence that its case is more plausible.¹⁶

- In civil cases, a preponderance of the evidence is at least 51%. It means that judges in a medical negligence case must be persuaded that the evidence presented by the plaintiff is more plausible as the proximate cause of the injury than any counterargument offered by the defendant.
- In criminal cases, the prosecution must prove their case 'beyond reasonable doubt' akin to a 98% or 99% certainty.

Preventing Medical Litigation

Some ways/methods to minimize litigation are sited below:

- **Awareness of potential areas of litigation and medico-legal problems:** Doctor should be aware of the risks involved in certain procedures and should have clear knowledge of the changes in legislation which might influence his practice.
- **Good 'doctor-patient' relationship:** Sympathy, good rapport and taking keen interest in the patient's apprehensions and complaints are hallmarks in gaining the patient's confidence. A suspicious patient who has no faith in the physician is a potential litigant.
- **Appropriate training and maintenance of authorized protocol:** Up-to-date and adequate training of medical and nursing staff is needed. It is dangerous to venture beyond one's capability and qualifications. Maintaining a time-tested, well accepted protocol is necessary. It is wise to seek a second opinion.
- **Maintaining standard medical service:** Limited work load and adequate infrastructure are needed to maintain good quality service. Minimum standard for nursing homes or hospitals, whether public or private, must be maintained.
- **Proper counseling and informed consent:** Counseling and informed consent is mandatory before each medical/investigative/operative procedure.
- **Proper investigation:** Any non-invasive/invasive procedures should be done, provided the risks and benefits are duly informed and written consent has been taken.
- **Adequate supervision and timely referral:** Adequate supervision by a well organized graded system is recommended. Early detection of complications by resident doctors and timely notification of the consultant, especially in emergency cases, may prevent mishaps.
- **Surgical intervention:** Surgical procedures should always be performed in places where there is sufficient equipment and qualified staff. Junior doctors should

Table 1.1: Examples of medical negligence**General Errors**

- Inadequate clinical records and failure to examine the patient himself/herself.
- Failure to attend a patient with consequent damage.
- Failure to admit to hospital when necessary.
- Failure to obtain informed consent for any procedure.
- Making a wrong diagnosis in the absence of skill and knowledge.
- Administration of incorrect type/quantity of drugs, especially by injection.
- Failure to immunize and perform sensitivity tests.
- Failure to act on radiological or laboratory reports.

Medicine

- Failure to diagnose myocardial infarcts and other medical conditions.
- Failure to refer a patient to hospital or for specialist opinion.
- Toxic results of drug administration.

Surgery

- Delayed diagnosis of acute abdominal lesions.
- Retention of instruments, tubes, towels, sponges and swabs in operation sites.
- Operating on the wrong patient, wrong side of the body, wrong limb, digit or even organ.
- Failed vasectomy, without warning of lack of total certainty of consequent sterility.
- Diathermy burns.

Obstetrics and Gynecology

- Unwanted pregnancy due to failed tubal ligation.
- Complications of hysterectomy—ureteric ligation and vesico-vaginal fistulae.
- Brain damage in the newborn due to hypoxia from prolonged labor—fear of litigation for this has resulted in a higher rate of caesarean.
- Mismanagement of delivery, especially under the influence of alcohol/drug.
- Performing abortion without indication (criminal abortion).

Orthopedics and Emergency Medicine

- Missed fractures, especially of the scaphoid, skull, femoral neck and cervical spine.
- Over-tight or prolonged use of plaster casts resulting in tissue and nerve damage.
- Undiagnosed intracranial hemorrhage.
- Missed foreign bodies in eyes and wounds, especially glass.
- Inadequately treated hand injuries, particularly tendons.

Anesthesiology

- Hypoxia resulting in brain damage.
- Neurological damage from spinal or epidural injections.
- Peripheral nerve damage from splinting during infusion.
- Incompatible blood transfusion.
- Incorrect or excessive use of anesthetic agents.

be trained well and supervised in surgical care of the patient.

- **Meticulous record keeping:** Often proper record keeping can prove the doctor innocent in the court. However, fabrication of records after any mishap is dangerous.
- **Morbidity and mortality audits:** Discussions, analysis and constructive criticism of errors and omissions help in improving and maintaining standard of patient care.
- **Medical indemnity insurance:** The doctor must cover himself with indemnity insurance.
- **Medical defense procedure:** Efficient defense attorney is important to defend one against a malpractice and negligence suit. The attorney must be aware of the expected standard of patient care.

Defenses Against Negligence

In case of alleged negligence, following may be helpful for defense:

- No duty owed to patient, i.e. no doctor-patient relationship was established.
- Duty discharged according to prevailing standards.
- **Informed consent for the act:** The patient was duly informed of the consequences.
- Patient was guilty of contributory negligence.
- Therapeutic misadventure.
- Medical maloccurrence.
- **Error of judgment.** The court has held that the error of judgment was not a case of negligence as contended. If, for e.g. one of the risks inherent in an operation takes place or some complication ensues which lessens the benefit that was hoped for, he makes an error of judgment.
- **Mistake of fact** is a situation where a person not intending to do unlawful act, does so because of wrong conclusion or understanding of fact. The guilty mind was never there while doing the act. It can be a factor in reducing civil liability but not criminal liability.
- **Res judicata** means 'the things have been decided'. According to this principle, once the case is completed between two parties, it cannot be tried again between the same parties. Suppose a patient sues a hospital for any malpractice and the things are decided, he cannot subsequently sue the doctor again separately for the same negligence.
- **Limitation:** The case against the doctor should be filed within 2 years from the date of alleged negligence. No fee was charged for the treatment cannot be a defense in cases of negligence.¹¹

Documentation: It is a part of medical training and one must make a habit of keeping records, not only in the interest of medical science, but also for his own safety and interest. The dictum is that '*If it is not in the record—it did not occur*'.

Doctrine of Res ipsa loquitur

- Generally, professional negligence of a doctor must be proved in court by expert evidence of another physician.
- The patient need not prove negligence in case where the rule of *res ipsa loquitur* applies, which means '*the thing or fact speaks for itself*'.
- Applies to both civil and criminal negligence.
- Error is so self-evident that the patient's lawyer need not prove the doctor's guilt with medical evidence. The doctor has to prove his innocence.¹⁷
- Rule is applied when the following three conditions are satisfied:
 - i. In the absence of negligence, the injury would not have occurred
 - ii. Doctor had exclusive control over the injury producing instrument/treatment
 - iii. Patient was not guilty of contributory negligence.

Examples

- i. Blood transfusion misadventure.
- ii. Failure to give anti-tetanic serum in cases of injury.
- iii. Prescribing an overdose of medicine producing ill effects.
- iv. Leaving a pair of scissors in abdomen.¹⁸
- v. Failure to remove swabs during operation, causing complications/death.
- vi. Loss of use of hand due to prolonged splinting.

In such situations, the breach of duty is obvious, so the strategy of the defense generally must be to show that the patient was not harmed by the breach.

Calculated Risk Doctrine

- The doctrine is that, *res ipsa loquitur* should not be applied when the injury complained is of type that may occur even though reasonable care has been taken.
- It is an important defense to any doctor.
- Doctor has to produce evidence/statistics that the accepted method of treatment he employed had unavoidable risks.
- For example, when a patient undergoing coronary bypass dies during the surgery, it becomes a case of professional accident as there is already an inherent risk of 2-5% associated with it.

Doctrine of Common Knowledge

- It is based on the assumption that the issue of negligence in the particular case is not related to specialized knowledge or technical matters of the medical profession, but an act involving application of common knowledge.
- Experts may not provide evidence regarding matters of 'common knowledge'.
- It is a variant of *res ipsa loquitur*.¹⁹
- Here, the patient must prove the act of commission or omission, but he need not produce evidence to establish the standard of care.

Doctrine of Avoidable Consequence Rule

- Once plaintiff (patient) has been injured, he must take reasonable steps to lessen the consequences of his original injury. A defendant (accused) will not be liable of any further injury that the plaintiff could have reasonably avoided.
- The doctrine is different from contributory negligence. The latter is unreasonable conduct by plaintiff. It occurs before or simultaneously with the wrong committed by the defendant.²⁰
- The doctrine refers to unreasonable conduct by the plaintiff after the defendant has wronged the plaintiff. The amount of recovery is reduced.
- Thus, if the plaintiff, after injury, unreasonably refuses to accept medical attention for a foot injury and as a result ultimately suffers amputation of the foot that otherwise would have healed, then the avoidable consequences rule would deny recovery for loss of foot but would not affect other damages.

The eggshell skull rule (thin-skull rule) is a legal doctrine used in both civil and criminal law that holds an individual liable for all consequences resulting from their activities leading to an injury to another person, even if the victim suffers unusual damages due to a preexisting vulnerability or medical condition.

Medical Maloccurrence

- Medical maloccurrence is the legal term which defines a less than ideal outcome of medical care, and maloccurrence is often unrelated to the reasonable risks of quality of care that was provided.
- In some cases, in spite of good medical attention and care, an individual fails to respond properly.
- For example, idiosyncratic response to drugs in some patients or damage to recurrent laryngeal nerve during thyroidectomy leading to vocal cord paralysis.

Novus Actus Interveniens (Unrelated Intervening Action)

- If doctor is negligent, which results in deviation from the logical sequence of events, then the responsibility for the subsequent disability or death may pass from original incident to the negligent act of doctor.
- For a plea of *novus actus interveniens*, an element of negligence is essential.
- It usually applies to cases of accidents and assaults, like leaving a swab or instrument in the abdomen after laparotomy.
- Plea is rarely accepted by the courts.

Contributory Negligence

Definition: Any unreasonable conduct, or absence of ordinary care on part of the patient or his attendant, which combined with doctor's negligence contributed to the injury complained of, as a direct cause and without which the injury would not have occurred.²¹

- Good defense for the doctor in civil cases, but not in criminal cases.²²
- Doctor has to prove patient's negligence. But, doctor is expected to foresee that the patient may harm himself and to warn accordingly.
- For example, patient did not give proper history, failure to follow doctor's instructions regarding drugs, tests and diet, or leaving the hospital against doctor's advice.
- Damages awarded by the court may be reduced.

Composite negligence: Injury is caused to the person without any negligence on his part, but as a result of the combined effect of the negligence of some other persons (two or more). In such a case, each wrong doer is jointly and severally liable to the injured for payment of the entire damages and the injured person has the choice of proceeding against all or any of them.

Therapeutic Misadventure/Hazard

Definition: It is a case in which an individual has been injured or had died due to some unintentional/inadvertent act by doctor or his agent or hospital (somewhat similar to medical maloccurrence). Such mishap does not provide ground for negligence, e.g.

- i. Hypersensitivity reactions caused by penicillin, tetracycline and aspirin.
- ii. Radiological procedures for diagnostic purposes, e.g. poisoning by barium enema, traumatic rupture of rectum or chemical peritonitis during barium enema.

- iii. Thyroid cancer with I^{131} therapy.
- iv. Fatal complications from hemolytic reactions with blood transfusion.
- v. Prolonged use of diethylstilbestrol, a synthetic form of estrogen, may cause breast cancer.

Misadventure is mischance, accident or disaster.

It is of three types:

- i. **Therapeutic:** when treatment is being given.
- ii. **Diagnostic:** when diagnosis is the only objective at that time, e.g. injection of radiopaque dye in radiological investigation, bronchoscopy and angiography.
- iii. **Experimental:** where patient has agreed to serve as a subject in an experimental study (drug/operative procedure).

Vicarious Liability/Respondeat Superior

Definition: An employer is responsible for the negligent act of his employees by the principle of '*respondeat superior*' (Latin, 'let the master answer'), if three conditions are satisfied:

- i. There must be an employer-employee relationship
- ii. The employee's conduct must occur within the scope of his employment
- iii. Incident must occur while on the job
- It also called the '*Master-Servant Rule*'.
- In medical practice, usually, the principal doctor becomes responsible for any negligence of his assistants (both medical and para-medical). Both may be sued by the patient, even though the principal has no part in the negligent act.
- A doctor may be associated temporarily with another doctor with the establishment of an employee-employer relationship between them. Thus, if one doctor assists another in the operating room for a fee, the assistant is considered as an employee of the principal surgeon.
- When two doctors practice as partners, each is liable for negligence of the other, even though one may have no part in the negligent act.
- If a swab, sponge or instrument is left in the patient's body after the operation, the surgeon is liable for damages. A surgeon is not liable for the negligence of an anesthetist, and the anesthetist is not liable for the negligence of the operating surgeon.
- **'Borrowed servant doctrine':** An employee may serve more than one employer, e.g. the nurse employed by a hospital to assist in operations will be the 'borrowed servant' of the operating surgeon during the operation, and the servant of the hospital for all other purposes.
- Physicians and surgeons are not responsible for the negligent acts of competent nurse or other hospital personnel, unless such acts are carried out under their direct supervision and control.

- A hospital, as an employer, is responsible for negligence of its employees who are acting under its supervision and control.
- Hospital management cannot be held responsible for the negligent acts of members of the senior medical staff in the treatment of patients, if it can be proved that the management exercised due care and skill, in selecting properly qualified and experienced staff.
- Hospital management is held responsible for the mistakes of resident physicians and interns in training, who are considered employees when performing their normal duties. A physician is responsible for the acts of the interns and residents carried out under his direct supervision and control.²³
- Both the employer and employee are sued by the patient, because the employee may lack funds for paying the damages. Usually, liability will be fixed upon those actually at fault and those whose control over the negligence is demonstrable.
- To avoid vicarious liability, an employer must demonstrate either that the employee was not negligent or the employee was reasonably careful or that the employee had gone on a '*detour*', wherein the employee was acting in his own right, rather than on the employer's business.

Corporate Negligence

Definition: It is the failure of those in hospital administration/management who are responsible for providing the treatment, accommodation and facilities necessary to carry out the purpose of the institution, to follow the established standard of conduct.

It occurs when hospital:

- Provides defective equipment or drugs.
- Selects or retains incompetent employees including doctors.
- Fails in some other manner to meet the accepted standard of care and such failure results in injury to a patient to whom the hospital owes a duty.

Products Liability

Definition: It refers to the physical agent that caused the injury or death of the patient during treatment.

- The plaintiff must prove that:
 - i. Manufacturer departed from standards of due care, with respect to design, manufacture, assembly, packaging, failure to test and inspect for defects or failure to warn or give adequate instructions.
 - ii. Defect was the proximate cause of injury/death. If it is proved, the manufacturer becomes responsible for injury or death.

- The burden of proving the safety and effectiveness of a new drug/device/instrument lies with the manufacturer.

Consent

Definition: Consent (Latin *consentirez*: 'to feel or sense with') means voluntary agreement, compliance or permission. As per the **Sec. 13 of the Indian Contract Act, 1872**: 'two or more persons are said to consent when they agree upon the same thing in the same sense (meeting of the minds).'

Types (Flow chart 1.3)

Broadly, consent is of two types:

1. **Implied:** When the patient presents himself at the doctor's clinic or outpatient, it is held to imply that he is agreeable to be examined. This does not imply to procedures more complex than *inspection, palpation, percussion* and *auscultation*. For other examinations, like rectal and vaginal and withdrawal of blood for diagnostic purposes, expressed permission should be obtained.
2. **Expressed:** Specifically stated by the patient in distinct and explicit language. It can be:
 - i. *Oral/verbal consent* is obtained for relatively minor examinations or therapeutic procedures, preferably in presence of disinterested party, like nurse.
 - ii. *Written consent* is to be obtained for:
 - All major diagnostic procedures
 - General anesthesia
 - Operations.

Doctrine of Informed Consent²⁴

It implies an understanding by the patient of:

- i. Condition or nature of illness
- ii. Purpose and nature of procedure or treatment proposed
- iii. Risks and benefits of treatment or procedure
- iv. Prospect of success or failure
- v. Risks and benefits of alternative treatment(s) or procedure(s)

Flow chart 1.3: Types of consent

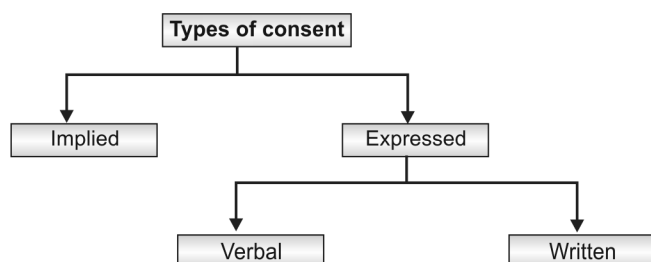

- vi. Prognosis in the absence of intervention
- vii. Acceptance or refusal (*informed refusal*) of the said procedure or intervention

The knowledge regarding the intervention should be imparted in an understandable language and format so that decision in the form of authorization by patient can be made.

- There are no clear parameters laid down regarding the quantum of information to be given for informed consent. Therefore, it is reasonable information which a doctor deems fit considering best practices.
- The standard to which physicians are held in negligence suits is that of a 'reasonable physician' dealing with a 'reasonable patient.'

Exceptions to informed consent

- Emergencies (Sec. 92 IPC)
- Therapeutic privilege
- Therapeutic waiver
- Medico-legal postmortems (Sec. 174 CrPC)
- Examination of an arrested accused [Sec. 53 (1) CrPC]
- Treatment of patient suffering from 'notifiable diseases' for greater community interest
- Psychiatric examination or treatment by court order
- Prisoners (new entrants)

- **Therapeutic privilege:** The '*therapeutic privilege*' enables the doctor to withhold from patient the information (as to risk), if the disclosure would pose serious psychological threat to the patient (e.g. malignancy or unavoidable total results). However, he should disclose full information to a competent relative of the patient.
- **Therapeutic waiver:** A competent person who is aware of being entitled to informed consent may give up his right by waiving it.

Consenting Ages for Treatment

- The age of consent for medical examination and treatment is legally accepted as ≥ 12 years.²⁵
- For a child < 12 years of age, or a patient of unsound mind, his/her guardian or person in whose custody he/she is, can give consent.
- For any invasive and diagnostic procedures, general anesthesia and surgical operations, age of consent is ≥ 18 years.
- Medico-legal examination is a contract between the doctor and the patient which has got some legal consequences. The age of consent for such examination is ≥ 18 years.

In accordance with the Indian Contract Act, a person is generally competent to contract (i) if he has attained the age majority (18 years in India), (ii) is of sound mind, and (iii) is not disqualified by any law to which he is subject to.

Impairments to reasoning and judgment which may make it impossible for someone to give informed consent include basic intellectual or emotional immaturity, high levels of stress such as PTSD, severe mental retardation or illness, senility, delirious intoxication, severe sleep deprivation, Alzheimer's disease and coma.

Reasons for Obtaining Consent

- i. To examine, treat or operate upon a patient without consent is *assault* (battery) in law, even if it is beneficial and done in good faith.²⁶
- ii. If a doctor fails to give the required information to the patient before taking consent to a particular operation/treatment, he may be charged for *negligence*.
- iii. Not taking consent is considered as deficiency in medical services under the section 2(1) of the Consumer Protection Act.

Rules of Consent

- i. Consent should be free, voluntary, clear, intelligent, informed, direct and personal. There should be no undue influence, fraud, misrepresentation of facts, compulsion, coercion or other consequences.
- ii. Informed consent is legally not required to be in writing, but provides evidence that consent was in fact obtained, if necessity arises.
 - It should be in a proper form and suitably drafted for the circumstances. The more specific the consent, the less likely it will be construed against the doctor or hospital in court.
 - The written consent should be witnessed by another person, present at the signing to prevent any allegation that the consent was forged or obtained under pressure.
- iii. Any procedure beyond routine physical examination, such as operation, blood transfusion or collection of blood requires expressed consent.
- iv. The doctor should explain the object of examination to the patient and patient should be informed that the findings would be included in the medical report.
- v. Patient should be informed that he has right to refuse to submit to examination and that the result may go against him. If he refuses, he cannot be examined.
- vi. A person ≥ 18 years of age can give valid consent to suffer any harm, which may result from an act not intended or not known to cause death or grievous hurt (**Sec. 87 IPC**).
- vii. A person can give valid consent to suffer any harm which may result from an act not intended or not known to cause death, done in good faith and for his benefit (**Sec. 88 IPC**).

viii. A child < 12 years of age and an insane person cannot give valid consent to suffer any harm which may result from an act done in good faith and for his benefit. The consent of the parent or guardian should be taken (**Sec. 89 IPC**).

Loco parentis (Latin, 'in place of a parent'): In an emergency involving children, when their parents or guardians are not available, consent is taken from the person-in-charge of the child, e.g. a school teacher can give consent for treating a child who becomes sick during a picnic away from home, or the consent of the principal of a residential school.

- ix. The consent given by an insane or intoxicated person, who is unable to understand the nature and consequences of that to which he gives his consent is invalid (**Sec. 90 IPC**).
- x. **Sec. 92 IPC** deals with cases of emergency, e.g. head injury requiring urgent decompression.²⁷ It states that any harm caused to a person in good faith, even without the person's consent, is not an offence, if the circumstances are such that it is impossible for that person to signify consent and has no guardian or other person in lawful charge of him from whom it is possible to obtain consent in time for the thing to be done in benefit. *In an emergency, the law implies consent.*²⁸
- xi. Even in emergency, unless patient is unconscious, the consent offered by the parents of major is void and amount to negligence.
- xii. Nothing is said to done in good faith which is done without due care and attention (**Sec. 52 IPC**).
- xiii. Consent of the in-mates of the hostel is necessary, if they are > 12 years of age. Within 12 years, the principal or warden can give consent.
- xiv. In civil cases, examination should not be done without the consent of the person to be medically examined.
- xv. In criminal cases, the victim cannot be examined without his/her consent. The court cannot force a person to get medically examined.
 - In rape cases, victim should not be examined without her written consent.
 - In medico-legal cases of pregnancy, delivery and abortion, the woman should not be examined without her consent.
- xvi. Under **Sec. 53 (1) CrPC**, an accused can be examined by a doctor by using reasonable force, if requested by a police officer (not below S.I.), if examination may provide evidence to the commission of the offence.

Whenever a female is to be examined, the examination *shall be made only by, or under the*

supervision of a female medical practitioner. Such an examination by a male doctor must not be carried out even in the presence of a female nurse [Sec. 53 (2) CrPC].

- xvii. Under **Sec. 54 CrPC**, an arrested person may be examined by a doctor at his request to detect evidence in his favor, a copy of the report is to be furnished by the doctor to the arrested person.
- xviii. Consent of one's spouse is not necessary for the treatment of other. Husband or wife has no right to refuse consent to any operation, which is required to safeguard the health of the partner.
- xix. For contraceptive sterilization and artificial insemination, consent of both husband and wife should be obtained.
- xx. The law provides the consent in any procedure made compulsory by state, e.g. mass immunization.
- xxi. In case of consent for donation of organ after death, the will of the deceased is enough.
- xxii. In prenatal diagnostic procedures, informed written consent of pregnant woman is obtained and a copy of the consent is given to the woman.
- xxiii. Pathological autopsy should not be carried out without the consent of next of kin of the deceased.²⁹
- xxiv. Medico-legal autopsy does not require any consent from the relatives of the deceased.

Consent is invalid if:

- It is not an informed consent.
- Given for committing a crime or an illegal act, such as criminal abortion.
- Obtained by misrepresentation or fraud.
- Given by one who had no legal capacity to give it, e.g. a minor or an insane person.

- **Substituted consent:** If a person in need of treatment is incapable of giving informed consent, consent (proxy consent) must be obtained from next of kin. The order of succession is generally spouse, adult child, parent and sibling.
- **Blanket (open) consent:** The consent practiced in most hospitals that cover almost everything a doctor might do to a patient without mentioning anything specific. It is of questionable legal validity.
- **Presumed consent** assumes that an individual agrees in principle to the said procedure; if not, he/she must withdraw his/her consent i.e. 'opt out'.

Medical Records

Medical records pertains to documents containing a chronological written account of the patient's medical history and complaints, physical findings, results of diagnostic tests, medications, therapeutic procedures and

day-wise progress notes recorded by a medical practitioner.

- It serves as a documentary evidence of the patient's illness, treatment and response to treatment. This record may be used as evidence in malpractice suits, claims of the insurances and compensations in personal injury suits.
- Records are the property of the hospital and the personal data contained in the medical record is considered confidential information and the property of the patient.
- Original hospital record of the medico-legal case (MLC) including X-ray/CT/MRI films should not be handed over to the police. However, if the investigating officer requests, a photocopy of the record (bed-head-ticket) may be supplied and a receipt of the same must be obtained.
- Medico-legal report (MLR) and post-mortem report (PMR) belongs to the requestor i.e. the police and the same is held by the doctor in fiduciary relationship.
- If affected party is asking for a record, then attested photocopy of the MLR may be handed over to the patient or his/her relative and after the requisite fee has been paid by applicant.
- Request for supply of copy of MLR or PMR under the RTI Act are not maintainable under Section 8(1) (e) & Section 8(1) (h). It should not be issued to third parties (including the accused) by the hospital authorities.
- Safe custody of the patient's confidential records, whether kept in conventional manner or in a computer, is the responsibility of the doctor.
- Patient's record cannot be used in clinics or conferences without the patient's consent.
- Hospitals have the right to use the records without consent for evaluating the quality of care and statistical purposes.
- X-ray films are the property of the hospital/doctor as part of the record, the patient is entitled for the skill and treatment, but copies of records and X-ray films may be given.
- Under the Directorate General of Health Services guidelines published in 'Hospital Manual', the responsibility of hospital to keep medical records is upto 5 years for outpatient department, and for inpatient medical records (including case sheets of medico-legal cases) it is upto 10 years.³⁰

Malingering (Shamming)

Definition: It is a conscious planned feigning or pretence to having a disease in order to achieve a specific goal.³¹

Reasons

- i. By soldiers or policemen to evade their duties
- ii. By prisoners to avoid hard work
- iii. By businessmen to avoid business contracts
- iv. By workmen to claim compensation
- v. By beggars to attract public sympathy
- vi. By criminals to avoid legal responsibility

Diseases feigned: Ophthalmia, neurasthenia, dyspepsia, aphasia, intestinal colic, sciatica, diabetes, vertigo, spitting of blood, epilepsy, ulcers, insanity, burns, paralysis of limbs, rheumatism, artificial bruise and lumbago.

- Usually the signs and symptoms do not conform to any known disease.
- Patients can distort or exaggerate their symptoms, but true simulation is very rare.
- History of the case should be taken from the person himself and his relatives or friends and any inconsistencies in this description of the symptoms are noted.
- A complete examination is essential after removing the bandages, if any, and washing the part.
- It can be diagnosed by keeping the patient under observation and watching him without his knowledge.

Euthanasia (Mercy Killing)

Definition: Euthanasia (Greek, good death) denotes producing painless death of a person suffering from hopelessly incurable and painful disease.

Types: It can be of two types (Diff. 1.3)

- i. Active euthanasia
- ii. Passive euthanasia

It can also be classified into:

- i. **Voluntary euthanasia:** Wherein the individual requests euthanasia, either during illness or before, if complete incapacitation is expected.
- ii. **Non-voluntary euthanasia:** Where an individual is incapable of perception and feeling and hence

cannot decide or distinguish between life and death, such a person cannot give informed consent, e.g. when resuscitation is not expected after severe brain damage as in coma patients or severely defective infants.

- iii. **Involuntary euthanasia:** Where an individual may distinguish between life and death, any medical killing is involuntary i.e. against the will of the person. It is ethically, morally and legally considered as murder. This is not to be confused with medical killing in cases of capital punishment.

Arguments against Euthanasia

- i. It is against medical ethics.
- ii. It would not only be for people who are 'terminally ill', but may be used to commit murder.
- iii. It can become a means of health care cost containment.
- iv. It may become non-voluntary.
- v. It is a rejection of the importance and value of human life.

Reasons for Euthanasia

- i. Unbearable pain.
- ii. High cost of medical treatment.
- iii. Right to commit suicide.
- iv. People should not be forced to stay alive.

- Recently, Supreme Court has allowed passive euthanasia in patients with permanent vegetative state but rejected active euthanasia. The decision has to be taken to discontinue life support either by parents or spouse or other close relatives or in the absence of any of them—by a person or a body acting as a 'next friend'.
- Belgium, Netherlands, Luxemburg, Thailand, New Zealand and US state of Oregon permit some forms of euthanasia.
- The terms 'physician-assisted suicide' and 'euthanasia' are often used interchangeably.
- By far, most reported cases of euthanasia concern cancer patients.

Differentiation 1.3: Active and passive euthanasia

S.No.	Feature	Active euthanasia	Passive euthanasia
1.	Definition	Positive merciful act, to end useless suffering or a meaningless existence	Discontinuing or not using extraordinary life-sustaining measures to prolong life ³²
2.	Principle	It is an act of commission	It is an act of omission
3.	Procedure	Administration of lethal doses of opium/barbiturate/sodium thiopental and then a muscle relaxant	Allowing death by not resuscitating a terminally ill or incapacitated patient or defective newborn infant
4.	Characteristic feature	Using measures that would hasten death	Not using measures that would delay death
5.	Followed in	Netherlands and Belgium	India and in some states of US (e.g. with holding tube-feeding)

MULTIPLE CHOICE QUESTIONS

1. **Medical etiquette:** *TN 05*
 - A. Deals with the conventional laws of the courtesy observed between members of the medical profession
 - B. Deals with legal responsibilities of the physician
 - C. Deals with the study of the effects of violence or unnatural disease
 - D. Deals with the moral principles which should guide members of the medical profession in their dealings
2. **Schedule that recognize medical qualifications awarded by institutions in India:** *AIIMS 11*
 - A. Schedule I
 - B. Schedule II
 - C. Schedule III Part I
 - D. Schedule III Part II
3. **Medical qualifications awarded by institutions outside India and recognized by MCI are registered in:** *AI 06*
 - A. First schedule of Indian Medical Council Act 1956
 - B. Second schedule of Indian Medical Council Act 1956
 - C. Part I of third schedule of Indian Medical Council Act 1956
 - D. Part II of third schedule of Indian Medical Council Act 1956
4. **Professional death sentence is given by:** *AFMC 11*
 - A. Central Health Ministry
 - B. Medical Council of India
 - C. Indian Medical Association
 - D. State Medical Council
5. **Appeal against penal eraser can be done in:** *WB 11*
 - A. State Medical Council
 - B. Medical Council of India
 - C. Central Health Ministry
 - D. State Health Ministry
6. **Prohibition of participation in torture by a doctor comes under:** *MP 10*
 - A. Declaration of Tokyo
 - B. Declaration of Helsinki
 - C. Declaration of Oslo
 - D. Declaration of Geneva
7. **Declaration of Helsinki is about:** *Orissa 11*
 - A. Organ transplantation
 - B. Human experimentation
 - C. Torture
 - D. Physician's oath
8. **Declaration of Oslo is related to which among the following:** *DNB 10*
 - A. Torture
 - B. Capital Punishment
 - C. Medical Termination of Pregnancy
 - D. Human experimentation
9. **In the court of law, professional secrecy can be divulged under:** *Manipal 11*
 - A. Doctrine of Common Knowledge
 - B. Privileged communications
 - C. Res ipsa loquitor
 - D. Therapeutic privilege
10. **Privileged communication is between:** *AI 09*
 - A. Doctor-patient
 - B. Doctor-medical council
 - C. Doctor-court
 - D. Doctor-police
11. **Dichotomy means:** *Manipal 04*
 - A. Fee splitting
 - B. Summons
 - C. Civil wrong
 - D. Employing touts to get patients
12. **Infamous conduct comprises of all, except:** *Delhi 11*
 - A. Adultery
 - B. Advertising
 - C. Procuring criminal abortion
 - D. Examining a patient without consent
13. **Professional death sentence is:** *TN 07*
 - A. Imprisonment for life
 - B. Rigorous imprisonment
 - C. Erasing of name from the medical register
 - D. Death by hanging
14. **False statement regarding Red Cross sign:** *AI 10*
 - A. Can be used by Army medical services
 - B. Punishable to use it without permission
 - C. Used by members of Red Cross
 - D. Can be used by doctors and ambulances
15. **If death of a patient occurs during surgery due to the negligence of the surgeon, then he can be charged under:** *UP 05; COMEDK 07; DNB 09*
 - A. 299 IPC
 - B. 300 IPC
 - C. 304 A IPC
 - D. 304 B IPC
16. **In civil negligence cases against the doctor, the onus of the proof lies with:** *AIIMS 11*
 - A. Doctor
 - B. Patient
 - C. First class judicial magistrate
 - D. Police not below the rank of sub-inspector
17. **Burden to prove defense lies with the doctor in case of:** *UP 11*
 - A. Mens rea
 - B. Res ipsa loquitor
 - C. Res judicata
 - D. Respondeat superior

1. A	2. A	3. B	4. D	5. C	6. A	7. B	8. C	9. B
10. C	11. A	12. D	13. C	14. D	15. C	16. B	17. B	

18. During an operation, if a pair of scissors is left in abdomen, the doctrine applicable is:
Kerala 04; JIPMER 10
- A. Res integra B. Res gestae
C. Res ipsa loquitur D. Res judicata
19. Doctrine of Common Knowledge is a variant of:
Orissa 11
- A. Medical maloccurrence
B. Novus actus interveniens
C. Res ipsa loquitur
D. Calculated risk doctrine
20. Contributory negligence is related with: *DNB 08*
- A. Eggshell skull rule
B. Master-servant rule
C. Avoidable consequence rule
D. Common knowledge rule
21. Medical negligence in which the patient contributed to the injury complained of: *DNB 09*
- A. Civil negligence
B. Corporate negligence
C. Contributory negligence
D. Criminal negligence
22. Contributory negligence is a defense in:
AP 08; Delhi 08; Orissa 11
- A. Civil negligence
B. Criminal negligence
C. Ethical negligence
D. Composite negligence
23. Vicarious responsibility pertains to: *Delhi 06*
- A. Patient's, contribution towards negligence
B. Hospitals contribution towards patient's damage
C. Responsibility for actions of a colleague
D. Responsibility of senior for actions of junior
24. False about informed consent: *AIIMS 07*
- A. Alternate procedures/treatment to be concealed from the patients
B. Patient must be told about the risks
C. Patient must be explained about the whole procedure
D. Patient must be explained in the language he understands
25. A 13-year-old boy attends the surgery without an adult accompanying him. He has a sore throat. Legally, a general practitioner must:
Karnataka 07
- A. Examine and prescribe as appropriate
B. Refuse to see him unless a responsible adult is present
C. Write to the parent asking them to come to the surgery
D. Examine but not prescribe
26. Examining the patient without consent amounts to:
Delhi 11
- A. Assault B. Unethical
C. Indecent D. Negligence
27. A doctor while examining the patient without consent in an emergency is protected under:
Manipal 06; Maharashtra 10
- A. Sec. 87 IPC B. Sec. 89 IPC
C. Sec. 90 IPC D. Sec. 92 IPC
28. A doctor has to do an urgent operation on an unconscious patient to save his life. But there are no relatives to take consent. He goes ahead without obtaining consent from anyone; he is using the principle of:
CMC (Vellore) 09
- A. Therapeutic privilege
B. Doctrine of implied consent
C. Therapeutic waiver
D. Doctrine of informed consent
29. Consent is required for: *UP 11*
- A. Mass immunization
B. Medico-legal autopsy
C. Pathological autopsy
D. Treatment of unconscious patient
30. Medical records to be preserved for: *Maharashtra 10*
- A. 1 year B. 3 years
C. 5 years D. 10 years
31. A person voluntarily acting like having a disease is said to be:
Kerala 09
- A. Hypochondriac B. Masochist
C. Gerontophilia D. Malingerer
32. In a comatose patient, when life support itself is withdrawn is:
Delhi 05
- A. Active euthanasia
B. Voluntary euthanasia
C. Involuntary euthanasia
D. Passive euthanasia

Acts Related to Medical Practice

2

The Transplantation of Human Organs Act, 1994¹

This Act was enacted for the removal, storage and transplantation of human organs for therapeutic purposes and for the prevention of commercial dealings in human organs. Under this Act 'human organ' means any part of a human body consisting of a structured arrangement of tissues which, if wholly removed, cannot be replicated by the body.²

Authority for removal of human organs

1. Any donor (\geq 18 years of age) may authorize the removal before his death of any organ of his body for therapeutic purposes.³
2. If any donor had in writing (in presence of 2 or more witnesses) authorized the removal of any organ after his death for therapeutic purposes, the person lawfully in possession of dead body should allow the doctor all reasonable facilities for removal.
3. When no such authority is there, person lawfully in possession of dead body can authorize the removal of any organ of the deceased person.
4. When human organ is to be removed, the medical practitioner should satisfy himself, that life is extinct in such body or where it is a case of brainstem death, the death has been certified by:
 - i. The doctor in-charge of hospital in which the brainstem death has occurred.
 - ii. An independent doctor, being a specialist nominated by the above in-charge from the panel of names approved by Appropriate Authority.
 - iii. A neurologist or a neurosurgeon, nominated by the in-charge from the panel.
 - iv. The doctor treating the person whose brainstem death has occurred.

Under any circumstances, brainstem death tests should not be performed by transplant surgeons or any doctor in the transplant team or a member of the Authorization Committee.⁴

Removal of human organs cannot be authorized wherein:

- i. An inquest may be required to be held in relation to such body.
- ii. A person who has been entrusted the body solely for the purpose of cremation.

Authority for removal of human organs in case of unclaimed bodies in hospital or prison

- If not claimed by any near-relatives within 48 h from time of death, the authority lies with the management of hospital or prison or by employee of the hospital or prison authorized by management
- If there is reason to believe that any near-relative of the deceased person is likely to claim the body even beyond 48 h, no authority should be given.

Authority for removal of organs from bodies sent for postmortem or pathological examination: Person competent under this Act can give authorization, if such organ will not be required for the purpose for which the body has been sent.

Restriction on removal and transplantation of human organs

- i. Human organ should not be removed from the body of donor *before his death* and transplanted into recipient, unless the donor is a *near-relative* (spouse, son, daughter, father, mother, brother or sister).
- ii. When donor authorizes the removal of his organs *after his death*, these organs may be transplanted into the body of *any recipient*.
- iii. If any donor authorizes the removal of his organs *before his death* to such recipient not being near-relative *by reason of affection or attachment towards the recipient*, the organs should not be removed and transplanted without prior approval of Authorization Committee.

Regulation of hospitals conducting the removal, storage or transplantation of human organs

- i. Hospital not registered under this Act should not be engaged in transplantation activities.

- ii. Medical practitioner should not conduct transplantation at any unregistered place under this Act.
- iii. The eyes and the ears may be removed at any place from dead body of any donor for therapeutic purposes by a doctor.

The doctor is also prohibited from removal or transplantation of human organs for any purpose other than therapeutic purposes.

Punishment for doctor on removal of human organs without authority

- i. Punishable with imprisonment for 5 years and fine upto ₹ 10,000.
- ii. Removal of his name from the register of State Medical Council for a period of 2 years for the 1st offence and permanently for the subsequent offence.

Punishment for commercial dealings in human organs

Punishable with imprisonment for a term from 2-7 years and fine of ₹ 10,000–20,000.

Duties of the Medical Practitioner Regarding Organ Transplantation

- I. In case of *live donation*, the doctor should satisfy himself before removing an organ from the donor that:
 - a. Donor has given his authorization.
 - b. Donor is in proper state of health and fit to donate the organ.
 - c. Donor is a near-relative of the recipient and sign a certificate after carrying out following tests on donor and recipient:
 - i. Tests for the antigenic products of HLA-A, HLA-B and HLA-DR using conventional serological techniques.⁵
 - ii. Tests to establish HLA-DR β and HLA-DQ β gene restriction fragment length polymorphisms.
 - iii. When the above tests do not establish genetic relationship, tests to establish DNA polymorphisms using at least two multilocus genes probe.
 - iv. When (iii) do not establish genetic relationship, further tests to establish DNA polymorphisms using at least five single locus polymorphism probes.

In case recipient is a spouse of donor, record the statements of both and sign a certificate.
- II. In case of *cadaveric donation*, the doctor should satisfy himself that:
 - i. Donor has authorized before his death, the removal of his organ for therapeutic purpose after his death, in presence of two or more witnesses, at least one of whom is a near-relative.

- ii. Person lawfully in possession of dead body has signed a certificate as specified under the Act.

III. A doctor, before removing organ from a *brainstem dead* person, should satisfy that:

- i. Certificate regarding the brainstem dead from the Board of medical experts is present.
- ii. In case of a person < 18 years, a certificate has been signed by either of the parents of such person.

- **Organs and tissues that can be transplanted:** Liver (one of the most difficult), kidney, pancreas, pancreatic islet cells, small intestine, lung, heart, corneas, skin graft, blood vessels, bone and hand.⁶
- Under Spanish law, every dead person can provide organs, unless the deceased person expressly rejected it (presumed consent). Nonetheless, doctors ask the family for permission.
- In US, law requires that the donor made a statement during his lifetime that he is willing to be an organ donor. Many states have sought to encourage the donations to be made by allowing the consent to be noted on the driver's license. Still, it remains an opt-in system rather than the Spanish opt-out system.

The Consumer Protection Act, 1986 (CPA) [Amendment in 1991, 1993, 2002]

Purpose: This Act was brought into existence for the protection of interests of the consumer and for settlement of consumer disputes, within a limited time frame and with fewer expenses. This enables a patient to make a complaint to a redressal forum in respect of a defective (negligent) service, if the service has been paid for.⁷

Redressal Agencies (Flow chart 2.1)

It is established at three different levels:⁷

- i. **District forum** headed by the District Judge, situated in each district of the State. The jurisdiction to entertain complaints is limited to those where the value of services is ≤ ₹ 20 lakhs.
- ii. **State Commission** headed by a Judge of a High Court, situated in the capital of each State.
- iii. **National Commission** is the apex consumer body headed by a Judge of the Supreme Court, situated in New Delhi and run by the Central Government.⁸

Limitation period: The District forum, State Commission and National Commission will not admit a complaint, unless it is filed within 2 years from the date of occurrence of the cause of action.¹⁰

Appeals

- Any appeal against the order of the District forum or the State Commission under this Act must be filed within 30 days of the order.

Flow chart 2.1: Structure of consumer forums/commissions

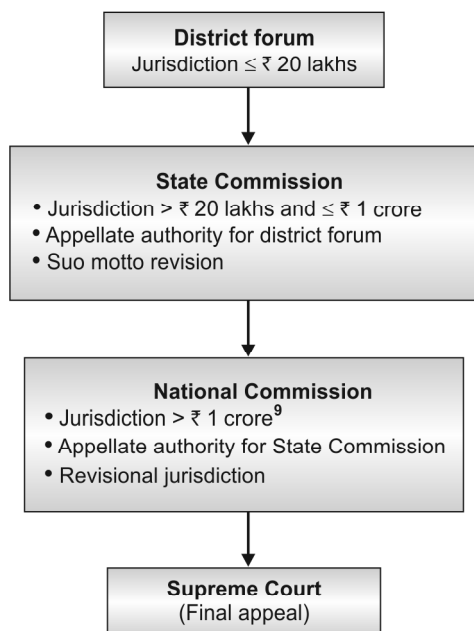

- Any person who is aggrieved by an order of the National Commission has a right to appeal to the Supreme Court (appellate authority) within a period of 30 days from date of the order.

Penalties

- For non-compliance of any order by these commissions, the person is punished with imprisonment ranging from 1 month to 3 years.
- For false complaints, the complainant has to pay as penalty to opposite party, not exceeding ` 10,000.

CPA and Medical Services (Table 2.1)

In the landmark decision of the Supreme Court (Indian Medical Association Vs VP Santha, 13.11.1995), medical

services were included in the Section 2(1) (o) of CPA and following was concluded:

- Services rendered at a government hospital, health centre or dispensary, non-governmental hospital or nursing home where no charge is taken from any person availing the service and all patients are given free service, is outside the purview of the expression 'service'.
- The medical services delivered on payment basis fall within 'service' as defined in Sec 2 (1) (o) of the Act.
- Similarly, hospital and nursing homes, which provide free service to some patients who cannot afford to pay and charges are required to be paid by persons who are in a position to pay, are covered under this Act.
- When a person has an insurance policy for medical treatment and all charges are borne by insurance company, the service rendered by a doctor would not be free of charge.

Further, this judgment concedes that the summary procedure prescribed by the CPA would suit only glaring cases of negligence and in complaints involving complicated issues requiring recording of the evidence of experts, the complainant can be asked to approach the civil courts.

Medical Indemnity Insurance

It is a contract under which the insurance company agrees, in return for the payment of premiums, to indemnify (cover) the insured doctor as a result of his claimed professional negligence.

Objectives of Medical Indemnity Insurance

- To look after and protect the professional interests of the insured doctor.

Table 2.1: Arguments against and for CPA

Arguments against CPA	Arguments for CPA
<ul style="list-style-type: none"> • There are Civil Courts, hence, no need of Consumer Courts. • The cases are hurried through because of time limits. • As there is no court fee, any one can appeal, increasing the litigation and wasting valuable time and energy of the physician. • No doctor would take risky cases for fear of litigation. • As there is no scope for testimony by medical experts, there is very likelihood of the justice being miscarried. • Deterioration of the doctor-patient relationship. Doctors would resort to defensive medicine, leading to increase in the cost of health care. 	<ul style="list-style-type: none"> • Civil courts have failed in delivery of justice at fewer expenses. • Cases are disposed of speedily (within 90 days). • Complainant is not required to pay court fee. So, even a poor victim of professional negligence can get compensation. • All principles of natural justice are followed, like in Civil Courts. • Both parties can produce their own evidence, lawyer and expert. Frivolous adjournments are not allowed to prevent the delay. • It is the consumer's choice to go to Consumer or Civil Court; once case is decided by consumer court, doctor cannot be punished for the same offence by a Civil Court.

- ii. To arrange, conduct and pay for the defense of such doctor.
- iii. To arrange all other professional assistance including pre-litigation advice.
- iv. To indemnify the insured doctor in respect of any loss or expense directly arising from actions, claims and demands against him on grounds of professional negligence.

The Workmen's Compensation Act, 1923

This Act provides for the payment of compensation to workmen for injuries sustained by them in an accident, arising out of and in the course of employment.

- If a workman is killed, his dependants will be entitled to compensation for his death.
- The amount of compensation depends upon whether the injury has caused death, permanent total disablement or permanent partial disablement.
- The employer will not be liable to pay compensation in respect of any injury which results in death or permanent total disablement caused by an accident, if the workman at the time of sustaining injury was under the influence of drink or drugs or willfully disregarded or removed any safety guard or other device provided for his safety.

The Medical Termination of Pregnancy (MTP) Act, 1971

The original Act of 1971 came into force on 1st April 1972 and amended in 2002 to provide for the termination of certain pregnancies by the registered medical practitioners (RMP) for protection and preservation of the lives of women.¹¹

Indications for Termination of Pregnancy¹²

- i. **Therapeutic:** In order to prevent injury to the physical health of pregnant woman. Indications are:
 - Cardiac disease (Grade III and IV)
 - Chronic glomerulonephritis
 - Intractable hyperemesis gravidarum
 - Malignant hypertension
 - Epilepsy/Insanity
 - Cervical or breast carcinoma
 - Diabetes with retinopathy
 - Toxemia of pregnancy
- ii. **Eugenic:** Risk of the child being born with serious physical or mental abnormalities. Indications are:
 - Mother exposed to teratogenic drugs (warfarin) or radiation exposure (> 10 rads) in early pregnancy.

- German measles (Rubella), chicken pox, viral hepatitis or other viral infections, if contacted within 1st trimester.
- Structural (anencephaly), chromosomal (Down's syndrome) or genetic abnormalities of the fetus.
- Parents have inheritable mental condition or chromosomal abnormalities.
- iii. **Social:** Almost the sole indication, to prevent grave injury to the physical and mental health of the pregnant lady. Conditions include:
 - Unplanned pregnancy with low socioeconomic status (80% of cases).
 - Pregnancy in a woman as a result of contraceptive failure. All the pregnancies can be terminated using this criterion.
- iv. **Humanitarian:** Pregnancy caused by rape.
- v. **Environmental**
 - When a woman suffering from some serious disease, has no one to help in her domestic work and will be incapable of bearing the strain of rearing a child.
 - If there is already a subnormal child, who demands considerable attention, making it difficult to look after the new arrival.

MTP Act Rules

Length of pregnancy: Under MTP Act, pregnancy cannot be terminated after 20 weeks of pregnancy.¹³ Above 20 weeks, the pregnancy can be terminated only on therapeutic considerations, i.e. to save the life of the mother. In such cases, decision can be taken by a single doctor.

- Upto 12 weeks of pregnancy, it can be terminated on the opinion of a single doctor.
- Between 12-20 weeks, decision should be taken jointly by two doctors.^{14,15}

Place where MTP can be Performed

MTP's can only be conducted at:

- i. A hospital established or maintained by Government, or
- ii. A place approved by Government or a District level Committee with the Chief Medical Officer or District Health Officer as the Chairperson of the said Committee.

Qualification and Experience of RMP

For RMP conducting MTP upto 12 weeks

The doctor should have the experience of assisting an RMP in conducting 25 cases of MTP, out of which at

least 5 cases should have performed independently, in an approved hospital by the Government.

For RMP's conducting MTP between 12-20 weeks period

The doctor should have either:

- Post-graduate degree/diploma in Obs & Gynae,¹⁶
- Six months of house surgency in Obs & Gynae or
- One year or more in the practice of Obs & Gynae at any hospital.

Emergency cases: Pregnancy can be terminated by any RMP, even without required experience at any place, irrespective of duration of pregnancy, if it is necessary to save the life of pregnant woman.

Consent: Consent of woman is mandatory, except when she is minor (< 18 years) or mentally ill, where consent of the guardian is obtained. Consent of husband is not necessary.

Maintenance of register: The head of the hospital should maintain a register, recording the details of the patient undergoing termination of pregnancy for a period of 5 years, and professional secrecy should be maintained.

Contravention of the rules by the doctor: Liable to be punished with rigorous imprisonment of 2-7 years and if he is a government servant, he will be liable to face disciplinary action including dismissal from service.

Methods to bring about abortion are given in Table 2.2.

- English common law considered abortions before 'quickening' to be morally and legally acceptable.
- In the UK, as in some other countries, two doctors must first certify that an abortion is medically or socially necessary before it can be performed.

Complications are much less in legal abortions done before 8 weeks (5%), but it is about five times more in mid-trimester termination, irrespective of the method employed.

- Deaths during legal abortions are rare. Such deaths are due to:
 - i. Hemorrhage and shock due to trauma, atonic uterus or incomplete abortion
 - ii. Infection
 - iii. Emboli (thrombotic, amniotic, or air)
 - iv. Complications of anaesthesia.
- Deaths by *method of abortion* in developed countries (in decreasing rate of occurrence):
 - i. Hysterectomy/hysterotomy
 - ii. Instillation methods (including saline)
 - iii. Dilatation and evacuation
 - iv. Dilatation and curettage.
- Curettage is the most common method of abortion used and results in the most deaths because of this, even though it has the lowest rate of death by type of procedure.
- Deaths due to hemorrhage and sepsis are complications of perforation of the uterus. While perforation is a recognized complication of any procedure involving instrumentation of the uterus, death due to sepsis/hemorrhage should not occur and strongly suggest the possibility of medical negligence.
- In India, contrary to the western countries, the mortality from saline method has been found to be much higher as compared to termination by abdominal hysterectomy.

The Prenatal Diagnostic Techniques (PNDT) Act, 1994 (Amendment 2002)

The Prenatal Diagnostic Techniques (Regulation and Prevention of Misuse) Act, 1994, was enacted in order to check female feticide.²⁰

- 'Prenatal diagnostic procedures' means any gynecological, obstetrical or medical procedures such as ultrasonography, fetoscopy, samples of amniotic fluid, chorionic villi, embryo, blood or any other tissue or fluid of a man, or of a woman before or after conception, for conducting any type of analysis or prenatal diagnostic tests for selection of sex before or after conception.

Table 2.2: Methods of inducing abortion under MTP Act

1st trimester (upto 12 weeks) ^{17,18}	2nd trimester (upto 20 weeks) ¹⁹
<p>Medical</p> <ul style="list-style-type: none"> • Mifepristone (RU-486) • Mifepristone and misoprostol (PGE₁) • Methotrexate and misoprostol • Tamoxifen and misoprostol <p>Surgical</p> <ul style="list-style-type: none"> • Manual vacuum aspiration (MVA) • Dilatation and evacuation (D & E) • Suction evacuation and/or curettage 	<ul style="list-style-type: none"> • Dilatation and evacuation (13-14 weeks) • Intra-uterine instillation of hyperosmotic solution <ol style="list-style-type: none"> i. Intra-amniotic hypertonic urea (40%), saline (20%) ii. Extra-amniotic: Ethacrydine lactate, prostaglandins (PGE₂, PGF_{2α}) • Prostaglandins [PGE₁, PGE₂, PGF_{2α}]: Intravaginally, intramuscularly or intra-amniotically • Oxytocin infusion • Hysterotomy

- 'Prenatal diagnostic test' means ultrasonography or any analysis of amniotic fluid, chorionic villi, blood or any tissue or fluid of a pregnant woman or conceptus conducted to detect any abnormalities or diseases as given in clause 2.
- 'Prenatal diagnostic techniques' includes all prenatal diagnostic procedures and prenatal diagnostic tests.
Any medical practitioner or any other person should not conduct or aid in conducting any prenatal diagnostic techniques at a place other than a place registered under this Act.

Regulation of Prenatal Diagnostic Techniques

Clause 1: Any place including a registered genetic counseling centre, laboratory or clinic should not be used for conducting prenatal diagnostic techniques except for the purpose given in clause 2 and after satisfying any of the conditions in clause 3.

Clause 2: Prenatal diagnostic techniques should be used for the detection of any of the following abnormalities:

- Chromosomal abnormalities.
- Genetic metabolic diseases.
- Hemoglobinopathies.
- Sex linked genetic diseases.
- Congenital anomalies.

Clause 3: Prenatal diagnostic techniques should be used in pregnant women, if any of the following conditions are satisfied:²¹

- Age \geq 35 years.
- Undergone two or more spontaneous abortions or fetal loss.
- Has been exposed to potentially teratogenic agents, such as drugs, radiations, infections or chemicals.
- The pregnant woman or her spouse has a family history of mental retardation or physical deformities, such as spasticity or any other genetic disease.

Written consent of pregnant woman and prohibition of communicating the sex of fetus

- Prenatal diagnostic procedures should not be conducted unless:
 - The doctor has explained all known side-effects and after-effects of such procedures to the patient.
 - He has obtained her written consent in a language which she understands.
 - A copy of her written consent obtained above is given to the pregnant woman.
- The person conducting prenatal diagnostic procedures including ultrasonography *should not communicate to*

the pregnant woman or her relative, the sex of the fetus by words, signs or in any other manner; and should keep a complete record of the patient.

Offences and Penalties

- Any person, organization, genetic counseling center/ laboratory/clinic should not issue any advertisement in any manner regarding facilities of prenatal determination of sex.
- Any medical person who contravenes the provisions of this Act should be punished with an imprisonment upto 3 years and fine upto ` 10,000 and on any subsequent conviction with imprisonment upto 5 years and fine upto ` 50,000.
- His name will be removed from the register of the Council for a period of 5 years for the first offence and permanently for the subsequent offence.
- Any person who seeks the aid of genetic counseling laboratory/clinic or medical practitioner for purposes other than specified above, should be punished with imprisonment upto 3 years and fine upto ` 50,000 and on any subsequent conviction with imprisonment upto 5 years and fine upto ` 1 lakh.
- Every offence under this Act should be cognizable, non-bailable and non-compoundable.

- **Non-bailable:** The magistrate has the power to refuse bail and remand a person to judicial or police custody.
- **Non-compoundable:** Case (e.g. rape, 498A) which cannot be withdrawn by the petitioner.

The Delhi Artificial Insemination (Human) Act, 1995

- This Act is applicable in the state of Delhi. It regulates the donation, sale and supply of human semen and ovum for the purpose of artificial insemination. It requires registration and yearly renewal by any person intending to carry on a semen bank.
- The semen bank before accepting the semen for artificial insemination should:
 - Test the donor for the presence of HIV 1 and 2 antibodies by ELISA.
 - Screen for HIV surface antigen and if found negative, the donor shall be allowed to donate.
- The donated semen should be stored either by cryopreservation for a minimum period of 3 months in order to exclude window period of HIV 1 and 2 infections in the donor.
- Second ELISA test is performed on the donor after 3 months, and if negative, the semen should then be used.
- It is also required by the practitioner:
 - Not to segregate the XX/XY chromosomes for artificial insemination.

- ii. Seek the written consent of the recipient for using the semen on the basis of only one ELISA test, being negative, where facilities for cryopreservation and liquid nitrogen for semen are not available.

The Mental Health Act, 1987

The Act repealed the Indian Lunacy Act, 1912 and the Lunacy Act, 1977 (J & K Act of 1977). This Act has the following provisions:

- Guidelines for establishment and maintenance of psychiatric hospitals/nursing homes at the centre and state and authorities to regulate these centres.
- Procedure for admission and detention of mentally unsound persons, in psychiatric hospitals.

Restraint of an Insane

It may be:

- Immediate restraint
- Admission in psychiatric hospital.

Immediate restraint

It is done in case of:

- i. An insane person who is dangerous to himself or to others, or likely to injure, or wastefully spend his property or that of others.
- ii. Person suffering from delirium due to disease.
- iii. Person suffering from delirium tremens.

Immediate restraint is done under the personal care of attendants, e.g. by safely locking-up in a room. The consent of the lawful guardian of the insane person has to be taken, but if there is no time to take the consent, he can be immediately restrained. Such restraint is lawful till the danger exists.

Admission in psychiatric hospital

The following procedures are adopted:

- i. **On voluntary basis:** Any major person, who considers himself to be mentally ill person, may request the doctor in-charge of psychiatric hospital for admission and treatment. In case of a minor, the guardian may make such request.
The doctor should make an inquiry as deem fit within 24 h, and if satisfied that the person requires treatment as an in-patient, he may admit such person.
- ii. **Under special circumstances:** A mentally ill person who is unable to express his willingness for admission voluntarily, can be admitted in a psychiatric hospital for a period of 90 days, if

an application is made by a relative/friend and accompanied by two medical certificates, one of which should be by a government medical officer.

- iii. **Reception order on application:** The doctor in-charge of a psychiatric hospital, husband or wife or any relative can make an application to the Magistrate. The Magistrate must consider the allegations in the petition and the evidence of mental illness as disclosed by the medical certificates. If he is satisfied, he may pass a reception order.
- iv. **Admission of a mentally ill prisoner:** He can be admitted into any psychiatric hospital by an order passed by an appropriate authority.
- v. **Admission of an escaped mentally ill person:** He can be retaken by any police officer or worker of the psychiatric hospital and readmitted into the same hospital.

Observation of a mentally ill patient: For diagnosis and certification, an alleged mental patient may be kept under observation (upto 10 days) of a psychiatrist with an order from a magistrate. If diagnosis cannot be reached during this period, then the magistrate can order for another 10 days observation (upto a maximum of 30 days).

Content of Medical Certificates

The two medical certificates issued by two doctors must contain a statement that each of the medical practitioner:

- i. Has independently examined the alleged mentally ill person.
- ii. Formed his opinion on the basis of his own observations and from the particulars communicated to him.
- iii. In their opinion, the alleged mentally ill person is dangerous to self or others because of the mental disorder which warrants detention of such person in a psychiatric hospital.

Discharge of a Mentally Ill Person

- i. Voluntary patients should be discharged within 24 h of the receipt of request for discharge made by the patient or the guardian. If medical board is of the opinion that such patient needs further treatment, the patient should not be discharged, and treatment should be continued for a period not exceeding 90 days at a time.
- ii. A mentally ill person who is admitted on an application by a relative/friend can himself or a relative/friend can apply to the Magistrate for

discharge. The Magistrate, after making an enquiry, can either allow or dismiss the application.

- iii. A mentally ill person detained under 'reception order' may be discharged, if the person on whose application admission order was made, applies in writing to the doctor in-charge.
 - iv. Any relative/friend of a mentally ill person can make an application for discharge to the doctor in-charge, who should forward it with his remarks to the authority under whose order the person was detained. Such authority can pass an order of discharge.
- *Provides for judicial inquisition regarding possession of property by alleged mentally ill person, custody of the person, and management of his property:* If the court is of the opinion that the mentally ill person is not capable of looking after himself and property, a guardian is appointed and if he is incapable of looking after his property only, a manager is appointed.
 - Provides for the liability to meet cost of maintenance of a mentally ill person detained in psychiatric hospital.
 - *Provides for protection of human rights of mentally ill persons:* The patient should be treated with dignity, without any cruelty and should not be involved in any research, if it is of no direct benefit to the patient and without consent.
 - *Provides for penalties and procedure for awarding the same, for violation of the provisions of the Act:* If a mentally ill person is received or detained against the provisions of the Act, the punishment is imprisonment upto 2 years and/or fine.

The Clinical Establishments (Registration and Regulation) Act, 2010 (CEA)

The CEA lays down the requirement for a National and State Council for mandatory registration of clinical establishments and provides for penal consequences in case of non-registration. It is implemented in the Union Territories, Arunachal Pradesh, Mizoram, Himachal Pradesh and Sikkim. Rest of the states has to adopt the CEA by passing resolutions in the Assemblies since the health is a State subject.

Important features

- As per **Sec. 12 (2)** of CEA, medical practitioners will have to provide 'facilities to stabilize the emergency medical condition of any individual who is brought to his/her clinical establishment.'
- **Clinical establishment** means a place established as an independent entity—a hospital, maternity or nursing home, dispensary, clinic or an institution that offers services (diagnostic or investigative) in any recognized system of medicine. It includes a clinical establishment owned or controlled by the Government, trust (public or private), corporation (including a society), local authority or a single doctor, but does not include the clinical establishments of the Armed Forces.
- Penalties
 - Any person contravening any provision of this Act, if (no penalty is provided elsewhere, is fined upto)
 - ˆ 10,000 for the 1st offence, upto ˆ 50,000 for the 2nd offence and upto ˆ 5 lakh for any subsequent offence.
 - Penalty for non-registration: Fine is upto ˆ 50,000 on 1st contravention, upto ˆ 2 lakh for 2nd contravention and upto ˆ 5 lakh for any subsequent contravention.
 - Any person, who knowingly serves in a clinical establishment not registered under this Act is fined upto ˆ 25,000.

MULTIPLE CHOICE QUESTIONS

1. **Transplantation of Human Organs Act was passed in:** *AI 05, 06*
 - A. 1994
 - B. 1996
 - C. 2000
 - D. 2002
2. **Which of the following is outside the purview of Transplantation of Human Organs Act?** *Orissa 11*
 - A. Eyes
 - B. Eardrums
 - C. Ear bones
 - D. Bone marrow
3. **Minimum age to give consent for organ donation for therapeutic purposes:** *DNB 09*
 - A. 12 years
 - B. 18 years
 - C. 21 years
 - D. No such law in action
4. **All are involved in brain-stem death certification under the Transplantation of Human Organs Act, except:** *MP 10*
 - A. The doctor, in charge of hospital in which the brain-stem death occurred.
 - B. A neurologist or a neurosurgeon, nominated by the in-charge, from the panel.
 - C. A doctor involved in the transplantation procedure.
 - D. The doctor treating the person whose brain-stem death has occurred.
5. **What is matched for organ transplantation?** *Jharkhand 11*
 - A. mDNA
 - B. HLA
 - C. RNA
 - D. Blood group
6. **Which of the following organs obtained from cadaver is not used for transplant?** *AI 11*
 - A. Blood vessels
 - B. Lung
 - C. Liver
 - D. Urinary bladder

1. A

2. D

3. B

4. C

5. B

6. D

7. Consider the following statements: *UPSC 09*
- The Consumer Protection Act (CPA) applies to all goods, but not any services.
 - The CPA provides for establishing four-tier consumer dispute redressal machinery at the national, state, district and block levels.
- Which of the statements given above is/are correct?
- A. 1 only B. 2 only
C. Both 1 and 2 D. Neither 1 nor 2
8. Apex body dealing with medical negligence cases: *Maharashtra 11*
- A. MCI
B. State Medical Council
C. Supreme Court
D. National Consumer Commission
9. Maximum amount that can be received under the Consumer Protection Act: *Manipal 08*
- A. 25 lakhs B. 50 lakhs
C. 75 lakhs D. > 100 lakhs
10. Doctor liable to get sued by patient till what time limit from alleged negligence: *JIPMER 10; Maharashtra 09, 11*
- A. 1 year B. 2 years
C. 3 years D. 4 years
11. MTP Act was passed in the year: *Manipal 09*
- A. 1971 B. 1991
C. 2001 D. 2002
12. MTP can be indicated in all, except: *PGI 05*
- A. Pregnancy caused by rape
B. Husband is willing but mother-in-law is not agreeing
C. If maternal health is in danger
D. Pregnancy due to contraceptive failure
13. MTP Act in India does not permit termination of pregnancy after: *MAHE 03; Delhi 06; AP 06*
- A. 12 weeks B. 16 weeks
C. 20 weeks D. 24 weeks
14. According to MTP Act, 2 doctors opinion is required when pregnancy is: *PGI 03; Maharashtra 09*
- A. 10 weeks B. 6 weeks
C. > 12 weeks D. > 20 weeks
15. Assertion (A): Abortion may be induced at twenty weeks of gestation without second medical opinion.
Reason (R): The conditions for medical termination of pregnancy have been liberalized in India. *UPSC 03*
- A. A is false but R is true
B. Both A and R are true
C. A is true but R is false
D. A and R are false
16. Under the MTP Act, routine termination of pregnancy can be done by: *Rohtak 08*
- A. Any registered medical practitioner (RMP)
B. Any RMP with MD/MS degree in Obs and Gynae
C. Any RMP with 6 months residency in any department
D. Any RMP with a minimum of 3 months residency in Obs and Gynae
17. First trimester abortion uses all, except: *TN 09*
- A. Mifepristone
B. Extra-amniotic ethacrydine lactate
C. Dilatation and evacuation
D. Suction evacuation
18. Abortion at 8 weeks of pregnancy can be done by: *AP 10; Jharkhand 11*
- A. Suction evacuation
B. Hypertonic saline
C. Ethacrydine lactate
D. Oxytocin
19. In extra-amniotic 2nd trimester MTP, which of the following is used: *PGI 04*
- A. Ethacrydine lactate
B. Prostaglandins
C. Hypertonic saline
D. Glucose
20. PNDT Act was introduced in the year: *Punjab 08*
- A. 1990 B. 1994
C. 2000 D. 2002
21. In PNDT Act, which one of the following is NOT a ground for carrying out prenatal test: *AI 03*
- A. Pregnant woman above 35 years of age
B. History of two or more spontaneous abortion
C. When fetal heart rate is 160/min at fifth month
D. History of exposure to teratogenic drugs
22. Acts passed before 1980, except: *PGI 09*
- A. Factories Act
B. Employees' State Insurance Act
C. Workmen's Compensation Act
D. Mental Health Act
- The Factories Act was enacted in 1948 which governs the health, safety and welfare of workers in factories.
 - The Employees' State Insurance Act, 1948 envisaged to protect the interest of workers in contingencies such as sickness, maternity, temporary or permanent physical disablement or death due to employment injury.

7. D 8. D 9. D 10. B 11. A 12. B 13. C 14. C
15. A 16. B 17. B 18. A 19. A & B 20. B 21. C 22. D

- **Indian Penal Code (IPC) 1860:** It is a comprehensive code that deals with substantive criminal law of India. It defines various offences and prescribes code for punishment in the court of law.¹
- **Criminal Procedure Code (CrPC) 1973:** It deals with procedures of investigation and the mechanism for punishment of offences against the substantive criminal law.
- **Indian Evidence Act (IEA) 1872:** It relates to evidence on which the court come to conclusion regarding facts of the case. It is common to both the criminal and civil procedure.

Inquest

Definition: An inquest (Latin *quaesitus*: to seek) is an inquiry or investigation into the cause of death where death is apparently not due to natural causes.

It is done in cases of:

- Sudden death.
- Suicide, homicide and infanticide.

- Death from accident, poisoning, drug mishap or machinery.
- Unexplained death or death from burns or fall from height.
- Death under anesthesia or on operation table or from postoperative shock.
- Death due to medical negligence or within 24 h of admission in a hospital.
- Death of a convict in jail, police custody, mental hospital or correctional school.
- Dowry deaths (in India).
- Death due to any industrial disease (not held in India).

Types of Inquest

Two types of inquests are held in India: (Diff. 3.1)

- Police inquest (most common)
- Magistrate inquest

Other types of inquests (not held in India):

- Coroner's inquest
- Medical examiner system
- Procurator fiscal

Differentiation 3.1: Magistrate and police inquest

S.No.	Feature	Magistrate inquest	Police inquest
1.	Investigating officer	Inquest conducted by DM, SDM, and Magistrate who is qualified and experienced	Conducted by police officer who is not qualified in law or medicine
2.	Informing magistrate	Need not inform anyone	Needs to inform the magistrate of the area
3.	Types of cases handled	Can hold inquest in all cases of suspicious deaths	Cannot hold inquest in cases of death in custody, jail, police firing or dowry deaths
4.	Witnesses	Police helps the magistrate. Does not require signature of the witnesses	<i>Panchas</i> help, who are chosen at random to sign the report
5.	Warrant for arrest	Can issue arrest warrant of the accused	Cannot issue warrant, but can arrest an accused in cognizable offence
6.	Exhumation	Can order a body to be exhumed	Cannot order
7.	Autopsy	Does not send dead bodies for autopsy indiscriminately	Sends dead bodies for autopsy indiscriminately
8.	Analysis of viscera	Can order chemical analysis of viscera	Cannot order
9.	Quality of investigation	Superior to police inquest	Inferior to magistrate inquest

Police Inquest

- The provision for holding of inquest is outline in **Sec. 174 CrPC**.
- Police inquest is held by a police officer (known as the Investigation Officer—IO) not below the rank of senior head constable in all cases of unnatural deaths with the exceptions mentioned under Magistrate inquest.
- An inquest is a fact finding inquiry, to establish reliable answers to four important questions. The *first* relates to the identity of the deceased, the *second* to the place of his death, the *third* to the time of death and the *fourth* question is related to his apparent cause of death (whether accidental, suicidal and homicidal or caused by animal).²
- The rules of procedure forbid any expression of opinion on any other matter.
- It is not the requirement of law to mention the name of the accused, the weapon carried by them and who were the witnesses of the assault in the inquest report.
- Even if there is some discrepancy between the inquest report and the postmortem report, the list of injuries mentioned in the inquest report cannot prevail over the details of the postmortem report.

Procedure

- Police officer, on receipt of information of death, gives intimation to the nearest Executive Magistrate empowered to hold inquests.³
- He then proceeds to the place of occurrence and holds an inquiry into the matter, in the presence of two or more respectable inhabitants of the locality (witnesses). The witnesses are called *panchas*.
- The inquest report so prepared is known as *panchnama*.
- If no foul play is suspected, the dead body is handed over to the relatives for disposal.
- In suspicious cases, the body is sent for postmortem examination to the nearest authorized doctor with a requisition and a copy of the inquest.
- The report is then forwarded to the District Magistrate or sub-divisional magistrate (SDM).

The police officer may summon persons who appear to know the facts of the case and the person is bound to attend and answer questions put to him (Sec. 175 CrPC). Refusal to answer questions is punishable under **Sec. 179 IPC** for a term of upto 6 months and/or fine of ₹ 1000.

Magistrate Inquest

Inquest is conducted by District Magistrate, Judicial Magistrate, SDM or any Executive Magistrate empowered by State Government, such as the Sub-Collector or Tehsildar.⁴

- **Sec. 176 CrPC** deals with inquiry by Magistrate into cause of death.^{5,6}
- It is practiced all over India.
- It is not held routinely, but only when especially indicated.

Indications for Magistrate inquest⁷

- Deaths due to police firing.
- Disappearance or death of a person in police custody or during police interrogation.⁸
- Death of a convict in jail.
- Exhumation cases (where the body is dug out of a grave).
- Rape alleged to have been committed on any woman in the custody of the police.
- Dowry deaths (suicide/death of a woman within 7 years of marriage).⁹
- Admission of a mentally ill person in a psychiatric hospital under certain provisions of Mental Health Act, 1987.

In addition to the above, the magistrate reserves the right to hold an inquest in any other case of death which he deems fit.

The Judicial Magistrate or the Metropolitan Magistrate holding the inquest should forward the body for examination by the Civil Surgeon or any other doctor appointed by the State Government within 24 h of the death of a person.

Purpose: The main intention behind the magistrate inquest is to ensure that:

- No person is unjustly deprived of his liberty and his rights as citizen.
- No person, who is deprived of his liberty, can die as a result of neglect or brutality of the people who are in-charge of him.
- In case of a person who is already buried, there is no doubt with regards to identity, cause of death or manner of death.
- The death is not a 'dowry death'.

Coroner's Inquest (Diff. 3.2)

- **Coroner** is usually an advocate, attorney or 1st class Magistrate with 5 years experience or a Metropolitan Magistrate.
- He used to be appointed by state government to inquire into causes of unnatural or suspicious deaths.

Open verdict means an announcement of the commission of crime without naming the criminal (when the perpetrator of crime is not identified).

In India, the coroner system was introduced by the British in 1902 in the 'Presidency Towns' of Kolkata and Mumbai. Later on, the system was removed from Kolkata, and still later from Mumbai (since 26th July 1999).

Differentiation 3.2: Coroner's and Magistrate's court

S.No.	Feature	Coroner's court	Magistrate's court
1.	Type of court	Court of inquiry	Court of trial
2.	Accused	Need not be present during trial	Should be present during the trial
3.	Punishment	No power to impose fine/punish	Can impose fine and punishment
4.	Contempt of court	Can punish a person for contempt, if committed within the premises of his court	Can punish whether offence is committed within or outside the premises of court
5.	Status in India	Not followed	Followed

Medical Examiner System

- This type of inquest is conducted in most of the states of US. A medical man (Board Certified or Board eligible forensic pathologist) is appointed to hold an inquest.
- He/she visits the scene of crime/accident to gather first hand evidence and interview people to obtain as much information as possible regarding circumstances of death.
- He/she performs autopsy and correlates autopsy findings with evidence and determines the cause and manner of death.
- The system is superior to other inquest where non-medical men/coroner conducts the inquiry.
- But the medical examiner does not have any judicial powers, e.g. he cannot examine the witness under oath and cannot authorize the arrest of any person.

Procurator fiscal is a public prosecutor in Scotland and has powers in the investigation of criminal matters. Amongst his roles is the investigation of sudden, unexplained or suspicious deaths including fatal accidents. He can request an autopsy to be performed by a forensic pathologist and presents cases for the prosecution in the Courts.

Courts of Law

Two types:

- Civil
- Criminal.

Criminal courts in India are of four types (Flow chart 3.1):

1. **Supreme Court** is the highest judicial tribunal and the highest court of appeal; located in New Delhi. It has the power of supervision over all courts in India. The law declared by it is binding on all courts.
2. **High Court** is usually located in the capital of every State and is the highest court in the state. Judges in a High Court are appointed by the President of India in consultation with the Chief Justice of India and the governor of the state.¹⁰ It deals with Appeals from lower courts and writ petitions in terms of Article 226 of the Constitution.¹¹ It may try any offence and pass any sentence authorized by law (Sec 28 CrPC).

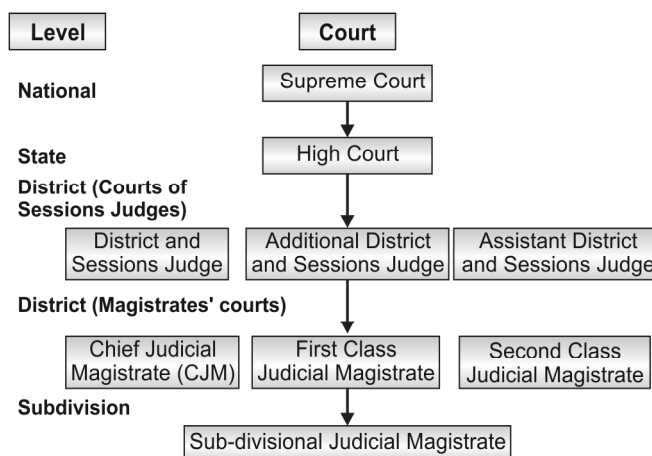
Flow chart 3.1: Criminal courts in India

3. **Sessions Court** is usually located at the district headquarters and is therefore also known as *District Session Court* and presided over by a 'District and Sessions Judge'.

- He is known as a District Judge when he presides over a civil case and a Sessions Judge when he presides over a criminal case. The district judge is also called 'Metropolitan Session Judge' when he is presiding over a 'Metropolitan area'.
- Appointment of district Judge is done either by the state Government in consultation with the High court or by way of elevation of judges from courts subordinate to district courts.
- It can try cases which have been committed to it by a Magistrate.
- It can pass any sentence authorized by law including death sentence which is subject to confirmation by the High Court (Sec. 28 CrPC).

Assistant Session Court can pass any sentence authorized by law except a death sentence or imprisonment for a term exceeding 10 years.

4. **Magistrates' Courts** are of three types:
 - Chief Judicial Magistrate
 - First Class Judicial Magistrate
 - Second Class Judicial Magistrate.

- In metropolitan cities with more than one million population, the Chief Judicial Magistrate and First Class Judicial Magistrate are designated as Chief Metropolitan Magistrate and Metropolitan Magistrate respectively.
- The High Court appoints the Judicial Magistrate of first class to the Chief Judicial Magistrate (Sec. 12 CrPC).¹²
- Powers of Magistrate court is given in Table 3.1 (Sec. 29 CrPC). Higher court can enhance the sentence awarded by it.

Special Magistrates: They could be either Metropolitan Judicial or Executive Magistrates and may be appointed for a special purpose, e.g. to try cases of rioting.

- Under the **Juvenile Justice Act, 2000**, a Board to try juvenile offenders should consist of a Judicial Magistrate of first class (or Metropolitan Magistrate) and two social workers, out of whom at least one should be a woman.¹⁵ They will form a Bench and have the powers of Judicial Magistrate of the first class, and the Magistrate on the Board is designated as the principal Magistrate.
- As per the Act, 'juvenile' or 'child' means a person who has not completed 18th year of age.¹⁶
- If the juvenile is found guilty of serious offence, he/she is not given life imprisonment or committed to prison, but sent to reformatory school (formerly called as Borstal) or special home for rehabilitation.

Under the **Code of Criminal Procedure (CrPC)**, offences are classified as:

- **Bailable offences** are those in which bail can be granted by the law. The court cannot refuse bail and the police have no right to keep the person in custody. For example, causing death by rash or negligent act (Sec. 304A IPC), causing miscarriage (Sec. 312 IPC), voluntarily causing hurt (Sec. 323 IPC) and grievous hurt (Sec. 325 IPC).
- **Non-bailable offences** are those in which bail cannot be granted. These are the serious offences and the decision is taken by a Judicial Magistrate only. The police must produce the accused before the Judge within 24 h of arrest. At that time, the accused has a right to apply for bail himself or through his lawyer. E.g. cases of murder (Sec. 302 IPC), attempt to murder (Sec. 307 IPC), dowry death (Sec. 304B IPC), causing

miscarriage without woman's consent (Sec. 313 IPC) or voluntarily causing grievous hurt by dangerous weapons (Sec. 326 IPC).

- **Warrant case** is related to an offence punishable with death, life imprisonment or imprisonment for ≥ 2 years; e.g. murder, dowry deaths, attempt to murder cases.¹⁷
- Cases other than warrant cases are **summons cases**; e.g. cases of attempt to suicide or voluntarily causing hurt.
- **Cognizable offence:** It is an offence in which a police officer can arrest a person without warrant from the Magistrate, e.g. rape, murder, dowry death or attempt to murder.
- **Non-cognizable offence** is an offence in which the police officer cannot arrest without a warrant from the Magistrate, e.g. causing miscarriage, voluntarily causing hurt or intercourse with a man with his wife during separation (376A IPC).

Sentences authorized by law

- i. Death (hanged by neck till death)
- ii. Imprisonment for life
- iii. Imprisonment—rigorous, simple or solitary
- iv. Forfeiture of property
- v. Monetary fine
- vi. Treatment, training and rehabilitation of juvenile offenders

Capital Punishment

- **Capital punishment** (Latin *capitalis*: regarding head) or death penalty is the killing of a person by judicial process as a punishment for an offence.
- Various methods of carrying out death sentence are: Hanging, electrocution, shooting, cyanide poisoning, lethal injection, garroting and guillotine.
- The power of amnesty for capital punishment in India is vested with the President of India.

- Most democratic countries have abolished the death penalty, including Canada, Australia, New Zealand, almost all of Europe and much of Latin America. Among western countries, the first to abolish capital punishment was Portugal.
- Lethal injection is now virtually the universal method of execution in US.

Table 3.1: Powers of Magistrate

Magistrate	Period of Imprisonment	Amount of fine
Chief Judicial/Chief Metropolitan ¹³	Upto 7 years	Without limit but as per law
1st Class Judicial/Metropolitan ¹⁴	Upto 3 years	Upto ` 10,000
2nd Class Judicial	Upto 1 year	Upto ` 5,000

Guillotine: Device used for carrying out executions by decapitation. It consists of a tall upright frame from which a heavy blade is suspended. The blade is raised with a rope and then allowed to drop, severing the victim's head from their body. The device was used for execution in France and, more particularly, during the French Revolution.

Subpoena or Summons¹⁸

Definition: *Subpoena* (Latin, under punishment) is a document compelling the attendance of a witness in a court of law, under penalty, on a particular day, time and place for the purpose of giving evidence.

- **Sec. 61-69 CrPC** deals with summons.
- It is issued by the court in writing, in duplicate and signed by the presiding officer of the court and bears the seal of the court (Sec. 61 CrPC).
- It is served on the witness by a police officer, by an officer of the court or any other public servant.
- The witness retains one copy (original) and returns the other one duly signed by him on the back, in acknowledgement of its receipt (Sec. 62 CrPC).
- Summons must be obeyed and if the witness fails to attend the court, then:
 - i. In civil cases, he will be liable to pay damages.
 - ii. In criminal cases, the court may issue notice under **Sec. 350 CrPC** and after hearing the witness, if it finds that the witness neglected to attend the court without justification, may sentence him to imprisonment and/or fine, or the court may issue bailable or non-bailable warrant to secure the presence of witness (Sec. 172-174 IPC and Sec. 87 CrPC).
- It may also require the witness to bring with him any books, documents or other things under his control, which he is bound by law to produce in evidence.
- The witness may be excused from attending the court, if he has valid and urgent reason.
- If a witness is summoned by two courts on the same day, one criminal and other civil, he should attend the criminal court (criminal courts have priority over civil courts).
- Higher court has priority over the lower. If summoned to two courts on the same day, either civil or criminal, he must first attend the higher court.
- If a witness receives two summons on the same date from the same type of court, he should attend the court from which he received the summons first and inform the other court.

- In ancient Persian law, if one failed to answer the summons of the King, the punishment was death.
- Subpoena can be of two types:
 - i. *Subpoena duces tecum*: Person is required to bring certain documents or other evidence to the court (usually the postmortem or the medico-legal report) specified in the subpoena.¹⁹
 - ii. *Subpoena ad testificandum*: Requires the individual to testify before the court.

Conduct Money

Definition: It is the fee offered or paid to a witness in civil cases, at the time of serving the summons to meet the expenses towards attending the court.²⁰

- If fee is not paid or if he feels that the amount is less, the doctor can bring this fact to the notice of the judge before giving evidence in the court. The judge will decide the amount to be paid.
- In criminal cases, no fee is paid to the witness at the time of serving the summons. He must attend the court and give evidence because of the interest of the State in securing justice; otherwise he will be charged with contempt of court. However, conveyance charges and daily allowance are paid according to the government rules.

Medical Evidence

It is defined as legal means to prove or disprove any medico-legal issue in question. It is of two types:

- i. Documentary
- ii. Oral.

Documentary Evidence

Definition: It comprises of all documents, written or printed, to be produced before the court for inspection during the course of trial. It includes:

i. Medical certificates

- Issued by a qualified registered medical practitioner (RMP) in relation to ill health, death, insanity, age or sex.
- No fee is to be charged for issuing death certificates. Death certificate should not be issued without inspecting the body, and if the doctor is not sure of the cause of death, the matter should be reported to the police.
- Issuing or signing a false certificate is equivalent to giving false evidence (**Sec. 197 IPC**) and punished

with imprisonment of upto 7 years and fine (**Sec. 193 IPC**).²¹

ii. Medico-legal reports

- Reports prepared by a doctor at the request of the investigating officer for his guidance usually in criminal cases, e.g. injury, postmortem, rape, pregnancy, abortion or delivery.
- It may be prepared even when there is a requisition from the person himself or the magistrate.
- Postmortem reports are made only when there is a requisition from the police officer or magistrate.
- Reports are *not* admitted as evidence, unless the doctor attends the court and testifies to the facts under oath.
- Report should show competence, lack of bias and offer concrete professional advice. The doctor should avoid technical terms as far as possible.

iii. Dying declaration²²

Definition: It is a written or oral statement of a person, who is dying as a result of some unlawful act, relating to the material facts of the cause of death or the circumstances surrounding it.

The dying declaration has been incorporated in **Sec. 32 IEA**.²³ It must have corroborative evidence to support it before it can be accepted (**Sec. 157 IEA**).

Procedure and features of dying declaration

- The doctor should certify that the person is conscious and his mental faculties are normal [*compos mentis* (Latin, *compos*: having mastery, *mentis*: mind)].
- Oath is not administered because of the belief that a dying person tells the truth.
- *No leading questions* are asked.
- Ideally, a Magistrate should be called to record the declaration.
- When death is imminent, the statement may be recorded, in the presence of two witnesses, by the doctor or the police officer without losing time in waiting for the Magistrate.
- The declaration can be made to a police officer, public servant, village headman or a private person, but its evidential value will be less.
- Statement of the declarant should be recorded in the form of a simple narrative, without any alteration or phrases.
- While recording the statement, if the declarant becomes unconscious, the person recording it must record as much information as he has obtained and sign it himself.
- Fitness of the declarant to make statement is certified by the Magistrate or other officer concerned, at the conclusion of the statement.
- Declaration is sent to the Magistrate in a sealed cover.
- If the declarant survives, the declaration is not admitted, but has *corroborative value*, and the person is called to give oral evidence.²⁴

Dying deposition: The Magistrate records the evidence after administering oath in presence of the accused or his lawyer.²⁵ There is no provision of dying deposition in IEA, so it is not followed in India (Diff. 3.3).

iv. **Miscellaneous:** Expert opinion from books, deposition in previous judicial proceedings, etc.

- *Difference in dying declaration between Indian and British law:* In UK, it requires that the declarant should be under the expectation of immediate death and is restricted in cases of homicide only. But there is no such requirement in Indian law.
- *Dying declaration made in a state of shock:* Shock usually appears immediately after receiving the injuries, but it may supervene after some time, if the individual at the time of receiving the injuries was in a state of great excitement and mental preoccupation. Shock may be produced from exhaustion resulting from several injuries combined, though each one of them separately may be very slight. After receiving mortal injuries involving a vital organ, a very guarded reply is required to be given by a medical witness as to whether a person is capable of speaking, walking or performing any other volitional act which would involve a bodily or mental power for some time after receiving the fatal injury.
- Recently, the Supreme Court acquitted two persons sentenced to life imprisonment, observing that the victim's 'dying declaration' was unreliable (recorded by an assistant sub-inspector) and the prosecution could not produce any evidence against them. It also asked lower courts to ensure the veracity of a dying declaration, which should be free from tutoring, to inspire full confidence about its correctness for convicting an accused.

Oral Evidence

- It includes all statements which the court permits or which are required to be made before it by a witness, in relation to matters of fact under inquiry (Sec. 3 IEA).
- It must be direct—it must be evidence of an eyewitness (Sec. 60 IEA).
- Oral evidence is more important than documentary evidence, as it permits cross-examination.
- Documentary evidence is accepted by the court only on oral testimony by the person concerned.

Exceptions to oral evidence

- Dying declaration:* Accepted in court as legal evidence in event of victim's death (Sec. 32 IEA).
- Expert opinions expressed in a treatise:* Expert opinions printed in books are accepted as evidence without oral evidence of the author (Sec. 60 IEA).
- Deposition of a medical witness taken in lower court:* Accepted as evidence in a higher court when it has been recorded and attested by a magistrate in presence of the accused who had an opportunity to cross-examine the witness (Sec. 291 CrPC).

Differentiation 3.3: Dying declaration and dying deposition

S.No.	Feature	Dying declaration	Dying deposition
1.	Statement	Recorded by a magistrate/doctor/village headman/police	Always recorded by a Magistrate
2.	Oath	Not required	Must
3.	Accused or his counsel	Not present	Always present
4.	Cross-examination	Not done	Done
5.	Legal value	Comparatively less	Much more
6.	Admissibility, if declarant survives	Not admitted, but has corroborative value	Fully admitted
7.	Role of doctor	<ul style="list-style-type: none"> Assess <i>compos mentis</i> To record the statement in absence of Magistrate, but in presence of witnesses 	<ul style="list-style-type: none"> Assess <i>compos mentis</i> Statement always recorded by the Magistrate
8.	Status in India	Followed	Not followed

iv. *Report of certain government scientific experts*: Admitted as evidence without their oral examination, e.g. reports of Chemical Examiner, Director of Fingerprint Bureau, Haffkeine Institute or CFSL (Sec. 293 CrPC).

v. *Evidence given by a witness in a previous judicial proceeding*: Admitted in a subsequent judicial proceeding when the witness is dead or cannot be found or is incapable of giving evidence or cannot be called without unreasonable delay or expense to the court (Sec. 33 IEA).

vi. *Public records*: Birth and death certificates, and certificates of marriage.

vii. *Hospital records*: Routine entries, such as date of admission, discharge, pulse, temperature, etc. are admissible without oral evidence.

- **Circumstantial evidence or indirect evidence** is the evidence consisting of collateral facts from which an inference may be drawn and are consistent with the direct evidence, such as finding blood on the clothes of the accused.
- **Hearsay evidence**: Any evidence that is offered by a witness of which he/she does not have direct knowledge but his/her testimony is based on what others have said. For example, Anil heard from Sunil about an accident that Sunil witnessed but that he had not, and Anil repeated in court Sunil's story as evidence of the accident.

Res gestae describes a common-law doctrine governing testimony. Under the hearsay rule, a court normally refuses to admit as evidence statements that a witness says he or she heard another person say. The doctrine of *res gestae* provided an exception to this rule.

Types of Witness

Definition: A witness is a person who gives sworn testimony (evidence) in a court of law as regards facts and/or inferences that can be drawn from these.

Types: (Diff. 3.4)

- Common, ordinary or lay witness
- Expert or skilled witness.

Expert witness is a person who has been trained or skilled in technical or scientific subject. He can volunteer a statement, if he feels that justice is likely to be miscarried owing to the court having failed to elicit an important point.²⁶ **Sec. 45 IEA** deals with opinion of experts.

A doctor can testify both as ordinary as well as expert witness. When he describes the dimensions of an injury, e.g. stab wound, he acts like an ordinary witness (fact witness), but when opines the cause of death as hemorrhage due to antemortem injury to the femoral artery, he is an expert witness.

Hostile witness is a person who willfully or with motive (bribe/intimidation) conceals part of the truth or tells a lie or gives completely false evidence in a court.^{27,28}

- It is contradictory to the statement the witness made in the previous deposition (e.g. statement recorded by the police).
- Any of the above two witnesses can be declared hostile witness.

- A witness who has seen the event first-hand is known as an eyewitness.

- **Testimony** (Latin *testimonium*: from *testis*): In law and in religion and are consistent with the direct evidence, testimony is a solemn attestation as to the truth of a matter.

Differentiation 3.4: Common and expert witness

S.No.	Feature	Common witness	Expert witness
1.	Definition	Gives evidence about the facts observed or perceived by him	Person especially skilled in foreign law, science or art
2.	Volunteering a statement	Not allowed	Can volunteer
3.	Drawing inference from observations	Not allowed	Can draw
4.	Expressing opinion on observations made by others	Not allowed	Can express
5.	Responsibility	Less	Highly responsible
6.	Punishment on giving false evidence	Less punishment	Severely punished in some countries
7.	Conduct money	Cannot claim	Can claim
8.	Examples	Any person	Handwriting or fingerprint expert, doctor, chemical examiner

- The Supreme Court has defined a **hostile witness** as 'one who is not desirous of telling the truth at the instance of the party calling him' and an **unfavorable witness** is 'one called by a party to prove a particular fact, who fails to prove such a fact or proves an opposite fact' (Sat Pal vs Delhi Administration).
- The Black's Law Dictionary defined **hostile witness** as 'a witness who is biased against the examining party or who is unwilling to testify'.

Recording of Evidence**Testifying**

A deposition is testimony of a witness. The words spoken by the witness are treated as courtroom testimony and the proceeding is conducted in accordance with the applicable court rules. Sec. 118 IEA states about the person who may testify as witness in court of law.

Presentation of Evidence

After receiving subpoena, the expert witness must appear before the court at the appointed time with the relevant documents. The evidence is probed for areas of uncertainty, inconsistency or any factors which may make the evidence appear unreliable. Evidence is presented in a systematic order (Sec. 138 IEA):

- Oath (Sec. 51 IPC)
- Examination-in-chief (Sec. 137 IEA)
- Cross-examination (Sec. 141-146 IEA)
- Re-examination (Sec. 137-138 IEA)
- Court questions (Sec. 165 IEA, Sec. 311 CrPC).

Oath

It is compulsory for the witness to take an oath in the witness box before he gives his evidence. He is required

to swear by Almighty God that he will tell the truth, the whole truth and nothing but the truth. If the witness is an atheist, he makes a solemn affirmation in same terms, instead of swearing by God.

Perjury: A witness who after taking oath or making a solemn affirmation, willfully makes a false statement which he knows or believes to be the false (Sec. 191 IPC and Sec. 344 CrPC) is liable to be prosecuted for perjury under **Sec. 193 IPC** with imprisonment upto 7 years and fine.

- In US, punishment for perjury is imprisonment upto 5 years, while in UK it is upto 7 years.
- In some countries, such as France, Italy and Germany, suspect's evidence is not taken under oath or affirmation and thus cannot commit perjury, regardless of what they say during their trial.

Examination-in-chief (Direct Examination)

- It is the examination of a witness by the party who calls him.
- In criminal cases, the public prosecutor commences this examination.
- *Objectives are* to place before the court all the facts that bear on the case and if the witness is an expert, his interpretation of these facts.
- *No leading questions are allowed* except in those cases in which the judge is satisfied that a witness is hostile.²⁹

Leading question: Any question suggesting the answer which the person putting it wished or expects to receive (Sec. 141 IEA). It includes a material fact and admits of a conclusive answer by a simple 'Yes' or 'No'. For example, "Was the length of the knife 15 cm?" Instead

the question should be "What was the length of the knife?"

Leading questions must not be asked, if objected to by the adverse party, in an examination-in-chief or in re-examination, except with the permission of the court (Sec. 142 IEA).^{29,30}

Cross-examination

It is the examination of a witness by the adverse party (defense lawyer).

Objectives are:

- i. To elicit facts favorable to his case
 - ii. To test the accuracy of the statements made by the witness
 - iii. To modify or explain what has been said
 - iv. To develop new or old facts
 - v. To discredit the witness
 - vi. To remove any overemphasis which may have been given to any of fact in direct examination
- The lawyer tries to weaken the evidence of the witness by showing that his details are inaccurate, conflicting, contradictory and untrustworthy.
 - *Leading questions are allowed* (Sec. 143 IEA).
 - Cross-examination has no time limit, may last for hours or even days.
 - The court has the power to disallow questions which are indecent or scandalous (Sec. 151 IEA) or intended to insult or annoy or offensive in form (Sec. 152 IEA).

During cross-examination, if any question is not understood, the witness should ask the lawyer to explain it better. Moreover, he should not volunteer any unrelated information.

Re-examination (Re-direct Examination)

It is the examination of a witness subsequent to the cross-examination by the party who called him.

Objectives are:

- i. To clear any doubts that may have arisen during cross-examination.
- ii. To explain some matter in its proper perspective, so that under emphasis or possible misinterpretation may be avoided.

Leading questions are not allowed. Opposing lawyer has the right of re-cross-examination on any new point which has been raised.

Court Questions/Questions by the Judge

Judge may ask any question to the witness at any stage of the trial to clear any doubtful points.³¹

The deposition of the witness is handed over to him. The witness after carefully going through it, is required

to sign at the bottom of each page and on the last page immediately below the last paragraph, and to initial any corrections (Sec. 278 CrPC). The witness should not leave the court without the permission of the judge.

Conduct and Duties of a Doctor in the Witness Box

When summons is served, he must attend the court punctually. As a rule, his evidence is taken at the appointed time.

- i. Take all records and relevant reports that may have to be quoted in the box.
- ii. Be well dressed and modest.
- iii. Do not discuss the case with anyone in the court except the lawyer by whom you were asked to testify.
- iv. Stand up straight, be relaxed, calm and not be frightened or nervous. Look people in the eye when you speak, for it gives the impression of honesty.
- v. Never attempt to memorize. The law allows refreshing your memory from copies of reports.
- vi. Speak slowly, distinctly and audibly so that the typist can record your evidence.
- vii. Use simple language, avoiding technical terms to the best of your ability.
- viii. Address the Judge by his proper title such as 'Sir' or 'Your honor.'
- ix. Be polite, pleasant and courteous to the lawyer. Do not underestimate the medical knowledge of the lawyers.
- x. Do not evade a question. Say 'I don't know' if it is so, for no one can be expected to know everything.
- xi. Do not lose your temper. An angry witness is often a poor witness.
- xii. Retain independence of your mind. A biased expert is a useless expert.
- xiii. Listen carefully to the questions. Do not hesitate to ask the questions to be repeated, if you do not understand it. Avoid long discussions.
- xiv. If you believe the question is unfair, look at your lawyer before answering. If he fails to object, turn to Judge and ask whether you should answer the question.
- xv. Do not over emphasize replies to questions from cross-examining lawyers.
- xvi. Watch for double questions. The answer to each part of the question may be different.
- xvii. When asked to comment upon the competence of a colleague, avoid any insulting remarks. If you do not wish to make any statement, say that you have 'no opinion' or 'no comments'.

- xviii. Say 'In my opinion...', do not use phrase such as 'I think...' or 'I imagine...' Be prepared to give reasons for your opinion, if asked.
- xix. Do not be drawn outside your particular field of competence. Avoid speaking on a subject in which you have little or no practical experience.
- xx. Do not refuse to answer any question—a medical witness has no professional privilege.
- xxi. Do not volunteer any information beyond that asked for in the question; limit your answer to your expertise in the field.

MULTIPLE CHOICE QUESTIONS

1. **IPC is:** TN 05
 A. Procedure for investigation
 B. Code for punishment
 C. Both A & B
 D. None
2. **Police inquest is done:** TN 05
 A. By the collector
 B. To find the cause of death
 C. To hang the person who committed murder
 D. None of the above
3. **Before conducting the inquest, police should inform:** Manipal 10
 A. Director general police
 B. Sessions judge
 C. Executive magistrate
 D. Senior police officer
4. **Magistrate's inquest is conducted by:** Manipal 06
 A. District magistrate
 B. Executive magistrate
 C. Sub-divisional magistrate
 D. Any of the above
5. **A married woman died in unnatural conditions within 5 years of her marriage. Her parents complained of frequent demand of dowry. Her autopsy will be conducted under which section:** AI 10; Punjab 10
 A. Sec. 174 CrPC B. Sec. 176 CrPC
 C. Sec. 302 IPC D. Sec. 304B IPC
6. **Sec. 176 CrPC is related to:** MP 10
 A. Coroner inquest B. Summons
 C. Police inquest D. Magistrate inquest
7. **In India, Magistrate inquest is done in all of the following cases, except:** AI 05; TN 05
 A. Police firing B. Dowry death
 C. Custodial death D. Murder
8. **In case of death in prison, inquest is held by:** Delhi 03; TN 08; Maharashtra 11
 A. Magistrate B. Panchayat officers
 C. Police superintendent D. District attorney
9. **A lady died due to unnatural death within seven years of her marriage. The inquest in this case will be done by:** AIIMS 04; DNB 09; FMGE 09
 A. Forensic medicine expert
 B. Deputy superintendent of police
 C. Sub-divisional magistrate
 D. Coroner
10. **Consider the following statements:** UPSC 09
 1. In India, every State has its own high court.
 2. In India, the judges of the high court are appointed by the Governor of the State concerned.
Which of the statements given above is/are correct?
 A. 1 only B. 2 only
 C. Both 1 and 2 D. Neither 1 nor 2
11. **Example of Court of Appeal:** Manipal 11
 A. Sessions court B. Magistrate's court
 C. Coroner's court D. High court
12. **First class Judicial Magistrate is appointed by:** MP 07
 A. Governor
 B. Chief Justice of High Court
 C. Chief Minister of the State
 D. Chief Justice of Supreme Court
13. **Chief Judicial Magistrate can give sentence a guilty for imprisonment upto:** DNB 09
 A. 3 years B. 5 years
 C. 7 years D. Life imprisonment
14. **Powers of a 1st class Magistrate:** PGI 06; AP 10; Jharkhand 11
 A. Fine upto ` 10,000 and 3 years imprisonment
 B. Fine upto ` 10,000 and 5 years imprisonment
 C. Fine upto ` 3000 and 5 years imprisonment
 D. Unlimited fine and 7 years imprisonment
15. **'Juvenile court' is presided over by:** DNB 08
 A. I class woman magistrate
 B. II class woman magistrate
 C. II class male magistrate
 D. None of the above
16. **Juvenile court deals with cases of children upto the age of:** Maharashtra 09; DNB 09; FMGE 10
 A. 15 years B. 16 years
 C. 18 years D. 21 years
17. **Warrant cases are punishable with imprisonment upto:** DNB 09
 A. More than 1 year B. More than 2 years
 C. Less than 1 year D. Less than 2 years

1. B 2. B 3. C 4. D 5. B 6. D 7. D 8. A 9. C 10. D
 11. D 12. B 13. C 14. A 15. A 16. C 17. B

18. Subpoena is also called: *Manipal 06*
 A. Summons B. Panchnama
 C. Requisition D. Inquest papers
19. Duces tecum is: *WB 08*
 A. Summon B. Panchnama
 C. Conduct money D. Hostile witness
20. Conduct money is fee given to a: *AP 07*
 A. Witness in civil court
 B. Witness in criminal court
 C. Doctor for good behavior in court
 D. Witness for good conduct
21. When a doctor issues a false medical certificate, then he is liable under: *AIIMS 11; Bihar 11*
 A. Sec. 197 IPC B. Sec. 87 IPC
 C. Sec. 304A IPC D. Sec. 338 IPC
22. Dying declaration is a: *Manipal 10*
 A. Circumstantial evidence
 B. Oral evidence
 C. Documentary evidence
 D. Hearsay evidence
23. Dying declaration comes under: *DNB 09*
 A. Sec. 30 CrPC B. Sec. 32 CrPC
 C. Sec. 32 IPC D. Sec. 61 CrPC
24. If a patient survives after having given dying declaration, then it stands as: *JIPMER 04; UP 09*
 A. No value
 B. Valid for 48 hours
 C. Corroborative evidence
 D. None
25. Dying deposition is done by: *UP 05*
 A. Doctor
 B. Magistrate
 C. Police
 D. All
26. Volunteering a statement can be done by: *Punjab 07*
 A. Eyewitness
 B. Medical witness
 C. Hostile witness
 D. IO
27. Hostile witness is one who: *Maharashtra 08*
 A. Threatens the judge
 B. Threatens the prosecutor
 C. Refuses to answer
 D. Willfully gives false evidence
28. A witness, who after taking oath, willfully makes a statement which he knows or believes to be false is guilty of crime under section: *AI 03, UP 05; AIIMS 11*
 A. 190 IPC B. 191 IPC
 C. 192 IPC D. 193 IPC
29. Leading questions are NOT permitted in: *Delhi 08*
 A. Cross-examination
 B. Examination-in-chief
 C. Questions by the Judge
 D. Re-examination
30. Sec. 142 IEA is related to: *BHU 08*
 A. Cross-questioning
 B. When leading question can be asked
 C. When leading question cannot be asked
 D. Objective evidence
31. Judge can ask questions: *Punjab 07*
 A. During cross-examination
 B. Examination-in-chief
 C. Any time during trial
 D. Re-examination

Identification I

4

Definition: Identification is the *determination of the individuality of a person* based on certain physical characteristics.

It can be:

- i. **Complete (absolute):** Absolute fixation of the individuality of a person.
- ii. **Partial (incomplete):** Ascertainment of only some facts (e.g. race, sex, age or stature) about the identity, while the others remain unknown.

Identification is necessary in:

Living persons pertaining to:

Criminal cases	Civil cases
<ul style="list-style-type: none">• Persons accused of assault, murder or rape• Interchange of newborn babies in hospitals• Impersonation• Absconding soldiers and criminals	<ul style="list-style-type: none">• Marriage• Passport/license• Inheritance• Insurance claim• Missing persons• Disputed sex

Dead people

- i. In cases of fire, explosion and accidents.
- ii. When an unknown dead body is found on the road, fields, railway compartment or water.
- iii. In cases of decomposed body.
- iv. In cases of mutilated body.
- v. Skeleton.

Before identifying the accused in court, the doctor should verify the identification marks noted by him.

Corpus Delicti

Corpus delicti ('body of offence') refers to the principle that it must be proven that a crime has actually occurred before a person can be convicted of committing the crime.¹

In a charge of homicide, it includes:

- i. Positive identification of the dead body (victim)
 - ii. Proof of its death by criminal act of accused.
- The term includes body of the victim, bullet or clothing showing marks of the weapon or photographs showing fatal injuries.

- The main part of corpus delicti is the establishment of identity of the body and infliction of violence in a particular way, at a particular time and place by the person or persons charged with crime and none other.
- The identification of a dead body and proof of corpus delicti is essential before a sentence is passed in murder trials, as unclaimed, decomposed bodies or portions of a dead body or bones are sometimes produced to support a false charge.

Identification data

In living and dead both

1. Race and religion
2. Sex
3. Age
4. Teeth
5. General development and stature
6. Anthropometric measurements
7. Fingerprints, lip prints and footprints
8. External peculiarities, like scar or tattoo
9. Hair
10. Personal effects: clothes, pocket contents

In living only

- Handwriting
- Speech and voice
- Gait, manner and habit
- Memory and education

Sex, age and stature are primary characteristics of identification—they are unaltered even after death.

Race and Religion

Important in cases of mass disasters, e.g. in case of railway accidents or air crashes, when persons of different races are traveling together.

Race

It is determined by:

- i. **Clothing:** Traditional Indian dress is different from Western dress.
- ii. **Complexion:** Skin is black in Negroes, brown in Indians and fair in Europeans (Caucasian).
- iii. **Eye:** Indians have dark or brown, Negroes have dark brown and Europeans have blue or gray iris.

- iv. **Hair:** Ethnic variations are discussed in Chapter 5. Indians have black, long and fine hair which is rounder and thicker than Caucasians or Negroes.
- v. **Skull: Cephalic Index** (Greek *kephale*: head) or Index of Breadth is the percentage of breadth to length in any skull.²

$$CI = \frac{\text{Maximum transverse breadth of skull}}{\text{Maximum anteroposterior length of skull}} \times 100$$

Length and breadth are measured by calipers.

- It is useful anthropologically to find out racial difference from skull shape.³ Skull can be classified into three types based on cephalic index (CI)—dolichocephalic, brachycephalic, mesocephalic (Table 4.1). Another variant *hyperbrachycephalic* with very round or broad head (CI 85-89.9) can be seen in Apert syndrome.
- Since the Indian skull is Caucasian with few Negroid characters, we take the value for Europeans, i.e. 75-79.9.⁷
- It is also useful in estimating the age of fetuses for legal and obstetrical reasons.
- It has been reported that CI is less 2-3 in individual with sickle cell anemia than normal individual.

Difference between Caucasian, Mongolian and Negroid skull is given in Diff. 4.1.

- vi. **The indices of long bones** may also help in identifying races; e.g. Brachial index (Radio-humeral index), Intermembral index, Humero-femoral index and the Crural index (Tibio-femoral index).

- Brachial index = (Length of Radius/Length of Humerus) × 100
For Europeans: 74.5, Negroes: 78.5
- Crural index = (Length of Tibia/Length of Femur) × 100
For Indians: 86.5, Negroes: 86.2, Europeans: 83.3.
- Humero-femoral index = (Length of Humerus/Length of Femur) × 100
For Europeans: 69, Negroes: 72.4
- Intermembral index = (Length of Humerus + Radius/Length of Femur + Tibia) × 100
For Europeans: > 70, Negroes: < 70.5

'Mongolian spots': These hyperpigmented spots or patches are most often found over the lumbosacral region of infants and occur in people of different races (90% of Native Americans, 80% of Asians and 10% of whites) which help in racial identification.

Religion

- *Hindu males* are not circumcised, may have sacred thread, necklace of wooden beads, caste marks on forehead, tuft of hair on back of the head and piercing of ear lobes.
- *Muslim males* are normally circumcised, have marks of corns and callosities on lateral aspect of knees and feet due to their posture during prayer.
- *Hindu females* put on saris, vermilion on head, silver toe ornaments, tattoo marks, nose ring aperture in left nostril and few openings for ear rings along the helix.
- *Muslim females* put on trousers, no vermilion mark, nose ring in the septum, several openings on the helix for ear rings and no tattoo marks.

Table 4.1: Different types of skull based on cephalic index⁴

Type of skull	Cephalic index	Race
Dolicocephalic (long-headed)	70-74.9	Aryans, Aborigines, Negroes
Mesaticephalic (medium-headed)	75-79.9	Europeans, Chinese
Brachycephalic (short-headed)	80-84.9	Mongolian ⁵

Differentiation 4.1: Caucasian/European, Mongolian and Negroid skull⁴

S.No.	Feature	Caucasians	Mongols	Negroes
1.	Skull	Rounded ⁶	Square	Narrow and elongated
2.	Forehead	Raised	Inclined	Small and compressed
3.	Face	Straight lower face—orthognathism	Large and flattened, malar bones prominent	Jaw projecting—prognathism, malar bones prominent
4.	Orbits	Triangular	Small, round	Square
5.	Nasal opening	Narrow and elongated	Rounded	Broad
6.	Palate	Triangular	Rounded or horseshoe shaped	Rectangular

Sex

Sex determination is required for following reasons:

- For the purpose of identification in living/dead.
- For deciding whether an individual can exercise certain civil rights extended to one sex only.
- For deciding questions relating to legitimacy, divorce, paternity, marriage, impotence, rape and affiliation.

Sex of a person can be determined from:

- Physical morphology (Diff. 4.2)
- Microscopic study of sex chromatin
- Gonadal biopsy.

In normal cases, in the living:

- **Most certain evidence of sex:** Possession of ovaries in females and testes in males.
- **Highly probable evidence of sex:** Possession of sexual structures, e.g. developed breasts and vagina in females, and male distribution of hair and penis in males.
- **Presumptive evidence of sex:** Outward appearance of individual features, contours of face, clothes, voice and figure.

Nuclear Sexing

Definition: It is a method of sexing cells which may help in determining sex in doubtful cases, decomposed and mutilated bodies and fragmentary remains (Table 4.2).

Histological Examination

- Barr body (sex chromatin):** It is the condensed, inactive, single X-chromosome found in the nuclei

Table 4.2: Chromatin positivity in males and females

Test	Male (%)	Female (%)
• Barr body	0-4	20-80
• Davidson body	0	6
• Fluorescent feulgen	0-2	50-70
• Quinacrine dihydrochloride	45-80	0-4

of somatic cells of most females and whose presence is the basis of sex determination tests that are performed. In XO (Turner's syndrome) there will be none, and in XXX there will be two Barr bodies (Fig. 4.1).⁸ It is seen during mitosis in the interphase nucleus as dark staining, small planoconvex mass of chromatin lying near the nuclear membrane (Fig. 4.2).⁹ Buccal smear is usually used.

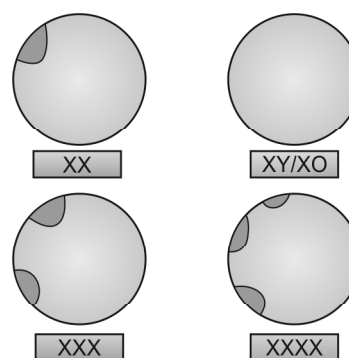

Fig. 4.1: Barr body in different karyotypes

Differentiation 4.2: Determination of sex from physical/morphological feature

S.No.	Feature	Male	Female
1.	General built	Muscular, strong, stout	Less muscular, delicate, slender
2.	Scalp hair	Short, thick, coarse	Long, fine, thin
3.	Facial hair	Present	Absent
4.	Pubic hair	Thick, coarse, extends upwards with apex at umbilicus (rhomboidal)	Thin, fine, horizontal, covers mons veneris (triangular)
5.	Adam's apple	Prominent	Less prominent
6.	Shoulders	Broader than hip	Narrower than hip
7.	Waist	Not well-defined	Well-defined
8.	Trunk	Abdominal segment smaller	Abdominal segment larger
9.	Thorax	Dimensions more	Dimensions less
10.	Thighs	Cylindrical	Conical due to short femur and greater fat
11.	Breasts	Not developed	Developed after puberty
12.	Uterus and vagina	Absent	Present
13.	Penis	Present	Absent
14.	Gonads	Testes	Ovaries

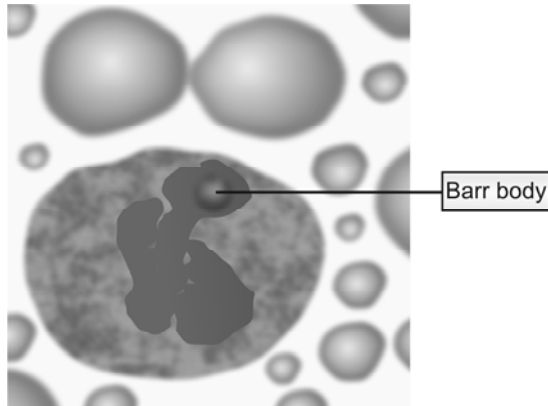

Fig. 4.2: Barr body in buccal epithelium

Murray Barr and Edward Bertran while working on stained sections of nerve cells in cats noticed a tiny, dark staining blob that was always present only in the nucleus of the female cats and never in the males.¹⁰ It was subsequently determined to be inactive X-chromosome and came to be known as **Barr body**.

- ii. **Davidson body:** In females, neutrophil leucocytes contain a small nuclear attachment of drumstick form (Fig. 4.3).¹¹
- In decomposed bodies, sex chromatin cannot be made out.
- Sex chromosomes (XX or XY) can be determined in the cells that are dividing, e.g. bloodstains, cartilage, bone marrow, teeth pulp and hair root.
- Hair follicles are important for cell sexing since they resist putrefaction and both Barr body and Y-chromosome can be demonstrated.
- **Quinacrine dihydrochloride** is used for staining Y-chromosome that is seen as bright fluorescent body.
- **Fluorescent Feulgen reaction** using Acriflavin Schiff reagent is used for staining X-chromosome that is seen as bright yellow spot in nuclei.

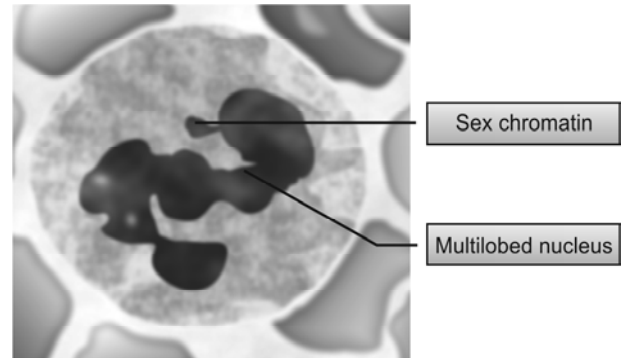

Fig. 4.3: Davidson body (drumstick appearance) in neutrophil

- **Gonadal biopsy** (from testes or ovaries) is a *confirmatory method* of determining sex.

In normal cases, sex determination is easy from external examination, but it is difficult in cases of:

- i. Hermaphrodites
- ii. Concealed sex
- iii. Advanced decomposition
- iv. Skeleton.

Intersex

Definition: It is an intermingling of sexual characters of either sex in one individual to a varying degree including the physical form, reproductive organs and sexual behavior.

It results from some defect in embryonic development (Flow chart 4.1). Davidson divided it into four groups:

- i. Gonadal agenesis
- ii. Gonadal dysgenesis
- iii. True hermaphroditism
- iv. Pseudohermaphroditism.

Flow chart 4.1: Classification of disorders of sexual development

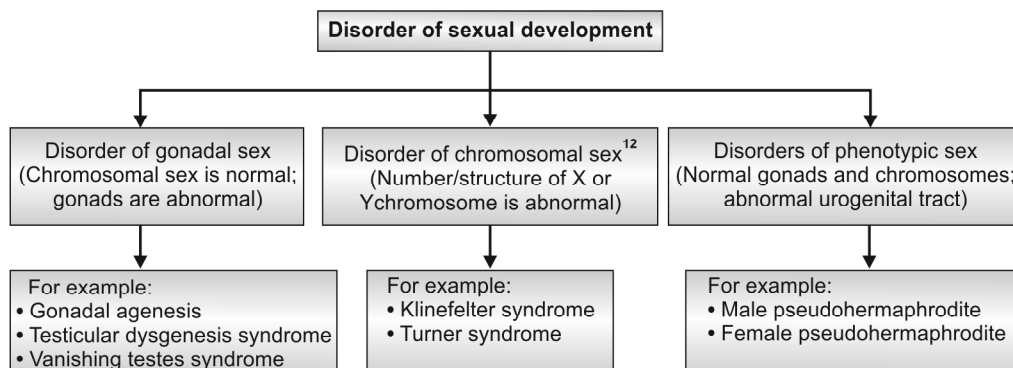

1. **Gonadal agenesis:** Sex organs (testes and ovaries) never developed in these individuals. Nuclear sexing is negative.
2. **Gonadal dysgenesis:** External sexual characters present, but testes or ovaries fail to develop at puberty, e.g. Turner syndrome, Klinefelter syndrome, Swyer syndrome and gonadal aplasia. It is characterized by a progressive loss of primordial germ cells on the developing gonads of an embryo leading to extremely hypoplastic and dysfunctioning gonads composed of fibrous tissue—**streak gonads**.¹³

Klinefelter Syndrome (Fig. 4.4)

Klinefelter syndrome is the most common sex chromosome disorder associated with male hypogonadism and the second most common condition caused by the presence of extra chromosomes.

Anatomically male, but nuclear sex is female (chromatin positive).¹⁴ Classical karyotype is 47 XXY.¹⁵ Incidence is 1 in 500; chances are more with increasing maternal age.

Features^{16,17}

- Delay in onset of puberty, gynecomastia at puberty.
- Axillary and pubic hair are absent, hair on chest and chin are reduced.

- Signs of eunuchoidism, tall stature and abnormal body proportions (height greater than arm span).
- Testes feel normal during childhood, but during adolescence they are firm, fibrotic, small, and non-tender to palpation. Azoospermia is present.
- Mental deficiency and other abnormalities, such as clinodactyly or synostosis.
- Problems with coordination and social skills.

Diagnosis: Karyotyping using lymphocytes or fibroblasts or prenatally from amniocytes or chorionic villi, or by determining the presence of RNA for X-inactive-specific transcriptase (XIST) in peripheral blood leukocytes by polymerase chain reaction.

Serum testosterone is low and FSH, LH and estradiol are elevated. Sometimes, the serum testosterone is normal, but serum free testosterone is usually low.

Histological: Testicular dysgenesis with hyalinization of seminiferous tubules.

Men with Klinefelter syndrome are at a higher risk of autoimmune diseases, diabetes mellitus, leg ulcers, osteopenia and osteoporosis, tumors (breast and germ cells), gonadotroph adenoma and gonadotroph hyperplasia liver adenoma, SLE, rheumatoid arthritis and Sjögren syndrome.

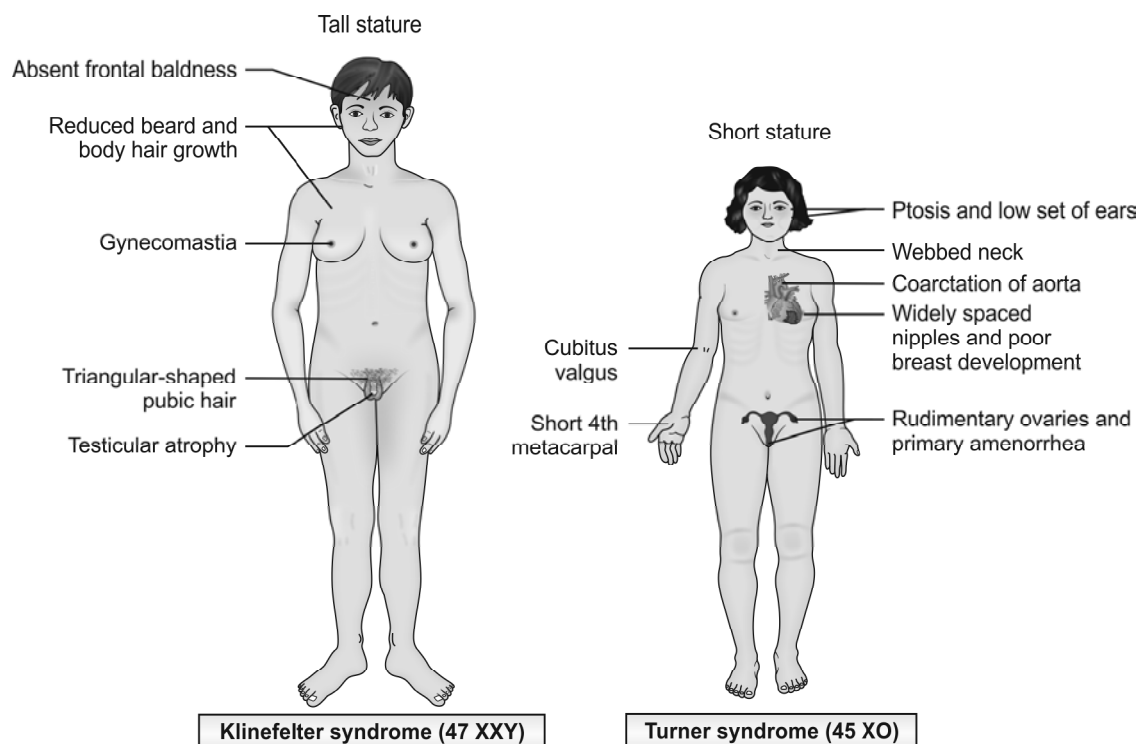

Fig. 4.4: Features seen in Klinefelter and Turner syndrome

Hypergonadotropic hypogonadism (defective development of testes or ovaries and associated with excess pituitary gonadotropin secretion) is seen in Klinefelter syndrome, Noonan syndrome, viral orchitis (mumps), cytotoxic drugs and testicular irradiation. In women with hypergonadotropic hypogonadism, the most common cause is Turner syndrome.^{18,19}

Turner Syndrome (Fig. 4.4)

Turner syndrome is the most common sex chromosome abnormality of human females. Its incidence in newborns is approximately 1 in 2,500.²⁰

Anatomical structure is female, but nuclear sexing is negative like male. Sex chromatin pattern is XO (45 chromosomes).²¹

It can be recognized at birth by lymphedema of dorsum of hands and feet, loose skin folds in the nape of neck and low birth weight.

Features²²⁻²⁵

- Short stature, webbed neck.
- Micrognathia, high-arched palate.
- Ptosis with low-set ears.
- Low hairline, widely spaced nipples.
- Cubitus valgus, short fourth metacarpals, hyperconvex nails and recurrent otitis media.
- Lymphedema of hands and feet, pigmented nevi and keloid formation.
- Learning disability, often involving visual-spatial skills without typical mental retardation.
- **Cardiovascular** anomalies: Coarctation of the aorta and aortic stenosis.
- **Renal** abnormalities: Hydronephrosis, horseshoe kidney, hypertension.
- Increased urinary gonadotrophin excretion.
- **Sexual** infantilism due to gonadal dysgenesis with primary amenorrhea.
- High incidence of osteoporosis, type II diabetes

Diagnosis: Evaluation for childhood short stature often leads to the diagnosis. Hypogonadism is confirmed in girls who have high serum levels of FSH and LH. A karyotype showing 45 XO establishes the diagnosis.

Cardiovascular disease is the most common cause of death in adult women with Turner syndrome. Most common heart defects are bicuspid aortic valve (30% of children), coarctation of the aorta (5-10%) and aortic dissection.²⁶ Other anomalies seen are hypoplastic left-heart syndrome, partial anomalous pulmonary venous drainage and atrial septal defects.

3. **True hermaphroditism:** It is a rare condition; also known as double-sex or bisexual. Both ovarian and testicular tissues are present.²⁷ External genitalia of both sexes exist in one individual, but sex chromatin may be either male or female pattern (46 XX or 46 XY or mosaics).
4. **Pseudohermaphroditism:** In this, gonadal tissue of only one sex is seen internally, but external appearance is that of opposite sex.
 - a. **Male pseudohermaphroditism**²⁸⁻³⁰
 - Individuals have male karyotype (nuclear sex—XY) and testes.
 - Complete or partial feminization of the external genitals.
 - It is because of failure to utilize testosterone which may be due to:
 - i. Androgen receptor deficiency
 - Complete androgen insensitivity (Testicular feminization syndrome—TFS)
 - Incomplete androgen Insensitivity
 - ii. 5- α reductase deficiency (inability to convert testosterone to its active form dihydrotestosterone).

Testicular feminization syndrome is the most common form of male pseudohermaphroditism. It is characterized by female external genitalia with normal size breasts but with primary amenorrhea and scanty or absent axillary and pubic hair. Internally, there is a short blind-pouch vagina with absence of uterus, fallopian tubes and ovaries. Testes are in the abdomen or inguinal canal and vas deferens are usually present.

- b. **Female pseudohermaphroditism**³¹⁻³³
 - Individuals have female karyotype (nuclear sex—XX) and ovary.
 - Sex organs and sexual characteristics deviate to male (uterus, fallopian tubes and ovaries are normal).
 - It is due to variable virilization of the urogenital tract as a result of excess androgen during fetal life caused by congenital adrenal hyperplasia (CAH, 98% of cases). Among the various forms of CAH, the 21-hydroxylase deficiency is most common (> 95% of cases) but sexual ambiguity can also be seen in defects in 17-hydroxylase, 3 β -hydroxysteroid dehydrogenase, 17-ketosteroid reductase and 11 β -hydroxylase.

Concealed Sex: Criminals conceal their sex to avoid detection by changing dress or by other methods. This can be detected by physical examination.

In advanced decomposition, sex can be determined by identifying uterus or prostrate, which resist putrefaction.

Sex from Skeletal Remains

- Recognizable sex differences appear after puberty *except* in pelvis. In pelvis, sex features are independent of each other and one may even contradict the other in same pelvis.
- The sex of long bones can be determined on the basis of medullary index from tibia, humerus, ulna and radius. Sternum is least useful.
- Radiological thinning of the cortex and progressive rarefaction of apex of medullary cavity of head of humerus and femur are helpful.

The accuracy in sexing from adult skeletal remains is given in Table 4.3 (as reported by Krogman).³⁴

Table 4.3: Accuracy of sexing based on skeletal remains

Skeletal remains	Accuracy in sexing (%)
Entire skeleton	100
Skull + Pelvis	98
Pelvis alone (best single bone) ³⁵	95
Skull alone	92
Long bones	80-85
Long bones + Pelvis	98

Traits diagnostic of sex from skeleton are given in Diff. 4.3 to 4.6 and Table 4.4.

The *preauricular sulcus* has been described as a characteristic of the female pelvis. The pelvic portion of the anterior sacroiliac ligament is attached to it. Its prominence results from obstetrical trauma during the course of delivery which allows for differentiation between nulliparous women and males vs females who have given birth.

Differentiation 4.3: Male and female skull (Fig. 4.5)

S.No.	Feature	Male skull	Female skull
1.	General appearance	Larger, heavier, rugged, marked muscular ridges	Smaller, lighter, walls thinner, smoother
2.	Forehead	Receding, irregular, rough, less rounded	Vertical, round, full, infantile, smooth
3.	Cranial capacity	More capacious (1450-1550 cc)	Less capacious (1300-1350 cc)
4.	Glabella	Prominent	Less prominent
5.	Supraorbital/ supraciliary ridge	Prominent	Less prominent
6.	Frontonasal junction	Distinct angulation	Smoothly curved
7.	Orbits	Square, rounded margins, small	Rounded, sharp margins, large
8.	Frontal and parietal eminence	Less prominent	Prominent
9.	Zygomatic arch	Prominent	Not prominent
10.	Occipital area (Muscle markings and protuberance)	Prominent	Not prominent
11.	Mastoid process	Large, round, blunt	Small, smooth, pointed
12.	Digastric groove	Deep	Shallow
13.	Condylar facet	Long, narrow	Short, broad
14.	Palate	Large, U-shaped, broad	Small, parabolic
15.	Foramen magnum	Relatively large, long	Small, round
16.	External auditory meatus	Bony ridge along upper border prominent	Often absent

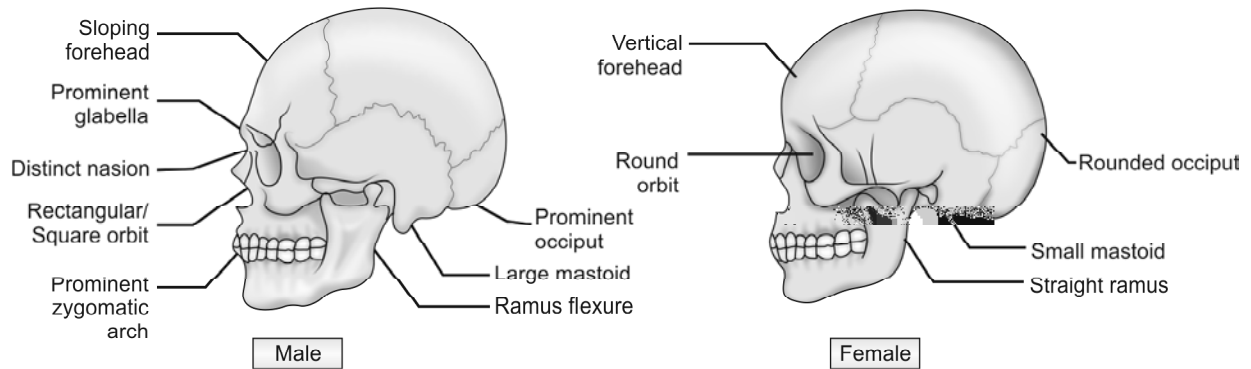

Fig. 4.5: Male and female skull

Differentiation 4.4: Male and female mandible (Fig. 4.6)

S.No.	Feature	Male mandible	Female mandible
1.	General appearance	Larger, thicker	Smaller, thinner
2.	Chin (symphysis menti)	Square or U-shaped	Rounded
3.	Angle of body with ramus	Less obtuse ($< 125^\circ$), prominent	More obtuse, not prominent
4.	Angle of mandible (gonion)	Everted	Inverted
5.	Body height at symphysis	Greater	Smaller
6.	Ascending ramus	Greater breadth	Smaller breadth
7.	Ramus flexure	Rearward angulation of the posterior border of ramus	Straight ramus
8.	Muscular markings	Prominent	Not prominent

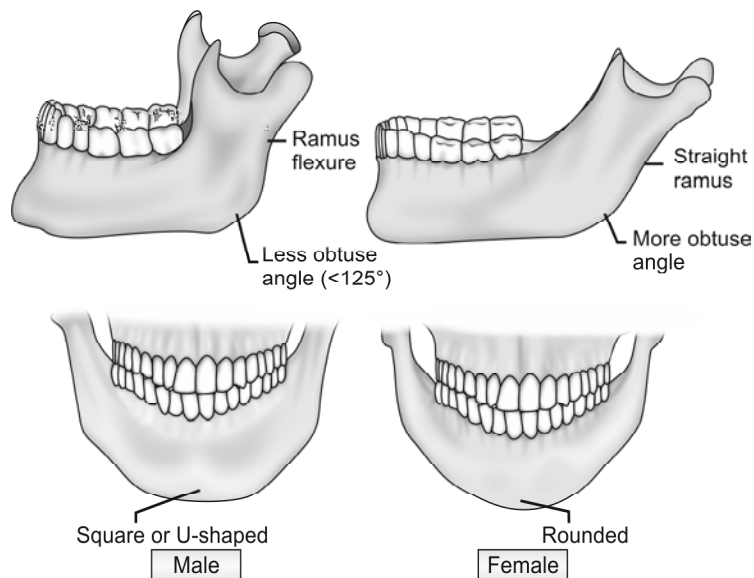

Fig. 4.6: Male and female mandible

Differentiation 4.5: Male and female pelvis (Figs 4.7 and 4.8)^{36,37}

S.No.	Feature	Male pelvis	Female pelvis
1.	General appearance	Massive, rougher, prominent muscular markings	Less massive, slender, smoother, muscular markings not prominent
2.	Shape	Deep funnel	Flat bowl
3.	Preauricular sulcus ³⁸ (attachment of anterior sacroiliac ligament)	Not frequent, narrow, shallow	More frequent, broad, deep
4.	Acetabulum	Large, 52 mm diameter	Small, 46 mm diameter
5.	Obturator foramen (Fig. 4.9)	Large, oval, base upwards	Small, triangular, apex forwards
6.	Greater sciatic notch (Fig. 4.10)	Narrow, deep, small	Broad, shallow, large
7.	Iliopectineal line	Well-marked, rough	Rounded, smooth
8.	Ischial tuberosity	Inverted	Everted
9.	Body of pubis (Fig. 4.9)	Narrow, triangular	Broad, square, pits on posterior surface, if borne children
10.	Subpubic angle	V-shaped, sharp angle, 70°-75°	U-shaped, rounded, broader angle, 90°-100°
11.	Pelvic brim or inlet	Heart-shaped	Circular or elliptical shaped
12.	Pelvic cavity	Conical, funnel shaped	Broad, round
13.	Pelvic outlet	Smaller	Larger
14.	Sacroiliac articulation	Large, extends to 2½-3 vertebrae	Small, extends to 2-2½ vertebrae
15.	Coccyx	Less movable	More movable

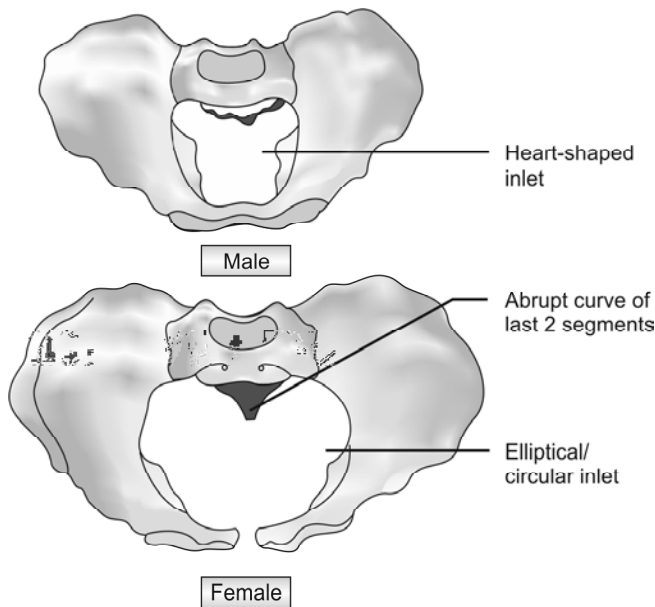

Fig. 4.7: Pelvis: Overview

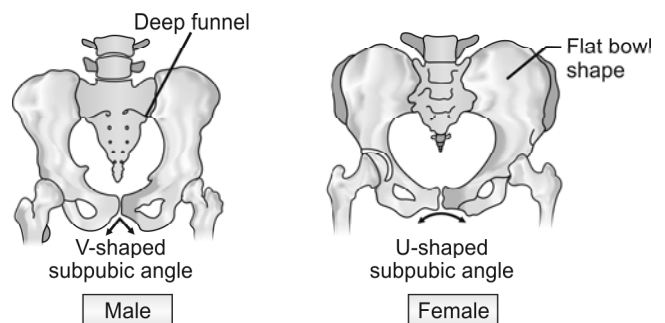

Fig. 4.8: Male and female pelvis

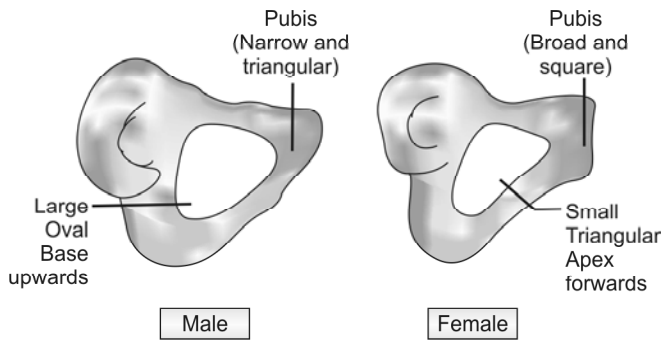

Fig. 4.9: Pelvis: Obturator foramen

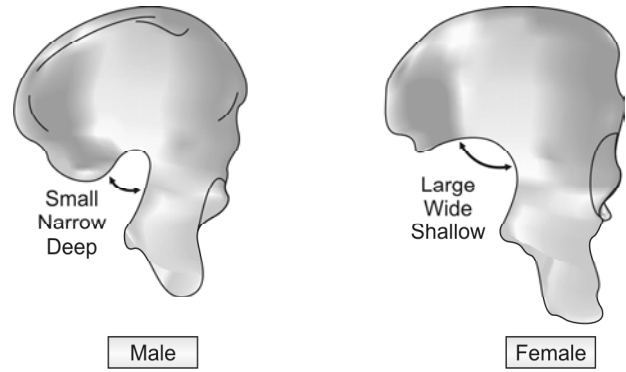

Fig. 4.10: Pelvis: Greater sciatic notch

Differentiation 4.6: Male and female sacrum (Fig. 4.11)

S.No.	Feature	Male sacrum	Female sacrum
1.	General appearance	Larger, heavier, rough, narrow	Smaller, lighter, smooth, broad
2.	Breadth of body of 1st sacral vertebra	More than breadth of one side ala	Less than breadth of one side ala
3.	Inner curvature (Fig. 4.7)	Uniformly curved anteriorly	Abruptly curved at the last two segments
4.	Sacroiliac articulation	Extends upto 3rd segment	Extends upto 2-2½ segment
5.	Sacroiliac joint surface	Large, less sharply angulated	L-shaped, elevated anteriorly

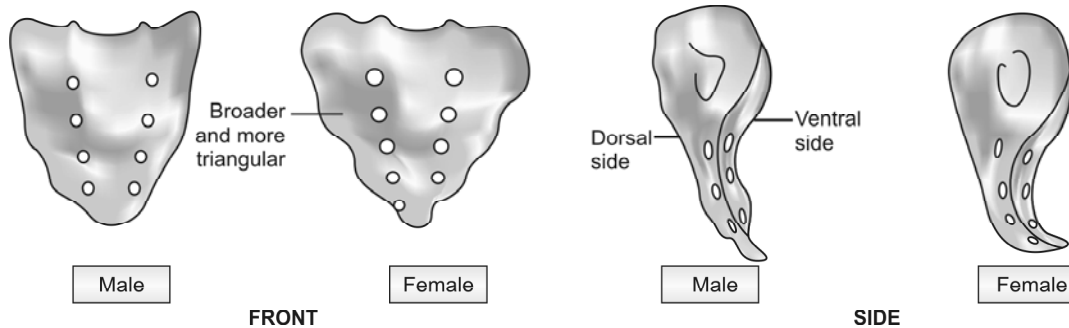

Fig. 4.11: Sacrum

Table 4.4: Diagnostic indexes for determination of sex

S.No.	Index	Formula	Male	Female
1.	Washburn/Ischiopubic index	$\frac{\text{Length of pubis}}{\text{Length of ischium}} \times 100$	73-94	91-115
2.	Sciatic notch index	$\frac{\text{Width of sciatic notch}}{\text{Depth of sciatic notch}} \times 100$	4-5	5-6
3.	Sternal index	$\frac{\text{Length of manubrium}}{\text{Length of body}} \times 100$	46.2	54.3
4.	Corporobasal index ³⁹	$\frac{\text{Breadth of body of 1st sacral vertebra}}{\text{Breadth of base of sacrum}} \times 100$	> 42	< 42
5.	Sacral index	$\frac{\text{Transverse diameter of base of sacrum}}{\text{Anterior length of sacrum}} \times 100$	< 114	> 114

Kimura's Base-wing index =

$$\frac{\text{Width of wing (ala of sacrum)}}{\text{Width of base (transverse diameter of body of S1)}} \times 100$$

Chilotic line: It is an anthropometric line extending from the posterior aspect of the iliopectineal eminence to the closest point on the anterior auricular margin (the pelvic segment) and then to the iliac crest (the sacral portion). Since the pelvic segment is predominant in females and the sacral segment is predominant in males, the chilotic index may be used to identify the sex of human skeletal remains.⁴⁰

$$\text{Chilotic line index} = \frac{\text{Sacral part of chilotic line}}{\text{Pelvic part of the chilotic line}} \times 100$$

Age

Age determination can be done through many means, and an analysis of all possible age-related attributes is best for an overall estimate. Some of the utilized features include:

- i. Dental eruption
- ii. Epiphyseal unions
- iii. Pubic symphyseal morphology
- iv. Cranial suture closures
- v. Mandibular and sacral changes
- vi. Miscellaneous
 - a. Secondary sexual characters
 - b. Age-related degenerative conditions.

Dentition in Determining Age

- Alveolar cavities which contain teeth are formed around the 3-4th month of intrauterine life (IUL).
- At birth, rudiments of all the temporary teeth and the 1st permanent molars may be found in jaw.
- Each tooth has a crown, neck and a root embedded in jaw bone (Fig. 4.12).
- Teeth are composed of dentin covered on the crown by enamel and on the root by cementum which is attached to the alveolar bone by periodontal membrane.
- Tooth formation proceeds in an invariable sequence. The first radiographic evidence is formation of a bony crypt followed by mineralization of crown tips. Mineralization proceeds from crown tips down the sides of the tooth.⁴¹
- Root mineralization does not begin until crown formation is complete and root formation ceases with the reduction of apical foramen. As the root becomes longer, the crown erupts through the bone.
- Mineralization of deciduous dentition begins in utero, early in 2nd trimester and root formation of third molar may not be complete until 20 years of age.

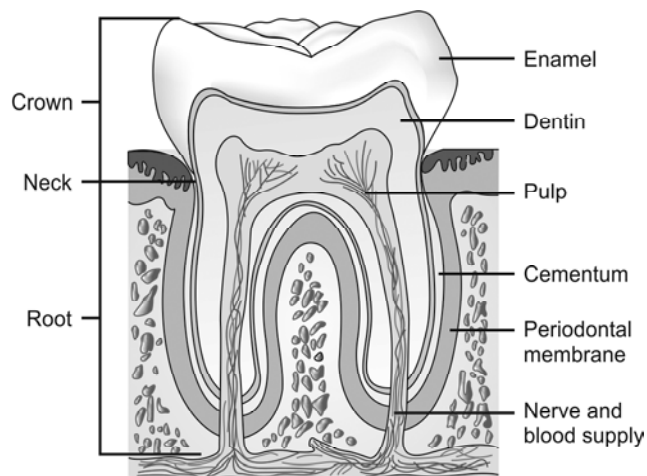

Fig. 4.12: Parts of a tooth

- During eruption of a permanent tooth, the overlying root of its deciduous predecessor simultaneously undergoes absorption, until only the crown remains. The unsupported crown then falls off.
- Age of eruption of teeth depends upon:
 - i. Heredity
 - ii. Environment
 - iii. Nutrition
 - iv. Endocrine factors.

Each individual has two sets of teeth (Diff. 4.7)

- i. Temporary/deciduous/milk teeth
- ii. Permanent teeth

Temporary teeth

- *20 in number:* 4 incisors, 2 canines and 4 molars in each jaw (Table 4.5 and Fig. 4.13).
- The eruption of the deciduous teeth commences at about 7 months after birth and is completed about the end of the 2nd year, the lower central incisor preceding those of the upper.^{43,44}
- In ill-nourished children, especially in rickets, dentition may be delayed.

Table 4.5: Eruption of deciduous teeth

S.No.	Tooth	Eruption (months)	Total no. of teeth
1.	Central incisor		
	• Lower ^{43,44}	6-8	2
	• Upper	7-9	4
2.	Lateral incisor		
	• Upper	7-9	6
	• Lower	10-12	8
3.	First molar	12-14	12
4.	Canine	17-18	16
5.	Second molar	20-30 (2-2½ years) ⁴⁵	20 ⁴⁶

Differentiation 4.7: Temporary and permanent teeth

S.No.	Feature	Temporary teeth	Permanent teeth
1.	Size	Smaller, lighter, narrower, except temporary molars which are longer than permanent premolars	Heavier, stronger, broader, except permanent premolars
2.	Direction of anterior teeth	Vertical	Inclined forward
3.	Crown color	China-white	Ivory-white
4.	Neck	More constricted	Less constricted
5.	Ridge ⁴²	Present at the junction of the crown and the root	Not present
6.	Root	Roots of molars are smaller, more divergent	Roots of molars are larger, less divergent
7.	Incisors	Smooth incisal edge	Ridged, especially on incisal surface
8.	Radiology	Presence of tooth germ beneath tooth will suggest that tooth is temporary	No such thing visible in case of permanent teeth

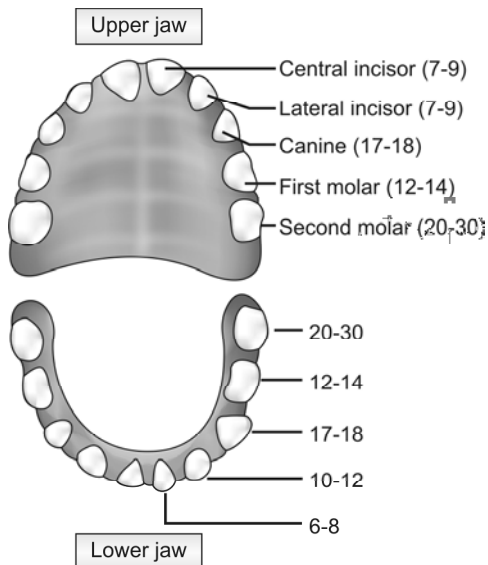

Fig. 4.13: Eruption of deciduous teeth (in months)

- In congenital syphilis, teeth may be premature or even present at birth.

Permanent teeth: 32 in number—4 incisors, 4 premolars, 2 canines and 6 molars in each jaw (Table 4.6 and Fig. 4.14).

Developmentally teeth are divided into 2 sets:

- Super-added permanent teeth:** These teeth do not have deciduous predecessors. All permanent molars belong to this category (6 in each jaw).
 - Successional permanent teeth:** These teeth erupt in place of deciduous teeth, e.g. permanent premolars erupt in place of deciduous molars (10 in each jaw).
- Usually permanent tooth erupts first in lower jaw.

Table 4.6: Eruption of permanent teeth

S.No.	Tooth	Eruption (years)
1.	First molar ^{47,48}	6-7
2.	Central incisor	6-8
3.	Lateral incisor ⁴⁹	7-9
4.	First premolar	9-11
5.	Second premolar	10-12
6.	Canine	11-12
7.	Second molar	12-14
8.	Third molar	17-25

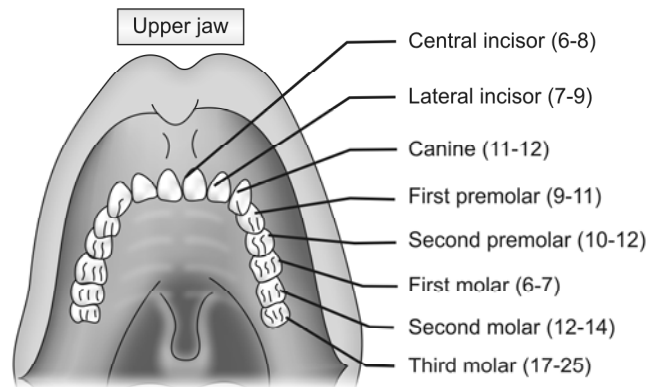

Fig. 4.14: Eruption of permanent teeth (in years)

- Permanent teeth appear few months earlier in girls than in boys.
- Eruption of teeth is useful in estimating age upto 15 years. The third molar (wisdom tooth) erupts after this time, but is so variable in age of eruption that it is not a reliable age indicator.

- The mandibular third molar is the most commonly impacted tooth in the mouth and is closely followed by maxillary third molar, maxillary canine and mandibular canine respectively.⁵⁰
- If, in the jaw all 3rd molars are present, then the age is over 18 years, but their absence gives no certain idea about age.

An impacted tooth is the one that fails to erupt into proper function in the dental arch within the expected time.

Spacing of jaw: After eruption of 2nd molars, the ramus of mandible grows behind to make room for the eruption of 3rd molar teeth which is known as *spacing of the jaw*.

Period of mixed dentition: Starting from the day of eruption of first permanent molar till before the eruption of last permanent canine—both temporary and permanent teeth are present in the jaw. This duration is known as *period of mixed dentition* (Table 4.7). Usually, it is between 6-11 years, but may persist until 12-13 years.⁵¹

- From 6-11 years, the number remains 24 because as and when a tooth erupts, it displaces another and the number remains constant.

Table 4.7: Number of teeth with age

Age (years)	Number of teeth	
2-5	20	(All deciduous)
6	21-24	(Eruption of 1st permanent molars)
7-9 ⁵²	24	(12 permanent—8 incisors, 4 molars) (12 deciduous—4 canines, 8 molars)
10 ⁵³	24	(16 permanent—8 incisors, 4 molars, 4 premolars) (8 deciduous—second molars and canines)
11 ⁵⁴	24	(20 permanent—8 incisors, 4 molars, 8 premolars) (4 deciduous—canines)
12-14	25-28	(Eruption of 2nd permanent molars)
14-17	28	(All permanent)
17-25	29-32	(Eruption of 3rd molars)

- There is addition of teeth from the age of 12-14 years, when the second molar erupts and the total number becomes 28. Then the number remains constant till 17 years and again 4 more are added from 17-25 years and the number becomes 32.

Estimation of age from teeth beyond 25 years

- **Dental attrition or occlusal wear:** The amount of wear on all three permanent molars occurs at comparable rates which can be assessed and age estimation made on the basis of comparison to the baseline.
- Gustafson's method
- Aspartic acid racemization
- **Boyde's method:** It is based on counting incremental lines in cementum on histological section starting from the neonatal line (formed at birth).
- **Chemical method:** Estimation of nitrogen content of enamel (increases with age), carbonate content (decreases with age) and concentration of ions—Cu, Se and Fe (increases with age).
- **Radiocarbon dating of tooth enamel:** It may give a precise estimation of an individual's date of birth.

Of the non-destructive methods (where tooth is not required to be taken out), assessing stages of development of the mineralization of the teeth using radiographs are more reliable than those using tooth counts. Amino acid racemization is considered to be most reliable destructive method of dental age estimation.

Gustafson's Method

- Age estimation consists of microscopic examination of longitudinal section of central part of the tooth to assess changes in teeth as a result of wear and tear with advancing age.⁵⁵
- Estimate age between 25-60 years.⁵⁶
- Useful only while examining a *dead body or skeletal remains*, as teeth need to be extracted for examination.
- It is based on criteria given in Table 4.8 (Fig. 4.12).

Table 4.8: Gustafson's criteria⁵⁷

S.No.	Changes	Description
1.	Attrition	Wearing down of occlusal surface due to mastication, first involving enamel, then dentin and lastly pulp.
2.	Periodontosis	Retraction of gum margin and loosening of tooth exposing the neck and adjacent parts of roots.
3.	Secondary dentin	Progressive infilling of the dental pulp cavity, decreases the size of cavity and may completely obliterate it.
4.	Cementum apposition	Cementum increase in thickness around the root due to changes in tooth position, continuously deposited throughout life and forms incremental lines.
5.	Root resorption	Involves both cementum and dentin. Starts at apex and extends upwards.
6.	Root transparency	Occurs in root from below upwards in lower jaw and above downwards in upper jaw due to rarefaction of the dentin tissue. <i>Most reliable of all criteria.</i> ⁵⁸

- Before tooth is extracted from the body, degree of periodontosis is estimated.
- Tooth is ground down on glass slabs from both sides to about 1 mm, which allows estimation of transparency, then it is further ground to about ¼ mm for microscopic examination.
- Anterior teeth are more suitable than posterior teeth. Merit decreases from incisors to premolars, molars are quite unsuitable.
- All changes are absent at 15 years. Error is $\pm 10-15$ years. Limit of error increases above 50 years of age.
- 0-3 points are allotted to indicate the degree of any of these changes:
 - 0—No change
 - 1—Beginning of change
 - 2—Obvious change
 - 3—Maximum change

- **Histological technique:** It is based on the counting of incremental lines in dental cementum added to the average age of tooth eruption for the estimation of the age at death. The amount of dentin laid down after the formation of the neonatal line in deciduous dentition, and counting of cross-striations and striae of Retzius in primary and secondary enamel may help in finding the chronological age. Once enamel depositions are complete, the use of cemental annulations rings can be used.
- **Aspartic acid racemization:** The analysis has been done on both tooth enamel and crown dentin with analysis of dentin giving more accurate age estimation than enamel. During the course of aging, L-forms of amino acids are transformed by racemization to D-forms. Thus, the extent of racemization of amino acids may be used to estimate the age (time that has lapsed since the dentin was laid down and when the ratio was zero). Of all amino acids, aspartic acid has one of the fastest racemization rates and most commonly used for age estimation.
- **Radiocarbon analysis of tooth enamel:** This method is used to determine the year of tooth formation based on levels of radiocarbon present in tooth enamel.

Other Information from Teeth

- **Sex determination**
 - i. Identifying Y-chromosome in dental pulp tissue using quinacrine and fluorescent microscopy.
 - ii. Isolation of sex-specific banding patterns in DNA profiles of X and Y-chromosomes.
- **Race**
 - i. '*Shovel-shaped*' incisors found in most Mongoloids and Americans.
 - ii. *Carabelli's cusp* (seen in whites), *taurodontism* (bull tooth) and *enamel pearls* (common in Mongoloids) have been listed as racial determinants.

Carabelli's tubercle is an anomalous cusp on the mesial palatal surface of the upper first permanent molars, most commonly seen among Europeans (75-85%) [50% of American whites and 34% of Afro-Americans].

- **Taurodontism** is an aberration of teeth that lacks the constriction at the level of the cemento-enamel junction characterized by elongated pulp chambers and apical displacement of bifurcation or trifurcation of the roots, giving it a rectangular shape. The term means 'bull like' teeth derived from similarity of these teeth to those of cud chewing animals.
- Taurodontism, especially in maxillary molars, enamel pearls on premolars and congenital lack of upper 3rd molars are commonly seen in Mongoloids.

Occupation and habits

- i. Cobblers or tailors usually show notched upper incisors from wear and tear.
 - ii. Dark brown stains on the back of incisors are seen in 'cigarette smokers.'
- **Social status:** From general cleanliness, dentures and dental fillings by gold, silver or other metal.

Age from Ossification of Bones

- The clavicle is the first bone to ossify in the body from two membranous primary ossification centres during the 5-6th postovulatory week. A secondary centre forms in the sternal end between 15-17 years and fuses by 20-22 years. In majority of the bones, primary centres of ossification appear between 7th and 12th weeks of intrauterine life.⁵⁹ By the age of 11-12th week of IUL, there are 806 centres of ossification.
- At birth, there are about 450 ossification centres.⁶⁰ The adult human skeleton has 206 bones, this shows that 600 centres of bone growth have disappeared i.e. they have united with adjacent centres to give rise to adult bone.
- The process of appearance and union has a sequence and time (approximate age ranges) (Table 4.9).
- Ossification begins centrally in an epiphysis and spreads peripherally as it gets bigger.
- Process of union of epiphysis and diaphysis is called *fusion*. Union is a process not an event.
- Some researchers have used five grades of epiphyseal union: unobservable (0), beginning (1), active (2), recent (3) and complete (4), and these offer a possibly more accurate estimate of age.
- Capitate and hamate ossifies during infancy (1 year), the former preceding the later.⁶¹ Between 2-6 years, the number of carpal bones present on X-ray represents the approximate age in years, e.g. 3 carpal bones—3 years (Fig. 4.15).⁶²⁻⁶⁵
- If all the epiphyses of all the long bones are united, the person is most probably over 25 years of age.
- X-rays of elbow, wrist, clavicle and shoulder joints (upper extremity) and hip, knee and ankle joints (lower

Table 4.9: Appearance of ossification centres

S.No.	Bone	Centres of ossification	Age of appearance	Age of union
1.	Sternum	<ul style="list-style-type: none"> Manubrium 1st Sternebrae 2nd and 3rd Sternebrae 4th Sternebrae Xiphisternum 	5th month IUL 5th month IUL 7th month IUL 10th month IUL 3rd year postnatal	Old age 14-25 years 14 years 40 years
2.	Clavicle	Medial end	15-17 years	20-22 years
Upper Limb				
3.	Humerus	<ul style="list-style-type: none"> Head Greater tubercle Lesser tubercle Capitulum Trochlea Lateral epicondyle Medial epicondyle 	1 year 3 years 5 years 1 year 9-10 years 10-11 years 5-6 years	At 5-6 years, the three fuses together and at 17-18 years, fuses with the shaft At 14-15 years, all three fuses with the shaft 16 years
4.	Radius	<ul style="list-style-type: none"> Upper end Lower end 	5-6 years 2 years	15-17 years 17-19 years
5.	Ulna	<ul style="list-style-type: none"> Upper end⁶⁶ Lower end 	9 years 6 years	15-17 years 17-19 years
6.	Carpals	Pisiform	9-12 years	—
Lower Limb				
7.	Hip Bone	<ul style="list-style-type: none"> Ischiopubic rami Triradiate cartilage Iliac crest Ischial tuberosity 	— — 15-16 years 16-17 years	7 years 12-14 years 19-21 years 21-22 years
8.	Femur	<ul style="list-style-type: none"> Head Greater trochantar Lesser trochantar Lower end 	1 year 4 years 14 years 9 months IUL (at birth)	17-18 years 14-15 years 15-17 years 17-18 years
9.	Tibia	<ul style="list-style-type: none"> Upper end Lower end 	At birth 1 year	17-18 years 16-17 years
10.	Fibula	<ul style="list-style-type: none"> Upper end Lower end 	4 years 2 years	17-18 years 16-17 years
11.	Tarsals	<ul style="list-style-type: none"> Calcaneum Talus Cuboid 	5th month IUL 7th month IUL 9th month IUL	17-18 years

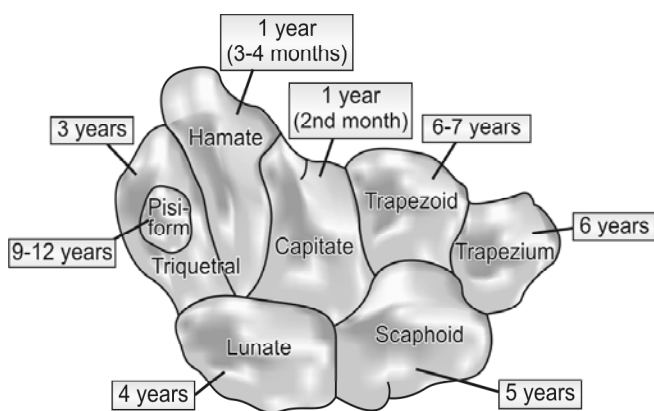

Fig. 4.15: Ossification of carpal bones (simplified)

extremity) are usually recommended to determine the age before 25 years of age.

- Determination of age based on the union of epiphyses with a range of ± 6 months is given in Table 4.10. In females, epiphyseal union occurs 1-2 years earlier than males.

Table 4.10: Radiological age determination (before 25 years)

S.No.	Site for X-ray (region)	Age (years)	
		Female	Male
1.	Elbow	13-14	15-16
2.	Wrist ⁶⁷	16-17	18-19
3.	Shoulder	17-18	18-19
4.	Iliac crest	18-19	19-21
5.	Ischial tuberosity and inner end of clavicle	21-22	21-23

Age Determination in Adults Over 25 years

After the age of 25 years, estimation of age becomes more uncertain.

Symphyseal Surface of Pubis

- The pubic symphyseal face in the young is characterized by an undulating surface, such as the crenulated surface of a typical non-fused epiphyseal plate.
- This surface undergoes a regular progressive change from 18 years onwards.
- It is the *best single criterion* for determining age-at-death for individuals from third to fifth decade.
- Morphologic changes seen in males with age are given in Table 4.11 and Figure 4.16.
- Various features that are noted on the symphyseal surface—ridges and furrows, dorsal margin, ventral bevelling, lower extremity, ossific nodule, upper extremity, ventral rampart, dorsal plateau and symphyseal rim.

Skull Suture Closure (Table 4.12 and Fig. 4.17)

- This method bases age upon the degree of closure, union or ossification of the cranial sutures.

Table 4.11: Age determination from pubic symphysis (in males)

Age	Features
< 20 years	Compact bone near its surface
About 20 years	<ul style="list-style-type: none"> • Surface markedly irregular/uneven • Ridges runs transversely across articular surface
25-40 years	<ul style="list-style-type: none"> • Ridges gradually disappear • Surface has granular appearance • Outer and inner margins completely defined
40+ (Early 5th decade)	Oval smooth surface with raised upper and lower ends
Late 5th decade	Narrow beaded rim develops on margin
50+ (6th decade)	Erosion of surface and breakdown of ventral margins
60+ (7th decade)	Surface becomes irregularly eroded

Note: If male criteria are used for females, the age would be underestimated by about 10 years.



Fig. 4.16: Changes in pubic symphyseal surface with age

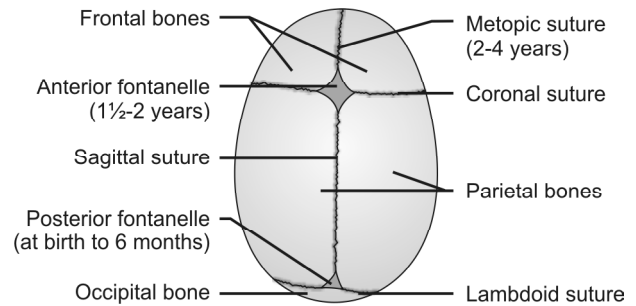

Fig. 4.17: Normal skull of the newborn

- The closure of the skull sutures is considered to be a reasonably reliable index of age estimation between 25-40 years of age (useful in living also).⁶⁸
- Closure of skull sutures begins on the inner side (endocranially) 5-10 years earlier than on the outer side (ectocranially). The closure of ectocranial suture is variable and it may not close at all (lapsed union). It is more commonly seen in sagittal suture.
- The *most successful estimate* of age is done from *sagittal suture*, followed by lambdoid and then coronal. The sutures start closing on the inner side at about 25 years of age. On the outer side, posterior one-third of sagittal suture closes at about 30-40 years; anterior one-third of sagittal and lower half of coronal at about 40-50 years; and middle of sagittal and upper half of the coronal at about 50-60 years (Fig. 4.18).
- A *lateral head skiagram* is preferable for observing the sutures.

Table 4.12: Age determination from skull suture closure

S.No.	Suture closure	Age
1.	Posterior fontanelle (occipital) ⁶⁹	At birth to 6 months
2.	Anterior fontanelle (bregma) ⁷⁰	1½ -2 years
3.	Two halves of mandible	1-2 years
4.	Metopic suture (between frontal bones)	2-4 years, may remain unfused
5.	Basiocciput and basisphenoid	18-20 years (females), 20-22 (males)
6.	Lambdoid suture	45-50 years
7.	Parieto-temporal	60-70 years

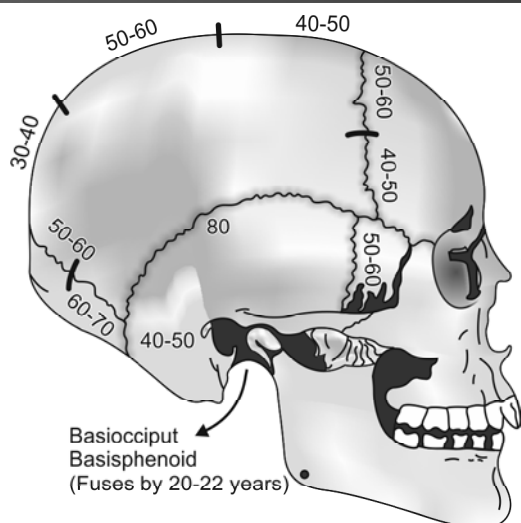

Fig. 4.18: Age (in years) of skull suture closure

Age Estimation from Mandible

It is given in Diff. 4.8.

Sacrum

The five sacral vertebrae remain separated by cartilage until puberty and with the onset of puberty, ossification of intervertebral discs starts from below upwards and fusion becomes complete by 20-25 years.

General Features in Estimation of Age

It includes secondary sexual characters, baldness or graying of hair, arcus senilis and skeletal changes.

Secondary sexual characters

In males

- The first sign of puberty in boys is increase in size of the testicles (*gonadarche*), seen at about 13-14 years which is followed a few months later by the growth of pubic hair (*pubarche*) and enlargement of penis.⁷¹

- At about 15 years, hair is moderately grown on pubis, and hair begins to grow in axilla.
- At about 16 years, hair in pubis is well grown and external genitalia have adult appearance. Hair begins to appear between 16-18 years on face and voice becomes hoarse.

In females

- The first sign of puberty in girls is the development of breasts (*thelarche*), seen at about 10-12 years.⁷² Development of pubic hair and the external genitalia is usually the second change seen within 2 months of thelarche. The first menstrual bleeding (*menarche*) occurs at an average age of 13 years.
- At about 14-15 years, pubic hair is well grown and hair appears in axilla.

Older years

Many non-pathogenic conditions such as arthritis and osteoporosis become more prevalent and pronounced in old age and can be used to give corroborative evidence in the determination of age.

- Baldness or graying of hair does not carry much value in calculating age. But, pubic hair does not turn gray before 50-55 years.
- Arcus senilis:** Opaque zone around periphery of cornea may be noticed as a result of lipoid degeneration after 50 years, but is not complete before 60 years.
- Pterygia:** Localized, elevated yellow-white areas that develop on the conjunctiva and cornea. Located most often nasally but sometimes temporally and are usually bilateral. Pterygia are generally found in middle-aged or elderly individuals.
- Skeletal changes**
 - Thyroid and cricoid cartilage (1st tracheal ring) tend to ossify by about 45-50 years.

Differentiation 4.8: Mandibles of infancy, adult and old age (Fig. 4.19)

S.No.	Feature	Infancy	Adult	Old age
1.	Body	Shallow	Thick and long	Shallow
2.	Ramus	Short, oblique, forms obtuse angle with body	Less obtuse angle	Obtuse angle with body (about 140°)
3.	Mental foramen	Opens near the lower margin and directed forwards	Opens midway between upper and lower margins and directed horizontally backwards	Opens near the alveolar margin
4.	Condylod process	At a lower level than coronoid process	Elongated and projects above coronoid process	Neck is bent backwards

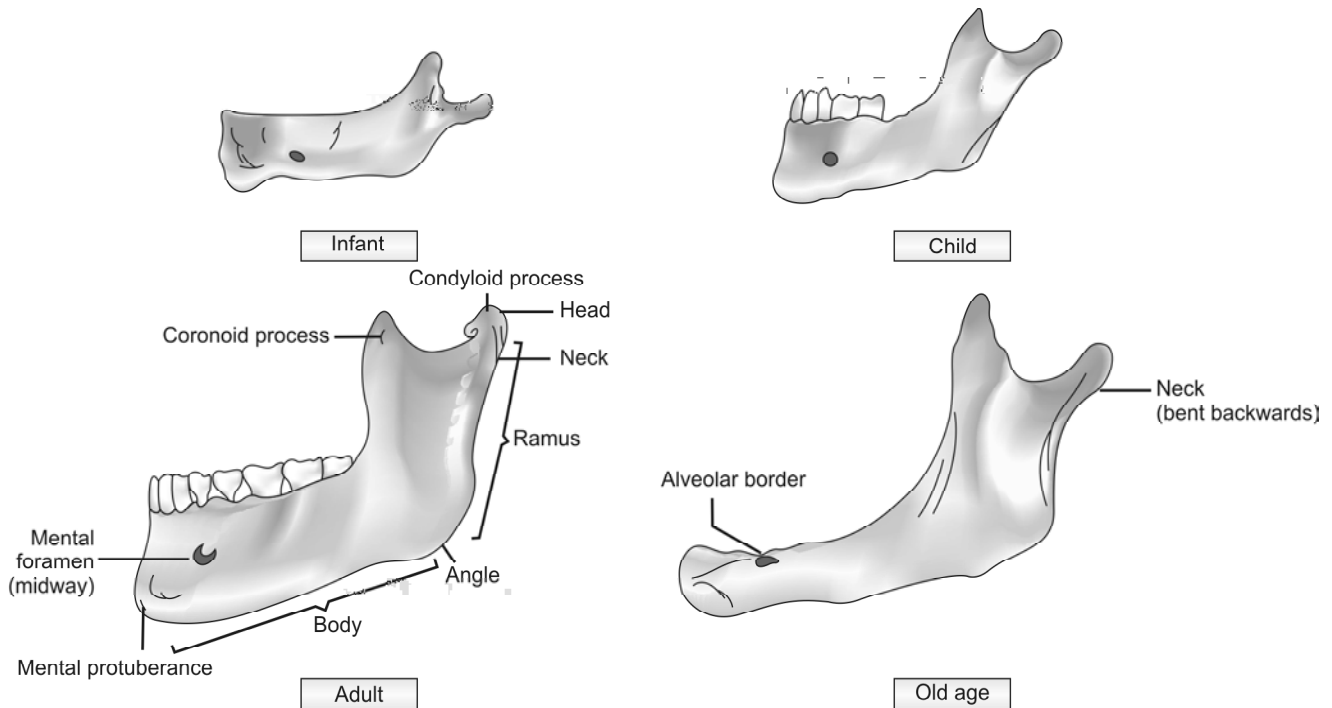

Fig. 4.19: Mandible at different ages

- Greater cornu fuse with the body of hyoid by 40-45 years.
- Xiphisternum and manubrium unite with the body of sternum around 40 years and above 50 years respectively.⁷³
- Lipping of lumbar vertebrae occurs around 40-50 years (osteophytosis) and atrophic changes occur in intervertebral disc with diminution of joint space at about 50-60 years.
- Skull bones with advancing age tend to become lighter and thinner.

X-ray of skull, vertebrae and sternum is used to determine age in old people.

- **Phase changes in the sternal rib:** System of age estimation based on sequential morphological changes at the sternal end (costochondral joint) between the rib and sternum of the 4th rib. These changes are similar to those that occur on the pubic symphyseal face.
- **Cortical bone histology:** System of aging based on calculating the rate of osteon turnover or replacement osteon from midshaft of long bone sections. It involves counting the number of whole osteons and osteon fragments (which increase in number with age), and nonhaversian canals and the percentage of circumferential lamellar bone in the cortex (which decreases with age, completely disappearing at about age 50)—best correlation coming from the fibula, then the femur and the tibia.

Medico-legal Importance of Age

Medico-legal importance of various age groups is given in Table 4.13.

- **Evidence:** Competency for giving evidence depends upon understanding, but not on age. A child of any age can give evidence, if the court is satisfied that the child is truthful (**Sec. 118 IEA**).
- **Criminal abortion:** A woman who has passed the childbearing age cannot be charged of procuring criminal abortion.
- **Identification:** An approximate age is important in any chain of identity data.
- **Impotence and sterility:** A boy is sterile though not impotent before puberty; woman becomes sterile after menopause.

Stature

- Stature varies at different times of day by 1.5-2 cm. It is less in the afternoon and evening due to reduced elasticity of intervertebral discs and the longitudinal vertebral muscles.
- After the age of 30, the natural process of senile degeneration causes gradual decrease in stature by 0.6 mm per year on average.
- Stature is greater by 1-3 cm on lying down.

Table 4.13: Medico-legal importance of various age groups

Age	Medico-legal importance
3rd lunar month (12 weeks of pregnancy)	Till this duration, decision for termination of pregnancy can be taken by one doctor.
5th lunar month (20 weeks of pregnancy)	Maximum period of gestation for use of the indication of MTP Act. Above this age, termination is only on therapeutic grounds.
7th lunar month (28 weeks of pregnancy)	Fetus born after this period, if it does not show any sign of life, is termed stillborn fetus.
7th calendar month (210 days)	Fetus is considered to be viable.
10th lunar month	Fetus at this stage is a full term fetus.
5 years ⁷⁴	Above this age, a child becomes responsible for his act leading to wreckage of train (according to Railway Act).
7 years ⁷⁵	Below this age, child is not responsible for his criminal act, as he does not understand the nature and consequences of his act (Sec. 82 IPC).
7-12 years	Criminal responsibility: A child may or may not be held responsible for his act by the court, depending upon whether the child has attained sufficient maturity to understand the nature and consequence of the act (Sec. 83 IPC).
10 years	If a child below this age is removed from his lawful guardian for purpose of robbing movable property from his/her possession, it will amount to kidnapping (Sec. 369 IPC) .
12 years	A child under 12 years cannot give valid consent to suffer any harm which may occur from any act done in good faith and for his benefit (Sec. 89 IPC).
14 years	Employment: According to the Factory Act, a person below this age is a child and cannot be employed in factory jobs.
14-15 years	A person can be engaged in non-hazardous factory jobs for a limited period during the day hours.
15 years	<ul style="list-style-type: none"> Sexual intercourse even with wife, below this age amounts to rape. A person above 15 years of age can be <i>employed</i> in a factory like an adult, if he has a fitness certificate from a doctor.
16 years	<ul style="list-style-type: none"> Taking away a <i>male</i> under this age without consent of guardian amount to kidnapping. Statutory rape: Intercourse with a girl below this age, irrespective of whether with or without her consent amounts to rape.
17 years	<ul style="list-style-type: none"> Admission in a medical college. A juvenile or child over this age but < 18 years, would stay in the after-care organization till he attains the age of 20 years.
18 years ⁷⁶⁻⁷⁸	<ul style="list-style-type: none"> Judicial punishment: Below this age, an offender is juvenile and is tried in juvenile court and if convicted, sent to reformatory school (no imprisonment or death sentence). Age of majority except when the individual is under guardianship of court. Age of marriage for females. Can cast vote. Mentally sound person can make a valid will. Taking out or enticement of a <i>girl</i> below this age from custody of her guardian amounts to kidnapping. Kidnapping a boy or girl below this age for purpose of begging is punishable with imprisonment of 10 years with or without fine. Can be employed in any authorized job in a factory. Can give valid consent to suffer any harm which may result from an act not intended or not known to cause death or grievous hurt (Sec. 87 IPC). Minimum age for entering a government service.
21 years ^{79,80}	<ul style="list-style-type: none"> Age of marriage for males. If a girl below this age is 'imported' to India from foreign country for the purpose of illicit intercourse, the act amounts to kidnapping (Sec. 366 B IPC). Person under the guardianship of the Court of Wards attains majority.
25 years	<ul style="list-style-type: none"> Age for contesting membership of parliament and other legislative bodies. Age limit for entering in some government services. According to Punjab Excise Act, a person below this age cannot buy and consume liquor.
35 years	Minimum age for appointment as President, Vice-President and Governor of States in India.
55-65 years	Age of retirement from services under the government, Statutory bodies, autonomous bodies/institutes or from judiciary services.

Note: Lunar month—28 days, calendar month—30 days

- On an average, the body lengthens after death by about 2 cm, due to complete loss of muscle tone, relaxation of large joints and loss of tensioning effect of paraspinal muscles on intervertebral discs.
- If the body has been dismembered or skeletonized, the approximate stature may be determined by:
 - i. Length of entire skeleton and 2.5-4 cm for thickness of soft parts.
 - ii. Length from tip of middle finger to the tip of the opposite finger when arms are fully extended.
 - iii. Twice the length of one arm with 30 cm added for two clavicles and 4 cm for sternum.
 - iv. Length from vertex to the symphysis pubis is roughly half of stature.
 - v. Length from sternal notch to symphysis pubis multiplied by 3.3.

Stature from Bones

The methods in use to determine the stature can be divided into:

- least squares regression equation and other regression principles
 - stature: bone length ratios
 - skeleton height and adjustment for missing soft tissue
- Sex and race of the individual should be taken into account while applying these methods.
- When whole skeleton is not available, but one or the other long bones are available, then regression equations are used.
 - Pearson's regression formula (first reported this in 1899) is the most commonly used method to determine the stature based on long bones. The formula for femur being: $\text{Stature} = 81.306 + 1.88 \times F$ (length of femur in males).⁸¹
 - Several authors have offered regression equations, viz. Breitingger, Telkkä, Dupertius and Hadden, Trotter and Gleser, and Muñoz.⁸² They are derived for one population (usually Europeans and North Americans) and as such not suitable for Indians. Moreover, these formulae's are not valid for children.
 - Combination of bones is more reliable than a single bone and long bones of lower limb (femur and tibia) give better estimate than upper limbs (humerus and radius).
 - *Multiplication factors to calculate stature* for femur: 3.6–3.8; tibia and fibula: 4.48; humerus: 5.30; radius 6.7–6.9 and ulna: 6.0–6.3 (approximately).⁸³
 - In taking measurements of bones, their lengths are measured using Hepburn type osteometric board (Fig. 4.20).

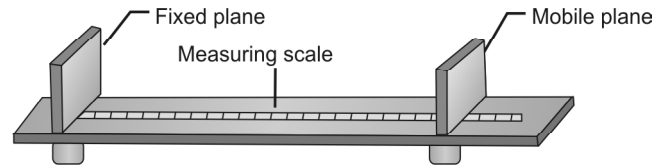

Fig. 4.20: Osteometric board

Scars

Definition: It is a fibrous tissue covered by epithelium without hair follicles, sweat glands or pigment, produced from the healing of a wound. Scar is formed, if injury is at the level of dermis and below.

The most superficial wounds which involve the epidermis, e.g. superficial burns or abrasions will heal by epithelialization alone without scar formation.

Examination: Good lighting is essential. Description of scars should include number, site, size and shape, level it bears to the body surface, fixed or free, smoothness or irregularity of the surface, color, presence or absence of glistening, tenderness, condition of the ends whether tapering or not, and the probable direction of the original wound.

Characteristic of Scars

- Scars from lacerated wounds and infected wounds are firmer, irregular, prominent and attached to the deeper tissues.
- Incised wounds produce linear scars.
- Stab wound due to knife produces oval, elliptical, triangular or irregular scars which are depressed.
- Bullet wound causes a circular depressed scar.
- Scars from scalds have spotted appearance.
- Vaccination scars are circular or oval, flat or slightly depressed.

Growth: Scars produced in childhood grow in size, especially if situated on chest or limbs.

Age of scars (Table 4.14).

Erasure: Scar can be erased by excision and skin grafting.

Table 4.14: Age determination of scars

Features	Duration
Firm union, reddish/bluish scar	5-6 days
Pale, soft and sensitive (tender)	2 weeks–2 months
Tough, brownish, glistening, wrinkled and little tender	2-6 months
Tough, white, glistening and non-tender	> 6 months

Medico-legal Importance

- i. Identification of the individual.
- ii. Shape of scar may indicate the nature of weapon or agent that caused injury.
- iii. Age of scar indicates time of infliction of injury which may have value as circumstantial evidence.
- iv. If a person is disfigured by scar due to assault, it constitutes grievous hurt (**Sec. 320 IPC**).
- v. Striae gravidarum and linea albicantes may indicate previous pregnancy in females.
- vi. To charge an enemy with assault, a person may attribute scar due to disease as those of wound.
- vii. Scars on wrist or throat may indicate previous attempts at suicide.
- viii. Linear needle scars indicate an IV drug abuser and depressed scars a skin popper.

Tattoo Marks

Definition: Tattoos (Tahitian or Polynesian *tatau*: to mark or strike) are designs made in the skin by multiple small puncture wounds with needles dipped in coloring matter which is attached to an oscillating unit. The unit rapidly and repeatedly drives the needles in and out of the skin, usually 50-3000 times a minute.

Dyes used: Indigo, cobalt, carbon, vermilion, cadmium, selenium, Prussian blue and Indian ink.

- Color, design, size and situation should be noted.
- The permanency of tattoo marks depends upon the type of dye used, the depth of its penetration and the part of body tattooed. Permanent tattoos are obtained if:
 - i. Black, blue and red dyes are employed
 - ii. The dye penetrates the dermis.
 - iii. The part of body is protected by clothing.
- A latent (faded) tattoo mark becomes visible by rubbing that part and examining with magnifying lens. The use of high contrast photography, computer image enhancement, UV lamp or infra-red photography is also helpful for identifying faded tattoos.
- Tattoos are recognized even in decomposed bodies and bodies recovered from water when the epidermis is removed.

Complications: Septic inflammation, abscess, gangrene, syphilis, hepatitis B, AIDS, leprosy and tuberculosis.

Erasure of Tattoo

- i. Surgical methods
 - Dermabrasion using dermabraders or with CO₂ or Erbium:YAG laser. Laser beam vaporizes the

particles of the dye and are expelled from tissues in gaseous form.

- Complete excision and skin grafting
 - Production of burns by means of red hot iron
 - Scarification
 - Using carbon dioxide snow
- ii. Electrolysis.
 - iii. Caustic or corrosive substances remove pigment by producing inflammatory reaction and superficial scar, e.g. mixture of papain in glycerin.
- Chronic eczema may cause the tattoo designs to disappear.

Medico-legal Importance

It helps in knowing the:

- i. **Identity** of a person, particularly the dead or decomposed individual—his name or spouse's or friend's; date of birth or service.
- ii. **Religion and nationality:** Designs of Cross or Christ (in Christians) and Hanuman, Lord Krishna (in Hindus).
- iii. **Political affiliations**, e.g. hammer and sickle, lotus or right hand.
- iv. **Race:** Tattooing of the chest and limbs is common amongst the Japanese.
- v. **Profession/occupation:** Some gangs have certain specific emblems of tattoo marks. Some occupations, e.g. coal miners leave visible tattoo marks on the hands and face.
- vi. **Behavioral characteristics:** Erotic tattoos of the sexual fanatic, blue bird design on the extensor surface of the web of thumb of homosexuals, number 13 inside the lower lip of drug pushers, addict type of tattoo marks to conceal injection sites.
- vii. It may also represent **social status** of that individual.

Notes

- **Marfan syndrome** is an inherited connective-tissue disorder transmitted as an autosomal dominant trait. Cardinal features include tall stature, ectopia lentis, mitral valve prolapse, aortic root dilatation and aortic dissection.
- **Down syndrome** is the most common chromosomal disorder and the most common cause of intellectual disability that result from having an extra copy of chromosome 21.
- **Patau syndrome** or Trisomy 13 is a chromosomal condition associated with severe intellectual disability and physical abnormalities including heart and kidney defects.
- **Cri-du-chat syndrome** is caused by a partial deletion of chromosome 5p and is characterized by a high-pitched, catlike cry in infancy with growth failure, simian crease, microcephaly, facial abnormalities, micrognathia, and mental retardation.

- **Noonan syndrome** is a genetic disorder that affects men and women equally. It was thought to be a form of Turner syndrome, but patients with this syndrome have normal karyotype—important distinction between the Turner and Noonan syndromes. Cardinal features include hypertelorism, down-slanting eyes, webbed neck, congenital heart disease (in 50%), short stature, mental retardation (in 25%), bleeding diathesis and chest deformity.
- **Sheehan syndrome** occurs due to necrosis of the pituitary gland with associated hypopituitarism resulting from postpartum hemorrhage and hypovolemic shock.
- **Virilizing ovarian tumor** is a rare cause of hyperandrogenism in women, and account for < 5% of all ovarian neoplasms.

- **Ovarian dysgenesis** is a rare type of female hypogonadism in which no functional ovaries are present to induce puberty in an otherwise normal girl whose karyotype is found to be 46, XX.
- **Dentigerous cyst:** The second most common odontogenic cyst is the dentigerous cyst (first being periapical cyst), which develops within the normal dental follicle that surrounds an unerupted tooth. It most frequently is found in areas where unerupted teeth are found: mandibular third molars, maxillary third molars and maxillary canines, in decreasing order of frequency.
- As per *Hindu Marriage Act*, marriage can be declared null and void, if one of the parties, at the time of ceremony, was incapable of giving valid consent or was unfit for marriage and procreation of children due to unsoundness of mind.⁷⁸

MULTIPLE CHOICE QUESTIONS

- Corpus delicti means:** *TN 02, 04, 07; AIIMS 08*
 - Essence of crime
 - Decomposed body
 - Identification of dead person
 - None
- Cephalic index is:** *Delhi 03*
 - Maximum breadth of skull
 - Maximum length of skull
 - Ratio of A and B
 - Sum of A and B
- Cephalic index is useful for the determination of:** *PGI 03; UP 08; DNB 10*
 - Age
 - Sex
 - Race
 - Sature
- A skull with squared orbit, broad nose and rectangular palate with cephalic index 75, probably the race is:** *PGI 04*
 - Negroes
 - Mongoloids
 - Europeans
 - None
- Cephalic index of 80-85 belongs to:** *JIPMER 08*
 - Mongolians
 - Indians
 - Europeans
 - Negroes
- Caucasian skull is:** *BHU 10*
 - Elongated
 - Square
 - Narrow
 - Round
- The cephalic index of Indian population is between:** *AI 04; TN 06*
 - 70-75
 - 75-80
 - 80-85
 - 85-90
- Barr body is NOT seen in:** *PGI 07; WB 08*
 - Turner syndrome
 - Klinefelter syndrome
 - Down's syndrome
 - Marfan's syndrome
- Barr body is found in the following phase of the cell cycle:** *AI 05*
 - Interphase
 - Metaphase
 - G1 phase
 - Telophase
- Barr body was first detected in:** *DNB 08*
 - Buccal mucosa
 - Brain
 - Liver
 - Skin
- Davidson body is used to determine:** *Delhi 03*
 - Age
 - Sex
 - Race
 - All
- Example of disorder of sex chromosomes is:** *AIIMS 06*
 - Marfan's syndrome
 - Testicular feminization syndrome
 - Klinefelter syndrome
 - Down's syndrome
- Streak ovaries are seen in:** *CMC (Vellore) 09*
 - Klinefelter syndrome
 - Turner syndrome
 - Down syndrome
 - Kallamann syndrome
- Klinefelter syndrome is associated with all, except:** *JIPMER 08; AFMC 12*
 - XXY
 - Male phenotype
 - Azoospermia
 - Barr body absent
- Klinefelter syndrome is:** *MP 07, 10; Maharashtra 09; Gujarat 10*
 - 45 XO
 - 46 XY
 - 45 XY
 - 47 XXY
- All are seen in Klinefelter syndrome, except:** *WB 07*
 - Mental retardation
 - Male phenotype
 - Azoospermia
 - Low FSH level

1. A 2. C 3. C 4. A 5. A 6. D 7. B 8. A 9. A 10. B
 11. B 12. C 13. B 14. D 15. D 16. D

17. Males who are sexually under developed with rudimentary testes and prostate glands, sparse pubic and facial hair, long arms and legs and large hands & feet are likely to have the chromosome complement of: *AI 04*
 A. 47 XYY B. 46 XY
 C. 47 XXY D. 45 XO
18. Most common cause of hyperthalamic hypogonadotropic failure in men: *AI 10*
 A. Klinefelter syndrome B. Noonan syndrome
 C. Viral orchitis D. Kallmann syndrome
19. False about Klinefelter's syndrome: *AP 08*
 A. Most common syndrome of sex gene involvement
 B. Most common cause of hypothalamic hypogonadotropic failure in males
 C. Mental retardation may be seen
 D. Serum FSH levels are consistently high
20. Incidence of Turner syndrome: *Manipal 10*
 A. 1: 500 B. 1: 1000
 C. 1: 1500 D. 1: 2500
21. Karyotype of Turner syndrome is: *JIPMER 05*
 A. XO B. XX
 C. XXY D. XY
22. A 19 years old female with short stature, wide spaced nipples and primary amenorrhea. Most likely she has a karyotype of: *AI 03*
 A. 47 XX +18 B. 46 XXY
 C. 47 XXY D. 45 XO
23. Webbing of neck, short stature, increased carrying angle, low posterior hair line and short fourth metacarpal are characteristics of: *AI 04; PGI 04; AIIMS 09*
 A. Klinefelter syndrome
 B. Turner syndrome
 C. Cri-du-chat syndrome
 D. Noonan syndrome
24. All of the following about Turner syndrome are true, except: *MAHE 03, 09, 11; PGI 06; AP 08; UPSC 09, Bihar 11*
 A. Amenorrhea B. Mental retardation
 C. Short stature D. Coarctation of aorta
25. Patient with genotype XO will have following phenotype, except: *PGI 09; WB 09*
 A. Tall stature B. Broad chest
 C. Webbed neck D. Lymphedema
26. Most common cardiac anomaly in Turner syndrome: *CMC (Vellore) 07*
 A. Bifurcation of aorta B. Coarctation of aorta
 C. Aortic stenosis D. Bicuspid aortic valve
27. True hermaphroditism is when: *DNB 09*
 A. Testes or ovaries are absent
 B. Both ovaries and testes are present in one individual
 C. External genitalia of one sex and internally of opposite sex
 D. External sexual characters are present, testes and ovaries are abnormal
28. A girl presents with primary amenorrhea, grade V thelarche (mature breast), grade II pubarche (sparse growth of pubic hair) and no axillary hair. Likely diagnosis is: *FMGE 09; AIIMS 11*
 A. Testicular feminization
 B. Mullerian agenesis
 C. Turner syndrome
 D. Gonadal dysgenesis
29. True about testicular feminization are all, except: *PGI 03, 04*
 A. Testes present B. Female phenotype
 C. XY D. Uterus present
30. A baby girl presents with bilateral inguinal masses, thought to be hernias, but are found to be testes in the inguinal canals. Karyotype expected in the child: *AIIMS 04*
 A. 46 XX B. 46 XY
 C. 47 XXY D. 47 XYY
31. Most common effect of congenital adrenal hyperplasia: *Maharashtra 09*
 A. Female pseudohermaphroditism
 B. Male pseudohermaphroditism
 C. True hermaphroditism
 D. Gonadal dysgenesis
32. Most common cause of congenital adrenal hyperplasia: *UP 05; Maharashtra 10*
 A. 21-Hydroxylase deficiency
 B. 11-Hydroxylase deficiency
 C. 17- α -Hydroxylase deficiency
 D. 3- β -Hydroxy dehydrogenase deficiency
33. Commonest cause of female pseudohermaphroditism is: *WB 10*
 A. Virilizing ovarian tumor
 B. Ovarian dysgenesis
 C. Exogenous androgen
 D. Congenital adrenal hyperplasia
34. Krogman's formula is related to: *Orissa 11*
 A. Race B. Age
 C. Sex D. Stature
35. Most useful for sex determination is: *Kerala 08*
 A. Skull B. Femur
 C. Pelvis D. Tibia
36. All of the following are features of female pelvis which distinguish it from male pelvis, except: *PGI 05*
 A. Subpubic angle U shaped and obtuse
 B. Deep funnel shaped
 C. Wider greater sciatic notch
 D. Sacrum is short and wide

17. C	18. A	19. B	20. D	21. A	22. D	23. B	24. B	25. A	26. D
27. B	28. A	29. D	30. B	31. A	32. A	33. D	34. C	35. C	36. B

37. Differentiating feature of female pelvis is: *PGI 05*
 A. Subpubic angle V shaped
 B. Subpubic angle U shaped and obtuse
 C. Pre-auricular sulcus prominent
 D. Ischial tuberosity is inverted and obturator foramen is large and oval
38. Pre-auricular sulcus helps in determination of: *PGI 04*
 A. Age
 B. Sex
 C. Height
 D. Race
39. Corporobasal index is used to determine: *AI 08*
 A. Age
 B. Sex
 C. Race
 D. Stature
40. Chilitic line helps in determination of: *DNB 08*
 A. Race
 B. Sex
 C. Age
 D. Stature
41. Mineralization of the teeth begins at: *COMEDK 07*
 A. Crown and progresses towards root
 B. Root and progresses towards crown
 C. Simultaneously at root and crown
 D. Begins in the centre
42. All are true about permanent teeth, except: *MP 11*
 A. Ridge is present between neck and body
 B. Anterior teeth are inclined forward
 C. Roots of molars are larger
 D. They are ivory white in color
43. The first incisors to erupt in an infant: *UPSC 07*
 A. Lower central
 B. Lower lateral
 C. Upper central
 D. Upper lateral
44. In the upper jaw, primary teeth erupt earlier than those in the lower jaw, except: *Orissa 11*
 A. Lateral incisors
 B. Central incisors
 C. Canines
 D. Second molars
45. Primary dentition is complete by: *UPSC 08*
 A. 1.5 years
 B. 2.5 years
 C. 3.5 years
 D. 4.5 years
46. At 3 years, a child has: *TN 06*
 A. 12 teeth
 B. 20 teeth
 C. 24 teeth
 D. 28 teeth
47. The 1st permanent molar erupts between: *Karnataka 03*
 A. 8-10 years
 B. 6-7 years
 C. 11-12 years
 D. 12-14 years
48. First permanent tooth to arise: *AP 10; UPSC 11; Delhi 11*
 A. Incisor
 B. Canine
 C. Premolar
 D. Molar
49. Age of appearance of permanent lateral incisor: *WB 10*
 A. 5-6 years
 B. 6-7 years
 C. 8-9 years
 D. 9-10 years
50. The most frequent tooth to be impacted: *UPSC 07*
 A. Lower third molar
 B. Upper third molar
 C. Lower canine
 D. Upper premolar
51. The period of mixed dentition is between the age of: *UP 11*
 A. 2-9 years
 B. 6-11 years
 C. 12-14 years
 D. 16 years
52. Number of teeth at 7 years: *Gujarat 07*
 A. 20
 B. 24
 C. 26
 D. 28
53. False with regard to permanent teeth is: *TN 08*
 A. Molars erupt around 6 years
 B. Dentigerous cyst is common in canines
 C. There are 16 permanent teeth at the age of 10 years
 D. 3rd molars eruption is variable
54. Age of child with 20 permanent teeth and 4 temporary teeth is: *Kerala 08, 09; Punjab 10; UP 10*
 A. 9 years
 B. 10 years
 C. 11 years
 D. 14 years
55. Gustafson's method useful for determination of: *Manipal 06; Gujarat 10*
 A. Age
 B. Stature
 C. Race
 D. Sex
56. Gustafson's method is most useful for: *AP 07*
 A. 16 years
 B. 18 years
 C. 21 years
 D. > 25 years
57. All are included in Gustafson's method, except: *UP 05*
 A. Transparency of root
 B. Attrition
 C. Cementum apposition
 D. Primary dentition
58. The most reliable dental change used in Gustafson's method for age estimation is: *AI 03; Delhi 06; AIIMS 06; COMEDK 08*
 A. Attrition
 B. Cementum
 C. Secondary dentin deposition
 D. Transparency of root
59. All the primary ossification centres are appeared at fetal age of: *WB 11*
 A. 1 month
 B. 2 months
 C. 3 months
 D. 4 months
60. Number of ossification centres present at birth: *Punjab 08*
 A. 206
 B. 250
 C. 350
 D. 450
61. At the end of 1 year of age, the number of carpal bones seen in skiagram of the hand is: *COMEDK 08*
 A. Nil
 B. One
 C. Two
 D. Three

37. B & C	38. B	39. B	40. B	41. A	42. A	43. A	44. B	45. B	46. B
47. B	48. D	49. C	50. A	51. B	52. B	53. B	54. C	55. A	56. D
57. D	58. D	59. C	60. A	61. C					

Identification II

5

Anthropometry (Bertillon system)

The first scientific method of criminal identification, called anthropometry, is attributable to *Alphonse Bertillon* (1853-1914). He developed this system based on the principle that the measurements of various parts of the human body do not alter after adult age (21 years).¹ Anthropometry laid the foundation for the eventual acceptance of fingerprints as a scientific method for personal identification.

It includes:

- **Descriptive data:** Color of hair, eyes, complexion, shape of nose, ears and chin.
- **Body measurement:** Height, AP diameter of head and trunk, span of outstretched arms, length of middle finger, left little finger, left forearm, left foot, length and breadth of right ear and color of left iris. (11 such measurements)
- **Body marks,** such as moles, scars and tattoo marks.
- **Photographs** of front view and right profile of the head are also taken.

Dactylography (Dactyloscopy)

Dactylography (**dermatoglyphics, Galton system**)^{2,3} is the study of fingerprints as a method of identification. A fingerprint match is widely accepted as *most reliable evidence of identification*.⁴ This system was first used by *Sir William Herschel* in 1858. *Sir Francis Galton* systematized this method in 1892.

What are fingerprints?

- The fingers, palms of the hands, and soles of the feet of humans (and some other primates) bear friction ridge skin (Fig. 5.1). On the tip of the fingers, the friction ridge skin forms a number of basic patterns. Within each basic pattern are numerous possible variations.
- Dermal carvings or ridges appear first time from the 12th-16th week of IUL and their formation gets completed by 24th week, i.e. 6th month IUL and remain constant throughout embryonic life, birth and the life of the individual.
- The arrangement and distribution of the patterns are unique to an individual and no two hands resemble each other.

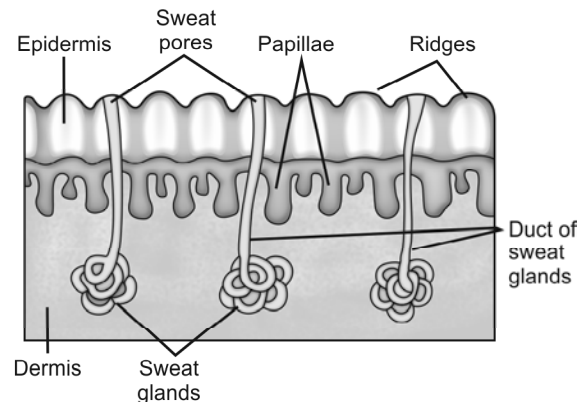

Fig. 5.1: Cross section of friction skin

- An individual's genetic makeup plays a part in determining the basic shapes of the patterns and ridges, but it is not the only factor as identical twins have identical genetic makeup, but distinguishably different fingerprints. The probability that two individuals will have the same conventional fingerprint is also about one in 1 billion.
- Fingerprints do not change throughout life, unless damage has occurred to the dermal skin layer. Permanent impairment of fingerprint pattern occurs in leprosy, electric injury and after exposure to radiation (injury should involve 1-2 mm beneath the skin surface).⁵

- Loss of fingerprints can happen in trauma, e.g. burn injury.
- Ridge atrophy with alteration of ridge pattern is seen in celiac disease, dermatitis, eczema, psoriasis, acanthosis nigricans, scleroderma, and dry and atrophic skin.
- **Dyskeratosis congenita** (*Zinsser-Engman-Cole syndrome*), a rare genetic condition characterized by triad of reticulated hyperpigmentation of the skin, nail dystrophy, and leukoplakia. They may have adermatoglyphia (loss of dermal ridges on fingers and toes).

Fingerprint Patterns

There are four basic ridge patterns as given in Table 5.1 (Fig. 5.2).

Table 5.1: Types of fingerprint ridges

S.No.	Type	Percentage (%)
1.	Loop ⁶ (Ulnar/radial)	60-70
2.	Whorl	30-35
3.	Arch	5-10
4.	Composite	2-3

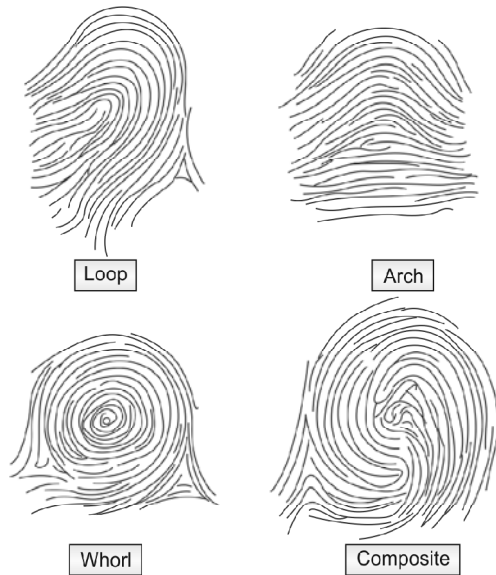

Fig. 5.2: Types of fingerprints

- Composite contains at least two different patterns, other than the basic arch. Sometimes, it is also referred to as 'accidental'.
- If a scar is formed, it will constitute a valuable addition to the identification process.

Recording of Fingerprints

Hands are washed, cleaned and dried to ensure clear prints. Print is taken using printer's ink on an unglazed white paper.

- Plain or dab impression** is obtained by gently pressing the inked surface of the tip of finger on paper.
 - Rolled impression** is taken by rolling the inked finger from side to side.
- In case of criminals, impressions of all the ten digits of both hands are taken.
 - It is customary and conventional to take the *left thumb impression of male* and *right thumb impression of female* in lieu of signature for illiterate person and on legal and other documents. The reason cited is that in earlier days, males being working class (and as most

people are right handed) may have some injury/scar in their right thumb.

- In dead body, if fingertips are dried up or shrivelled the prints can be taken after soaking the fingers in an alkaline solution (e.g. KOH). The surface of the fingers can be rounded out and smoothed by injecting glycerin, melted paraffin, hot water or air into the tissues.
- If the prints obtained by the above methods are not found decipherable, then the palmer skin of the terminal phalanx of each finger may be removed from both the hands and placed in a labeled bottle containing 10% formalin or a solution of glycerin and alcohol for preservation and transport to be the Fingerprint Bureau.
- In case of advanced putrefaction and in drowning, the skin may come out like a glove which can be preserved in formalin for the development of fingerprints.
- Prints can be obtained from the dermis if epidermis is lost, histological section upto a depth of 0.6 mm from finger pad surface can give satisfactory results.

Limitations of manual recording

- Impression not placed accurately in the designated space
- Uneven or excessive recording medium (e.g. ink)
- Pressure and twisting during recording may distort the print
- Presence of permanent or temporary scars

Types of Evidentiary Fingerprints

Three types of fingerprint may be encountered:

- Patent (visible) print** needs no processing to be clearly recognizable as a fingerprint. It is often made from grease, dark oil, dirt or blood, rendering it visible and recognizable and even suitable for comparison without additional processing.
- Plastic (impression/indentation) print** is a recognizable fingerprint indentation in a soft surface, such as butter, soap, cheese, paint, putty or tar. Such prints have a distinct three-dimensional character, immediately recognizable and require no further processing.
- Latent print** requires additional processing to be rendered visible and suitable for comparison. Processing of latent prints to render them visible and suitable for comparison is called development, enhancement, or visualization.

Development/Enhancement of Latent Prints

Latent prints are the most prominent example of **Locard's Principle of Exchange**: 'when two objects come into

contact with each other, there is always some transfer of material from one to the other'; hence, the great importance of visualizing them onto useful evidence.

Composition of latent print residue: Palmer and planter surface is completely free from hair and sebaceous glands, but there is profusion of sweat glands (called eccrines), the composition of which forms the basis for latent fingerprint residue; contamination by sebaceous secretions is also quite common from people touching their faces.

- The salts predominant in perspiration are sodium and potassium chlorides, with the organic fraction containing mainly amino acids, urea and lactic acid. Free fatty acids, triglycerides and wax esters prevail in sebaceous secretions.
- Fingerprints are stable compounds and unless they are exposed to extremes of heat or humidity and/or friction, they may persist indefinitely.
- Most methods for the development of latent prints were developed on the basis of knowledge about the latent print residue composition.

Fingerprint Development

A. **For non-porous surfaces**, e.g. glass, gloss-painted surfaces, metal and plastic.

- *Visual examination:* Oblique illumination may reveal latent fingerprints, particularly if the surface is smooth and clean.
- *Fluorescence examination:* High intensity light source or argon-ion laser or UV light may reveal latent fingerprints.

Development techniques

i. **Vacuum metal deposition (VMD):** VMD is most sensitive, being capable of detecting monolayer of fat by sequential deposition of a thin coating of thermally evaporated gold followed by zinc. It can develop fingerprints on surfaces that have previously been wet or even submerged in water for extended periods of time. If fingerprints are not revealed by VMD, superglue, powders or other techniques may be used subsequently.

ii. **Fingerprint powders:** Powdering is one of the oldest techniques for detecting fresh latent prints. It is widely used but insensitive. Many powders has been developed—microscopic flake like structure such as milled aluminum or brass, or molybdenum disulfide are more sensitive and effective at developing fingerprints on smooth, clean surfaces than the more traditional black or white powders. In case of contaminated surfaces, granular black

(chalk and mercury) or white powders (lead carbonate or French chalk) are more suitable. Rough or grained surfaces may be treated with iron, cobalt or nickel-based powders along with a magnetic applicator. There are many fluorescent powders which may also be used in conjunction with a suitable light source.

- iii. **Superglue fuming** can be used on any nonporous surfaces and is particularly useful on surfaces such as rough or grained plastic surfaces which cannot be easily treated using VMD. It is composed of methyl or ethyl cyanoacrylate which polymerize with latent prints.
- iv. **Small particle reagent (SPR):** SPR consists of a suspension of molybdenum disulfide suspended in aqueous detergent solution which is applied by spraying or immersion. The molybdenum disulfide particles adhere to fats deposited in the fingerprints, producing a gray-black image.
- v. **Iodine fuming** is one of the oldest and cheapest methods and can develop recent prints on porous and non-porous surfaces. Iodine fumes are absorbed by fingerprints to form a brown image which is photographed immediately.

B. **For porous surfaces**, e.g. paper, wall paper, cardboard and matt emulsion painted surfaces. The reagents used for these surfaces react either with amino acids, fats and lipids or chlorides absorbed into the surface.

- *Visual examination* is less likely to reveal fingerprints on porous surfaces.
- *Fluorescence examination* may sometimes detect fingerprints either by the rarely observed fluorescence of naturally occurring components or fluorescence of some contaminants.

Development techniques

i. **DFO (1,8-diaza-9-fluorenone):** It is the most sensitive reagent available for detecting fingerprint on porous surfaces. DFO reacts with amino acids deposited in the fingerprints to produce a faintly colored but intensely fluorescent compound which can be easily photographed. Since amino acids are soluble in water, DFO or ninhydrin cannot be used to treat porous surfaces which have been wet.

ii. **Ninhydrin** is a widely used chemical which reacts with amino acids and produces a deep blue or purple color known as *Ruhemann's purple*. It can be very effectively used at scenes of crime with the same formulation being brushed onto the surfaces.

- iii. **Powders:** Smooth papers may be treated with black or magnetic powder, although these will usually detect recent fingerprints.
- iv. **Superglue fuming** may be used on some smooth surfaces such as cigarette packets.
- v. **Physical developer:** It is the only available technique for detecting fingerprints on a wet porous surface. This reagent is an aqueous solution of silver nitrate containing a Fe II/III redox couple and two detergents. The developed fingerprints are gray-black in color and recorded using conventional photography.

Other methods for detecting latent prints

- **Radioactive sulfur dioxide:** Fabrics and adhesive tapes
- **Sudan black:** Surfaces contaminated by grease or foodstuffs
- **Osmium tetroxide:** Both porous and non-porous surfaces
- **Electronography:** Skin of living or dead bodies (uses high energy beam of X-rays to irradiate the lead dust on the suspected part)

Identification Protocol

- The unknown impression is examined, and all minutiae are analyzed and then compared to the known, to determine if a relationship exists.
- Weight is assigned in a comparison, not only to the number of minutiae in agreement, but also the rarity and clarity of those characteristics. Differences in appearance due to recording technique, pressure and other factors must be anticipated.
- The comparison can result in one of three possible conclusions: insufficient ridge detail to form a conclusion, exclusion or identification i.e. that they were made by the same finger.

Fingerprint Classification

- The modified Henry system followed in US is used for the classification of 10-print sets, or a fingerprint card, for one individual.
- The development of computerized fingerprint storage and retrieval systems has made searching larger files for single and partial prints routine. It has also rendered classification largely unnecessary.
- For quite a few decades, a 'minimum number of minutiae (points)' rule was followed. In practice, 12 points of fine comparison were accepted as proof of identity (suggested by Locard).
- Resolution in 1973 stated that no minimum number of features is required for making fingerprint identification. Most fingerprint examiners in most countries subscribe to this principle.

Medico-legal Application

- i. Identification of criminals whose fingerprints were found at scene.
- ii. Identification of fugitive through fingerprint comparison.
- iii. Exchange of criminal identifying information with identification bureau of foreign countries in cases of mutual interest.
- iv. Identification of unknown deceased person, persons suffering from amnesia, missing persons and unconscious patient.
- v. Identification in disaster work.
- vi. Identification in case of accidental exchange of newborn infants.
- vii. Identification of licensing procedure for automobile, firearm, aircrafts, etc.
- viii. Problems of mistaken identity and detection of bank forgeries.

- Sir Francis Galton published his book in 1892, '*Finger Prints*' and is regarded as a classic work.
- Juan Vucetich might be considered the Western Hemisphere's fingerprint pioneer.
- The first 'Fingerprint Bureau' in the world was officially established in Kolkata on 12th June 1897 at Writers' Building.⁷
- Sir Edward Henry devised a fingerprint-classification system that was adopted in British India. He presented it in UK in 1899.
- **Automated Fingerprint Identification System (AFIS)** is a storage, search, retrieval and exchange system for finger and palm print electronic images and demographic data (biometric data). AFIS utilizes specialized computer software configurations to create unique algorithms based upon relationships between the characteristics present within the finger or palm friction ridge. To match a print, a fingerprint technician scans the print in question, and computer algorithms are utilized to mark all minutia points, cores and deltas detected on the print. This enables a fingerprint to be compared with millions of file prints within a matter of seconds.

Poroscopy

- It is the further study of fingerprints, described by *Locard*.
- Ridges on fingers and hands are studded with microscopic pores formed by mouths of ducts of subepidermal sweat glands. Each millimeter of ridge contains 9-18 pores. There are about 550-950 sweat pores per square centimeter in finger ridges, and less (400) in the palms and soles (Fig. 5.3).

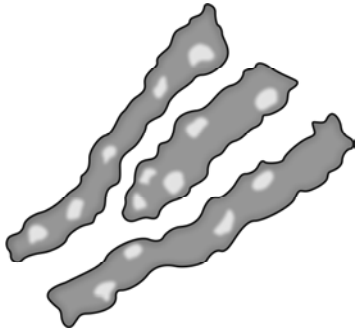

Fig. 5.3: Sweat pores as they appear on ridges

- The method of examining these pores is called poroscopy and is useful when only fragments of fingerprints are available.

Footprints: Skin patterns of toes and heels are as distinct and permanent as those of fingers. Footprints of newborn infants are used in maternity hospitals to prevent exchange or substitution of infants. Records are also kept for air force flying personnel.

Lip prints (Cheiloscopy)

- The study of lip prints is called cheiloscopy.⁸
- It is said that a person's lip prints are unique.
- Lip prints are revealed at the point of direct, physical contact of the perpetrator's lips with an object at the scene of crime, e.g. cutlery and crockery items particularly if a meal was eaten or the surface of windows, plastic bags and cigarette ends.
- Suzuki has divided lip prints into five main types (Fig. 5.4). Type I represents grooves running vertically over the lips. Type II has partial length grooves of Type I variety. They do not cover the entire breadth of the lips. Type III represents the branched grooves and Type IV represents the intersected grooves. Type V represents the reticular pattern, much like a wire mesh. Type V represents all other patterns. These are irregular non-classified patterns.

Enhancement and Utilization of Lip prints

- Techniques used in fingerprinting are useful for the purpose—easiest method makes use of fingerprint powders and fixing on foil.
- Aquaprint and cyanoacrylamide may be also applied.
- For classification, the middle part of the lower lip, 10 mm wide is taken which is almost always visible in the trace.
- It is useful for personal identification.
- The use of lip prints in criminal cases is limited because the credibility of lip prints has not been firmly established in our courts.

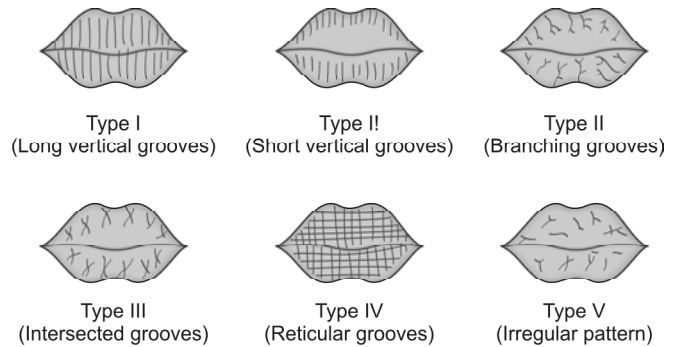

Fig. 5.4: Types of lip prints

Hair

Examination of hair (*trichology*) can provide crime investigators with important clues. Apart from burning, hair is virtually indestructible. It remains identifiable even on bodies in an advanced state of decomposition or attached to the weapon of offence after a crime has been committed. When a sample of hair is submitted for examination, the following questions need to be answered.

Medico-legal Questions

Q. Is it hair or some other fibre?

Hair consists of bulb or root, shaft and a tip.

Root is the portion of hair at the base of skin. It has a base known as bulb, embedded inside the hair follicle. *Shaft* is the portion of hair lying above the skin and tapers to terminate at the free end as tip.

It is divided into three zones (Figs 5.5 and 5.6):

- Cuticle:** Outermost layer, consists of thin non-pigmented microscopic scales.
- Cortex:** Middle layer, consists of longitudinally arranged elongated cells. Within these cells are fibrils on which there may be granules of pigment. It has keratin that is responsible for the charring and acrid odor when the hair is burned.
- Medulla:** Innermost layer, composed of keratinized remains of cells.

These three zones are also seen in the root or bulb, but the tip is usually non-medullated.

Fibres

- Fibres can be classified into two groups: natural and artificial (manmade).
 - Natural fibres* are subdivided into 3 classes: animal (e.g. silk, wool and hair), vegetable (e.g. cotton, jute and coir) and mineral (e.g. asbestos).
 - Artificial fibres* are subdivided into synthetic-polymer, natural-polymer and other fibres.

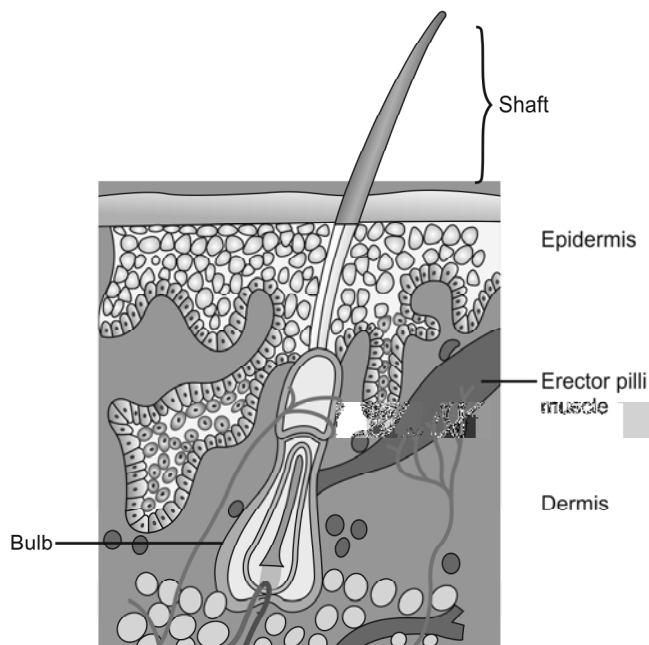

Fig. 5.5: Parts of hair

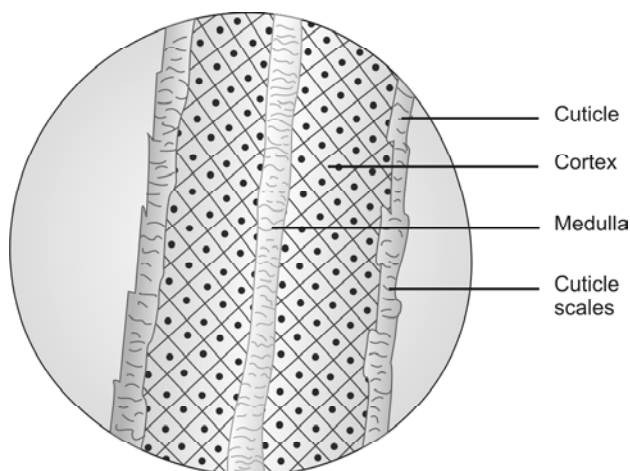

Fig. 5.6: Longitudinal section of human hair

- All animal fibres except silk can be considered as hair fibres.
- Most natural fibres have distinctive appearances that can be detected under the comparison microscope (Table 5.2).
- Synthetic fibre that cannot easily be identified with the microscope can be subjected to infrared spectrophotometry.

Q. Is it human or animal hair?

Difference between human and animal hair is given in Diff. 5.1 (Figs 5.7 and 5.8).

Table 5.2: Microscopic features of different fibres

Fibre	Features
Cotton	Flattened and twisted tubes consisting of long tubular cells with thickened edges and blunt pointed ends.
Silk	Consists of long clear threads without any cells. They have smooth surface and are finely striated.
Wool	Being an animal hair, it shows an outer layer of flattened cells (re-used wool may have lost their surface scales in the processing) and overlapping margins. Interior is composed of fibrous tissue, but sometimes medulla is present.

The medullary index (MI) is defined as the ratio of the diameter of the medulla to the diameter of the cortex.

$$MI = \frac{\text{Diameter of medulla}}{\text{Diameter of cortex}}$$

Q. What could be the racial profile of the person?

- Important differences are given in Diff. 5.2.
- These features become somewhat less useful for identifying people of mixed ancestry.

Q. From what part of body is the hair originated? (Fig. 5.9)

- *Scalp hair*: Long, soft, taper from root to tip, split ends and circular on cross section.
- *Beard and moustache*: Thicker, straight, blunted tip and triangular on cross section.
- *Axillary and pubic hair*: Stout, short, lack of uniformity and curly with frayed or split ends.
- *Eye-brow, eyelashes and nostril hair*: Short and stiff, thick, tapering abruptly and triangular on cross section.
- *Body hair*: Soft, fine and flexible, lack of uniformity of medulla, milder pigmentation and narrow tip.

Q. Is it male or female hair?

- Beard and moustache are specific for males. Male hair is usually thicker, coarser and darker as compared to females.
- Barr bodies can be detected in the hair follicles in about 20-80% of females and only about 0-4% of the males.
- Sexing can be done if root sheath is present, using DNA analysis.

Q. What could be the age of the person?

Whether the hair is that of an infant or adult can be said.

- Lanugo hair of the newborn are fine, downy, soft, non-pigmented, non-medullated, and cuticular scales have smooth edges.

Differentiation 5.1: Human and animal hair

S.No.	Feature	Human hair	Animal hair
1.	External	Delicate, fine and thin	Coarse and thick
2.	Color	Black, gray, reddish or reddish brown	Any color, can have banded appearance
3.	Shaft diameter	50-150 μ	25 μ or > 3000 μ
4.	Root	Bulb or ribbon shaped	Brush-like
5.	Tip	Cut or frayed (scalp hair)	Tapered
6.	Cuticular scales	Short, broad, thin and irregularly annular	Large and have step-like or wavy projections
7.	Cortex	Thick, well striated, 4-10 times as broad as medulla	Thin, rarely twice as broad as medulla
8.	Medulla ⁹	Narrow, may be continuous, interrupted, fragmented or even absent	Broad, continuous and always present
9.	Medullary index	< 1/3	> 1/3
10.	Pigment granules	Uniformly distributed	Mostly clumped near the medulla
11.	Precipitin test (with intact root)	Specific for human	Specific for animal

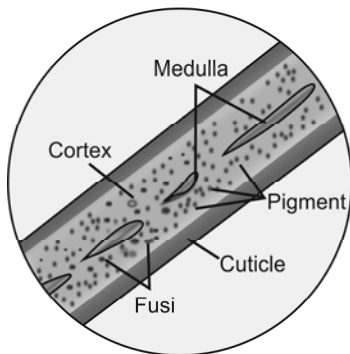

Fig. 5.7: Human hair

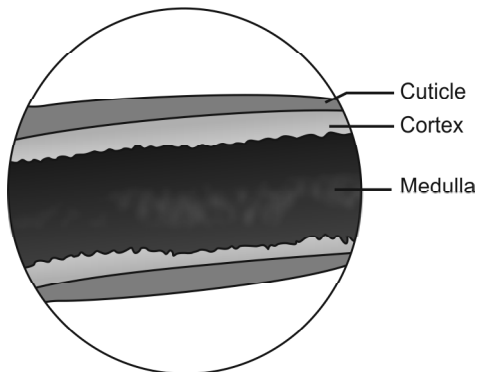

Fig. 5.8: Animal hair

- Adult hair are coarser, pigmented and medullated having a complex cuticular pattern.
- Gray hair are apparent after the age of 40 and are devoid of any pigment.

Age is based on examination of the following which tend to increase with age: medullary index, size of pigment granules, streakiness of pigment distribution, darkness of color, amount of cortical fusi and size of unpigmented area above the root.

Q. Has the hair being altered by dyeing, bleaching or diseased?

- Bleached or colored hair are dry, brittle, lusterless and rough.
- Abrupt color change to a very light color indicates bleaching.
- Color in cuticle indicates dyeing.
- Microscopical examination with incident fluorescence illumination may show whether hair is dyed or not.
- Curly appearance accompanied by constrictions in the shaft is indicative of permanent waving.
- Hair color is lighter in diseases, such as kwashiorkor, malnutrition and certain vitamin deficiencies.
- Tunneling of hair by fungal hyphae can produce distinctive transverse lines—seen in hair exposed to fungi and occur in buried bodies.

Differentiation 5.2: Ethnic differences in human hair

S.No.	Feature	Caucasians	Mongolians	Negroes
1.	Color	Light brown	Black or dark brown	Black or dark brown
2.	Consistency	Fine to medium	Coarse	Short, curly, finest
3.	Shape	Oval	Round	Flat
4.	Shaft diameter	Slight variation	Constant diameter	Wide variation
5.	Pigmentation	Uniform	Coarse granules	Irregular
6.	Cuticle	Thin	Thick	Medium
7.	Medulla	Fragmented or absent	Unbroken	Fragmented or absent

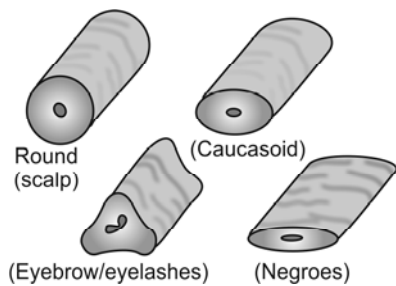
**Fig. 5.9:** Cross section of hair**Q. Is the hair identical with hair of the victim or the suspect?**

- Blood groups (ABO) can be determined from a single hair bulb.
- If some root structure is present, standard DNA profiling can be used.
- Even if the shaft is there, mitochondrial DNA testing can be tried.

Q. Did the hair fall naturally or was it forcibly removed? (Fig. 5.10)

- The bulb of naturally fallen hair is distorted, atrophied and the hair sheath is absent.
- In forcibly plucked hair, the hair sheath is ruptured, bulb is swollen, larger and irregular.
- If the root is not present, an even break with regular edges indicates that it was cut off and an irregular break indicates the hair was broken off.

Q. What is the cause of injury? (Fig. 5.11)

- In uncut hair, the tip is pointed and non-medullated.
- Sharp weapon produces a clean uniform cut surface.
- Blunt force injury result in flattening and splitting of hair shaft.
- Singed hair due to burns or firearm injury are swollen, fragile, curled, twisted and have a peculiar odor.

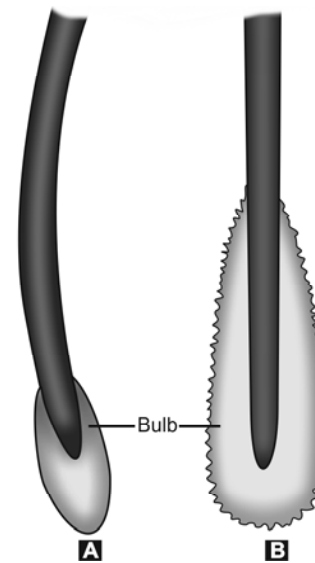
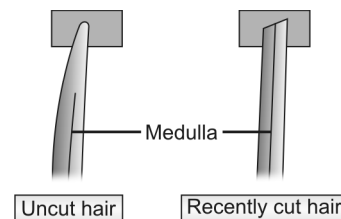
**Fig. 5.10:** (A) Root of a naturally fallen hair
(B) Healthy hair bulb (plucked)**Fig. 5.11:** Tip of hair

Postmortem root banding seen in people who are dead for some time, wherein an opaque band about 0.5 mm above the root bulb can be observed with transmitted light microscope.

Medico-legal Application**1. Identification**

- It is an important clue when similar hair may be detected on the alleged weapon and on the body of the assailant.

- ii. Victim's hair remains identifiable long after the commission of crime and provides valuable physical evidence.
 - iii. In rape and sodomy cases, pubic hair of the accused may be detected on the victim and vice versa.
 - iv. In bestiality, animal hair may be found around the genitalia, body and clothing of the accused.
 - v. In road traffic accidents, hair of the victim may be found adhered to the offending car.
2. **Nature of weapon:** Whether sharp or blunt can be opined.
 3. **Nature of assault:** Various trace evidence, like stains may be attached with hair, so it must be carefully looked for (Table 5.3).
 4. It helps in **differentiating burns from scalds**. Hair is brittle, singed or charred with large round vacuoles at the point of burning which is absent in scalds.
 5. Singeing of hair indicates **burns** or close range **firearm injury**.
 6. **Time since death** can be calculated from growth of scalp hair and beard (growth rate: 2.5 mm/week or 0.4 mm/day).
 7. **Age and sex** can be determined.
 8. **Poison** can be determined from hair, e.g. arsenic, thallium and lead.

Superimposition

- Technique applied to determine whether the recovered skull is that of the person in the photograph.
- Technologically, skull-photo superimposition have passed through three phases—the photographic, video and computer-assisted superimposition techniques.
- While performing photographic superimposition, the comparison photograph is enlarged to the size of the unknown skull and then the skull is positioned in the same orientation as the facial photograph.
- Recently, computer-assisted superimposition has become a popular method which digitize the skull and facial photograph using a video computer with

appropriate software and then to compare the two images morphologically by image processing.

- The complete skull is required to obtain positive identification. Without the mandible, it cannot be positively be identified as the presumed person, even if a good match is seen in skull-superimposition image.
- The coincidence of dentition between the skull and facial photograph (if incisors and canines are seen) could lead to positive identification.
- When evaluating anatomical consistency between the parts, special attention should be paid to their outline, the facial tissue thickness at various anthropometric points, and the positional relationships between skull and face-eyebrow to supraorbital margin, eye to orbit, nose to nasal aperture, lips to teeth and ear to external auditory meatus.
- If they are well matched with each other, it can only be stated that the skull could be that of the photographed person.
- Test is of a more negative value, because it can be *definitely be stated* that the skull and photograph are not those of the same person.

Forensic Odontology

Definition: It deals with the application of dentistry to aid in the administration of justice.

The work of a forensic odontologist includes:

- Identification of unknown bodies through dental records.
- Identification of bite marks on the victims of attack.
- Comparison of bite marks with the teeth of a suspect and presentation of this evidence in court as an expert witness.
- Identification of bite marks in other substances such as wood, leather and foodstuffs.
- Age estimation of skeletal remains.

Identification of Human Remains

Unidentified bodies due to violent crimes, road traffic accidents, natural and manmade disaster and in particular, the mass casualties normally associated with aviation disasters, drowning, burns, murder, suicide or dead from natural causes rely on dental evidence to positively identify the body.¹⁰

The central dogma of dental identification is that postmortem dental remains can be compared with dental records, including written notes, study casts, radiographs, etc. to confirm identity.¹⁰ Clearly, individuals with numerous and complex dental treatments are often easier to identify than those individuals with little or no restorative treatment.

Table 5.3: Stains attached on the hair

Type of stains	Suggestive information
• Seminal	Sexual offence
• Blood	Injury
• Salivary	Asphyxial deaths
• Mud	Struggle/road traffic accident
• Carbon particles	Burns/firearm injury
• Dyes	Concealment of natural color

Once the postmortem record is complete, a comparison between this and dental records can be carried out. A range of conclusions can be reached when reporting a dental identification.

Even if only a few teeth are available, one can still offer an age estimation, smoking habit, state of oral hygiene and identification of individual features which may match with antemortem records. Where the subject has no teeth, useful information can still be obtained from the study of any dentures and by X-ray of mouth and skull.

In problem cases, a variety of techniques are used to assist in the identification issue. These include:

- Incremental line and other histology studies (*Maples* noted that 2nd molar was best for histological ageing techniques)
- Scanning electron microscopy with/without energy-dispersive X-ray analysis
- Metal ratio analysis in bone and teeth, especially magnesium/zinc ratio
- Serology studies for blood groups, serum proteins and polymorphic enzymes
- DNA analyses

Bite Marks

Bites are commonly seen in cases of:

- i. *Sexual assault*: Marks are usually seen on breasts, neck, shoulders, thighs, abdomen, pubis or vulva.
- ii. *Child abuse*: Marks are seen anywhere on the body, such as arms, hands, shoulders, cheeks, buttocks and trunk.
- iii. Bite marks on foodstuffs (apples, cheese, chocolate), leather (key rings and belts) and wood (pencils) in cases where a perpetrator might have taken a bite out of something in the victim's home and left it behind.
- iv. Police officers may be bitten by the resisting offenders.
- v. In sporting events, like football, rugby or wrestling.
- vi. In assaults, where marks may be found anywhere on the body.

Nature of bite marks: Comprise of a crop of punctate hemorrhages varying from small petechiae to large ecchymoses merging into a confluent central bruise. Human bite is semicircular or crescentic caused by the front teeth (incisors and canines) with a gap on either side due to separation of upper and lower jaw whereas deep parabolic arch or U-shaped is characteristic of an animal bite. There may be abrasions, bruises and lacerations or a combination of all these.

- *Self-inflicted bite* marks are present on accessible parts of the body, e.g. shoulders or arms, usually seen in psychiatric patients or teenage girls.

- *Accidental marks* resulting from falls on to the face and during fits, biting of tongue and lips may also be there.
- *In sexual assault*, sucking action during bites reduces the air pressure in the centre and produces multiple petechial hemorrhages due to rupture of small capillaries and venules.

Identification from bite marks is possible, if incisors and canines have some characteristic features.

Bite mark investigation

1. *Photograph*: Bite mark is photographed from different angles.
2. *Swabbing of saliva*: To identify or exclude assailant from 'secretor' status who exude blood group substances in the saliva.
3. *Impression of bite mark*: Plastic substance (rubber or silicone based) or plaster of Paris is laid over the bite mark that hardens and produces permanent negative cast of the lesion.
4. Skin carrying the bite is removed and preserved in formalin during autopsy.

Dental Profiling

When dental records are unavailable and other methods of identification are not possible, the forensic dentist often produces a 'picture' of the general features of the individual known as *dental profiling*. It will typically provide information of the deceased's age, ancestral background, sex and socio-economic status. In some instances, it is possible to provide additional information regarding occupation, dietary habits, habitual behaviors and occasionally, on dental or systemic diseases.

- Microscopic examination of teeth can confirm sex by the presence or absence of Y-chromatin and DNA analysis can also reveal sex.
- Because of the resistant nature of dental tissues to environmental assaults, such as incineration, immersion, trauma, mutilation and decomposition, teeth represent an excellent source of DNA material. When conventional dental identification methods fail, this biological material can provide the necessary link to prove identity.

Charting of Teeth

On the charts following peculiarities are recorded:

- i. Any extractions, recent or old
- ii. Any fillings, number, position and composition
- iii. Artificial teeth, whether of gold, porcelain or stainless steel
- iv. Prosthetic work in mouth, such as bridge work or braces

- v. Any crowned teeth
- vi. Any broken teeth
- vii. Pathological conditions in teeth, jaws or gums
- viii. Congenital defects, such as enamel pearls, Carabelli's cusps or ectopic teeth
- ix. Malpositioned teeth that are rotated or tilted
- x. General state of hygiene, like caries, plaque, tobacco staining and gingivitis
- xi. Racial pointers, such as shovel shaped upper central incisors and multi-cusped molars.

Most widely used systems are:

- i. **Universal (Cunningham) system:** Follows the plan advocated by American and International Society of Forensic Odontology. The permanent teeth are numbered from 1 to 32 and lettering the deciduous teeth A to T, starting at the posterior upper right and continuing in a clockwise direction.

Right	1 2 3 4 5 6 7 8	9 10 11 12 13 14 15 16	Left
	32 31 30 29 27 27 26 25	24 23 22 21 20 18 18 17	

- ii. **Palmer's notation:** Palmer numbered the permanent teeth with Arabic numerals 1 to 8 from midline backwards.

Right	8 7 6 5 4 3 2 1	1 2 3 4 5 6 7 8	Left
	8 7 6 5 4 3 2 1	1 2 3 4 5 6 7 8	

- iii. **Haderup system:** It is similar to Palmer notation, except it uses a plus sign (+) to designate upper teeth and a minus sign (-) for lower. For the deciduous teeth, a zero was additionally placed in front of the number. This notation was adopted by the Scandinavian countries.

Right	8+ 7+ 6+ 5+ 4+ 3+ 2+ 1+ +1 +2 +3 +4 +5 +6 +7 +8	-1 -2 -3 -4 -5 -6 -7 -8	Left
	8- 7- 6- 5- 4- 3- 2- 1-	-1 -2 -3 -4 -5 -6 -7 -8	

- iv. **FDI (Federation Dentaire Internationale) - two-digit system:** A two-digit notation capable of indicating tooth and quadrant was developed. Thus, lower right canine will be numbered 43. This was adopted as the International Standard.

A. Permanent teeth
Upper

Right	18 17 16 15 14 13 12 11	21 22 23 24 25 26 27 28	Left
	48 47 46 45 44 43 42 41	31 32 33 34 35 36 37 38	

Lower

B. Deciduous teeth

Right	55 54 53 52 51	61 62 63 64 65	Left
	85 84 83 82 81	71 72 73 74 75	

- v. **Modified FDI system:** In this method, the tooth and quadrant are designated by a separate number. Right quadrant was designated by 2 and 3 and left was designated by 1 and 4 in permanent teeth.
- vi. **Diagrammatic or anatomical chart:** In this, each tooth is represented by a pictorial symbol that gives the same number of tooth surfaces as those on that particular tooth in mouth. Incisors and canines are represented by four surfaces premolars and molars by five.¹¹

Medico-legal Application

1. **Identification:** Dental identification is the most sophisticated method of comparative identification after dactylography. It is of not much use in developing countries, as dentists often do not keep records.
2. **Age estimation** of an individual.
3. **Grievous hurt:** Fracture/dislocation of tooth amounts to grievous hurt according to **Sec. 320 IPC**.
4. **Cause of death:** The teeth resist putrefaction and deposition of metals can be detected after considerable time after death, e.g. poisoning.
5. Dentures (partial or complete) are useful in identification, if they have the patient's name or code number in them.
6. Criminals can be identified through bite marks left either in human tissues or foodstuffs.

Miscellaneous Methods of Identification

Clothes and Personal Effects

They are helpful in establishing identity in case of mass disasters. It is necessary to preserve the clothes along with any articles, such as driving license, watch, spectacles, ornaments and wallet found on a dead body for the purpose of future identification. The clothes are examined for mark of the tailor, foreign material or any tear.

Occupational Marks

These are helpful in identifying unknown dead bodies, as certain occupation leave marks by which persons engaged in them may be identified, e.g. in clerks, a callosity on the proximal part of right middle finger may be seen where the pen usually rests or dyers/photographers may have their fingers stained with dyes or chemicals.

Handwriting

Opinion regarding the handwriting is usually given by the expert in this field and doctors are seldom

asked to testify. But, sometime the doctor may have to examine a person to whether he is able to write when a plea of paralysis or mental incapacity is put forward.

Speech, Voice, Ticks, Manner and Habit

Sometime, it is possible to identify a living person from certain peculiarities, like stammering, nasal twang and jerky movement of muscle of the face or shoulder.

Other methods of identification

1. **Palatoscopy/palato-print/rugoscopy:** It is the study of palatal rugae in order to establish identity. Rugae ('*plica palatine*') are anatomical fold or wrinkles formed by 12-14th week of IU life, the irregular fibrous connective tissue located on the anterior third of the palate, behind the incisive papilla.¹² Palatine rugae are unique and can be used for identification in circumstances when it is difficult to identify a dead person through dental records or fingerprints (even in advanced decomposition). This method of identification is useful, if antemortem record of palatal rugae is available.

This method is useful since:

- Rugae pattern remain stable throughout life and does not change during growth.
- It is protected from trauma due to its situation and from heat by buccal pad of fat and tongue.
- Even in twins, the pattern of rugae may be similar but not identical.

2. **Fronal sinus print:** It is unique to a particular individual and these are permanent and fixed (after 15 years of age) and rarely alter following infection or injury. For comparison, antemortem X-ray of skull taken on occipito-mental plane is compared with postmortem X-rays.

3. **Vascular grooves and sutural pattern:** The sutural pattern on the skull bone particularly of sagittal and lambdoid sutures are complex and are individualistic. Similarly, the vascular grooves over skull bone, particularly of middle meningeal vessels are individualistic. Rather, vascular grooves over skull are more helpful for identification as compared to suture lines, because these are well demonstrable in X-rays.
4. **Ear print:** It is the study of shapes of the ear lobules and tips of ears as well as the hardness or softness of the helix and lobules, and hairiness of the helix and tragus. These characters of the ears are considered to be individualistic.
5. **Nose print:** The lines on the nose and shape of the tip of nose are considered to be individualistic. Chance impressions may be found over door, wall and mirror at the scene of crime or even on the body of the victim or accused.
6. **Nail print:** It is the study of the depressions and elevations (striations), numbers, distribution and dimensions of the ridges on the surface of the nails which are considered to be individualistic. They remain unchanged throughout life and with advancement of age the striations become more prominent. The longitudinal striations are present over both convex and concave surfaces of finger and toe nails.
7. **EV method of identification:** The electrocardiogram (ECG or EKG) and vector cardiogram (VCG) trace expresses cardiac features that are unique to an individual. As a biometric, heartbeat data are difficult to disguise, reducing the likelihood of successfully applying falsified credentials into an authentication system.
8. **'Barium meal' X-ray of stomach:** It is also considered to be individualistic and may be helpful in identification, if previous record is available.

MULTIPLE CHOICE QUESTIONS

1. **A convict whose family or relations was not known and no biological sample was available with jail authorities, escaped from the jail. A dead body resembling the convict was found in nearby forest, but due to mutilation of face, identity could not be established. The positive identity that he is the same convict who escaped from jail can be established by:** AI 04
- A. Blood grouping B. DNA profile
C. Anthropometry D. HLA typing
2. **The system of identifying and utilizing fingerprints is called:** Delhi 05
- A. Galton system
B. Anthropology
C. Thanatology
D. Bertillon system
3. **Study of fingerprints is known as:** PGI 05
- A. DNA fingerprinting
B. Dactylography
C. Poroscopy
D. Cheiloscopy
4. **The most reliable method of identification of an individual is:** AI 05; PGI 05
- A. Dactylography B. Scars
C. Anthropometry D. Handwriting
5. **The fingerprint pattern may be impaired permanently in case of:** AIIMS 06; AI 09
- A. Eczema B. Scalds
C. Scabies D. Leprosy

6. **Most common pattern of fingerprint is:**
AI 05; Delhi 05, 07; Gujarat 07; UP 08; Manipal 10
 A. Arches B. Loops
 C. Whorls D. Composite
7. **Fingerprint Bureau was first established in:**
AI 06, AIIMS 08
 A. England
 B. China
 C. India
 D. Singapore
8. **Cheiloscopy is the study of prints of:**
AIIMS 04
 A. Foot B. Fingers
 C. Palate D. Lips
9. **In humans, cortex of hair is usually:**
Delhi 11
 A. Double that of medulla
 B. Same as medulla
 C. 4-10 times broader than the medulla
 D. Thin in comparison to medulla
10. **In a charred body, which of the following means is useful in its identification:**
Karnataka 03
 A. Stature
 B. Comparison of dental records
 C. Scar marks
 D. Skeletal features
11. **Dental numbering is done by all, except:**
AI 11
 A. FDI two digit system
 B. Anatomic and diagrammatic charting
 C. Palmer notation
 D. Universal system
12. **Palato-print is commonly taken from which part of palate:**
AIIMS 11
 A. Anterior part B. Lateral wall
 C. Medial wall D. Posterior part

Medico-legal Autopsy

6

Definitions

- **Forensic pathology** deals with the investigation of sudden, unexpected and/or violent deaths that includes determining the cause of death and the circumstances of how the death occurred.

- **Autopsy*** refers to the systematic examination of a dead person for medical, legal and/or scientific purposes.

It is of three types:

- i. **Academic:** Dissection carried by students of anatomy.
 - ii. **Pathological, hospital or clinical:** Done by pathologists to diagnose the cause of death or to confirm a diagnosis. Physicians cannot order these autopsies without the consent signed by the next of kin.
 - iii. **Medico-legal:** Type of scientific examination of a dead body carried out under the laws of the State for the protection of rights of citizens. The basic purpose of this autopsy is to establish the cause and manner of death.
- It is said '*the only thing worse than no autopsy is a partial autopsy*'. In every case, the autopsy must be complete, i.e. all the body cavities should be opened, and every organ must be examined. Partial autopsies have no place in forensic pathologic practice.
 - The autopsy should be carried out by the registered medical practitioner, preferably with training in forensic medicine. The doctor should remove the organs himself. The attendant should prepare the body and help the doctor where required, such as sawing the skull cap, reconstructing the body, etc. As the autopsy is proceeded with, details of the examination should be taken down verbatim by an assistant.
 - The person responsible for handling, moving and cleaning the body is often called a *diener* (German, servant).

- **Virtopsy** (combination of 'virtual' and 'autopsy') is a bloodless and minimally invasive procedure to examine a body for cause of death. It utilizes imaging techniques (CT and MRI), photogrammetry and 3-D optical measuring techniques to get a reliable, accurate geometric presentation of all findings (the body surface as well as the interior).
- **Psychological autopsy** is an investigative procedure of reconstructing a person's state of mind prior to death. This is based upon information gathered from personal documents, police and medical records and interviews with survivors of the deceased—families, friends and others who had contact with the person. The typical case is one which there is some doubt as to whether death was accidental, self-inflicted or malicious, and whether the deceased played an active role in his or her own demise. Such matters can be especially important in life insurance claims that are void if death was suicidal.

Purpose/Objectives of Autopsy

Who, when, where, why, how and what are the questions that the autopsy assists in answering. The objectives of medico-legal autopsy are:

- i. To determine the identity of the deceased in case of decomposed, burnt, mutilated or an unidentified body.
- ii. To determine the cause of death, whether natural or unnatural and to interpret the significance and effect of the disease present in case of natural death.
- iii. To find out the manner of death, whether accidental, suicidal or homicidal; and if homicide, whether any trace of evidence has been left by the accused on the victim.
- iv. To know the position of victim, sequence of injuries and to identify the poison or weapon responsible for death in homicide investigation.
- v. In case of fatal wounding, to determine the volitional activity possible after such trauma and survival time.
- vi. To determine approximate time of death, age of injuries and place of death.
- vii. In case of newborns, to determine the question of live birth and viability of the baby.

* Autopsy (Greek *autos*—self, *opsis*—view)—to see for oneself; also called necropsy (Greek *necros*—dead, *opsis*—view) or postmortem examination (post—after, mortem—death).

- viii. In case of mutilated or skeletal remains, to determine if they are human and if human, whether they belong to one or more than one person, the probable cause of death and approximate time since death.

Procedure for Medico-legal Autopsies

- i. **Authorization:** It should be conducted only when there is an official order authorizing the autopsy, from the police or Magistrate.
- ii. All registered medical practitioners in government service can conduct the examination. Autopsy is to be conducted by two doctors where death of a female has occurred within 7 years of marriage.
- iii. No unauthorized person should be present at the autopsy.
- iv. The medico-legal autopsy should be conducted in an authorized centre. The body should never be embalmed before autopsy.¹ It may be necessary to do an autopsy at the site, when the body is in an advanced state of putrefaction.
- v. Even if the body is decomposed, autopsy should be performed, as certain important lesions may still be found.
- vi. It should be performed as soon as possible after receiving the requisition, without undue delay. The requisition is accompanied with a copy of the inquest or the preliminary investigation report, a dead-body challan which includes the name, age, sex, identification marks and religion of the deceased, apparent cause of death and any other paper of importance. Before starting the autopsy, the doctor should go through the inquest report and the requisition thoroughly and put his signature on all the papers after marking them serially.
- vii. The autopsy should be conducted in daylight because color changes, such as jaundice, changes in bruises and postmortem staining cannot be appreciated in the artificial light.
- viii. Sometimes, if the body is received in the mortuary at night, it is preserved at 4°C after a preliminary examination is done to note external appearances, body temperature, extent of postmortem staining and rigor mortis.² The actual postmortem is conducted on the next day.
- ix. **Identification:** A police officer or any other authorized person and two relatives should identify the dead body, in front of the autopsy surgeon. The names of those who identify the body must be recorded. In unidentified bodies, the marks of identification, race, religion, sex, age, dental formula, photographs and fingerprints should be taken.

- x. Medico-legal autopsy does not require any consent from the relatives of the deceased.
- xi. Both positive and negative findings should be recorded.
- xii. Nothing should be erased and all alterations should be initialed in the report.
- xiii. **Chain of evidence:** It is absolutely essential to preserve the chain of evidence by identifying the body and maintaining absolute control of specimens removed at autopsy.
- xiv. **List of articles:** A list is made of all the articles removed from the body, e.g. clothes, jewelry, bullets, etc. They are labeled, sealed, mentioned in the report and handed over to the police constable after obtaining a receipt.
- xv. After completion of autopsy, the body is stitched, washed and restored to the best possible cosmetic appearance and then handed over to the police constable/IO.
- xvi. **Visit to the scene of crime:** If a visit to the scene of crime can be arranged, it is well worth undertaking in certain cases, such as murder, poisoning, traffic accidents, firearm injuries and sexual offences.

Chain of evidence/custody requires that from the moment the evidence is collected, every transfer of evidence from person to person be documented and be provable that nobody else could have accessed or tampered that evidence which can compromise the case of the prosecution.

Instruments for Autopsy Examination

A list of instruments useful in various standard and specialized postmortem procedures is given in Box 6.1.

External Examination

The observation and documentation of various external characteristics of the decedent is the essence of the external examination.

1. **Clothing:** They are listed and their number, labels and laundry marks, design, stains, tears, loss of buttons, cuts, holes or blackening from firearm discharges with their dimensions should be noted.
 - Trace evidence like hair, fibres, paint chips, glass fragments, vegetation and insect are collected, labeled and preserved.
 - Jewelry may provide evidence of identification, pockets may contain medication or drugs of abuse and personal papers may help in identification and provide medical history.
 - The clothes should be removed carefully without tearing them, to avoid confusion of signs of struggle.

Box 6.1: Instruments and equipment useful for postmortem examinations (Fig. 6.1)

- Scalpel and disposable blades of 22 size.
 - Toothed forceps: Teeth lend strength in gripping the skin and organs.
 - Rib cutters: Small pruning shears and are used to cut through the ribs prior to lifting off the chest plate.
 - Enterotome: Large scissors used for opening the intestines.
 - Scissors used for opening hollow organs and trimming off tissues.
 - Bone cutter: This is used to cut the ribs and has curved blades.
 - Councilman rib shear/cutter: Small pruning shears used to cut through the ribs prior to lifting off the sternum.
 - Vibrating saw (Stryker saw): Instrument of choice for most autopsy surgeons for removing the brain.
 - Bone saw: The hand saw can be used to saw through the skull, but it's very slow-going compared to the vibrating saw. Infections from aerosols being thrown up are other disadvantages.
 - Virchow skull breaker or chisel: After scoring the calvarium with the vibrating saw, the chisel is used to separate the top of the calvarium from the lower skull, thus exposing the brain and the meninges.
 - Hammer with hook is used with the chisel to separate the calvarium from the lower skull.
 - Brain knife: Long knife used to smoothly cut solid organs into slices for examination.
 - Hagedorn's needle is used for sewing up the body after autopsy.
- Other instruments that should be available: probe, small rule and plastic-coated measuring tape.

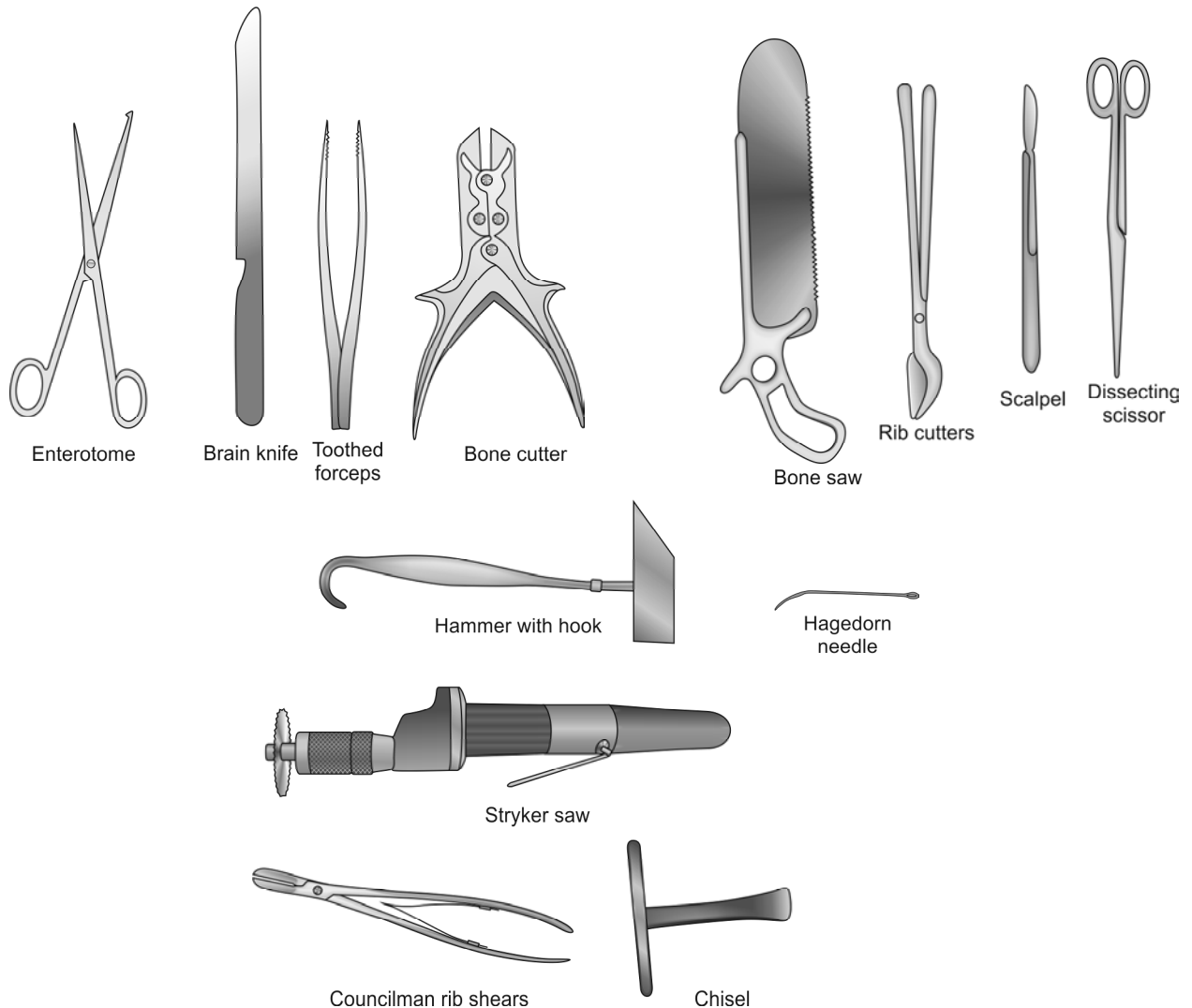
**Fig. 6.1: Autopsy instruments**

If they cannot be removed intact, they should be cut in an area away from any bullet hole or cuts, along the seam of the garment.

- After autopsy, wet clothing should be sun-dried, packed, sealed in paper bags and handed over to the police.
2. The whole surface of the body should be carefully examined before and after washing from head to foot, and back and front, and the details noted.
 3. Body length, weight, sex, race, head hair, eyes, dentition, general state, built, development and nourishment is noted. It should include all surgical procedures, dressings and other diagnostic and therapeutic measures.

Following should be noted in external examination:

1. **Skin:** General condition (rash, petechiae, color, looseness and turgor), asymmetry of any part of the body or muscular wasting. The presence of stains from blood, mud, vomit, feces, corrosive or other poisons, or gunpowder is noted.
2. **General description** includes deformities, scalp hair, beard, scars, tattoo marks, moles, pupils, skin disease, circumcision, amputations and vermilion mark.
3. **Signs of disease:** Edema of legs, dropsy, surgical emphysema about the chest, skin disease, eruptions.
4. **Time since death:** Rectal temperature, rigor mortis, postmortem staining, putrefaction, maggots, stomach contents, etc. are required to estimate time since death.
5. **Face:** Cyanosis, petechial hemorrhages, pallor, protrusion or biting of the tongue, state of lips, gums, teeth, marks of corrosion and injuries inside the lips and cheeks.
6. **Eyes:** Condition of the eyelids, conjunctivae, softening of the eyeball, color of sclera, state and color of pupils, contact lenses, petechiae, opacity of the cornea, lens and artificial eyes (which may contribute in road traffic accidents).
7. **Natural orifices,** i.e. nose, mouth, ears, urethra, vagina and anus should be observed for any discharges, injuries and foreign body. Leakage of blood or CSF from ears, mouth or nostrils is noted. Samples of discharges should be taken on swabs or smears prepared on slides.
8. **Neck:** Bruises, fingernail abrasions, ligature marks or any other abnormalities.
9. **Thorax:** Symmetry, general outline, injuries.
10. **Abdomen:** Presence or absence of distension or retraction, striae gravidarum.
11. **Back:** Bedsores, spinal deformity, injuries.
12. **External genitalia:** General development, edema, local infection, position of testes.
13. **Hands:** Injuries, defense wounds, electric marks, and in clenched hands, if anything is grasped.
14. **Fingernails:** Presence of tissue, blood, dust or other foreign matter, may be indicative of struggle.
15. **Limbs and other parts:** Fracture and dislocation.

External Injuries

The final stage of external examination is the documentation of injuries, either by grouping them according to injury type and anatomical location, or by numbering them, without implying an order of infliction or ranking of severity. Each injury is characterized by its:

- i. Type/nature of injury
 - ii. Size (length, breadth and depth)
 - iii. Shape
 - iv. Site (in relation to two external anatomical landmarks)
 - v. Direction of application of the force
 - vi. Margins, edges and base
 - vii. Distance of the wound from the heel
 - viii. Time of infliction of the injury should be studied from inflammatory and color changes
 - ix. Vital reaction
 - x. Collect foreign materials, e.g. hair, grass, fibres, etc.
 - xi. If the injuries are obscured by hair, it should be shaved
 - xii. Deep or penetrating wounds should not be probed until the body is opened
- In burns, their character, position, body surface area involved and degree should be mentioned.
 - Concealed punctured wounds, bruising of frenulum of lips and injection marks should be searched for, if indicated.
 - The use of printed body sketches is very useful. The position of the injuries should be pictographically depicted on the skeleton diagrams.
 - Photographic documentation of major injuries is now considered as standard practice. Identifying markers bearing the unique autopsy number, with a measurement scale should be included to ensure that the photos correspond to the specific case.

- Special procedures utilized during external examination include photography for the purposes of identification and documentation. Infrared and UV photography will enhance trace materials, tattoos, bruises and patterned injuries.
- High contrast black-white photography or computer directed image enhancement can be used to enhance patterned injuries.
- Radiological examination assists in identification, locating foreign objects such as projectiles and documenting old and recent bony injury.

Internal Examination

It is convenient to start the examination with the cavity chiefly affected. All three major cavities of the body, i.e. skull, thorax and abdomen should be opened and examined as a routine. The choice as to which part of body is to be opened first—skull or the body cavities is left to the dissector.

- In *suspected head injury*, open the skull first and then the thorax and the abdomen, but some authors are of the view that it should be opened after blood has been drained out by opening the heart.
- In *suspected asphyxial deaths* due to compression of neck, open the skull and abdomen first followed by dissection of the neck.³ The draining out of blood from neck vessels via the skull provides a comparatively cleaner field for the study of neck structures.
- In *all other cases*, the thorax and abdomen are opened first and then the skull.

Skin Incisions

Skin incisions are of three types (Fig. 6.2):

- I-shaped incision** extending from the chin straight down to the symphysis pubis and avoiding the umbilicus (because the dense fibrous tissue is difficult to penetrate with a needle, when the body is stitched after autopsy). *Most common method* followed.
- Y-shaped incision**: Straight line of Y corresponding to the xiphisternum to pubis incision and forks of Y runs down below the breasts and extending towards the acromion process. It is desirable in

those cases (especially females) where it is customary to keep a dressed body for viewing for sometime after death.

- Modified Y-shaped incision**: An incision is made in midline from suprasternal notch to symphysis pubis. The incision extends from suprasternal notch over the clavicle to its centre on both sides and then passes upwards over the neck behind the ears. It is used when a detailed study of neck organs is required, e.g. hanging or strangulation.

Evisceration Methods (Flow chart 6.1)

- En masse**: This method, described by *Letulle*, involves removing most of the internal organs in one full swoop. It is a rapid technique for removing the organs from the body although the ensuing dissection is the lengthiest. It has the advantage of leaving all attachments intact.
- Virchow's method**: This method of evisceration is simply removal of individual organs one by one with subsequent dissection of that isolated organ. It is useful in assessing individual organ pathology, a quick and effective method, if the pathological interest is in a single organ.
- En bloc removal**: It is a compromise between the above two methods and most widely used in UK. *Ghon* developed this method, which is relatively quick, but preserves most of the important inter-organ relationships.
- In situ dissection**: This method developed by *Rokitansky*, is rarely performed which involves dissecting the organs in situ with little actual

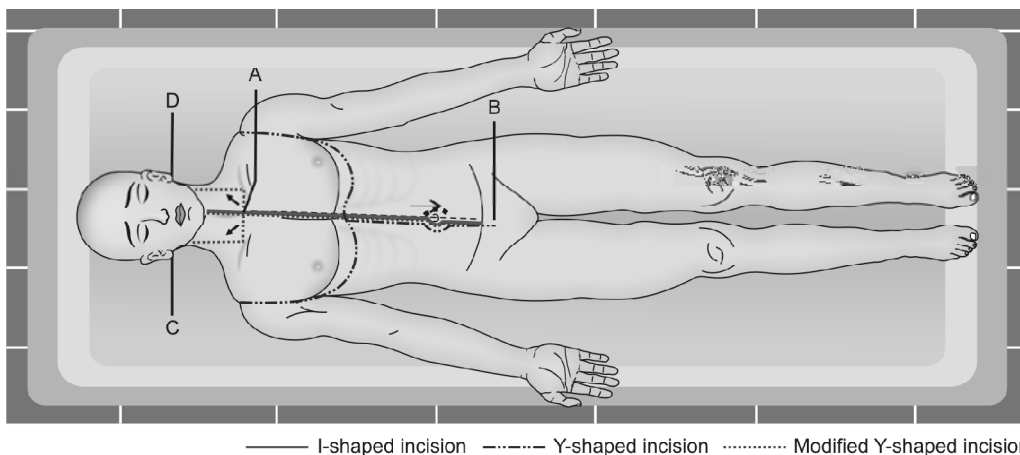
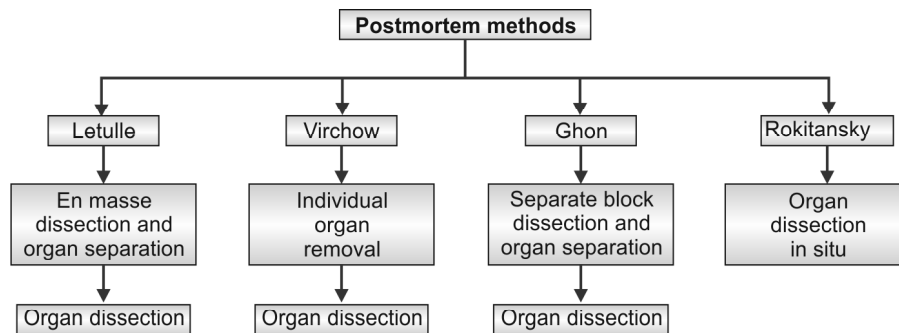

Fig. 6.2: Incision for opening thoracic and abdominal cavities (A) Sternal notch (B) Symphysis pubis (C) Right mastoid process (D) Left mastoid process (For color version see Plate 1)

Flow chart 6.1: Evisceration techniques



evisceration being performed prior to dissection. It may be the method of choice on patient with highly transmissible diseases.

No matter which dissection technique is utilized to eviscerate, the autopsy surgeon needs to perform a dissection specific to the organ in question.

- Hollow structures, such as blood vessels and GI tract (esophagus, stomach and intestines) is cut opened in order to reveal the pathology present inside.
- For solid organs, many parallel cuts, in a fashion similar to slicing a loaf of bread is done.

Wherever indicated, a small portion of each organ is preserved in formalin for histopathological examination.

Examination Proper

Abdomen and Pelvis

The rectus abdominis muscles are incised upto 5 cm above the symphysis pubis. A small nick is made in the fascia to admit the left index and middle fingers with palmar surfaces up, to protect the underlying structures, and the peritoneum is cut up to the xiphoid. In the abdominal cavity, presence of any blood, pus or fluid, perforation or damage to any organ is looked for. If blood, pus or any other fluid is present, its quantity is measured.

In penetrating wounds of the abdomen, gross injury to liver, kidneys, spleen and intra-abdominal vessels may be seen and there may be excessive intra-abdominal hemorrhage.

- Stomach:** Two ligatures are applied at the cardiac end of the esophagus and two ligatures below the pyloric end of the stomach. The stomach is removed by cutting between the double ligatures at both ends and it is opened along the greater curvature. The mucous membrane is examined for the presence of any stain, congestion, hemorrhage, desquamation, ulceration, sloughing or perforation. The content of the stomach is noted in respect to quantity, nature of material/food, state of digestion, color, and smell.
- Intestine:** It is dissected in its entire length. Any injury or reactions due to poison or presence of foreign body, e.g. a bullet, is noted. Ulcerative colitis like lesions is noticed in case of poisoning with mercuric chloride.
- Liver:** It is removed and its weight, size, color, consistency and presence of any pathology or injury is noted.
 - Normal liver weighs about 1300-1550 g in an adult.
 - Inflammatory or neoplastic processes often cause hepatomegaly, but fibrotic conditions such as cirrhosis will cause a shrunken organ.
 - For macroscopic examination of the liver, multiple transverse sections at 1-2 cm apart are given from one side to the other.
 - The gallbladder is dissected out along with the liver. Any pathology or stone formation inside it is noted.
- Spleen:** The spleen is removed by cutting through its pedicle; its size, weight, consistency, condition of capsule, rupture, injuries or disease is noted. Hilum should be inspected for splenunculi before dissecting the spleen.
 - Weight of normal spleen range from 130-170 g.
 - It is sectioned in its long axis, and the character of parenchyma, follicles and septa is noted.
 - In case of septicemia, the spleen will often be soft and liquefied and slicing may be impossible.
 - With normal spleen or with amyloid deposition or portal hypertension slicing will be easy.
- Pancreas:** The pancreas is removed along with the stomach and duodenum. It is sliced by multiple sections at right angles to the long axis to expose the ductal system.
- Kidneys:** They are removed along with adrenal glands after tying the ureters along with the vessels at least one inch away from the hilum.

- The surface of the kidneys along with the covering capsules should be examined for texture, congestion, hemorrhage and injury.
 - An adult kidney weighs about 150 g.
 - With chronic renal parenchymal disease such as nephrosclerosis, ischemia or infection there may be fine or coarse scars associated with capsular fibrosis.
 - The kidney is sectioned longitudinally through the convex border into the hilum. The pelvis is examined for calculi and inflammation.
 - *Renal infarcts* are pyramidal or wedge-shaped lesions with the base at the cortical surface and the apex pointing to the medullary origin of the arterial supply. Beginning as pale areas of necrosis with hyperemic borders, they progress to yellow-gray lesions that ultimately become depressed V-shaped gray-white furrows.
- vii. **Urinary bladder:** It is examined in situ. If bladder contains urine, it is syringed out before opening to avoid any chances of contamination by blood or any other material. The bladder should be examined for any pathology, hemorrhage, congestion or injury. Both the ureters should be opened along their long axes.
- viii. **Female genitalia:** The uterus and its appendages should first be examined in situ and then removed en masse along with the vagina by giving an incision externally on the labia upto the symphysis pubis above and the anus below. Internally, an incision is given around the pelvic brim and continued downwards to the pelvic outlet till it reaches the vaginal incision.

The **uterus** is examined and its dimensions, weight, whether gravid, parous or nulliparous or any pathology is noted. In case of gravid uterus, condition of the whole product of conception should be noted. In cases of abortion or attempted abortion, remains of any part of the product of conception inside the cavity, color of endometrial surface, erosion, any injury, ulceration or perforation of vaginal canal (particularly near the fornices) or of the uterine wall is noted. Foreign body may be present inside the uterine cavity. Smell and nature of the fluid present inside the uterine cavity is noted. Evidence of use of instruments may be present in the cervix or in the os.

The **vagina** is examined for any injury, foreign body, condition of hymen, mucous membrane and rugae. Any fluid present in the vagina is aspirated and preserved.

Ovaries should be examined for presence of corpus luteum. Fallopian tubes and ovaries have special medico-legal significance in cases of deaths due to their rupture in ectopic pregnancy.

- ix. **Prostate (in males):** It is examined for enlargement or malignancy. In prostatitis, it is firm and in carcinoma, it is hard and granular.

Chest

The skin and muscles of the chest are dissected sidewise and carried back to the midaxillary line, down to the costal margin and up over the clavicles. The ribs and sternum are examined for fractures, and the chest is opened by cutting the costal cartilages close to the costochondral junctions and starting from the upper border of the second cartilage with a cartilage knife. Then, disarticulation of the sternoclavicular joint is done on each side by inserting the point of knife into the semicircular joint.

The pleural cavity is examined before complete removal of the sternum. In situ inspection is done before removal of thoracic organs which includes observation of the atrium and ventricle for air embolism, distension or collapse of lungs, the chest cavity for fluid, hemorrhage or pus, pleural adhesions, injuries including fracture of ribs.

Lungs

Both the lungs are separated from the mediastinal structures after tying the vessels and the bronchioles.

- The condition of pleura, any sign of pleuritis, petechial hemorrhages, injury, effusion, hemothorax, pneumothorax, pyothorax is noted.
- Normal lungs weigh 250-400 g each in an adult, but may weigh > 1 kg in cases of severe cardiac failure or diffuse alveolar damage.
- It is conventional to cut open from large to small airways, from medial to lateral to include all lobes and segments opening along the branches as they are encountered. Impression of the parenchymal appearance and texture is noted and apical disease like old tuberculous cavities or fungal balls can also be demonstrated.
- The parenchyma is squeezed and any pus or fluid expressed is noted.
- After this, horizontal slicing through each lobe with a brain-knife is made to inspect the rest of the parenchyma.
- It is occasionally preferable to make large horizontal slices through the whole lung rather than opening

the airways and vessels in cases of large mass lesion (e.g. carcinoma).

Dissection of the vessels

The course of pulmonary veins into the lung is traced and thrombosis and atheroma is looked for, the latter being associated with pulmonary hypertension. An antemortem embolus may be coiled and when straightened resembles a cast of the vessel from which the thrombus originated, usually in the leg. Massive pulmonary emboli may block either the main trunk of the pulmonary artery or one of the major pulmonary vessels, more commonly on the right side.

- **Antemortem thrombus** firmly adheres to the lining endothelium, with a pale, granular and transversely ridged surface because of alternating layers of platelets and fibrin.
- **Postmortem thrombus** is weakly adherent to the lining endothelium, dark-red, glistening and friable. It is of two types:
 - i. *Black currant-jelly*: When blood clots rapidly, a soft, lumpy, uniformly dark-red, rubbery and moist clot is produced.
 - ii. *Chicken-fat*: When red cells sediment before blood coagulates, the red cells produce a clot similar to the first, but above this a pale or bright-yellow layer of serum and fibrin is seen.

Heart

- The heart is held at the apex, lifted upwards and separated from other thoracic organs by cutting the inferior and superior vena cava, pulmonary vessels, and ascending aorta as far away as possible from the base of the heart.
- The size and weight of the heart is noted. Adult heart weighs about 250-300 g. Hearts that weigh too much are at risk for sudden, lethal arrhythmias.
- Many approaches can be taken to dissect the heart. The appropriate method is selected on the basis of the age of the patient and any suspected abnormality.
- The overall anatomy of the heart needs to be evaluated for any congenital anomalies. The condition of the valves, presence and degree of atheroma in the valves and the intima of the large vessels is noted. Any ischemic lesion is searched for. The state of the myocardium, size of the chambers, thickness of right and left ventricle, state of endocardium (subendocardial hemorrhage in the left ventricle), valvular lesions, and condition of the aorta with

regards to any aneurysm, atherosclerosis, or syphilitic aortitis (*tree bark appearance*) is noted.

Examination of the Heart

Coronary artery disease is seen more commonly than valvular heart disease. The myocardium is examined for fibrosis or recent infarct. The myocardial infarct is easily identifiable when it is of more than 12 h of age. If an infarct is identified, sections from its central and peripheral zones are useful in dating the onset of ischemic damage and determining any recent extension.

Examination of coronary arteries (*in situ examination*)

The extramural coronary arteries are examined by making serial cross-sectional incisions about 3-5 mm apart, in order to evaluate for atherosclerotic narrowing, the common site being 1 cm away from the origin of the left coronary artery (Fig. 6.3). The narrowest segments and any areas containing thrombi should be selected for microscopic examination.

The anterior descending branch of the left coronary artery is cut downwards along the front of the septum, then the circumflex branch on the opposite side of the mitral valve. The right coronary artery is followed from the aorta to the cut near the pulmonary valve and then above the tricuspid valve. The presence of acute coronary lesions, viz. plaque rupture, plaque hemorrhage or thrombus is noted. The extent of coronary artery atherosclerosis is categorized based on the approximate percentage stenosis, caused by the plaque. Anything < 50% is considered mild, while 50-75% is considered moderate and > 75% is severe.

- Another method to examine the heart is the *inflow-outflow method* or following the direction of blood flow (Fig. 6.4). First, the right atrium is opened,

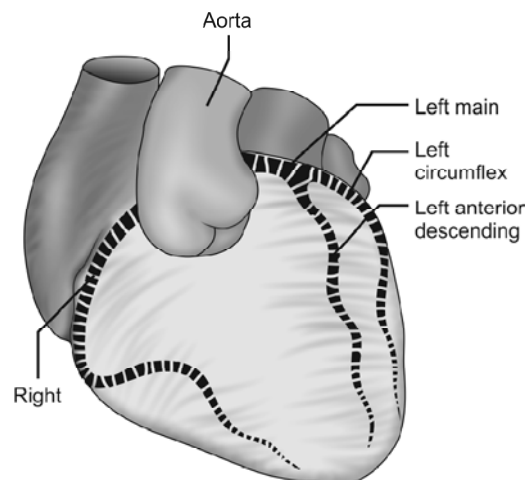

Fig. 6.3: Examination of coronary arteries

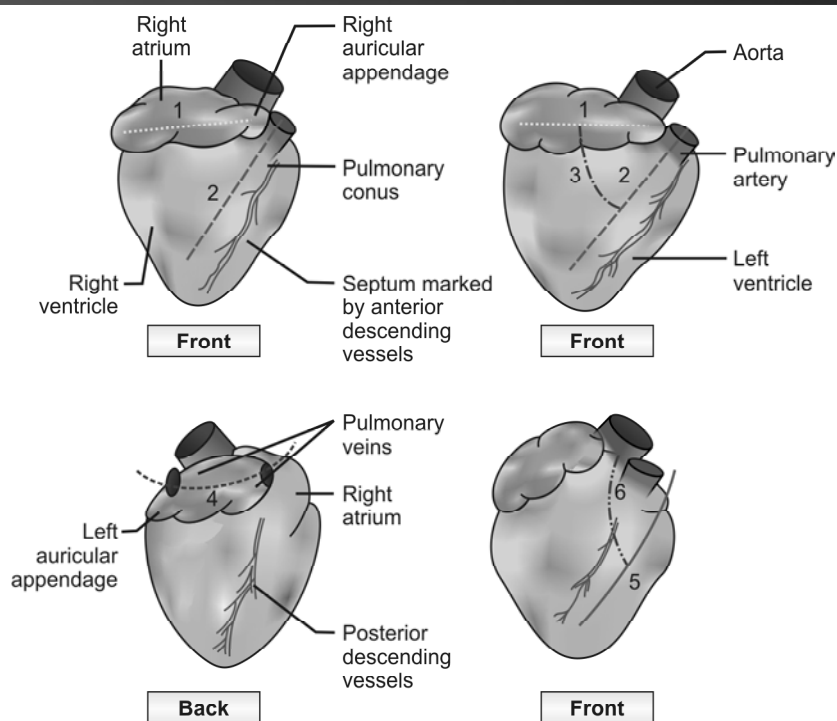

Fig. 6.4: Opening of the heart at autopsy (For color version see Plate 1)

Incision 1—Through right atrium

Incision 2—On the anterior wall of right ventricle parallel to interventricular septum

Incision 3—Through tricuspid valve

Incision 4—Through left atrium (after reversing the heart)

Incision 5—Through mitral valve, parallel to the septum (on anterior wall)

Incision 6—Through aortic valve

followed by the tricuspid valve, and then the pulmonic valve. Next, the left atrium is opened, followed by the mitral valve and the aortic valve. During opening, the valves should be examined before being cut and valve orifice measured. Special sections can be taken at this point to evaluate the conduction (electrical) system of the heart.

- Another lesser used method is the *short axis or ventricular slicing method* (Fig. 6.5). With the heart in the anatomical position, the first slice is made through the heart at a point about 3 cm from the apex separating it from the remainder of the heart. Further complete slices are then made in parallel to this slice, 1 cm apart, until reaching below the atrioventricular valves. The remainder is then examined by opening along the path of blood flow. It is useful if ischemic myocardial disease is suspected as it clearly

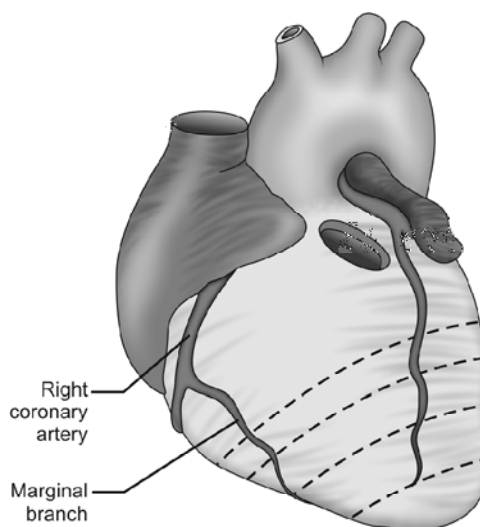

Fig. 6.5: Examination of myocardium

demonstrates the distribution of infarction. Examination of coronary arteries should precede the examination of heart.

- **Examination of valve:** The circumference of the valve is measured. The circumference of mitral valve is 8-10.5 cm (mean 10 cm) and admits two fingers; tricuspid valve is 10-12.5 cm (12 cm) and admits three fingers; aortic valve is 6-8 cm (7.5 cm) and pulmonary valve is 7-9 cm (8.5 cm). The decrease in circumference is suggestive of stenosis whereas increased circumference could be due to regurgitation or incompetent valves.
- **Ventricular hypertrophy:** An estimate is made by measuring the thickness of the ventricular walls at a point about 1 cm below the atrioventricular valve. The upper limits of normal are: left ventricle: 1.5 cm, right ventricle: 0.5 cm and atrial muscle: 0.2 cm.

Subendocardial Hemorrhages

These are flame-shaped, confluent hemorrhages and tend to occur in one continuous sheet rather than in patches, seen in the left ventricle, on the left side of the interventricular septum and on the opposing papillary muscles and adjacent columnae carnea.⁴

Subendocardial hemorrhages are seen in:

- Severe loss of blood or shock
- Intracranial damage, such as head injury, cerebral edema, surgical craniotomy or tumors
- Death due to ectopic pregnancy, ruptured uterus, abortion, antepartum or postpartum hemorrhage
- Poisoning, e.g. arsenic or oleander

Agonal thrombi: In case of a person dying slowly due to circulatory failure, a firm, stringy, tough, pale-yellow thrombus forms in the cavities, usually on the right side of the heart.

The *pericardium* is examined for presence of any pathology or injury. The content of the pericardial sac and its quantity is noted. Pericardial effusion, cardiac tamponade, subpericardial hemorrhage and constrictive pericarditis are looked for.

Neck

The neck structures are examined before removal of the thoracic organs so that the tongue, larynx, trachea and esophagus can be taken out along with the lungs. This helps in examination of the whole of the upper respiratory tract in its continuity (Details are given in Chapter 10).

In case of death due to alleged constriction of the neck, there may be fracture of hyoid bone or thyroid cartilage with extravasation of blood into the tissues

and injury to carotid arteries, sternomastoid muscles or platysma. Compression of the neck with hard materials may cause injury to the cervical vertebrae and the corresponding part of the spinal cord. Level and extent of other mechanical injuries on the neck are cautiously examined to know the type of injury and organs or structures injured resulting in death.

Skull and Brain

Procedure: A wooden block is placed under the shoulders so that the neck is extended and the head fixed by a headrest. A coronal incision is made in the scalp, which starts from one mastoid to the opposite mastoid process just behind the ear and is continued over the vertex of the scalp. The incision should penetrate upto the periosteum. The scalp is reflected forwards to the superciliary ridges and backwards to a point just below the occipital protuberance (Fig. 6.6A). Presence of hematoma, petechial hemorrhage, edema or depressed fracture is noted.

The temporal and masseter muscles are incised on either side, for sawing the skull. The saw-line is made in a slightly V-shaped direction (angle of 120°) so that the skull cap can fit back into the correct position on reconstruction of the body. Saw and remove the skull cap, the line of separation is just above the superciliary ridges in front, to the base of the mastoid process on either side and just above the occipital protuberance behind (Fig. 6.6B).

Dura: Examine the dura from outside for extradural hemorrhage (weight and volume is noted, if present) and superior sagittal sinus for antemortem thrombus. Cut the dura along the line of detached skull cap and pull it gently from front to back while cutting falx cerebri and examine for subdural and subarachnoid hemorrhage.

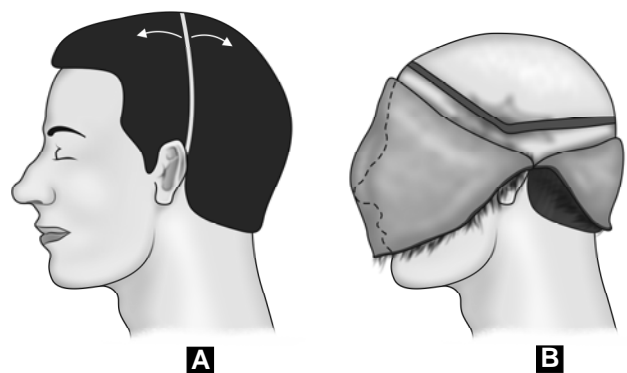

Fig. 6.6: (A) Incision for removal of scalp
(B) Saw-line for removal of skull cap

- The weight and volume of subdural hemorrhage, its effect on brain-flattening or any asymmetry is noted.
- Subdural hemorrhage can be washed under running water whereas subarachnoid hemorrhage cannot be washed.

Delivery of the Brain

Insert four fingers of the left hand between the frontal lobes and the skull. Draw them backward and then with the right hand, cut the nerves and vessels as they emerge from the skull. Cut the tentorium along the superior border of the petrous bone. Cut the cervical cord, first cervical nerves and vertebral arteries, as far below as possible. Support the brain throughout with the left hand. Remove the brain along with the cerebellum and brainstem which is supported by the right hand.

- Examine the remaining venous sinuses and the cranial cavity for antemortem thrombi. Remove the pituitary by chiseling the posterior clinoid processes and incising the diaphragm of the sella turcica around its periphery.
- Pull out the dura and examine the base of the skull and the rest of the cranial cavity for any fracture. Inspect the skull cap for fracture by holding it against the light.
- Remove a wedge shaped portion of the petrous temporal bone and examine the mastoid for any collection of pus, hemorrhage or fluid in the middle ear.

Examination of the Brain

The brain is weighed and then examined for any swelling, shrinkage or herniation, upper and lateral surfaces of the brain for asymmetry or flattening of the convolutions. The cerebral vessels, especially the circle of Willis is looked at for arteriosclerosis, embolism and aneurysms.

Berry aneurysms (size varies from few mm to few cm) are usually present at the junction of vessels especially at the junction of the posterior cerebral arteries, the posterior communicating vessels, and the middle cerebral arteries and the anterior communicating arteries. Look for cerebral infarction which may occur due to a thrombus or atheroma.

In most medico-legal autopsies, the brain is examined in the fresh state; however, in select cases, the autopsy surgeon may need the brain 'fixed' prior to further evaluation. Fixation is an extremely important step in the proper examination of the brain and spinal cord.

Fixation of the Brain

The best routine fixative is 10% formalin and requires 2-3 weeks for satisfactory fixation. In fetuses and infants,

the addition of acetic acid to the fixative solution increases the specific gravity of the fixative and allows the brain to float in the solution; it also makes the tissue firmer without altering its histological characteristics.

Dissection of the Brain

The most utilized and reliable method of brain sectioning is the *coronal cutting method*, whether examination occurs in the fresh state or after formalin fixation. It involves serially sectioning of all parts, including cerebrum, cerebellum, and brainstem.

First the cerebellum and brainstem should be separated from the cerebrum. This is done as high as possible and cut the surface in a horizontal plane with a large scalpel. The brainstem is then separated from the cerebellum at the cerebellar peduncles, as close to the brainstem as possible with a scalpel.

Cerebrum

The cerebrum is then sliced in a coronal plane at 1 cm intervals. If the brain is fresh, it is sliced from the frontal end and from the superior surface. The main aim with the fresh brain is to be as quick as possible, since the brain is so soft that it rapidly collapses.

With fixed brain, the first slice is done through the mammillary bodies (at the basal surface) which divide the brain into half in the exact coronal plane. Thereafter, each half is sliced 1 cm each, in turn, with the flat surface laid downwards. It should be done with a single sweep of a brain knife, to avoid a sawing motion and subsequent irregularities on the cut surface. These slices should then be laid out in order on a flat surface.

Other planes that can be used for special cases:

- Cutting the brain in the plane of CT-scans, for comparison with the radiology.
- Single, midline sagittal section, particularly useful if a third or fourth ventricle lesion is expected.

Features to look for:

- The cortical ribbon, white matter, basal ganglia and lateral ventricle should be examined for any asymmetry or brain shift that would indicate space occupying lesion—abscess, large hemorrhage, recent infarction or either metastatic or primary tumors.
- Old infarcts are cystic spaces which do not produce any brain shift.
- Small focal lesions may not cause any brain shift, e.g. small (lacunar) infarcts associated with hypertension and gray areas of demyelination (plaques) within the white matter.
- Dilatation of lateral ventricle may indicate atrophy.

- Shrinkage of cerebral cortex (gray matter) is common in chronic alcoholics.
- Cerebral fat emboli that have completely obstructed the small vessels of the brain may be visible to the naked eye as punctate hemorrhages in the white matter.
- Petechial hemorrhages in the white matter are commonly found in death from anaphylactic shock.
- In head injury, edema is seen in the white matter around or deep to contusions, lacerations or ischemic lesions. If there is any injury to the brain, successive sections parallel to the wounded surfaces should be made till the whole depth of the wound is revealed.

Cerebellum

The cerebellum is dissected on the horizontal plane with the two lobes being sliced in a 'fan' shape with the middle slice going through the dentate nucleus which gives best histological orientation of the structures.

Brainstem

The brainstem can be sliced at 5 mm intervals perpendicular to its axis and laid out in order on a flat surface.

In brainstem and cerebellum, any focal lesions must be identified, such as areas of hemorrhage, areas of softening or cystic degeneration that indicate recent or old infarction respectively, and primary or metastatic tumors.

Dissection of head in infants: *Rokitansky's method* or *Beneke's technique* is used to open the skull in infants (details in Chapter 20).

Spinal Cord

- The spinal cord can be removed from an anterior or posterior approach and usually removed separately from the brain.
- If there is no indication, the spinal cord need not be exposed.
- The *anterior approach* is more difficult but has the advantages of not requiring the body to be turned (messy procedure with evisceration already taken place) and allowing the nerve roots and dorsal ganglia to be dissected.
- The *posterior approach* is both quicker and easier, but best performed before the full postmortem, to avoid the mess. It also allows the spinal cord and the brain to be removed in continuity, but does not allow examination of the nerve roots and basal ganglia.⁵

The posterior approach is outlined below.

Posterior approach to the spinal cord

- A long midline incision is made and the skin, muscle and soft tissues are flapped out sidewise or laterally 1 inch on either side from the vertebral column.
- The posterior arch is cut with the vibrating saw. This dissection can extend superiorly along the cervical vertebrae to the foramen magnum.
- The spinal processes and posterior portions of the laminae are removed.
- The dura is opened longitudinally to the uppermost part of the incision, where it is cut circumferentially.
- The nerves are cut and the spinal cord is delivered by steady traction.

Description of an Organ

- **Size:** Measuring tape is used. A tense capsule indicates enlargement and loose capsule shrinkage.
- **Shape:** Note any deviation from normal.
- **Surface:** Most organs have a delicate, smooth, glistening and transparent capsule of serosa. Any thickening, roughening, dullness or opacity is noted.
- **Consistency:** The softness or firmness is appreciated by application of finger pressure.
- **Cohesion:** It is the strength within the tissue that holds an organ together. It is judged by the resistance of the cut surface to tearing, pressure or pulling.
- **Cut surface:** Note color and structural details.

After completion of autopsy, blood, fluid etc. are removed from the body cavities. The organs are replaced in the body and any excess space is packed with cotton or cloth, especially in the pelvis and the throat, where blood tends to leak. The dissected flaps are brought close together and sutured by using thin twine and large curved needle. The skull should be filled with remaining portion of the brain along with cotton or other absorbent material and the skull cap fitted in place. The scalp is pulled back over the vault and the scalp stitched with thin strong twine. The body is washed with water, dried and covered with clothes and then handed over to the police constable accompanying it.

Report

After completing the postmortem examination, a complete but concise report should be written in duplicate/triplicate using carbon papers. One copy is given to the investigating officer and another copy is retained for future reference (sometimes a third copy is made for

hospital purpose or for the chemical examiner). The report should contain a list of specimens and samples retained for further examination.

- The report should be given on the same day, as the details cannot be accurately recorded from memory, if there is too much of delay.
- If laboratory tests have to be carried out, a provisional report is given and later after obtaining the reports, a supplementary report is given. In suspected cases of poisoning, the opinion should be kept reserved until the Chemical Examiner's report is received. In such cases, viscera should be preserved and histological and bacteriological examinations may be carried out. The conclusion that death was caused by poison depends on evaluation of clinical, toxicological, circumstantial and/or autopsy evidence.
- A definite opinion should be given whenever possible, but if the cause of death cannot be ascertained, it should be mentioned in the report. While giving cause of death, the word '*probably*' should be avoided. It must be recognized that the determination of cause and manner of death are opinions, not facts. **The opinion of one autopsy surgeon can differ from another's.**
- If the cause of death is not found on autopsy, the opinion as to the cause of death should be given as '*undetermined*', and the manner of death as '*unknown*'.

Demonstration of Pneumothorax

Pneumothorax occurs when a leakage through the pleura allows air to enter the pleural cavity and the communication rapidly closes. It can be demonstrated by three ways during autopsy:

- i. The skin and subcutaneous tissues are reflected from the chest wall till the mid-axillary line, being careful not to open the pleural cavity. Care should be taken not to puncture the intercostal soft tissue and penetrate the pleural space, as this releases air from an underlying pneumothorax. Water is poured into the angle between subcutaneous tissue and the chest wall, and the intercostal tissues below the water line are pierced with a blade. If pneumothorax is present, bubbles of air will be seen rising through the water.
- ii. Another method is possible before any incision is made. This involves introducing a wide bore needle attached to a 50 ml syringe into the subcutaneous tissue over an intercostal space into the pleural space. The plunger should be removed previously

and the syringe filled with water. The water is observed for the presence of any bubbles. A similar procedure is then followed on the other side.

- iii. A third method involves postmortem chest X-ray and assessment in a manner similar to detection of a pneumothorax in the living patient.

Demonstration of Air Embolus

For venous air embolus, a plane chest X-ray before evisceration to demonstrate the pathology may be done. Examination of the retina should be performed with an ophthalmoscope for intravascular bubbles.

During dissection of the neck, the large neck veins should be carefully exposed, but not opened before the heart is dissected in situ, to avoid the confusion of air introduction during evisceration. The abdomen is opened in the usual manner and the contents are moved to inspect the inferior vena cava for bubbles in the lumen through its transparent wall. There are three methods to demonstrate *venous air embolus*:

- i. The sternum is removed by dividing the ribs, being careful not to puncture the pericardial sac, and cutting through the sternum distal to the sternoclavicular joint. The internal mammary vessels should be clamped. The anterior pericardial sac is opened and the external epicardial veins inspected for evidence of intraluminal bubbles. Water is introduced to fill the pericardial space. Once completely covered in water, the right atrium and ventricle are incised and careful inspection is made to identify any air bubbles which may escape.⁶
- ii. Another method is by inserting a water-filled syringe (minus plunger) connected to a needle into the right ventricle, the syringe chamber observed for the presence of bubbles.
- iii. **Pyrogallol test:** A 2% pyrogallol solution mixed with sodium hydroxide is taken in a syringe. Gas is then aspirated from the right side of the heart and then shaken. The mixture will turn brown, if air is present. In the absence of air, the solution stays clear (indicating gas production by bacteria).

Arterial air emboli are unusual and usually result from traumatic injury involving the pulmonary veins or following introduction of air during cardiopulmonary bypass. Smaller volume of air is associated with such emboli and as such more difficult to demonstrate.

Systemic emboli may be verified by inspecting the intracranial vessels of the meninges and circle of Willis

and then examining underwater after clamping the internal carotid and basilar arteries.

Collection of Samples

- i. **Blood:** The cellular barrier of mucous and serous membranes breaks down after death, due to which substances (e.g. alcohol and barbiturates) in the stomach and intestine can migrate to the organs in the thorax and abdomen leading to erroneous results. Before autopsy, 10-20 ml of blood can be drawn from the femoral (*best sample*), jugular or subclavian vein by a syringe. Blood should never be collected from the pleural or the abdominal cavities, as it can be contaminated with gastric or intestinal contents, lymph, mucus, urine, pus or serous fluid.
- ii. **CSF:** It is collected by lumbar puncture or from the cisterna magna by inserting a long needle between the atlanto-occipital membrane. Direct aspiration of CSF can be done from the lateral ventricles or third ventricle after removal of the brain.
- iii. **Vitreous humor:** A fine hypodermic needle (20 gauge) attached to a syringe is inserted through the outer canthus into the posterior chamber of the eye, after pulling the eyelid aside, followed by aspiration of 1-2 ml of crystal clear colorless fluid from each eye. Water/saline is re-introduced through the needle to restore the tension in the globe for cosmetic reasons.
- iv. **Lungs:** In solvent abuse ('glue sniffing') and death from gaseous or volatile substances, the lung is mobilized and the main bronchus tied off tightly with a ligature. The hilum is then divided and the lung is put into a nylon bag immediately and the bag is then sealed. Plastic (polythene) bags are not suitable, as they are permeable to volatile substances.
- v. **Urine:** It can be collected in a suitable sterile or non-sterile 'universal container' for either microbiological or toxicological analysis by suprapubic puncture or when the bladder is opened. Before dissection, urine can be collected via catheter or abdominal wall puncture.
- vi. **Bone:** About 200 g is collected. It is convenient to remove about 10-15 cm of the shaft of the femur.
- vii. **Hair:** An adequate sample of head and pubic hair should be removed by plucking along with roots, and not by cutting, and preserved in separate containers (0.5 g for DNA analysis, upto 10 g for analysis of heavy metals).

- viii. **Maggots:** These are dropped alive into boiling absolute alcohol or 10% hot formalin which kills them in an extended condition (to disclose the internal structure of the larvae). If time of death is an issue, some larvae/maggots should be preserved alive for examination by an entomologist. Maggots may reveal the presence of drugs/poisons in decomposed bodies.
- ix. **Nails:** All the nails (fingers and/or toes) should be removed in their entirety and collected in separate envelopes.
- x. **Skin:** If there is needle puncture, the whole needle track and surrounding tissue should be excised. Control specimens should be taken from some other area on the opposite side of the body and preserved in a separate container. In firearm cases, a portion of skin around the entrance and exit wounds should be preserved.

- **Fibroblasts for tissue culture:** Karyotyping, metabolic assays, enzyme assays and diagnostic ultrastructural studies can be performed on cultured fibroblasts. Skin, fascia, lung, diaphragm, muscle and cartilage are useful for fibroblast cell cultures.
- **Tissue for metabolic studies and nucleic acid analysis:** Liver, kidney, cardiac and skeletal muscle, and peripheral nerve obtained at autopsy may be used for biochemical studies in the diagnosis of inborn errors of metabolism. The tissue should be frozen rapidly in liquid nitrogen or dry ice and stored at -70°C .

Preservation of Viscera

Viscera should be preserved in cases of:

- Suspected death due to poisoning
- Deceased was intoxicated or used to drugs
- Cause of death could not be found after autopsy
- Accidental death involving driver of a vehicle or machine operator
- Death due to burns (if needed)
- Advanced decomposition*
- Any case, if requested by the Magistrate

Specimens that must be preserved in cases of suspected poisoning are given in Tables 6.1 to 6.3.

Table 6.1: Samples preserved in living persons

Material	Quantity
Vomit	300 ml (whole, if quantity is less)
Stomach washout	500 ml
Blood	10 ml
Urine	100 ml

* When the body is too decomposed to collect any fluids, collect atleast 100 g of muscle from thigh, liver, brain, fat and kidneys

Table 6.2: Viscera preserved during autopsy (routine)

S.No.	Material	Quantity
1.	Stomach and its contents	Whole
2.	Upper part of small intestine and its contents	About 15-30 cm length (some say 100 cm)
3.	Liver (along with gallbladder)	300-500 g
4.	Kidney	Longitudinal half of each kidney
5.	Spleen	Whole
6.	Blood	10 ml
7.	Urine	100 ml

Table 6.3: Additional viscera and materials required in certain cases

S.No.	Material	Poisoning/circumstances suspected
1.	Heart	Strychnine, digitalis
2.	Brain ^{7,8}	Alkaloids, organophosphorus, opiates, strychnine, carbon monoxide, cyanide, barbiturates and volatile organic poisons; hydrophobia/rabies (for negri bodies)
3.	Spinal cord ⁹	Strychnine
4.	CSF ¹⁰	Alcohol
5.	Vitreous humor ¹¹	Alcohol, chloroform
6.	Lung ¹²	Gaseous poisons, hydrocyanic acid, alcohol, chloroform
7.	Skin	Injected poisons (insulin, morphine, heroin, cocaine and other illicit drugs), firearm injuries
8.	Bone, hair and nails	Heavy metals (arsenic, antimony, thallium)
9.	Fatty tissue	Pesticides and insecticides
10.	Uterus and its appendages	Criminal abortion
11.	Muscle	Decomposition

- The gallbladder (bile) may show the presence of number of drugs including morphine, cocaine, methadone, glutathione, many antibiotics and tranquillizers and heavy metals (in chronic poisoning).
- If septicemia is suspected and the cause of it is not obvious, spleen should be cultured.

The viscera should be refrigerated at about 4°C, if not sent to the laboratory. They can be destroyed either after getting the permission from the Magistrate or when the investigating police officer informs that the case has been closed.

Preservation of Samples

- The ideal samples are the ones in which no preservative has been added and sent to CFSL within few hours. But, practically, it usually gets delayed.
- The specimen is preserved at 4°C until they are analyzed.^{13,14} For long-term storage, it has to be kept in freezer (-10°C).
- In order that putrefaction may not set in and render chemical analysis difficult, certain preservatives are used.

1. Viscera

- The most commonly used preservative for viscera is *saturated solution of common salt*.¹⁵ It is easily available, cheap and effective preservative.
- In cases of suspected alkali or acid poisoning (*except carbolic acid*), rectified spirit is used.¹⁶ It is *not used* in cases of suspected poisoning with:

- | | |
|-------------------|---------------|
| • Alcohol | • Chloroform |
| • Kerosene | • Ether |
| • Chloral hydrate | • Phosphorus |
| • Formaldehyde | • Formic acid |
| • Paraldehyde | • Acetic acid |

2. Blood for toxicological analysis [for alcohol, cocaine, cyanide and carbon monoxide (CO)] is preserved in sodium or potassium fluoride at the concentration of 10 mg/ml of blood and anticoagulant potassium oxalate, 30 mg/10 ml of blood.¹⁷
 - Postmortem samples are liable to production of alcohol by microbiological action and higher concentrations of sodium fluoride are required to inhibit this.

- Heparin and EDTA should not be used as anticoagulants, since they interfere with detection of methanol.
 - If blood is required only for grouping, no preservative is necessary and small amount of blood is well preserved by soaking in a blotter.
 - In case of suspected CO poisoning, a layer of 1-2 cm of liquid paraffin is added immediately over the blood sample to avoid exposure to atmospheric oxygen.
 - If solvent abuse and anesthetic death is suspected, the glass container should have a foil-lined lid to prevent gas from escaping (as gas can permeate rubber) and the container is completely filled to prevent gas from escaping in 'dead' air space.
 - Blood for hematological examination including glycosylated hemoglobin in diabetics should be sent in a clean glass container with anticoagulant (e.g. EDTA).
3. Urine is preserved by adding small amount of phenyl mercuric nitrate or thymol. Fluoride should be added to urine if alcohol, cyanide or cocaine is suspected in the sample.
 4. Vitreous humor is preserved using sodium fluoride (10 mg/ml).¹⁸
 5. For bones, hair and nails preservative is not required. It has to be dried in normal temperature and sealed in plastic bag. But, bone marrow is preserved in a test tube containing 4-5 ml of 5% albumin-normal saline solution and stored at 4°C.
- Formalin is *not* used as preservative for chemical analysis because extraction of poison, especially non-volatile organic compounds become difficult.
 - The use of disposable, hard plastic (especially polypropylene) or glass containers are recommended for preservation.
 - All samples should be properly sealed and labeled with the patient's name, hospital number, nature of sample, collection site, preservative used and date and time of collection. It should be handed over to the IO after obtaining proper receipt.

- Sodium fluoride is the most commonly used agent to prevent glycolysis.¹⁹ It inhibits the enzyme enolase and is also effective at inhibiting bacterial growth.²⁰
- EDTA can effectively chelate the calcium ion of blood, therefore it can prevent the blood coagulation, does not affect the count and size of the leukocyte and keep erythrocyte invariable. Other anticoagulants are potassium oxalate, citrate or lithium heparin.

Procedure of Preservation

For preservation of viscera, a clean, transparent and preferably sterile glass jar (one litre capacity) with a wide mouth and stoppers should be used. The size of the jar should be such, that at least 1/3rd of the container remains empty after being filled with the preservative to allow for accommodation of the gas which will evolve out of the organs preserved. However, the preservative should completely immerse the viscera after the contents are well shaken.

- The stomach, small intestine and its contents are preserved in one bottle, part of liver along with gallbladder, spleen and kidney in another bottle and urine in the third bottle. The stomach and intestines are opened before they are preserved. The liver and kidneys are cut into small pieces to ensure penetration of the preservative. Blood should be sent in a vial(s).
- When additional material is required to be sent, it should be dispatched in separate bottles, like brain in one bottle and vomitus or stomach washout in another bottle. The bottles and vials required for preservation are normally supplied by the office of the Forensic Science Laboratory (FSL).
- The stoppers of the bottles should be well fitting, covered with a piece of cloth and tied by tape or string and the ends sealed using a departmental seal. Each bottle should be suitably labeled with the autopsy number, name of the deceased, name of the organ, date, time and place of autopsy, followed by signature of the doctor who performed the autopsy.
- A sample of the preservative used (rectified spirit or sodium chloride) is separately preserved and sent for analysis to rule out any poison being present as a contaminant.
- The sealed bottles are then put in a viscera box which is sealed. A specimen of the seal used is put in a separate envelope which is sealed and handed over to the police constable, in return for a receipt. All these precautions are necessary to maintain the chain of evidence.
- Along with the viscera box, the following documents are also sent:
 - i. Copy of the inquest papers, brief facts of the case and the case sheet.
 - ii. Copy of autopsy report.
 - iii. Letter requesting the chemical examiner to examine the viscera and inform the medical officer of its findings.

Samples for Laboratory Investigations

- **Histopathological examination:** Sections of various internal organs (1.5 × 1.0 × 1.0 cm) in case of suspected

abnormality are preserved in 10% formalin or 95% alcohol.²¹

- **Bacteriological/serological examination:** Blood should be kept in sterile container using sterile syringe from the right ventricle of the heart or from some large vessel, such as femoral vein or artery. It may also be used for biochemical examination.
- **Virological examination:** A piece of tissue is collected and preserved in 50% sterile glycerin.
- **Enzymatic studies:** Small pieces of tissues are collected into a thermos containing liquid nitrogen.
- **Smears:** Vaginal/anal smears are needed in cases of alleged sexual assault. In suspected malaria, smears from cerebral cortex, spleen and liver may be taken and examined for malarial parasite.

Obscure and Negative Autopsy

Obscure autopsy: In about 20% of all postmortem examination cases, the cause of death may not be clear at the time of dissection of the body and there are minimal or indeterminate findings or even no positive findings at all. These are a source of confusion to any forensic pathologist.

In many of these cases, the cause of death can be made out after detailed clinical and laboratory investigations and interview with persons who had observed the deceased before he died.

Causes

- i. **Natural diseases:** Epilepsy, paroxysmal fibrillation.
- ii. **Concealed trauma:** Concussion, blunt injury to the heart, reflex vagal inhibition.
- iii. **Poisoning:** Anesthetic overdose, narcotic, neurotoxic, cytotoxic or plant poisoning.
- iv. **Biochemical disturbances:** Uremia, diabetes.
- v. **Endocrinal disturbances:** Adrenal insufficiency, thyrotoxicosis.
- vi. **Miscellaneous:** Allergy, drug idiosyncrasy.

Negative autopsy: In about 2-5% of all postmortem examination cases, the cause of death remains unknown, even after all laboratory examinations including microscopic and toxicological examination.

Reasons of negative autopsy

- i. Inadequate history.
- ii. Inadequate external examination and internal examination.
- iii. Insufficient laboratory examinations.
- iv. Lack of toxicological analysis.
- v. Lack of training of the doctor.

Second Autopsy

There is no provision in Indian law for a second autopsy. Rarely, it is conducted either by order of the Magistrate or senior police officer by a board of doctors, usually three in number, from different institutions. It is usually done when the relatives are not satisfied with the report given in the autopsy report or when the cause of death cannot be opined by the doctor in the first instance.

Examination of Decomposed, Mutilated and Skeletonized Remains

Definitions

- **Forensic anthropology** is that branch of physical anthropology which for forensic purposes deals with identification of skeletonized remains known to be or suspected to be being human.
- **Mass disaster:** Death of more than 12 victims in a single event, like fire, air crashes or floods. The number of victims far exceeds the capacity of local death investigation system to handle.
- **Decomposed bodies** show putrefactive changes in varying degree depending upon the time elapsed since death. In most cases, evidence of trauma (hemorrhage and fractures) can be recognized. Appropriate viscera should be preserved (whenever possible) for chemical analysis for evidence of suspected poisoning.
- **Mutilated bodies** are extensively disfigured, deprived of a limb or a part of the body, but the soft tissues, muscles and skin are still attached to the bones.
- **Fragmentary remains** include only fragments of the body such as head, trunk or limb.

In medico-legal practice, many a times, decomposed, mutilated, or even skeletonized bodies are received for autopsy. Careful examination may yield important information in all such cases. In case of mass disaster, the help of the anthropologist is sought in identification, if the remains are skeletonized, badly burnt or largely destroyed.

General description: Decomposed bodies sometimes have earth and clothes stuck to them and/or are infested with maggots. The body may be immersed in a tank of weak carbolic (lysol) acid to soften the earth and get the clothing away without disintegration. Samples of insect eggs or maggots should be obtained for laboratory examination prior to immersing the body in lysol.

In case of skeletal remains, bones are kept in anatomic arrangement and a skeletal chart is drawn, indicating which bones are present. A complete list of all the bones sent for examination should be prepared, and

photographs of all the bones are taken. The sand, dust or earth present on the bones is removed with brushes and wooden picks and scrapers. Light applications of acetone help to remove tight dirt.

Medico-legal Questions

Following questions which the autopsy surgeon usually faces in connection with postmortem examination:

Q. Whether the body is of human or animal?

- It is easy to say if the head, trunk or limbs are available, but when pieces of muscles are only available without attached skin or viscera, it is very difficult. In such cases, definite opinion can be given by *precipitin test* or *anti-globulin inhibition test* (more sensitive than precipitin test) using blood or any other soft tissue, if the tissue is not severely decomposed.
- In case of bones, gross anatomical and microscopic characteristics (Haversian system) and chemical analysis of bone ash may be done. Precipitin test may be useful for confirmation. Serological tests are not useful in case of bones not having extractable plasma proteins or those bones which are burnt or cremated.

Q. Whether it belongs to one or more bodies?

- This is determined by fitting together all separate parts. If there is no disparity or reduplication and if the color of the skin is same in all parts, they belong to one body.
- For bones, reconstructing the skeleton is done and observed for disproportion in the size of various bones, reduplication and articulation and if the age, sex and race of all the bones is same.
- If the bones are suspected to be from more than one skeleton, they can be separated by the use of short wave UV light which emits different color due to fluorescence of organic elements in the bones and inorganic substances on the surface of the bones.

Q. What was the race of the person?

This can be determined from hair and skin, if available, from nasal bridge height, nasal aperture shape, facial prognathism, palate shape, teeth (incisors), the skull (including cephalic index), pelvis and from features and indices of different long bones, particularly the lower extremities (Details are in Chapter 4).

Q. Whether it is male or female?

- It can be determined if the head or trunk is available, from the presence and distribution or absence of hair, configuration of the pelvis, skull, mandible, diameter of

head of femur and humerus and measurements of femur, tibia, humerus and radius. Recognizable sex differences are present only after puberty (Details are in chapter 4).

- It can also be determined from the recognition of prostate or uterus which can be identified even in advanced state of putrefaction. Microscopic examination may be done for confirmation. Sex can also be determined by nuclear sexing or sexing root sheath cells of human head hair.

Q. What was the age of the individual at the time of death?

- Age can be estimated from general development, color of hair on the scalp, beard, moustache and pubis.
- Closure of the cranial sutures, teeth, ossification centres of bones, changes in the mandible, symphyseal surface of the pubis, sacrum and margin of the glenoid cavity of the scapula; calcification of laryngeal and sternal cartilages and hyoid bone are also helpful. After the completion of bony union, exact age cannot be determined.

Q. What was the stature of the individual?

- Stature can be determined from long bones, such as femur, tibia, humerus or radius and using the formulae of *Pearson*, *Dupertius* and *Hadden*; *Trotter* and *Gleser* for Americans; *Breitinger* for Germans or multiplication factors devised by Indian researchers.
- The principle of these formulae is to measure the length of long bone and multiply it with a given factor and then adding a fixed factor.
- The length of the humerus multiplied by five is a quick method of estimation of height.

Karl Pearson's formula for stature from dried long bones (in cms)

S.No.	Male	Female
1.	$81.306 + 1.880 \times F$	$72.884 + 1.945 \times F$
2.	$78.664 + 2.376 \times T$	$74.774 + 2.352 \times T$
3.	$70.641 + 2.894 \times H$	$71.475 + 2.754 \times H$
4.	$89.925 + 2.271 \times R$	$81.224 + 3.343 \times R$

F: Length of femur, T: Length of tibia, H: Length of humerus, R: Length of radius

Q. What was the identity of the individual?

- It can be determined from fingerprints, tattoo marks, scars, moles, hair, teeth, flat feet, supernumerary ribs, congenital defects, deformities, articles of clothing and superimposition technique (if skull is available).
- An X-ray of any bone, if taken during life, may be compared with an X-ray of the same bone and it may

help in identification. Malunited fractures, healed fractures or deformities of bone, if present, are helpful.

- Determination of blood group antigens from teeth pulp might also help in establishing identity, if the blood group is known.
- Other methods include X-ray comparison of trabecular patterns and neutron activation analysis to distinguish the relative mineral contents.

Q. What was the manner of separation of parts?

It can be found out by examining the margins of the parts and the ends of the long bones and to look for whether they had been cleanly cut, sawn, hacked, lacerated, disarticulated at the joints or gnawed through by animals.

Q. What was the mode and place of disposal?

- The place of occurrence and disposal of the parts can be found out from trace materials attached with the parts from the place of disposal.
- A body buried in deep grave skeletonizes comparatively later. A body disposed off in open air dries up early. Bones of the bodies disposed in forest may be partly eaten by animals.

Q. Whether the injuries are antemortem or post-mortem in nature?

Evidence of vital reaction is looked for at margins of the injured parts.

Q. What was the cause of death?

- The cause of death can be made out if there is evidence of fatal injury to some vital organ or large blood vessel, or marks of burning or deep cuts or fractures of bones, especially the skull, cervical vertebrae, hyoid bone or ribs. Foreign body, such as a bullet, when present is helpful.
- Bones or their charred remains may be subjected to chemical analysis for the detection of metallic poisons, such as arsenic, as these are not destroyed by heat.

Q. What type of weapon was involved?

In case of presence of antemortem injury, like fracture or depending on the nature of injury of the bones, the weapon used to inflict the same and the type of weapon used to dismember the part, e.g. whether a hard blunt weapon, a light or heavy sharp cutting weapon, a pointed weapon or a firearm can be determined.

Q. What was the time of death?

The probable time since death may be determined from the condition of parts and decomposition changes. The appearance of bones, unless they are very recent, is

much more dependent upon the environment in which they have lain, than the passage of time. Bones left in a dry environment, such as sand, will last far longer than bones in a damp, acidic situation.

- If soft tissues, like fascia and ligaments are still attached with the bone, then death might have occurred within about 2 weeks to 2 months back.
- If no soft tissue is attached, but the bone is still not completely dry then, death might have occurred about 1-3 months back.
- If the bone is completely dry, but has a putrid smell, death has occurred within the last 3 months.
- If the bone is dry with no putrid smell, but has retained its normal color, then the time passed after death is between 3 months to 1 year.
- After 30-40 years, the bone tends to become lighter as the organic matrix is lost and the softer parts of the bone begin to crumble.

Dating of skeletal remains

- Total nitrogen content is > 4-5 g% in bones less than 50 years old. Between 50-100 years, it is about 3.5 g%, and 2.5 g% when the bones are 350 years old.
- The number of amino-acids (initially about 15, glycine and alanine are predominant) diminishes with age and hydroxyproline and proline tend to disappear after 50 years. A bone > 100 years old will contain 7 amino acids.²²
- Blood pigment tests using bone dust remain positive for upto 100 years.
- Eluted bone dust solution tested for immunological activity against a human anti-Coombs serum, test positive for 5-10 years.
- **UV fluorescence:** The sawn shaft of a long bone such as a femur is examined under an UV lamp; fresh bone will fluoresce across the whole surface from periosteum to marrow cavity. As time lengthens, the fluorescent zone narrows, breaks up and finally vanishes between 150-300 years.
- **Estimation of radioactive carbon (C-14):** Radioactive carbon gets deposited in living tissue. After death, there is no further deposition and its concentration gradually decreases in the organic substances. Estimation of C-14 in bones may give some idea as to when the person died. There is no significant fall of C-14 during the first century after death.

Exhumation

Definition: It is the lawful digging out of an already buried body from the grave.

- It is a situation where a previously-buried dead body is 'dug up,' 'unearthed,' or 'disinterred'.
- Usually it involves a body (of any age group) that was not originally autopsied but which, for some reason, must be exhumed in order for an autopsy to be performed.²³

Reasonsi. **Criminal cases**

- Establishing the cause and manner of death in suspected homicide disguised as suicide.
- Death as a result of criminal abortion and criminal negligence.
- Retrieving some vital object which may throw light on the case, e.g. bullet from the dead body, if the person was killed by a firearm.

- ii. **Civil cases:** Identification of the deceased for accidental death claim, insurance, workmen's compensation claim, liability for professional negligence, survivorship and inheritance claims, disputed identity, separation overseas, and burial of the wrong body inadvertently or by fraud.

Authorization: The body is exhumed only when, there is a written order from the *First Class Magistrate* (judicial or executive); police *cannot* order exhumation.²⁴

Procedure

- i. It should be done and completed in broad daylight, for which it should be started during the morning hours of the day.
- ii. The body is exhumed under the supervision of a medical officer and Magistrate, in the presence of a police officer.
- iii. Before opening the grave, it should be positively identified from location of burial plot, headstone and gravemarker, so that wrong body is not disinterred.
- iv. Soil from above, below and two sides of the body or the coffin should be preserved in separate glass jars, with identification tags.

- v. Disinfectants/pesticides should not be sprinkled on the body as it might interfere later with the determination of poison in the body.
- vi. The doctor should examine the body inside the grave or the coffin regarding its position and appearance. A drawing of the grave and body or skeleton should be made, noting all the details, whether the face is up, or to the right, arms are extended, or the lower limbs are flexed.
- vii. The grave or the coffin with the body should be photographed.
- viii. If decomposition is not advanced, a plank or a plastic sheet should then be lowered to the level of the earth on which the body rests.
- ix. After this, the body is lifted and sent for postmortem examination, along with a requisition and a preliminary investigation report which contains the brief history of the case. In the mortuary, postmortem examination on the body is performed as in all other cases.
- x. In highly putrefied bodies, an attempt should be made to establish the identity. Viscera should be preserved for chemical analysis. If the body is reduced to skeleton, the bones should be examined.

Time limit

In India, there is *no time limit* for ordering of the exhumation, but many western countries have well-defined time limit upto which exhumation can be done.²⁵ For example, in France, the time limit is 10 years and in Germany, the time limit is 30 years. Thus in France, after 10 years of death, if some facts are found which may reveal foul play, even then the body cannot be exhumed.

MULTIPLE CHOICE QUESTIONS

1. The dead body of a murdered person is brought for preservation in mortuary. Statement NOT correct is:

AIIMS 04

- A. The body should be stored averagely at 4°C.
- B. The body can be embalmed before postmortem.
- C. The body should be never undressed before the forensic doctor has seen it.
- D. The body can be stored at -20°C to preserve it for long duration.

2. The temperature ideally preferred to preserve the body for autopsy is:

JIPMER 03

- A. -10°C
- B. 0°C

- C. 4°C
- D. 10°C

3. Last structure to be autopsied in asphyxial death:

AIIMS 07, 08

- A. Head
- B. Thorax
- C. Abdomen
- D. Neck

4. True about subendocardial hemorrhages are all, except:

AIIMS 10; UPSC 11

- A. May be seen after head injury
- B. Involves the right ventricular wall
- C. Continuous pattern
- D. Flame shaped hemorrhages

Autopsy Room Hazards

7

It has long been recognized that the autopsy room is a potential source of infection and that the forensic pathologists and other persons in close proximity to an autopsy are at higher risk of contracting infectious diseases from the dead bodies. These personnel have a greater exposure to blood-borne viruses and other infections including human immunodeficiency virus (HIV), hepatitis B (HBV), non-A non-B hepatitis (C, D and E viruses), tuberculosis, Creutzfeldt Jakob disease, herpes and human T-cell lymphotropic virus type I.

Infections in autopsy room may be acquired by any one of the following routes:

- A wound resulting from an object (e.g. scalpel) contaminated with blood or body fluids or needle-stick injury.
- Splash of infected blood or other body fluids onto an open wound or area of dermatitis.
- Contact of blood or other body fluids with mucous membranes of the eyes, nose or mouth.
- Inhalation and ingestion of aerosolized particles.

Commonly Acquired Infections

- **Hepatitis B** is the most transmissible of the blood-borne viruses, but its transmission is preventable by vaccination. Increased risk of HBV infection has been found among health care workers, especially those having frequent contact with blood and/or exposure to needles or sharp instruments. Among the physicians, pathologists have been recognized as a high-risk group for occupationally acquired HBV infection, because of their greater exposure to blood.
 - Persons associated with postmortem examination and other health care workers experiencing needle stick injuries are at a considerable risk of acquiring **hepatitis C infection** (HCV).
 - Autopsies on persons who have died of **viral hemorrhagic fever** (VHF) pose even greater risk. Many pathologists and their assistants have died of autopsy transmitted Ebola, Marburg and Lassa hemorrhagic fevers.
- Autopsy is an efficient method of transmitting **tuberculosis** from the dead body to those present in the autopsy room. The risk for infection does not vary with the distance from the autopsy table. In our country, where tuberculosis is still the most fatal respiratory disease affecting the lower socioeconomic group and where unidentified vagabonds constitute a significant percentage of the autopsy population, the percentage of unrecognized tuberculosis cases is substantial. Airborne droplets, usually from sputum positive cases transmit tuberculosis. Embalming itself has been shown to produce active tuberculosis aerosols.
 - The risk of **HIV infection** among medical and laboratory personnel, including mortuary workers, is considered low when compared with other blood-borne viruses, such as HBV and HCV, but resembles the rates for single contact heterosexual transmission. Deep injury, visible blood on the device causing the injury, injury with a needle used in a vessel and injury with hollow-bore needle (compared to a solid needle)—all increases the likelihood of a larger inoculum of blood entering the recipient. HIV infection should be suspected, if the body is of:
 - i. Male homosexual
 - ii. Intravenous drug abuser
 - iii. Hemophiliac who has received repeated blood transfusions
 - iv. Female prostitute
 - v. Victim of sexual abuse.

Risk of transmission from single percutaneous exposure to blood for:

- HBV: 6-30%
- HCV: 3%
- HIV: 0.3%¹

Autopsy of HIV Positive and HBV Patients

One school maintains that all autopsies should be carried out with total precautions against infective risk. However, this is almost impracticable to achieve in the present set-up. The other school advocates pre-autopsy testing of blood-sample for HIV and other infective agents.

A simple and rapid test (10-minute test carried out by a manual HIV test-kit) is available for mortuary use in the developed countries. This test is also applicable to urine—a more cost-effective specimen and safer than blood collection.

Pre-preparation: The body should be transported to the mortuary by duly plugging all the natural orifices and sites of the IV drip. It should be wrapped and tied in double layer, tough plastic bag, with a red color tag mentioning 'Biologically Hazardous'. The label should mention the name, age, sex and registration number.

Universal Work Precautions

- No unauthorized person should be admitted in the autopsy room, so as to minimize exposures. Only experts and workers who are trained in handling the infected material should be allowed.
- Immunosuppressed or immunodeficient individuals and individuals who have uncovered wounds, oozing skin lesions or dermatitis should not perform the autopsy.

Clothing: Autopsy personnel should wear protective clothing—full sleeves overalls, head cap, N95 particulate masks, goggles if eye glasses are not worn, double gloves (heavy autopsy gloves over surgical gloves) and waterproof rubber gumboots of knee length with shoe covers. A plastic visor will protect the eyes and mucosal surfaces from splash injury.

Handling sharp instruments: Minimum instruments as needed should be kept. Scissors with slightly blunt ends should be used and sharp ones are used, only if needed. Wherever possible, the use of needles should be avoided. Needlestick injuries are entirely preventable, blunt needles and bulb syringes should be used to aspirate fluids.

Needlestick accidents occur during disposal of needles, they should never be recapped after use.

Accident cuts, particularly to the distal thumb and index and middle fingers are the most frequently injured by forensic pathologists.

Examination of organs: It is better to leave some organs in situ in the cadaver rather than eviscerating *en masse*. Another method is to fix lungs and other organs as a whole after removal, rather than slicing them before fixation.

To minimize aerosol splatter, cranium may be opened with an electrical oscillating saw attached to a vacuum dust exhaust and filter or with a handsaw under a transparent anti-splash cover.

Handling specimens for laboratory examination: They should be properly labeled and fixed with 10% formalin solution and should be handled with gloved hands.

Disposal of used instruments: They should be dipped in 2% glutaraldehyde (Cidex) for 30 minutes, washed with soap and water, dried and then rinsed in methylated spirit and air dried or autoclaved.

- All soiled gauze and cotton should be collected in a double plastic bag for incineration.
- Disposable needles and syringes, scalpel blades and other sharp items should be placed in a puncture-resistant containers.
- Laundry material, e.g. aprons and towels should be soaked in 1% bleach for half-an-hour, washed with detergent and hot water, and autoclaved.

Clean-up procedure: Small spatters and spills of blood and other body fluids should be wiped up with disposable tissues or towels which are discarded in special biohazard bags and properly disposed. The autopsy table and floor should be cleaned with 1% bleach solution, followed by washing with soap and water.

The health care workers should wash thoroughly with soap and water before dressing.

Disinfectants: 1:10 dilution of common household bleach or a freshly prepared sodium hypochlorite solution is recommended. Liquid chemical germicides commonly used in health care facilities and laboratories are effective against HIV.

The most common method of exposure includes being pricked with a used needle or other contaminated material. To prevent this, body-sewing needles and staples may be avoided and the mortician's stitches may be replaced by suture-free closure using tapes.

After that, the body should be wrapped in double layer plastic sheet bag and secured properly, so that there is no leakage. A tag should be attached for identification.

Universal precautions apply to blood, semen and vaginal secretions, as well as to CSF, synovial, pleural, pericardial, peritoneal and amniotic fluid, but they do not apply to feces, nasal secretions, sputum, sweat, urine and vomitus, unless they contain visible blood.

In case of accidental injuries or cuts with instruments, contaminated or not with blood or body fluids, while working on a body, the wound should be immediately washed thoroughly under running water, bleeding encouraged and the wound disinfected.

It must be reported to the authorities and immediate, proper measures instituted. Blood sample should be taken from the source of exposure and tested for HIV and HBV. The individual should be advised that he/she could possibly have been infected by the needle-prick and counseled appropriately. HIV-testing should be done there, and then after an interval of 3 and 6 months to trace the possible introduction of the virus to the related event, so as to evaluate the ensuing claims, if need be.

Autopsy and Disposal of Radioactive Corpse

- If the amount of radioactivity is < 5 millicuries, no precautions are necessary.
- If the body contains between 5-30 millicuries of radioactive material, the doctor must wear heavy rubber gloves, plastic aprons, shoe covers and spectacles to reduce radiation. Instruments with long handles should be used during the autopsy. Organs that are most radioactive should be removed first and placed in covered glass jars, labeled and examined for radioactivity from time to time. Fluid of the pleural and peritoneal cavity should be flushed copiously with running water and drained off directly into the sewer. Contaminated clothing should be thoroughly cleaned with soap and water, for suitable decay of the radioactive material before being sent to laundry. Instruments can be brought to a safe limit by soaking them in water with soap. Contamination of the floor of the autopsy room should be avoided.
- If the body contains more than 300 millicuries activity after autopsy, it should be embalmed in the hospital mortuary. The presence of a cardiac pacemaker must be recorded, especially if it is one which might contain a radioactive substance.

Organs may be removed and detailed dissection is done away from the body, or placed in a glass jar and preserved in a fixative or kept in cold storage for later examination when radioactivity has fallen to a safer level.

MULTIPLE CHOICE QUESTION

1. Transmission rate of HIV by needlestick injury in health professionals is: *CMC (Vellore) 08; TN 09*
- A. 0.3% B. 1%
C. 5% D. 10%

Thanatology

8

Definition: Thanatology (Greek *thanatos*: death) is the scientific study of death in all its aspects including its cause and phenomena.¹ It also includes bodily changes that accompany death (postmortem changes) and their medico-legal significance.

Death occurs in two stages (Diff 8.1):

- i. Somatic, systemic or clinical
- ii. Molecular or cellular.

Somatic death: The question of death is important in resuscitation and organ transplantation. Skin and bone remains metabolically active for many hours and these cells can be successfully cultured days after somatic death.

During early 20th century, irreversible cessation of circulatory and respiratory functions was sufficient basis for diagnosing death.

Molecular death

- Molecular death occurs piecemeal. Initial changes occur due to metabolic dysfunction and later from structural disintegration.
- Nervous tissues die rapidly, the vital centres of the brain in about 3–7 min, but muscles survive upto 1-2 h.

Supravital reactions

• Mechanical excitability of the skeletal muscle

- i. Tendon reaction (*Zsako's phenomenon*): Contraction of the whole muscle (e.g. quadriceps) due to propagated excitation following a mechanical stimulation, seen within 2-3 h after death.
- ii. Localized idiomuscular contraction at the point of stimulation may be seen several hours after cessation of Zsako's phenomenon.

• **Electrical excitability of the skeletal muscles** of the face may be observed for few hours after death.

• **Pharmacological excitability** of the iris muscle resulting in change of pupil diameter following the administration of miotic or mydriatic solutions can be seen during the first hours of the postmortem period.

Brain/Brainstem Death

As ventilator technology advanced, circulation and respiration could be maintained by means of a mechanical respirator, despite loss of all brain functions and thus have brought the concept of **brain death**, i.e. irreversible loss of cerebral functioning.

- Brain death is the complete and irreversible cessation of functioning of the brain. Brain includes all the CNS structures, except the spinal cord.

Differentiation 8.1: Somatic death and molecular death

S.No.	Feature	Somatic death ²	Molecular death ³
1.	Definition	Complete and irreversible cessation of function of brain and stoppage of the circulation and respiration	Death of individual tissues and cells
2.	Onset	Precedes molecular death	Succeeds somatic death (1-2 h after stoppage of vital functions)
3.	Response to external stimuli	Muscle responds thermal, electrical or chemical stimulus	Does not respond
4.	Confirmation	Flat ECG and EEG, and absent breath sounds	Rigor mortis, algor mortis, postmortem lividity, putrefaction
5.	Resemblance	Suspended animation, coma, hypothermia	Does not resemble any condition

- Brain death is now accepted as brainstem death. The respiratory centre which controls respiration lies within the brainstem. If this area is dead, the person is unable to breath spontaneously or regain consciousness.
- As the integrity of the reticular formation within the brainstem is essential for the proper functioning of the cortex, brainstem death can practically be considered to be sufficient for brain death. *The crucial point in determining brain death is the demonstration of absence of all brainstem functions.* Many countries, including India, now legally consider brainstem death as brain death.

Mechanism of Brain Death

Brain injury has a number of causes, such as traumatic or cerebrovascular injury and generalized hypoxia, all of which produce brain edema.

Edema is accompanied by an increase in intracranial pressure leading to gradual decrease in cerebral circulation to the level of almost cessation, causing aseptic necrosis of the brain. Within 3-5 days, there occurs widespread brain destruction or *pannecrosis*

throughout the cerebrum and the brainstem, the brain becomes a liquefied mass, a condition known as '*respirator brain*'. Increase in the intracranial pressure compresses the entire brain including the brainstem and total brain infarction follows.

Diagnosing Brain Death (Box 8.1)

The two essential requirements for the diagnosis of brain death are:

1. *Establishment of cessation of all brain functions*, i.e. cerebral and mainly brainstem functions using primarily the clinical criteria and partly by confirmatory paraclinical/laboratory tests which includes electroencephalogram (flat isoelectric EEG) and somatosensory evoked potentials (SSEP) and tests to measure cerebral blood flow.⁴
2. *Demonstration that cessation of these functions is irreversible*: Irreversibility is established by:
 - Determination of the cause of loss of brain function.
 - Exclusion of reversible conditions.
 - Demonstration that the cessation of brain functions persists for an appropriate period of observation.

Box 8.1: Diagnostic clinical brain death criteria^{4,5}

- A. **Prerequisites.** Brain death is the absence of clinical brain function when the proximate cause is known and demonstrably irreversible.
- i. Clinical or neuroimaging evidence of an acute CNS catastrophe that is compatible with the clinical diagnosis of brain death.
 - ii. Exclusion of complicating medical conditions that may confound clinical assessment.
 - iii. No drug intoxication or poisoning.
 - iv. Core temperature > 32°C (90°F).
- B. **The three cardinal findings in brain death** are coma, absence of brainstem reflexes and apnea.⁶
1. **Coma** or unresponsiveness—No cerebral motor response to pain in all extremities.
 2. **Absence of brainstem reflexes**
 - a. *Pupils*
 - i. Absent pupillary response to bright light.
 - ii. Size: Mid position (4 mm) to dilated (9 mm).
 - b. *Ocular movement*
 - i. No oculocephalic reflex (Doll's eye phenomenon).
 - ii. Absent oculovestibular reflex (Caloric test): No deviation of eyes to irrigation in each ear with 50 ml of cold water.
 - c. *Facial sensation and facial motor response*
 - i. No corneal reflex to touch with a cotton swab.
 - ii. No jaw reflex.
 - iii. No grimacing to deep pressure on nail bed, supraorbital ridge, or temporomandibular joint.
 - d. *Pharyngeal and tracheal reflexes*
 - i. No gag reflex: No response after stimulation of the posterior pharynx with tongue blade.
 - ii. No cough response to bronchial suction.
 3. **Apnea test:** It is based on the fact that loss of brainstem function definitively results in loss of centrally controlled breathing, with resultant apnea.

Exclusion of Reversible Conditions

The most important reversible conditions/confounding factors that must be excluded are:

- i. Hypothermia
- ii. Severe electrolyte, acid-base or endocrine abnormalities
- iii. *Drug intoxication*: Presence of sedation, neuromuscular blockade, or drugs causing CNS depression
- iv. Hypoxia, hypotension and shock
- v. *Other conditions*: Brainstem encephalitis, severe hypophosphatemia, encephalopathies associated with hepatic failure, uremia and hyperosmolar coma of diabetes mellitus.

Observation period: The length of the observation period is still a matter of great controversy. Neurological examination must not be done within 30 min of cardiopulmonary resuscitation.

Brain Death Certification

The common consensus in this regard is as follows:

- i. Two medical practitioners must perform the brainstem death tests.
- ii. The patient's attending physician should participate in the determination of death wherever possible.
- iii. The doctors involved should be experts in the technique of brain death assessment. Under no circumstances are brainstem death tests performed by transplant surgeons or any doctor in the transplant team.
- iv. Each doctor should perform the tests twice.

Beating-heart donor or living cadavers: After brainstem death has been established, the retention of the patient on the ventilator facilitates a fully oxygenated cadaver transplant, the so-called *beating-heart donor or living cadavers*.

- The success of a homograft depends mainly upon the type of tissue involved and the rapidity of its removal after circulation has stopped in the donor.
- The best results are obtained if the organs are salvaged while circulation is present or immediately after cessation of the circulation.
- Cornea can be removed from the dead body within 6 h (opacity occurs within 2 h of death, but the changes are reversible), skin in 24 h, bone in 48 h and blood vessels within 72 h for transplantation. Kidneys within 45 min, heart within one hour, lungs and liver within 15 min.

Types of transplants

- **Autograft:** Tissue transplanted from one part of the body to another in the same individual. It is also called *auto-transplant or homologous transplantation*.
- **Allograft:** Organ or tissue transplanted from one individual to another of the same species with a different genotype. It is also called *allogeneic graft or homograft*.
- **Isograft:** Organs or tissues are transplanted from a donor to a genetically identical recipient (such as an identical twin).⁷
- **Xenograft:** Organs or tissue transplanted from one species to another, e.g. grafting of animal tissue into humans.⁸
- **Split transplants:** Deceased-donor organ (specifically the liver) may be divided between two recipients, especially an adult and a child.

Cause, Mechanism and Manner of Death

Two of the most important functions of the forensic doctor are the determination of the cause and manner of death.

- **Cause of death** is any injury or disease producing physiological derangement, briefly or over a prolonged period and which results in the death of the individual, e.g. a gunshot wound to the abdomen, a stab wound to the chest, adenocarcinoma of the lung or coronary atherosclerosis.
- **Mechanism of death** is the physiological derangement produced by the cause of death that results in death, e.g. hemorrhage, septicemia, metabolic acidosis or alkalosis, ventricular fibrillation and respiratory paralysis. A particular mechanism of death can be produced by multiple causes of death and vice versa. Thus, if an individual dies of hemorrhage, it can be produced by a gunshot wound or a stab wound or a malignant tumor of the lung eroding into a blood vessel. A cause of death, e.g. a gunshot wound of the abdomen can result in many possible mechanisms of death, like hemorrhage or peritonitis.
- **Manner of death** explains how the cause of death came about. Manner of death can generally be categorized as natural (death due to disease), homicide, suicide, accident or undetermined (Flow chart 8.1 and Table 8.1).
 - A cause of death may have multiple manners of death. An individual can die of massive hemorrhage (mechanism of death) due to stab wound of heart (cause of death), with the manner being homicide (someone stabbed him), suicide (stabbed himself), accident (fell over the weapon) or undetermined (not sure what happened).

Flow chart 8.1: Manner of death

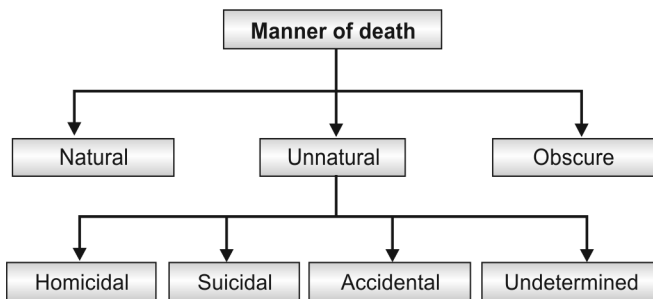

Table 8.1: Description of manners of death

Manner	Definition
Natural	Death resulting from disease
Homicide	Death resulting from the deliberate action of another
Suicide	Death intentionally self-inflicted
Accident	Death as the result of an environmental influence

- For some deaths the manner may be undetermined because the circumstances are unclear; for example, whether a drowning was accidental or suicidal.
- Deaths for alcohol and drug abuse are difficult to classify and are sometime described as 'unclassified'.

- **Agonal period** is the time between a lethal occurrence and death.⁹

Cause of Death

The international format of certifying the cause of death is defined by the WHO. The system divides the cause of death into two parts:

- Part I describes the condition(s) that led directly to death (immediate cause). It is divided further into subsections and generally three—(a), (b) and (c). These are for disease processes that have led directly to death and that are causally related to one another,

(a) being due to or consequent on (b), which in turn is due to or consequent on (c) (antecedent causes).¹⁰

- Part II is for other conditions, not related to those listed in Part I, that have also contributed to death (contributory cause).¹⁰

- It is important to realize that it is the disease lowest in the Part I list that is the most important, as it is the primary condition, the start of the events leading to death (Table 8.2).
- It is not necessary to complete parts Ib, Ic or II, if there are no predisposing conditions.
- If a patient died from suddenly due to intracerebral hemorrhage due to hypertension, the cause of death will be:

i. Ia: Intracerebral hemorrhage

ii. II: Hypertension

And, if the same patient survived for few days or weeks and developed pneumonia, the death certificate should record both processes:

i. Ia: Bronchopneumonia

ii. Ib: Intracerebral hemorrhage

iii. II: Hypertension

- Statistically, both certificates would record the primary cause as intracerebral hemorrhage.
- Doctors should not write the mode of death on the death certificate as these terms are cumbersome and are not useful.

Modes of Death (Proximate Causes of Death)

According to *Xavier Bichat*, a French physician, there are three modes of death depending upon the system most obviously affected, irrespective of what the remote cause of death may be:

i. Coma

ii. Syncope

iii. Asphyxia.

Coma

Definition: It is a state of profound unconsciousness from which a person cannot be roused, with minimal or

Table 8.2: Cause, mechanism and manner of death

Cause of death	Mechanism of death	Manner of death
<ul style="list-style-type: none"> • Hemoperitoneum, as a consequence of <ul style="list-style-type: none"> – Laceration of the aorta, as a consequence of – Blunt thoracic trauma 	Hemorrhagic shock	Accident
<ul style="list-style-type: none"> • Bronchopneumonia, as a consequence of <ul style="list-style-type: none"> – Stab wound of thorax 	Septicemia	Homicide
<ul style="list-style-type: none"> • Cardiac tamponade, as a consequence of <ul style="list-style-type: none"> – Gunshot of thorax 	Cardiac dysrhythmia	Homicide

no detectable responsiveness to stimuli. This is death from failure of the function of the brain.

Causes: It is the mode of dying seen in:

- i. *Injury or disease* of the brain
- ii. *Systemic disorders*, such as diabetic ketoacidosis, uremia, heat stroke, eclampsia
- iii. *Intoxication* with alcohol, opium, cocaine, chloral hydrate, anesthetics, atropine, cyanide, phenol
- iv. *Other conditions:* Severe catatonic states.

Postmortem examination: It may reveal the cause, such as inflammation of the meninges, compression from hemorrhage, tumor or vascular lesion. In case of poisoning and metabolic disorders, a hyperemic condition of the brain and its covering membranes may be found.

Persistent vegetative state (PVS): The individual has lost cognitive neurological function and awareness of the environment, but does have noncognitive function and a preserved sleep-wake cycle.

- Spontaneous movements may occur and the eyes may open in response to external stimuli, but the patient does not speak or obey commands.
- Patients in a vegetative state may appear somewhat normal.
- It is usually seen in patients with diffuse, bilateral cerebral hemisphere disturbance with an intact brainstem, though it can occur with damage to the most rostral part of the brainstem.

Syncope

This is death from failure of the function of the heart resulting in hypoxia and hypoperfusion of the brain.

Causes

- i. Heart disease
- ii. Pathological state of blood
- iii. Hemorrhage
- iv. Exhausting diseases
- v. Vagal inhibition
- vi. Poisoning: Digitalis, tobacco, aconite and oleander

Postmortem examination: Non-specific findings. The cavities of the heart contain comparatively little blood, the organs are pale, and capillaries are congested.

Asphyxia

This is death from failure of the function of the lungs.

- It occurs in pathological conditions of the respiratory system, such as pneumonia, paralysis of the respiratory centre (as in opium poisoning), occlusion

of air passages, breathing of irrespirable gases and traumatic asphyxia.

- In all these conditions, respiratory function ceases before that of the heart.

Postmortem examination: Triad of asphyxial stigmata may be seen:*

- i. *Cyanosis:* Bluish discoloration of skin, face (particularly lips and ears), nailbeds, mucous membranes or internal organs.
- ii. *Petechial hemorrhages* on the face, conjunctiva, subpleura or subepicardium (**Tardieu spots**).
- iii. *Congestion and edema of the face and visceral congestion* due to raised venous pressure.

Other features: Pronounced lividity, cardiac dilatation, or pathological changes which are dependent upon the type of death, like local injuries to the neck in hanging, strangulation and throttling, and color of blood in carbon monoxide poisoning.

It is usually not possible to certify that a person died of coma, syncope or asphyxia without mentioning the cause which has produced them, e.g. coma due to head injury, syncope due to tobacco poisoning, or asphyxia due to hanging.

Anoxia

According to *Gordon*, cessation of vital functions is brought about by tissue anoxia.¹¹

- Anoxia means complete lack of oxygen which ultimately leads to cardiac failure and death.
- Nowadays, the term 'hypoxia' is used which is shortage of oxygen in blood.

Anoxia is classified into four types:

- i. **Anoxic anoxia:** It occurs due to defective oxygenation of blood in the lungs and may be due to:
 - Breathing in a rarefied atmosphere, as in high altitude climbing or flying, or inhalation of carbon dioxide or sewer gas.
 - Mechanical interference to the passage of air into the respiratory tract, e.g. smothering, hanging, strangulation, throttling, gagging, choking or drowning.
 - Prevention of normal movements of the chest, e.g. strychnine poisoning or traumatic asphyxia.
 - Cessation of the respiratory movements, as in paralysis of the respiratory centre, e.g. electric shock and bulbar palsy, poisoning with morphine and barbiturates.
- ii. **Anemic anoxia:** It occurs due to reduced oxygen carrying capacity of the blood, e.g. hemorrhage, poisoning by carbon monoxide and nitrites.¹²

* Fluidity of blood and dilation of right ventricle are not considered as pathognomic of asphyxia

- iii. **Histotoxic anoxia:** It means inhibition of oxidative processes in the tissue which cannot make use of oxygen in the blood, e.g. cyanide poisoning.^{12,13}
- iv. **Stagnant/ischemic anoxia:** In this type, impaired circulation results in reduced oxygen delivery to the tissues, e.g. shock, congestive cardiac failure and heat stroke.

Sudden Death

Definition: Death occurring instantaneously or within one hour of the onset of morbid symptoms (as per WHO 24 h is the limitation period). Sudden death is important from a medico-legal point of view, as it raises a suspicion of foul play.

- In cases of sudden death, it is usually not possible to ascertain the cause of death from an external examination of the body. Therefore, in all such cases, an autopsy is necessary to obviate the possibility of death due to foul play.
- A doctor who issues a death certificate in such a case runs the risk of being accused as an accessory to the crime, should the death be found to be due to foul play eventually.

Causes

1. **Cardiovascular** (44-50% of cases): Cardiovascular disease, particularly coronary artery atherosclerosis is the most common cause of sudden death.
 - Coronary artery disease
 - Valvular heart disease
 - Congenital heart disease
 - Hypertensive heart disease
 - Infection, e.g. myocarditis, pericarditis
 - Cardiac tamponade
 - Cardiomyopathies
 - Aortic aneurysm
2. **Respiratory system** (15-23% of cases)
 - Pulmonary embolism
 - Lobar/Bronchopneumonia
 - Massive hemoptysis
 - Obstruction by foreign body
 - Air embolism
 - Edema of glottis/lungs
 - Pneumothorax
 - Neoplasm
3. **Central nervous system** (10-18% of cases)
 - Intracerebral hemorrhage
 - Cerebral thrombosis
 - Subarachnoid hemorrhage
 - Embolism

- Meningitis
 - Tumor
 - Idiopathic epilepsy
 - Abscess
4. **Gastrointestinal system** (6-8% of cases)
 - Hemorrhage from peptic ulcer, esophageal varices or malignancy
 - Strangulated hernia
 - Rupture of abdominal aneurysm
 - Ruptured diseased viscus
 - Acute hemorrhagic pancreatitis
 - Appendicitis
 - Fulminant hepatic failure
 - Ruptured liver abscess
 5. **Genitourinary system** (3-5%)
 - Chronic nephritis
 - Tuberculosis of kidney
 - Nephrolithiasis
 - Tumors of kidney/bladder
 6. **Reproductive system**
 - Toxemia of pregnancy
 - Rupture of ectopic pregnancy
 - Uterine hemorrhage due to fibroids
 - Carcinoma of vulva
 7. **Endocrine**
 - Adrenal insufficiency or hemorrhage
 - Myxedemic coma or crisis
 - Diabetic coma
 - Parathyroid crisis
 8. **Iatrogenic**
 - Abuse of drugs
 - Mismatched blood transfusion
 - Sudden withdrawal of steroids
 - Anesthesia
 9. **Miscellaneous**
 - Anaphylaxis
 - Cerebral malaria
 - Alcoholism
 - Shock from dread, fright or emotion
 - Sickle cell crisis
 - Bacteremic shock

Special Causes in Children

- i. Cot deaths or SIDS
- ii. Mongols and others with congenital or mental abnormalities
- iii. Concealed puncture wounds.

Indeterminate: Very rarely the cause cannot be determined.

Coronary Atherosclerosis

The most common cause of death from cardiovascular disease is coronary atherosclerosis.

Almost all adults show atherosclerotic plaques scattered throughout the coronary arterial system. However, significant stenotic lesions that may produce chronic myocardial ischemia show more than 75% (three-fourth) reduction in the cross-sectional area of a coronary artery or its branch. Zones of occlusion are usually less than 5 mm in length and the area of the severest involvement is about 3-4 cm from the coronary ostia, more often at or near the bifurcation of the arteries, suggesting the role of hemodynamic forces in atherogenesis.

Acute occlusion of coronary artery may result from thrombosis or hemorrhage within the wall of the artery. The frequency of occlusion of the coronary arteries is:

Coronary artery	Percentage (%)
Left anterior descending	40-50
Right coronary artery	30-40
Left circumflex artery	15-20

- The location of myocardial infarction (MI) is determined by the site of the vascular occlusion and by the anatomy of the coronary circulation.

- Most infarcts occur in the left ventricle in the anterior wall. Right ventricle is involved in < 10% of cases.¹⁴
- Occlusion of the left anterior descending coronary artery typically causes an infarct in the anterior and apical areas of the left ventricle and the adjacent interventricular septum (anteroapical MI) (Fig. 8.1).
- Occlusion of the right coronary artery is responsible for most infarcts involving the posterior and basal portions of the left ventricle.
- Posterior infarcts may be due to blockage of either the right vessel or the circumflex branch of the left artery.
- Myocardial infarcts which involve the entire thickness of the ventricular wall are referred to as *transmural infarcts*, while those restricted to the inner one-third of the myocardium are called *subendocardial infarcts*.
- Fresh thrombi are dark-brown and are attached to the vessel walls. Old thrombi appear as homogeneous yellowish or gray, firm plugs blocking the vessels. Significant obstruction of the coronary artery lumen (with 75% narrowing of the lumen) without MI or thrombosis may lead to sudden death. Hypoxic myocardium is electrically unstable and liable to arrhythmias and ventricular fibrillation, especially at moments of sudden stress, such as exercise or with/ during an adrenaline response, such as anger or emotion.

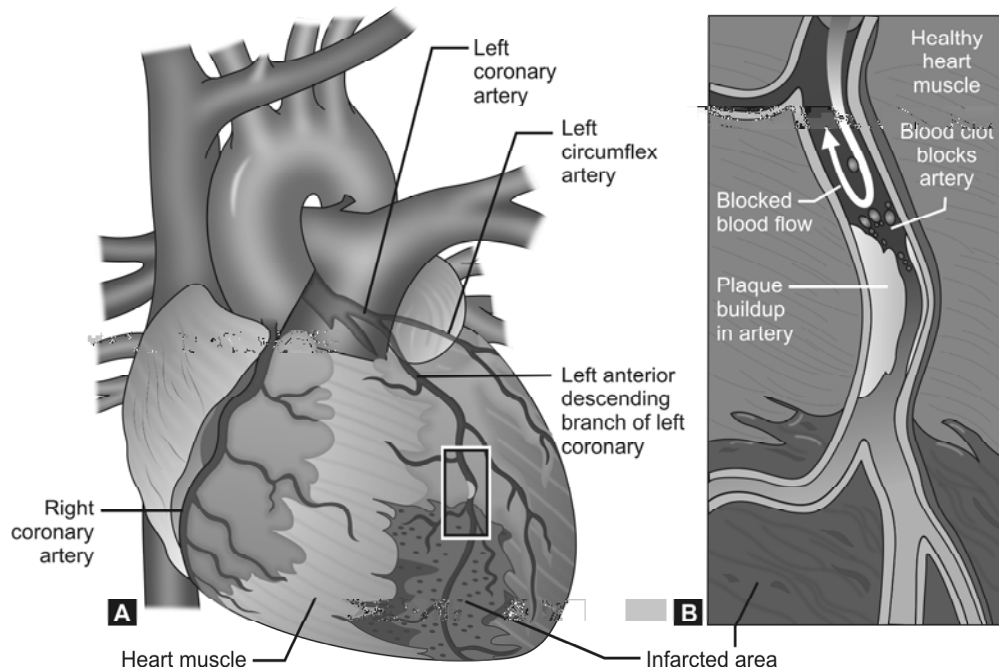

Fig. 8.1: Myocardial infarction

Postmortem Examination

No naked eye change is seen for the first 12-18 h. The appearance of a myocardial infarct is determined primarily by its age. It is generally accepted that at least 12-24 h of survival postinfarction must occur for the earliest recognizable change to evolve in the heart.

The essential sequence of events consists of coagulation necrosis and inflammation, followed by the formation of granulation tissue, resorption of the necrotic myocardium, and finally organization of the granulation tissue to form a collagen-rich scar. These events occur in a fairly predictable pattern, allowing one to estimate the age of a given infarct from its gross and microscopic appearance (Table 8.3).

Immersion of tissue slices in a solution of *triphenyl tetrazolium chloride* (TTC) gives red color to the intact area (where dehydrogenase is preserved), but infarcted area appears pale if seen in about 4 h; the results are however inconsistent.

Fresh thrombotic lesion is seen in less than 25% of the cases. Coronary artery spasm can cause death in patients suffering from angina without narrowing of the coronary arteries and without significant atherosclerosis or congenital anomalies. The lesions of the conducting system of the heart may sometimes cause arrhythmias and death. Any person with a heart in excess of 420 g is at risk of sudden death, even though the coronary arteries are normal.

- **Enzyme histochemistry** is the most reliable method of detecting early MI. Dehydrogenases—succinic, lactic, malic, hydroxybutyric and cytochrome oxidase are among those used. With malate dehydrogenase, normal

myocardium stains dark blue-black and infarcted area is devoid of color.

- **Periodic Acid-Schiff (PAS) stain:** In early infarcts (at least 28 h), damaged myofibres stain a pale purple-blue with PAS, compared with the pink color of healthy fibres.
- **Hematoxylin-Eosin (H&E) autofluorescence:** Routine formalin-fixed H&E sections are examined under UV light. Early infarcted fibres show a shift of their secondary emission towards yellow, away from the usual olive-green of healthy fibres.
- **Acridine-Orange fluorescent stain:** Slides are examined under UV light; normal myocardium is golden brown/yellowish brown with damaged fibres showing a shift to green.

Anaphylactic Deaths

Most anaphylactic deaths seen by forensic pathologist are caused by insect bites, drugs or foods.

Signs and symptoms: Faintness, itching of the skin, urticaria, tightness in the chest, wheezing, respiratory difficulty and collapse. A typical anaphylactic reaction results in acute respiratory distress or circulatory collapse. Obstruction of the upper airway can be caused by pharyngeal or laryngeal edema; of the lower airway, by bronchospasm with contraction of the smooth muscle of the lungs, vasodilatation and increased capillary permeability. Cardiac arrest may be caused by respiratory failure.

In anaphylactic deaths, the onset of symptoms is usually immediate or within the first 15-20 min. Beyond that time, one would need a well-documented medical history of gradually developing symptoms to implicate an anaphylactic reaction, e.g. the development of itching or wheals and flares. Death usually occurs within 1-2 h.

Table 8.3: Sequential pathologic changes in MI

S.No.	Duration	Gross changes	Microscopic changes
1.	0-6 h	No change; TTC test negative	No change; stretching and waviness of fibres
2.	6-12 h	No change or slight pallor	Coagulative necrosis and neutrophilic infiltration begins, minimal hemorrhage
3.	12-24 h	Slight pallor or mottling	Continuing coagulation necrosis, 'contraction band' necrosis at the periphery of the infarct, neutrophilic infiltrate
4.	24-72 h	Pallor, hyperemic or alternate bands of red and pale areas—'tigroid appearance'	Complete coagulation necrosis of myofibres; neutrophilic infiltrate well developed with early fragmentation of neutrophil nuclei
5.	4-7 days	Central pallor with hyperemic border, soft	Macrophages appear, disintegration and phagocytosis of necrotic fibres, granulation tissue visible at edge of infarct
6.	10 days	Maximally yellow, soft, shrunken, purple periphery	Well developed phagocytosis, prominent granulation tissue in peripheral areas of infarct, pigmented macrophages, eosinophils, lymphocytes and plasma cells present
7.	4-6 weeks	Thin, gray-white, hard, shrunken fibrous scar	Increased fibrocollagenic tissue, decreased vascularity, fewer pigmented macrophages, lymphocytes and plasma cells

Vagal Inhibition (Vasovagal Shock/Reflex Cardiac Arrest/Nervous Apoplexy)

- Sudden death occurring within seconds or minutes as a result of minor trauma or harmless peripheral stimulation may be caused by vagal inhibition.
- Pressure on the baroreceptors situated in the carotid sinuses, carotid sheaths and the carotid body (located in the internal carotid artery and situated near the angle of mandible) causes an increase in blood pressure in these sinuses with resultant slowing of the heart rate, dilatation of blood vessels and fall in blood pressure.
- Some individuals show marked hypersensitivity to stimulation of the carotid sinuses, characterized by bradycardia and cardiac arrhythmias ranging from ventricular arrhythmias to cardiac arrest.

Mechanism: It acts through a reflex arc in which the afferent (sensory) nerve impulses arise in the carotid complex of nerve endings, but not in the vagal nerve trunk itself. These impulses pass through glossopharyngeal nerves to the tenth nucleus in the brainstem, then return through the vagus (efferent) supply to the heart and other organs. This reflex arc acts through the parasympathetic autonomic nervous system and is

independent of the main motor and sensory nerve pathways. Afferent fibres are present over the skin, pharynx, glottis, pleura, peritoneum and cervix, which pass into the lateral tracts of spinal cord and finally to the brain.

Causes

- Pressure on the carotid sinuses, as in hanging or strangulation.
- Unexpected blow to the larynx, chest, abdomen and genital organs.
- Impaction of food in the larynx or sudden inhalation of fluid into the upper respiratory tract.
- Sudden immersion of body in cold water.
- The insertion of an instrument into the bronchus, uterus, bladder or rectum.
- Puncture of a pleural cavity producing a pneumothorax.
- Sudden evacuation of pathological fluids, e.g. ascitic tap.

Postmortem examination: There are no characteristic postmortem findings. The cause of death can be inferred only by exclusion of other pathological conditions and from the observation of reliable witnesses, history and clinical findings concerning the circumstances of death.

MULTIPLE CHOICE QUESTIONS

- Study of death in all its aspects is known as:** *AIIMS 08*
 A. Eugenics B. Thanatology
 C. Dactylography D. Tricology
- True about somatic death are all, except:** *PGI 03*
 A. Cooling of the body
 B. Cessation of spontaneous respiration
 C. Cessation of circulation
 D. Flat isoelectric EEG
- Molecular death is:** *PGI 10; Kerala 11*
 A. Complete and irreversible cessation of brain, heart and lungs function
 B. Death of individual tissues and cells after somatic death
 C. Total loss of EEG activity, but heart is functioning
 D. Vitals functions are at low pitch that cannot be detected by clinical examination
- NOT important in brain death:** *PGI 07*
 A. EEG
 B. ECG
 C. Absence of brainstem reflex
 D. Body temperature
- Brainstem dead are all, except:** *JIPMER 08*
 A. Weaned off from ventilator, no respiration for 15 secs
 B. Absent pupillary response
 C. Absent nystagmus
 D. Absent corneal reflex
- All the following are found in brain dead patients, except:** *NIMHANS 07; Karnataka 11*
 A. Decreased deep tendon reflex
 B. Absent pupillary reflexes
 C. Complete apnea
 D. Heart unresponsive to atropine
- A woman with infertility receives an ovary transplant from her sister who is an identical twin. Type of graft is:** *AI 05*
 A. Xenograft B. Autograft
 C. Allograft D. Isograft
- Xenograft is transplantation of tissue:** *FMGE 10*
 A. From a different species
 B. From same species
 C. From genetically identical twins
 D. From one part of body to another

1. B

2. A

3. B

4. B

5. A

6. A

7. D

8. A

9. Agonal period is the duration between: *Maharashtra 08*
- Traumatic event and information given to the relatives
 - Traumatic event and starting of the operation
 - Lethal trauma upto death
 - Death and postmortem examination
10. An old lady with mitral stenosis underwent hysterectomy for uterine fibroid and died after developing pulmonary edema. The order of cause of death in international certificate is: *NIMS 11*
- Mitral stenosis, pulmonary edema, hysterectomy
 - Pulmonary edema, mitral stenosis, hysterectomy
 - Pulmonary edema, hysterectomy, mitral stenosis
 - Hysterectomy, pulmonary edema, mitral stenosis
11. Gordon's clarification of death signifies: *Orissa 11*
- Mechanism of death
 - Causes of death
 - Modes of death
 - Manner of death
12. Diffusion of oxygen at the tissue level is affected in all the following poisonings, except: *AIIMS 05*
- Carbon monoxide
 - Curare
 - Phosgene
 - Cyanides
13. Cyanide poisoning causes: *AFMC 10*
- Histotoxic anoxia
 - Anoxic anoxia
 - Anemic anoxia
 - Stagnant anoxia
14. All the statements regarding atherosclerosis are true, except: *AP 10; SGPGI 11*
- Naked eye changes are not visible for the first 12 hours
 - Triphenyl tetrazolium chloride can help in detecting infarcted area
 - Most commonly involves the left coronary artery
 - Common site is the anterior wall of right ventricle

Signs of Death

9

The changes which occur after death are helpful in estimation of the approximate time of death and to differentiate death from suspended animation. It can be classified into: (Table 9.1)

- Immediate changes
- Early changes
- Late changes.

Immediate Changes (Somatic Death)

a. Irreversible cessation of the function of brain including brainstem:

This is earliest sign of death with stoppage of functions of the nervous system. There is insensibility and loss of both sensory and motor functions. There is loss of reflexes, no response and no tonicity of the muscles. Pupils are widely dilated. This condition is sometimes seen in:

- Prolonged fainting attack
- Vagal inhibitory phenomenon
- Epilepsy, mesmeric trance, catalepsy, narcosis, electrocution.

b. Irreversible cessation of respiration:

Complete stoppage of respiration for > 4 min usually causes death. The stoppage of respiration can be established by the following tests:

- i. *Inspection*: No visible respiratory movement.
- ii. *Palpation*: No respiratory movement can be felt.
- iii. *Auscultation*: Breath sounds cannot be heard from any part of the lungs.

iv. Feather test, mirror test and Winslow's test are no longer utilized.

Respiration may stop briefly without death as in:

- Voluntary breath holding
- Drowning
- Cheyne-Stokes respiration
- Newborns.

c. Irreversible cessation of circulation:

Stoppage of heart beat for > 3-5 min is irrecoverable and results in death. The following tests may be performed to test circulation:

- i. Radial, brachial, femoral and carotid pulsations will be absent, if the circulation has stopped.
- ii. *Auscultation of heart*: Absence of the heart beat over the whole precordial area and particularly over the area of the apex.
- iii. *ECG*: In case of cessation of circulation, the ECG curve is absent and the tracing shows a flat line without any elevation or depression.
- iv. *Other tests*: Various tests, like diaphanous, magnus, I-card, pressure, cut and heat tests are now obsolete.²

Tests to detect stoppage of respiration (obsolete)

- *Winslow's test*: No movement of reflection of light shone on mirror or surface of water in bowl kept on the chest.^{3,4}
- *Feather test*: No movement is seen, if a feather or fine cotton fibres are held before the nostrils.
- *Mirror test*: No haziness is seen on the reflecting surface of the mirror held in front of mouth and nostrils.

Table 9.1: Changes after death

Immediate changes ¹	Early changes ²	Late changes
Irreversible cessation of: <ul style="list-style-type: none"> • Function of brain • Circulation • Respiration 	<ul style="list-style-type: none"> • Loss of elasticity of the skin, and facial pallor • Primary relaxation of the muscles • Contact pallor and flattening • Changes in the eye • Algor mortis • Livor mortis • Rigor mortis 	<ul style="list-style-type: none"> • Putrefaction • Adipocere formation • Mummification

Tests to detect stoppage of circulation (obsolete)³

- *Magnus test (ligature test)*: Fingers fail to show bluish discoloration and edema to a ligature applied at their base.
- *Diaphanous test (transillumination test)*: Failure to show redness in the web-space between the fingers on transillumination from behind.
- *I card's test*: Fluorescein dye on being injected at a given site in a dead body fail to produce yellowish-green discoloration as seen in a living person.
- *Pressure test*: Fingernails appear pale and fail to show reddish color on removal of firm pressure over it.

Suspended Animation (Apparent Death)

Definition: It is a condition in which vital signs of life (heart beat and respiration) are not detected by routine clinical methods as the functions are interrupted for some time or are reduced to a minimum.⁵

Mechanism: The metabolic rate is greatly reduced so that the requirement of the individual cell for oxygen is satisfied through the dissolved oxygen in body fluids.

Types

Two types:

- Voluntary*: Seen in practitioners of yoga or in trance.⁵
- Involuntary*: Seen in freezing of body, poisoning with barbiturates or opiates, newborns, drowning, electrocution, heatstroke, cholera, postanesthesia, shock, cerebral concussion or insanity.^{6,7}

The patient can be resuscitated by cardiac massage or electric stimulator and artificial respiration. The death certificate should not be issued without an ECG or EEG record.

Early Changes (Molecular Death)

- Changes in the skin and facial pallor:** Skin becomes pale and ash-white due to stoppage of circulation and drainage of blood from the capillaries and the small vessels. The skin loses its elasticity and the face looks younger due to loss of creases. The lips appear brownish, dry and hard due to drying.
- Primary relaxation or flaccidity of the muscles:** Muscles loose their tonicity and become flaccid, but the muscular tissues are still alive, their chemical reaction is alkaline and responds to electrical stimuli.
- Contact flattening and pallor:** The areas which remain in contact with the ground, become flat and the blood from vessels of these areas is pressed out, this continues even after the formation of postmortem staining over the surrounding areas.

iv. Changes in the eye

- *Loss of corneal and pupillary reflexes:* It may be seen in all cases of deep insensibility and therefore is not a reliable sign of death. However, the pupils react for sometime to myotic and mydriatic agents.
- *Pupils:* The pupils are dilated after death, because of the relaxation of muscles of the iris. Later, they are constricted with the onset of rigor mortis of the constrictor muscles and evaporation of fluid. As such, their state after death is not an indication of their antemortem appearance.
- *Shape of the pupils:* Pupils are circular during life, but due to loss of tone and elasticity of the ciliary muscles after death, the shape of the pupil can be changed and the change may persist during the stage of rigor mortis of the muscles. Moreover, the sizes and shapes of the pupils of the two sides may be different.
- *Opacity of the cornea:* There is opacity and haziness of the cornea due to drying and deposition of dust and debris over it. This may be delayed, if the lids are closed after death. If the lids are closed, the cornea remains clear for about 2 h. This haziness is transient and passes off, if a drop of water is poured on the cornea. But the cornea becomes permanently hazy after about 10-12 h of death due to decomposition.
- *Tache noire (French, black line):* If the eyelids remain open for 3-4 h after death, there is formation of two yellow triangles (base on the limbus, apex at the lateral or medial canthus and sides are formed by the margins of the upper and lower eyelids) on the sclera at each side of the iris, which become brown and then black.⁸

Cause: Drying/desiccation and deposition of cellular debris, mucus and dust on the exposed conjunctiva and the sclera underneath.

- *Loss of intraocular tension:* Intraocular tension falls rapidly after death. It becomes zero in 4-8 h from 10-22 mm Hg during life. The eyeballs look sunken in the orbit.
- *Changes in the retina:* The blood in retinal vessels appears fragmented or segmented (**cattle trucking or shunting**) within seconds to minutes after death, and persists for about an hour (**Kevorkian sign**). This occurs all over the body due to loss of blood pressure, but it can be seen only in retina by an *ophthalmoscope*.

The retina is pale for the initial 2 h and the area around the disc look yellowish. At about

6 h, the disk outline is hazy and becomes blurred in 7-10 h. By 12 h, the area for the disc can be known only by some convergent segmented vessels.

- *Vitreous potassium and hypoxanthine*: Steady rise in the values are seen after death.

Changes in the eye other than those in the *retina* and *vitreous humor* are less important for the purpose of estimation of time of death.

Cooling of the Dead Body

- It is also called *algor mortis* (Latin *algor*: coolness, *mortis*: death) or chill of death.⁹
- Algor mortis is usually the first sign of death beyond the obvious, and is then followed by rigor mortis.
- Sometime after death, the body temperature of the cadaver falls and after some hours, it tends to be equal to the temperature of its immediate environment. The surface (outer) temperature falls more rapidly for some time than the inner core temperature.
- The fall of temperature of the cadaver occurs due to cessation of energy production and inactivity of the heat regulating centre after somatic death.
- Loss of the body heat occurs by conduction, radiation and evaporation when the body is in the atmospheric environment, and by conduction and convection when the body is in water.
- The curve of cooling pattern is *sigmoid, biexponential or inverted 'S' shaped*.
 - Initial plateau (*isothermic phase*) indicates that there is no loss of heat or fall of the inner core (rectal) temperature for the first 1-2 h. This is due to the thickness of the skin and the subcutaneous tissue which are good insulators of heat.
 - Some hours after death, the fall of temperature at the inner core of the body achieves a regular, linear and constant pattern (*intermediate phase*).
 - Then, it gradually becomes slow as the temperature of the environment is reached. The last part of the curve (*terminal phase*) is slightly above the base line which is indicative of bacterial activity (Fig. 9.1).
- For the purpose of estimation of time passed after death, the measurement of the inner core temperature is important and is more reliable than the outer surface temperature.
- Site of the body used to record the inner core temperature:

- Rectum (8-10 cm above anus)¹⁰
- External auditory meatus
- Subhepatic (inferior surface of liver)
- Nostrils upto cribriform plate
- Intracerebral (through the orbit)

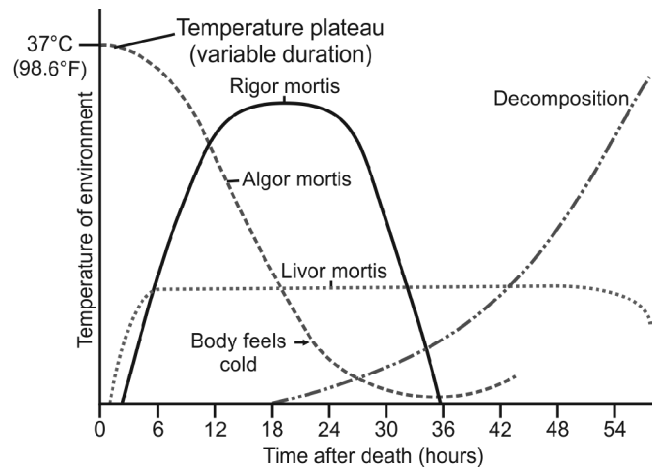

Fig. 9.1: Estimation of time since death
(For color version see Plate 2)

Methods for measurement of core temperature:

Chemical (not clinical) thermometer 10-12 inches long with graduation ranging from 0-50°C is required. Alternatively, a thermocouple probe may be used and this has the advantage of a digital readout or a printed record.

For measurement of the temperature, the bulb of the thermometer is introduced inside the rectum (*except in sodomy*), at least 10 cm above the anus. Temperature can also be recorded by making an incision in the peritoneal cavity and inserting the thermometer against the inferior surface the liver. The time and temperature of the environment is also recorded. Reading should be made at intervals, in order to obtain the rate of fall of temperature.

- The use of this method is practical in cool and temperate climates, because in tropical countries (like in India) there may be a minimal fall in body temperature postmortem and in deserts the body temperature may even rise after death.
- The average rate of fall of the body temperature is 0.4-0.7°C/h and the body attains environmental temperature in 16-20 h after death.¹¹
- It is assumed that the body temperature at the time of death was normal which varies between 35.7-37.7°C orally and 36.7-37.5°C in the rectum (in males).
- A rough estimate of time since death (TSD) is obtained by the formula:

$$\text{TSD (in hours)} =$$

$$\frac{\text{Normal rectal temperature} - \text{Measured rectal temperature}}{\text{Rate of fall of temperature/hour}}$$

- For *temperate countries*, Marshal and Hore formula is used. The rates of fall of temperature in an average built person is 1°F upto 3 h, 2°F upto 9 h and 1.5°F

upto 12 h. The *rule of thumb* is that the temperature falls at about 1.5°F/h.

- Rectal temperature is higher in case of struggle or exercise prior to death.
- Low temperature is seen in congestive cardiac failure, hemorrhage, collapse and secondary shock.

Various equations, algorithms and nomograms using rectal temperature have been developed. Examples of simple rule-of-thumb formulae (for temperate countries):

- $TSD = (\text{Rectal temperature at time of death} - \text{measured rectal temperature } [^{\circ}\text{F}]) \div 1.5$
 - $TSD = (\text{Rectal temperature at time of death} - \text{measured rectal temperature } [^{\circ}\text{C}]) + 3^*$
- (*Compensatory number for possible initial delay in cooling of the body)

Presently, **nomogram method** devised by *Henssge* is used. This method is based on experimental data which can be carried out by a simple computer program or by a nomogram. Adjustments are built in for the body weight, ambient temperature and body temperature. It provides a 95% accuracy of estimating the TSD during the first 15 h (with an error of ± 2.8 h).

Factors Affecting Algor Mortis

- i. **Environmental temperature** (*major factor*): Rate of fall of body temperature is directly proportional to the difference between the temperature of the dead body and the environmental temperature.
- ii. **Air movement**: Air movement over the surface of the dead body causes a quick fall of temperature due to increased evaporation of body fluids. A body kept in a well-ventilated room will cool more rapidly than one in a closed room.
- iii. **Humidity**: Cooling is more rapid in a humid rather than in a dry atmosphere since moist air is better conductor of heat.
- iv. **Media of disposal**: Cooling is earliest in water and late in buried bodies. The ratio of the rates of fall of temperature in the three media, water: air: soil = 4: 2: 1. The rate is thus maximum in water, moderate in air and minimum in a buried body.
- v. **Built of cadaver**: Obese bodies cool slowly and lean bodies rapidly, since fat is a bad conductor of heat.
- vi. **Age and sex**: Rate of loss of heat is more in children and the elderly, compared to adults, because the surface area of the body is more in relation to the body volume. Females retain body heat for a comparatively longer period because of their subcutaneous fatty tissue.

- vii. **Clothing or coverings of the body**: A well-covered body retains heat for a longer period as compared to a naked or thinly clothed body, as clothes are bad conductors of heat.
- viii. **Position and posture of the body**: If the body lies in supine and extended position, the loss of heat is rapid because greater surface area of the body is exposed; whereas in curled fetal position, the loss will be slow.
- ix. **Mode of death**: In case of sudden death in a healthy individual, the body tends to cool slowly, whereas in death due to long and wasting illness, the body cools rapidly.

Postmortem Caloricity

In this condition, instead of cooling, the temperature of the dead body remains high for the initial 2 h or so. This is due to:

- i. **Postmortem glycogenolysis**: Compulsory phenomenon which occurs in all dead bodies and which starts soon after death (produces upto 140 calories).
- ii. **Cause of death**:^{12,13}
 - In deaths occurring due to infectious diseases, septicemia or bacteremia, heat is produced by the action of the infective organisms.
 - If death is preceded by a severe convulsion, as in tetanus and strychnine poisoning, it causes an increase in the body temperature.
 - In case of death due to heat stroke or pontine hemorrhage, the heat regulation is severely disturbed before death.
- iii. **High environmental temperature**: In tropical countries, when the environmental temperature is higher than the body temperature, the dead body may absorb some heat.

Medico-legal Importance of Algor Mortis

- i. It is a sign of death.
- ii. It helps in the estimation of the time of death.
- iii. Rapid cooling of a dead body delays the processes of rigor mortis and decomposition. If the heat is preserved for a longer period, then both the processes start early.

Postmortem Staining

[*Synonyms*: Hypostasis, livor mortis, vibices, suggilation, postmortem or cadaveric lividity, darkening of death]

Definition: Postmortem staining or PM staining is bluish or purplish-red discoloration resulting from gravitational settling of blood in the toneless capillaries and venules of the dependant parts of the dead body. It is present at the undersurface of skin in the superficial layers of the dermis.

Cause: After the stoppage of circulation, there is stagnation of blood in the vessels and it tends to sink by force of gravity in the capillaries and venules of the dependent parts of the body.

- The upper portions of the body drained of blood are pale.
- The intensity of the color depends upon the amount of reduced hemoglobin in the blood.
- It is not possible to distinguish postmortem lividity from cyanosis seen in the living. Therefore, one should not use cyanosis to describe postmortem appearances.

Development of PM Staining

In early stages (30 min to 1 h), it consists of discolored patches on the dependant parts of the body of 1-2 cm in diameter, having the same color as blood which can be mistaken for bruises. Gradually, in 3-4 h, the small patches increase in size and coalesce with each other to form uniformly stained large areas. It is usually well-developed within 4 h, complete in 5-6 h.

- When lividity is developing, pressing the end of a finger against the skin for a few seconds will cause blanching. When the pressure is released, lividity will reappear.
- It begins immediately after death, but it may not be visible for about half to 1 h in normal individuals.
- It is present in all bodies, but is more clearly seen in bodies of fair skinned people than in dark skinned ones. It may not be appreciated in old and anemic persons.

Fixation of PM Staining

- After complete formation of the postmortem staining, if the body is undisturbed, the staining gets 'fixed' in 8-12 h and persists until putrefaction sets in (Fig. 9.1).¹⁴ At this stage, lividity does not disappear, if finger is firmly pressed against the skin.
- If the position of the body is altered after fixation, the staining will not be changed and will remain as such, though the color may fade slightly in intensity.
- Fixation occurs earlier in summer and is delayed in asphyxial deaths and in intracranial lesions.
- It is thought to be due to intravascular coagulation of the settled blood and blood leaking through the permeable vessels (as a result of decomposition). But practically, very little clotting of the blood is seen in the small veins and capillaries during postmortem examination.

Distribution of PM Staining

- It depends on the position of the body.
- In a body *lying supine*, it appears in the neck, and then spreads over the entire back with the exception of the areas directly pressed on the ground or the bed, i.e.

occipital area, shoulder blades, buttocks, posterior aspects of thighs, calves and heels which do not show any staining and appear rather pale (Fig. 9.2). This phenomenon is known as **contact pallor**. The vessels in these areas remain pressurized and the blood is compressed out. Similarly, any pressure that prevents the capillary filling, such as the collar band, waist bands, belts or wrinkles in the clothes remain free from color and are seen as stripes or bands called *vibices*. Such pale areas may be mistaken for marks due to beating or strangulation, if they are seen on the neck.

- If the body is *lying prone*, as in drunken persons, intense lividity is seen in front and Tardieu's spots are common. The eyes may suffuse and numerous hemorrhages may appear in the conjunctivae. This may give rise to suspicion of suffocation or strangulation.
- If the body has been *lying on one side*, the blood will settle on that side.
- If the body has been *suspended vertically*, as in hanging, postmortem staining will be most marked in the legs, external genitalia, lower parts of forearms and hands, upper margin of the ligature mark on the neck. In case of prolonged suspension, petechial hemorrhages are seen in the skin.
- When the body remains *submerged in water*, as in drowning, the head being the heaviest assumes a lower level in comparison with the rest of the body and the staining is usually found on the face, the upper part of the chest, hands, lower arms, feet and the calves, as they are the dependent parts. If the body is in flowing water and constantly changing its position, staining may not develop.¹⁵

Fate of PM Staining

- It merges with putrefactive changes.¹⁶
- Initially, there is hemolysis of blood and diffusion of blood pigment into the surrounding tissues where it undergoes secondary changes. Later, as decomposition progresses, the staining becomes dark in color and turns brown and green, before disappearing with destruction of blood.

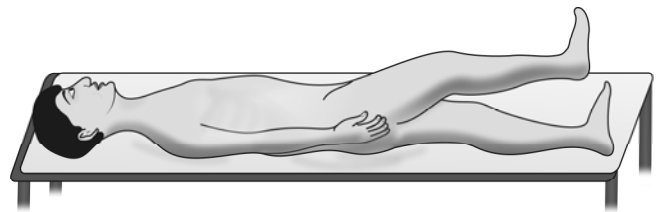

Fig. 9.2: Postmortem staining in dependent parts
(For color version see Plate 2)

- In mummification, staining becomes brown to black with drying of the body.

Features Related to PM Staining

- PM staining also occurs at the dependant parts of all the internal organs. Hypostasis in the heart can simulate myocardial infarction; in the lungs it may suggest pneumonia; dependent coils of intestine appear strangulated.
- The areas of contact pallor are similar to the areas of contact flattening.
- If there has been excessive loss of blood during or before death or in severely anemic individuals, postmortem staining may not be appreciable. It may not be appreciable in death from wasting diseases and lobar pneumonia.
- Congestion, resembling postmortem staining may be seen few hours before death in case of a person dying slowly with circulatory failure, e.g. cholera, typhus, tuberculosis, uremia, morphine and barbiturate poisoning, congestive cardiac failure, deep coma, and asphyxia.
- **Recent methods** to determine time since death from postmortem staining is known as *calorimetry*, which shows an increasing pallor of the hypostasis during the first 24 h.

Color of PM staining: The normal color of the post-mortem staining is either bluish or purplish red. But in some specific causes of death, the color of the post-

mortem staining may be different, as given in Table 9.2. (color changes seen in different poisoning is given in Chapter 36).

Medico-legal Importance of PM Staining

- It is a sign of death.
- The time since death can be roughly estimated from the formation, extension and fixation of the post-mortem staining.¹⁷
- It indicates the posture of the body at the time of death.¹⁷
- It may indicate the moving of the body to another position sometime after death.¹⁷
- Cause of death may be judged from the *distribution and color* of postmortem staining.
- In the early phase of its formation, it may be confused with bruise when patchy and small (Diff. 9.1).
- It may be confused with congestion of the organs, particularly of the internal organs (Diff. 9.2).

Table 9.2: Color of PM staining and cause of death

Cause	Color
Asphyxia	Deep bluish-violet
<i>C. perfringens</i> septicemia	Pale bronze
Hypothermia, drowning, refrigerated bodies	Pink*
Mummified bodies	Brown to black

* Wet skin allows atmospheric oxygen to pass through, and at low temperatures hemoglobin has a greater affinity for oxygen

Differentiation 9.1: PM staining and bruise¹⁸

S.No.	Feature	PM staining	Bruise
1.	Situation	On the dependant parts	Anywhere
2.	Tissue level	Undersurface of the skin	Subcutaneous tissue level
3.	Surface	Not elevated	May be slightly elevated
4.	Margin	Sharp and clearly defined	Diffuse
5.	Color	Bluish or purplish red	Reddish when fresh, change in color occurs with time
6.	Cause	Capillo-venous distension with blood	Extravasation of blood from capillaries
7.	Nature of change	Postmortem	Antemortem
8.	Effect of pressure	Pressed spot appears pale	No change
9.	Cut section	Oozing of blood from the vessels which can be cleaned by washing	Hemorrhage in the tissue which cannot be washed
10.	Microscopically	Engorgement of capillaries infiltration	Extravasation of blood, cellular infiltration
11.	Enzymatic study	No change	Change in the level of certain enzymes
12.	Medico-legal importance	Time of death and position of the body may be known	Nature of injury and weapon used may be known

Differentiation 9.2: Congestion and PM staining

S.No.	Feature	Congestion	PM staining
1.	Situation	Uniform, all over the organ	Irregular and in dependant parts
2.	Exudate	Exudate may be seen	No inflammatory exudate
3.	Mucous membranes	Normal	Dull and lusterless
4.	Swelling or edema	May be seen	None
5.	Hollow viscus	Uniform staining	Stomach and intestine when stretched show alternate areas of discoloration and pallor
6.	Cause	Due to some pathology in the organ	Passive capillo-venous distension
7.	Nature of change	Antemortem	Postmortem

- viii. Hemorrhagic spots on skin due to blood dyscrasias may be mistaken for postmortem staining.
- ix. Some extraneous color or stain may be mistaken for postmortem staining; however these can be easily wiped or rubbed off or washed out.

Rigor Mortis

Definition: *Rigor mortis* (Latin, stiffness of death) is that state of the muscles in a dead body when they become stiff or rigid with some degree of shortening.

The phase of primary relaxation of the muscles continues for about an hour which is followed by stiffening or rigidity. It indicates molecular death of the concerned muscles.

Mechanism: Muscle fibres contain bundles of myofibrils which consist of two types of protein filaments, actin and myosin. At rest, actin filaments interdigitate myosin filaments only to a small extent and the muscle fibres also appear soft and supple. Maintenance of this condition of muscles is due to the presence of ATP (adenosine-triphosphate) above a certain level. On nervous stimulation, hydrolysis of ATP occurs to ADP (adenosine-diphosphate) and phosphate with the liberation of energy which causes contraction of the muscle fibres and extension of the actin filaments more inside the myosin filaments.

After death, there is continuous hydrolysis of the ATP and as long as glycogen is available in the muscle, there is re-synthesis of ATP. In this process, once the muscle glycogen is exhausted, no further re-synthesis of ATP is possible and the muscle loses softness, elasticity and extensibility due to formation of viscid **actomyosin complex** giving rise to rigor mortis in the muscle (Fig. 9.3).

After the pH of the muscle becomes 5.5, release of autolytic enzymes stored in lysosomes takes place. The

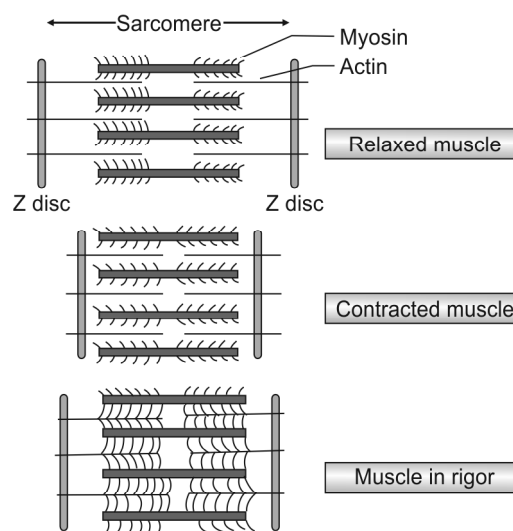

Fig. 9.3: Schematic representation of rigor mortis

major proteolytic enzymes are cathepsins and calpains. These enzymes act at the myofibrillar proteins and hydrolyze them. As a result, the actomyosin complex is broken down and muscles become 'soft' again. This is known as *resolution of rigor* which occurs during the stage of secondary relaxation, due to decomposition.

Muscles involved: Rigor mortis occurs both in the *voluntary and involuntary muscles*. It occurs earlier in the involuntary or smooth muscles than in the voluntary or striated muscles.

Onset and Duration

In tropical countries like India, roughly, it commences in 1-2 h after death, takes about 9-12 h to develop from head to foot, persists for another 12 h and takes 12 h to pass off (**Rule of 12**) (Fig. 9.1).^{19,20} In Northern India, the usual duration of rigor mortis is 18-36 h in summer and 24-48 h in winter.

Order of Appearance

- Rigor mortis first appears in the heart muscle within an hour after death.²¹
- Among the voluntary muscles, rigor mortis usually develops sequentially and follows a descending pattern, the so-called *Nysten's law*: it first appears in the muscles of the eye lids (orbicularis oculi) [3-5 h],²² then in jaw, facial muscles [4-5 h], neck, thorax [5-7 h] upper limb (from shoulder to the hand) [7-9 h], abdomen, lower limb (from the hip to the foot) [9-11 h], and lastly in the small muscles of fingers and toes [11-12 h].
- The rigidity disappears in the same order in which it has appeared. In the whole body, it stays for maximum duration in the muscles of the lower limbs.
- When rigor is fully established, the entire body is stiff; knees, hips, shoulders and elbows are slightly flexed and fingers and toes often show a marked degree of flexion.
- It is independent of the integrity of the nervous system, though it is said to develop more slowly in paralyzed limbs.

Nysten's law: Rigor mortis affects first the muscles of jaw, followed by those of the face and neck, then muscles of the trunk and arms, and lastly the legs and feet.

Testing of rigor mortis: It is tested by lifting the eyelids, depressing the jaw, and gently bending the neck and various joints of the body (Table 9.3 and Fig. 9.4). When rigor is developing and the extremities are moved (if death occurred < 8-12 h before), the rigor fixes the extremities in their new position. The rigidity will be less than in other symmetrical groups which have not been disturbed.

Breaking of rigor mortis: If rigidity is complete and rigor is broken by mechanical force, e.g. if a limb in rigor is flexed forcibly at a joint, the limb becomes flaccid and will remain so thereafter. Rigor mortis may be broken down partially due to mishandling during the transit of the body from the scene of crime to autopsy table, which

may misled the autopsy surgeon in estimating the time since death.

Effects of rigor mortis

- There is goose skin appearance of the body due to rigor mortis of the erector pilae muscles.
- Rigor in the muscles of the seminal vesicles may cause postmortem ejaculation of seminal fluid.
- Contraction of the heart muscle due to rigor mortis should not be mistaken for myocardial hypertrophy.
- Rigor mortis in the uterine muscle cannot expel the fetus from the womb.

Factors Affecting Rigor Mortis

The two major factors that influence the onset and duration of rigor mortis are the environmental temperature and the degree of muscular activity before death.

- Environmental temperature:** At high temperature, rigor mortis comes early and passes off early. In cold temperature, it comes late and stays longer.
- Muscular activity:** Violent exercise prior to death may hasten the onset as well as disappearance of rigidity.
- Mode of death** (Table 9.4).
- Built:** It comes early and passes off early in thinly built subjects with weak musculature. In well-built subjects with strong musculature, it comes late and stays longer.
- Age:** Rigor mortis does not develop in a fetus of < 7 months of intrauterine age. It is moderate in children, emaciated and in elderly people.

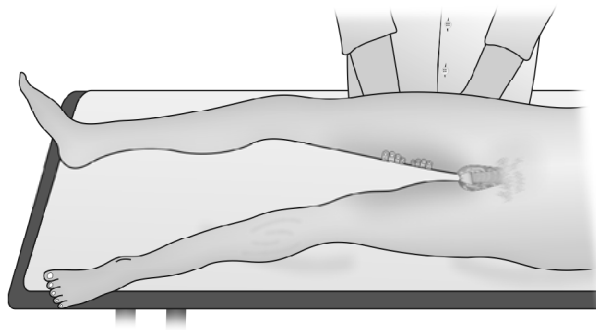

Fig. 9.4: Testing of rigor mortis

Table 9.3: Interpretation of rigor mortis

Perception	Interpretation
<ul style="list-style-type: none"> • Moves with little force • Moves with more force • Free movement or not present in the part tested <ul style="list-style-type: none"> – If only proximal parts show rigidity – If only distal parts show rigidity 	<ul style="list-style-type: none"> Present in moderate form Present in strong form Not developed yet or disappeared Developing phase Developed, disappearing phase

Table 9.4: Mode of death affecting rigor mortis

Early onset of rigor	Late onset of rigor
<ul style="list-style-type: none"> Exhaustive or wasting diseases, like cholera, typhoid, tuberculosis, cancer Violent deaths, like cut-throat, electrocution, firearm and lightning injuries Poisoning with strychnine, organophosphate, insulin or HCN Fatigue or exhaustion Heat stroke 	<ul style="list-style-type: none"> Asphyxia (CO, hanging) Hemorrhage Cold, refrigerated bodies Paralyzed muscles Pneumonia

Medico-legal Importance of Rigor Mortis

- It is a sign of death and indicates molecular death of the muscle involved.
- During the early phase after death, it helps in estimating the time since death. During summer, if rigor mortis has not set in, death might have occurred within 2 h. If rigor mortis has involved the whole body then death might have occurred between 12-24 h back. In winter season, the above timings are roughly doubled.
- It indicates the position of the body at the time of death. For example, if the body is lying on its back with its lower limbs raised in air, it indicates that the body reached full rigidity elsewhere while lying in a position where the legs were flexed.
- Some conditions occur in dead bodies which may imitate/ simulate rigor mortis.*²³
 - Cadaveric spasm or instantaneous rigor
 - Heat stiffening
 - Cold stiffening
 - Gas stiffening or putrefaction.

Cadaveric Spasm (Instantaneous Rigor/Rigidity, Cataleptic Rigidity)

Definition: It is a condition in which the muscles of the body which were in a state of contraction immediately before death, continue to be so after death without passing through the stage of primary relaxation.^{24,25}

Predisposing conditions: It occurs especially in cases of sudden death, excitement, fear, severe pain, exhaustion, cerebral hemorrhage, electrocution, injury to the nervous system, firearm wound of the head and convulsant poisons, like strychnine.

Muscles involved: The spasm is primarily a vital phenomenon; it originates by normal nervous stimulation of the muscles.

- It is usually limited to a single group of voluntary muscles and frequently involves the hands.
- Occasionally, the whole body is affected, as seen in soldiers shot in battlefield when the body may retain the posture which it assumed at the moment of death.

No other condition simulates cadaveric spasm. A great force is required to overcome this stiffness. It passes without interruption into normal rigor mortis and disappears when rigor disappears.

Mechanism: It is unclear but may be neurogenic. It may be due to exhausted ATP in the affected muscles with persistence of contraction even after death and the resultant failure of the chemical processes required for active muscular relaxation to occur during molecular death. Adrenocortical exhaustion, which impairs resynthesis of ATP may be the possible cause.

Differentiating features between rigor mortis and cadaveric spasm is highlighted in Diff. 9.3.

Medico-legal Importance

Cadaveric spasm, being an antemortem phenomenon, reflects the last act of the subject performed before and at the time of his death. The *cause and the manner of death* may be judged.

- In case of drowning*, the hand may firmly grip sand, mud, gravel or weed which are present in the pond or lake from where the body was recovered.
- In a case of firearm/stab injury* over an approachable vital part of the body, the pistol/knife may be firmly grasped in the victim's hand which is a strong presumptive evidence of suicide. Although, attempts may be made to simulate this condition in order to conceal murder. But rigor does not produce the same firm grip of a weapon.
- In homicidal cases*, the deceased may grasp some part of clothing, button, foreign hair of the assailant(s) with whom he had a struggle prior to his death.

Heat Stiffening

If the body is subjected to exposure at $> 65^{\circ}\text{C}$, rigidity is produced which is much more marked than that found in rigor mortis. There will be coagulation of the muscle protein in which the flexors are affected more, giving rise to a *pugilistic attitude* of the body. The muscles are contracted, desiccated or even carbonized on the surface. A zone of brownish-pink 'cooked meat' is seen under this, overlying normal red muscle. The stiffening remains

until the muscles and ligaments soften from decomposition and the normal rigor mortis does not occur.

Differentiating features between rigor mortis and heat stiffening is given in Diff. 9.4.

Cold Stiffening

This is seen when a body is exposed to freezing temperatures for a reasonable period, the tissues becoming frozen and stiff, simulating rigor.

It occurs due to:

- Freezing of body fluids, particularly at the tissue level and in the synovial sacs of the joints.
- Hardening of the subcutaneous fatty tissue.

Differentiating features between rigor mortis and heat stiffening is given in Diff. 9.5.

Gas stiffening occurs during putrefaction due to accumulation of gases in the tissues which causes false rigidity resulting in stiff limbs and is very obvious from the discoloration, swelling and foul smell.

Secondary Relaxation of Muscles

- After some hours of stay, rigor mortis passes away and the body becomes relaxed or flaccid for the second time. This is secondary relaxation or secondary flaccidity of the muscles. It occurs only with the onset of decomposition or putrefaction of the dead body (Diff. 9.6).

Differentiation 9.3: Rigor mortis and cadaveric spasm

S.No.	Feature	Rigor mortis	Cadaveric spasm ²⁶
1.	Onset	Within 1-2 h after death	Instantaneous
2.	Production	Freezing and exposure to temperature > 65°C produce rigor	Cannot be produced by any method after death
3.	Mechanism of formation	Break down of ATP below critical level	Not known exactly
4.	Molecular death	Occurs	Does not occur
5.	Muscles involved	All the muscles of the body, both voluntary and involuntary	Usually restricted to selected group of voluntary muscles
6.	Primary flaccidity	Precedes rigor mortis	Not seen
7.	Muscle stiffening	Not marked	Marked
8.	Duration of stay	About 12-24 h	Few hours, until replaced by rigor mortis
9.	Predisposing factor	Nil	Sudden death, excitement, exhaustion, fear, fatigue
10.	Body temperature	Cold	Warm
11.	Muscle reaction	Acidic	Alkaline
12.	Reaction to electrical stimulus	Does not respond	Responds
13.	Medico-legal significance	Indicates time of death	Indicates the cause and manner of death

Differentiation 9.4: Rigor mortis and heat stiffening

S.No.	Feature	Rigor mortis	Heat stiffening
1.	Mechanism	Due to breakdown of ATP of muscles	Due to heat coagulation of muscle protein
2.	Time of formation	2-12 h after death	Can be antemortem or postmortem
3.	Role of heat	High temperature enhances the process	Occur at a temperature > 65°C
4.	Onset	In sequence	Rapid and diffuse
5.	Degree of stiffness	Moderate	High
6.	Mechanical pull at joints	Will revert to rigidity extension (if not fully developed)	Rupture of muscles may occur
7.	External features	Nothing specific	Signs of exposure to heat (burning, blackening, blisters)
8.	Disappearance	In sequence, at various duration	Uniform, with onset of putrefaction

Differentiation 9.5: Rigor mortis and cold stiffening

S.No.	Feature	Rigor mortis	Cold stiffening
1.	Cause	ATP loss	Temperature < 0°C
2.	History	Non-specific	Exposure in ice caves, glaciers
3.	Body fluids	Liquid	Frozen
4.	Manipulation of joints	Will revert to rigidity extension (if not fully developed)	Crackling sound or crepitation is heard
5.	Disappearance	In sequence, at various duration	On thawing it goes and rigor mortis appears

Differentiation 9.6: Primary and secondary relaxation of muscles

S.No.	Feature	Primary relaxation	Secondary relaxation
1.	Time of occurrence	Immediately after death	After rigor mortis passes off
2.	Molecular death	Has not occurred	Has occurred
3.	Response to stimuli	Responds	Does not respond
4.	Body temperature	Near normal	Cold
5.	External features	Nothing specific	Signs of decomposition present

- During this phase, other signs of putrefaction will be there. Apart from those signs, the reaction of the muscles will again be alkaline due to breakdown of protein with liberation and accumulation of ammonia.

Decomposition/Putrefaction

Definition: It is a process by which complex organic body tissue breaks down into simpler inorganic compounds or elements due to the action of saprophytic microorganisms or due to autolysis.

Putrefaction usually follows the disappearance of rigor mortis (Fig. 9.1). During the hot season, it may commence before rigor mortis has completely disappeared from the lower extremities.

After death, the body's protective functions are absent and its defense barrier is lost. Saprophytic microorganisms which cannot invade the body during life, physical and chemical agents which are present in the environment, all act on the dead body. Further, some body chemicals and enzymes which are helpful in different metabolic processes, in the absence of physiological control after death, start acting adversely.

Microorganisms involved: *Clostridium welchii*, *Staphylococcus*, non-hemolytic *Streptococcus*, *diphtheroids*, and *Proteus* are the important ones.

Autolysis ('*auto*': self; '*lysis*': breakdown) refers to the situation where a body's own enzymes are acting on itself, causing tissue and cellular destruction.

- Immediately after death, cell membranes become permeable and break down, with release of cytoplasm containing enzymes.
- The proteolytic, glycolytic and lipolytic action of ferments causes autodigestion and disintegration of organs, and occurs without bacterial influence.
- The *earliest autolytic changes occur* in parenchymatous and glandular tissues and in the brain.
- In adults, such digestion may start before death in cases of intracranial lesions.

Gases produced: H₂S, phosphoretted hydrogen, ammonia, CO₂, CO, mercaptans and methane.

External Signs of Decomposition*Decomposition changes ('4 Ds')*

- **Discoloration:** Greenish discoloration in the lower abdominal quadrants.
- **Distension:** Various gases produced during decomposition permeate into skin, soft tissue and organs which manifests as crepitus and distension.
- **Degradation:** Decomposition causes a loss of anatomic integrity of skin and other tissues such as localized peeling of skin ('skin slippage'), loosening of skin of hands and feet ('degloving') and loosening of hair and nails.
- **Dissolution:** Progressive decomposition leads to liquefaction and disappearance of tissues and organs and eventual skeletonization.

Discoloration: The *first external sign* of decomposition is usually a greenish discoloration *over the right iliac fossa* over the region of the caecum which lies superficially and the contents of the bowel are more fluid and full of

bacteria.²⁷ *C. welchii* are most abundant at the iliocaecal zone of the intestinal tract.

- Internally, this is seen on the undersurface of the liver, where it is in contact with the transverse colon.
- After death, when the tissue barrier is lost, they can invade through the intestinal wall and reach the blood vessels and produce H₂S gas. The gas combines with the hemoglobin of blood and forms sulphmethemoglobin which discolors the vessels and the surrounding tissue.

Onset: In India, this change is seen by about 12 h after death in summer (or even earlier) and by 36-48 h in winter. The discoloration gradually spreads all over the abdomen, external genitalia, face, neck and thorax and lastly on the limbs. In temperate conditions, these changes are seen in 24-48 h after death.

'Marbling' of skin

- The blood vessels provide an important route through which the bacteria can spread with ease throughout the body.
- Their passage is marked by the decomposition of hemoglobin to sulphmethemoglobin in the blood vessels which causes a greenish or reddish-brown staining of the inner walls of the superficial vessels.
- This is seen as linear branching patterns which gives a 'marbled' ('road map') appearance of the skin (Fig. 9.5).
- *Areas where visible:* It appears first in the shoulder, roots of the limbs, thighs, sides of abdomen, chest and neck.
- *Onset:* In summers, 'marbling' is seen in 36-48 h after death.²⁸

Further changes seen are given in Table 9.5.

Postmortem luminescence is usually due to contamination by bacteria, like *Photobacterium fischeri*, the light comes from them and not from putrefying material.

Luminescent fungi, *Armillaria mellea*, are other sources of light.

Skeletonization of the body: Skeletonization of the dead body takes varying time depending on several factors. In buried dead bodies, total skeletonization may take one year. When disposed off carelessly on land or water, skeletonization may occur within a few days to few months. Destruction of bones ordinarily take several years.

Internal Changes due to Putrefaction

The organs composed of muscular tissue and those containing large amount of fibrous tissue resist putrefaction longer than the parenchymatous organs, with the exception of the stomach and intestine, which decompose rapidly because of their contents at the time of death.

Liver softens and becomes flabby in 12-24 h and blisters appear on its surface in 24-36 h. The liver

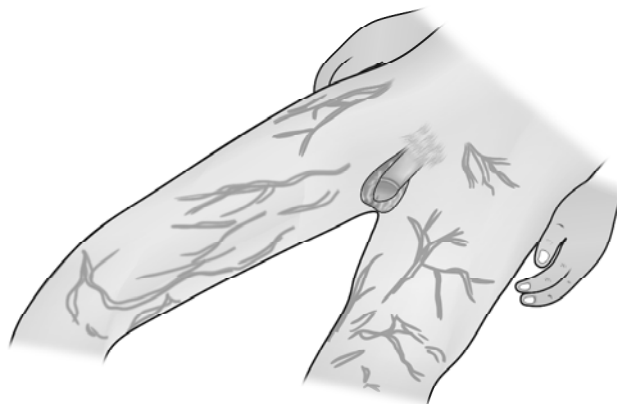

Fig. 9.5: 'Marbling' of the skin of lower limbs
(For color version see Plate 2)

Table 9.5: Putrefactive changes

Duration	Changes
12-24 h	Gas accumulates inside the abdominal cavity making it tense. Blood-tinged froth comes out through the nostrils and mouth (<i>postmortem purge</i>). Eyes become soft and collapsed, cornea becomes white and flattened.
24-48 h	Subcutaneous tissue becomes emphysematous. Breasts in females, scrotum and penis in males are swollen. Tongue is swollen and protruded. Blisters are formed on the lower surfaces of trunk and thigh which contain fluid. Epidermis gets denuded.
48-72 h	There is prolapse of uterus and anus. Postmortem delivery of fetus may take place. Postmortem staining gets displaced from the original stained areas. Eyes protrude. Face is swollen and discolored so that identification is difficult. Hair and nails become loose and may be taken out easily.
3-5 days	Teeth (anterior and premolars) become loose. Skull sutures separate and the liquefied brain matter come out, especially in children. Skin of hands and feet may come off in a 'glove and stocking' manner.
5-10 days	Colliquative putrefaction (liquefaction) occurs during this period. Abdomen may burst open. Puffiness of the body passes over due to escape of gas through the damaged body parts. Soft, firm tissues change to thick, semisolid black mass. Finally, cartilages and ligaments are softened.

assumes a 'honey comb' ('foamy' or 'Swiss cheese') appearance due to formation of air bubbles.²⁹ It becomes greenish in color and later changes to coal-black.

Heart may show white granularity consisting of calcium and soapy material on epicardial and endocardial surfaces known as '*miliary plaques*'.

As a general rule, the organs show putrefactive changes in the following order as given in Table 9.6.³⁰

Prostate and uterus being the last organs to decompose, they help to identify the sex of the dead bodies in advanced state of decomposition.³¹

Pink teeth: In putrefied bodies, the teeth are sometimes seen to be pink in color, especially near gum line as a result of hemolysis of extravasated blood in the dentinal tubules.

- Cephalic congestion from a head-down position and a moist environment (e.g. drowning) promote the development of pink teeth.
- It is independent of the cause of death and production of carboxyhemoglobin.
- Usually seen within 1-2 weeks after death.

Factors Affecting Putrefaction

The factors can be divided into external and internal factors. The temperature of the body after death is the most important factor determining the rate of putrefaction.

External factors

- i. **Environmental temperature:** High temperature promotes early decomposition.
 - The optimum temperature for decomposition is 21-38°C. Beyond this range, decomposition occurs at a slow rate (delayed when the temperature is < 10°C and > 38°C).
 - Decomposition nearly stops at < 0°C and > 48°C.
 - The rate of decomposition is about twice as rapid in summer as in winter.
 - Optimum temperature helps in:
 - a. Chemical breakdown of the tissues
 - b. Promoting the growth of microorganisms responsible for decomposition
- ii. **Moisture:** Presence of moisture promotes decomposition by promoting the growth of the organisms.
 - If the body dries up quickly, putrefaction ceases and mummification occurs.

Table 9.6: Order of putrefaction

Early putrefaction	Late putrefaction
i. Larynx and trachea	i. Heart, lungs, kidneys
ii. Stomach, intestines	ii. Esophagus, diaphragm
iii. Spleen	iii. Blood vessels
iv. Liver	iv. Bladder
v. Brain	v. Prostate, uterus (non-gravid)
vi. Gravid uterus	vi. Skin, muscle, tendon

- Bodies recovered from water, if left in the air, decompose rapidly.
- iii. **Air:** Free access of air hastens putrefaction, because the air conveys organisms to the body.

Stagnant air promotes decomposition, whereas movement of air retards the process by evaporating the body fluids and cooling the dead body.
- iv. **Clothing:** Clothing may reduce the rate of decomposition by preventing invasion of the body by airborne organisms.

In winter, clothing hastens putrefaction by maintaining body temperature for a longer period and helping the growth of the microorganisms.
- v. **Manner of burial:** If the body is buried soon after death, putrefaction is less.
 - In buried dead bodies, the rate of decomposition varies according to the depth of the grave.
 - In surface burial, the rate of decomposition is more than in the deep burial, because of abundance of bacteria in surface soil in comparison to deep soil.
 - Putrefaction is delayed if body is buried in dry, sandy soil or the body is placed in a coffin, because there is exclusion of water, air and action of insects and animals.

Internal factors

- i. **Age:** In stillborn fetuses or infants who are unfed or have not breathed, the process of decomposition is slow, since it occurs from outside, as their bodies are sterile. Bodies of children putrefy rapidly and of old people slowly.
- ii. **Sex:** Sex does not have much to influence, but occurs faster in females, because of its abundant subcutaneous fatty tissue that contains moisture and retains body heat for a longer period.
- iii. **Condition of the body:** Emaciated body decomposes later than a well nourished bulky, fatty body due to more fluid content in the latter which promotes growth of microorganisms.
- iv. **Cause of death:** When death is due to infection or septicemia, decomposition is rapid. Putrefaction is delayed in death due to wasting disease, anemia, poisoning by carbolic acid, zinc chloride, strychnine and heavy metal due to the preservative action of these substances on the tissues or their destructive/inhibitive effects on microorganisms.
- v. **External injury on the body:** Dead body having external injuries (either antemortem or postmortem) will decompose earlier, because the injured areas will allow invasion of the body by bacteria.

Medico-legal Importance of Putrefaction

- i. It is the surest sign of death.
- ii. From decomposition changes, time since death can be assessed.
- iii. In advanced decomposition, the identity of the deceased may be impossible.
- iv. In advanced putrefaction, no opinion can be given as to the cause of death, except in case of poisoning, fractures and firearm injuries.

Decomposition of Submerged Body

Casper's dictum states that rate of decomposition in air is twice as rapidly as in water, and eight times as rapidly in deeply buried bodies, i.e. 1 week of putrefaction in air = 2 weeks in water = 8 weeks in soil at similar temperature, but this dictum is not useful practically.³²⁻³⁴ The deeper a body is buried, the better its preservation during an elapsed period of time.

The process of decomposition in water is slow due to:

- Exclusion of air
- Protection by clothes
- Early cooling of the body

After the body is removed from the water, the rate is rapid due to imbibition of water and optimum temperature for the growth of microorganisms. In submerged dead bodies, decomposition starts early in the head and face, because being heavy they assume the lowest level in the water and their blood content is maximum. As submerged cadavers float with the head lower than the trunk, gaseous distension and postmortem discoloration are first seen on the face and then spread to the neck, upper extremities, chest, abdomen and the lower extremities.

Factors Influencing Decomposition in Water

- i. **Water temperature and salinity:** Putrefaction is more in warm, fresh water than in cold, salt water.
- ii. **Water current:** In stagnant water, decomposition is more rapid than in flowing water, since flowing water washes out the microorganisms from the surface of the body.
- iii. **Quality of water:** Decomposition is slow in fresh water and rapid in polluted water.
- iv. **Aquatic animals:** Presence of aquatic animals including fish may cause mutilation of the dead body which accelerates the process of decomposition due to invasion by microorganisms.

Floatation of a Dead Body on Water

In India, floatation of a dead body on water occurs usually by 24 h after death in summer. In winter, it takes about 2-3 days to float. In cold or temperate countries, time required for floatation is about 2-3 days in summer and 1-2 weeks in winter.

Factors Influencing Floatation

- i. **Decomposition:** Early decomposition causes early floatation of the dead body, because accumulation of gas in the tissue increases the buoyancy of the body.
- ii. **Salinity of water:** Floatation occurs early in salty water due to higher specific gravity.
- iii. **Stagnant water:** Promotes early floatation by way of causing early decomposition.
- iv. **Clothing:** It causes early floatation, as it is lighter than water due to air bubbles in between the spaces of the fabrics.
- v. **Age:** Bodies of mature newly born float earlier than stillborn or immature ones.
- vi. **Sex:** Female bodies are lighter, because of more fat content and so female bodies float early.
- vii. **Season:** Floatation is early in summer than in winter, warm temperature being favorable for decomposition.

Entomology

Forensic entomology: It is the branch of science which deals with study of insects and other arthropods found in dead bodies that can shed light on time since death, the length of body's exposure and whether the body was moved.³⁵

- The forensic entomologist can use a number of different techniques including species succession, larval weight, larval length and a more technical method—accumulated degree hour technique which can be very precise, if the necessary data is available.
- Invasion of the dead body by maggots is an important cause of early decomposition and destruction of the dead body. Maggots are larvae of flies. The most important insects that are typically involved in the process include the flesh flies (Sarcophagidae) and blowflies (Calliphoridae). The green-bottle fly seen in the summer is a blowfly.
- Usually, three types of flies deposit or lay eggs, e.g. common house fly, green bottle fly and blue bottle fly. They lay eggs near the moist areas of the body, like the nose, mouth, near the canthuses of the eyes or

axillary folds. Laying of eggs may be as early as 8-9 h after death.

- *In case of common house fly*, hatching of the eggs occurs after about 10-12 h. The first change in the larva or the maggot occurs in a 1-2 days, the second in another 1-2 days. The larva continues in this stage for 2-3 days. Then it moulds into a pupa and takes about a week to change to an adult fly.
- Thus, the maturation of these insects (egg-larva-pupa-adult insect) serves as a biological clock which takes 1-2 weeks following death (but depends on the species and on ambient temperature).

Hence, to determine time of death, one has to identify the variety of the maggot and the stage in which it is present in the body.

Under certain specific environmental conditions, modified decomposition of the body occurs, wherein instead of total destruction, the dead body is preserved for a pretty long period. The two varieties of modified decomposition are known as adipocere and mummification (Diff. 9.7).

Adipocere (Saponification)

Definition: Adipocere (Latin *adipo*: fat, *cire*: wax) is formation of an offensive, sweet rancid smelling, soft, whitish or grayish white, crumbly, waxy and greasy material (similar to soap) occurring in fatty tissues of a dead body. It is a modification of decomposition.

Time required for formation: In hot and moist environment, it may occur by the end of 1 week (earliest recorded—3 days). In temperate countries, it starts in 3 weeks and completes in about 3 months.

Mechanism of formation: Adipocere consists mainly of fatty acids formed due to postmortem hydrolysis and hydrogenation of body fats. The process needs water which is provided by the body fluid of soft tissues. The chemical reaction essentially involves conversion of unsaturated liquid fats (oleic acid) to saturated solid higher fatty acids, like palmitic, stearic and hydroxystearic acid, mostly palmitic acid.

Distribution: It forms at any site where fatty tissue is present. The face, buttocks, breasts and abdomen are the

usual sites. In case of a female body, this change will be seen almost all over the body due to presence of a good amount of subcutaneous fat. Internally, small muscles are dehydrated and become very thin, and have a uniform grayish color. The depths of large muscles have a pink/red color with complete conversion of the fat to adipocere. The intestines and lungs are usually parchment-like in consistency and thinness. The liver is prominent and retains its shape.

Fate of the body: Usual decomposition is prevented when the body remains submerged in water or buried in moist graves or damp soil as the process of adipocere formation utilizes most of the fluid and hence the body is not invaded by microorganisms.³⁶

Factors Influencing Adipocere Formation

- Age:** Fetuses < 7 months do not show adipocere formation.
- Built:** In obese people and mature newborn, it is formed quickly.
- Environmental temperature:** Heat accelerates and cold retards adipocere formation in a body.³⁷
- Moisture:** Moisture is essential for chemical reactions to occur.³⁷ It occurs rapidly in bodies submerged in water than in damp soil.
- Air current:** It retards adipocere formation by evaporation of the body fluid and by reducing the body temperature.
- Running water:** Adipocere formation is retarded as the electrolytes are washed away from the surface of the body which is necessary for the change.
- Bacterial infection:** Early activity by anaerobes such as *Clostridium perfringens* assist in the reaction, as the bacteria produce lecithinase which facilitates hydrolysis and hydrogenation.

A warm, moist and anaerobic environment thus favors adipocere formation.

Medico-legal Importance

- Sign of death:** It is the surest sign of death.
- Time since death:** It gives a rough estimate about the time since death.

Differentiation 9.7: Adipocere and mummification

S.No.	Feature	Adipocere	Mummification
1.	Characteristic feature	Conversion of fatty tissues into fatty acids	Dehydration or desiccation
2.	Smell	Rancid smell	Odorless
3.	Moisture	Gains moisture and undergo hydrolysis	Looses moisture
4.	Ideal conditions	Warm temperature, moisture, less air, bacteria and fat splitting enzymes	High temperature, dry condition, free circulation of air

- iii. **Personal identification:** When the process involves the face, the features are well-preserved which help in identification.
- iv. **Recognition of injuries:** The cause of death may be determined, since injuries can be recognized.
- v. **Place of disposal of body:** Some idea about the place of disposal of the body can be made, since its formation requires a warm place with high humidity or presence of moisture or water.

Mummification

Definition: It is the rapid dehydration/desiccation and shriveling of the dead body from evaporation of water, with preservation of natural appearances and features of the body.

- It is a modification of putrefaction.
- The entire body loses weight, becomes thin, stiff, brittle and odorless.
- The process of normal decomposition of the dead body is prevented, as the growth of the micro-organisms is retarded.

Salient Features

- It begins in the exposed parts of the body, like face (lips, tip of nose), hands and feet and then extends to the entire body including the internal organs.
- The *skin* may be translucent due to absorption of the liquefied subcutaneous fat. It is usually shrunken and contracted, dry, brittle, leathery and rusty-brown in color, stretched tightly across anatomical prominences, such as the cheek bones, chin, costal margins, hips and adheres closely to the bones, and often covered with fungal growths.
- The *internal organs* become shrunken, hard, dark-brown and black and become a single mass and may not be identifiable.
- Collagen, elastic tissues, cardiac and skeletal muscle, cartilage and bone are usually demonstrable histologically in the mummified material.
- Occasionally, a body may show evidence of mummification in certain parts and adipocere changes in others. Thus, there may be adipocere in cheeks, abdomen and buttocks with mummification of the arms and legs.

Time required for mummification: It varies between 3-12 months or longer.

Factors Favoring Mummification

- i. **Hot environment:** As in the deserts.
- ii. **Dry atmosphere:** Mummification cannot occur in humid conditions.

- iii. **Free air movement:** It helps in rapid evaporation of body fluids.
- iv. **Contact of the body with absorbing media:** A dead body lying in shallow grave, in dry sandy soils mummifies early due to absorption of body fluid rapidly.
- v. **Poisoning:** Chronic arsenic or antimony poisoning favors the process of mummification.

Medico-legal importance: They are same as adipocere.

Estimation of Time Since Death (TSD) or Postmortem Interval (PMI)

Postmortem interval (PMI): It is the time that has elapsed since a person has died i.e. it is the time interval between death and the examination of the body.

This is important:

- i. To know when crime was committed.
- ii. It gives the police a starting point for their inquiries, and allows them to deal with the information available more efficiently.
- iii. It might enable to exclude some suspects.
- iv. To confirm or disprove an alibi.
- v. To check the suspect's statements.
- Determination of the time of death is important in both criminal and civil cases.
- In civil cases, the time of death might determine who inherits property or whether an insurance policy was in force.
- Estimation of time since death is a part of medico-legal inferences drawn after postmortem examination of dead bodies. It can directly or indirectly help to find out the time of assault which helps the investigating officer to locate an accused and to verify any alibi of the accused.
- The various methods include study of physical, chemical, biochemical, histological and enzymatic changes which occur progressively in a dead body. But in reality, there is no dependable method to narrow down the range of the estimated time lapsed after death, since the biological processes never follow a fixed rule. They vary during life and at death, from place to place and person to person. The longer the postmortem interval, i.e. the time between death and the attempt to determine time of death, the less precise the estimate of the interval.
- For all practical purposes, in many cases only gross estimation of this time interval may be possible. In most cases in this country, time of death is usually estimated from the physical changes noticeable in the

dead body. This necessitates *use of a range* for the estimated time of death, giving due consideration to the biological variable factors.

- The range of time provided is at best an educated guess, based on knowledge and experience and is subject to error.

First of all history should be taken and then local physical or environmental factors at the scene of crime, such as presence of fires, open windows, or atmospheric temperature must be noted.

Physical Changes Useful for Estimation of TSD

When a dead body is still warm, not rigid, without any permanent haziness of cornea, the death of the person possibly has occurred within the last 1 h in summer and within last 2 h in winter.

Evidence for estimating the time of death may come from three sources:

- Corporal (physical) evidence*: present in the body.
- Environmental and associated evidence*: present in the vicinity of the body.
- Anamnestic evidence*: based on the deceased's ordinary habits, movements and day-to-day activities.

Changes useful for determining the TSD (Fig. 9.1):

- Changes in the eye
- Algor mortis
- PM staining
- Rigor mortis
- Putrefaction
- Insect activity
- Stomach and intestinal contents
- Contents of urinary bladder
- Bone marrow changes
- Biochemical changes
- Circumstantial evidence
- Flow-cytometry

- Changes in the eye:** Already described above.
- Algor mortis:** It is the most useful single indicator of the postmortem interval during the first 24 h after death. The body attains environmental temperature in about 16-20 h after death.
- PM staining:** The extent of appearance and its fixation give some idea about the time which has passed after death. Mottled patches over the dependent parts occur within about 1-3 h. These patches coalesce in 4-6 h. The lividity is *fully developed and fixed in about 8-12 h*.
- Rigor mortis:** Appearance, distribution or its passing away are the most important physical changes which are taken into account for estimation of time since death.

- In tropical countries, it commences in 1-2 h after death, takes about 9-12 h to develop from head to foot, persists for another 12 h and gradually passes off in the same order as it appeared.
- In temperate countries, rigor mortis begins in 3-4 h, becomes fully established after 8-12 h, remains unchanged for upto 36 h and then disappears in 2-3 days.

In temperate countries, rough guide to estimate TSD is as follows:

- If the body feels warm and is flaccid, death is within < 3 h.
- If the body feels warm and is stiff, death is 3-8 h back.
- If the body feels cold and is stiff, death is 8-36 h back.
- If the body feels cold and is flaccid, death has occurred > 36 h back.

- Putrefaction:** Among the delayed changes after death (and after rigor mortis), this change is the single best one for the purpose of estimation of time since death. In India, greenish discoloration of the abdomen over the caecum and the flanks appears in about 12-24 h after death. It spreads over the whole of the abdomen and the rest of the body within the next 24 h.

Marbling commences after 24 h. Putrefactive odor is noticed at about the same time. By 36-48 h, marbling is prominent. In 12-18 h after death, gases collect in the intestines and distend the abdomen. From 18 to 36 or 48 h, gas formation is abundant. In about 36 h, in summer, the female genitalis appear pendulous and in about 48-72 h, the rectum and the uterus protrude.

Adipocere and mummification: The time required for adipocere formation in our country is 5-15 days. The time required for the complete mummification of a body varies greatly from 3-12 months or longer.

- Insect activity:** By about 18-36 h, flies lay their eggs. The eggs hatch into maggots or larvae in about 24 h.³⁸ In the course of 4-5 days, maggots develop into pupae, and in another 4-5 days pupae into adult flies. Lice usually die within 3-6 days after the death of the individual.
- Stomach contents:** From the state of digestion of food and the quantity of food substance in the stomach, it can be estimated for what period the person survived after taking his last meal if the quality, quantity and the time of the last meal taken can be known, the approximate time of his death can be made out indirectly.

- Diet rich in carbohydrates leaves the stomach earliest, a protein meal leaves the stomach more rapidly than a fatty meal. Milk leaves rapidly, whereas meat and pulses are retained longer.
- A light meal usually leaves the stomach within 1-2 h, a medium-sized meal in 3-4 h and a heavy meal within 5-8 h.
- If the stomach is full and contains undigested food, it can be said that death occurred within 2-4 h of eating of the last meal and if the food is digested (indistinguishable), then > 4 h.

Factors influencing the emptying time of stomach

- Motility of stomach
- Consistency of gastric contents
- Osmotic pressure of gastric contents
- Quantity of material in the duodenum

Factors decreasing the emptying time of stomach

- Head injury
- Fatty meal
- Pyloric stenosis
- Gastrojejunostomy operation
- Sleep
- Physical exhaustion, mental depression
- Coma
- Illness, emotional stress, like fear or worry

viii. **Intestinal contents:** The head of the digested meal reaches the hepatic flexure in about 6-8 h, splenic flexure in 9-12 h and pelvic colon in 12-18 h. In the pelvic colon, it may stay as feces for upto 12 h.

From the content of the pelvic colon and the rectum, it can be said if the person attended the nature's call within last few hours or not. If it contains feces, death may have occurred in the night and if empty, sometime after evacuation in the morning (depending upon the person's habit).

- ix. **Contents of urinary bladder:** The amount of urine in the bladder may give some indication of the time of death in some cases. If a body is found in the morning with the bladder full, then inference may be drawn that he might have died before the usual time of leaving his bed, since the first activity in the morning after leaving the bed is evacuating the bladder.
- x. **Changes in the bone marrow:** Within 1 h of death, nuclei of the neutrophils in marrow start swelling and by 4-5 h the nuclei become round. By 10-12 h, the outline of the neutrophils is lost.
- xi. **Biochemical and enzymatic changes:** These changes are dependent on the cooling of the body.

These are to some extent helpful and more suitable for cold or temperate countries.

- **Cerebrospinal fluid:** Cisternal fluid is examined. Lactic acid, non-protein nitrogen (NPN) and amino acid content increase in the first 15 h after death, but the rate is not uniform. Potassium, ammonia, creatine and uric acid increase and glucose values decrease after death.
- **Blood:** Potassium and magnesium levels rise whereas sodium and chloride fall after death. Lactic acid, creatine, NPN and amino acid nitrogen content increases after death. By about 12 h after death, the level of amino acid nitrogen is about 10 mg%; NPN is about 40 mg%; and that of creatine is about 10 mg%.

Blood	Initial values (mg%)	After 15 h of death (mg%)
Lactic acid	15	200
NPN	15	40
Amino acid	1	12

- The enzymes acid phosphatase, amylase, serum glutamate-oxalate transaminase (SGOT) and lactate dehydrogenase (LDH) increase after death.
- **Vitreous humor:** Steady rise in vitreous potassium values occur upto 100 h after death and linear rise of hypoxanthine upto 120 h.³⁹ A combination of the two generated the greatest accuracy with respect to estimation of TSD.
 - The main advantage of vitreous potassium method is that it may be carried out upto 4-5 days after death, whereas most other estimators are useful within the first 24 h.⁴⁰
 - Unfortunately, the levels of potassium in the vitreous are determined by the degree and rapidity of putrefaction rather than the time interval from death. Thus, anything that accelerates putrefaction, raises the level of vitreous potassium.
 - Levels of ascorbic acid and pyruvic acid in the vitreous fall after death.

Formulae used for vitreous potassium

• **Madea's formula:** $TSD = 5.26 \times [K^+] - 30.9$

• **Sturner's formula:** $TSD = 7.14 \times [K^+] - 39.1$

where $[K^+]$ is the potassium concentration (mmol/l)

With these methods, 95% confidence limits vary from ± 9.5 h to ± 40 h but with the elimination of subjects with electrolyte imbalance, accuracy is ± 22 h.

- *Pericardial fluid*: Constituents are not helpful in estimating time since death.
 - *Synovial fluid*: There is linear rise of potassium which doubles within 2 days.
- xii. **Facial hair growth**: Rate of growth of hair after shaving is 0.4 mm/day. Hair does not grow after death. If the time of his last shave is known, then the time since death can be calculated.
- xiii. **Circumstantial evidences**: Pocket articles like letters, diary, cinema-show ticket, etc. may indicate in some way the date and time upto which the person survived.
- Degree of coagulation of milk, staleness of food on a table and when the neighbor saw the person etc. may be valuable.
 - The dress should be noted as regards to whether the person is fully dressed or in the night dress.
 - In some cases, the wrist watch may stop and thus may indicate the date and exact time of death.
 - Some idea about the earliest period of death can be made from the newspaper present by the side of the dead body.
 - If a body is lying on the grass, it becomes pale due to non-exposure to sun for about 5 days.

Flow-cytometry: It is being investigated as a tool for determining how long an individual has been dead and, thus, the time since death. This procedure is still experimental. Present analysis involves use of splenic tissue. In flow-cytometry, one correlates the degree of DNA degradation in tissue from the deceased with tissue from other individuals whose time of death is known, i.e. controls.

Preservation of Dead Bodies

Preservation of dead bodies may occur naturally, if disposed off in favorable environmental condition. Dead bodies may also be preserved artificially.

The methods are:

- i. *Freezing* the body below 0°C, and at -17/-18°C the body may be preserved for years.
- ii. The body is treated with *chemical agents*, like lead sulphide, arsenic and potassium carbonate which prevent bacterial action and autolysis.
- iii. *Embalming*: It is the treatment of the dead body with antiseptics and preservatives to delay putrefaction. It results in coagulation of proteins, fixation of tissues, bleaching and hardening of organs and conversion of blood into a brownish mass. It

produces a chemical stiffening similar to rigor mortis and normal rigor does not develop.

In this process, the content of the intestine is syringed out or taken out by suction. Then embalming fluid is injected through large veins. Typical embalming fluid contains a mixture of formaldehyde, methanol, phenol, glycerin, oil of wintergreen (eucalyptus oil), eosin and water.⁴¹ Other chemicals, like glutaraldehyde, sodium borate/citrate may be used.

The evacuation of the intestine clears out the prevailing microorganisms and the formalin fixes the tissue protein and renders it unsuitable for bacterial invasion. Autolysis is also prevented due to chemical fixation of the tissue.

Disadvantages of embalming

- Difficult to interpret any injury or disease
- Determination of cyanide, alcohol, alkaloids, organic poisons and drugs become difficult
- Blood grouping may not be possible
- Thrombi and emboli are dislocated/dislodged

Presumption of Survivorship

Two persons of one family may die in a common circumstance. In such cases, for the purpose of succession of properties of one or both of the deceased persons, it may be necessary to know who died earlier and who died later, i.e. who survived whom. By postmortem examination, it may not be possible to say who died earlier and who later, if the deaths have occurred with a gap of a few minutes only. In such a case, *it has to be presumed* who might have survived whom, so that the problem of succession of property can be solved on that basis.

The case is decided by the facts and evidence available. Moreover, age (adults withstand better than young and elderly), sex (males withstand more than females), constitution (strong and robust withstand better than weak, debilitated and diseased), nature and severity of injuries (extent of hemorrhage, involvement of vital organs) and the mode of death (swimmer survives a nonswimmer) should be taken into consideration.

Presumption of Death

This is a legal issue which does not have any medical implication or involvement. It is in connection with inheritance or succession of property of a person, missing

for a long period or for claiming insurance money when the individual is alleged to be dead and body is not found.

Sec. 107 IEA states that a person is presumed being alive, if there is nothing to suggest the probability of

death within 30 years. **Sec. 108 IEA** states that, if it is proved that the said person has not been heard of for 7 years by them, who are expected to hear about him, if he would be alive, then death is presumed.

MULTIPLE CHOICE QUESTIONS

- Immediate sign of death is:** *DNB 10*
 A. Rise in body temperature
 B. Dilatation of pupil
 C. Changes in skin
 D. Cessation of respiration & circulation
- Following is an early sign of death:** *Karnataka 03*
 A. Rigor mortis
 B. Adipocere formation
 C. Putrefaction
 D. Mummification
- All are tests associated with cessation of circulation, except:** *Orissa 04; UP 05*
 A. Winslow's test
 B. Magnus test
 C. Diaphanous test
 D. I-card's test
- Test of historical importance to detect respiration:** *MAHE 09*
 A. I-card test
 B. Winslow test
 C. Magnus test
 D. Diaphanous test
- True about suspended animation:** *PGI 10*
 A. Common phenomenon
 B. Can be voluntary
 C. Similar to molecular death
 D. Resembles brain death
- Suspended animation may be seen:** *BHU 11*
 A. Electrocution
 B. Hanging
 C. Drowning
 D. Burn
- The phenomenon of suspended animation may be seen in:** *AIIMS 04*
 A. Throttling
 B. Drowning
 C. Strangulation
 D. Brain hemorrhage
- Tache noire is:** *TN 05*
 A. Postmortem calorificity
 B. Change in eye after death
 C. Postmortem lividity
 D. None of the above
- Algor mortis is:** *JIPMER 03; Punjab 11*
 A. Cadaveric spasm
 B. Hypostasis
 C. Cooling of body
 D. Rigor mortis
- The ideal place to record body temperature in dead body is:** *AIIMS 05, 06; BHU 10*
 A. Rectum
 B. Axilla
 C. Mouth
 D. Groin
- The rate of cooling down of dead bodies in tropical climate is:** *Delhi 05, 06; Kerala 06; UP 07*
 A. 0.2°C/h
 B. 0.5°C/h
 C. 1.5°C/h
 D. 2°C/h
- Postmortem calorificity may be seen in all the following causes of death, except:** *AIIMS 05; MP 07*
 A. Septicemia
 B. Barbiturates poisoning
 C. Strychnine poisoning
 D. Tetanus
- Postmortem calorificity is seen in all, except:** *JIPMER 03; AP 06*
 A. Burns
 B. Sunstroke
 C. Tetanus
 D. Septicemia
- Postmortem staining gets fixed within:** *BHU 10*
 A. 1 h after death
 B. 6 h after death
 C. 12 h after death
 D. 24 h after death
- Postmortem lividity is unlikely to develop in a case of:** *AI 03*
 A. Drowning in well
 B. Drowning in a fast flowing river
 C. Postmortem submersion
 D. Drowning in chlorinated swimming pool
- Statement NOT true about postmortem staining is:** *PGI 05*
 A. Disappears within 24 h with discoloration
 B. Seen only in dependent parts
 C. Appears immediately after death
 D. Not seen in parts tied with a tight cloth or at pressure point
- Postmortem lividity is useful to access:** *TN 06*
 A. Time since death
 B. To know the weapon used
 C. Position of the body after death
 D. All of the above
- Difference between postmortem staining and contusion are all, except:** *PGI 10*
 A. Bluish in color
 B. Disappear on pressure
 C. Margins are regular
 D. Extravasation is found
- True about rigor mortis are all, except:** *PGI 03; FMGE 08*
 A. Seen immediately after death
 B. It last 18-36 h in summer
 C. It disappears in the sequence as it appears
 D. It last 24-48 h in winter

1. D 2. A 3. A 4. B 5. B & D 6. A & C 7. B 8. B 9. C 10. A
 11. B 12. B 13. A 14. B 15. B 16. A 17. A & C 18. D 19. A

Asphyxia

10

Definition: Asphyxia (Greek, 'pulsenessness' or 'absence of pulse') is a condition caused by interference with the exchange of oxygen and carbon dioxide in the body.

- Asphyxia literally means 'defective aeration of blood' due to any cause.

Pathophysiology of Asphyxia

Pathophysiology of asphyxia is depicted in Flow chart 10.1.

Etiology of Asphyxia (Table 10.1)

It can be:

- Mechanical/violent:** Mechanical interference to the passage of air into the respiratory tract by (Fig. 10.1):
 - Closure of the external respiratory orifices by closing the nose and the mouth (e.g. smothering).
 - Closure of the air passages by external pressure on the neck (e.g. hanging, strangulation and throttling) or impaction of foreign bodies (e.g. gagging and choking).
 - Occlusion of the respiratory tract and lungs by fluid (e.g. drowning).

Flow chart 10.1: Pathophysiology of asphyxia (vicious cycle)

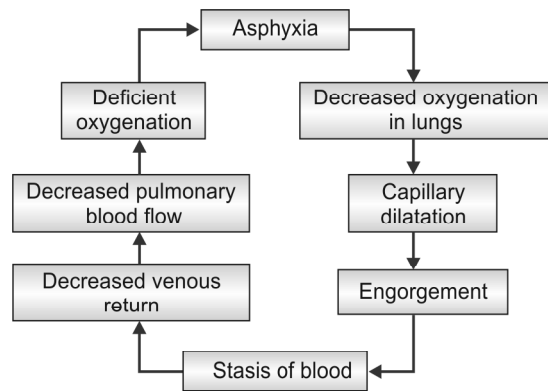

- Pressure on the chest in a stampede or collapse of a building (e.g. traumatic asphyxia).
- Pathological:** Entry of oxygen to the lungs is prevented by disease of the upper respiratory tract or lungs, e.g. laryngeal edema, spasm, tumors and abscess.
 - Toxic or chemical:** Cessation of the respiratory movements due to paralysis of the respiratory centre in poisoning with morphine, barbiturates and

Table 10.1: Asphyxial conditions

Classification	Level of obstruction	Cause
Strangulation/hanging	Neck (including larynx, trachea and major blood vessels)	Occlusion of the internal airways by external pressure
Smothering	Mouth and nose	Blockage of the external orifices
Gagging	Nasopharynx	Blockage of the internal airways
Choking	Larynx	Blockage of the internal airways
Overlaying	Mouth, nose, chest	Occlusion of mouth and nose and blockage of the internal airways by external pressure
Traumatic asphyxia	Chest	Restriction of chest movement due to external mechanical fixation
Wedging	Neck and chest	Occlusion of the internal airways by external pressure
Drowning	Upper and lower respiratory tract	Occlusion of the internal airways by fluid
Toxic asphyxia	Lung	Failure of oxygen transportation/utilization, CO or cyanide poisoning

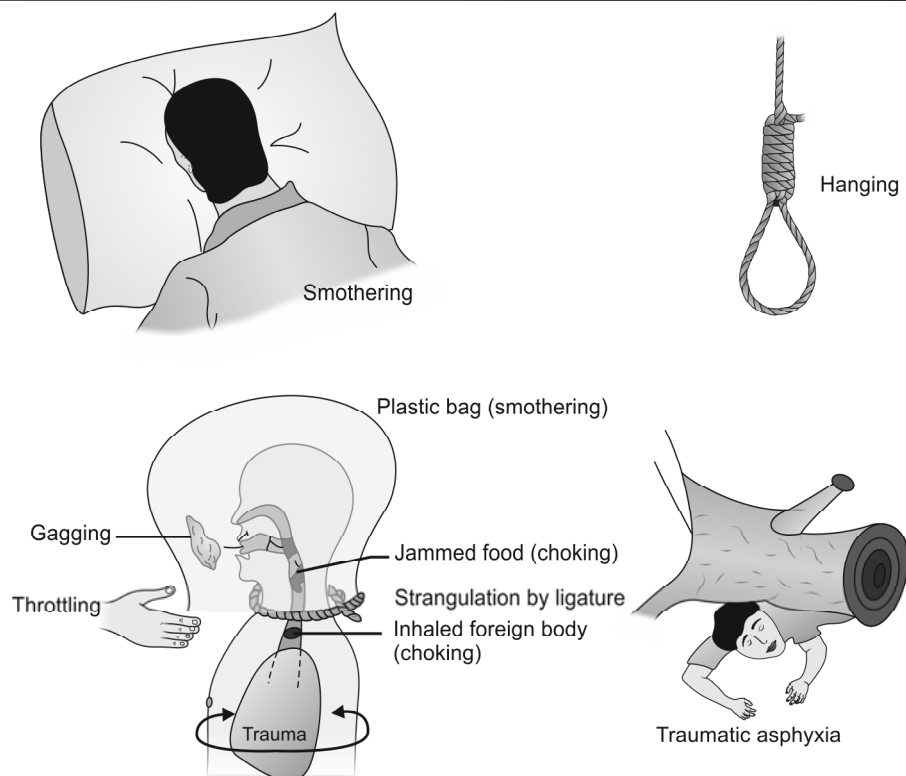

Fig. 10.1: Mechanism of asphyxial deaths of common occurrence in the medico-legal field

strychnine. Inhibition of oxidative processes in the tissue preventing the use of oxygen in the blood, e.g. cyanide poisoning.

- iv. **Environmental:** Breathing in vitiated atmosphere, as in high altitude, climbing or flying, or inhalation of CO, sewer gas or pure helium.
- v. **Traumatic:** Blunt trauma to the thorax may result in pneumothorax or hemothorax or pulmonary embolism that will interfere with oxygenation and ventilation by compressing otherwise healthy parenchyma.
- vi. **Positional/postural:** Positional asphyxia is due to peculiar body position that prevents adequate gas exchange.
 - In alcoholics or addicts, where the person is unconscious and the upper portion of the body is lower than rest, or neck is forcibly flexed on the chest which prevents normal respiratory movements.
 - *Positional/restraint asphyxia* may occur in *hogtying* also (individual is placed in a prone position, their hands are cuffed together behind their back and their ankles are bound and tied to their wrists).
- vii. **Iatrogenic:** It is seen during anesthesia.

Clinical Effects of Asphyxia

Clinical effects of asphyxia are shown in Flow chart 10.2.

Tardieu's or Bayard's ecchymoses/spots: They are usually round, dark-red, well-defined, pin-head sized spots, found in those parts where capillaries are least supported, e.g. conjunctiva, face, epiglottis, subpleural surface of lungs, heart, meninges and thymus.

- They tend to be better made out in fair skinned persons, readily visible in fresh bodies and disappear with putrefaction.
- They are not pathognomonic of asphyxia and their absence does not exclude asphyxia (rarely seen in drowning).
- It can be seen in other forms of death—electrocution, poisoning, coronary thrombosis, in persons on anticoagulants, with bleeding disorders such as scurvy, leukemia and thrombocytopenia, but distribution is more generalized.

Cyanosis (Greek, dark blue): It is due to diminished O₂ tension in blood and increase in reduced hemoglobin ($\geq 5\text{g/dl}$). Blood appears purple or dark in color; usually seen in the lips, tip of nose, ears lobules, and internally in the lungs, meninges, liver, spleen and kidneys.

Flow chart 10.2: Clinical effects of asphyxia

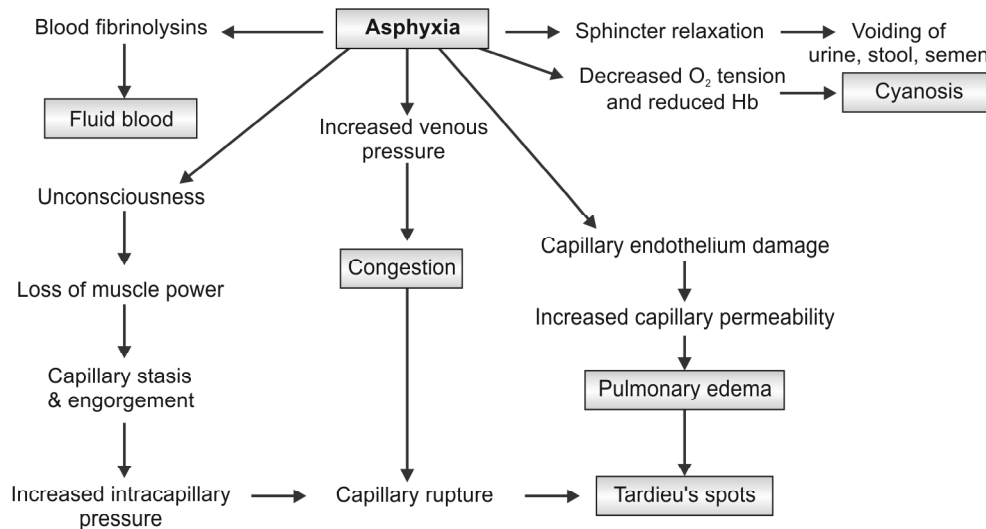

Hanging

Definition: Hanging or 'self-suspension' is a form of asphyxia which is caused by suspension of the body by a ligature which encircles the neck, the constricting force being at least part of the weight of the body.

Classification

On the basis of position of the knot (Fig. 10.2)

- **Typical hanging:** When the point of suspension is placed centrally over the occiput i.e. the knot is at the nape of neck on the back.^{1,2}

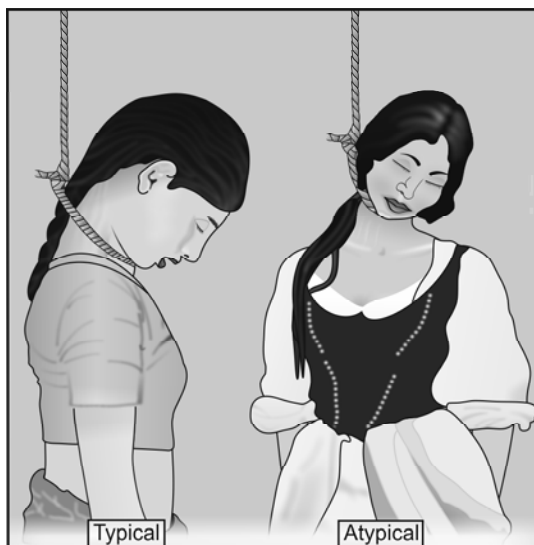

Fig. 10.2: Classification of hanging (position of knot)

- **Atypical hanging:** Knot of ligature is anywhere other than on the occiput.

On the basis of degree of suspension (Fig. 10.3)

- **Complete hanging:** Body is fully suspended and no part of body touches the ground. Constricting force is weight of the body.
- **Incomplete or partial hanging:** Lower part of the body is touching the ground (toes or feet touching the ground) or in sitting, kneeling, lying down or prone position. Weight of the head acts as the constricting force.

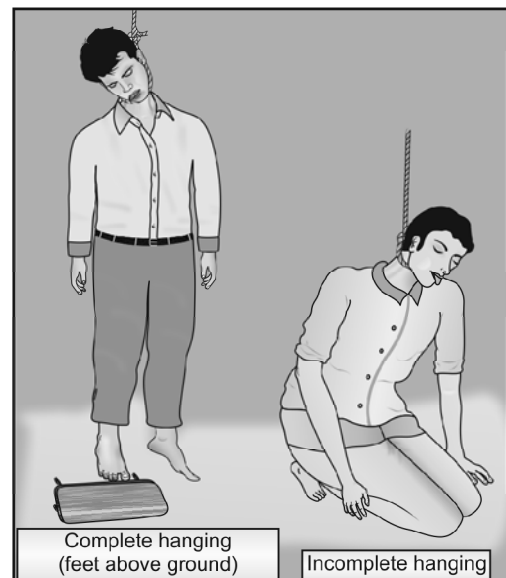

Fig. 10.3: Classification of hanging (degree of suspension)

On the basis of intent

- Suicidal
- Homicidal
- Accidental
- Autoerotic

Cause of Death

- i. **Asphyxia:** Constricting force of ligature causes compressive narrowing of laryngeal and tracheal lumina, leading to asphyxia.
- ii. **Venous congestion:** Jugular veins are blocked by the ligature which results in stoppage of cerebral circulation; occurs if ligature is made up of broad and soft material.
- iii. **Combined asphyxia and venous congestion:** Commonest cause.
- iv. **Cerebral anemia:** It occurs when ligature is made of thin cord.
- v. **Reflex vagal inhibition** leading to sudden cardiac arrest.
- vi. **Fracture/dislocation of cervical vertebrae:** It is seen in judicial hanging.

Delayed deaths are rare which may be due to:

- Aspiration pneumonia
- Edema of lungs, larynx
- Infections
- Infarction of brain
- Hypoxic encephalopathy
- Abscess of brain

Secondary effects of hanging in persons who have recovered are:

- Hemiplegia
- Epileptiform convulsions
- Amnesia
- Cervical cellulitis
- Parotitis
- Retropharyngeal abscess

Fatal period: Death is *immediate*, if cervical vertebrae are fractured or if the heart is inhibited, *rapid* if cause is asphyxia and *least rapid* if coma is responsible. Usual period is 3-5 min which may extend to 5-8 min of suspension leading to death.

Autopsy of Neck (Asphyxial Deaths)

Photograph of the victim along with ligature (if present) is recommended.

External Examination*General features*

- Clothing and personal effects.
- Distribution of lividity, rigor mortis, algor mortis.

- Bleeding from any sites, discharge of semen, urine or fecal matter.
- Ocular or facial petechiae, congestion, cyanosis.
- Tongue protrusion between clenched teeth and dribbling of saliva.
- Evidence of any other trauma

Ligature

Is ligature present in situ or removed?

Knot: If in situ, note knot position, number of loops.

Ligature description

- Type of material
- Circumference of noose
- Width
- Nature of knot (slip-knot or fixed)

Frequently, the knot is in the form of a simple slip-knot to produce a running noose or fixed by granny or reef-knot; occasionally a simple loop is used. Usually, it is present on the right or left side.

If in situ, it should be cut away from knot and reconstructed by joining cut ends with tape or another cord (Fig. 10.4).

Description of ligature mark or furrow

- Course (angled or straight)
- Width
- Associated skin changes or trauma
- Relation to thyroid cartilage
- Pattern
- Neck circumference at level of furrow (to determine degree of neck constriction)
- Transfer of ligature material

Internal Examination

- i. Anterior neck structures are examined at the end of autopsy—following removal of tissues and organs and collection of toxicology samples—to allow drainage of blood and reduce the possibility of artifactual hemorrhage.
- ii. Modified Y-shaped incision is preferable to expose the neck structures (Fig. 10.5).
- iii. Anterior neck structures (tongue, larynx, trachea with thyroid gland, attached strap muscles including sternocleidomastoid muscles and submandibular glands) are inspected before removing them.
- iv. Tongue is inspected and cut through (tip to base) to observe hemorrhage.
- v. It is noted whether hemorrhages are present in the submandibular glands and strap muscles.

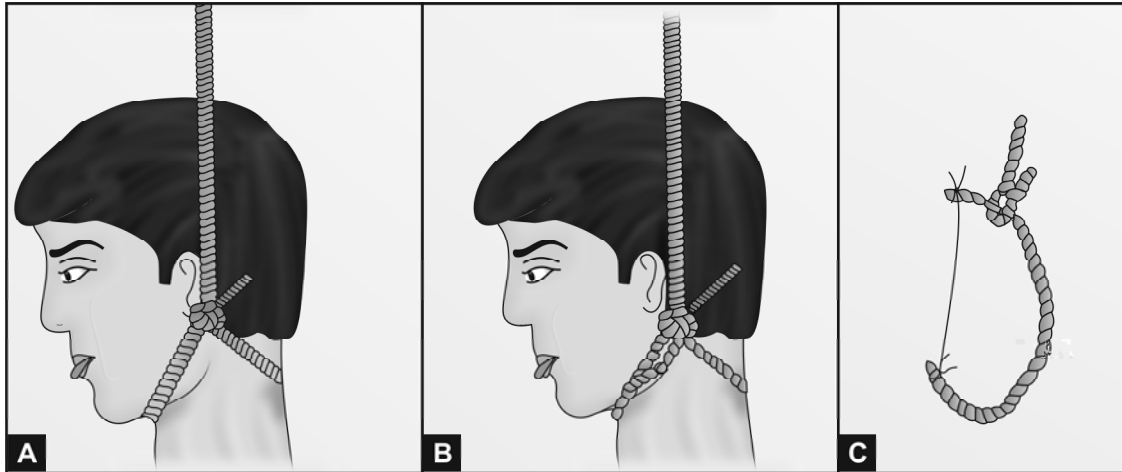

Fig. 10.4: (A) Fixed noose, (B) Running noose, (C) Method of cutting the noose and preserving the cut ends and the knot

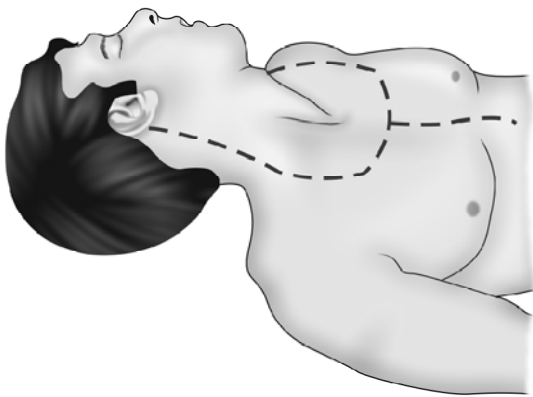

Fig. 10.5: Modified Y-shaped incision

- vi. The thyroid gland is removed and sectioned.
- vii. Any hemorrhage or fracture is noted in the muscle around the cricoid, laminae of the thyroid cartilage and superior horns.
- viii. Hyoid bone is palpated and any hemorrhages adjacent to the hyoid or thyrohyoid ligament are also noted. Dissect away the hyoid (note that the lesser cornua are variably long and may be inadvertently cut).
- ix. Longitudinal sections through the larynx may be done to note intracartilaginous hemorrhages—in suspected hanging cases.
- x. The esophagus and larynx-trachea are dissected posteriorly to observe any submucosal hemorrhage or petechiae, mucosal injuries and aspiration.

Postmortem Findings in Hanging

External Findings

1. Face

- i. **Swollen, cyanosed face:** Due to impaired venous return and accumulation of blood.
- ii. **Prominent eyeballs:** Due to increased pressure resulting from passive accumulation of blood.
- iii. **Dilated pupils:** If the knot presses on cervical sympathetic, eye of the same side may remain open and its pupil dilated (*la facie sympathetique*).³ It indicates antemortem hanging.
- iv. **Sub-conjunctival hemorrhages.**
- v. **Protrusion of tongue:** Due to pressure on floor of the mouth by ligature. It is usually swollen and blue. Injuries include bite marks with or without underlying small hemorrhages ('marginal' hemorrhages).
- vi. **Bleeding from nose/ears:** Due to impaired venous return and increase in pressure, resulting in passive flow of blood.
- vii. Lips and mucous membrane of mouth are blue.
- viii. **Dribbling of saliva:** *Surest sign of antemortem hanging.*^{4,5} Excessive salivation occurs when the person is alive, due to pressure and friction caused by ligature material on the submandibular glands. Dribbling of saliva occurs from the angle of mouth which is at a lower level, i.e. from angle opposite to the side of knot. When the knot is on the nape of the neck, it occurs across the middle of lower lip.

2. Neck

i. Ligature mark ('furrow')

- **Site:** Usually above the hyoid bone.
- **Size/shape:** Depends on the type of material used.
- **Direction:** It runs obliquely, backwards, non-continuous, upwards, towards the point of suspension. Mark is non-continuous because of a gap at the nape of neck, and hair intervening between ligature material and the skin underneath. When the knot is in contact with the skin, it is usually inverted 'V' shaped, due to extension of ligature material downward on both sides from the knot above (Fig. 10.6).
- **Skin at the site:** Usually depressed/grooved, pale in color, but later becomes yellowish brown, dry, hard, parchment-like with small abrasions at its edges, corresponding to the thickness and edges of the rope. These abrasions are also known as *rope burns* and are due to frictional force.
 - The pattern of ligature may be reproduced in the furrow.
 - Postmortem blisters may be seen on skin squeezed adjacent to the furrow.
 - An abraded area below the furrow may indicate upward slippage of the ligature, usually seen when suspension is complete.
 - Neck veins above the furrow may be distended.

ii. **Dimension of neck:** Due to prolonged suspension, the neck becomes slender and increases in length.

iii. **Bending of neck:** Neck gets flexed to the side opposite to the knot.

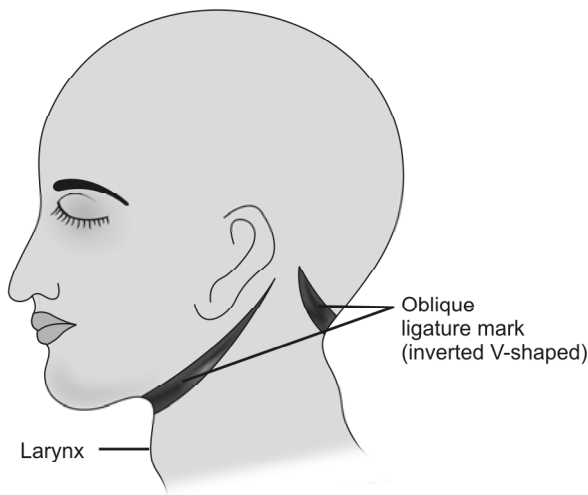

Fig. 10.6: Ligature mark in hanging. Point of suspension is posterior to the left ear

3. Other parts of body

- Tardieu's spots:** May be present on forehead, over the eyelids, under the conjunctiva and near the temple.
- Cyanosis of fingernails.
- Purple colored postmortem staining in the lower limbs and lower regions of upper limbs (hands/forearms)—*glove and stocking PM staining*.
- Hands are usually clenched.
 - In males, there may be penile turgidity and involuntary discharge of semen.
 - In both sexes, there may be involuntary discharge of fecal matter and urine.

Signs of asphyxia may be lacking in case of complete hanging as death occurs almost instantaneously by vagal stimulation. Florid asphyxial changes can be seen in cases where a fixed knot was used or in incomplete hanging.

Based on the ligature mark in the neck, the diagnosis of antemortem hanging can be made if the following triad of characteristics are present:

- Streaks or bands of reddened or pink tissue
 - Imprint of the pattern of the ligature in the furrow
 - Sloping or upward angle towards the suspension point
- Microscopically, engorgement in the reddened and pinkish area in contrast to the adjacent non-engorged and non-hemorrhagic areas may be demonstrated.

Internal Findings

• Neck

- Subcutaneous tissue underneath the ligature mark is dry, white, firm and glistening. Platysma and sternomastoid may show hemorrhages and are sometimes ruptured.
- Hyoid bone may be fractured in persons, more commonly above the age of 40 years.
- Transverse carotid intimal tears may be seen in obese victims, long drops and posteriorly placed knots (*Amussat's sign*).
- Vertebral artery injuries—rupture, intimal tear and subintimal hemorrhage (most frequent) may be present.
- Larynx and trachea are congested.
- Fracture of superior horn of the larynx may be present.

• **Lungs:** They are congested, distended and emphysematous with plenty of Tardieu's spots subpleurally, particularly at the interfaces of the lobes.

• **Brain:** Congested and show multiple Tardieu's spots.

• **Viscera:** All the abdominal organs are congested.

• **Blood:** Fluid and purplish in color.

There may be hemorrhages on ventral surface of the intervertebral disks beneath the anterior longitudinal ligament in the lumbar spine (*Simon's sign*). It may also be seen in blunt trauma, drowning and putrefaction.

Medico-legal Questions

Q. Whether the hanging was suicidal, homicidal or accidental?

- **Suicide:** Hanging is a common method of asphyxial suicide in many countries. Person can be between 10-80 years, more common in males. Point of suspension remains approachable to the suicider. Partial hanging is almost always suicidal in nature. A history of a previous attempt may be present and generally committed in a secluded place (victim's home is the most frequent site). Suicidal note may be left behind. There should be a motive for committing suicide. Fibres of ligature material may be present in the clenched hand.
- **Homicide:** Very rare. Not ordinarily possible in an adult victim, unless intoxicated or made unconscious or the victim is either a child or a debilitated person.

Homicide should be suspected where:

- There are signs of violence/disorder of furniture
 - Clothing of deceased is torn or disarranged
 - There are injuries, either offensive or defensive.
- **Postmortem hanging/postmortem suspension:** Person may be murdered and the body suspended to simulate suicide. Look for signs of dragging to the place of suspension. Beam or branch of tree shows evidence of the rope having moved from below upwards, as the body has been pulled up. *In true suicidal hanging, the rope moves from above downwards* (Diff. 10.1).
 - **Accidental hanging:** Hanging deaths in children < 6 years are usually accidental. It has been reported among children while 'playing hanging' (e.g. pretending to be a cowboy) or playing 'Lasso' or getting suspended from playground equipment and sometimes even in adults (e.g. autoerotic hanging).

Lynching

Lynching is a form of *homicidal hanging*. A suspect, an accused or an enemy is overpowered by several persons, acting jointly and illegally and hung him by means of a rope from a tree or some similar object. It was prevalent in North America, where it was practiced by whites on Negroes.⁶

Differentiation 10.1: Antemortem and postmortem hanging

S.No.	Feature	Antemortem hanging	Postmortem hanging
1.	Salivary dribbling mark	Present	Absent
2.	Fecal/urinary stains	May be present	Absent
3.	Ligature mark <ul style="list-style-type: none"> • Direction • Continuity • Level in the neck • Parchmentization • Vital reaction 	Oblique Non-continuous Above thyroid Present Present	Circular Continuous At or below thyroid Absent Absent
4.	Knot	Single, simple, on one side of neck	Multiple, granny or reef type on occiput/chin
5.	PM staining <ul style="list-style-type: none"> • Above ligature mark • In lower limbs • Glove-stocking like 	Present Present Present	Absent Absent Absent
6.	Evidence of injury <ul style="list-style-type: none"> • Self-inflicted • Struggle • Tear of carotid artery intima • Imprint abrasion 	Present Absent Present Present	Absent Present Absent May/may not be present
7.	Elongation of neck	Present	Absent
8.	Cyanosis	Deeply positive	Absent or faintly present
9.	Emphysematous bullae on lungs	Absent	Present
10.	Point of suspension	Compatible with self-suspension	Not so

Judicial Hanging

In case of judicial hanging, the ligature is looped around the neck with the knot under the chin (submental), but subaural (below auricle) knot is also used.⁷ The drop is at least the height of the victim (5-7 feet) and the hanging is complete. The ligature around the neck causes a forceful jerky impact on the neck at the end of the fall, so as to cause fracture of cervical column (fracture dislocation of C2 from C3, rarely C3 and C4 vertebrae—*hangman fracture*) with stretching or tearing of cervical spinal cord, but not decapitation. In judicial hangings, odontoid process is usually not fractured.

Hangman's fracture: Experimentally, it was demonstrated that when the hangman's knot was placed beneath the chin, death occurred rapidly because of fracture of the pedicles/lamina of C2 vertebra and a traumatic spondylo-lithesis of the C2 over C3 (anterior subluxation/dislocation)⁸ (Fig. 10.7). This knot placement then became standard, as the most efficient method of execution.

The mechanism of the injury is forcible hyperextension of the head. This injury may also be seen in sports or due to fall or road traffic accidents.

Factors which influence the appearance of ligature mark

- **Ligature material:** If it is tough and narrow, then the mark is deep and prominent. If it is soft and broad, then mark is less prominent or deep.
- **Period of suspension:** Longer the suspension, deeper is the groove, and it is more prominent and parchmented.
- **Degree of suspension:** Mark becomes more prominent and deep in case of total suspension.
- **Weight of the body:** Heavier the body, more marked is the ligature impression.
- **Position of knot:** Main force applied to the neck by ligature is opposite to the point of suspension.
- **Slipping of ligature during suspension:** Produces double impression of ligature.

Strangulation

Definition: It is a form of violent asphyxial death caused by constriction of air passage at the neck by means of a ligature or by any means *other than suspension of the body*.

Classification

- **Ligature strangulation:** When ligature material is used to compress the neck.
- **Manual strangulation or throttling:** When human fingers, palms or hands are used to compress the neck.
- **Mugging:** Strangulation caused by holding the neck of the victim in the bend of elbow or knee of the assailant. It is an attack, usually from behind, and may leave no external or internal injury mark. It is

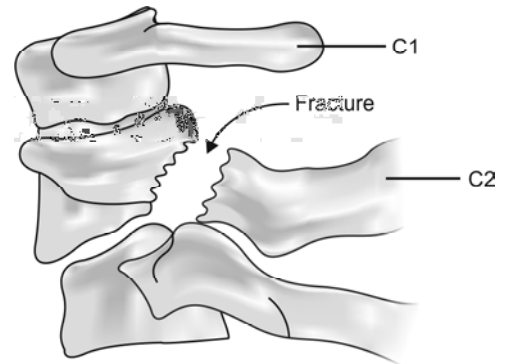

Fig. 10.7: Hangman's fracture

also known as *chokehold*. This hold is not permitted in wrestling, because of its danger.

- **Bansdola:** A bamboo or stick is placed across the back of the neck and another across the front. Both the ends are tied with a rope due to which the victim is squeezed to death. When a foot or knee is placed across the front of throat and pressed while the victim is lying on ground, same condition will follow. If a stick or foot is used, a bruise is seen in the centre, across the trachea corresponding to the width of the object used.
- **Garroting:** Strangulation is caused by compression of the neck by a ligature which is quickly tightened by twisting it with a lever (rod, stick or ruler) known as *Spanish windlass* which results in sudden loss of consciousness and collapse (Fig. 10.8).⁹ Garroting as a mode of execution was practiced in Spain, Portugal

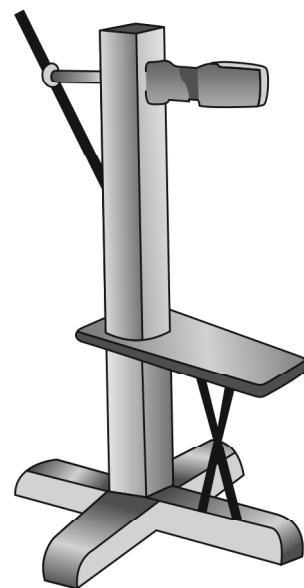

Fig. 10.8: A garrote

and Turkey. An iron collar was tightened by a screw for strangulation.

Ligature Strangulation

Cause of death

- *Asphyxia* due to elevation of the larynx and tongue closing the airway at pharyngeal level.
- *Cerebral anoxia* due to venous congestion.
- *Vagal inhibition*.
- Rarely, *fracture dislocation* of cervical vertebrae.

Postmortem Examination

External Findings (Fig. 10.9)

1. Face

- Face is congested, swollen and cyanosed. Tardieu's spots are present on the forehead, temples, eyelids and conjunctiva; more abundant than in hanging.
- Eyes** prominent, wide open, conjunctiva congested, pupils dilated, sub-conjunctival hemorrhage is present.
- Lips, fingernails and ear lobules are cyanosed; postmortem lividity marked on the skin above the ligature.
- Tongue** is swollen, dark colored, may protrude out of mouth and bitten by teeth.
- Bloodstained frothy fluid and mucus may escape from mouth and nostrils.

2. Neck

Ligature mark ('furrow')

- Ligature mark is a well-defined groove, which is slightly depressed and of same width as that of ligature material. Groove may be narrow at parts due to folding of ligature.
- The furrow is usually *horizontally placed* across the middle or lower part of neck, at or below the level of

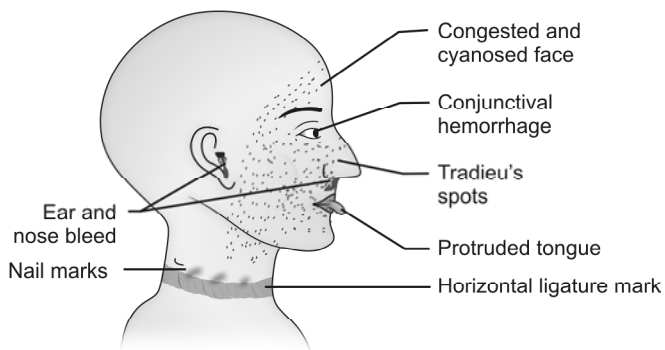

Fig. 10.9: Postmortem findings in strangulation

thyroid cartilage. The mark is transverse, circular and continuous.

- Mark, though completely encircling the neck horizontally, is more prominent on the front and sides, than on the back of the neck (as the underneath skin is thick).
 - The base of the furrow is usually red, accompanied with congested or ecchymosed margins. Base may show imprint pattern of the ligature material used.
 - It may be very indistinct or altogether absent, if the ligature was soft and broad and was removed soon after death and may need to be examined under UV light.
 - Mark may be oblique as in hanging, if the victim has been dragged by a cord, after being strangled in a recumbent posture.
- #### 3. Other parts of body
- Postmortem staining is deep and prominent.
 - There may be involuntary discharge of urine and fecal matter—more common than in case of hanging. Seminal ejaculation is less common than in case of hanging.
 - Hands are usually clenched and genitals turgid.
 - In case of struggle, there may be evidence of abrasions, fingernail scratch marks, and contusions over the face, arms and other parts of the body.
 - Scratches may be found on the skin of the neck near the ligature. They are usually vertical, may be irregular or crescentic abrasions, consequent of the victim attempts to pull the ligature away from the neck. Fingernails of the deceased should be examined for fragments of skin and blood.

Internal Findings

Neck

- Bruising of the subcutaneous tissue and muscles of neck, especially underneath the ligature and knot. There may be bruising or laceration of the sheath of carotid arteries.
- Injury of hyoid bone is *not commonly* noticed, because the level of constriction is well below and traction on the thyrohyoid ligament is negligible.
- Fracture of thyroid cartilage, one or both the superior horns may be seen.
- Sub-capsular and interstitial thyroid hemorrhages are common.
- Fracture of cricoid cartilage is less common.
- Rings of trachea may sustain fracture when considerable force is applied.
- Bruising of the root of the tongue and floor of the mouth may occur.

- viii. Lymphoid follicles at the base of the tongue and the palatine tonsils are congested.
- ix. Mucous membrane of the pharynx, pyriform sinuses, epiglottis and larynx usually show areas of hemorrhagic infiltration.
- x. Larynx, trachea and bronchi are congested and contain frothy, often bloodstained mucus.
- xi. Fracture/dislocation of cervical vertebrae is not common, may occur in infants if associated with twisting of the neck.

General findings

- i. **Lungs** are congested, edematous with numerous subpleural petechial hemorrhages.
- ii. **Brain** is congested with petechiae in white matter.
- iii. All other organs are congested.

Medico-legal Questions

Q. Whether death was caused by strangulation?

- General asphyxial features of death are present. The findings in the head and neck are strongly presumptive of strangulation which is confirmed by ligature mark on the neck.
- In absence of ligature mark in neck or deeper injury, it will be difficult to form an opinion, except from circumstantial evidence.
- The mere presence of cord or ligature around the neck of a dead body does not confirm the diagnosis, for it may be put around the neck for a malicious purpose.
- Strangulation by ligature has to be differentiated from hanging (Diff. 10.2).

Q. Whether the strangulation was suicidal, homicidal or accidental?

Suicidal strangulation

- Suicide by strangulation is rare. The victims employ various methods of tightening the ligature, but the person can apply a single or double knot before consciousness is lost.
- In suicidal strangulation, signs of venous congestion are very well developed above the ligature and are especially prominent at the root of tongue.
- The ligature should be found in situ; body should not show signs of violence or marks of struggle.

Homicidal strangulation: Strangulation should be assumed to be homicidal, until the contrary is proved. Many of the victims are women, and frequently, strangulation in them is associated with sexual intercourse.

Homicide is suspected when:

- There are two or more firm knots, each on separate turns of the ligature.
- Abrasions and fingernail marks are seen.
- The clothing of the victim is torn or disarranged, indicating that a struggle has taken place.
- The ligature when removed is loose.

Sometimes, homicidal strangulation is feigned by an individual to bring a false charge against his enemy. Hysterical women sometimes feign it, without any obvious motive.

Accidental strangulation

- Accidental strangling may occur in uterus, when the movement of fetus causes the umbilical cord to encircle the neck.
- Children may get entangled in ropes during play or strangled in their cots.
- Persons under the influence of alcohol, epileptics and imbeciles may be strangled either by a tight scarf or collar or necktie.

Accidental ligature strangulation may occur in the '**long-scarf syndrome**' in which a clothing around the victim's neck (scarf or '*chunni/dupatta*') becomes entangled, usually in a stationary or moving mechanical device (e.g. rickshaw or scooter wheel), and the clothing becomes increasingly constricted owing to the continued action of the machine.

Pseudo or False Strangulation Groove

- Sometimes, marks are seen on the neck of dead infants or children. Infants have short neck and these marks are produced from folds in the skin due to bending of the head.
- They are also seen in decomposed bodies with tight collars, buttoned shirt at the neck or a necklace around the neck.

Throttling or Manual Strangulation

Definition: Asphyxia produced by compression of the neck by human hands.

Cause of death

- i. *Asphyxia* from obstruction of respiration.
- ii. *Cerebral anoxia* from interference with cerebral circulation.
- iii. *Vagal inhibition* from pressure on carotid nerve plexus consisting of fibres of vagus, sympathetic and glossopharyngeal nerves. About half of the deaths are due to vagal inhibition.

Pressure must be applied for 2 min or more to cause death.

Differentiation 10.2: Hanging and strangulation^{10,11}

S.No. Feature	Hanging	Strangulation
1. Age	Young or elderly adults	No age limit
2. Face	Usually pale, petechiae less common	Congested, livid with petechiae
3. Signs of asphyxia	Less marked	Well marked
4. Tongue swelling and protrusion	Less marked	More marked
5. Bleeding from nose, ears, mouth	Less common	More common
6. Neck	Stretched, elongated	Not so
7. Ligature mark ('furrow') <ul style="list-style-type: none"> • Direction • Continuity • Level in the neck • Base 	Oblique Non-continuous Above thyroid Pale, hard, parchment-like	Transverse Continuous Below thyroid Soft and reddish
8. Knot	Single, simple, slip knot, on one side of neck	Multiple, granny or reef type, tied with force
9. Abrasions and ecchymoses about the edges of mark	Not common	Common
10. Involuntary discharge of feces and urine	Less common	More common
11. Involuntary discharge of seminal fluid	More common	Less common
12. Bruising of neck muscles	Less common	More common
13. Subcutaneous tissue under the mark	White, hard, glistening	Ecchymosed
14. Hyoid bone fracture	May occur	Uncommon
15. Thyroid fracture	Unlikely	More common
16. Larynx and trachea fracture	Unlikely	May be found
17. Emphysematous bullae on lungs	Sometimes present	Very common
18. Carotid arteries	Damage may be seen in intima	Rare
19. Design	History of previous unsuccessful attempts of suicide may be available	No such history is available
20. Suicide note	Usually present	Not present
21. Place of occurrence	Usually in own bed room with doors and windows bolted from inside	Any place, not necessary inside room, not bolted from inside
22. Signs of struggle	Absent	Always present, unless taken unaware

Postmortem Examination

- The external signs are abrasions and bruises on the front and sides of the neck and are commonly at each side of the laryngeal prominence and just below the jaw line. The injuries may extend onto the upper part of the sternal area.
- When pressure is prolonged, the classical signs of asphyxia may be seen—cyanosis, edema and congestion of the face, Tardieu's spot in the eyes and face, and sometimes bleeding from nose and ears.
- The tips of the fingers produce bruises. They may be oval or round and 1.5-2 cm in size (may be more in case of continued bleeding). Presence and extent of fingertip bruising and nail scratch abrasions will depend upon:
 - i. Relative position of victim and assailant.
 - ii. Manner of grasping of neck, whether from front, back or sides.
 - iii. Amount of pressure exerted.
 - iv. Whether single or both hands have been used.

- v. Sex, age, condition of vessels and nutrition of individual.
- vi. Condition of nails of assailant.

Important to note that:

- Bruises made by tips of thumbs are more prominent than with other fingers.
- Multiple abrasions on the neck may also result from use of victim's hands in an effort to dislodge the assailant's grip. These curvilinear marks commonly lie close to areas of bruising and are often horizontally orientated. If these are from the assailant, they are usually vertical.

External Findings

- i. If the assailant uses single hand from front:** Thumb will be applied on one side and other fingers on opposite side of neck. A grip from right hand produces a bruising due to bulb of pressing thumb over the cornue of hyoid/thyroid on anterolateral surface of right side of victim's neck and several fingertip bruising marks and overlying nail scratch abrasions over left side; being directed obliquely downwards and outwards, usually one below the other (Fig. 10.10). Concavities of nail markings and their direction will indicate the relative position of victim and assailant.
- ii. If the assailant uses both hands:** When both hands are used, evidence of pressure of thumb mark of one hand and finger marks of other hand are usually found on either side of throat. In case of grip from behind, the pressure is applied all around the neck, but some areas of bruising will be more prominent than others, because of pressing fingertips.

Because of struggle and resistance, marks of bruising and abrasions may be found over the face, nostrils, lips, chin, cheeks, forehead and lower jaw of the victim. These can also be caused in an effort to stop the victim from shouting or crying for help.

It is therefore important to examine the nails of the victim and fingernail scrapings of the alleged assailant when possible, so that these can be compared with tissue type of the victim.

Internal Findings (Fig. 10.11)¹²

- i. Extravasation of blood in subcutaneous tissues underneath the external marks of bruising and abrasions is the *most significant internal sign*.**

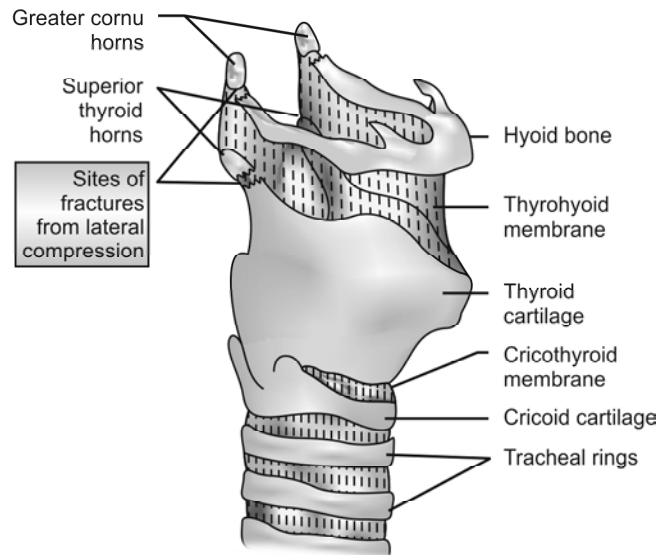

Fig. 10.11: Larynx: Sites of fracture from lateral compression (throttling)

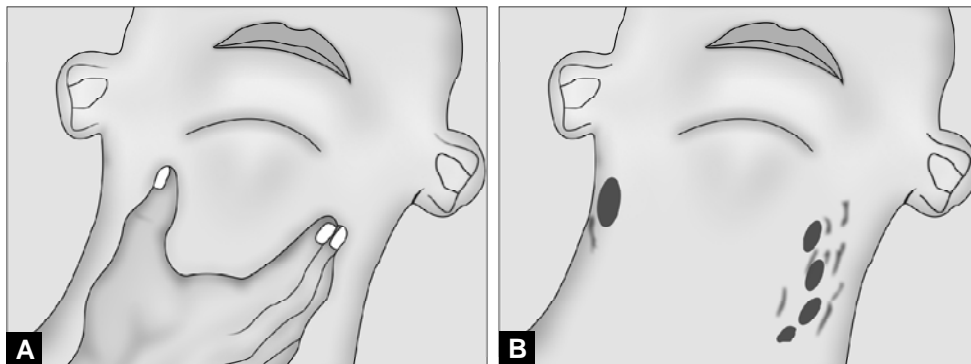

Fig. 10.10: (A) Compression of neck with single hand and (B) External findings in neck

- ii. Tear/laceration of platysma or sternomastoid muscles may be seen.
- iii. Tongue may be bruised/lacerated, may protrude out and bitten by teeth.
- iv. Hemorrhages, varying from pinpoint ecchymosis to extensive extravasation may be found in mucous membrane of larynx, epiglottis, pharynx, and peritonsillar region.
- v. Inward compression *fracture of hyoid bone* is the most *diagnostic finding of throttling*.¹³
- vi. Fracture of superior horns of thyroid cartilage is common, though both horns do not get fractured simultaneously.
- vii. Ribs may be fractured, if murderer kneels on the chest of the victim.
- viii. There may be laceration of carotid sheath and tear of inner coat of carotid artery.
- ix. Cricoid is usually not fractured.

Fractures of the superior horn of thyroid cartilage are not limited to fatal neck compression. Direct blunt trauma (e.g. motor vehicle impact or fall from height), resuscitation and poor autopsy technique can lead to this injury.

- **Accidental throttling:** Sudden application of one or both hands on a person's throat as demonstration of affection, in joke, or as a part of physiological experiment may cause death due to vagal inhibition.

Q. How much force an assailant could have used?

- If there is damage to neck structures, it indicates use of considerable force and is indicative of intent to injure, if not to kill.
- If there is fracture of hyoid bone/larynx, it indicates use of appreciable force and is homicidal in nature.
- Minor damage or absence of damage to the neck structures can kill without producing much damage, e.g. karate blow.
- If only slight changes are seen in neck structures, a guarded opinion should be given about the probable degree of force used.

The amount of force required to compress neck structures, is estimated as—jugular vein: 2 kg, carotid artery: 5 kg, trachea: 9 kg and vertebral artery: 30 kg. This implies that venous flow is decreased before arterial and airway obstruction occurs. For fractures of thyroid cartilage lamina: 14.3 kg and cricoid cartilage: 18.8 kg force is required.

Medico-legal Questions

Q. Whether death was due to throttling?

Diagnostic signs are:

- i. Bruising and abrasions on face and neck with or without rupture of neck muscles.
- ii. Engorgement of tissues at and above the level of compression.
- iii. Fracture of thyroid cartilages and hyoid bone.
- iv. General signs of asphyxia.
- v. Fracture of cricoid is almost pathognomic of throttling.

Q. Whether throttling was suicidal, homicidal or accidental?

- **Self-throttling** is impossible, because as soon as unconsciousness supervenes, the hand will relax and the grip will be released.
- **Homicidal throttling:** *Common mode of homicide* as the hand is immediately available and method of choice in infants. Victims are usually infants, children or women (associated with sexual assault). In adults, signs of struggle are usually present, but if throat is seized firmly and compressed, victim cannot struggle. Adults can be throttled when under the influence of drugs/drinks or stunned or taken unaware. If contusions and fingernail abrasions are present on neck, the presumption must be of homicide.

Hyoid Bone Fractures

Fracture of the hyoid bone occurs in 50-70% of cases in subjects above 40 years and can be classified as:

Inward (side-wise) Compression Fractures

- They are seen in cases of *throttling*, as the fingers of the grasping hand squeeze the throat, the greater cornu of hyoid are compressed inwards causing fracture of the bone with tear of its periosteum on the outer side and not on the inner side, displacing the posterior fragment inwards (Fig. 10.12).
- This type of fracture can occur on both sides.
- A similar fracture may be seen at the joint between the greater cornu and body of hyoid.
- **Demonstration:** If the body of hyoid is grasped in one hand, and the distal fragment between the finger and thumb of the other hand, the distal fragment can be easily bent in inward direction, but outward movement is limited to normal position only.

Antero-posterior Compression Fractures

- It is seen in *hanging*; due to anteroposterior compression, hyoid bone is driven directly backward, divergence of greater cornu is increased causing fracture with outward displacement of posterior small

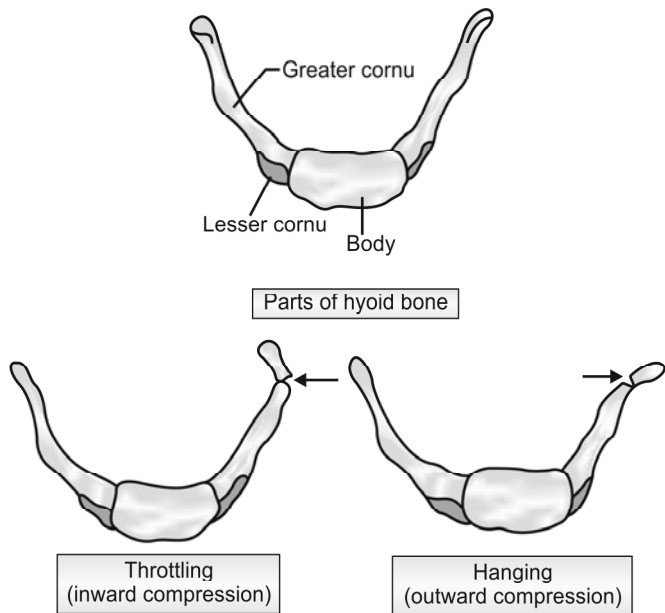

Fig. 10.12: Hyoid bone fracture

fragment. As a result, periosteum on inner side of fracture is torn when the fragment can be easily moved outwards, but inner movement is limited to normal position only (Fig. 10.12).¹⁴

- This type of fracture can also occur in the greater cornu at its junction with the body and it may be bilateral.
- They are also seen in ligature strangulation, run over motor vehicle accident and blows on front of neck by any means, e.g. rods, foot or stick.

Avulsion or Traction or Tug Fracture

It occurs due to hyperextension of the neck or muscular over-activity, as result of traction on thyrohyoid ligament either by downward or lateral compression or when direct pressure is exerted between hyoid and thyroid by pressing fingers. The hyoid is drawn upwards and held rigid.

It may be noted that:

- Cartilaginous separations between the greater cornu and body, joints between lesser cornu and body or the presence of incomplete bony union of hyoid parts should not be mistaken for fractures.
- A hyoid fracture should not be diagnosed as antemortem in origin, if there is no recent hemorrhage at alleged traumatized site.

- Chronic alcoholics are predisposed to hyoid fracture.
- Fractures of the hyoid can also be seen in natural deaths, presumably from intense muscle contractions during the agonal stages or following violent coughing.

Suffocation

Definition: It is a form of asphyxia caused by mechanical obstruction to the passage of air into the respiratory tract *by means other than constriction of neck or drowning.*

Classification¹⁵

- | | |
|-----------------------|---------------|
| i. Smothering | ii. Choking |
| iii. Gagging | iv. Overlying |
| v. Traumatic asphyxia | vi. Burking |

i. Smothering

Definition: It is a form of asphyxia caused by mechanical occlusion of external air passages, i.e. the nose and mouth by hand, cloth, plastic bag or other material.

Postmortem findings

- Abrasions and bruises around the mouth and nostrils. These may not be seen, if soft materials, like cloth or pillow has been used.
- Injuries on the inside of the lips from pressure of teeth are seen.
- Bruising of gums or sometimes tears of delicate tissues are seen.

These findings may be missed, unless looked for.

Medico-legal aspects

- Accidental smothering is common in alcoholics or epileptics who may fall or roll over in a heap of mud or such other material.
- After birth, an infant may die from smothering, if he is born with membranes covering the nose and mouth (*cul-de-sac*).
- Children may get suffocated while playing with plastic bags over the face or head.

Plastic bag asphyxia results from decreased oxygen concentration in the available inspired air and physical obstruction of the mouth and nose. The plastic bag becomes electrically charged and adheres to the face, aided by condensation. It is a common method of suicide among the elderly and debilitated individuals. It can also be seen in autoerotic asphyxia, drug misadventure—volatile inhalants (e.g. chloroform or propane), inhalation of volatile hydrocarbons (e.g. trichlorethane) or accidental deaths in children.

ii. Choking

Definition: It is a form of asphyxia caused by an obstruction within the air-passages by a foreign object, like coin, fruit seed, toffees, candies, fish or any other material.¹⁶

In an epileptic attack, tongue may fall back on to posterior pharyngeal wall causing choking.

The phases of acute fatal airway obstruction are:

- i. Penetration of the object into the airway.
- ii. Obstruction of the airway.
- iii. Failure to expel once the obstruction has occurred.

Mechanism: Initially there is stridor, respiratory distress, coughing and the inability of the victim to speak. This is followed by a rapid, deep inhalation which causes the foreign object to pass further down the airway. Laryngospasm occurs followed by vagal stimulation, leading to arrhythmia and apnea and death.

Cause of death

- i. Asphyxia.
- ii. Vagal inhibition.
- iii. Laryngeal spasm.
- iv. Delayed death from pneumonia, lung abscess or bronchiectasis.

Postmortem findings

- i. Signs of asphyxial death. Sub-conjunctival hemorrhages without cutaneous petechiae may be seen.
- ii. Presence of food items or foreign body in respiratory tract. The food items are usually round and firm, yet pliable to allow molding in the airway.
- iii. In an epileptic, tongue may show bite marks or bruising.

Medico-legal aspects

Although most choking deaths are accidental; suicide and homicide are possible.¹⁷

- Accidental choking deaths are common in children < 1 year of age. Ninety percent of choking deaths happen before the age of 5 years.
- Homicidal choking usually involves the aged, individuals debilitated by disease, alcohol or drugs, and infants. When objects are forced into the mouth, signs of a struggle, if the individual was conscious, may be noted. Perioral, teeth, tongue and other intraoral injuries can result.
- Suicidal choking is uncommon and may occur in psychiatric patients and prisoners.

Café-coronary

This is a condition of *accidental choking* where a bolus of food produces complete obstruction of the larynx. It is called so, because it mimics a heart attack and is usually seen in an intoxicated restaurant patron.¹⁸

Causes

- *Predisposing factors* include a decreased protective airway reflex resulting from aging, poor dentition with a tendency to swallow food whole, alcohol consumption and ingestion of large doses of tranquillizers and other CNS depressants *impairing the gag reflex*.
- Reflex cardiac arrest as a consequence of stimulation of laryngeal nerve endings from 'vagal inhibition'.

Clinical findings: Victim who was apparently healthy collapses suddenly turning blue while eating at a dining table.

Treatment (for choking)

- i. If there is difficulty in breathing and cyanosis, give first aid by application of pressure on the abdomen (Heimlich maneuver) till the patient recovers or loses consciousness.¹⁹
- ii. A blow on the back or on the sternum may cause coughing and expel the foreign body.
- iii. The victim is placed in a supine position and the mouth is opened to perform a finger sweep.
- iv. If this is not successful, the foreign body should be removed from hypopharynx with the middle and index fingers or with forceps.
- v. If the object cannot be removed, the person may need a tracheotomy/cricothyrotomy.

Postmortem findings

Bolus of unchewed food or such material is found impacted in larynx or trachea. A litmus paper test of the bolus can be made to determine the acidity, to ascertain its origin (mouth or vomitus).

Medico-legal aspects

It is a case of accidental death (asphyxia) as opposed to natural, so additional insurance claims can be made.

'Creche coronary': Choking occurring in children aged 1-3 years as they are more vulnerable because of their increased mobility, putting inappropriate small objects in their mouth or appreciate the size of a piece of food, small airways, inadequate dentition for chewing and weaker cough reflex.

iii. Gagging

Definition: Gagging is a form of asphyxia which results from pushing a gag (rolled up cloth or paper balls) into the mouth, sufficiently deep to block the pharynx. It combines the features of smothering and choking.

Initially, the airway may be patent through nose, but collections of saliva, excessive mucus with edema of pharynx and nasal mucosa causes complete obstruction.

Postmortem findings

- i. Same as choking.
- ii. Injuries to nose and mouth with seepage of blood into the back of throat.

Medico-legal aspects

- Almost always homicidal and the victim is usually an infant or an elderly person.
- Gagging is usually resorted to prevent the victim from shouting for help; death is usually unintended.
- Gags have been used to suppress screams by victims using a painful method of suicide (e.g. self-immolation).

iv. Overlaying

- Overlaying or compression suffocation results from compression of the chest, nose and mouth, so as to prevent breathing.
- It is a form of accidental smothering of an infant by a nursing mother, sharing a bed with her child who may roll over during sleep and occlude the air passages.
- Ethanol intoxication or a medical condition can be a factor depressing an arousal response in the older bed-sharer.

Postmortem findings: Face, nose and chest of victim child may appear compressed and pale. Pressure marks from bedding or clothing may be seen on the victim, but these can happen postmortem. Usual findings of asphyxia will be seen along with intrathoracic petechiae.

Medico-legal aspects

- Purely accidental in nature.
- It may also be a case of infanticide.
- These cases are likely to be victims of sudden infant death syndrome (SIDS).

v. Traumatic Asphyxia/Crush Asphyxia

Definition: Asphyxia resulting from respiratory arrest due to mechanical fixation of chest, so that the normal movements of chest wall are prevented.

Causes²⁰

- i. Due to house collapse, accidentally or in wars/earthquake.
- ii. Stampede by crowd, running in panic, e.g. due to outbreak of fire in a cinema hall/public gathering.
- iii. Run over by a vehicle or overturned vehicle (especially tractors).
- iv. Collapse of wall inside a mine or trenches (cave-in) in bunkers of sand or grain.

- v. When held between the buffers of two bogies of a train.
- vi. Restraint of suspects by *hogtying* practiced in some states in US by the police.

Mechanism: The essential feature is fixation of the thorax by severe compression or external pressure that prevents respiratory movements. An individual can die in seconds if there is considerable weight, but usually at least 2-5 min elapse before death ensues.

Postmortem examination

External findings

Characteristic features seen are:

- i. **Masque ecchymotique** refers to the classical appearance of:
 - a. Florid red or blue congestion of face and neck with variable involvement of the upper thorax, back and arms.
 - b. Deep cyanosis of face.
 - c. Numerous petechial hemorrhages or ecchymoses.
 - d. *Demarcation line:* Level of compression is indicated by a well-defined demarcating line between the discolored upper portion of body and the lower normal part.
- ii. Areas of pallor seen at the level of collar of shirts, folds or creases in the garments.
- iii. Facial edema.
- iv. External blunt trauma injuries can be seen on the head, neck and chest along with mud or other foreign material.

Internal findings

- **Eyes:** Purtscher's retinopathy (retinal hemorrhages).
- **Face:** Nose, ear or pharyngeal petechiae/ecchymoses that may result in external bleeding—mimics a basal skull fracture.
- **Bones:** Rib and clavicle fractures are common; extremity and pelvic fractures may be seen.
- **Upper respiratory tract:** Edema, epiglottic and laryngeal petechiae.
- **Lungs:** Congested, heavy, subpleural petechiae; contusions/lacerations and hemo-/pneumothorax may be present.
- **Heart:** Right heart and veins above aorta may be distended, injuries are rare.
- **Abdomen:** Hepatic and splenic lacerations may be found.
- **CNS:** Edema and petechiae can be seen.

Medico-legal aspects

Mostly accidental, but fallen appliances or furniture particularly over children has been described as a means of homicide.

- In survivors, discoloration disappears within a few weeks and does not undergo the color changes seen with the healing of bruises. The color is not altered by the administration of oxygen. Petechiae disappear within days, but subconjunctival ecchymoses can persist for weeks, eventually fading to yellow and disappearing.
- **Mechanism of masque ecchymotique:** Retrograde displacement of blood from superior vena cava into the subclavian veins and veins of the head and neck results from sudden compression of the chest or abdomen. Valves in the subclavian veins prevent the spread of hydrostatic force to the veins of upper limbs. But, the displacement of the blood into the valve-less veins of the head and neck causes rupture of distal capillaries. Therefore, face and neck of the victim are deeply cyanosed; eyes bloodshot and numerous petechiae over scalp, face, neck and shoulders are seen.

vi. Burking

- It is a combination of homicidal smothering and traumatic asphyxia (Fig. 10.13).
- *William Burke and William Hare* killed 16 persons during 1927-28 in Scotland and sold their bodies to Dr. Robert Knox for use as specimens in his anatomy classes in Edinburgh Medical School, in what became known as the case of the *Body Snatchers* (West Port murders).
- **Method:** A victim was invited to their house and given alcohol. When drunk, he was thrown on the ground and Burke would kneel or sit on the chest

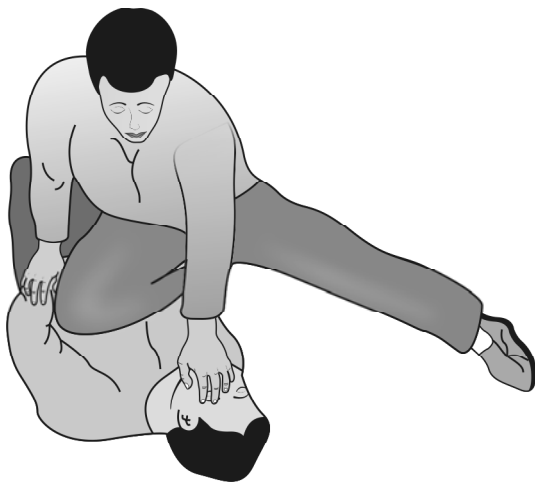

Fig. 10.13: Burking

and close the nose and mouth with his hands, and Hare used to pull him around the room by the feet.

Wedging is a form of mechanical asphyxia in which the face, neck or thorax is compressed between two firm structures. It is common in 3-6 months old children when they start to move to the corners of beds and cribs, but they do not have the muscle development to free themselves out of a wedged position. They become wedged between the mattress and either the wall, bed frame, a piece of furniture, mesh or another mattress.

Drowning

Definition: Drowning is the process of experiencing respiratory impairment from submersion/immersion in liquid.

- Implicit in this definition is that a liquid-air interface is present at the entrance to the victim's airway which prevents the individual from breathing oxygen.
- Outcome may include delayed morbidity, delayed or rapid death, or life without morbidity.
- Terms wet or dry drowning, active or passive drowning, near-drowning and secondary drowning would be discarded (World Congress on Drowning, Amsterdam 2002).

Drowning was previously defined as death secondary to asphyxia while immersed in a liquid, usually water, or within 24 h of submersion. The definition excluded aspiration of vomit, blood, saliva, bile or meconium.

Classification (Flow chart 10.3)

I. TYPICAL OR WET DROWNING

Water is inhaled into the lungs and the victim has severe chest pain (seen in 80-90% of cases). It is also known as *primary drowning*.

Flow chart 10.3: Classification of drowning

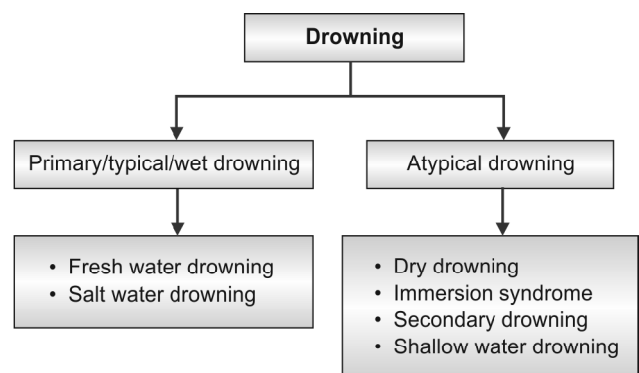

- *In fresh water and brackish water drowning* (0.5-0.6% NaCl), the aspirated water is rapidly absorbed from the alveoli into the circulation leading to hemodilution and hemolysis. Circulatory overload, hyponatremia, hyperkalemia, together with myocardial hypoxia result in fall of systolic blood pressure followed by ventricular fibrillation (Flow chart 10.4 and Fig. 10.14).^{21,22}
- *In sea (salt) water drowning* (3-4% salinity), the aspiration of water results in withdrawal of water from the pulmonary circulation into the alveolar spaces as a result of the osmotic differential, while at the same time electrolytes (sodium, chloride, magnesium from sea water) pass into the blood. There

is hemoconcentration with crenation of RBCs, but not hemolysis and little change in the sodium/potassium balance.^{23,24} The pulse pressure decreases slowly and is followed by A-V dissociation, but not ventricular fibrillation (Flow chart 10.4 and Fig. 10.15).

In both fresh water and salt water drowning, there is terminal pulmonary edema.

II. ATYPICAL DROWNING

1. Dry drowning

- In dry drowning, water does not enter the lungs due to laryngeal spasm induced by small amounts of water entering the larynx.²⁵
- Seen in 1-2% of cases.

Flow chart 10.4: Mechanism of fresh and sea water drowning

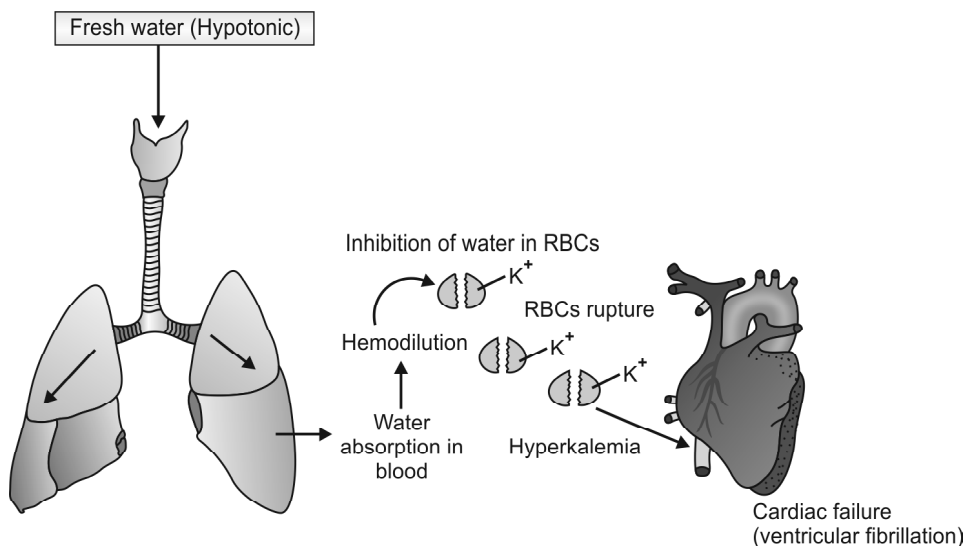
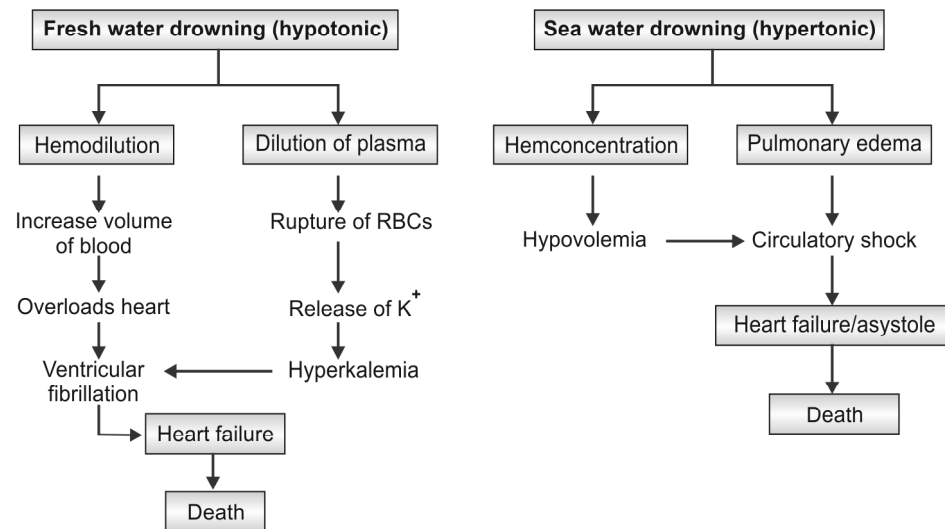

Fig. 10.14: Mechanism of death in fresh water drowning

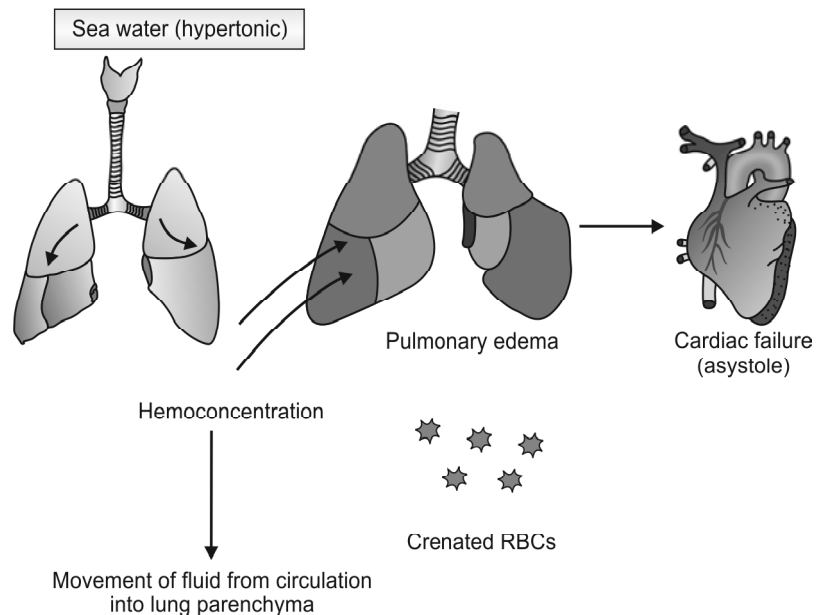

Fig. 10.15: Mechanism of death in sea water drowning

- Death may be extremely rapid and time elapsed is insufficient for typical drowning to occur. Two mechanisms have been postulated:
 - i. Reflex cardiac arrest due to vasovagal stimulation.
 - ii. Laryngeal spasm due to airway closure causing lethal hypoxemia.
 - In these cases, autopsy findings and biological tests for drowning are negative and the lung fields are dry.
 - 2. **Immersion syndrome** (*Hydrocution, submersion inhibition or cold water drowning*)²⁶
 - The syndrome occurs as a result of:
 - i. Cold water stimulating the nerve endings of the surface of the body.
 - ii. Water striking the epigastrium.
 - iii. Cold water entering eardrums, nasal passages, pharynx and larynx.
 - iv. Falling or diving into water with feet first or *duck diving* by the inexperienced.
 - **Mechanism:** Sudden immersion in cold water may initiate cardiorespiratory reflexes lasting about 2-3 min which is termed as 'cold-shock' response. The initial response include an immediate reflex peripheral vasoconstriction, increase in heart rate and increase in cardiac output with resulting increase in arterial and venous pressure. These significantly increase the workload of the heart and coupled with concomitant increased catecholamine levels which may induce fatal arrhythmias.
 - The findings of typical drowning are absent because aspiration of water into the lungs does not occur.
 - The syndrome particularly affects the middle-aged or elderly men who have ingested some amounts of ethanol. Underlying cardiac disease could increase the risk of sudden collapse.
 - 3. **Near drowning** (*post-immersion syndrome or secondary drowning*)
 - Near drowning refers to survival beyond 24 h after a submersion episode.
 - Death is caused by complications or sequelae (e.g. ARDS, pneumonia, sepsis, hypoxic-ischemic encephalopathy, cerebral edema and DIC).
 - *Secondary drowning* sometimes refers to a victim who initially responds well to resuscitation but then suffers respiratory decompensation.
 - 4. **Shallow water drowning** (*submersion of the unconscious*): Alcoholics, drugged, epileptics, infants, children and unconscious persons may die due to drowning in shallow water in a pit or drain.
- Epidemiology**
- Drowning victims are predominantly male (> 65%). It occurs in the summer months, more frequently seen in rivers, lakes, ponds and creeks.
 - The age groups affected are the children (< 4 years) and young adults (15-24 years). Drugs and alcohol abuse among the teenagers are other associated factors.

Cause of Death

- i. *Asphyxia*: Most common cause of death.
- ii. In fresh water drowning, death results from *ventricular fibrillation*. While in salt water, it is due to *cardiac arrest* from fulminant pulmonary edema and associated changes.
- iii. *Vagal inhibition* due to impact with water.
- iv. *Laryngeal spasm*.
- v. *Concussion/head injury*.
- vi. *Apoplexy*: Subarachnoid hemorrhage from rupture of Berry aneurysm or cerebral hemorrhage by rupture of cerebral vessels from sudden on-rush of blood to the brain due to excitement or sudden fall from height into cold water.
- vii. *Secondary causes*
 - Septic aspiration pneumonia
 - Sudden bursting of aneurysm

Symptoms: Apart from recalling of memory of past events, there may be mental confusion along with auditory and visual hallucinations, tinnitus and vertigo. In wet drowning, there is chest pain.

Treatment: First and immediate step consists of application of artificial respiration with closed chest cardiac massage, even in absence of pulse and respiration and irrespective of injuries sustained during drowning. Defibrillator should be used when there is ventricular fibrillation.

Fatal period

- Fresh water drowning: 4-5 min.²⁷
- Sea water drowning: 8-12 min.

Postmortem Examination

- The diagnosis of drowning is one of exclusion.
- Most of the signs are not specific of death due to drowning and are rather signs of submersion of body underwater for some period. Any dead body, whatever the cause of death, will develop signs of immersion, if left for a sufficient time in water.
- Moreover, some of the signs are not appreciable in case of putrefaction.

When freshly removed from water, the body and clothes will be wet. There will be sand and mud particles on the body, hair and clothes. This finding is not specific of antemortem drowning or death due to drowning.

External Findings

- i. **Face** is pale, becomes bloated and discolored with putrefaction. Cyanosis is present.

- ii. **Eyes** are found half open or closed, conjunctiva suffused and pupils are dilated. Sub-conjunctival hemorrhages may be present in lower eyelids.
- iii. **Tongue** may be swollen and protruded.
- iv. **Postmortem lividity**: Light pink in color, present over face, neck, front of upper part of chest, upper and lower limbs as the body usually floats with face down, buttocks up, legs and arms hanging down in front of the body (Fig. 10.16). With onset of putrefaction, skin of head and neck become dark with '*tete de negre*' appearance.
- v. **Froth**: Presence of fine, copious white 'shaving-lather' like froth at the mouth and nostrils is the *most characteristic antemortem external finding*.^{28,29} Production of this tenacious, fine, lathery foam is a vital phenomenon.
 - The mass of foam, consisting of fine bubbles, does not collapse when touched with the point of a knife.
 - It may be absent when wiped off, but reappears again by itself or by applying simple pressure on chest.

Mechanism of production of froth: The inhalation of water irritates the mucous membrane of air passages due to which the tracheal and bronchial glands secrete large quantities of tenacious mucus and the alveolar lining cell irritation produces edema fluid. Vigorous agitation of the seromucoid secretion, surfactant, aspirated water and retained air converts the mixture of endogenous and drowning medium into froth.

Other conditions in which froth is seen:

- Strangulation
- Putrefaction
- Epileptic fit
- Electric shock
- Acute pulmonary edema
- Opium/OPC poisoning

In all these cases, froth is not fine, not of such large quantity or tenacious in nature as in drowning.

- vi. **Cutis anserina** (*goose skin/goose flesh/goose bumps*) is a state of puckered and granular appearance of

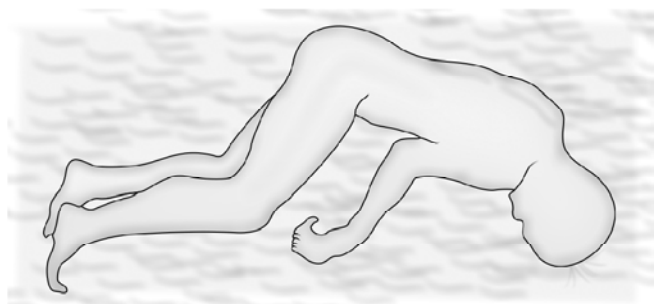

Fig. 10.16: Position of a submerged dead body

skin of the extremities immersed in cold water due to contraction of erector pilorum muscles. It can occur on submersion of the body in cold water immediately after death while the muscles are still warm and irritable, and also produced by rigor mortis of erector muscles.³⁰

- vii. **Washerwomen's hand** is the wrinkled, sodden, bleached appearance of palms, palmer aspect of fingers and soles of feet including plantar surface of toes due to submersion of the body. Maceration of skin occurs due to imbibation of water into its outer layers. It is first seen in the fingertips by 3-4 h and whole hand by 24 h.
- viii. Scrotum and penis get retracted in contact with cold water in winter months.
- ix. Grass, gravel, mud, sand, weeds or aquatic vegetations held firmly in clenched hands due to *cadaveric spasm* which is a *vital proof of antemortem drowning*. The material clenched in the hands indicates the place of submersion.
- x. **Rigor mortis** appears early, especially when a violent struggle for life has taken place before death.
- xi. **Antemortem injuries** might be sustained during fall into water, along the tank, or by striking against a hard object while diving in shallow water. Examination of the skin for blunt injuries should be delayed until the body is dry. Abrasions are easily seen after drying which becomes brownish in color.

- **Tete-de-negre** is the French name for a dessert, a pastry covered with black chocolate. According to Harrap's French-English dictionary, tete-de-negre literally means 'nigger-brown' color.
- **Cutis anserina** (Latin *cutis*: skin, *anser*: goose): Another term for this is 'horripilation' (Latin *horrere*: to stand on end, *pilus*: hair).

Internal Findings

1. Lungs

- i. Lungs are voluminous, distended and show ballooning, i.e. bulge out of chest on removal of sternum (Diff.

10.3). Tenacious, lathery froth in trachea and bronchi is present. In case of laryngeal spasm, there will be no ballooning.

- ii. Distended lungs will show indentations of ribs on the pleural surface because of pressure on increased volume of lungs.
 - iii. Lungs feel heavy, boggy and doughy; will easily indent on pressure by fingers because of water logging and edematous condition.
 - iv. Lungs may be congested, but are often pale gray in appearance because of forcing out of blood from lungs and compression of vessels in the interalveolar septa by the trapped air and water in lung alveoli.
 - v. Tardieu's spots over the subpleural tissues are few or none due to compression of blood vessels in interalveolar septa.
 - vi. There may be mottled areas of red and gray distended alveoli, alternating with few bigger areas of extravasation known as **Paltauf's hemorrhage**, from tracking of effused blood along the interlobular septa; mostly seen over the anterior surface and margins of lungs.³¹
 - vii. Cut section of lungs will exude copious amount of frothy bloodstained liquid due to presence of water within alveoli and bronchioles.
 - viii. Pleural cavities may contain bloodstained fluid, either by permeation through pleura or postmortem disintegration of lungs and pleurae.
- The overall picture of lungs and respiratory passage in *wet drowning* has been described as **emphysema aquosum** (*emphysema hydroaerique*) as it resembles the pulmonary hyperinflation seen in obstructive lung disease. There is dilation of alveoli, thinning of alveolar septae and compression of alveolar capillaries.
 - When the person is unconscious at the time of drowning, **edema aquosum** develops. It is a state of mere flooding of lungs with the airless water and no formation of froth. Emphysema aquosum develops

Differentiation 10.3: Lungs in fresh water and sea water drowning

S.No.	Feature	Fresh water drowning	Sea water drowning
1.	Size and weight	Ballooned, but light	Ballooned and heavy
2.	Color	Pinkish	Purplish or bluish
3.	Consistency	Emphysematous	Soft, jelly-like
4.	Shape after removal from body	Retained, do not collapse	Not retained, tend to flatten out
5.	On cut section	Crepitus is heard, little froth and no fluid	No crepitus, copious fluid and froth

only when the conscious victim of drowning struggles for survival.

- When a dead body is thrown into water, even though **hydrostatic lungs** (due to hydrostatic pressure water passes into the lungs) are produced, yet there will be *no classical signs of drowning lungs*. A drowning lung together with frothy fluid is diagnostic.

2. Larynx, trachea and bronchioles

- Presence of sand, mud, silt, dirt, aquatic vegetations, classical water flora, algae and diatoms in the trachea and lower bronchial tree are characteristic positive findings of antemortem drowning.
- Fine white froth, at times blood tinged in the lumen of trachea and bronchi, interspersed with foreign material as above, is highly *suggestive of death from antemortem drowning*.
- Mucosa of larynx, trachea and bronchioles may be red and congested.
- Vomit reflex due to medullary hypoxia may result in regurgitation of gastric contents into larynx, trachea and bronchioles.

- Heart and blood vessels:** Like in other forms of asphyxia, left side of heart will be usually empty; the right heart will be full with the venous system engorged with dark blood, unusually fluid in consistency because of admixture with water.

Gettler test: Normally the *chloride content* of the right and left side of heart is nearly same, about 600 mg/100 ml. If difference is 25 mg% or more, it is suggestive of antemortem drowning.³²

- In case of *fresh water drowning*, the chloride content of the blood of left heart will be lower than that in right because of dilution by water.
- In case of *salt water drowning*, chloride content of left heart will be greater than right heart because of hemoconcentration and mixing with salt water.
- No change in chloride content of heart is seen in persons dying of laryngeal spasm or vagal inhibition, putrefaction, patent foramen ovale or if the saline content of drowning medium approximates that of blood.

Plasma magnesium: A high level of plasma magnesium in left heart blood is observed than in right heart blood and is due to absorption of magnesium from the drowning medium, particularly salt water.

4. Stomach and small intestines

- Stomach contains water in 70% of cases, but it is possible that the victim might have drunk the same

water before death. When a disagreeable liquid is found which could not be swallowed voluntarily and which corresponds to drowning medium, like muddy water, it is a valuable indication of antemortem drowning.

- Water is not found in the stomach, if the person died from shock, syncope, putrefaction and was already dead (postmortem submersion).
- Small intestine may contain water in about 20% cases. This is regarded as *positive evidence of death by drowning* as it depends on peristaltic movement which is a vital phenomenon.

Water may enter the mouth and pass down into the stomach passively if the water is turbulent, rather than the victim actively swallowing it. It may also be due to the postmortem relaxation of the gastroesophageal sphincter which allows water to enter the stomach.

- Brain:** Congested gray matter, softening and loss at the gray-white junction.
- Liver, spleen and kidneys** are congested.
- Middle ear:** Presence of water and hemorrhage in middle ear is claimed to be one of the *positive proof of antemortem drowning*. Hemorrhages in petrous temporal bone or in mastoid air cells may be seen. Temporal bone hemorrhages are also seen in death due to hanging, head injury and carbon monoxide poisoning.
- Ethmoid and sphenoid sinuses:** Water may enter the respiratory sinuses; the jugum sphenoidale may be removed to expose the contents of the sphenoid sinus.
- Diatom test:** Diatoms belong to the class Bacillariophyceae and are microscopic unicellular algae which secrete silicon skeletons called *frustules*; they are chemically inert and almost indestructible, being resistant to strong acids (Fig. 10.17). During drowning, diatoms (size upto 60 μ) enter the circulation via the lungs through the ruptured alveolar walls, lymph channels and pulmonary veins into left heart and then into general circulation, when the person is alive (Fig. 10.18).³³
 - Presence of diatoms in the lung substance, blood stream, brain, liver, kidneys, bone marrow of femur (best site for analysis)³⁴ or humerus or in the skeletal muscle has been claimed to be *suggestive proof of antemortem drowning*.³⁵
 - Since diatoms resist putrefaction, diatom test may have some value in examination of decomposed bodies.
 - The test is *negative* in dead bodies thrown in water and in dry drowning.

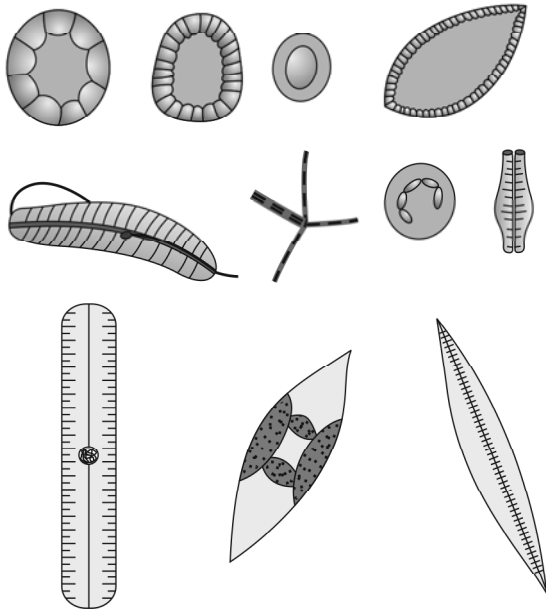

Fig. 10.17: Different types of diatoms

Procedure: A sample of tissue is carefully retrieved to avoid surface contamination. Approximately 50 g of tissue is taken and placed in 50 ml of concentrated nitric acid in a boiling flask. The flask is heated for

48 h, cooled and the liquid is centrifuged for 20-30 min. The supernatant is discarded and the sediment is re-centrifuged. The final residue is aspirated and placed on a clean glass slide and air dried. It is then examined for silica skeletons of diatoms which are birefringent using phase-contrast microscopy or dark ground illumination. A water sample is collected at the time of body retrieval in a clean container and similarity of different species of diatom is compared.

Interpretation

The presence of diatoms supports the diagnosis of drowning, while the absence of diatoms does not exclude it as a cause. The diatom test is valid only if it can be shown that:

- Deceased did not drink this water immediately before submersion.
- Species recovered from specimen are present in the sample from site of drowning.
- The various species are present in same order of dominance for the admissible size range and in approximately same proportions.

The test is limited by the difficulty of excluding the possibility of environmental contamination. Diatoms are ubiquitous in the environment and may enter the

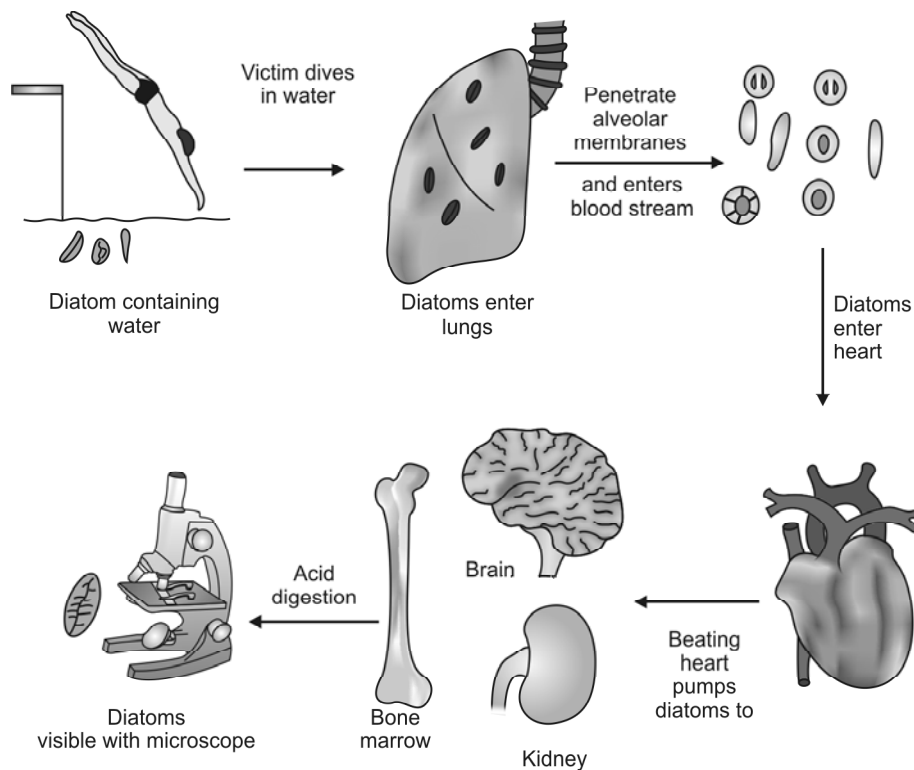

Fig. 10.18: Principle of diatom test

circulation via the GIT (as contaminants of foods, such as salads, watercress and shellfish) or via the respiratory tract (diatoms are normally present in small numbers in the air, in some paints, building plasters and dusts).

Medico-legal Questions

Q. Whether death was due to drowning?

Drowning is one of the most difficult modes of death to prove at postmortem, especially when the body is not examined in a fresh condition (Diff. 10.4).

In doubtful cases, where definite opinion cannot be given, viscera and body fluids should be preserved for chemical analysis. Sometimes, the cause of death may have to be given as '*consistent with drowning*'.

Q. Whether drowning was accidental, suicidal or homicidal?

- **Accidental drowning** is *most common* and seen in children, bathers, fishermen, dockworkers, intoxicated and epileptic subjects. Women may fall accidentally in a well, while drawing water. Accidental drowning may occur in precipitate labor, when the baby may fall into a bathtub or lavatory pan and die.
 - Information regarding inability to swim, trauma, seizure disorder, heart disease, exhaustion, alcohol and drug abuse should be sought.
- **Suicide** by drowning is fairly common in India, especially among females. Women usually make sure to tie up their clothes in such manner that their private

parts are not exposed after death. Sometimes, a woman takes her child with her. A determined suicider may tie his hands and legs together or attach weights to his body before immersion. Like wise, he may take poison, cut his throat and jump into a well. If an adult is found drowned in shallow water, the presumption is usually suicide, unless proved otherwise.

- Information/findings that may assist in the determination of suicide: witnesses, clothes and personal effects found stacked by the water, a suicide note and suicidal ideation, a history of cancer or terminal illness, recent bizarre behavior or depression and associated self-inflicted wounds.
- **Homicidal drowning** is not very common, though it is one of the method of choice in infanticide, especially of newborns. While injuries may be found in a case of homicide, it is very easy to drown a person without leaving any suspicious mark behind, especially if the person is non-swimmer, intoxicated or already inside water taking a bath.
- Victims of homicidal violence may be placed in the water after death in order to dispose of the body.

Hyperventilation Deaths

For long underwater swimming, the swimmer may hyperventilate before going down. While swimming, the oxygen gets utilized and the CO₂ produced, being low in tension is not sufficient to stimulate the respiratory centre and the swimmer may then suddenly become unconscious and get drowned.

Differentiation 10.4: Antemortem drowning and postmortem submersion³⁶

S.No. Feature	Antemortem drowning	Postmortem submersion
1. Froth over mouth and nostrils	Fine, lathery froth, appears spontaneously	Absent, even if present, it is coarse, not spontaneous
2. Cadaveric spasm in hands	Aquatic vegetations, mud may be present	Not observed
3. Trachea and bronchioles	Presence of algae, mud along with frothy mucus	Absent
4. Lungs	Ballooned up, bulky, edematous, bear indentations of ribs	Collapsed, decomposed
5. Mud and algae in stomach and small intestine	May be present	Absent
6. Diatom and Gettler tests	Positive	Negative
7. Injuries	If present, need to be consistent with drowning	Injuries inconsistent with drowning
8. Other suggestive signs	Water in middle ear, retracted genitals, cutis anserina, washer-woman's hands, wet clothing, mud and sand	Water is never present in middle ear; others are not valuable and corroborative findings

In skin diving, a mask and fins are used and it is an extension of swimming with similar hazards.

Sexual Asphyxia (Autoerotic asphyxia/ Hypoxyphilia, Asphyxiophilia)

Definition: Autoerotic asphyxia is a paraphilia in which sexual arousal and orgasm depend on self-induced asphyxia upto, but not including loss of consciousness.

- Partial asphyxia caused by pressure on carotid vessels or obstruction of air passages causes cerebral ischemia and may lead to hallucinations of an erotic nature in some men.
- The degree of asphyxia produced by mechanical means is controlled, i.e. the victim is in a position that allows self-release. but in some cases death occurs accidentally.
- These cases are associated with some form of abnormal sexual behavior, usually masochism, cisvestism and transvestism.
- Victims are usually young males, scene is usually the victim's own house, bedroom, bathroom, basement and the door is locked from inside.

Methods

- Hanging:** Most frequent method. The presence of padding under the noose, nakedness of the victim, feminine attire and exposed genitalia are the hallmarks of these deaths. Frequently, the person ties his arms, legs and sometimes waist and genitalia (*bondage*) with a rope, string or chain.

- Sexual gratification may be obtained by **electrical stimulation**. For this, electrodes are applied to the genitals or on abdomen; usually a low voltage supply from a battery is used.
- Other methods** include covering the head in plastic or some impervious bag which may be secured around the neck by an elastic band to achieve partial anoxia. It is sometimes combined with the inhalation of volatile solvents ('glue sniffing').
- Carbon tetrachloride, paint thinners, petrol or amyl acetate are either directly inhaled from container or re-breathed after placing in a plastic bag.

The scene should be examined for:

- Evidence of abnormal sexual behavior and nakedness of the deceased with presence of pornographic material. There may be mirror(s) positioned in such a way to allow viewing of the act.
 - Evidence that the act has been practiced previously, such as worn grooves in rafter or door, where ropes or pulleys have been placed, from verbal communication with others regarding the nature of activities or from diaries, etc.
 - Evidence of attempts to conceal the act by some method, padding to prevent a ligature from leaving marks around neck.
- There is no evidence to suggest it a suicidal act and the situation is ruled as an accident.³⁷

MULTIPLE CHOICE QUESTIONS

- When a person has suspended himself with the knot situated in the region of the occiput, such hanging is called: *AIIMS 04*
 A. Typical B. Atypical
 C. Partial D. Incomplete
- In typical hanging, knot is placed at: *FMGE 09*
 A. Occiput B. Chin
 C. Left side of mandible D. Right side of mandible
- '*La facies sympathique*' is a condition seen in cases of: *AIIMS 05; Maharashtra 10, 11; Punjab 11*
 A. Hanging B. Strangulation
 C. Throttling D. Railway accidents
- Increased salivation is seen in death due to: *JIPMER 03*
 A. Strangulation B. Hanging
 C. Drowning D. Cyanide poisoning
- Following is most suggestive of antemortem hanging: *Karnataka 04; DNB 09*
 A. Salivary dribbling B. Congestion of lungs
 C. Ligature marks D. Petechial hemorrhages
- Lynching is a type of: *Orissa 11; AFMC 11*
 A. Homicidal hanging B. Suicidal hanging
 C. Judicial hanging D. Accidental hanging
- The 'knot' in judicial hanging is placed at: *AIIMS 06*
 A. Behind the neck B. Side of the neck
 C. Below the chin D. Choice of hangman
- Hangman's fracture is: *COMEDK 07; Bihar 10; Manipal 11*
 A. Spondylolisthesis of C2 over C3
 B. Fracture of odontoid process
 C. Fracture of transverse process
 D. Dislocation of C5

1. A

2. A

3. A

4. B

5. A

6. A

7. C

8. A

30. **Cutis anserina is seen in:** *Delhi 03; PGI 05*
 A. Drowning B. Firearm injury
 C. Hanging D. Strangulation
31. **Paltauf's hemorrhages are seen in:** *AP 11*
 A. Brain B. Lungs
 C. Heart D. Liver
32. **Gettler's test is used to diagnose death due to:** *Delhi 06*
 A. Hanging
 B. Strangulation
 C. Burns
 D. Drowning
33. **NOT correct regarding diatoms:** *AI 05*
 A. They are aquatic unicellular plant
 B. Has an extracellular coat composed of magnesium
 C. Acid digestion technique is used to extract them
 D. Its presence in bone marrow indicates antemortem drowning
34. **The best site for taking sample for diatoms test is:** *PGI 05*
 A. Lungs
 B. Bone marrow of ulna
 C. Bone marrow of femur
 D. Muscle
35. **Diatoms are seen in death due to:** *Jharkhand 11*
 A. Strangulation B. Drowning
 C. Electrocutation D. Asphyxia
36. **Death due to drowning is suggested by all, except:** *Delhi 06*
 A. Profuse fine froth which increase on pressure on chest
 B. Cadaveric spasm
 C. Absence of mud/weeds in stomach
 D. Diatoms in bone marrow
37. **Sexual asphyxia is:** *Maharashtra 08; Gujarat 10*
 A. Suicidal death B. Homicidal death
 C. Natural death D. Accidental death

Definitions

- **Injury:** Any harm, whatever illegally, caused to any person in *body, mind, reputation or property* (Sec. 44 IPC).
- **Wound:** *Clinically*, it means any injury where there is breach of natural continuity of skin or mucous membrane. *In medico-legal practice*, the terms wound and injury are synonymous, but strictly wound will include any lesion, external or internal, caused by violence, with or without breach of continuity of skin.

Classification of Wounds/Injuries

Injuries can be classified in many ways:

Based on Causative Factors

1. **Mechanical or physical injuries** (*produced by physical violence, Fig. 11.1*)
 - i. Abrasion
 - ii. Bruise or contusion
 - iii. Lacerated wound
 - iv. Incised wound
 - v. Stab wound
 - vi. Firearm wound
 - vii. Fracture/dislocation of bone, tooth or joint.
- Blunt force trauma is caused when an object, usually without a sharp or cutting edge, impacts the body

or the body impacts the object. Abrasion, contusion, laceration and fracture/dislocation of bone or tooth result from such an impact.

- Sharp force trauma occurs when an object with a sharp or sharpened edge impacts the body. Incised and stab wounds result from such trauma.
- For any given amount of force, the greater the area over which it is delivered, the less severe the wound (as applicable to blunt and sharp trauma).

The severity, extent and appearance of blunt trauma injuries depend on:

- The amount of force delivered to the body
- The time over which the force is delivered
- The region struck
- The extent of surface over which the force is delivered
- The nature of the weapon

2. Thermal injuries

Due to application of heat

- a. General effects (may not cause any visible injury), e.g. heat cramps and heat stroke
- b. Effects of local application, e.g. burns and scalds

Due to application of cold

- a. General effects, e.g. hypothermia
- b. Local effects, e.g. frost bite and trench foot

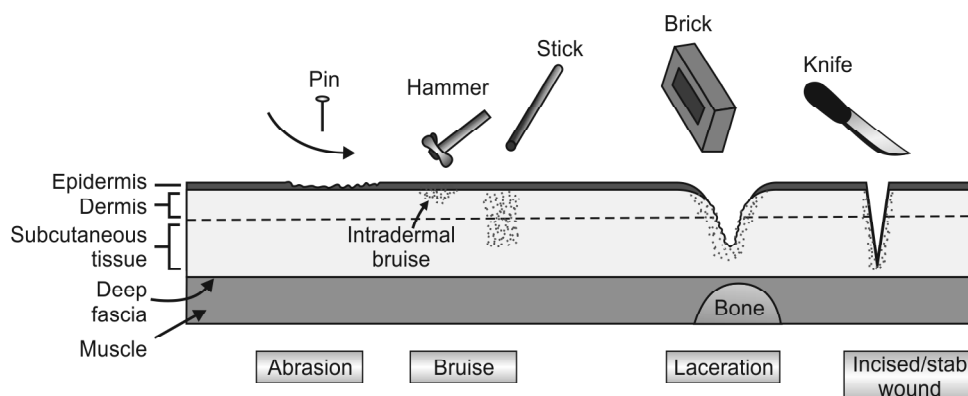

Fig. 11.1: Mechanical injuries caused by blunt and sharp objects

3. Chemical injuries

- i. *Irritation*: Due to application of weak acids, alkalis, plant or animal extracts
- ii. *Corrosion*: Due to application of strong acids or alkalis

4. Miscellaneous injuries

- i. Electrical injury
- ii. Radiation injury: Due to X-ray, UV radiation, radioactive substances
- iii. Lightning injury
- iv. Blast injury

Based on Severity of Injury (Legally)

- i. Simple
- ii. Grievous, which may or may not be dangerous

Based on Nature of Injuries (Medico-legally)

- i. Suicidal
- ii. Homicidal
- iii. Accidental
- iv. Defense wounds
- v. Fabricated or self-inflicted wounds

Based on Time of Infliction

- i. Antemortem—recent or old
- ii. Postmortem

Abrasion

Definition: Removal of the superficial epithelial layer of the skin, usually the epidermis, by friction against rough surface. Cyclists often refer to abrasion as 'road rash'.

Types (Fig. 11.2)

- i. **Scratch/linear abrasion:** It is caused by a sharp or pointed object passing across the skin, such as fingernails, thorn or pin. Surface layers of skin are collected in front of the object, which leaves a clean area at the start and tags at the end (Fig. 11.3). Fingernail abrasions are seen in throttling, sexual attacks and child abuse.
- ii. **Graze abrasion (sliding/scrape/grinding abrasion)**
 - Grazes are caused by horizontal or tangential friction between the skin and the hard rough surface.¹ They show uneven, longitudinal parallel lines, which indicate the direction in which the force was applied (epidermis being heaped up at the opposite end) (Fig. 11.3).
 - Most common type of abrasion and commonly seen in road traffic accidents.² Particles of glass, gravel or dirt may be embedded in such wounds.

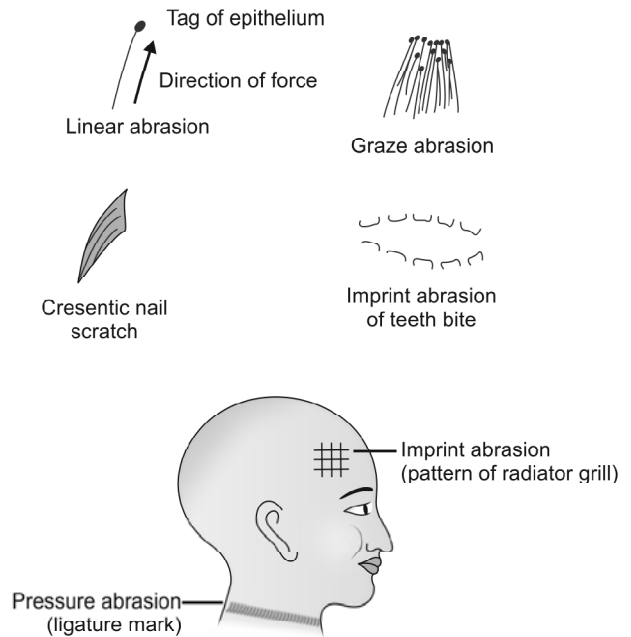

Fig. 11.2: Types of abrasions

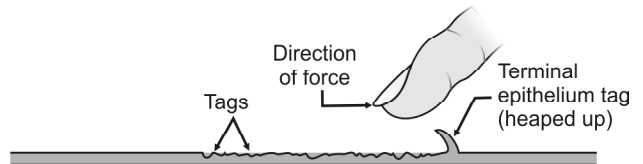

Fig. 11.3: Direction of force in an abrasion

- **Brush burn:** Graze abrasion involving wider area such as the back, caused by violent rubbing against a surface, as in dragging along over the ground. Such injuries, when dry, become firm, even though no true 'scab' is present.³⁻⁵
 - **Friction burn:** An extensive, superficial, reddened excoriated area with little or no linear mark, occurs when the skin is covered by clothing (element of thermal damage is present).
- iii. **Pressure abrasion (crushing/friction abrasion):** It is caused by direct impact or linear pressure of a rough object over the skin. The slight movement directed inwards results in crushing the superficial layers of the cuticle and bruising underneath, e.g. nooses or ligatures in hanging and strangulation.
 - iv. **Imprint abrasion (impact/contact/patterned abrasion):** It is caused when the force is applied perpendicular to the skin, the cuticle gets crushed at the point of impact and bears the imprint of the object causing it.

- The abrasion is slightly depressed below the surface.
- It tends to be focal and is commonly seen over bony prominences, where a thin layer of skin covers the bone.
 - Imprint abrasion becomes more defined when injured cuticle dries up and becomes brownish and parchmentized, in contrast with the surrounding uninjured skin surface.
- Pattern abrasion is a variation of pressure abrasion.⁶
- When a person is knocked down by car, pattern of the radiator grill, headlamp rim or tyre-tread mark may be seen on the skin.⁷ Imprint of bicycle chain, serrated knife are other examples.
- Teeth bite marks are included in this category, though they may produce contusion or laceration, depending upon the force applied.⁸
- UV light may be used to visualize the pattern injuries not apparent with visible light.

Human bite can occur during sexual behavior/assault, child abuse, self-defense, self-inflicted or a child biting another child. Bite may tear or crush, resulting in two U-shaped marks, corresponding to the upper and lower anterior six teeth (canine to canine) and separated by an open space of about 2.5-4 cm, which can be contused from teeth pressure. Most victims of a criminal act are women and breast is the most common location. Male victims are more frequently bitten on the arms.

Age of Abrasion

It produces minimum bleeding, heals rapidly and leaves no permanent scarring on healing (Table 11.1).

Differential Diagnosis

- Postmortem insect bites of the skin caused by ants or cockroaches produce dry, pale brown lesions with irregular margins and are arranged in a linear pattern. Most commonly found at mucocutaneous junctions—around the eyelids, nose, mouth, ears, axilla, groins and genitalia. Vital reaction is absent.
- It may also resemble powder stippling (firearm injury).
- Excoriation of skin by excreta and diaper rash may be misinterpreted as abrasions.
- Dry skin of scrotum and vulva gives a reddish brown or yellow coloration when exposed to the open air.

Table 11.1: Age of abrasion

Duration	Features
Fresh 2-24 h	Bright red, oozing of serum and some blood. Exudation dries to form a reddish scab, comprising of blood, lymph and epithelial cells. Polymorphonuclear cells infiltrate (<i>scab formation</i>).
2-3 days	Reddish-brown scab, less tender. ⁹
4-5 days	Scab is dark brown in color.
5-7 days	Scab is brownish black and starts falling off from the margins. Epithelium grows and covers defect under the scab (<i>epithelial regeneration</i>).
7-12 days	Scab dries, shrinks and falls off, leaving depigmented area underneath. It gradually gets pigmented in due course of time (<i>subepidermal granulation</i>).
> 12 days	Epithelium becomes thinner and atrophic. New collagen fibres are prominent. Basement membrane is present and vascularity of the dermis decreases (<i>regression</i>).

- Decubitus/pressure ulcers* (bed sores): These are due to pressure necrosis of the skin in a bedridden caused by prolonged compression of soft tissue between bony prominence and external surface.
- Postmortem abrasions* (refer to Diff. 11.1): In doubtful cases, a histopathological examination may be needed.

Circumstances of Abrasions

- Usually it is seen in accidents and assaults.
- Hysterical women may produce abrasions over accessible areas, like the front of forearm or over the face, to fabricate charge of assault.
- Abrasions on the face or body of the assailant indicate a struggle.
- Person collapsing due to a heart attack may fall forward and receive abrasions on the forehead, nose and cheek, but there will be no injuries on the upper limbs.
- Abrasions may be produced on the palmer surface of hands in a conscious person, who while falling puts out his hands to save himself.
- Alcoholics tend to fall backwards and strike the occiput on the ground.
- Abrasions over the cornea may cause corneal opacity which may restrict vision permanently, amounting to grievous hurt (**Sec. 320 IPC**).

Differentiation 11.1: Antemortem and postmortem abrasion

S.No.	Feature	Antemortem abrasion	Postmortem abrasion
1.	Site	Anywhere on the body	Usually over bony prominences
2.	Color	Bright red	Yellowish, translucent and parchment-like
3.	Exudation	More, scab slightly raised	Less, no scab
4.	Vital reaction	Present	Absent
5.	Healing process	May be evident	Not seen

Note: Abrasions produced slightly before or after death cannot be differentiated even by microscopic examination.

Medico-legal Importance

- Abrasions give an idea about the site of impact and direction of force.
- They may be the only external signs of serious internal injury.
- Patterned abrasions are helpful in connecting the wound with the causative weapon.
- Age of injury can be determined which helps to corroborate with alleged time of assault.
- In open wounds, dirt, dust, grease or sand is usually present which helps to connect the injuries to the scene of crime.
- Character and manner of injury may be known from its distribution:
 - i. In *throttling*, crescentic abrasions made by fingernails are found on the neck.
 - ii. Abrasions on the victim may show whether the fingernails of assailant were long, irregular or broken.
 - iii. In *smothering*, abrasions may be seen around the mouth and nose.
 - iv. In *sexual assaults*, abrasions may be found on the breasts, genitals, inside of the thigh and around the arms.

Patterned injuries can be subdivided according to the type of force involved:

- **Blunt force injuries:** These are the most commonly seen group. Abrasions may preserve patterns well, especially if the force is applied perpendicular to the skin surface. Bruises may also reproduce patterns well, particularly if they are intradermal. Lacerations less frequently show a well-defined reproduction of the shape of the causative agent.
- **Sharp force injuries:** Stab wounds may show characteristics of a specific type of blade (e.g. 'fish-tail' appearance). Distinctive patterns may be seen with the hilt, or a stab wound with Phillips head screwdrivers or scissors.

- **Gunshot wounds:** Contact entry wounds (may have sight marks) and shotgun wounds (e.g. wad marks) may produce distinct patterned injuries.
 - **Other miscellaneous wounds and marks** e.g., fern-like pattern with lightning strikes, tool marks on internal structures (such as cartilage).
- Medico-legal importance:* Connect a particular weapon or object to an injury, which may allow a perpetrator to be linked to the crime and/or enable better understanding of the events surrounding a death.

Bruise/Contusion

Definition: Bruise is the extravasation of blood in the subcutaneous/subepithelial tissues due to rupture of blood vessels, usually capillaries as a result of blunt force injury or pressure.

- 'Bruise' is derived from old English word '*brysan*' which means 'to crush'.
- Usually, there is no loss of continuity of the overlying skin.
- 'Bruise' implies that the lesion is observed through the overlying intact skin as bluish purple discoloration and swelling of the involved area, while a 'contusion' is a bruise within an organ or tissues, such as muscles, liver or mesentery.

Causes

- i. By application of blunt force viz. blow with fists, sticks, iron-bar, cane, whip or chain.
- ii. From compression, like pressing fingers.

Classification

Bruise is classified into three types depending on its situation:

- i. **Intradermal bruise:** Bruise lies in the immediate subepidermal layer. It is made by impact with a patterned object and hemorrhage is sharply defined.

- ii. **Subcutaneous bruise:** It is situated in subcutaneous tissue, often in the fatty layer and the edges are blurred. Most common type of bruise caused by blunt object, and appears soon after injury as dark red swelling.
- iii. **Deep bruise:** Bleeding deeper to the subcutaneous tissues. It may take hours to 1-2 days to appear at the surface (**delayed bruising**). Therefore, one more examination should be carried out 24-48 h after first examination. *Infrared photography* may demonstrate such bruises, if suspected initially.

Factors Influencing the Bruise

- i. **Type of tissue/site involved**
 - Soft, lax and vascular tissues, such as face, scrotum and eyelids develop large bruises even with little force.¹⁰
 - In tissues which are strongly supported, contain firm fibrous tissue and are covered by thick dermis, e.g. abdomen, back, scalp, palms and soles, even a moderate violence may produce only a small bruise.
 - Bruising of scalp is better felt than seen.
 - Bruising is more marked on tissues overlying bone.
 - In boxers and athletes, bruising is much less, because of good muscle tone.
 - Chronic alcoholics with cirrhosis and individuals taking aspirin, bruise easily.
- ii. **Age:** Children and elderly bruise more easily because of softer tissue and delicate skin in the former, and loss of subcutaneous supportive tissue and cardiovascular changes in the latter.
- iii. **Sex:** Women tend to bruise more easily than men because tissues are more delicate and subcutaneous fat is more. Obese people bruise more easily than lean because tissues are more delicate.
- iv. **Color of skin:** Bruising is more clearly seen and recognized in fair skinned persons than those with dark skin, in whom they may be better felt than seen.
- v. **Natural diseases:** Prominent bruising following minor trauma is seen in persons suffering from atherosclerosis, purpura hemorrhagica, leukemia, hemophilia, scurvy, bleeding diathesis, vitamin K and prothrombin deficiency, and in phosphorus poisoning.
- vi. **Gravity shifting of blood (ectopic/migratory bruise):** It is responsible for the appearance of bruises at a site other than the site of injury, e.g. black eyes. Blood will track along the fascial planes (or

between muscle layers) along the path of least resistance and may appear where the tissue layers become superficial. Thus, site of bruise does not always indicate the site of injury.

- **Grey Turner's sign:** Ecchymosis seen over flank or side of abdomen, occurring due to extensive retroperitoneal hemorrhage. This sign takes 24-48 h to develop.
- **Cullen's sign:** Bluish-black discoloration of the periumbilical skin due to extensive retroperitoneal or intraabdominal hemorrhage. This may be caused by ruptured ectopic pregnancy or acute pancreatitis.

Patterned Bruise

Bruise may indicate the nature of the weapon, especially when death occurs soon after infliction of injury.

- i. A blow from a solid body, such as hammer or a closed fist produces a rounded bruise.
- ii. Blows with a rod, stick or a whip produce two parallel, linear hemorrhages (**railway line or tram-line type**). The intervening skin appears unchanged (Fig. 11.4).
Mechanism: The weapon sinks into the skin on impact, so that the edges drag the skin downwards and the traction tears the marginal blood vessels. The centre compresses the skin, which causes little or no damage to the vessels. When the impact is released, the blood flows back into the injured marginal zones and leaks into tissues (Fig. 11.5).
- iii. A woven, spiral or plaited ligature may produce a patterned bruise.
- iv. Suction or biting on the sides of the neck or the breasts during love making/sexual intercourse produces elliptical patterned bruises.

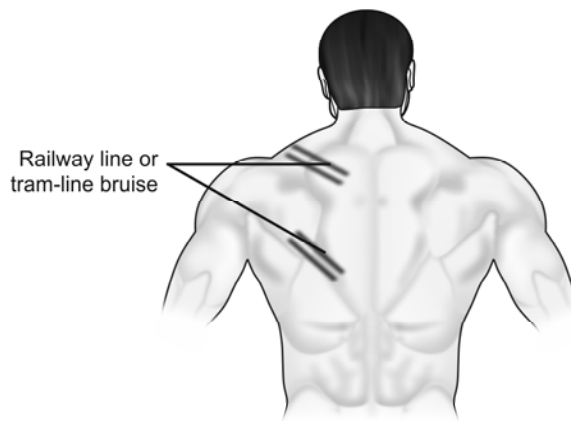

Fig. 11.4: Patterned bruise

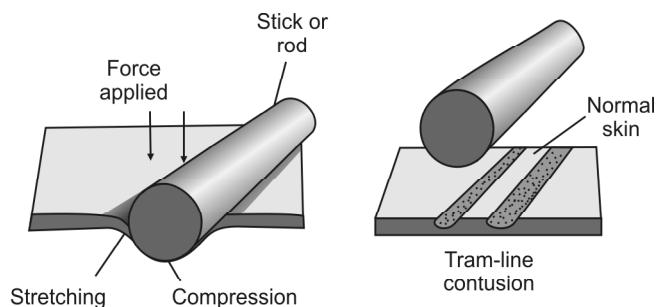

Fig. 11.5: Formation of 'tram-line contusion'

Deep tissue and organ contusion

- Internal organs can also get contused; contusion of the brain may cause confusion, coma and death.
- Contusion in vital centres, e.g. which control respiration and blood pressure can be fatal even when very small.
- Small contusions of heart can cause serious disturbances of normal rhythm or stoppage of cardiac action and death.

Dating/Age of Bruise

Consistent, reliable microscopic dating is not possible and color changes in resolution of a contusion is not always a reliable indicator of its age. However, methods used to date a bruise are:

- Histology (only in postmortem situation)
 - Color changes (visual examination)
 - Calorimetry
 - Spectrophotometry
- Bruises heal by destruction and removal of extravasated blood.
 - The extravasation of blood is followed by an inflammatory reaction that causes vasodilation and attracts macrophages which breaks down hemoglobin to biliverdin. Biliverdin is then broken down by the enzyme *biliverdin reductase* to yellow color bilirubin. As hemoglobin is broken down, some of its iron is released and combines with ferritin which gives rise to hemosiderin.
 - Color change starts at the periphery and extends inwards to the centre.
 - The time required for bruising to clear is extremely variable and is only a general guideline in interpreting the age of the bruise (Table 11.2). It should only be stated whether the bruise is recent or old.
 - **Sub-conjunctival hemorrhage** does not show similar color changes owing to hemoglobin being kept oxygenated by air. It is red at first, then becomes

Table 11.2: Age of bruise

Duration	Color
Fresh	Red (oxygenated blood)
Few hours to 3 days	Blue (deoxyhemoglobin) ¹¹
4-5 days	Bluish black to brown (hemosiderin) ¹²
5-6 days	Green (biliverdin) ¹³
7-12 days	Yellow (bilirubin)
2 weeks	Normal

yellow and finally disappears.¹⁴ Similar changes are seen in **meningeal hemorrhages** owing to O₂ supplied from CSF.

- Healthier the individual, the more rapid will be the healing. A bruise takes a much longer duration to heal in the old than in the young. In old age, it may remain for 4-5 weeks. Bruises of soft loose tissues, like those surrounding the eye resolve faster.
- Environmental lighting may slightly alter the color of the bruise. Drugs, such as steroids may change the rate of bruise dispersion, and interventions, such as ice packs or heat treatment may add to variability.
- Bruises of the same age may show different color progression, so that variation in color does not necessarily mean that there have been multiple episodes of injury.
- Not all bruises pass through a yellow phase before they resolve.
- Dating a bruise may be helpful in determining the veracity of the informant and together with other data may justify further investigation into a particular case.

- Hemosiderin is a granular brown iron-storage complex composed of ferric oxide, commonly found in macrophages and derived from breakdown of hemoglobin.
- Biliverdin is a green pigment formed as a byproduct of heme breakdown.
- Bilirubin was discovered by Virchow in 1849, who called the yellow pigment 'hematoidin'.

Complications

- Multiple contusions can cause death from shock and internal hemorrhage.
- Gangrene and death of tissue can result.
- Bacterial infections, especially by *Clostridia* can occur.
- Pulmonary fat embolism may occur.

Medico-legal Importance

- It is advisable that a medical officer should re-examine the patient after 24 h, as by this time the bruises are clearly visible.

- Age of the injury can be determined by the color changes.
- Degree of violence may be determined from their size.
- Patterned bruises may connect the victim and the object/weapon, e.g. whip, chain, cane or ligature.
- To confirm at postmortem examination, deep incisions are made at suspected sites, which show ecchymosis (Diff. 11.2 and 11.3).
- Contusions can be produced postmortem, if a severe blow is given to the body within few hours after death.
- Bruises may be fabricated by applying juices of marking nut or calotropis to incriminate others, or in defense of a crime.
- Surgical removal of cornea can result in hemorrhage into the eyelids, identical with antemortem trauma.
- Character and manner of injury may be known from its distribution:
 - i. When arms are grasped there may be 3-4 bruises on one side (corresponding to fingers) and one larger bruise on the opposite side (thumb).
 - ii. Bruising of the arm may be a sign of restraining a person.

Differentiation 11.2: Antemortem and postmortem bruise¹⁵

S.No.	Feature	Antemortem bruise	Postmortem bruise
1.	Swelling	Present	Absent
2.	Damage to epithelium	Present	Absent
3.	Extravasation of blood	Present	Absent
4.	Coagulation	Present	Absent
5.	Infiltration of the tissues with blood	Present	Absent
6.	Color changes	Seen	Uniform color
7.	Margins	Merge with surrounding area	Sharply demarcated
8.	Appearance	More marked in victims who survive for sometime	Less marked

Differentiation 11.3: PM staining and bruise

S.No.	Feature	PM staining	Bruise
1.	Cause	Distension of vessels with blood in dermis	Rupture of vessels which may be superficial or deep
2.	Cuticle	Not abraded	May be abraded
3.	Site	Occurs over extensive area of the most dependent parts	Occurs at the site of and surrounding the injury, may appear anywhere on the body
4.	Appearance	No elevation of involved area	Often swollen, because of extravasated blood and edema
5.	Margins	Clearly defined	Merge with the surrounding area
6.	Color	Uniform bluish-purple color	Different colors, depending on the age of bruise
7.	On incision	Blood is seen in blood vessels which can be easily washed away, subcutaneous tissues are pale	Extravasation of blood into the surrounding tissues, cannot be washed by water, subcutaneous tissues are deep reddish-black
8.	Effect of pressure	Absent in areas of the body which are under even slight pressure	Lighter over the area of pressure or support
9.	Superimposed abrasion	Not present	May be present
10.	Microscopically	Blood cells are found within the blood vessels and there is no evidence of inflammation	Blood cells are found outside the blood vessels, evidence of inflammation present

- iii. Small bruises along with nail marks on the inner aspect of thighs of a woman may indicate sexual assault. Typical small bruises (*six-penny bruises*) are produced by forcible poking or pressure of fingertips.
- iv. Bruising of the shoulder blades indicates firm pressure on the body against the ground or other resisting surface.
- v. In manual strangulation, position, number of bruises and nail marks give an indication of the position of the assailant.
- vi. Bruises found in 'soft' sites in a child such as cheeks or trunk and multiple bruises in various stages of healing suggest abuse.

Bruises are of lesser value than abrasions because:

- Their size may not correspond to the size of the weapon.
- They do not indicate the direction in which the force was applied.
- They may become visible after few hours or even 1-2 days after injury.
- They may appear at a distance away from the actual site of injury. It may not indicate the point of trauma.

Lacerated Wound

Definition: Laceration is tearing or splitting of skin, mucous membranes, muscles or internal organs caused by either a shearing or a crushing force and produced by application of a blunt force to a broad area of the body.

If the blunt force produces extensive bruising and laceration of deeper tissue, it is called *crush injury*.

Types

- i. **Split lacerations:** Occur when soft tissues are sandwiched between a hard unyielding deeper structure and the agent applying the force. Scalp lacerations occur due to the tissues being crushed between the skull and some hard object.¹⁶
Incised-looking lacerated wounds: When the skin is closely applied to the bone and the subcutaneous tissue is scanty, blunt force may produce a wound which by linear splitting of the tissues resembles an incised wound.¹⁷
Sites: Scalp, forehead, eye brows, zygoma, iliac crest, lower jaw, perineum and shin.¹⁸
- ii. **Stretch lacerations:** Result from a heavy forceful frictional impact of blunt forces exercising localized '*pressure with pull*'. Overstretching of the skin and subcutaneous tissues may cause lacerations with

flapping of the skin which may indicate the direction of application of force.

They are seen in run over by motor vehicle, kicking and in compound fractures.

- iii. **Avulsion or grinding compression:** Produced by force (shearing force) delivered at an oblique or tangential angle to detach (tear off) a portion of traumatized skin surface or viscus (tissue/organ) from their attachment (Fig. 11.6).
 - Commonly seen in road traffic accidents where the rotating force of a wheel tears off the skin over a large area. This is called *flaying* and most frequently occurs on the legs.¹⁹
 - Amputation injuries are a type of avulsion injury in which an entire extremity or portion thereof is severed from the body.
 - The most severe is a decapitation injury, in which the head separates from the body.
- iv. **Tears:** Tearing of skin and subcutaneous tissue can occur from localized impact by or against some hard, irregular object like car door handle, radiator mascot or from blows with broken glass bottles.
- v. **Cut lacerations:** Sometimes, a heavy sharp edged weapon causes a deep and wide cut over the body tissues.

Characteristics (Fig 11.7)

- **Margins:** Ragged, irregular and uneven; may show tearing of the extremities at angles diverging from the main laceration, the so-called '*shallow tails*'; pieces of tissue are attached in between called *tissue tags or bridges*.²⁰
- **Site:** Occur most commonly over bony prominences, such as the head where the skin is fixed and easily stretched and torn.

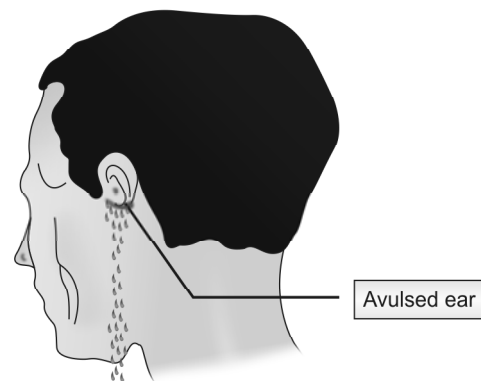

Fig. 11.6: Avulsed lacerated wound

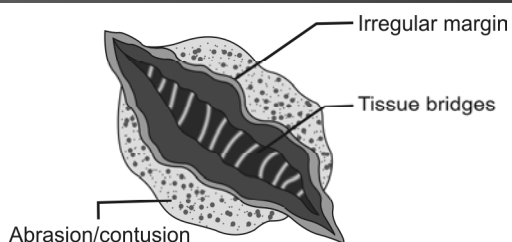

Fig. 11.7: Characteristics of lacerated wound

- **Bruising and abrasion:** Seen around the margin.
- **Edges:** May give an indication of direction in which the blow or force was applied.
- **Depth of wound:** Shows bridges of irregularly torn fibrous tissue, blood vessels and nerves across the interior of the wound.
- **Soiling of wound:** Mud, wood splinters, sand, glass fragments, paint material of the vehicle involved, hair or fibres may get embedded in the wound and are of great medico-legal importance.
- **Hair bulbs:** Crushed.
- **Hemorrhage:** Less, because the arteries are crushed and torn across irregularly; they retract and blood clots readily, *except* in the scalp where the temporal arteries bleed freely as they are firmly bound and unable to contract.
- **Shape and size:** May not correspond with the weapon or object which produced them.
- **Gaping:** Seen due to pull of elastic and muscular tissues.
- **Beveling:** Laceration caused by a blow directed tangentially or at an angle will produce undermining of the tissue on one side (indicates the direction of blow) and abrasion and beveling on the other (direction from which the blow was coming).
- **On healing:** Produces permanent scar.

Antemortem lacerations show bruising of margins, vital reaction, eversion and gaping of margins.

Dating of Laceration

The gross findings is summarized in Table 11.3 when healing occurs by first intention without any secondary infection.

Complications

- Lacerations may cause severe and fatal bleeding leading to shock and death.
- Infection.
- Pulmonary/systemic fat embolism may occur due to crushing of subcutaneous tissue.

Table 11.3: Healing of a lacerated wound

Duration	Gross findings
Fresh	Bleeding or fresh clot is attached; margins are red, swollen and tender.
12-24 h	Margins swollen, red and covered by dried blood clots and lymph.
3-5 days	Margins strongly adherent with each other and covered by dried crust.
6-7 days	Crust/scab falls off or can easily be taken off with soft reddish tender scar.
Few weeks	Scar is whitish, firm and painless.

- If located where skin stretches or is wrinkled, e.g. over joints, repeated and continued oozing of tissue fluids and blood may cause irritation, pain and dysfunction.

Medico-legal Importance

- The type of laceration may indicate the cause of injury and shape of blunt weapon, e.g.
 - Blunt round end (hammer) may cause a stellate laceration.
 - Blunt object with an edge, such as hammer head, may cause crescentic laceration (patterned laceration).
 - Long, thin objects, like pipes or sticks produces linear or elongated lacerations, while objects with a flat surface produce irregular, ragged or Y-shaped lacerations.
- Whether the laceration is accidental/homicidal/suicidal?
 - Accidental laceration:** Commonly seen anywhere on exposed parts of body.
 - Homicidal laceration:** Noticed on non-accessible parts of the body, especially in assault cases. It is usually seen on the head.
 - Suicidal lacerations** are rarely seen, as they are painful to produce and if present, they are seen on exposed parts of body and on same side.
- Sometimes **human bites** can be a combination of *deep lacerations and crushing* and are associated with a high incidence of infection. It may be associated with avulsion of pieces of the nose or ear. An accidental type of injury results from an attacker striking the victim's incisor teeth with his knuckles (metacarpophalangeal joint is usually involved).
- Foreign matter in the wound could give clues about the object causing it, e.g. paint material of vehicle may be transferred to the lacerated wound.

- Skin flap which overhangs the cut margin (avulsion cases) can indicate the direction of force applied.

Wounds caused by sharp edged and pointed weapons are of four types:

- Incised wound
- Chop wound
- Stab wound
- Therapeutic/diagnostic wound

Incised Wound (Cut/Slash/Slice)

Definition: Incision is a clean cut wound through the tissues (usually the skin and subcutaneous tissues including blood vessels), caused by a sharp-edged instrument, which is *more long than deep*.

It is produced by pressure and friction against the tissue by an object having a sharp cutting edge, such as knife, razor or scalpel.

Characteristics²¹

- **Margins:** Edges are clean cut, well-defined and usually everted. They may be inverted, if a thin layer of muscle fibres is adherent to the skin as in the scrotum (due to the attached dartos muscle to the skin). The edges are free from contusions and abrasions. Wrinkled wounds are produced where the skin is wrinkled (i.e. folds) and more than one incised wound is seen.
- **Width/breadth:** Width is greater than the edge of the weapon causing it due to retraction of the divided tissues.
- **Length:** Length is greater than its width and depth and has no relation to the cutting edge of the weapon, for it may be drawn to any distance.
- **Shape:** Usually spindle-shaped due to greater retraction of the edges in the centre. Gaping is more, if the underlying elastic fibres in the skin (**Langer's lines**) have been cut transversely or obliquely and is less when cut longitudinally (Fig. 11.8).
- **Depth and direction:** Usually deeper at the commencement, except in case of suicidal cut throat injuries, with hesitation cuts at the beginning. This is known as *head of the wound*. Towards termination, the cut becomes progressively shallow, known as *tailing of the wound* (Fig. 11.8). Consequently, depth of the incised wound with tailing will suggest the direction in which the force was applied.
- **Hemorrhage:** As vessels are cut clean, hemorrhage is more.
- **Beveled cuts:** If the blade of the weapon enters obliquely, tissues will be visible at one margin and

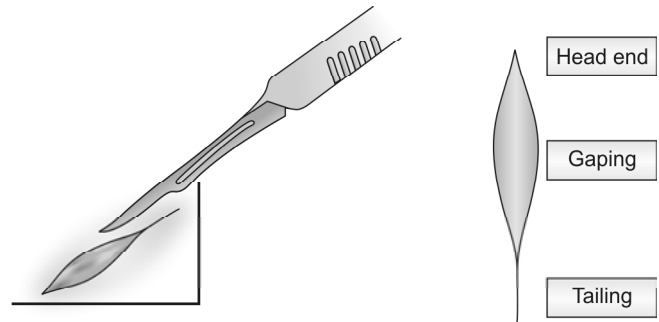

Fig. 11.8: Incised wound

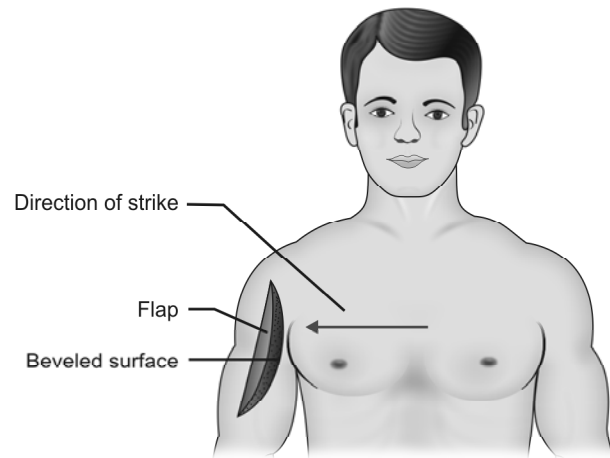

Fig. 11.9: Incised wound due to oblique strike

other margin will be undermined; if the blade is nearly horizontal a flap wound is caused (Fig. 11.9).

Bevel: A surface having a sloped or slanting edge. It is the angle or inclination of a line or surface that meets another at any angle but 90°.

Dating of Incised Wound

Refer to Table 11.4 for dating of incised wound.

Medico-legal importance

- Indicate the nature of weapon (sharp-edged).
- Give an idea about the direction of force.
- Age of injury can be determined.
- Position and character of wound may indicate manner of production, i.e. suicide, accident, or homicide (Diff. 11.4 and refer to Fig. 12.22).
 - Suicide:** Multiple incised wounds of varying depths on the neck or wrists suggest a suicide. Some features of suicidal wounds are:
 - Fatal wounds are present over limited accessible areas of the body, such as front of neck, groin,

Table 11.4: Dating of incised wound

Duration	Gross findings	Microscopic findings
Fresh	Red with clotted blood	Capillary dilatation, margination and emigration of neutrophils, reactive changes in tissue histiocytes
12 h	Margins red, swollen and adherent with blood and lymph	Reactive changes in fibroblast, monocytes in exudates
24 h	Continuous layer of endothelial cells cover the surface with a scab of dried clot	Endothelium begins to grow at edges, vascular buds begin to form
2-3 days	—	Vascularized granulation tissue formation (fibroblasts)
4-6 days	—	Formation of new fibrils
7 days	Scar formation	Scar formation

Differentiation 11.4: Suicidal and homicidal cut-throat wounds

S.No. Feature	Suicidal cut-throat	Homicidal cut-throat
1. Situation	Left side of the neck and passing across the front of the throat	Usually on the sides
2. Level	High, above the thyroid cartilage	Low, on or below the thyroid cartilage
3. Direction	Obliquely, above downwards and from left to right in right handed persons	Transverse or from below upwards
4. Number of wounds	Multiple, may be 20-30, superficial, parallel and merged with main wound	Multiple, cross each other at a deep level
5. Edges	Usually ragged due to overlapping of multiple superficial incisions	Sharp and clean cut, beveling may be seen
6. Hesitation cuts	Present	Absent
7. Tailing	Present	Absent
8. Severity	Less severe, one wound is severe, but sometimes, there may be 2-3	More severe, all tissues including vertebrae may be cut
9. Wounds in other parts of body	Often present across wrists, groin and thighs	No wounds on wrists, but severe injuries on head and neck
10. Defense wounds	Absent, unintentional cuts may be found	Present, unless taken unaware
11. Hands	Weapons may be firmly grasped due to cadaveric spasm	Fragments of clothing or hair may be grasped
12. Weapon at site	Usually present	Usually absent
13. Vessels	As head is thrown back, carotid artery escapes injury	Jugular vein and carotid artery are likely to be cut
14. Clothes	Not cut or damaged	May be cut, corresponding to injuries in the body
15. Circumstantial evidence	Quiet place, such as bed room; suicidal note	Disturbance at scene, footprints outside

chest or back of legs. Cutting of wrist is rarely fatal. Suicides usually do not injure the face.

- b. *Hesitation cuts/marks or tentative cuts or trial wound*: These cuts are multiple, small and superficial often involving only the skin and are seen at the beginning of the incised wound, presumably hesitating while gaining courage to make a final decisive cut.²²

- c. A person who commits suicide exposes his body by opening his clothes and then inflicts the wounds.

- d. When a safety razor blade is used, unintentional cuts are found on the fingers where the blade has been gripped.

- e. Most people have a vague knowledge of the anatomy and do not know where to cut a major

blood vessel and may cut their forearms vertically, rather than horizontally.

- ii. **Homicidal wounds:** They are deep and deliberate in character and are seen on the head, throat and neck and sometimes on the trunk. Incised wounds on nose, ears and genitals are usually homicidal and may result from sexual jealousy, caused by a jilted lover, husband or wife.²³
- iii. **Accidental wounds:** Commonly seen around the hands.
- iv. **Defense wounds:** Injuries are seen on the forearm and palm, when the victim may try to ward off on attack by raising hands and arms in defense or by grabbing the weapon.
- v. **Self-mutilation:** Sometimes, injuries may be caused by an individual with a mental disorder as a form of self-mutilation or by one who deliberately harms oneself for motives of gain. They are found anywhere on the body; superficial, multiple and avoiding vital areas such as lips, nose and ears.

Chop Wounds

Definition: Deep gaping wounds caused by a blow with the moderately sharp cutting edge of a heavy weapon, applied with a significant degree of force.

- A chop wound is best considered a combination of blunt and sharp force injury.
- **Weapons used:** Hatchet, axe, tomahawk, saber and meat cleavers.
- Presence of an incised wound on the skin with an underlying comminuted fracture or deep groove in the bone indicates wounds caused by such weapons.
- Dimensions of the wound correspond to cross-section of the penetrating blade.
- Margins are sharp, and may show abrasion, bruising and some laceration with severe injury to the underlying organs.
- Usually the lower end (heel) of the axe strikes the surface first which produces a deeper wound than the upper (toe) end. Deeper end indicates the position of the assailant (Fig. 11.10).
- Undermining occurs in the direction towards which the chop is made. In the skull, the undermined edge of the fracture is the direction in which the force was exerted and slanted edge is the side from which the force was directed.

Medico-legal Importance

- Most of the injuries are homicidal and usually inflicted on the exposed portions of the body, like head, face, neck, shoulders and extremities.

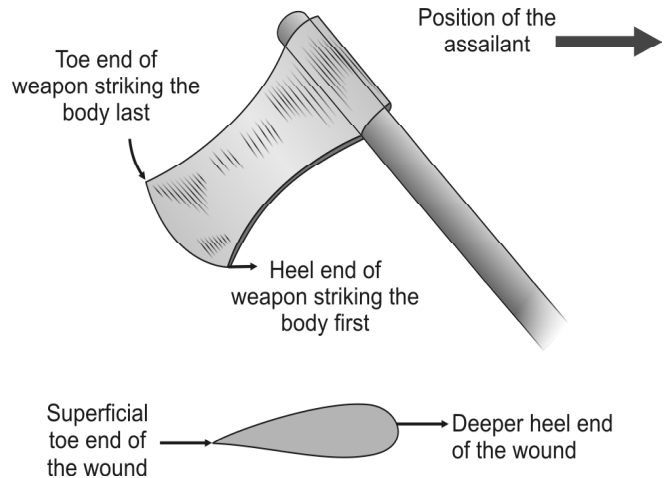

Fig. 11.10: Determining the relative position of the assailant from a chop wound

- Few are accidental due to machinery, like propeller injuries.
- Rarely, they could be suicidal.
- Wound examination could reveal clues regarding the causative weapon.

Stab Wound

Definition: Wound produced from penetration with long narrow instruments having pointed (sometimes blunt) ends into the depths of the body. Stab wounds are *deeper than its length and width*.

- Word '*stab*' means 'to wound or pierce with a pointed weapon'.
- **Weapons used:** The most frequently used object is a knife (single-edged kitchen or pocket knives with a blade length of 10-13 cm). Less often, injuries are caused by pieces of glass (broken-off bottle necks), scissors, dagger, screwdrivers, pens, ice picks or forks.
- A **stab/punctured wound** is an open injury in which foreign material and organisms are likely to be carried deep into the underlying tissues.
- **Concealed punctured wounds:** These are punctured wounds caused on concealed parts of body, such as nostrils, fontanelles, inner canthus of eyes, axilla, vagina, rectum and the nape of the neck. They are caused by slender instruments, such as ice picks or knives with thin blades. Fatal penetrating injuries can be caused without leaving any easily visible external marks or bleeding.

Classification

Clinically, stab wounds are of two types (Fig. 11.11):

- i. **Penetrating wound:** Weapon enters into the body cavity producing only one wound, i.e. wound of entry.
- ii. **Perforating wound** (through and through punctured around): Weapon after entering into one side of the body will come out through the other side, producing two wounds:
 - *Wound of entry:* Through which the weapon enters the body. It is larger and with inverted edges.
 - *Wound of exit:* Through which the tip of weapon emerges out of the body. It is usually smaller with everted edges.

Characteristics

- **Margins:** Edges of the wound are clean cut, usually no abrasion or bruising of the margins, but in full penetration of the blade, a patterned abrasion or bruising may be produced by the hilt-guard striking the skin. They are regular, sharp and well-defined. However, injuries caused by a pointed or conical instrument have lacerated edges.
- **Length:** Length is slightly less than the width of the weapon because of stretching of the skin. For measuring the length of stab wound, the edges of the wound should be approximated.
- **Breadth:** It is more than thickness of the blade due to gaping. Approximation of the edges is needed to get the actual measurement.

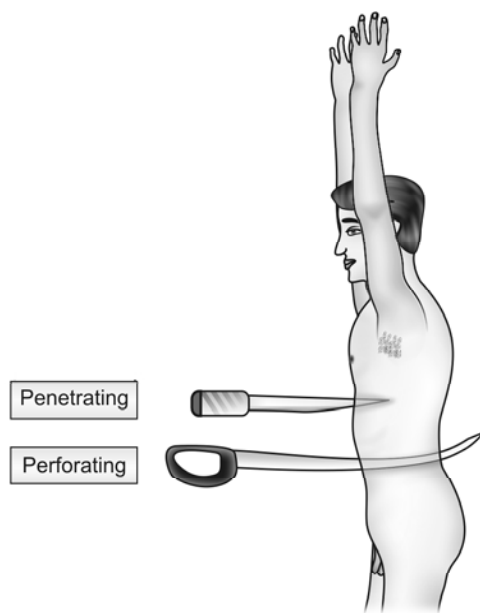

Fig. 11.11: Classification of stab wounds

- **Depth:** Depth is the greatest dimension of a stab wound. Depth corresponds to the length of the blade of the weapon entering the body, when the whole length of the weapon enters the body, but has not produced any wound of exit.
 - It is not safe to find out the depth of a stab wound by introducing a probe because it may disturb a loose clot and may lead to fatal hemorrhage.
 - The probe may easily pass between the fascial planes or within the muscle producing a false track. Depth should be determined in the OT, when the wound is repaired.

Depth of stab wound depends on:

- *Condition of the knife:* Sharpness of the tip of the knife is the most important factor in skin penetration. Once the tip has perforated the skin, the cutting edge is of little importance.
- *Resistance offered by the tissues and organs:* Apart from bone and calcified cartilage, the skin is most resistant to knife penetration.
- *Clothing:* Multiple layers of tough cloth or leather jackets require greater force to penetrate.
- *Force applied:* Speed of thrust of the knife.
- *Location:* Stretched skin is easier to penetrate than lax skin, e.g. chest wall.
- *Angle of strike:* A knife striking the skin at a right angle penetrates more deeply, than when it strikes from some acute angle.

- **Direction:** When a knife penetrates at an angle, the wound will have a beveled margin on one side with undermining (undercut) on the other, so that subcutaneous tissue is visible, indicating the direction from which the knife entered (Fig. 11.12). In solid organs, like liver, the track made by the weapon is seen well.
- **Shape:** It is slit-shaped with two acute angles or gape open depending on their location and their orientation, with regard to the cleavage lines of Langer (Figs 11.13 to 11.15).
 - A stab wound which runs parallel to the cleavage lines will remain slit-shaped and narrow, and the dimensions of the blade will be represented with considerable accuracy.
 - A stab wound which enters through the cleavage lines transversely will gape.
- i. If a single-edged weapon is used, the surface wound will be triangular or wedge-shaped and one angle of the wound will be sharp the other rounded, blunt or squared off. Blunt end of the wound may have small splits in the skin, so-called 'fish-tailing'. *Virtually all stab wounds are made with*

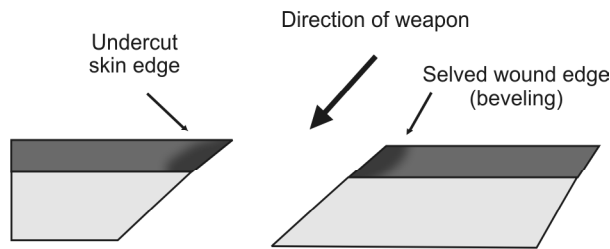

Fig. 11.12: Beveling of a wound in case of tangential entry of a weapon

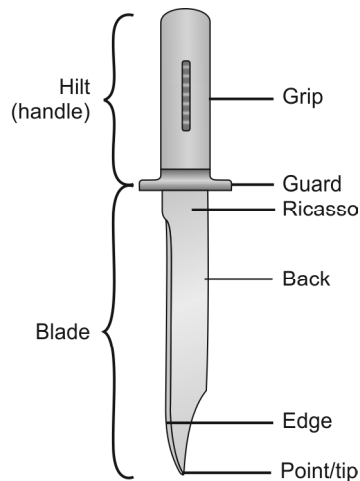

Fig. 11.13: Parts of a single-edged knife (one edge sharp and the other blunt)

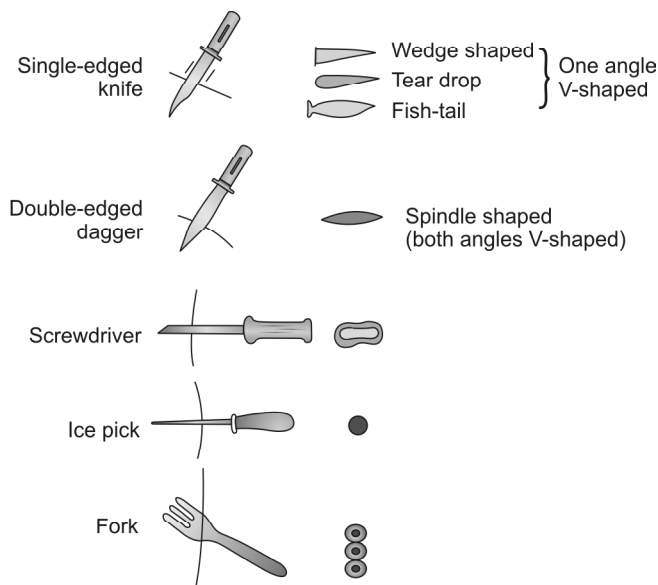

Fig. 11.14: Shape of stab wounds

single-edged weapons. Sometimes, this is not always the case, as the blunt edge of the knife may split the skin and resemble a double-edged knife wound.

- ii. If a double-edged weapon is used, the wound will be elliptical or slit-like and both angles will be sharp or pointed.
- iii. A round object, like a spear may produce a circular wound.
- iv. A pointed square weapon may produce a cross-shaped injury, each of the four edges tearing their way through the tissues (stellate shaped).
- v. Stabs produced with a broken bottle appear as clusters of wounds of different sizes, shapes and depths with irregular margins.
- vi. A screwdriver will produce a slit-like stab wound with squared ends and abraded margins.
- vii. Skin wound made by closed scissors produce a flat 'Z' shaped wound. If the blades were open, the injuries may look similar to those produced by a knife.
- viii. Ice picks produce small, round or slit-like wounds which may look like 0.22-calibre bullets or shotgun pellets.
- ix. A fork will produce clusters of 2-3 wounds depending on the number of prongs on the fork.

- The pattern of arrangement of the dense network of intimately intermingled dermal collagen and elastic fibres of the skin and their linear representation on the skin are called *Langer's lines* (Fig. 11.15).
- Skin tension and Langer's lines may transform round skin defects into slit-like wound resembling stabs wounds; round-out genuine stab wounds and artefactually lengthen stab wounds.
- The same weapon may cause apparently different injuries because of their different locations and orientations of the body due to skin elasticity (and Langer lines).

Complications/Cause of Death

- i. Hemorrhage leading to hypovolemic shock due to injuries of major vessels (most frequent cause).
- ii. Cardiac tamponade (less common).
- iii. Aspiration of blood and air embolism—when the stab is located on the neck (injury to jugular vein).
- iv. Infections, because of foreign matter embedded in the wound.
- v. Asphyxia.
- vi. Pneumothorax.

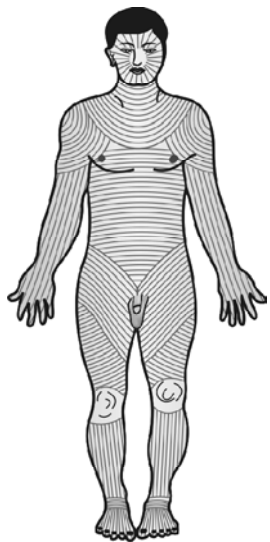

Fig. 11.15: Cleavage lines of Langer (similar lines are present at the back also)

Medico-legal Importance

- Shape of the wound may indicate the type of weapon which may have caused the injury.
- Depth of the wound will indicate the force of penetration.
- Direction and dimensions of the wound indicate the relative positions of the assailant and the victim.
- Age of injury can be determined.
- If a broken fragment of weapon is found, it will identify the weapon or will connect an accused person with the crime.
- Position, number and direction of wounds may indicate manner of production i.e. suicide, accident or homicide.

i. **Suicide:** Signs indicative of suicide:

- | | |
|---|---|
| • <i>Location:</i> Accessible areas (precordial region—most common site) | • <i>Tentative/hesitation wounds:</i> Concomitant, shallow stabs with similar direction |
| • <i>Direction:</i> Descending, backwards and to the right | • Combination with trial cuts (mostly on the arms/wrists) |
| • <i>Depth:</i> Variable, mostly superficial and one enters the heart/pericardium | • Exposure/undressing of stab region |
| • Extensive traces of blood on the hands of the victim | • Absence of defense injuries |

Death is due to hemopericardium if heart is involved, but cardiac tamponade can occur (accumulation > 150 ml of blood is fatal).

ii. **Homicide**

- Most deaths from stab wounds are homicidal, especially if found in an inaccessible area, such as back (most common mode of homicide in UK).
- Stabs are most often located on the thorax and the neck.
- Stab wound of the chest may have any direction, but the most common direction is at an angle from left to right and from above downwards.
- The absence of weapon at the scene of incident suggests homicide as the assailant usually does not leave the weapon at the scene of death.
- The number of stabs shows a correlation with gender of the perpetrator. In homicide committed by female perpetrators, the victims had fewer stab wounds on an average than in homicides committed by male perpetrators.

The term 'overkill' refers to the infliction of massive injuries by a perpetrator by exceeding the extent necessary to kill the victim. Personal conflict between the perpetrator and the victim, history of sex or drugs are associated factors.

iii. **Accident:** Rare. It is caused by falling against any projecting sharp objects, like glass or nails.

- *Physical activity following fatal stab wound:* Whether a victim after receiving fatal stab can perform any physical activity, like running away from the assailant or shouting for help depends on the organs injured, extent of the injury, the amount and rapidity of blood lost. When bleeding is profuse, physical activity is limited and with slow bleeding, the victim may be able to run a few meters from the assailant.
 - After stab injuries to the heart, the ability to act is maintained at least for a short period of time.
 - In lesion of the abdominal aorta, the ability to act may be maintained over prolonged periods of time, whereas in injuries of the thoracic aorta, incapacitation generally occurs within seconds.
 - Injuries of the lungs or abdominal organs do not lead to immediate incapacitation.
- The amount of blood loss necessary to cause death is variable from seconds to hours and depends on the rate of bleeding, amount of blood loss, nature of the injury and body's physiological response.
 - Arterial hemorrhages from major vessels may lead to death relatively fast. A loss of > 1 litre of blood from a major vessel may be fatal.
 - Sudden blood loss causes interference with activity when it exceeds 20-25% of the total blood supply. A person can lose over a third of his blood volume before progressing to irreversible hemorrhagic shock.

– A person who is elderly or frail has little reserve to withstand blood loss and may succumb quickly.

- **Hara-Kiri (seppuku):** It is an unusual type of suicide connected with Japanese Samurai warriors in which the victim with a short sword inflicts a single large abdominal stab wound into the left side, drawing the blade across to the right side and then turning it upwards producing an L-shaped cut. The sudden evisceration of the internal organs causes immediate decrease of intra-abdominal pressure and cardiac return resulting in collapse and death.

Defense Wounds

Defense wounds are wounds of the extremities which result from the immediate and instinctive reaction of the victim to ward off an attack.

They are usually classified into two types (Fig. 11.16):

- Active defense injuries:** They are seen when the victim tries to seize the weapon and the injuries are sustained on grasping the weapon. Injuries are usually located on the palms, the flexor sides of the fingers and the interdigital spaces, more common in the web between the base of the thumb and index finger (Fig. 11.17).
 - Passive defense injuries:** These are seen when the victim raises the hands or arms for protection. They are located on the extensor or ulnar surfaces of forearms, wrists, knuckles and the back of the hands.
- If the weapon is blunt, bruises and abrasions are produced.
 - If the weapon is sharp, the injuries will depend upon the type of attack, whether stabbing or cutting.
 - In stabbing with single-edged weapon, if the weapon is grasped, a single cut is produced on the palm of the hand or on the bends of fingers.
 - If weapon is double-edged, cuts are produced on the palm and fingers.
 - Cuts are usually irregular and ragged because skin tension is loosened by gripping of the knife.

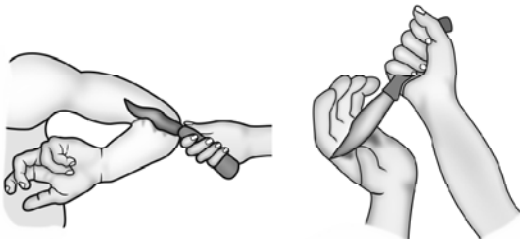

Fig. 11.16: Mechanism of defence wounds

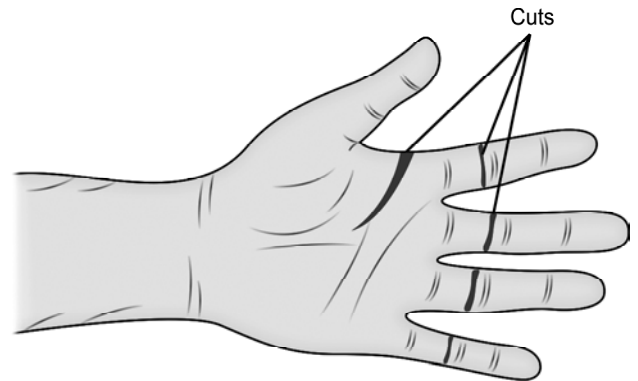

Fig. 11.17: Typical defense wound in a victim with a sharp edged weapon

Defense wounds are absent if the victim is:

- Unconscious
- Taken by surprise
- Attacked from behind
- Under the influence of alcohol/drugs

Therapeutic or Diagnostic Wounds

These are produced by medical personnel during the treatment of the patient, e.g. surgical wounds on the chest and abdomen for insertion of tubes for drainage, laparotomy incisions, cutdowns on antecubital fossa or wrists, tracheotomy and thoracotomy incisions. Sometime, they may be mistaken for primary traumatic injury, e.g. chest tube drainage wound may be mistaken for a homicidal stab wound.

To avoid misinterpretation, therapeutic tubing should never be removed prior to sending the body for postmortem examination.

Fabricated Wounds (Fictitious/Forged Wounds)

Definition: Fabricated wounds are produced by a person on his own body or by another with his consent. It can be:

- Self-inflicted wounds** are those inflicted by a person on his own body. Self-inflicted injury without conscious suicidal intent is a form of self-mutilation.
- Self-suffered wounds** are those inflicted by another person on the alleged victim.

Motive: The reasons for fabricating injuries are:

- To simulate a criminal offence for false charge
- By women, to bring a charge of rape.

- Charge an enemy with assault or attempted murder.
 - Convert simple injury into grievous one.
 - By prisoners, to bring a charge of beating against officers.
- ii. To avert suspicion
- Destroy evidence of certain injury which might connect a person with crime.
 - Assailant may pretend self-defense.
 - Policemen/watchmen may feign robbery or alleged attack.
- iii. By soldiers and prisoners to escape difficult task
- iv. Suicidal gestures, attempted suicide
- v. For the purpose of insurance frauds

Diagnosis: The diagnosis can be done by careful history taking and examination of injuries (Box 11.1).

- **Types of wound:** Mostly incised wounds, sometimes contusions, stab wounds and burns. Lacerated wounds are rarely fabricated. Burns are superficial and usually seen on left upper arm.
- **Most commonly used object** is a knife. Razor, glass piece, scissors and ice pick are some of the other objects used.
- **Body parts where found:** Top of the head, forehead, neck, outer side of left arm, front and outer side of thighs and front of abdomen and chest (Fig. 11.18).

Box 11.1: Typical features of fabricated injuries
(Fig. 11.18)

- History of assault incompatible with injuries
- Multiple shallow, non-penetrating cuts or fingernail abrasions
- Uniform in shape, linear or slightly curved course of lesions
- Grouped and/or parallel and/or criss-cross arrangement
- Location is easily reachable—usually on the left side (non-dominant side)
- Avoidance of pain sensitive regions of the body
- Absence of defense injuries
- No damage to clothes or inconsistent damage

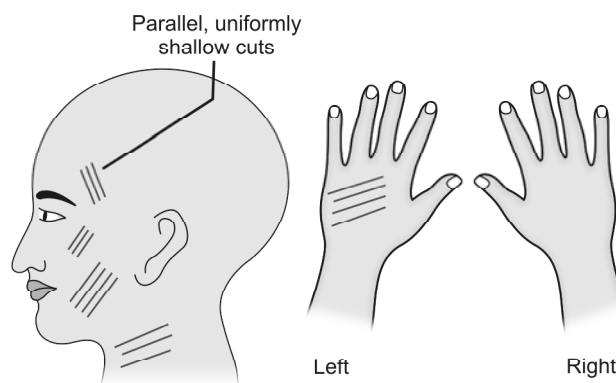

Fig. 11.18: Characteristics of self-inflicted injuries seen mostly in left side and avoid eyes, nose, mouth and ears

MULTIPLE CHOICE QUESTIONS

- 1. Graze is a form of:** *Maharashtra 08, 09*
A. Contusion B. Abrasion
C. Lacerated wound D. Incised wound
- 2. The commonest type of abrasion seen in road traffic accidents is:** *Karnataka 07*
A. Scratch abrasions B. Graze abrasions
C. Contact abrasions D. Imprint abrasions
- 3. Graze abrasions mimics:** *AI 09*
A. Eczema B. Pressure sore
C. Burns D. Scalds
- 4. Brush burn is injury due:** *MAHE 03*
A. Friction B. Electrocution
C. Steam D. Burns
- 5. Brush burn is:** *AP 09*
A. Graze abrasion B. Imprint abrasion
C. Electric burn D. Arborescent burn
- 6. 'Patterned' abrasion is variety of:** *AIIMS 05*
A. Linear abrasion B. Pressure abrasion
C. Sliding abrasion D. Superficial bruise
- 7. An auto rickshaw ran over a child's thigh, there is a mark of the tyre tracks, it is an example of:** *AIIMS 10*
A. Patterned bruise
B. Patterned abrasion
C. Pressure abrasion
D. Graze abrasion
- 8. Bite mark is an example of:** *FMGE 11*
A. Pressure abrasion B. Graze abrasion
C. Scratch abrasion D. Pattern abrasion
- 9. Scab or crust of abrasion appears brown in:** *AI 06; PGI 11*
A. 12-24 h B. 2-3 days
C. 4-5 days D. 5-7 days

1. B 2. B 3. C 4. A 5. A 6. B 7. B 8. D 9. B

10. Prominent bruise with minimum force is seen in: *AIIMS 09*
 A. Scalp B. Soles
 C. Palm D. Face
11. Blue color of contusion is due to: *Gujarat 07*
 A. Bilirubin B. Hemosiderin
 C. Hematoidin D. De-oxyhemoglobin
12. Color of hemosiderin is: *DNB 09*
 A. Brown B. Green
 C. Yellow D. Red
13. Green color of contusion is due to: *TN 08*
 A. Bilirubin B. Hemosiderin
 C. Hematoidin D. Biliverdin
14. No color change is seen in sub-conjunctival hemorrhage due to: *WB 09*
 A. Continuous CO₂ supply
 B. Little amount of blood is present
 C. Continuous O₂ supply
 D. Color change occurs but not visible to naked eye
15. Antemortem bruise is differentiated from postmortem bruise by: *AIIMS 09*
 A. Well-defined margin
 B. Capillary rupture with extravasation of blood
 C. Yellow color
 D. Gaping
16. Split lacerations are due to: *DNB 09*
 A. Blunt object B. Sharp object
 C. Sharp heavy object D. Pointed object
17. Split laceration resembles: *Jharkhand 11*
 A. Incised wound B. Abrasion
 C. Gunshot wound D. Contusion
18. Sites notorious for incised looking wound are all, except: *UP 04*
 A. Chest B. Zygoma
 C. Iliac crest D. Shin
19. Flaying is seen in which type of lacerated wound: *AIIMS 11*
 A. Split B. Stretch
 C. Avulsion D. Cut
20. Tissue bridges are seen in: *DNB 10*
 A. Abrasion B. Contusion
 C. Laceration D. Stab wound
21. In an incised wound, all of the following are true, except: *COMEDK 07*
 A. It has clean-cut margins
 B. Bleeding is generally less than in lacerations
 C. Tailing is often present
 D. Length of injury does not correspond with length of blade
22. Hesitation cuts are seen in a case of: *Karnataka 03; PGI 04, 09; Maharashtra 09; Bihar 10; MP 11*
 A. Homicide B. Suicide
 C. Accident D. Fall from height
23. Incised wounds on genitalia: *AIIMS 09, 10*
 A. Homicidal B. Suicidal
 C. Accidental D. Self-inflicted

10. D 11. D 12. A 13. D 14. C 15. B 16. A 17. A 18. A 19. C
 20. C 21. B 22. B 23. A

Definitions

- **Ballistics** (Greek *ba'llein*: throw): It is the science of projectile motion and conditions affecting that motion.
- **Forensic ballistics**: Science which deals with the investigation of firearms, ammunition and the problems arising from their use.

Ballistics is subdivided into:

- **External ballistics**: Study of the passage of the projectile through space or the air.
- **Internal ballistics**: Study of the projectile in the gun.
- **Terminal ballistics**: Study of the interaction of a projectile with its target.
- **Wound ballistics**: It is concerned with the motion and effects of the projectile in tissue.

- **Firearm**: Any instrument or device that discharges a missile by the expansive force of gases produced by burning of an explosive substance.

It consists of: (Fig. 12.1)

- Barrel**: A hollow metal cylinder in which the propellant charge is placed. It is long in rifles and shotguns and short in pistols and revolvers. The lumen is known as *bore*. The rear end where the cartridge is inserted is known as the *breech end* and the front end where the bullet/shots comes out is the *muzzle end*.
- Action**: It consists of a bolt, a striker or hammer and a trigger.
- Butt/grip**: Rear portion of stock in a shoulder arm or bottom of a handgun containing a magazine.
- Magazine**: The receptacle for the cartridges in a repeating type of weapon from which the cartridges are fed automatically into the chamber by the action of mechanism.

Velocity

- **Muzzle velocity**: The velocity of the projectile as it emerges from the muzzle end. Depending on it, firearms can be of low, medium and high velocity.

- **Striking velocity**: Velocity of the projectile at the point of impact. The velocity diminishes as the missile travels ahead to strike the target.

Trajectory: Path traced by the projectile during flight.

Classification of Firearms

Firearms are broadly classified into two categories depending on the type of barrel:

i. Rifled weapons

- Rifles: 0.22, single shot, lever action, bolt-action, pump action, auto-loading
- Revolvers: Swing-out, break-top, solid-frame
- Single shot pistols
- Auto-loading pistols
- Submachine guns
- Machine guns

ii. Smooth bore weapons (shotguns)

- Single-shot
- Double barrel
- Lever action
- Bolt action
- Pump-action
- Auto-loading

- Broadly, single-shot pistols, derringers (variant of single-shot pistols), revolvers and auto-loading pistols are considered as handguns.
- Country made firearms (*katta* or improvised firearms) are mostly 12 bore smooth bore weapons.

Rifled Firearms (Fig. 12.2)

The bore is scored internally with number of shallow spiral grooves varying from 2 to 22, most common are 4, 5 or 6, which run parallel to each other, but twisted spirally from breech to muzzle end. These grooves are called '*rifling*' and the projecting ridges between the grooves are called '*lands*' (Fig. 12.3).

- Rifles, pistols, revolvers, submachine guns and machine guns—all have rifled barrels.
- The direction of rifling can be either right (clockwise) or left (counter-clockwise)—majority of handguns have a right-hand twist.

When the bullet passes through the bore, its surface comes in contact with the projecting spirals which gives

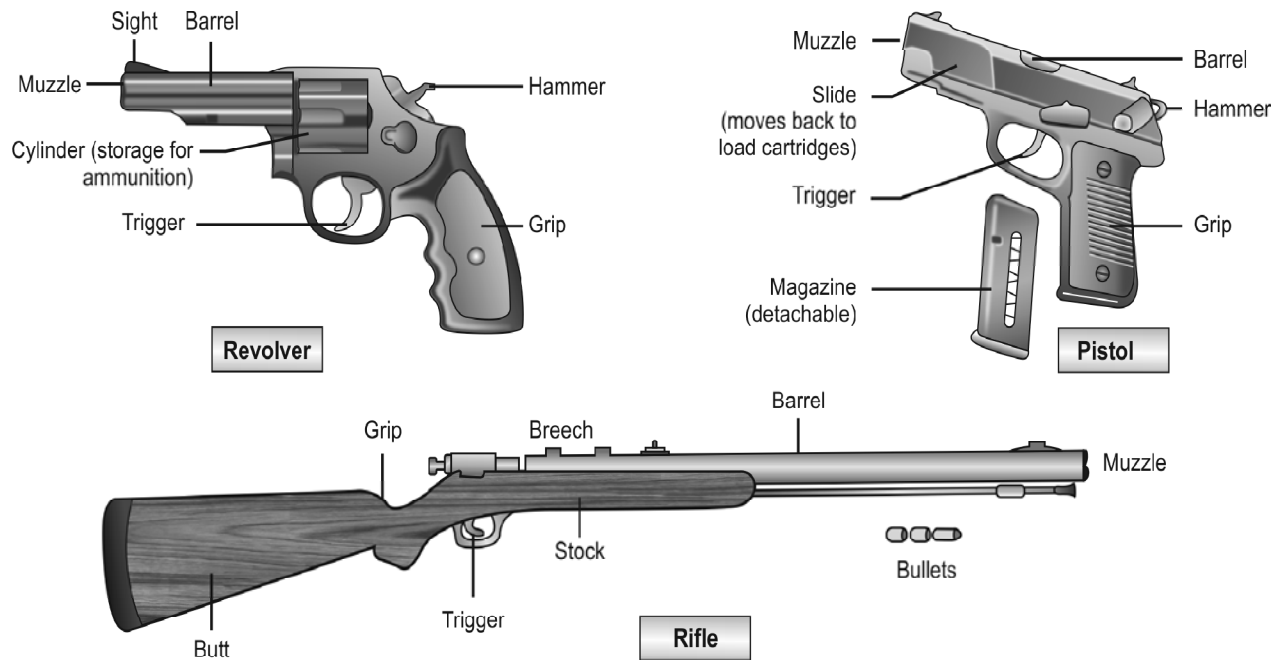

Fig. 12.1: Parts of rifled weapon

the bullet a rotational spinning or spiraling motion along its longitudinal axis. Rifling gives the bullet a signature marking that is unique to the weapon that fired it.

Advantages of rifling

- Imparts gyroscopic stability
- Increases accuracy and range
- Prevents wobbling/tumbling end-over-end
- Gives greater power of penetration

- **Fully-automatic:** Small firearm which, after first cartridge is manually loaded and fired, will eject the fired case, load the next cartridge from the magazine, fire and eject that fired case and repeats the process indefinitely as long as trigger is held pressed or until cartridge supply from magazine is exhausted.
- **Semi-automatic:** A weapon which fires, eject and reloads on trigger being pressed, but does not fire again until the trigger has been released and pressed again. Auto-loading pistols are semi-automatic wherein the empty cartridge is ejected after firing.¹
- **Revolver** has a revolving cylinder that contains several chambers, each of which holds one cartridge.
- **Rifle** is a firearm with a rifled barrel which is designated to be fired from the shoulder.
- **Zip guns:** Crude home made single shot rifled firearm.
- **Stud guns:** Tools used to fire metal studs into wood, concrete or steel.

Smooth Bore Firearms/Shotguns (Fig. 12.2)

In smooth bore firearms, the bore or the inner surface of the barrel is uniformly smooth. It is intended to be fired from the shoulder, and is designated to fire multiple pellets from the barrel.

- Barrel lengths of shotgun range from 18-36 inches; 26 and 28 inch being most common.
- Shotgun barrel is divided into three sections: chamber, forcing cone and bore.
- **Musket** is a muzzle-loaded, smooth bore long gun. It is usually fired from the shoulder.

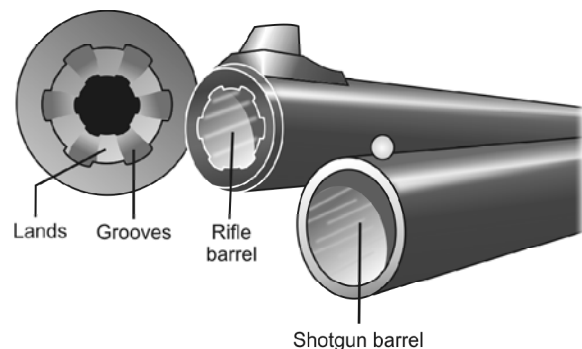

Fig. 12.2: Rifle and shotgun barrel

Choking (Fig. 12.4)

Cylinder bore: Entire barrel from breech to muzzle is of same diameter.

Choke bore: A shotgun slightly constricted at the muzzle, usually distal 7-10 cm of the barrel is narrow.

- Usual degrees of choke in descending order are full, modified, improved cylinder and cylinder.
- *Advantages of choking:* Lessens the rate of spread of shot, increases the explosive force and increases the velocity and thus increases the range.
- Dispersion of pellets in fully choked is about half that of cylinder bore.
- *For cylinder bore,* range of discharge can be obtained by measuring the diameter of the wound from the

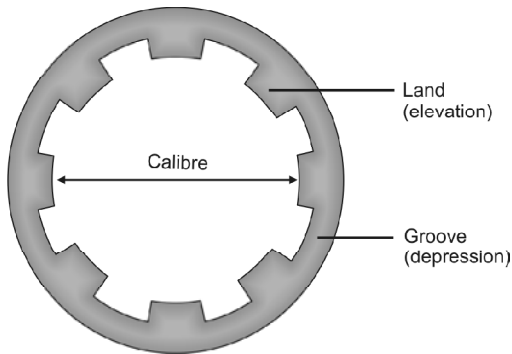

Fig. 12.3: Calibre of rifled firearm (distance between two lands)

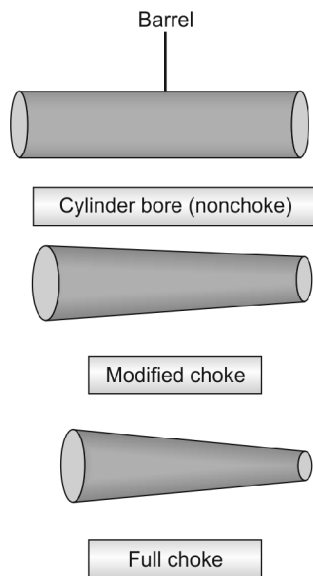

Fig. 12.4: Choking of shotgun

outermost individual pellet wound, in cm and dividing it by three, giving the result in meters.

Balling or welding of shot: In shotguns, there may be conversion of shots (pellets) into compact mass which may cause a circular or oval large entry wound of 5-10 mm and several small circular punctures, suggesting use of two weapons—one rifle and the other a shotgun.

Balling occurs due to:

- Faulty manufacture
- Old ammunition
- Too much powder
- Wads of incorrect kind
- High sealing pressure of the wads
- Pouring of paraffin into cartridge case after removing the outer wad

Paradox guns: Some shotguns which have small portion of their bore near the muzzle end rifled.

Shotgun pellets fall into two categories depending on the size: birdshot and buckshot (larger shot). There are three types of lead shot depending on the composition:

- i. Drop/soft shot: Made with pure lead.
- ii. Chilled/hard shot: Lead is hardened by the addition of antimony.
- iii. Plated shot: It is coated with a thin coat of copper or nickel to minimize distortion on firing—maintains good aerodynamic shape and increase the range.

Bore (Gauge/Calibre)

It is the diameter of the interior of the barrel of a *rifled firearm* measured between diagonally opposite lands, expressed in inches or millimeters, e.g. .22', .32', .38' (Fig. 12.3). It represents the diameter of the barrel before the rifling grooves are cut.²

For shotguns, bore is the number of spherical lead balls of size fitting the barrel of a shotgun which can be made from one pound of lead (454 g), e.g. 12, 16, 20 bore (Fig. 12.5).³ Barrel of 12 bore gun will pass a ball that weighs 1/12 lb.*

The *European system* of cartridge designation which uses metric system is more thorough and logical than the Indian system. It specifically identifies a cartridge by giving the bullet diameter and the case length in millimeters, as well the type of cartridge case, e.g. 7.62 × 54 mm R, indicates the diameter, length and rimmed bullet respectively.

* The *only exception* to this nomenclature is the .410 bore which has a bore .410 inch in diameter (smallest gauge of shotgun shell)

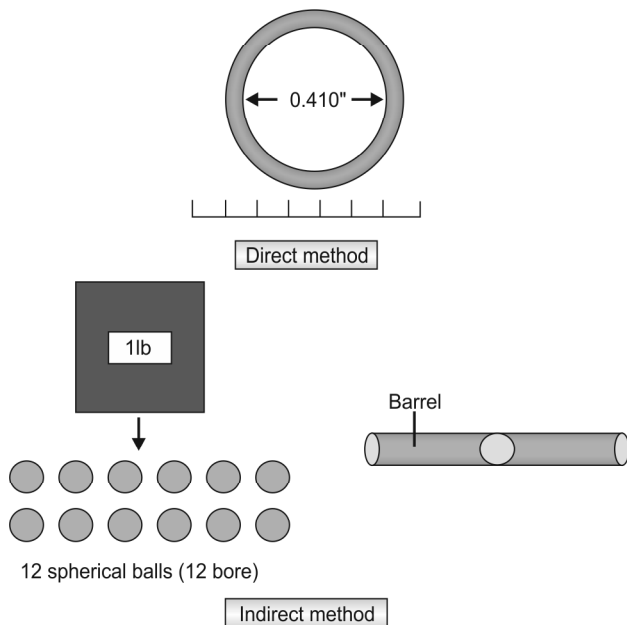

Fig. 12.5: Calibre of a shotgun

Bullet

Bullet (French *boulette*: little ball) is the projectile of a rifled firearm that leaves the muzzle when it discharges. Traditional bullet is made of soft metal and has a rounded nose. The metal used is lead with varying amounts of antimony and/or tin added to provide hardness. This is known as *round nose soft bullet*.

- Calibre of a bullet is the cross-sectional diameter.
- In the revolver and pistol, the bullet is short and the point is usually round (Fig. 12.6).
- In a rifle, the bullet is elongated with a pointed end (Fig. 12.6).

Modern bullets fall in 2 categories: lead- and metal-jacketed.

Jacketed bullets: A tough metal envelope (made of copper and zinc, or copper and nickel with steel) covering the outside of the bullet—thickness ranges from 0.0165-0.030 inches.

It is of two types:

- Full metal jacket:* Covers all, but the base.
- Partial metal-jacketed bullet:* Covers the base and cylinder portion of the bullet, leaving the nose partly or fully exposed; designed to expand or mushroom.

Advantages of jacket: It prevents:

- Deformation of the bullet in the barrel from dirt overpressures or damage outside the gun and reduces misfires.

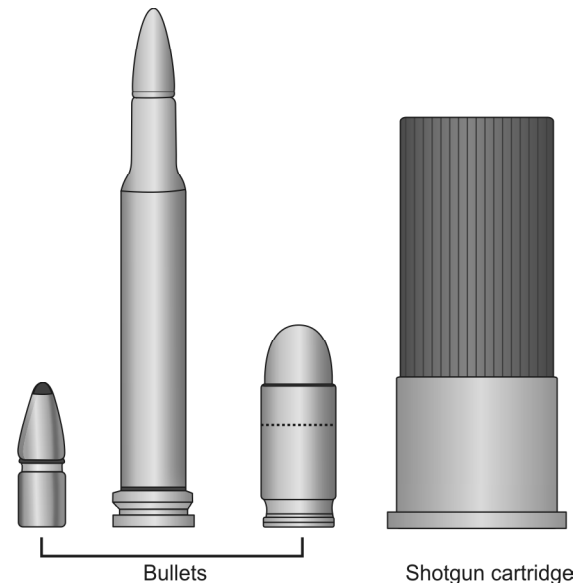

Fig. 12.6: Cartridges of rifled and shotgun weapons

- Fragmentation or melting.
- Damage to the gun barrel from 'leading'—lead fouling of the barrel.

Types of Bullet

- Dum-dum bullet:** Jacketed bullet (.303 centerfire rifle) which does not cover the entire bullet, an area near the nose is left uncovered to expose the core (Fig. 12.7).
- Hollow-point bullet:** Modern version of dum-dum bullet. There is a pit present in front of the nose (compare to soft point bullet, which has exposed lead, but no hollow). When the bullet strikes a soft target, the pressure in the pit forces the ring of lead around it to expand into a mushroom-shape. This causes more soft tissue damage and higher incapacitation index on the target (Fig. 12.7).
- Soft-point bullet:** Jacketed bullet that is left open at the tip, exposing some of the lead inside. They are designed to expand upon impact, but slowly, as compared to the hollow-point bullets (Fig. 12.7).
- Tandem bullet (Piggyback bullet):** Bullets ejected one after the other, when the first bullet having been struck in the barrel, fails to leave the barrel and is ejected by a subsequently fired bullet.⁴
Cause: Faulty ammunition or loaded firearm unused for years.
- Duplex bullet:** Contains two projectiles by design, used in military rifles and enter a target at different points.

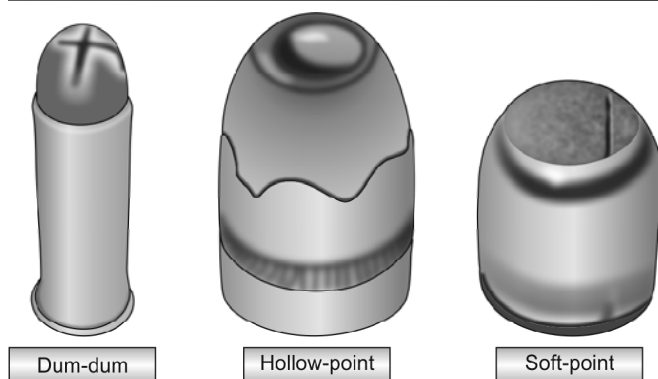

Fig. 12.7: Bullets

- vi. **Frangible bullet:** Designed to fragment upon impact, often to the point of disintegration, made mostly of copper, powdered tungsten, lead or iron.⁵ They do not ricochet.
- vii. **Souvenir bullet:** Bullet present in the body for long time with no fresh bleeding around it and surrounded by a dense fibrous tissue capsule. It was not removed as it was not causing any harm or it was located in an area from where its retrieval could cause more damage to the body, e.g. bullet in the spine.
- viii. **Incendiary bullets:** Type of army bullet used to cause fire in the target.
- ix. **Tracer bullet:** It leaves a visible mark or 'trace' while in flight so that the gunner can observe the strike of the shot.⁶
- x. **Rubber bullets** are usually non-lethal rubber-coated projectiles fired from guns, often used in riot control and to disperse protests. The British use the term *baton round*.
- xi. **Poisoned bullets** are usually 0.177 calibre bullets (the smallest in general use) which carry curare, ricin or aflatoxin.
- xii. **Wadcutter** is a bullet specially designed for shooting paper targets, usually at close range and with significant velocities.
- xiii. **Explosive bullets:** These bullets, apart from causing extensive damage in the victim, pose considerable danger to the surgeon/doctor conducting autopsy because the bullet may explode during the procedures or might detonate during ultrasonography, if it had failed to detonate in the body.

- Originally, dum-dum bullet referred to a new type of ammunition produced at the Dum-Dum arsenal in British India (near Kolkata) in the early 1890s.
- In frangible bullets, class characteristics can be demonstrated but individual markings are lost which is necessary for bullet-to-gun comparison. X-ray picture produced will be similar to the 'lead snowstorm' seen with hunting bullets.

Cartridge

Cartridge is one unit of ammunition.

Cartridge consists of:

- i. Cartridge case with percussion cap containing primer
- ii. Propellant charge (gunpowder)
- iii. Projectile (bullets/pellets)
- iv. Wads (in smooth bore weapons only)

Use of cartridge case

- Keeps various components together
- Prevents backward escape of gases
- Provides waterproofing for gunpowder

Cartridge of shotgun and rifle consists of the following as shown in Figures 12.8 and 12.9.

Percussion cap: It is made of either zinc or copper or a compound of both, so as to be malleable and deformable under the blow of the firing pin.

Cartridge cases in rifled firearms are usually made of brass. Sometimes, they are made of steel or aluminum. Cartridge cases are classified into five types depending on the configuration of their bases: rimmed, rimless, semi-rimmed, rebated and belted.

Rimmed cartridge has a base with projecting rim and used in revolvers. *Rimless cartridge* is used in pistols. Small-arms cartridges are classified as centrefire or rimfire, depending on the location of primer.

- *Centrefire:* The primer is located in the centre of the base of the cartridge case.
- *Rimfire:* Cartridges with priming mixture inserted in the hollow rim. Firing pin gives a hit mark on the circumference.

Blank cartridge: Cartridge with primer, gunpowder and wadding, but without any bullet. It is used in:

- Starter pistol in sports
- Stage/movie performance
- Army maneuvers

Wad: Wad is made of some soft material, like disc of felt, cardboard, cork or straw. It is placed between

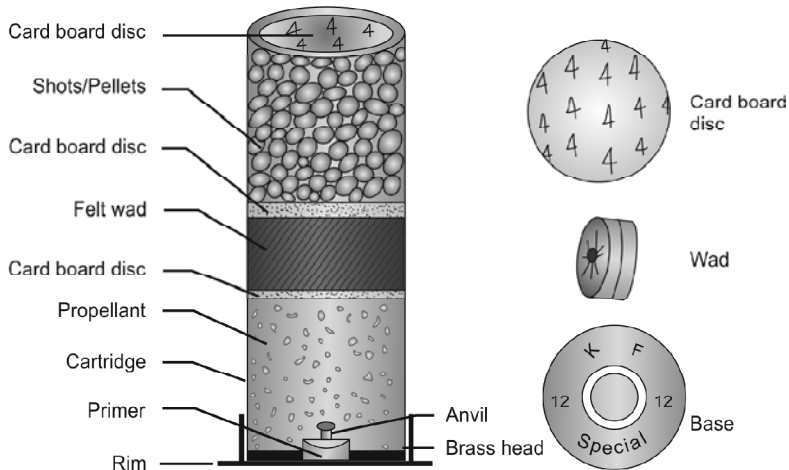

Fig. 12.8: Parts of a shotgun cartridge

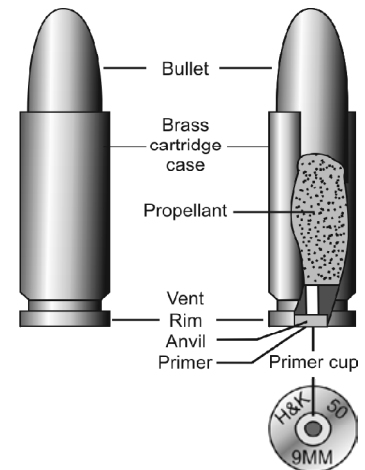

Fig. 12.9: Parts of a rifled cartridge

powder and shot or over the shot. The cardboard disc behind the shot charge prevents the pellets from getting lodged in the felt wad.

Advantages of wad:⁷

- Allows optimum pressure to develop
- Seals the bore effectively
- Helps in lubrication
- Prevents the escape of gas from the breech end
- Separates propellant from the projectiles

Gunpowders (Propellant Charge)

- Black powder:** It produces flame, smoke and heat, and consists of granular ingredients, like sulfur, charcoal and saltpeter (potassium nitrate). The optimum proportions for gunpowder and its function is given in Table 12.1.
- Smokeless powder:** It is more effective than black powder as it burns more efficiently and produces much less smoke resulting in less blackening and tattooing around the entry wound.

Types

- Single base powder** consists of nitrocellulose (gun cotton). It is the most common type of commercial powder, because of its simplicity, adequate power and low flame temperature.⁹
- Double base powder** consists of nitrocellulose and nitroglycerin. It is more powerful than single base because of nitroglycerin, but has a flame temperature that may melt the steel of the barrel.

Table 12.1: Composition of gunpowder with its function⁸

Chemical	Percentage (%)	Function(s)
Potassium nitrate	75	Oxygen supplier or oxidizer
Sulphur	10	Makes the mixture more denser and readily ignitable
Charcoal	15	Fuel

c. **Triple base powder** consisting of nitrocellulose, nitroglycerin and nitroguanidine is used at present. The quantity of nitroglycerin is small, but sufficient to give power; the nitroguanidine lowers the flame temperature while adding an active explosive constituent.

- Semi-smokeless powder:** It consists of mixture of 80% black and 20% smokeless type.

- When black powder burns properly, it produces 44% of its original weight in gases and 56% in solid residues (potassium carbonate and potassium sulfate). These residues appear as a dense, white smoke. A grain of black powder gives rise to 200-250 cc of gas composed of CO₂, CO, N₂, hydrogen, H₂S and traces of methane and O₂ whereas a grain of smokeless powder forms 800-900 ml of gas with nearly 100% conversion of powder to gases. [about 15.1 grains = 1 gram and 7,000 grains = 1 pound (approx)]¹⁰
- **Grading of black powder:** The term grading refers to grain size. There are two separate categories of gunpowder grades, 'C' and 'F'. 'C' grade is for cannon and large capacity explosive devices. Powder meant for small arms

uses the letter 'F' to denote the grain size. It correlates to the size of the screen mesh which it falls through for sorting. Ranges are course FG (used in large bore rifles), FFG (used in medium and small bore arms, such as muskets), FFFG (used in small bore rifles and pistols) and FFFFFG (used in short pistols) which is very fine. Small particles, higher FG numbers burn much faster.¹¹

Primer: The primer is a small charge of impact-sensitive chemical that may be located at the centre of the case head (centrefire ammunition) or at its rim (rimfire ammunition). It ignites the powder or propellant charge by impact of gun's firing pin.¹²

Primer is usually composed of:

- | | |
|-----------------------|-------------------|
| 1. Lead styphnate | 2. Barium nitrate |
| 3. Antimony sulphide | 4. Lead peroxide |
| 5. Potassium chlorate | 6. Tetrazine |

Mechanism of Discharge of Projectile

A firearm is fired when the trigger is pulled. The trigger releases a pin or hammer whose tip strikes the percussion cap at the base of the cartridges. This contains the primer which explodes by the heat created by the firing pin. This sends a flash through a tiny hole into the main body of powder filled case and powder charge or propellant is set on fire producing a large amount of gas and heat under pressure instantaneously. The cartridge case swells outwards, due to which the hold on the bullet (missile, pellets) is released; the bullet is forced into the barrel and passed out.

- When the bullet emerges from the barrel, it is accompanied by:
 - i. Unburnt propellant particles
 - ii. Partially burnt propellant particles
 - iii. Soot from combustion of propellant
 - iv. Nitrates and nitrites from combustion of propellants
 - v. Particles of primer residue (oxides of lead, antimony and barium)
 - vi. Vaporized metal and metallic particles stripped from the bullet and cartridge case
- Varying the length of the barrel also affects how much powder exits the muzzle. Shortening the barrel causes more unburned powder to emerge and vice-versa.
- The confined gas left behind gives recoil thrust to the gun.
- Noise of gun firing is caused by the muzzle blast or sudden release of gases disturbing the air.

- The blast has the shape of a cone, the apex of which is located at the muzzle.

- **Muzzle blast** is the release of gases under high temperature and pressure from the muzzle of a firearm when it is discharged.
- **Muzzle flash** is the visible light of the muzzle blast.

Wound Ballistics and Mechanism of Injury

As a missile traverses the body, it causes injury by transferring some or all of its energy. This is manifested as laceration and crushing of tissues in its path, and sometimes away from its path. The amount of energy transferred is given by the formula:¹³

$$KE = \frac{1}{2} M (V_1^2 - V_2^2)$$

where KE = Kinetic energy

M = Mass of the bullet

V_1 and V_2 = Velocities at entry and exit

It shows that velocity rather than its weight plays a greater role in determining the amount of kinetic energy possessed by a bullet. Doubling the weight doubles the kinetic energy, but doubling the velocity quadruples the kinetic energy.¹⁴

In general, bullets fired from handguns are propelled at a low velocity, have low energy (50-100 J) and result in *low energy transfer wounds* which are characterized by injuries confined to the wound track. Missiles with high available energy (2000-3000 J) include high-velocity assault rifle bullets and have the potential to cause *high energy transfer wounds*. As a bullet moves through the body, it crushes and shreds the tissue in its path, while at the same time flinging outward (radially) the surrounding tissue from the path of the bullet, producing a temporary cavity considerably larger than the diameter of the bullet (Fig. 12.10). Cavitation in solid organs, like liver, kidney and spleen is often fatal, but in the bones, it creates *secondary missiles*.

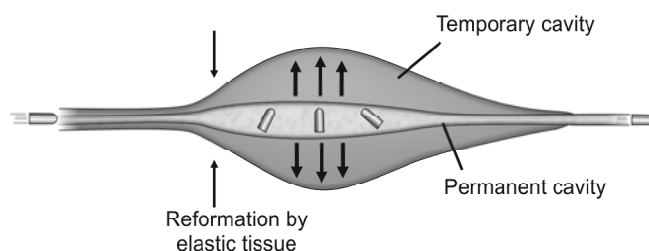

Fig. 12.10: Shock waves from a gunshot result in cavitation

Firearm Wounds

Gunshot wounds are either penetrating or perforating.

- **Penetrating wounds:** The bullet enters an object and does not exit.
- **Perforating wounds:** The bullet passes completely through an object.

For example, a bullet striking the head may pass through the skull and brain before coming to rest under the scalp, that producing a penetrating wound of the head, but perforating wound of the skull and brain.

The characteristics of firearm wounds depend upon:

- Nature of the firearm, whether shotgun or rifle
 - Shape and composition of the missiles
 - Range (distance) of firing
 - Part of the body struck (head or trunk)
 - Direction of firing
- **Tattooing:** It consists of unburnt or partially burnt powder particles that are embedded in and under the skin through the force of their impact (when the weapon is near enough for the powder grains to strike).
 - Tattooing is an antemortem phenomenon and indicates that the individual was alive; and it cannot be wiped away.
 - It consists of numerous reddish-brown punctate abrasions surrounding the wound of entrance.
 - The greater the range, the larger and less dense the powder tattooing.
 - Marks usually heal completely if the individual survives (involves the superficial layer of the epidermis).
 - **Stippling:** It is the visible mark powder grains leave, when it does not get embedded on the skin (when the range increases). It may also be produced by other material, e.g. shotgun filler or fragments of intermediary targets. The term 'stippling' is sometimes used synonymously with 'powder tattooing.'
 - **Blackening (soot or smoke soiling/smudging):** Deposition of powder soot (carbon) produced by combustion of gunpowder.¹⁵
 - As the range increases, the size of the zone of blackening will increase, whereas the density will decrease.
 - It can be easily removed with a wet sponge.
 - **Fouling:** Tiny lesions around the entry wound caused by fragments of metal expelled by the discharge. These fragments may come either from the surface of the bullet or from the interior of the barrel and cannot be wiped off from the skin.

- **Abrasion collar/ring:** As the bullet strikes the skin, it first indents and then stretches the skin surface so that perforation takes place through a tense area which produces a rim of flattened reddish-brown zone of abraded epidermis, surrounding the entrance wound. The abrasion ring can vary in width, depending on the calibre of the weapon, the angle and site at which the bullet entered.
 - A bullet striking perpendicularly will produce a concentric ring and if the bullet penetrates at an oblique angle, the zone will be eccentric with the wider zone on the side from which the bullet came (Fig. 12.11).
 - Entrance wounds in the skin overlying the clavicle have a wider abrasion ring than those in the other parts of the body.
 - Some contusion is present in abraded collar and as such, it is also called '**contusion collar**'.
- **Grease/dirt collar (bullet wipe):** A black/gray colored ring is seen lining the defect, sharply outlined caused from removal of substances from bullet as it passes through the skin. It consists of bullet lubrication, lead from surface of bullet, barrel debris and gun oil from interior of the barrel.
 - By contrast, soot is dark in the centre and fades towards the periphery.
 - Abrasion collar surrounds the dirt collar.
 - This gray rim is more prominent in clothing, where it is called 'bullet wipe'.
 - Abrasion and dirt collars are proof of an entry wound.
- **Recoil/muzzle impression:** If the contact is tight, muzzle impression is seen due to firm mechanical pressure of impact of the metal rim against the skin

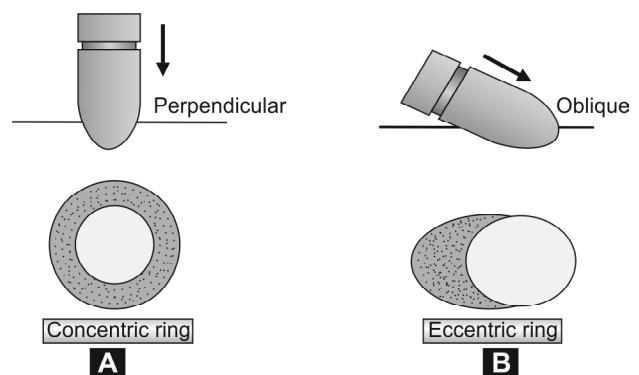

Fig. 12.11: Abraded collar when bullet struck (A) Perpendicularly (B) At an angle. The wider side determines the direction of fire

and also due to subcutaneous expansion of gases lifting the skin forcibly up against the muzzle.

- **Back spatter:** In a contact shot, the muzzle blast and negative pressure in the barrel may suck blood, hair, fragments of tissues and cloth fibres back into the barrel.
- **Blowback phenomenon:** Cruciate, stellate or ragged laceration is seen, especially if there is a thick bone immediately under the skin, such as the skull; occurs as a result of expansion of gases beneath the skin and their exit through the entry wound (in contact wounds).
- **Point blank:** When the range is very close to, or in contact with the surface of the skin.

Characteristics of Shotgun Wounds (Fig. 12.12)

At close range, the shotgun is the most formidable and destructive of small arms. When a shotgun is fired, the projectile travels in a compact mass. As the range increases, the individual pellets spread out, collectively travel in a cone-like manner and their velocity decreases with distance. A rough estimate of the rate of spread is about 1 inch/yard from the muzzle of a full choke gun.

Contact or Near Contact Shot

Contact wound: Muzzle of the weapon is held against the body at the time of discharge. Contact wound can be hard (muzzle held tightly against the skin), loose, angled or incomplete.

- Contact wounds differ in appearances, depending upon the site, whether it is the head or the non-resisting parts, e.g. chest or abdomen.
- Contact shotgun wounds of the *head* are the most mutilating firearms wounds. Extensive destruction

of bone and soft tissue structures occurs with bursting ruptures of the head and evisceration of the brain since the gases have restricted space for expansion. Soot is seen around the entrance in most contact wounds of head.

- Contact wound of the *trunk* appear circular in shape and have diameter usually equal to that of the bore of the weapon as shot enters as a mass.
- If the muzzle is pressed firmly, soiling or burning is absent, but the edges of the wound is seared and blackened by the hot gases and a muzzle impression may be found.
- If the muzzle is not pressed firmly or is loosened by recoil; flame, gas and soot may escape sideways and soil the adjoining skin.
- If clothing interposes between the muzzle and skin, soot will be found on the clothing, as well as the skin. Clothing may be singed and there may be burning around the skin wound.
- The gases cause laceration of deeper tissues and even fragmentation of bone.
- Wad is often found in the wound and this may prove to be an important clue to the type of cartridge used.
- Wound track and adjacent tissues appear cherry-red due to carboxyhemoglobin and carboxymyoglobin from absorption of carbon monoxide (CO) formed from combustion of the gunpowder (can spread upto 15 cm or more from the entrance).
- Usually, shotgun projectiles do not exit out of the body.

Close Range (Between contact and 3 ft)

Close range shotgun wounds of the head are almost as mutilating as contact wounds because the pellets are still traveling in a single mass. Large gaping tears of the scalp are present.

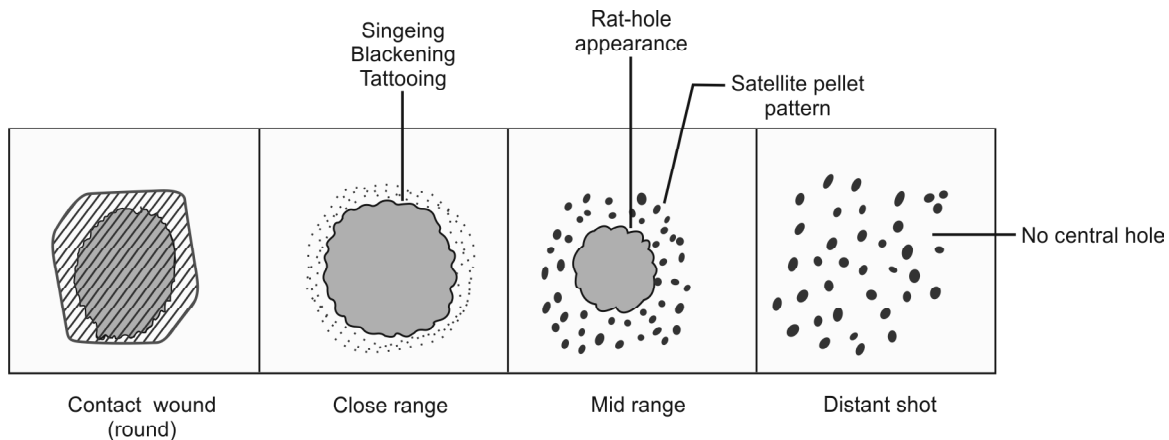

Fig. 12.12: Shotgun wounds at varying distances

- When clothing is present, it traps most of the soot and powder grains and may reduce the flame effect.
- Depending on the angle of firing, the wound is circular or elliptical. There are no separate pellet holes.
- Scorching of skin, singeing of hair, blackening and tattooing (less with smokeless powder) of skin is seen. Blackening and tattooing can be demonstrated by *infrared photography*.
- No burning is seen beyond 1 ft (30 cm).
- Soot soiling is less and disappears at over 1-3 ft.
- Wound track and adjacent tissues appear cherry-red due to absorption of CO.
- Wads or plastic cups from cartridge may be found in the wound.

Powder tattooing from a shotgun is less dense than the tattooing a handgun produces at the same range, due to more complete combustion of powder caused by the greater barrel length.

Mid/Near Range (Upto 7 ft)

As the muzzle of the shotgun moves further from the body, tattooing disappear and the diameter of the circular wound of entry increases in size until a point is reached where individual pellets begin to separate from the main mass.

- No burning and soot soiling is there, but tattooing can be seen upto 3-4 ft (90-125 cm).
- Between 3 ft, the shots enter the body in one mass, producing a round hole. The edge of the wound is abraded and crenated/scalloped (*rat hole*).
- At a distance of 4 ft, the shot mass spreads and individual pellet holes may be seen which are round with surrounding abrasion at their margins.
- At a distance of 6-7 ft, the central aperture is surrounded by separate openings in an area of 8-10 cm in diameter.
- As distance increases, the main entrance wound progressively becomes smaller and individual pellet wounds increases in number.
- Beyond 4-5 ft, the wads often strike the body below the main wound leaving a circular or oval imprint on the skin.

Long Range (Beyond 7 ft)

Beyond 10 ft, great variation occurs in the size of the pellet pattern depending on the ammunition used, the choke of the gun and the range.

- Charge of shot progressively spreads, so that small openings due to separate pellets appear around the main wound. With further increase in range, there is a more even distribution of pellet injuries with disappearance of the central aperture.
- At far longer ranges, the shots, depending upon its size and velocity, may not lodge in the body.
- Wadding injury may be seen upto 15-20 ft. Wad may cause an independent impact abrasion.

All these figures presuppose the lack of clothing since it will absorb soot and powder, making close range wounds appear to be distant by examination of the body alone.

Characteristics of Rifled Firearms Wounds

Handguns are most commonly used form of firearm both in homicides and suicides. The presence and extent of tearing of the skin depends on the calibre of the weapon, the amount of gas produced by the combustion of the propellant, the firmness with which the gun is held against the body and the elasticity of the skin.

Contact Shot (Fig. 12.13)

Whole of the discharge containing flame, gases, powder smoke and metallic particles will be blown under pressure into the track taken by the bullet through the body, often leaving little evidence that one is dealing with a contact wound.

- In case of contact shot over *forehead or mastoid* (head) region where the bone is thick, entry wound will be large and irregular, stellate or cruciform shaped having everted margins because of expansion of gas between the skull and scalp (Fig. 12.13).^{16,17} Back spatter may be seen.

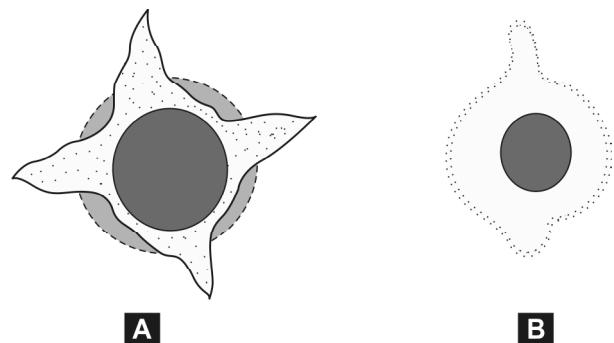

Fig. 12.13: Contact wounds
(A) Stellate wound (B) Muzzle imprint

- In contact wounds of the *trunk*, stellate/cruciform entry wound usually do not occur because the gas is able to expend into the abdominal or chest cavity or soft tissue.
- Contact wound over *abdomen* will show cavitations, because of blast effect.
- There is little or no evidence of burning, singeing, blackening and tattooing.
- Muzzle impression may be present around the wound.
- Muscles around the track taken by bullet will be cherry-red due to presence of CO.
- Burning, blackening and powder grains deposits will be found in the depths of the wound (examination of the wounds with dissecting microscope is of value).
- Hair nearby may get burnt or clubbed by fire/heat.

Close Shot (Flame Range) (Fig. 12.14)^{18,19}

Body lies within the range of flame, smoke and powder blast, i.e. within 2-3" (5-8 cm).

- Entry wound is small and circular in shape having inverted, contused lacerated margins.
- Skin adjacent to the entry wound shows evidence of grease/dirt collar on the inner zone and abraded-contused collar on the outer zone.
- Evidence of burning, singeing, blackening and tattooing of the skin in and around the entry wound.
- Clothings over the part will be burnt from flame of discharge.
- Hair, in and around, show singeing and will look clubbed, shriveled and swollen at intervals (rarely seen, because the gas emerging from the barrel blows it away).
- The length of the barrel of a firearm has considerable effect on the pattern of smoke produced on the target,

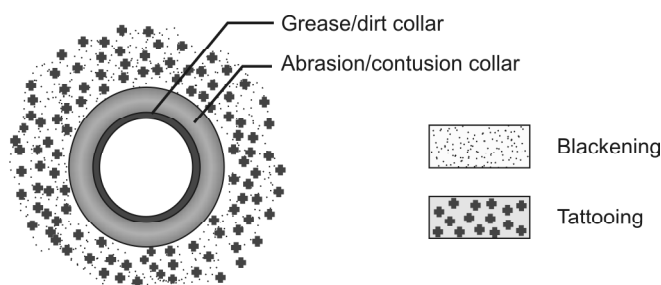

Fig. 12.14: Close shot entry wound of a bullet
(For color version see Plate 2)

e.g. a pistol with a 10 cm barrel will spread the smoke over a much larger area than a rifle having a 2 feet barrel.

- The blood and injured soft tissues in the track will be cherry-red due to CO.

Near Shot (Medium-Range or Intermediate Range)

Gunshot entry wounds with powder tattooing, but no soot, are commonly referred to as 'near-shot' or 'intermediate range' wounds i.e. when the range is within 24" (60 cm).

- Entry wound will be circular in shape, approximately the same size as the bullet, with lacerated, inverted edges surrounded by a narrow zone of abrasion and grease collar, with no evidence of any burning and singeing.
- Entry wound looks like a distant shot when the range is beyond 6" (15 cm). Beyond 15 cm, the burning effects of gases and singeing of hair is absent.
- Zone of blackening will be present when the range is within 6-8" (15-20 cm), and zone of tattooing will be present around it. For handguns cartridges, soot is absent beyond 30 cm.
- Tattooing becomes discrete as the range increases, no trace of powder marks will be found when the range is beyond 24", i.e. normally beyond arm's length. For handguns, powder tattooing extends to a maximum distance of 18-24 inches (45-60 cm).

Distant Shot

Gunshot entry wounds with no associated soot or gunpowder stippling are referred to as 'distant' wounds, i.e. range is beyond 2 feet.

- Entry wound is usually circular in shape, smaller than the bullet, because of elasticity of skin, and associated with the usual zone of abraded collar, lacerated, inverted skin margins and a bigger dirt collar.
- Distant gunshot wounds of the *head* may have a stellate or irregular appearance simulating a contact wound.
- There will be no evidence of any burning, singeing, blackening and tattooing.
- Wound of exit will be slightly bigger than the wound of entry.
- Sometimes, the term 'indeterminate' is used since closer range shots where the soot and gunpowder is totally blocked by an interposed target may produce identical appearing wounds.

Irregular, cruciform or stellate entry wounds can occur in individuals shot at intermediate or distant range when the bullet perforates the skin underlying a bony prominence. Head is the most common site—forehead, top and back of the head, supraorbital ridges and cheek bone. Uncommon site is the elbow.

Firearm Wounds on Skull (Fig. 12.15)²⁰

- **The entry wound** shows a punched out hole (clean cut) on the outer table and beveled appearance on the inner table (as it remains unsupported, chipping of the bone occurs). Fissured fracture may radiate from the hole. The piece may be driven inside causing injury to the brain. Dura shows irregular tear. In contact wounds, shattering of skull wound may occur.
- **The exit wound** on the inner table shows clean cut hole and beveling on the outer table. The wound is larger than the entry wound due to the deformity and tumbling of the bullet on entering the skull. The beveling helps to assess the angle of fire.

Tangential entrance wounds (gutter wound) into bone may produce 'keyhole' defects with entrance and exit side-by-side; the skin is torn or lacerated by the bullet (Fig. 12.16).

Puppe's rule: This rule states that when two fracture lines intersect each other, the second fracture line never crosses the first one (Fig. 12.17). It determines the sequence of shots when several bullets have struck the cranium and is also applicable to the multiple blunt force impact on the skull.

Exit Wounds

Shotguns

- The appearance of shotgun exit wound depends upon the part involved and the nature of tissues encountered during its passage in the body.

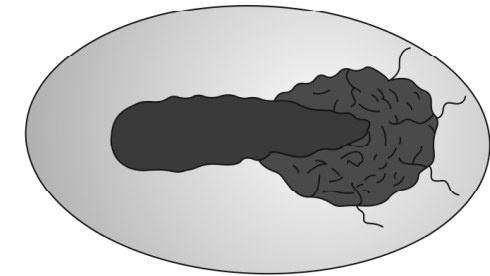
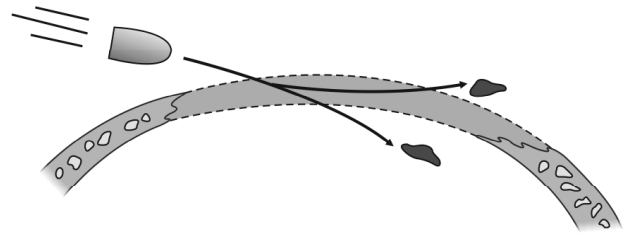

Fig. 12.16: 'Key-hole' defect on the outer bone table when a bullet strikes it tangentially

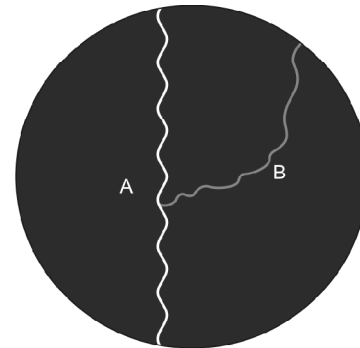

Fig. 12.17: Puppe's rule (A) First (initial) fracture (B) Subsequent (later) fracture (For color version see Plate 2)

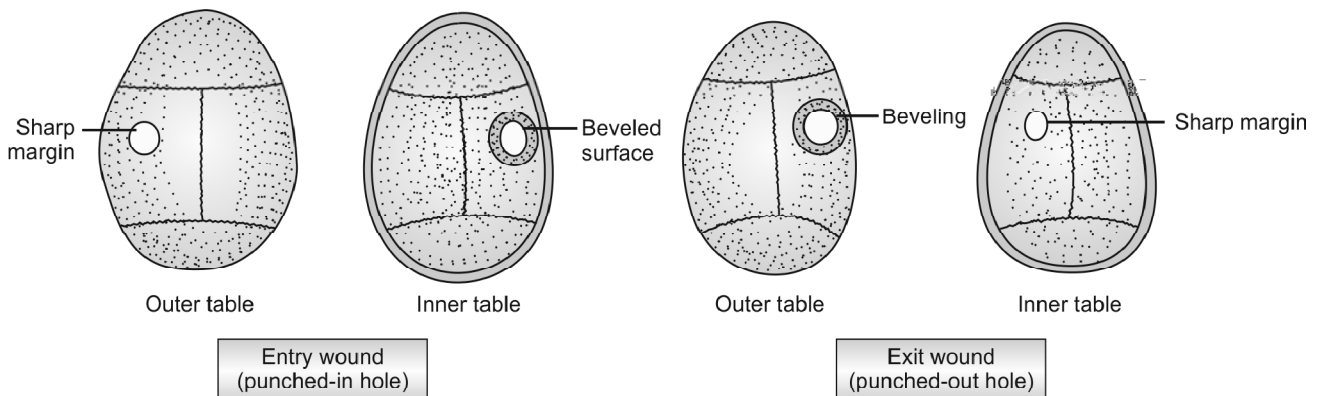

Fig. 12.15: Bullet wounds in skull

- Exit wound with shotguns are uncommon, especially when they involve the chest or abdomen.
- When present, it is in the form of serrated, irregular laceration with everted margins through which some tissues or bone fragments may be seen protruding.
- Sometimes, the pellets may accumulate immediately beneath the skin opposite the entry wound after they have traveled through the body and trapped by the skin.

Rifled Firearms

Exit wounds, whether they are from contact, intermediate or distant firing, all have the same general characteristics.

- Bullet which pass through the body causes exit wound, sometimes called as '*outshoot wound*'.
- It may be stellate, circular, elliptical, cruciate, star shaped or slit-like as bullet gets deformed when struck by a bone (common in head and shoulders)—may be confused with contact wounds.
- In contact wounds and very close range, exit wound is smaller than entry wound due to elastic nature of the skin. However, as range increases, the size of exit wound also increases.
- Exit wounds do not show burning, blackening, tattooing, abrasion or contusion collar. The edges are everted, torn or puckered with pieces of contused, hemorrhagic subcutaneous fat or muscle protruding out of the defect.

*Variations in shape and size of exit wounds occur when:*¹⁷

- Bullet tumbles in the body and fails to exit nose-end first
- Bullet exits as multiple pieces after breaking up
- Bullet is deformed
- Unsupported skin tends to tear and break into pieces
- Fragments of bone are blown out along with the bullet (secondary missiles)

Shored or supported exit wound: If the skin at the exit wound is supported by firm objects or tight garments e.g. belt, waist band, bra or tie, or body leaning against a hard object such as wall or floor, the exit wound appears as a circular defect surrounded by a margin of abrasion resembling an entry wound.²¹ The pattern of the material overlying the shored exit may be imprinted on the edges of the wound.

Diff. 12.1 tabulates the differences between entry and exit wound of a rifled firearm (Fig. 12.18).

Peculiar Effects of Firearms

Atypical entrance wound will be found in case of yawing or tumbling of a bullet.

- **Yaw:** Deviation between the long axis of the bullet and axis of the path of the bullet (Fig. 12.19).
- **Tumbling bullet:** Bullet rotates end-to-end during its path (Fig. 12.20).

Tail wobble or tail wag: It occurs for few microseconds after the bullet leaves the muzzle and may cause great damage.

Miscellaneous entry wounds

- **Graze/slap wound:** Bullet strikes the skin at so acute angle that it produces an elongated area of abrasion without actually perforating or tearing the skin.
- **Superficial perforating wound:** Shallow through-and-through wounds in which the entry and exit are close together.

Ricochet bullet: It is a rebound, deviation or deflection of a bullet from its course by striking an intermediate surface. Sometimes, the bullet may strike the surface, but fail to penetrate and glance off. Such projectiles are commonly deformed, and deformity depends upon texture of the bullet, critical angle of impact* and intermediary object.

- Round nose bullets are more likely to ricochet than flat nosed; full metal-jacketed than lead and low velocity than high velocity.

Bullets that do not exit the head are retained in the cranial cavity and shows internal ricochet (more common with .22 lead bullets).

- **'Billiard ball' ricochet effect:** This is seen in relation to ricochet of shotgun pellets from an intermediate target surface, such as door, windows, clothes or within the body itself.
 - When a mass of shotgun pellets enters tissue, the first pellets which penetrate are slowed and struck from behind by the following pellets which can cause them to scatter through the tissue much like a cluster of billiard balls struck by the cue ball.
 - Radiographically, the dispersal of pellets may suggest that the weapon was fired from a distance, when in actuality the weapon was fired from close range.

* It is the angle of incidence below which a bullet striking the surface will ricochet rather than penetrate which is determined by the nature of the surface, the construction and velocity of the bullet.

Differentiation 12.1: Entry and exit wound (Fig. 12.18)

S.No.	Feature	Entry wound	Exit wound
1.	Size	Smaller than the diameter of the bullet (except contact shot)	Bigger than the bullet
2.	Edges	Inverted	Everted, puckered
3.	Skull	Clean cut on outer table and beveled in the inner table	Beveled in the outer table and clean cut on inner table
4.	Bruising, abrasion and grease collar	Present	Absent
5.	Burning, blackening, tattooing	May be seen	Absent
6.	Bleeding	Less	More
7.	Fat	No protrusion	May protrude
8.	Wound track	May be cherry-red due to carboxyhemoglobin	No color change
9.	Fibres of clothes	Turned in	Turned out
10.	Radiological/micro-chemical examination	Lead ring may be seen	Absent
11.	Spectrograph	More metal is found	Not so

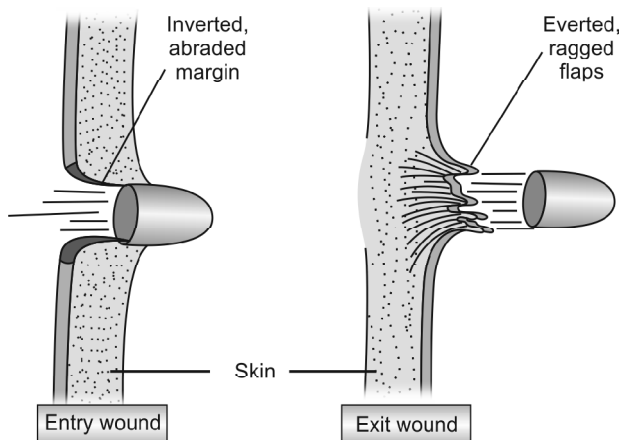

Fig. 12.18: Firearm entry and exit wounds

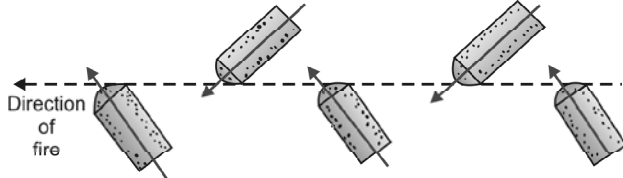

Fig. 12.19: Representation of 'Yaw' associated with bullets

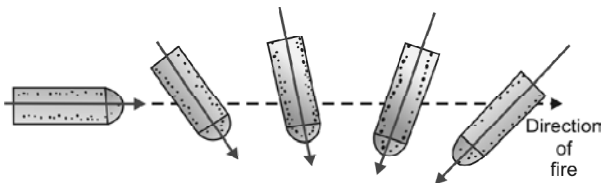

Fig. 12.20: Representation of 'Tumble' associated with bullets

- **Kennedy phenomenon:** The evaluation of whether the wound was an entrance or an exit becomes difficult due to surgical alteration. It is in reference to the late US President John F Kennedy who was shot and during autopsy the doctor directly opened the entry wound to remove the bullet.

- The **single bullet theory (magic bullet)** was introduced by the Warren Commission in its investigation of the assassination to explain what happened to the bullet which struck Kennedy in the back and exited through his throat. Purportedly, it passed through President's neck, Governor Connally's chest and wrist and embedded itself in the Governor's thigh.
- **Krönlein shot** is a very rare injury of the skull caused by a high-velocity bullet. In this low-range shot, there is bursting of the skull and laceration of the dura mater with complete evisceration of the brain. The autopsy could not determine with certainty the appearance of the primary gunshot wound, and the entrance and exit wounds.
- **Rayalseema phenomenon:** It is an artifact. Sometimes, to fake a firearm injury, a bullet is planted in an individual killed initially by stab injury to mislead the investigating agency. These cases were reported from the district of Rayalseema in Andhra Pradesh.

Postmortem Examination

Scene of crime: Before any object is removed, the following photographs must be taken with identifying labels and rulers:

- Bullet holes in the walls, floor, ceiling or in the furniture
- Body of the victim before and after undressing
- After removing the clothes, entrance and exit bullet holes along with bullets, pellets and wads found in the body

X-ray examination should be done before autopsy to avoid prolonged search for the bullet in the body.

Usefulness of X-rays:

- To see whether the bullet/any part of it is still inside the body
- To locate the bullet
- To retrieve small fragments deposited in the body by a exited bullet
- To identify the type of ammunition/weapon used prior to autopsy
- To document the path of the bullet

Clothing

All the clothing is removed, the condition and the extent of blood staining is noted. Location, number, size of the bullet hole, the extent of soot and powder distribution and the density of tattooing around the bullet holes is noted. Sometimes, a single bullet may produce several holes due to the presence of folds in the garment, and simulate more than one shot. Note whether the fibres of the clothing are turned inwards or outwards. Clothing may be forced into the tissues in shotgun wounds.

- The holes in the clothing should be connected to those in the body to determine the direction of fire. The clothes should be air dried and then sealed in clean brown paper.
- *If no exit wound is present*, either the clothing did not cover the area of the exit or the bullet may be in the clothing or has fallen away.
- The powder grains adherent to clothing should be carefully removed with forceps and preserved in a glass vial as they may be lost from the clothes due to rough handling.
- *Infrared photography* can be used to find out soot deposit on dark colored or black fabrics. X-ray can be used to search for larger metallic fragments.

Bullet wounds: Multiple wounds should be numbered. On the body diagrams, wounds are drawn as they appear on the body including burning, blackening, tattooing and abrasion collar.

Description of Bullet Wounds (Entry or Exit)

- i. The exact location of each wound in relation to its distance from:

- The top of the head or the sole of the foot, as it gives the direction of the track and also the height above the ground at which the bullet entered and left the body, if the person was in standing position when struck.
- Midline of the body.
- A fixed anatomical landmark.

- ii. The shape (stellate, round, slit-like or irregular) and size, abrasion collar and powder marking surrounding the borders of the wound. The difference in the width of the abrasion collar at different points is noted, as they indicate the angle at which the bullet struck the skin.
- iii. The presence or absence of blackening and tattooing should be noted. If the entrance wound is soiled with blood, it should be sponged carefully so that any tattooing of the skin is not disturbed.
- iv. Muzzle imprint.
- v. Soot deposit.
- vi. Metal deposition, if any.

Alteration by medical care personnel: If surgical alterations are made on entry or exit wound of the victim, the surgeon should make adequate documentation of their location and nature in the hospital records. This prevents confusion, if subsequently the patient dies and an autopsy is performed.

Track taken by the bullet through the body: It is advisable to record the wound in the skin and the wound track through the body in one section. Probes should not be introduced through the track. The path taken by the bullet through the body should be carefully traced by dissection with the organs in situ.

The bullet track should be described in relation to the planes of the body:

- From front to back or from back to front
- From left to right or from right to left
- From above downwards or from below upwards
- Angular estimates, i.e. vertical, horizontal and sagittal planes of the body

Frequently, the track of the bullet is unpredictable due to its deflection by bone and the bullet may be found in an unexpected situation.

Next to bone, the skin offers the greatest resistance to the penetration of a bullet. A bullet passing through the body may come to rest just underneath the skin on the opposite side.

Preservation and Marking of Exhibits

After the wound has been examined, the skin around the entrance and exit wounds should be cut out

including at least 2.5 cm of the skin around and 5 mm beneath the wound. They should be sealed separately in rectified spirit.

- i. **Bullet:** All bullets and recognizable parts of bullets in the victim must be recovered from the body and preserved with correct labeling of each bullet to the corresponding wound and placed in a separate envelope. Marks due to artefacts such as, scratches should not be produced on the bullet while removing it from the body. Such markings may make subsequent identification of the bullet difficult. It should be removed with fingers or with a forceps protected with rubber tubing. The recovered bullet should be dried and not washed, since washing removes the powder residue.
Description of the bullet should include its:
 - Weight
 - Calibre (diameter of the base)
 - Whether intact, deformed, fragmented or jacketed
- ii. **Pellets:** In a shotgun injury, the forensic pathologist need not recover every pellet. A few pellets and all wadding should be recovered for the ballistic expert to determine the shot size, gauge and type of ammunition. The size of pellets is difficult to measure after the shot is fired, as they become deformed.
- iii. **Fired cartridge cases:** Identification mark should be scratched on the inside of the open end. It should be wrapped in cotton and packed in cardboard boxes.
- iv. **Fired bullets:** Identification marks should be scratched on the base, or just above the riflings on the ogive, but not on the end of the nose, for the nose may pick up trace evidence. It is wrapped in cotton and packed in cardboard box.
- v. **Pellets, slugs and wads:** They may be packed in a cardboard box with cotton, after drying.
- vi. **Clothes:** The area of the powder tattooing should be preserved by fastening a cellophane paper over it and packed in a box.

Collection of evidence from suspect

- i. Clothes with trace evidence.
- ii. Victim's hair, clothing, fibres and blood.
- iii. Gunpowder and other evidence on the hands.
- iv. Unspent ammunition and empty cartridges.
- v. Gun used in the crime.

Medico-legal Questions

Q. Is the injury caused by firearm?

It is recognized by the appearance of clothing, entry and exit wounds, track of bullet and presence of bullet

or pellets and residual matter in the clothing or around the entry wound and in tissues.

Q. From what distance was the shot fired?

The distance can be determined by (Table 12.2):

- Presence or absence of marks of soot, burning, singeing and tattooing on the body of the victim.
- Effect of wads.
- Diameter of dispersion of pellets over the body.
- Muzzle impression.

When the range is greater, the distance can be determined only approximately.

Test firing with the suspect weapon using the same ammunition is useful for estimating the range.

Q. From which direction was the shot fired?

The direction of the firing depends upon the posture of the body at the time of impact.

It can be determined by:

- The position of entrance and exit wounds and the track, bearing in mind the possibility of deflection of bullet and the different relationships of the parts of the body in movement.
- Pattern of dispersion of pellets in case of shotguns, and from abrasion/contusion and grease collars in cases of rifled firearms.
 - Pellets disperse over a wider area as they travel more. Hence, the victim is shot from the side opposite to the side of wider dispersion.
- From the direction of the track of the wound inside the body; useful only in cases of bullet injury, but the track may change on striking against a bone. In a shotgun, individual pellets take divergent routes, which will not help in finding the direction.

Q. What kind of weapon fired the shot?

The kind of weapon can be determined by the size, shape and composition of the bullet and examination of the cartridge, shots and wads left in the body or

Table 12.2: Estimation of range from effects produced by firearms

Effects produced	Shotguns	Handguns	Rifles
Flame	1 ft	2-3"* (5-8 cm)	6-8"
Smoke (soot)	1-3 ft	12" (30 cm)	12"
Tattooing	3-4 ft	18-24" (45-60 cm)	24-30"
Cards	6-7 ft	—	—
Wads	15-20 ft	—	—

* (") Indicates inches

found at the scene of the crime and from the appearance of the wounds.

In case of **shotguns**, appearance of wound is characteristic.

- The wad consists of either plug of paper/cloth or circular discs of felt/cardboard from which the bore of the gun can be determined.
- Stains on the clothes or skin may show whether black or smokeless powder was used.
- Evidence of recent fire can be made by examination of weapon under *mercury vapor*.

The **rifled firearm** leaves its signature on the cartridge case and on the bullet. With all rifled firearms, the bullet is slightly larger than the barrel, and as it passes through the barrel, its sides are marked by the rifling of the barrel (*primary marking/class characteristics*).

• **Class characteristics** are determined by manufacturing specifications, design and dimensions. They are most useful in identifying the make and model of gun involved. Class characteristics in fired bullet identification would be:

- Number, diameter and width of lands and grooves
- Depth of grooves
- Direction and degree of rifling twist

• **Secondary markings or individual/accidental characteristics** are produced on the surface of the bullet by imperfection on the inner surface of the barrel. These irregularities are produced by sticking of particles of the bullet to the bore when shots are fired and is known as *metallic fouling*. They also result accidentally during the manufacturing process, usually microscopic in nature and have random distribution. They are useful in identifying the specific gun which was fired.

- Examination of a fired cartridge may make it possible to identify the weapon in terms of type, make and model.
- Class characteristics may be identical on bullets fired by two different weapons; the individual characteristics will be different.
- Individual characteristics are more pronounced where the grooves score the lead bullet, but for jacketed bullets, the land marking are more pronounced.
- In addition to markings on the bullets, the appearance of the firing pin imprint from centrefire weapons may indicate the make of weapon used (most important identifying mark).
- Bullets recovered from decomposed bodies may show partial or complete loss of individual characteristics depending upon the tissue from which the bullet was recovered and the construction of the bullet.

- The individual characteristics may also be destroyed by rust, corrosion, accumulation of dirt and grease from multiple firings or firing of thousands of rounds of jacketed ammunition.
- The bullet found in the body, known as *crime bullet*, is compared under a *comparison microscope* with one fired from a suspected weapon known as *test bullet*. The suspected weapon is fired using the same brand and type of ammunition into a roll of wool/bag of rags/sand bag/oiled saw-dust/blocks of ice or water tanks. Cleanly shaven, fresh pork skin is ideal for comparison with patterns on human skin.

Q. Is it possible to identify the victim/assailant from a recovered bullet?

- A bullet found at a scene may be linked to the specific individual through which it had passed by examining the tissue deposited on its surface (usually not visible) which can be removed by swabbing and performing DNA fingerprinting by STR analysis. This can be compared to the DNA of the individual (living/dead) through which the bullet is thought to have passed.
- **Fingerprints:** It is usually rare for an identifiable fingerprint to be left on a firearm, especially a handgun. But identifiable fingerprints may be obtained from fired cartridge cases which should be collected from the crime scene.

If a bullet passes through a body or intermediary target or ricochet off a hard surface, fragment of tissue, target or foreign material may adhere to or be imbedded in the bullet which can be identified by histological/cytological examination (for large tissue) and SEM-EDX (for non-organic material and small tissue).

Q. If multiple wounds of entrance and exit are present, could a single bullet have produced them?

Single entrance and multiple exits: If a bullet splits up within the body and divides itself into 3-4 pieces, there will be only one entry and several exit wounds (Fig. 12.21).

Q. If multiple wounds are present, were they produced from the same or different weapons?

This is determined by examination of the wound, bullet(s), cartridge, shots and wad(s).

Q. When was the firearm discharged?

- Smokeless powder leaves a dark gray deposit in the barrel of a recently discharged firearm. It forms a neutral solution with distilled water and contains nitrites and nitrates, but *no sulphates*. The mixture of

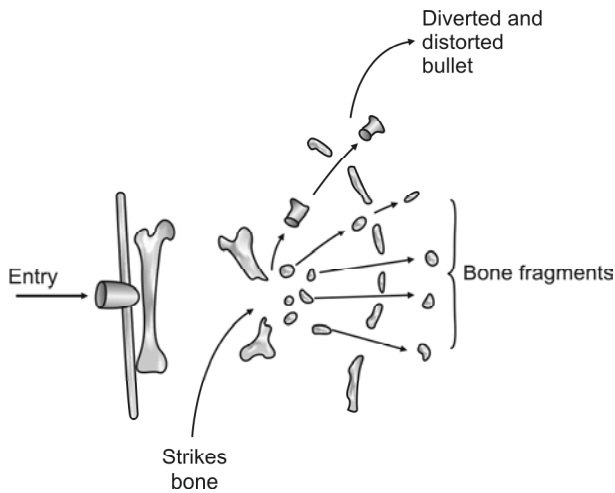

Fig. 12.21: Single entry and multiple exit wounds

gases of explosion has a peculiar smell, which can be noticed for several hours after the discharge of a gun.

- If black powder has been used, H_2S may persist in the barrel for few hours, if breech is closed. Gunpowder washings from barrels are alkaline; contain nitrite, sulphate and thiosulphate.

Detection of Gunshot Residues (GSR)^{22,23}

It is done by:

- Dermal nitrate or paraffin test:** It is an obsolete and non-specific test. It detects GSR (nitrates and nitrites) from the suspect's hand by removing it in a paraffin cast or cotton swab and treating with diphenylamine reagent. A positive test is indicated by blue flecks in the paraffin.
- Harrison and Gilroy test:** It is a qualitative calorimetric chemical test and not specific for firearm discharges residues, but detects the presence of antimony, barium and lead.

A cotton swab moistened with HCl is used to swab the hand and then treated with triphenylmethylarsonium iodide for detection of antimony, and sodium rhodizonate for the detection of barium and lead.

- Neutron activation analysis:** This chemical method is useful in identifying minute traces of elements present in the hair, nails, soil, glass pieces, paints, GSR and drugs. It is based on the detection and measurement of characteristic radioisotopes formed by irradiation in a nuclear reactor. Antimony and copper residues (from the primer) are detected from the suspect's hand.

- Atomic absorption spectroscopy (AAS) and Flameless atomic absorption spectrophotometry (FAAS):** This analytical method utilizes high temperatures to vaporize the metallic elements of the primer residues, to detect and quantify them. Measuring the antimony, barium and lead from the primer and copper vaporized from either the cartridge case or the bullet jacketing helps in determining:

- Holes in clothing and tissues as bullet holes
- Range of fire
- Common origin of bullet fragments or shotgun pellets found at different places
- Whether or not a person has fired a gun

- Scanning electron microscope-energy dispersive X-ray spectrometry (SEM-EDX):** It is the *most sophisticated tool* which can detect minute traces of GSR found on the body of suspect. It is a qualitative, not a quantitative analysis.

Clothing may be tested for presence of GSR²⁴

- **Modified Greiss test** is specific for nitrites. It uses chemicals (alpha-naphthol) to produce visual display of GSR pattern and density of particles.
- **Sodium rhodizonate reaction** detects lead from primer or bullet wipe.
- **Energy dispersive X-ray (EDX)** detects barium, antimony, lead and copper around the entry wound in clothing. It can be used to determine the range of fire.

Q. How long did the victim survive after the injury?

- It depends on the cause of death, i.e. whether from shock and hemorrhage, injury to a vital organ or septic complications.
- An individual can function without a heart for a short time. The limiting factor for consciousness is the O_2 supply to the brain. When the O_2 in the brain is consumed, unconsciousness occurs.

Q. How much activity could the victim perform following the injury?

This varies considerably depending on the site of injury and the organ involved (Refer to Chapter 11 also).

- If the injury involves the motor area of brain, brainstem, basal ganglia, medulla or cervical cord or there is laceration of the heart or aorta, the victim becomes incapacitated immediately. Sometimes, through-and-through bullet wounds of the brain (frontal lobes) or heart do not cause immediate disability, if they involve non-vital regions and the person may be able to carry out voluntary acts.

- In order of fatality, wounds of the auricles are most rapidly fatal, followed by wounds of the right ventricle and then the left ventricle.
- The amount and rapidity of blood loss will also help to form an opinion about the extent of physical activity possible.
- In injury to other parts of the body, the victim may be able to walk about.

Q. Is it a case of suicide, accident or homicide?

- The differentiating features are tabulated in Diff. 12.2.
- Most contact shotgun wounds of the head are suicidal in origin. The individual tends to use his dominant hand to press the trigger, steadying the muzzle against the head with the non-dominant hand. So, powder soot may be visible on the non-dominant hand.

For suicides, the sites of preference are (in decreasing order of occurrence) (Fig. 12.22):

- Temple (60% of cases)
- Centre of forehead
- Roof of mouth
- Midline behind the chin
- Left side or front of chest (precordium)

A suicider using a revolver or pistol usually shoots himself in the right temple region, the bullet passing almost horizontally or upwards and backwards through the head, and making its exit in the left parietal region. If the individual is left handed, left temporal region is selected.

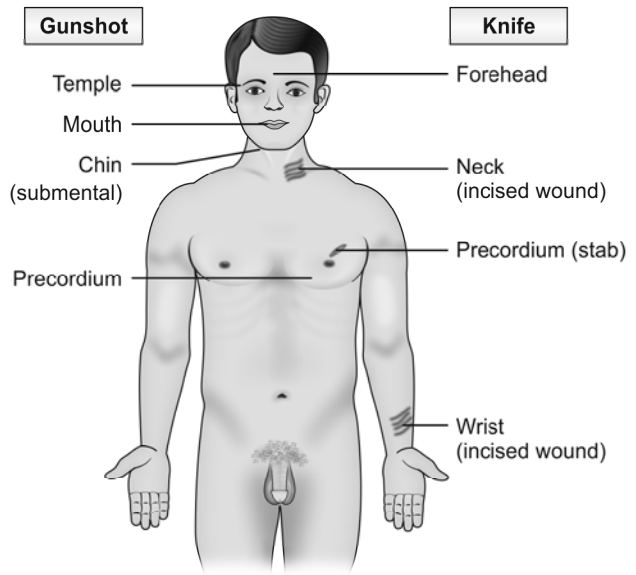

Fig. 12.22: Sites of election in suicide with firearm and knife

Q. Can there be multiple wounds of entry and exit from a single shot?

Yes, it may be seen in re-entry wounds where the bullet passes through one part of the body and then re-enters another part. For example, a bullet may pass through:

- an arm and the chest, so that four wounds would result (most common).

Differentiation 12.2: Suicidal, accidental and homicidal firearm injury

S.No.	Feature	Suicide	Accident	Homicide
1.	Site of entry wound	Head or heart	Any area	Any area
2.	Shot distance	Contact or very close range	Close or very close	Any range, usually distant
3.	Direction	Upward or backward	Any direction	Usually upward
4.	Number of wounds	Usually one	One	Any number
5.	Powder residue on hand pressing trigger	Present	Present	Absent
6.	Cadaveric spasm	May be seen with the weapon firmly grasped	Not so	Not so
7.	Weapon at scene	Found	Found	Not found
8.	Scene	Usually his house	In his house or while hunting/handling	Any place, evidence of struggle
9.	Sex	Usually males	Usually males	Any sex
10.	Motive	Insanity, illness, financial loss	Nil	Gang feuds, robbery, revenge

- the chest or abdomen and thigh and lower leg, producing six wounds. This occurs when the person is running or sitting in an unusual position (thigh and leg flexed).

Q. Is it possible that entry wound is present but the bullet is not found in the body?

It may occur when the bullet entering the:

- Stomach, may be vomited out.
- Windpipe, may be coughed up.
- Mouth, may be spat out.
- Body and coming in contact with the bone, and exiting by the same wound from where it entered.

Notes

- Bullet emboli:** Vascular embolization is usually associated with small calibre, low velocity bullet and usually involves the arterial system. It should be suspected whenever there is a penetrating bullet wound with failure to discover the bullet in the expected region or to visualize the bullet on routine X-ray. The most common sites of entry for a bullet are the aorta, heart and the inferior vena cava.
- Lead snowstorm:** This is seen in radiograph of an individual shot with centrefire ammunition. Fragments of lead break off the lead core as the bullet moves through the body and gets lodged into surrounding tissue. X-ray shows small radiopaque bullet fragments scattered along the wound track—'lead snowstorm'. A rifle bullet need not have to hit bone for this phenomenon to occur.

MULTIPLE CHOICE QUESTIONS

1. Empty cartridge case is ejected after firing in:

AIIMS 03, 04

- A. Shotgun B. Revolver
C. Pistol D. Rifle

2. Calibre of a rifled gun is calculated: DNB 09; TN 11

- A. Distance between a land and groove
B. Distance between two diagonally opposite lands
C. Distance between two diagonally opposite grooves
D. Number of spherical lead balls that can be made from one pound of lead

3. Spherical lead balls that can be made from one pound of lead for a 12-bore shotgun: Manipal 09

- A. 6 B. 8
C. 12 D. 24

4. Number of bullets fired in a tandem bullet:

AIIMS 07

- A. 1 B. 2
C. 3 D. 4

5. Bullet that fragments on impact is called: Kerala 06

- A. Duplex bullet B. Dum-dum bullet
C. Frangible bullet D. Soft-point bullet

6. Bullet that leaves a visible mark in its flight so that person can see the path is: AI 10

- A. Tandem bullet B. Tracer bullet
C. Dum-dum bullet D. Incendiary bullet

7. Use of wadding in a smooth bore gun are all, except: UP 04

- A. Seals the bore effectively
B. Helps in lubrication

- C. Allows optimum pressure to develop
D. Causes fatal injuries

8. Black gunpowder contains all of the following, except: PGI 03, 06; Punjab 09

- A. Potassium nitrate B. Lead peroxide
C. Charcoal D. Sulphur

9. Smokeless gunpowder is composed of: Delhi 05, 07

- A. KMnO_4 B. HCN
C. Nitrocellulose D. Sulphur

10. One gram of smokeless gunpowder produces:

Karnataka 11

- A. 3000-4000 cc of gas
B. 9000-10,000 cc of gas
C. 12,000-13,000 cc of gas
D. 15,000-16,000 cc of gas

11. FG, FFG, FFFG is used to indicate: PGI 08, 11

- A. Cartridge B. Black powder size
C. Base of gun D. Wadding of cartridge

12. Brain of cartridge is: UP 04

- A. Black powder B. Smokeless powder
C. Primer D. Projectile

13. Damage produced by a bullet is in direct proportion to its: AIIMS 09

- A. Size B. Shape
C. Velocity D. Weight

14. The capacity of a bullet to cause maximum destruction lies in its: AIIMS 10

- A. Size B. Shape
C. Weight D. Velocity

1. C 2. B 3. C 4. B 5. C 6. B 7. D 8. B 9. C
10. C 11. B 12. C 13. D 14. D

15. In a firearm injury, blackening seen around the entry wound is due to: *DNB 09*
 A. Flame B. Smoke
 C. Unburnt powder D. Hot gases
16. Stellate wound is produced with firearm in: *TN 03; AI 09*
 A. Contact shot
 B. Close shot
 C. Range within 60 cm
 D. Distant shot
17. Contact wound shows: *AP 06*
 A. Cruciate splitting B. Tattooing
 C. Singeing of hair D. Abrasion collar
18. In firearm entry wound, arrangement of abrasion collar, dirt collar and tattooing from inside to outside: *NIMS 11*
 A. Dirt collar, abrasion collar, tattooing
 B. Abrasion collar, dirt collar, tattooing
 C. Tattooing, dirt collar, abrasion collar
 D. Dirt collar, tattooing, abrasion collar
19. In a firearm injury, there is burning, blackening, tattooing around the wound, and is circular in shape, the injury is: *AI 05*
 A. Close shot entry B. Close contact exit
 C. Contact shot entry D. Distant shot entry
20. Gunshot injury in the skull, following are features, except: *UP 04*
 A. Entrance wound is beveled in the inner table
 B. Entrance wound is beveled in the outer table
 C. Exit wound is beveled in the outer table
 D. Exit wound is clean cut in the inner table
21. Which of the following may be seen in the exit wound: *DNB 10*
 A. Dirt collar B. Abrasion collar
 C. Tattooing D. Inverted edges
22. Gunshot residue on hands can be detected by: *AIIMS 05; DNB 10*
 A. Phenolphthalein test
 B. Dermal nitrate test
 C. Benzidine test
 D. H₂ activation test
23. Detection of metals (heavy) is done by using all, except: *PGI 04*
 A. Harrison-Gilroy test
 B. Atomic absorption spectroscopy
 C. Neutron activation test
 D. Paraffin test
24. Gunpowder on clothing can be visualized by: *AI 11*
 A. Magnifying lens B. UV rays
 C. Infrared rays D. Energy dispersive X-ray

Definitions

- **Traumatic brain injury (TBI):** Traumatically induced structural injury and/or physiological disruption of brain function as a result of an external force.
- **Closed head injury (non-penetrating):** Damage to the brain without any fracture of the skull and/or penetration of dura; most often results from blunt trauma.
- **Open head injury (penetrating):** Disruption of cranial vault with opening through skin and cranial bones to expose damaged brain; most often associated missile wounds, stab/chop wounds and motor vehicle or occupational accidents.
- **Missile injury:** Injury produced by moving object striking cranium; most often refers to bullet injury.
- **Acceleration/deceleration injury:** Damage produced by movement of brain within confines of cranial vault (tearing during violent movement or from impact of striking interior of skull or dural folds).

Craniocerebral Injuries

- There are three main components of the head: scalp, skull and brain (Fig. 13.1).
- The term 'craniocerebral injuries' can be used to describe the presence of skull ('cranio') and brain ('cerebral') injury.

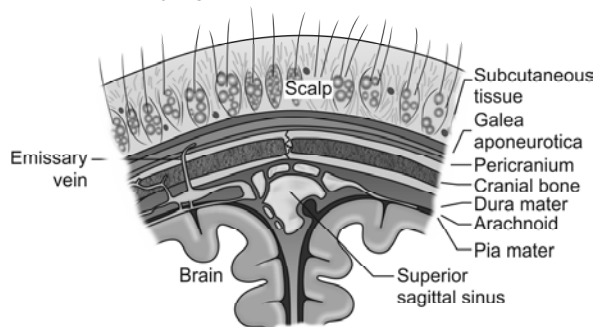

Fig. 13.1: Cross section of the scalp, skull and meninges

- Craniocerebral injuries to the head can be grouped into two types: 'focal' or 'diffuse' in the sense that they are localized or widespread (Table 13.1).

Soft Tissue Injury

- **Injuries:** Scalp wounds are caused by falls, blows, sharp cutting instruments or discharge of a firearm. It can be:
 - **Contusions:** Presence of scalp contusion is indicative of contact injury. In superficial fascia, they appear as localized swelling due to the dense fibro fatty tissues, but contusions deep into the galea aponeurotica are diffuse on account of loose aponeurotic tissues and difficult to make out on examination.
 - The easiest way to detect scalp injuries is by palpation, but shaving is necessary for proper documentation and photography.
 - During postmortem examination, autopsy surgeons are able to visualize this subscalpular (subgaleal) hemorrhage after reflection of the scalp.
 - **Lacerations:** They resemble incised wounds (incised looking lacerations). Careful examination in the depths of the wound will reveal the bridging fibres with surrounding band of abrasion.
 - **Incised wounds:** They have clean cut margins; hair bulbs are cleanly cut.
- An effusion of blood over the top of the head or forehead may gravitate down to the loose tissues causing *black eyes* (*periorbital hematoma*).

Table 13.1: Classification of craniocerebral injury

Focal	Diffuse
• Scalp lacerations	• Axonal injury (DAI)
• Skull fractures	• Ischemic injury
• Contusions/lacerations	• Vascular injury
• Intracranial hemorrhage	• Brain swelling
• Lesions secondary to raised intracranial pressure	

Causes of black eyes (also called *spectacle hematoma* or *raccoon eyes*) (Fig. 13.2)

- i. Most commonly due to *local violence* causing subcutaneous extravasation of blood into the lids, occurs soon after injury to upper and lower eyelids.
 - ii. Bleeding into the layer of loose connective tissue after a *blow on the skull*; the blood gravitates under the frontalis muscle and appears first in the upper eyelid and then the lower eyelid over the course of a couple of days.
 - iii. *Fracture of the orbital plate of the frontal bone* results in hemorrhage into the orbit, the blood tracks under the conjunctiva, appearing as a triangular, flame-shaped hemorrhage, the apex of which is at the margin of the cornea and the posterior limit cannot be seen, which distinguishes it from the subconjunctival hemorrhage.
- Wounds of the scalp bleed freely (blood vessels in the fibrous layer, superficial to galea aponeurotica, being held open once cut), but heal rapidly. If an injury extending through the galea gets infected, it may spread through the emissary veins to involve the sagittal, lateral and cavernous sinuses causing septic complications, like meningitis and brain abscess.
 - The soft fluctuant centres of scalp hematomas can masquerade as *depressed skull fractures* (Diff. 13.1).

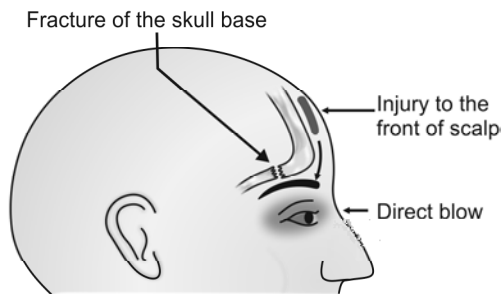

Fig. 13.2: Causes of black eyes

Skull Fractures

Motor vehicle accidents and falls are the most common causes of skull fractures.

Mechanism: The skull is not a completely rigid structure and it is able to bend and distort when force is applied to it. A blow to the skull causes '*inbending*' of the bone at the site of impact, and asymmetric and variably localized '*outbending*' at a distance from the impact. If the forces applied exceed the elastic properties the skull, fractures will occur.

- In general, if force is applied over a small area (e.g. a blow from a weapon) a fracture occurs at the site of inbending, whereas an impact over a larger skull area leads to fractures at the site of outbending.
- Fractures also represent the point of maximum stress upon the skull, which may not be at the immediate site of impact.
- Skulls of infants and children are thinner than those of adults and may be able to distort more before fracturing.
- The fracture of skull can occur either by direct or indirect violence.
 - i. **Direct violence:** The forces act directly on the bone to produce a fracture, e.g. head crushed under wheels in road traffic accidents or an object like stick/rod/bullet striking the head.
 - ii. **Indirect violence:** The forces act indirectly on the skull through some other structure, which receives primary impact, e.g. fall on buttocks from height which transmits the force to occipital bone through vertebral column or a blow to the chin resulting in fracture of base of the skull.

During autopsy, prior to cutting the skull cap off, the skull should be visually inspected and palpated for the presence of fractures.

Types (Fig. 13.3)¹

1. **Fissure/linear fractures:** These are linear cracks passing over the vertex or across the skull base without any displacement of the fragments, and

Differentiation 13.1: Hematoma and depressed skull fracture

S.No.	Feature	Hematoma	Depressed skull fracture
1.	Relation with skull surface	Raised above the surface	At or below the level of skull surface
2.	On pressure	Will pit	Will not pit
3.	Pulsation	May have pulsation, if any artery is involved	No arterial pulsation felt
4.	Shape	Circular in shape and movable over skull surface	Margins sharper, more irregular, less evenly circular

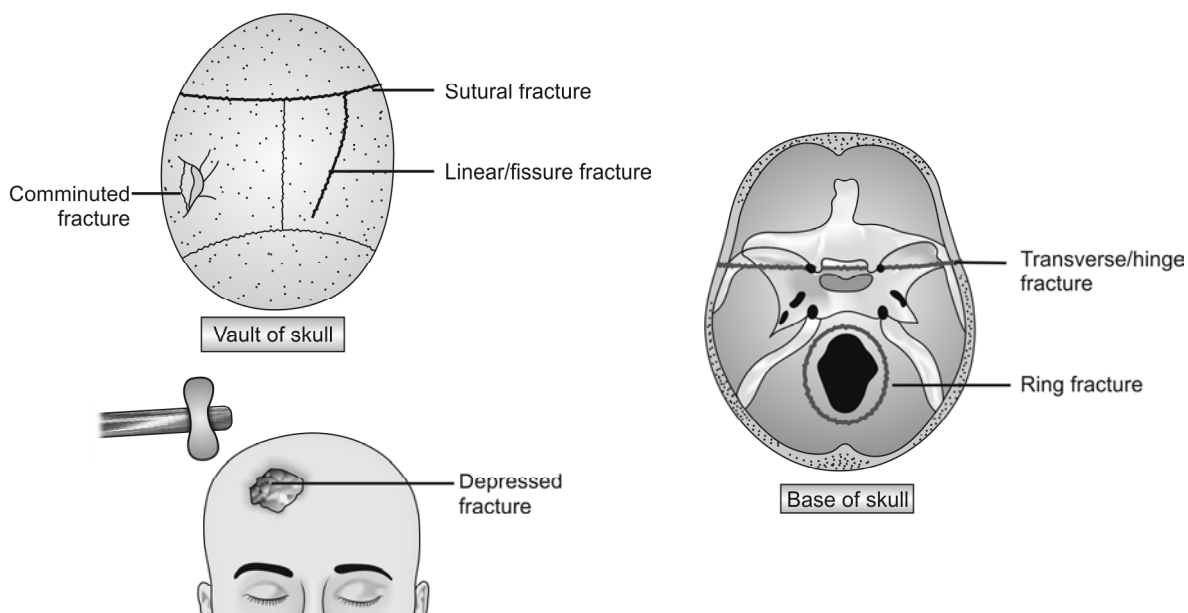

Fig. 13.3: Types of skull fractures

- either involves the whole thickness of the bone or the inner or outer table alone.
- These fractures are usually caused by:
 - i. Forcible impact against a broad resisting surface, like hard ground surface, as in road traffic accidents.
 - ii. When knocked to the ground by the blow of a fist.
 - iii. Blows with a hard blunt object having a relatively broad striking surface.
- The fracture line tends to follow an irregular course and is no more than a hair's breadth.
- They are difficult to detect, may not be seen on X-ray and can only be detected at autopsy.
- The line of fracture runs parallel with the axis of compression.
- Depression of bone fragments is not seen.
- An injury of the head sustained by a fall is mostly situated at the level of the margin of the hat, while an injury due to blow is commonly situated above this level.
- 2. **Depressed fracture:** When a portion of fractured bone is driven inwards it is known as depressed fracture. It is also called '*fracture a la signature*' (**signature fracture**), as the shape often points towards the shape of the offending weapon.²
- They are caused by blows with a heavy weapon having small striking surface, such as hammer, axe, brick or chopper.³
- The part of the skull which is first struck shows maximum depression; usually seen in the left frontal region.
- This type of fracture often suggests the probable manner of application of violence and also the relative position of the victim and the assailant at that moment.
- Depressed fracture is considered to be compound if an associated scalp laceration extending through the pericranium is present, and penetrating if a dural laceration exits.
- The risk of post-traumatic epilepsy following depressed skull fracture and cortical laceration is about 15%.
Some variants:
- i. **Elevated fracture:** One end of fractured fragment is elevated above the surface of skull, while the other end may dip down into cranial cavity resulting in injury to the brain.
 - It is caused by a blow from sharp, heavy object (e.g. an axe) which elevates the skull fracture by lateral pull of the weapon while retrieving it.
 - These fractures are rare, and are usually associated with injury to the dura also.
- ii. **Pond or indented fracture:** This is a smooth concave depression without a fracture line resulting from in-buckling of skull, occurring only in the elastic skull of infants and children (prior to 4 years of age).⁴

- Inner table is not fractured, meninges and brain are not damaged.
 - It may also be caused by forcible compression with an obstetric forceps or impact against some protruding objects, e.g. sacral promontory.
 - It is also known as *ping-pong fracture*, as it looks similar to a dent in ping-pong ball.
3. **Comminuted fracture (spider-web/mosaic fracture):** Two or more intersecting lines of fracture divide the bone into three or more fragments.
 - Skull bone gets broken into multiple pieces by fracture lines, which are haphazardly or concentrically arranged, or stellate if they radiate from the site of impact.
 - It is caused by vehicular accidents, fall from height on a hard surface or by blows with weapons having large striking surface, such as heavy iron bar, or from a bullet.
 - Comminuted fractures may be a complication of fissure fracture and the fragments of bone if displaced inward, form a depressed skull fracture.
 4. **Gutter fracture:** It is formed when part of the thickness of the bone is removed so as to form a gutter, e.g. oblique bullet wounds.⁴ It is usually accompanied by comminuted depressed fracture of the inner table of skull and the fragments causing injury to the meninges and brain.
 5. **Ring fracture:** This is a type of fissure fracture that encircles the base of skull around the foramen magnum, running from the sella turcica, partly through petrous ridges and then going posteriorly and medially, joining in the posterior fossa. In the front, the fracture may pass through the middle ear and roof of the nose. As a result, the skull gets separated from the spine. These fractures do not occur commonly.

Seen in:

 - Fall from a height on feet or buttocks, when the force of the fall is transmitted upwards through the spinal column.
 - Vault of skull being driven against vertebral column by fall of heavy load or by a heavy blow over the vertex.
 - Violent twisting of the head on the spine, shearing the vault from base.
 - Heavy blow directed underneath the occiput or chin.
 6. **Diastasis or sutural fracture:** Usually occurs in young children following a forcible blow on the head with a heavy hard blunt object where the fracture line passes through the sutures. It occurs alone, but is often associated with fissure fracture.
 7. **Contre-coup fracture:** Occurs exactly opposite to the site of primary impact or 'coup violence'. This is due to shear strain.
 - It is usually seen in the anterior cranial fossa involving the bones of the orbital or ethmoid plates with associated periorbital hematoma.
 - They occur after an occipital, parietal or temporal impact along with fracture at the site of impact.
 8. **Blow-out fracture:** This is due to blunt trauma to the eye wherein the forces are transmitted via the globe to the bony orbit, causing disruption of the orbital walls.

Teardrop sign: The fracture is most commonly involves the thin medial wall and/or orbital floor that results in orbital contents such as periorbital fat and inferior rectus muscle herniate downwards into the maxillary sinus resulting in pain, restricted eye movements and diplopia.^{5,6} Radiographically, a soft tissue 'teardrop' or polypoid mass in the roof of the maxillary antrum may be seen.
 9. **Basilar fracture:** The base of the skull is weak and hence any diffuse impact to the vertex of the skull will produce basilar fracture. These fractures may be missed on X-ray examination.
 - *Fracture of anterior cranial fossa:* Usually due to direct impact, although fissure fractures in orbital or cribriform plate may be due to contre-coup injury. The patient presents with epistaxis, CSF rhinorrhea, (at times from mouth), anosmia, nasal tip parasthesiae, black eye and occasionally carotico-cavernous fistula.⁷⁻¹⁰
 - *Fracture of middle cranial fossa:* It is seen due to direct impact behind the ear or crush injuries of the head. It manifests by CSF otorrhea (or rhinorrhea via Eustachian tube) if petrous part of temporal bone is fractured, hemotympanum, ossicular disruption, Battle sign or VII and VIII nerve palsy.¹¹
 - *Fracture of posterior cranial fossa:* It is commonly due to direct impact of the back of the head on the ground and clinically diagnosed by escape of blood and CSF through the mouth.
 10. **Hinge/transverse fracture:** Fracture of the base of skull occurs that completely splits it, creating a hinge (*'nodding face' sign*); frequently occurs with side impacts. Most common form is the one which

extends from the petrous bony ridge through sella turcica to lateral end of the contralateral petrous ridge.

- **Compound skull fracture:** Laceration of scalp associated with skull fracture.
- **Growing skull fracture:** Expanding linear fracture (usually in young children) associated with dural tear allowing leptomeninges to herniated into fracture site and expand with cerebrospinal fluid pressure.
- **Halo or ring sign:** Blood from head injured patients may mix with CSF and mask the recognition of a leak. CSF will separate from blood when the mixture is placed on filter paper resulting in a central area of blood with an outer ring or halo.¹²
- **Glucose estimation:** CSF has a greater concentration of glucose than mucus or lacrimal secretions. The quantitative determination of a glucose level in nasal fluid not contaminated by blood can be diagnostic of CSF rhinorrhea, if the nasal fluid contains > 30 mg/dl.^{10,12}
- **Immunoelectrophoretic identification:** β -2-transferrin assay is the most widely used test and is considered the standard criterion for diagnosis of CSF rhinorrhea.^{12,13}
- **Battle's sign:** Bruising behind the ear appearing 36 h after head injury; may be confused with retro-auricular scalp bruise (Fig. 13.4).¹⁴
- With basilar fracture, intracranial passage of a nasogastric tube or nasopharyngeal airway can happen. These fractures may be visible on plain radiographs or on bone window axial CT scans, but confirmed radiologically by pneumocranium or air-fluid levels in the sinuses.



Fig. 13.4: Battle's sign: blood in soft tissue over mastoid

Complications of Skull Fractures

- Injury to the brain** which may be dangerous to life.
- Hemorrhage:** If middle meningeal artery is ruptured, fatal hemorrhage may occur.
- Infections:** It may be direct spread from compound fracture or spread from fracture of paranasal sinuses, like frontal or ethmoidal.
- Traumatic epilepsy:** More common with open head injuries. Usually seen 1-2 years after the episode and manifests as tonic or clonic fits.

Coup and Contre-coup Injury

Coup injury is one which occurs immediately beneath the area of impact and results directly by the impacting force. Smaller the impact area, greater is the likelihood of a coup injury. Effects are immediate, resulting in contusion and hemorrhage.

For example, if the head is fixed (person standing still) and there is violent impact over the frontal bone, fracture and underlying brain damage will be located beneath the site of impact (Fig. 13.5).

Contre-coup injury (French *contre*: opposite, *coup*: blow) means that the lesion is present in the brain opposite to the site of impact. It is caused when the moving head is suddenly decelerated by hitting a firm surface, e.g. striking of the head on the ground during a fall, usually seen in road traffic accidents. The sudden arrest of the head results in injury to the brain, which is still in motion, striking the arrested skull.

Mechanism: Occurs due to local distortion of the skull and sudden rotation of the head resulting from the blow, which causes shear strain by pulling apart of the constituent of the brain.

For example, when a person falls with his occiput striking the ground, he may sustain injury at the occipital lobes (coup injury) and a more prominent injury to the frontal lobes (contre-coup injury) (Fig. 13.5).

- It can occur only when the head is free to move.
- It occurs most frequently in temporal lobes and frontal lobes (especially the orbital surface).
- It is rare before the age of 3 years.

Contre-coup injuries are due to various factors

- An impact causes a cavity or vacuum in the cranial cavity on the opposite side as the brain lags behind the moving skull. The vacuum exerts a 'suction effect' which damages the brain.
- A blow which produces inbending of the bone displaces the brain to the opposite side causing it to strike against the skull.

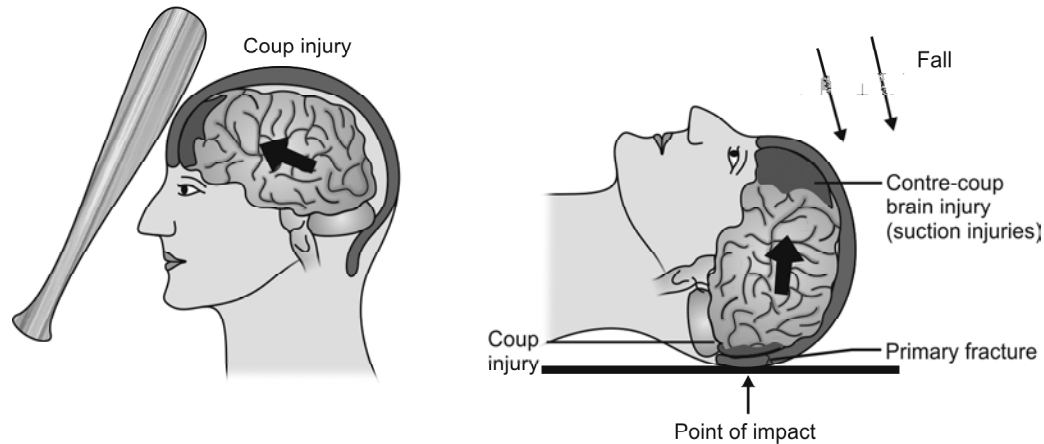

Fig. 13.5: Mechanism of coup and contre-coup injury of the brain

Medico-legal Importance

On the basis of localization of injuries, it is possible to conclude if they resulted from a fall or from blows.

- With *blows (assault)*, brain shows much larger contusions underlying the area of impact (coup) than on the site opposite to impact (contre-coup). Contre-coup lesions are rare.
- But, in head injuries caused by *falls* (e.g. road traffic accidents), the contre-coup injuries are usually located in inaccessible portions and are larger than the coup contusions. Coup lesions may be absent or minimal.

Brain Injury (Flow chart 13.1)

- Traumatic brain injury (TBI) is usually caused by motor vehicle accidents, falls and assaults.
- TBI can be classified based on severity (mild, moderate or severe, Table 13.2) mechanism (missile or blunt) and pathology (primary or secondary, Flow chart 13.1).

Flow chart 13.1: Classification of brain injury

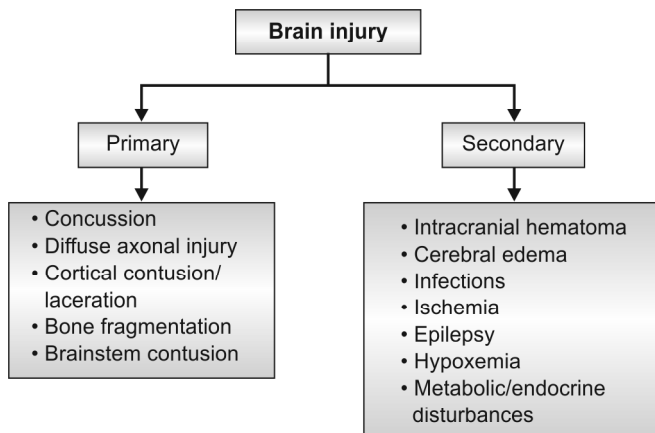

- **Primary brain injury** is the injury caused at the time of impact (e.g. contusion, laceration).¹⁶
- **Secondary brain injury** is brain damage arising from events developing subsequent to primary injury.
 - Some secondary injuries occur almost instantaneously (e.g. hemorrhage as a consequence of tearing of tissue), whereas others evolve over hours to days (e.g. delayed hemorrhage, inflammation, brain swelling, and axonal swelling secondary to paralysis of axonal transport or tearing of axons).¹⁷

Cerebral Concussion

Concussion (Latin *concutere*: to shake): Physiological disruption of brain function as a result of a traumatic event which is manifested by at least one of the following: alteration of mental state, loss of memory or focal neurological deficit, that may or may not be transient.

- Concussion, also known as mild traumatic brain injury is a clinical diagnosis (Table 13.2).
- It results from acceleration/deceleration of the head.
- Violent head movement causes shearing or stretching of nerve fibres and axonal damage.¹⁸
- It may resemble drunkenness (Diff. 13.2).
- Concussion is common among most contact and collision sports participants. Football players and boxers are particularly exposed to repetitive concussions, leading to the condition known as *chronic traumatic encephalopathy syndrome*.

Signs and Symptoms

Unconsciousness, bradycardia, hypotension and sweating, and is always followed by retrograde or post-traumatic (antegrade) amnesia, temporary lethargy,

Table 13.2: Severity of brain injury stratification¹⁵

Criteria	Mild/concussion	Moderate	Severe
Structural imaging	Normal	Normal or abnormal	Normal or abnormal
Loss of consciousness	0-30 min	> 30 min and < 24 h	> 24 h
Alteration of consciousness /mental state	A moment upto 24 h	> 24 h	Severity based on other criteria
Posttraumatic amnesia	≤ 1 day	> 1 and < 7 days	> 7 days
Glasgow Coma Scale (best available score in first 24 h)	13-15	9-12	3-8

Differentiation 13.2: Drunkenness and concussion

S.No.	Feature	Drunkenness	Concussion
1.	Skin	Flushed, congested and warm	Pale, cold and sweating
2.	Pulse	Rapid and bounding	Slow and feeble
3.	Pupils	Dilated; contracted in coma	Contracted in pontine hemorrhage
4.	Light reflex	Sluggish	May be brisk
5.	Respiration	Sighs, puffs, eructates	Shallow, irregular, slow
6.	Memory	Confused, disoriented	Retrograde amnesia, unrelieved by time
7.	Behavior	Uncooperative, abusive, talkative, sulky	Quiet and retracted, curled up in bed, photophobia
8.	Urine/blood	Examination will be helpful	Retention of urine, urine may contain albumin
9.	History	History of having consumed alcohol, smell of alcohol	History of head injury with features of concussion

irritability and cognitive dysfunction.¹⁹ Muscles are flaccid, pupils are dilated and unreacting, pulse is weak and slow, and respiration is shallow.

Severity of concussion: It is given in Table 13.3.

Findings: Gross and light microscopic changes in the brain are usually absent, but biochemical and ultrastructural changes—mitochondrial ATP depletion, local disruption of blood-brain barrier occur. CT and MRI scans are usually normal.

- **Post-concussion syndrome:** Seen in patients who returned to work too early after head injury. It consists of headache, vertigo, lassitude, irritability and depression which may persist for months.
- **Post-traumatic automatism:** It is intimately associated with amnesia. After an accident, the patient may speak and act in a purposive manner, but does not remember anything later on.
- **Anterograde amnesia:** Loss of memory subsequent to the event that caused the amnesia.
- **Retrograde amnesia:** Loss of memory preceding the event.
- **Punch drunk syndrome (dementia pugilistica or boxer's encephalopathy):** A condition occurring late in boxer's

career or years after retirement which is the cumulative result of recurrent cerebral concussions.

Signs and symptoms: There may be deterioration of speed and reflexes and incoordination along with personality change associated with social instability and sometimes paranoia and delusions. Later, memory loss progresses to full dementia, often associated with Parkinsonian signs, ataxia or intention tremors, shuffling, broad based gait and dysarthria.

Autopsy: Chronic SDH, attenuation of corpus callosum, DAI and cortical atrophy may be seen.

There are four forms of diffuse TBI: axonal injury, vascular injury, hypoxic ischemic encephalopathy and brain swelling. These categories overlap and they are often accompanied by various forms of focal TBI.

Diffuse Axonal Injury (DAI)

Diffuse axonal injury (DAI) is a clinicopathological condition representing a spectrum of severity in which the victim is unconscious from the time of injury and then either remains in a coma or enters a persistent vegetative state.

Table 13.3: Concussion grading scale

Grade 1	Grade 2	Grade 3
Transient confusion	Transient confusion	---
No loss of consciousness	No loss of consciousness	Brief or prolonged loss of consciousness
Concussion symptoms or mental status change resolves in ≤ 15 min	Concussion symptoms or mental status change resolves in > 15 min	---

- In severe cases, patients may expire depending on the severity of concurrent secondary injury.
- DAI is a clinical syndrome with supporting neuroradiological changes.
- It results from relative movement (shearing) at the gray-white matter interface following sudden rotational and acceleration/deceleration forces which cause disruption and tearing of axons, myelin sheaths and blood capillaries.^{20,21} With concussions, the axonal damage is considered as reversible; however, when sufficient vital axons are severely injured then death can occur.
- Ninety percent of cases are due to road traffic accidents and 10% due to falls and assaults.

Severity of DAI is given in Table 13.4.

Autopsy Findings

- Contact injuries to the scalp and skull may be absent.
- Thin subarachnoid hemorrhage may be seen.
- Brain:** Cut sections may be normal to the naked eye or there may be petechial hemorrhages in the corpus callosum, focal lesions in the dorsolateral aspect of the rostral brainstem in the vicinity of the superior and middle cerebellar peduncles. Gliding contusions are common, and hemorrhages in the thalamus and basal ganglia are frequent.

Diagnosis

- *CT scan:* Characteristic CT findings may be absent but in severe DAI focal lesions are seen as petechial hemorrhages in the corpus callosum, cerebellar peduncle and evidence of diffuse injury to axons.²²

Table 13.4: Grading of diffuse axonal injury (DAI)

Severity	Axonal injury	Hemorrhage in corpus callosum	Lesions in cerebellar peduncle
Grade I	Present	Absent	Absent
Grade II	Present	Present	Absent
Grade III	Present	Present	Present

- *MRI* with its high sensitivity for parenchymal injury, DAI is diagnosed in patients with non-hemorrhagic areas of T2 signal within the white matter or at the gray-white junction.
- *Histologically*, it is diagnosed by demonstrating numerous axonal swellings ('retraction balls/bulbs') in the internal capsule, corpus callosum and superior cerebellar peduncle (Fig. 13.6).²³ They can be seen as eosinophilic-pink swellings on H&E stained sections and can be also detected by silver stains, but a survival of 15-18 h is required before they can be identified using this technique.
- *Immunohistochemistry* is the most sensitive technique, and currently immunostaining for β -amyloid precursor protein (BAPP) has proven to be a sensitive and specific method of detecting axonal swellings.

Cerebral Contusion and Laceration

Definition: Areas of hemorrhagic disruption (tearing lesions) of the CNS that are superficially located in the brain are called *contusions* if the pia mater is intact, and *lacerations* if the pia is torn.

Location: Contusions occur usually in the frontal and temporal poles and on the inferior surfaces of the frontal (orbital gyri) and temporal lobes, and the cortex above and below the Sylvian fissure.

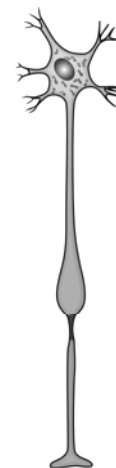

Fig. 13.6: Axonal swelling/ballooning

- Typically it involve the crests of gyri and often involve the gray matter only; may extend into underlying white matter and form a hematoma.
- In severe cases, extensive laceration with underlying parenchymal hemorrhage may be associated with subdural hemorrhage, forming a so-called *burst lobe*—often seen in the temporal lobes.

Pathogenesis: Contusions are the sites where the brain tissue comes in contact with the bony protuberances and dural coverings, sites of forcible separation of the brain from the dura, and sites of differential movement between the brain and dura and between adjacent areas of the brain.

- Contusion produces focal neurological deficits that persist for > 24 h. Since the damage is focal, patients may recover uneventfully, provided that they did not develop complications leading to other types of brain damage and did not sustain DAI at the time of injury.
- Intoxication by alcohol is associated with unduly large contusions as they tend to fall more heavily because of their blunted protective locomotor reflexes. Moreover, associated liver disease and acute alcohol intoxication hinder hemostasis.

Types: There are several types of brain contusions based on location and/or mechanism of injury:

- Coup contusion:** Occurs at the site of impact due to inbending bone rebounding and injuring the brain. They have a wedge-shaped appearance whose base is at the pial surface and the tip pointing towards the white matter.
- Contre-coup contusion:** It is associated with falls and occurs at a site diametrically opposite to the point of impact. It is due to the brain rebounding backward from the skull following impact. It is seen most commonly in the frontal (orbital gyri) and temporal lobes (Fig. 13.7).
- Fracture contusion:** Related to fractures of the skull and bears no relation with the point of impact.
- Intermediary coup contusion:** Present in deeper structures of the brain, like white matter or basal ganglia. It is present along the line of impact between coup and contrecoup points.
- Gliding contusion:** Usually associated with DAI and independent of site and direction of impact. It is a focal hemorrhage in the cortex and underlying white matter of the dorsal surface of cerebrum, particularly the frontal region. It is seen in falls and road traffic accidents.
- Herniation contusion:** It is due to the impact of medial side of temporal lobe with the edge of the

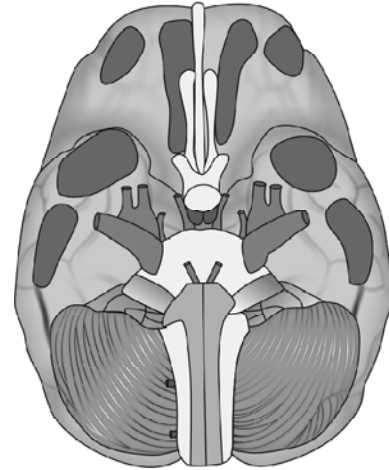

Fig. 13.7: Location of contre-coup contusions on undersurface of frontal and temporal lobes

tentorium, or the cerebellar tonsils against the foramen magnum. It is independent of the site and direction of impact.

Autopsy Findings

- In early stages, small contusions appear as linear hemorrhages perpendicular to the pial surface and associated focal swelling. Large contusion—lacerations appear as fragmented and irregularly shaped hemorrhagic areas. Frequently, there is associated subarachnoid hemorrhage.
- With time, it shrinks and takes a golden brown color secondary to hemosiderin deposition.
- Old contusions are frequent incidental autopsy finding, particularly in chronic alcoholics, which are seen as depressed yellow gliotic scars (*plaque jaune*).

Intracranial Hematoma

Intracranial hemorrhages are classified by anatomical location:

Types of intracranial hematoma

- | | |
|--------------|-----------------|
| • Extradural | • Subarachnoid |
| • Subdural | • Intracerebral |
- Intracranial hemorrhage is a common complication of head injury and is the most common cause of death in patients who experienced a lucid interval, 'talk and die', or 'talk and deteriorate after injury'.
 - Clinical complications associated with a hematoma are related to the size/volume of the lesion, the anatomical location and the rapidity with which it develops.

- Hypovolemic shock cannot happen from intracranial bleeding; there isn't enough space inside the head for the amount of blood loss needed to produce shock.
- Expanding hematomas should be distinguished from delayed hematoma, which are lesions that occur 24-48 h after the time of injury and that are not evident on initial imaging studies. It reflects increased blood flow or pressure through a vascular capillary network that was focally damaged, compounded by posttraumatic coagulopathy.
- In several cases of death due to blunt force head trauma, the only intracranial injuries that are evident at autopsy include subdural and subarachnoid hemorrhage.

- **Hemorrhage:** Copious discharge of blood from the blood vessels.
- **Hematoma:** Localized collection of blood in the tissues, usually clotted or partially clotted.
- **Apoplexy:** Sudden large effusion of blood in an organ or tissue.²⁴ The term is synonym for cerebral hemorrhage.

Extradural/Epidural Hematoma (EDH)

Definition: It is the bleeding occurring between the inner table of the skull and meninges (dura) (Fig. 13.8A).

Cause: Mostly traumatic in origin and unilateral. It is seen in falls and road traffic accidents (upto 10% of severe head injury cases).

Salient Features

- It occurs usually on the side of the impact, and common in adults between 20-40 years as the dura is able to strip more readily off the underlying bone.
- It is infrequent in the elderly and young (< 2 years) due to greater adherence of dura to the skull in both these age groups and absence of a bony canal for the artery in the young.
- It shows typical limitation due to the dural attachments at the suture lines.²⁵
- Fracture (fissure type) is present in most of the cases (90-95%).
- In children, EDH may be seen even without skull fracture.

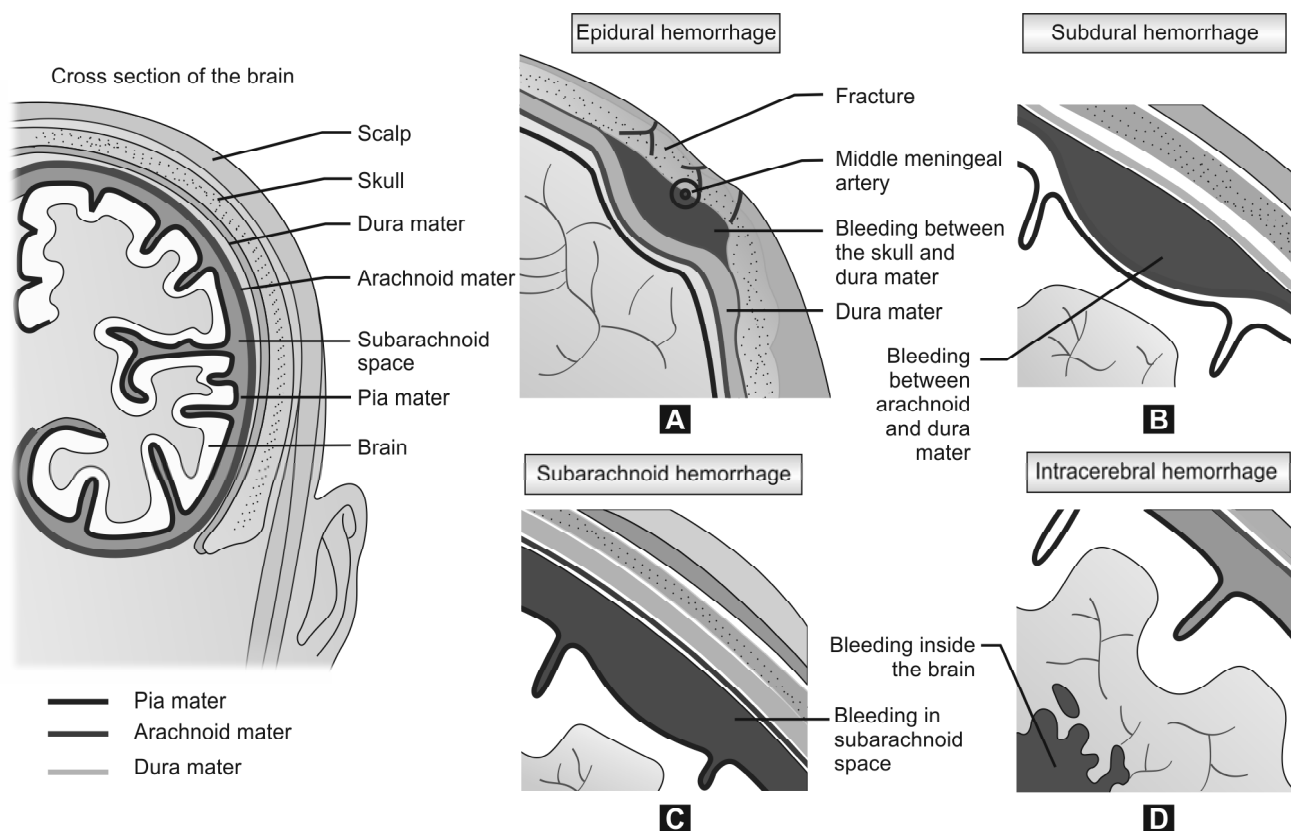

Fig. 13.8: Intracranial hematomas (For color version see Plate 3)

- It forms a circumscribed ovoid or disk-shaped blood clot that progressively indents and flattens the adjacent brain.
- Size and extent of an EDH is determined by the source of bleeding (venous or arterial) and the strength of attachment between the outer layer of the dura and the cranium.
- Artifactual epidural hematomas can occur in fire victims, related to heat-induced postmortem skull fractures.

Vessels Involved

- It may be due to impact over:
 - Lateral convexity of head, resulting in linear fracture of squamous temporal bone with rupture of underlying middle meningeal artery which is a direct branch of internal maxillary artery (*commonest cause*).²⁶⁻²⁸
 - Forehead that may tear the anterior ethmoidal artery.
 - Occiput that may tear the transverse sigmoid sinus.
 - Vertex that may cause hemorrhage from sagittal sinus.
- Fracture of skull with tear of diploic veins and middle meningeal veins.

Types

- Acute* onset is within few minutes to few hours or even a day (arterial bleeding).
- Chronic*: Symptoms are slower in onset (48-72 h) after trauma. It is rare and commonly associated with tears of venous structures.

Clinical Features²⁹⁻³¹

- Loss of consciousness due to concussion.
- Dilation of pupil on the side of hemorrhage with conjugate deviation of eyes to opposite side.
- Bilateral fixation of pupils.
- Lucid or latent interval** is seen.* It is a state of consciousness between two episodes of unconsciousness.³²
- Features of cerebral compression supervene and may lead to coma (due to continued bleeding or recurrence of fresh bleeding).
- Decerebrate rigidity and death due to respiratory failure.

Frequently, patient presents in coma and requires an urgent craniotomy. It is a *surgical emergency* and early diagnosis and necessary surgical intervention usually saves the patient.

* Patients with lucid interval are often not associated with other types of brain injury. If the patient is in coma from the time of injury, other types of brain injury are likely to be present.

Diagnostic tool: CT scan.

- It produces a biconvex lenticular-shaped hemorrhage, due to adherence of the dura to the inside of the cranium.
- Isolated EDHs of ≥ 2 cm or about 30 ml in volume may cause an alteration in the level of consciousness or a focal neurologic deficit.

Autopsy Findings

- Temporal scalp contusion on the side of the hematoma.
- Hematoma in the epidural space on removal of the skull cap along with fissure fracture of the temporal bone and a small thrombus on the surface of the middle meningeal artery may be seen.
- Diffuse brain swelling and cerebral contusions may be seen.
- Subfalcine herniation extending from the side of the hematoma to the opposite side and transtentorial herniation which is usually more marked on the side of the hematoma (effects of intracranial 'space occupancy').
- Swelling of the cerebral hemisphere under the hematoma causes effacement of sulci and flatness of the crests of the gyri, which gives a smooth appearance of the brain.

Medico-legal Aspects

- Prognosis is good with proper treatment. Hematoma on the contra-lateral side should be carefully excluded.
- Patient may be discharged from hospital during lucid interval and die at home; doctor may be charged with negligence.
- The condition may resemble drunkenness and patient may die in police custody.
- Presence of an EDH may or may not cause death—the possibility increasing with increasing volume of blood, duration of injury and the presence of herniation phenomenon.

Subdural Hematoma (SDH)

Definition: It occurs between the under surface of dura and outer surface of arachnoid mater (Fig. 13.8B). It is essentially venous or capillary and not arterial bleeding.

Cause: It is usually traumatic, following an assault or fall (70-75%), accidents account for another 20-25% of cases, but it can be due to secondary causes including alcoholism and anticoagulant therapy (Table 13.5).

Table 13.5: Causes of SDH

Causes	Comment
• Trauma	Blunt force head injury (accident/assault)
• Neurosurgical complication	Neurosurgical management of hydrocephalus
• Perinatal	Following labor (rarely significant)
• Vascular	Aneurysms, a rare childhood cause
• Hematological disorders	Inherited and acquired coagulation disorders and hematological malignancies
• Metabolic disorders	Glutaric aciduria, Menkes disease, galactosemia
• Hyponatremia	Associated with intracerebral hemorrhages
• Raised central venous pressure	Intradural bleeding may lead to subdural collections

Salient Features

- One of the *most common head injuries ending fatally*.
- Hematoma often not associated with a fracture of the skull.
- Commonly seen in elderly and alcoholics.
- Location of a SDH does not necessarily correlate to the location of the blunt force impact site.
- In infants < 1 year, the subdural space is narrower and less tolerant of space occupying lesions.

Vessels Involved

- Rupture of bridging or communicating veins traversing the subdural space to drain into parasagittal sinus.³³
- Tears in the dural venous sinuses.
- Cerebral contusions/lacerations after a fall.
- Fresh tear of old adhesion between dura and brain with bleeding.

Site: It is commonly seen over the upper lateral surface of cerebral hemispheres and most commonly supratentorial (fronto-temporal region). The blood presses on both the crests and depths of the gyri, hence the cerebral convolutions retain their normal contours, but it causes displacement of the cerebral hemispheres with flattening of the convolutions of the opposite hemispheres.

Types

SDHs are classified in clinical terms as acute, subacute, chronic or acute on chronic depending on the length of history, the neuroimaging findings and the appearance of the blood when the hematoma is drained.

- Acute:** Signs are evident within 3 days of injury. It occurs due to rupture of large bridging veins or the cortical artery or due to cerebral laceration.

- It is mostly unilateral, may be bilateral with mortality—90%.
 - *Clinical features:* Drowsy or comatose (one-third patients have a lucid interval) from the moment of injury. Unilateral headache, hemiparesis, enlarged pupil on the same side are frequent.³⁴
 - It is a rapidly evolving lesion and burr (drainage) holes or emergency craniotomy is mandatory.
 - Blood tends to accumulate in the base of skull, especially in the middle cranial fossa, is reddish in color and clotted.
- Subacute:** The signs are evident between 4-21 days.
 - It is due to rupture of smaller bridging veins.
 - It is associated with minor cerebral contusions or swelling.
 - *Clinical features:* Drowsiness, headache, confusion, forgetfulness or mild hemiparesis.
 - It may be mistaken in the young for schizophrenia and in the old for presenile and senile dementia.
 - Mortality is less.
 - Blood is partly clotted and partly fluid due to hemolysis or dilution with CSF.
 - Chronic or Pachymeningitis hemorrhagica interna chronica**
 - Signs and symptoms of alteration in mental state or progressive focal neurological deficits (usually headache, cognitive decline, gait abnormalities and hemiparesis) appear > 3 weeks after trauma.
 - It is most common in infants (< 6 months) and in the elderly (> 60 years). A history of head trauma may be elicited.
 - Blood is liquefied, mixed with proteins and CSF.
 - *Risk factors:* Cerebral atrophy, alcohol abuse, seizures, coagulopathies, subdural structural abnormalities, intraventricular shunts, CSF fistulae and dehydration.
 - It is usually seen over the parietal lobe and near the midline.
 - It is frequently an incidental finding at autopsy in old persons.

Diagnostic tool: CT scan. It appears as concavoconvex crescentic opacity.³⁵

- Acute SDH appears hyperdense to brain tissue, subacute appears isodense and chronic appears hypodense on noncontrast CT.
- Acute SDH > 120 ml is invariably fatal, between 50-120 ml is likely to cause death (particularly if there is significant subfalcine herniation and uncal herniation), and < 50 ml is unlikely to be fatal. Usually 50 ml of rapidly accumulating subdural blood is sufficient to be life-threatening.
- 'Acute on chronic' SDHs are chronic SDHs into which there has been recent bleeding to the extent that new neurological symptoms are precipitated in a patient who previously had no symptoms or trivial symptoms.

Age of Subdural Hematoma

Grossly, during the first 4 days, hematoma undergoes clotting and gradually becomes dark red to brownish in color by 5-10 days. Discrete fragile membrane becomes obvious by 2nd week. Liquefaction of clot occurs by 3 weeks. After 1 month, a firm capsule containing a dark brown watery fluid is formed.

Histologically, age of subdural hematoma can be estimated as given in Table 13.6.

Autopsy Findings

- i. Externally, evidence of blunt force injury more commonly to the face than to the head may be seen.
- ii. Skull fractures are usually present.
- iii. Clotted or partly liquefied hematoma extending for a considerable distance in the subdural space, producing an accentuation of the gyral pattern on the affected side with flattening of the opposite side (in contrast to the smooth brain surface under an epidural hematoma).
- iv. In acute SDH, there are no enclosing membranes. Chronic SDH may present 'classically' as typical *hematoma* surrounded by a clearly defined membrane that includes original dura, and an *inner* and *outer 'neomembrane'* which contains bloodstained fluid of variable color (usually yellow).
- v. Transtentorial herniation (more marked on the same side of the hematoma) and tonsillar herniation, and subfalcine herniation directed away from the side of the hematoma may be seen.

Table 13.6: Histological timing of subdural hematoma

Interval	Features
36 h	Intact RBCs, fibroblastic activity at the margins.
4-5 days	Loss of RBC contour, neomembrane adjacent to dura is 2-5 layers of thickness.
6-10 days	Laked RBCs, clot liquefies, 12-14 layers of fibroblasts, hemosiderin laden phagocytes seen, neomembrane visible grossly.
11-14 days	Fibroblasts, capillaries, and fibrin subdivide the clot, fibroblasts migrate around the edges of clot, siderophages present on arachnoid side.
15-20 days	Capillary formation, original RBCs lysed, membrane $\frac{1}{3}$ to $\frac{1}{2}$ dural thickness on the side of dura, but variably thin on arachnoid side.
3-4 weeks	Liquefied clot, membrane same thickness as dura on dural side and $\frac{1}{2}$ dural thickness on arachnoid side. Siderophages in membranes.
1-3 months	Hyalinization of membranes, more of collagen and of same thickness as dura on arachnoid side.
3-6 months	Hyalinized neomembrane resembling dura.

Medico-legal aspects

- The presence of any amount of SDH is usually interpreted by forensic experts as an indicator that the amount of force sustained by the individual was likely sufficient to cause lethal brain injuries. However, it is possible for individuals to survive a SDH.
- Histopathology of SDH, both acute and chronic, is used as a basis for estimating the period between injury and death which helps in correlating the events prior to death.

Subdural Hygroma

It is an accumulation of CSF in subdural space. When arachnoid is torn, CSF may pass from subarachnoid space into subdural space. A large collection of fluid may accumulate and cause cerebral compression.

- It is usually seen in infants and children.
- This chronic lesion has all the features of subdural hematoma, except trauma is not recorded and amount of blood is minimal.
- It may develop as a complication of meningitis, hydrocephalus and head trauma with/without skull fracture.

Subarachnoid Hematoma (SAH)

Definition: It is the hemorrhage in the subarachnoid space between the arachnoid and pia mater, mixed with CSF (Fig. 13.8C).

Salient Features

- SAH is common in TBI. Even in minor head trauma, small amount of localized SAH over the cerebral convexities is almost invariably seen.
- Like SDH, the location does not correlate with the site of impact in blunt force trauma, but usually SAH is most prominent close to its source.
- SAH is extensive because CSF and unclotted subarachnoid blood flow freely in the subarachnoid space.
- When a brain is removed at autopsy, the arachnoid membrane remains covering the brain.

Causes

It is mostly venous in origin.

a. Non-traumatic/natural causes

- i. Rupture of a developmental aneurysm of the vessels in the Circle of Willis [Berry (saccular) aneurysm]. Excluding head trauma, it is the most common cause (70% of cases) of SAH especially in young adults (Fig. 13.9).³⁶ Aneurysm size and site are important

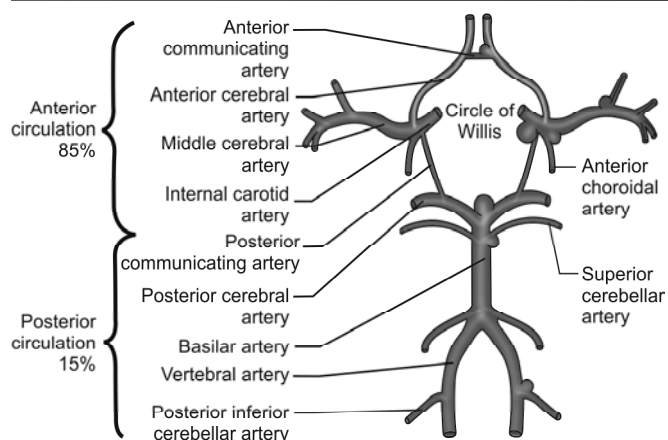

Fig. 13.9: Common sites of Berry aneurysms in circle of Willis

in predicting risk of rupture. Rupture is likely with aneurysms that are large (7-10 mm in diameter).

- ii. Arteriovenous malformations (10%).
 - iii. Atherosclerotic changes in blood vessels associated with hypertension in elderly subjects.
 - iv. Leaking intracerebral hemorrhage.
 - v. Disease conditions, like purpuric states and leukemia.
- b. Traumatic causes**
- i. Cerebral contusions or lacerations.
 - ii. Explosive blast.
 - iii. Asphyxia by strangulation.
 - iv. Traumatic asphyxia.
 - v. Blows to the neck, accidents, falls and cervical manipulations causing damage to the vertebral or basilar arteries.
 - vi. Rupture of a traumatic ICH into the subarachnoid space or into the cerebral ventricles with flowing of the blood through the foramina of Magendie and Luschka into the subarachnoid space.
 - vii. Prolonged hyperextension of the head during bronchoscopy, bleeding originating from rents in basilar or vertebral arteries (may lead to a charge of negligence).

In acute alcoholism, traumatic SAH is common due to:

- Loss of muscular coordination resulting in excessive rotational forces within the head
- Increased bleeding from congested vessels
- Bounding pulse of the drunken man

Site: SAH has a predominantly basal distribution. It is usually found over the orbital surface of the frontal lobe, parietal lobe and anterior third of the temporal lobes. It can be unilateral or bilateral, localized or diffuse.

Types

- i. Immediate
- ii. Delayed/reactionary hemorrhage—until the initial contraction and retraction of vessels has subsided (delayed post-traumatic SAH)

Clinical Features³⁷⁻³⁹

- i. Sudden onset of severe, unusual headache ('thunderclap headache')
- ii. Nausea and vomiting
- iii. Neck stiffness, photophobia, drowsiness or agitation
- iv. Depressed consciousness

Physical findings: Meningism and a positive Kernig's sign.

Diagnosis: Non-contrast CT scan.⁴⁰ Lumbar puncture (LP) should be performed, if CT scan is not yielding sufficient information. LP will reveal CSF intimately mixed with blood coming under increased pressure.

Differential diagnosis: Bacterial meningitis.

Medico-legal Aspects

- Atherosclerotic vessels in older persons with high BP rupture more easily than normal ones. The condition of blood vessels must therefore receive most careful consideration.
- It is possible to testify that trauma has caused or precipitated the rupture of developmental Berry aneurysm when head injury is followed at once by symptoms of unexplained acute neurologic deficit (headache, hemiparesis, stupor, or confusion).
- SAH can be produced postmortem, secondary to decomposition, with lysis of blood cells, loss of vascular integrity and leakage of blood into subarachnoid space. It can also be produced during the process of removing the brain.

- **Berry aneurysms** usually occur at a point where an artery is branching from a parent artery close to the circle of Willis and develop where the vessel wall is abnormal due to congenital defect or a degenerative change producing a thin-walled out-pouching. The wall of an aneurysm lacks an internal elastic lamina and muscularis layer. Only the intimal layer and adventitia of the artery form the dome of the aneurysm.⁴¹
- **Thunderclap headache:** Headache that reaches its maximum intensity in < 1 min. SAH is the most common cause.⁴² *Other causes:* Sentinel headache, cerebral venous sinus thrombosis, unruptured cerebral aneurysm, cervical artery dissection, pituitary apoplexy and ischemic stroke.

Important differentiating features of extradural, subdural and subarachnoid hemorrhages are given in Diff. 13.3.

Differentiation 13.3: Extradural, subdural and subarachnoid hemorrhage

S.No.	Feature	EDH	SDH	SAH
1.	Location	Between skull and dura	Between dura and arachnoid	Between arachnoid and pia
2.	Cause	Always due to head injury	Mostly due to injury but not always	Both natural and traumatic
3.	Incidence	2% of head injuries	5% of all head injuries; 50% of fatal head injuries	Extremely common in head injuries
4.	Vessel involved	Middle meningeal artery	Bridging veins, cortical contusions	Leakage from vessels on brain surface
5.	Externally	Often swelling under the scalp	Often no external manifestation	No external manifestation
6.	Confusion with other condition	Can be confused with heat artefact	Seldom confused with other bleeding	Can be artefact from opening the skull
7.	Space occupying	Can be space occupying	Often space occupying	Space occupying, if it is arterial
8.	Effect on brain	Brain surface ironed out by dura	Brain compressed, but less ironed out	Brain surface not distorted
9.	Situation	Usually on one side, but can be bilateral	Unilateral or bilateral	Focal, diffuse, or bilateral
10.	Clinical course	Classic lucid interval	Less well-defined	Depends on cause, location, vessel
11.	Autopsy	Save a portion for alcohol and drugs	If fresh, save a portion for alcohol and drugs	Seldom sufficient or helpful for analysis

Intracerebral Hematoma (ICH)

Definition: Hemorrhage found within the cerebral parenchyma that is not in contact with the surface of the brain (Fig. 13.8D).

Salient Features

- Traumatic ICH is seen in 15% of all patients who sustain fatal head injuries.
- Most likely result from a direct rupture of intrinsic cerebral blood vessel in relation to contusions at the time of injury.
- May be single or multiple.

Causes: Hypertension, trauma and cerebral amyloid angiopathy cause the majority of these hemorrhages.⁴³ Advanced age, heavy alcohol and cocaine use increase the risk. Usually, it is due to disease of cerebral vessels; hypertension is often a contributory cause.

- Spontaneous hemorrhage in the region of basal ganglia by rupture of lenticulo-striate artery (Charcot's artery) which is a branch of middle cerebral artery.
- Capillary hemorrhage in anoxia, arterial thrombosis, blood dyscrasias, fat embolism and asphyxial states.
- Angioma or malignant tumor of the brain.
- Hypertensive cerebral vascular disease.
- Laceration of the brain.
- Puerperal toxemia.

Sites: ICH are well demarcated homogenous collection of blood seen most frequently in the white matter of the fronto-temporal lobes when superficially located and are most likely related to extensive contusional injury; more deeply seated hematomas are seen in impacts of greater force, such as road traffic accidents.

Traumatic and Nontraumatic ICH (Diff. 13.4)

The cause of ICH is at times remains uncertain and a coincidental hypertensive hemorrhage or a hemorrhage associated with cerebral amyloid angiopathy may be difficult to exclude.

- The exclusion of a hypertensive hemorrhage is presumptive, based on the lack of a history of hypertension and the absence of gross (e.g., cardiomegaly and renal granular atrophy) and microscopic features (hypertensive vascular changes in the basal ganglia and dentate nucleus) of hypertension.
- Hemorrhage owing to cerebral amyloid angiopathy is excluded when microscope sections stained with Congo red do not show amyloid in the cerebral vessels.

Clinical Features

Occurs while the patient is awake and stressed.

- Abrupt onset of focal neurologic deficit
- Diminished level of consciousness

Differentiation 13.4: Post-traumatic intracerebral hemorrhage (PTICH) and spontaneous cerebral hemorrhage (apoplexy)

S.No.	Feature	PTICH	Apoplexy
1.	Cause	Head injury	Hypertension, atherosclerosis or aneurysm
2.	Age	Young individuals	Adults (past middle age)
3.	Onset	Distinct interval after injury	Sudden
4.	Position of head	In motion	Any position
5.	Mechanism	Blunt force injury, coup and contre-coup	Rupture due to disease
6.	Site/location	White matter of frontal or temporo-occipital region	Ganglionic region
7.	Concussion	May be seen	Not present
8.	Coma	Variable; coma from beginning or concussion → consciousness → coma	Deep unconsciousness and no such sequence

- iii. Signs of increased intracranial pressure, such as vomiting and headache
- iv. Seizures are uncommon
- v. Contralateral hemiparesis

Large intracerebral hematomas should be evacuated, unless the patient's neurological state is improving. Small multiple hematomas need not be removed.

Diagnostic tool: CT scan. ICH appear as hyperdense lesions (small foci, typically at gray/white matter interface or more centrally in the white matter) and are associated with mass effect and midline shift.

Intraventricular Hemorrhage (IVH)

The presence of copious blood in the fourth ventricle, seen through the foramina of Luschka and Magendie before the brain is sectioned, can be taken as indirect evidence of IVH which is confirmed when the brain is sectioned. Traumatic IVH can be primary or secondary.

- *Primary traumatic IVH* is rare but occurs after motor vehicle accidents and assaults.
- *Nontraumatic primary IVH* originates from a ruptured Berry aneurysm or vascular malformation or can be associated with hypertension, anticoagulant therapy or methamphetamine abuse.
- *Secondary IVH* is common after trauma which is usually self-evident when the brain is sectioned and a hematoma is found in continuity with the ventricles.

- Most common type of intracranial hemorrhage: Intracerebral hemorrhage.²⁵
- Least common type of intracranial hemorrhage: Epidural hemorrhage.
- Most common non-traumatic intracranial hemorrhage: Intracerebral hemorrhage.

- Most common intracranial hemorrhage following head trauma: Subdural hemorrhage.
- Most common cause of subarachnoid hemorrhage: Head trauma.
- Second most common cause of subarachnoid hemorrhage: Rupture of Berry (saccular) aneurysm.
- Most common cause of intraparenchymal hemorrhage: Hypertension.
- Most common artery involved in intraparenchymal hemorrhage: Lenticulostriate artery.
- Most common sites of hypertensive hemorrhage: Basal ganglia [putamen (most common site, 55%), thalamus (15%) and adjacent white matter (10%)], deep cerebellum (10%), and pons (10%).⁴⁴
- Sites of hemorrhage following head trauma: Intraparenchymal (inferior frontal lobes, anterior temporal lobes), subarachnoid, subdural and epidural spaces.
- Commonest sites of rupture of Berry aneurysm: Anterior circulation (85%), with the most common locations at the origin of the anterior communicating artery, origin of the posterior communicating artery and the bifurcation of the middle cerebral artery (Fig. 13.9). Vertebral artery is the least common site.⁴⁵

Diffuse Injury to the Brain

DAI has already been discussed. Ischemic and hypoxic brain damage and an increase in the volume of all or part of the brain are common pathology seen in autopsy of fatal TBI.

Diffuse Ischemic Injury

- Diffuse ischemia injury can develop as a consequence of increasing cerebral swelling secondary to cardiorespiratory arrest, or as a consequence of

profound hypotension as a result of other injuries, particularly fracture of long bones.

- More common in patients with high intracranial pressure [(ICP), > 60 mm Hg is fatal].
- Ischemic damage is another cause of traumatic coma in the absence of an intracranial mass lesion.
- *Histologically* neuronal ischemic injury can be identified using H&E stain: neuronal nucleus is shrunken and the cytoplasm undergoes eosinophilic change, appearing red.

Diffuse Vascular Injury

- Diffuse vascular injury is caused by the same type of forces that cause DAI, but the force is more severe and produces extensive disruption of neuronal function so that death occurs before axonal swellings can develop.
- *Autopsy findings:* Contact head injuries may not be apparent. Brain reveals thin SAH and widely scattered petechial hemorrhages. The hemorrhages are prominent in subependymal regions, lateral pons and midbrain, and midline of the hypothalamus and rostral brainstem.

Differential diagnosis of multiple brain petechiae

The petechiae of diffuse vascular injury may be confused with vascular congestion which is common and often marked in the brain after fatal TBI.

- Petechiae in vascular congestion can be identified by its preference for dependent areas of the brain, its localization to the walls of the third ventricle, and its tendency to be absent or inconspicuous in the brainstem.
- Widespread petechiae also seen in many non-traumatic conditions including DIC, thrombotic thrombocytopenic purpura, air and fat embolism, and cerebral malaria.

Brain Swelling

- Swelling may be severe enough to raise the ICP and cause death from brain shift, herniation and secondary damage to the brainstem.
- The unmyelinated infant brain with its higher water content more rapidly produces life-threatening cerebral edema.
- It can be classified into three types: swelling adjacent to contusions (focal), diffuse swelling in one cerebral hemisphere seen in association with ipsilateral acute SDH which becomes evident after surgical removal of the hematoma, and diffuse in both cerebral hemispheres due to global ischemic injury which tends to occur in young patients.
- *Pathogenesis:* It is caused by vasodilation secondary to loss of cerebrovascular autoregulation causing increase in the cerebral blood volume (i.e. congestive)

or an increase in water content of the brain tissue (cerebral edema).

- *Features:* Flattening of the surface of the gyri and narrowing, effacement of the sulci causing a smooth, flat outline on the normal undulations of the surface of the cerebral hemisphere. Brain swelling also causes narrowness of the cerebral ventricles, and when it is localized, it may cause herniation (Fig. 13.10).
- In rare cases, the only intracranial injury identified at autopsy is a markedly swollen brain. The swelling may be diffuse or it may be localized to a single side with an associated 'midline shift' which is referred to as '*malignant cerebral edema.*'

- **Brain herniation** may extend under the falx cerebri damaging the cingulate gyrus (subfalcine or supracallosal hernia), under the tentorium cerebelli damaging the parahippocampal gyrus/medial temporal lobe (tentorial or uncal hernia), and through the foramen magnum damaging the tonsil of the cerebellum (tonsillar hernia).
- **Cushing ulcer** is one of the complications seen in 50-75% of patients with TBI. It is a form of gastroduodenal stress ulceration similar to Curling's ulcer seen in severe burns. The ulcers are usually small and multiple.
- **Duret hemorrhages** are delayed, secondary brainstem hemorrhages (seen in midbrain and pons). They occur in cranio-cerebral trauma victims with rapidly evolving descending transtentorial herniation.⁴⁶ *Diagnosis:* CT brain.

Evaluation of head injury case

- Initial neurological assessment should evaluate the patient's level of consciousness and symmetry of neurologic function from head to toe. This should include a determination of the patient's GCS, cranial nerve examination that evaluates pupillary function, extraocular movements, facial symmetry, and vital cranial nerve reflexes, as well as motor examination.
- Noncontrast head CT scan.

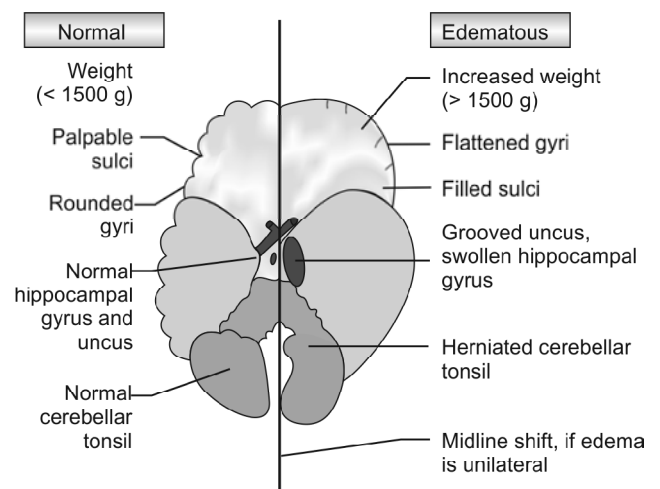

Fig. 13.10: Features of brain swelling

Surgical management

- Patients with an EDH > 30 ml in volume, or EDH in coma (GCS < 9) with pupillary asymmetry, or an acute SDH with thickness > 10 mm or a midline shift > 5 mm on CT should be surgically evacuated.
- A comatose patient with SDH < 10 mm thickness and midline shift < 5 mm should undergo evacuation, if GCS score decreases since admission.
- Patients with parenchymal mass lesions (contusions and intracerebral hematomas) and signs of progressive neurological deterioration due to the lesion or signs of mass effect on CT scan should be treated operatively.
- Patients with GCS scores of 6-8 with frontal or temporal lesions < 20 ml in volume with a midline shift of at least 5 mm and/or cisternal compression on CT scan, and patients with any lesion > 50 cc in volume should be treated operatively.

Spinal Cord

Spinal cord may be injured by penetrating wounds; *common sites involved* in order of frequency are:

- Lower cervical
- Thoracolumbar
- Upper cervical

Compression of spinal cord rarely occurs from effusion of blood from a fall. The cord is rarely penetrated in its upper part by sharp-pointed instruments. Firearm wounds may cause cord injury, even when the missile has not entered the cord.

Contusion of spinal cord may occur from direct or indirect violence. The hemorrhages usually extend in the axis of the cord. Bleeding may occur either into the spinal meninges (*hematorrhachis*) or into the substance of the spinal cord (*hematomyelia*).

Whiplash Injury

- Whiplash injury is an acceleration-deceleration mechanism of energy transfer to the neck that may result in bony and soft injuries.

- Commonly seen in road traffic fatalities which are due to the hyperextension of the neck.⁴⁷ Hyperflexion injuries are less likely but can be caused if heavy weights are dropped onto the bent back of an individual—may be seen in roof collapse.
- This injury is sustained commonly by occupants of the front seat in a motor vehicle.

Causes

- Rear end or side-impact motor vehicle collisions and sometimes in front impact collisions.
- Blow on the chin
- Blow against the spinous process of upper cervical vertebrae (rabbit punch)

Mechanism: Abrupt accelerations of the trunk causing whip-like movements of the head can occur in rear end collisions causing a maximal, unchecked backward thrusting of the head followed immediately by a forward rebound (Fig. 13.11A), if there is no/poorly adjusted head rest. In case of side impact collision, then the cervical spine will be forcibly bent in the frontal plane or in an intermediate plane (frontal and sagittal) (Fig. 13.11B).

Signs and symptoms

- Pain and/or stiffness of neck and lower back immediately or within 24 h after trauma (cardinal manifestation)
- Headache, dizziness, tinnitus, vertigo
- Irritability, nausea and fatigue
- Blurred vision
- Numbness and tingling
- Pain in the arms, legs, feet and hands
- Difficulty in swallowing
- Pain between the shoulder blades
- Concentration and memory problems
- Psychological problems

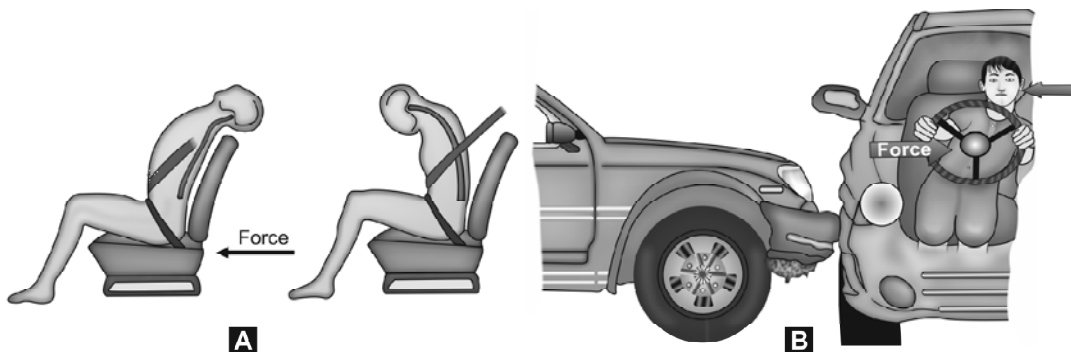

Fig. 13.11: Acceleration-deceleration injury of the cervical spine in (A) Rear-end and (B) side-impact collision

Imaging

- *Plain X-ray*: New degenerative changes may be seen.
- *CT scan*: Rotatory instability with increased rotation at C0-C1 and/or C1-C2.
- *MRI*: Disc herniations, ligamentous lesions at the craniovertebral junction, especially at the alar ligaments and transverse ligaments.

Autopsy findings

- Facet joint (cervical zygapophysial joint), yellow ligament, uncovertebral and disc/endplate lesions may be seen.
- An area of hemorrhagic discoloration on the surface or in substance of the cord or subtheal effusions of blood may be found.

Medico-legal aspects: A rising percentage of car accidents result in a refund claim based on whiplash. This is partly due to an increased awareness and documentation, though few false claims cases are also there.

Concussion of Spinal Cord (Railway Spine)**Causes**

- In railway and motor collisions (most common)
- Severe blow to the back
- Compression from dislocation/fracture of vertebrae
- Damage by effusion of blood
- Fall from height
- Bullet injury

Symptoms appear immediately or after some hours and includes headache, giddiness, restlessness, sleeplessness, neurasthenia, weakness in limbs, amnesia, loss of sexual power and derangement of special senses.

- It produces paralysis, affecting the arms and hands or bladder, rectum or lower extremities.
- Paralysis is temporary and recovery occurs in about 48 h.

Neck

The neck can be the site of many different types of injury. Its importance in forensic medicine is due to the presence of a large number of vital structures and the fact that it is of a size that can be grasped and easily held.

- Fractures of the hyoid bone or thyroid cartilage may occur due to fall injuring the neck, or when the neck comes in forcible contact with the handlebar of a cycle or the dashboard of a motor car.
- A blow to the side of the head or face, with a resultant abrupt twisting or sideways flexion motion of the neck can result in a laceration of the vertebral artery.
- A blow on the front of the neck may cause unconsciousness or even death due to vagal inhibition or by

fracture of the larynx, usually involving the thyroid and cricoid cartilages and resultant suffocation from hemorrhage or edema of the larynx.

- The mucous membrane of the trachea or larynx may be torn producing surgical emphysema and cause death by asphyxia.
- Suicidal incised wounds are more common than homicidal, but punctured wounds are usually homicidal.
- In wounds of the trachea and of the larynx below the vocal cords, speech is not possible. Wounds of the larynx and trachea are not fatal, if the large blood vessels are not damaged.
- Wounds of the sympathetic and vagus nerves may be fatal, those of the recurrent laryngeal nerves cause aphonia.
- Fractured neck by blunt force can cause spinal cord contusion, laceration or transection. Disruption of the atlanto-occipital junction can result in similar injuries.

Vertebral Column

- The spine is commonly injured in major trauma such as road traffic accidents or falls from a height.
- The type of injury will depend upon the degree of force and the angle at which the spine is struck. Vertebral column is strong in compression and vertically applied forces will result in little damage if the spine is straight. Angulation of the spine will alter the transmission of force and the spine becomes susceptible to injury, particularly at the site of the angulation.
- Force applied to the spine may result in damage to the discs or to the vertebral bodies.
- Fractures of the vertebral column are caused by direct violence or by indirect violence, as by forcible bending of the body or by a fall on buttocks or feet.
- Hyperflexion is the most common mechanism of fracture of spine. Falling from a height, diving and being thrown from automobile are the common causes.
- The *common sites of fracture* are upper and lower cervical regions and the junction of thoracic and lumbar segments. Fracture-dislocation and fracture of the laminae can damage the spinal cord.

Fracture of transverse processes: These are common in the region of the lumbar spine, where the quadratus lumborum muscle is attached.

Fracture of vertebral bodies: Compression (wedging) of vertebral body is the commonest fracture of the thoracic,

thoracolumbar or lumbar spine. It may occur with a fall from a height. Injuries to the atlas and axis are more dangerous than lesions in the lower cervical vertebrae, because of involvement of the respiratory centre.

Chest

Injuries of the chest can be:

- **Non-penetrating or closed** i.e. they do not open up any part of the thoracic cavity. Usually caused by blunt force.
- **Penetrating or open.** If an injury damages the parietal pleura, it will produce an open pneumothorax, communicating directly with the external air.

Children and young adults whose chest is elastic, may sustain severe injuries to the intrathoracic viscera without fractures of sternum or ribcage.

In some cases, absence of injuries may be due to clothing worn by the victim.

Ribs

Blunt injury may result in fractures of the ribs. The fracture of a few ribs is unlikely to have much effect, other than causing pain in a healthy adult. In children, rib fractures more resilient and they are able to cope better.

- If compression is front to back, lateral rib fractures may occur, and if back to front, the ribs tend to fracture near the spine.
- If compression is from side to side, the ribs may fracture near the spine and sternum. The middle ribs from 4-8th are usually fractured. In fractures due to direct violence, the fragments are often driven inwards and lacerate the underlying structures.
- In case of run over by a motor vehicle, the ribs are fractured symmetrically on both sides, in front near the costal cartilages and at the back near the angles.
- Multiple unilateral or bilateral rib fractures give rise to a *flail or 'stove-in' chest*, with consequent paradoxical respiration (the area of chest around the fractures may be seen to move inwards on inspiration) which interferes with respiratory exchange and also with return of the blood to the right atrium, resulting in severe dyspnea. Flail chest occurs when at least three successive ribs are fractured at two points.

Sternum: Fractures of the sternum are not common.

Complications of rib fracture: Flail chest, lacerations of intercostal blood vessels with hemothorax, laceration of lungs with pneumothorax or hemopneumothorax, impaling wounds of heart, pleurisy and pneumonia.

Rib fractures can also be *artefactual* due to cardiopulmonary resuscitation which may result in sternal and parasternal fractures.

- They are usually identified by their symmetrical, parasternal pattern and relative lack of hemorrhage at fracture site which indicates postmortem origin.
- Sometimes, fractures are seen in the left side only and may involve the first six ribs and sternal fracture may occur at the level of third or fourth intercostal space.

Lungs

- Compression of the chest or blunt weapon trauma produces contusions or lacerations.
- After severe head injury, where victim has been maintained for some time in a respirator, areas of collapse and hemorrhage with the formation of hyaline membrane is seen—'*respirator lung*'.
- A wound of the lung causes frothiness of blood, which issues from the mouth and nose or during coughing.
- Sudden compression of the chest may produce contrecoup contusions due to violent displacement of air in the lungs to the posterior surfaces near the angles of the ribs. The contusions may extend laterally or forwards into the substance of the lungs.
- Stab wounds of the lungs are usually not fatal, unless a major pulmonary blood vessel has been severed.
- *Spontaneous pneumothorax* may occur following rupture of an emphysematous bulla. *Tension pneumothorax* is seen when the leak in pleura has a valve-like action, air is sucked into the chest wall at each inspiration, but cannot escape on expiration. *Iatrogenic pneumothorax* may occur by external cardiac massage, percutaneously introduced subclavian catheters and continuous ventilatory support.

Complications of chest injuries

- Pneumothorax
- Hemothorax
- Air embolism
- Intraparenchymal hemorrhage
- Chylothorax
- Interstitial emphysema
- Cardiac tamponade
- Infection

Diaphragm: Traumatic rupture of diaphragm is seen with blunt trauma of the lower anterior chest and is more common on the left (right side is protected by liver).

Heart

- Contusions and lacerations of the heart may be caused by direct violence to the chest or by compression of the thorax, or when a driver is forcibly thrown against the steering wheel. Cardiac contusions are usually

seen on the anterior surface of either ventricle or the interventricular septum. Recent cardiac contusions are dark-red, hemorrhagic areas which are usually subepicardial.

- The commonest pincer lesion is a contusion of the right atrium at the entrance of the inferior vena cava. This is seen in compression injuries. It may cause sudden death, several days after the injury.
- Contrecoup contusions of the heart are seen over the posterior wall of the left ventricle. They are seen in traffic accidents in which the driver is thrown forward against the steering wheel and the heart is compressed against the vertebrae. Contusions may cause sudden death from ventricular fibrillation, or they may cause progressive circulatory failure and death after few hours or days.
- Foreign bodies, e.g. bullet, may remain embedded in the myocardium for years without producing any symptoms.
- The *common sites of traumatic cardiac rupture* in order of diminishing frequency are: right auricle, right ventricle, left auricle, ventricular septum and valves.
- The only *natural cause of rupture of the heart* is softening or thinning by infarction, which invariably occurs in the left ventricle.
- Stab wounds of the heart are dangerous. If the left ventricle is pierced, the thickness of the muscle wall may restrict the bleeding, allowing time for surgical treatment. A stab of the right ventricle is more rapidly fatal, blood escaping through the wound to cause hemopericardium and **cardiac tamponade**. Even 150 ml (average 400-500 ml) of blood can cause death by increasing intrapericardial pressure and producing mechanical interference with ventricular contractility. The right ventricle is more likely to be wounded, as it exposes its widest area towards the front of the chest.

Cardiac tamponade presents with three signs (Beck's triad). They are—low arterial blood pressure, increased central venous pressure and distant heart sounds. Hypotension occurs because of decreased stroke volume, jugular-venous distension due to impaired venous return to the heart, and muffled heart sounds due to fluid inside the pericardium.

Cardiac concussion or commotio cordis: It refers to sudden cardiac death following a blunt trauma to the chest. It is often associated with sports and in young athletes.

Mechanism: The impact occurs at an electrically vulnerable phase of the cardiac cycle (during early ventricular repolarization; 15-30 milliseconds before the peak of the T wave).

Aorta: Wounds of the aorta or the pulmonary artery are rapidly fatal. The rupture of the aorta commonly occurs at the junction of the arch and the descending parts, just beyond the origin of the left subclavian artery and is due to violent compression of the chest. It is common in traffic accidents and less common in fall from height and crushing chest injuries. Spontaneous rupture of the aorta may occur from local disease.

Abdomen

Abdominal organs are vulnerable to a variety of injuries from blunt trauma because lax and compressible abdominal walls can transmit the force to the abdominal viscera.

Injuries of the abdomen can be classified into:

- **Non-penetrating or closed**, i.e. peritoneum is intact. It is caused by blunt force; seen in falls, traffic accidents and assault by blunt weapons.
- **Penetrating or open**, i.e. when peritoneum is ruptured, it is open to infections.

Profuse subcutaneous or deep-seated bleeding of the abdominal wall may track along the muscular and fascial plane to become more diffuse, and may cover a large area of abdominal wall, especially in the lower segment. Blood may track down the inguinal canal and appear in the scrotum or labia.

In order of frequency, *the structures most likely to be damaged in blunt abdominal trauma are:* spleen, liver, kidneys, intestines, abdominal wall, mesentery, pancreas and diaphragm.

Injuries of the stomach and intestines may be caused by:

- compression or crushing forces which produce contusions or lacerations
 - traction or tearing forces
 - disruption or bursting forces
- Hollow visceral injuries are less common in blunt trauma compared to penetrating injuries.
 - Small intestine is more commonly injured by forces of compression than the stomach and the large intestine.
 - The proximal jejunum is the commonest site of rupture, followed by the ileum, duodenum, caecum, and large intestine. Transverse colon is usually involved in case of large intestinal rupture.
 - The small bowel is most common intra-abdominal organ involved on penetrating trauma (e.g. stab or gunshot wounds) followed by colorectal injury and duodenal and gastric perforations.
 - The intestinal wound may be situated at some distance from the external wound due to the compression and mobility of the intestines, and the depth of the wound is greater than the length of the penetrating object.

Pancreas: Wounds of the pancreas are very rare. The pancreas may be injured by compression forces usually where it overlies the second lumbar vertebra.

Spleen

- Most common organ to be injured in blunt abdominal trauma.⁴⁸
- Penetrating wounds of the spleen are less common than those of liver, but bleeding is more profuse. The spleen may be injured by forces of compression or traction forces. Compression forces produce lacerations. Traction forces may tear the spleen from its pedicle.
- The spleen is ruptured usually in its concave surface, and is generally associated with injuries to other organs and rib fractures. Lacerations are usually transcapsular and may occur at the hilar or convex surfaces. They are often multiple and may simulate the alphabetical figures, Y, H or L. Death from rupture of spleen is usually rapid due to profuse hemorrhage.
- A relatively mild trauma or even the contraction of the abdominal muscle may predispose the spleen to rupture, when it is diseased and enlarged, e.g. infectious mononucleosis, malaria, Kala Azar or leukemia.

Liver

It is the *second* most frequently damaged abdominal organ in blunt trauma. Most injuries occur on convex surfaces. The liver is commonly ruptured by motor accidents, blow, kick or by a sudden contraction of the abdominal muscles.

Blunt force to the abdomen may produce the following lacerations:

- Transcapsular laceration:* Both capsule and parenchyma are torn and the laceration is present over the convex surface of the liver. It may cause rapid death from hemorrhage and shock.
 - Subcapsular laceration:* Capsule is intact and injury is beneath the capsule or intraparenchymal, and present over the convex surface of the liver. It may rupture few days after the injury and cause fatal delayed intraperitoneal hemorrhage.
 - Non-communicating or central lacerations* are seen in the substance of the liver.
 - Coronal lacerations* are seen over the superior surface due to distortion.
 - Lacerations* of the inferior surface are due to distortion.
 - Contrecoup laceration* involve the posterior surface of the right lobe, at the point where it rests against the vertebral column.
- The right lobe is five times more commonly affected than the left.

- Convex surface and inferior border are more commonly involved.
- Mild degree of external violence may rupture the liver, if it is diseased, e.g. fatty change, abscess formation, malarial or bilharziasis.
- The liver is more susceptible than spleen to penetrating injury.⁴⁹

Complications of abdominal injuries

- Laceration of the liver produces slow, but considerable bleeding over a period of time.
- Laceration of the spleen produces rapid and profuse hemorrhage leading to hypotension.
- Peritonitis is more common in rupture of the large intestine than with rupture of the small intestine due to the presence of pathogenic organisms in the colon.
- Chemical peritonitis is caused by leakage of gastric contents or pancreatic juice into the peritoneal cavity.
- Multiple contusions of the intestines may produce paralytic ileus.

Kidneys

Injuries to the kidneys are uncommon as they are situated in relatively well-protected part of the body. Contusions and lacerations usually result from blunt force applied directly to the posterior or lateral aspect of the kidneys, such as blows to the loins or in motor vehicle accidents and fall from a height.

- Lacerations of the kidneys may be transcapsular, subcapsular and transrenal (tear extending from the capsule to the renal pelvis). These may cause hemorrhage into the perinephric fat and form a large perirenal hematoma.
- Penetrating wounds are produced by bullets or pointed weapons, usually through the loin, and other viscera are also injured with retroperitoneal hemorrhage.
- The complications may be sepsis and the extravasation of urine into the surrounding tissues with the development of urinary fistula.

Bladder

The bladder may be lacerated from a fall, a kick or a blow on the abdomen.

Ruptures are of two types:

- Extraperitoneal:** It occurs when the bladder is empty or contains little urine and lies within the pelvis. It is usually associated with pelvic fractures. The urine may extravasate upwards to the level of the kidneys or downwards along the spermatic cord into the scrotum which may produce cellulitis and death.

- ii. **Intraperitoneal:** It occurs when the bladder is full of urine. Any blunt trauma to the lower abdominal wall can compress the bladder against the sacrum, resulting in rupture due to increased pressure with the urine entering the abdominal cavity.

Stab wounds of the lower abdomen may penetrate the bladder and cause rapid death from hemorrhage. There may be extraperitoneal extravasation of urine.

The male urethra may be ruptured usually under the pubic arch by a kick in the perineum, fall on a projecting substance, fracture of pubic bone or a foreign body. Forcible catheterization or cystoscopy, especially in the presence of some obstruction can cause rupture of urethra from within.

Reproductive Organs

Female genital organs: Contusions and lacerations of the vulva and vagina may be due to kicks during assault or fall on a projecting substance. Wounds of vulva caused by a blunt weapon may resemble incised wounds. Lacerated wounds of the vulva may bleed profusely.

- The non-gravid uterus is usually not injured.
- The gravid uterus may be ruptured by a blow or kick on the abdominal wall, by instrumental criminal abortion, or in obstructed labor. Placenta may separate from uterus causing death of fetus.

Male genital organs

- The penis may be injured by a squeeze or crush, and the engorged erected penis may be completely avulsed from the pubes by forceful pull.
- Accidental injuries are rare, but the penis may be injured or amputated in revenge.
- Penile strangulation may occur by application of a constricting apparatus around the penis.
- Compression or crushing of the testes may cause sudden death from cardiac inhibition.

Bones and Joints

Fractures may occur from falls, blows or by muscular hyperactivity.

- In **simple or closed fracture:** There is no communication between the bone and the air. A fall on the outstretched hand will cause Colles fracture (fracture of the distal end of radius).
- In **compound or open fracture:** There is a communication between the bone and the air through a wound.
- **Comminuted fractures:** The bone breaks into fragments which may impact into each other or separate and become displaced.
- **Partial or green-stick fractures:** These occur because bones in children are very flexible and bend or partially

break, instead of breaking cleanly when overloaded. There may be discontinuity in one cortex of the bone, but not in the other.⁵⁰

- In childhood, slipping of an epiphysis is common, e.g. in distal end of the radius, internal epicondyle of the humerus, capitulum and distal end of the tibia.
- Fracture at the neck of the fifth metacarpal bone occurs, usually by striking the closed hand (fist) against a firm surface (**boxer's/brawler's fracture**).⁵¹

- Fractures of the mandible, maxilla, zygoma and zygomatic arch are produced by assaults and motor vehicle accidents.
- The frequency of fracture of different parts of mandible in decreasing order is: condyle (36%), body (21%), angle (20%), parasymphiseal (14%), alveolar (3%), ramus (3%), coronoid (2%) and symphysis (1%).⁵²
- Maxillary fractures can be divided into five categories.⁵³
 - Dentoalveolar:* Separation of fragment of mandible containing number of teeth.
 - LeFort I:* Transverse fracture of maxilla, above the apices of the teeth, through nasal septum and maxillary sinuses, the palatine bone and the sphenoid bone.
 - LeFort II:* Fracture has same track posteriorly, anteriorly it curves upwards near the zygomatic-maxillary suture, through the inferior orbit rim onto the orbital floor, across the nasal bones and septum.
 - LeFort III:* High transverse fracture of the maxilla that goes through the nasofrontal suture, through the medial orbital wall and fronto-zygomatic suture, across the arch and through the sphenoid.
 - Sagittal:* Fracture line runs through a sagittal plane through the maxilla.

Fracture of the extremities caused by **direct application of force** (Fig. 13.12):

- Penetrating fractures* are caused by large force acting on a small area; seen in gunshot wounds.
- Focal fractures* are *transverse* fractures results from a small force applied over a small area. It is usually seen in the forearms produced by weapons, like rods, when the person tries to ward off blows. Overlying soft tissue injury is relatively minor.
- Crush fractures* result from large force applied over a large area with extensive soft tissue injuries and often *comminuted fractures* of the bone. Mostly seen on the legs in motor vehicle-pedestrian accidents.

Indirect fractures result from a force acting at a distance from the site of fracture, e.g. a fracture of the head of the radius or of the lower end of the humerus caused by a fall on the extended palm.

It is classified into (Fig. 13.12):

- Avulsion or distraction fracture:* In this, the bone is pulled apart by traction, e.g. transverse fracture of

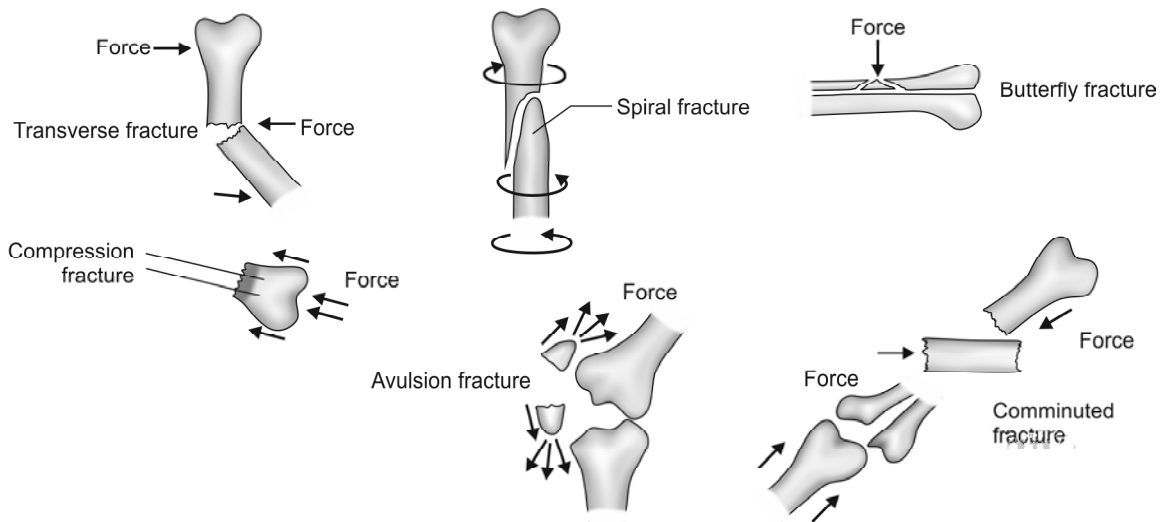

Fig. 13.12: Classification of fracture

patella due to violent contraction of the quadriceps muscle.

- ii. *Spiral fracture*: The bone is twisted and a spiral fracture is produced. It occurs only when the bone is subjected to torsional force.
- iii. *Vertical compression fracture* produce an oblique fracture of the body of long bones with the hard shaft driven into the cancellous end.
- iv. *In angulation and compression fracture*, the fracture line is oblique.
- v. *Angulation, rotation and compression fracture* causes fracture with a triangular butterfly fragment.

Pelvic fractures

Classified by the direction of force:

- i. Anterior-posterior compression
- ii. Lateral compression
- iii. Shear
- iv. Complex fractures

Healing of Fracture

- Fractures of cancellous bone unite faster than those of cortical bone.
- In children, a callus (osteogenic granulation tissue) is visible on X-ray within 2 weeks of fracture and the bone is consolidated in 4-6 weeks, though it takes 2-3 months to solidify. In adults, callus formation is visible on X-ray by about 3 weeks, consolidation takes about 3 months, and for femur it may take 4-5 months.
- *Histologically*, signs of clot organization is seen in about 48 h, the formation of osteoid matrix in about 3 days and formation of soft callus by about 1 week.

- In comminuted fractures where edges are not in apposition, bone formation does not occur. The gap is filled by fibrous tissue in 1-3 months depending on the size of the gap. The fracture line remains permanently visible on X-ray.
- Age of skull fracture can be estimated as given in Table 13.7.
- In case of fracture of the skull, healing occurs without formation of a visible callus because the injured periosteal vessels impede the formation of an external callus.
- In case of tooth being knocked out, age is estimated as given in Table 13.8.

Table 13.7: Estimation of age of skull fractures

Features	Age (weeks)
Edges stick together	1
Calcification of inner table and rounding of sharp edges	2
Bands of osseous tissue running across	3-4

Table 13.8: Estimation of age of tooth dislocation

Features	Age
Bleeding stops from its socket, edges sharp and feathered	1-2 days
Clot obliterated by fibrous tissue	14 days
Socket completely filled with new bone (as seen on X-ray)	1 year

Complications of fracture

- Shock
- Hemorrhage
- Infection
- Crush syndrome
- Fat embolism
- Venous thrombosis with pulmonary embolism

- Teeth most often affected by trauma in order of decreased frequency: Maxillary central incisors (60%), maxillary lateral incisors (22%), mandibular central incisors and mandibular lateral incisors.
- In permanent dentition, tooth fractures result from trauma whereas dislocation is common in primary dentition (due to elastic structures of the alveolar process).

At autopsy, a fracture may be suspected when there is extensive swelling and discoloration of the skin, or when there is abnormal mobility or crepitus is found. The tissues surrounding a suspected fracture should be dissected to determine injuries to the soft parts.

Antemortem or Postmortem Fracture

- Fracture produced just before death or just after death will have similar characteristics, except in the former there may be comparatively greater effusion of blood which will infiltrate the surrounding tissues.
- Antemortem fracture few hours prior to death will show edema and active cellular infiltration into the adjacent tissues and between the fractured edges of the bones.
- Antemortem fracture of long bones may result in fat emboli traveling to distant parts of the body producing characteristic lesions (punctate hemorrhages in skin, eyelids, conjunctiva) which are seen grossly and microscopically.

These changes are *not seen* in postmortem fractures.

MULTIPLE CHOICE QUESTIONS

1. **NOT a type of skull fracture:** *NIMHANS 08*
 A. Linear B. Depressed
 C. Diffuse axonal D. Basal
2. **Fracture-a-la signature is:** *AIIMS 06; AI 11*
 A. Gutter fracture B. Depressed fracture
 C. Ring fracture D. Sutural separation
3. **Depressed fracture of skull result from blows with:** *UP 04*
 A. Heavy object with small striking surface
 B. Blunt trauma to large surface area
 C. Heavy object with large striking surface
 D. Light object with small striking surface
4. **Pond's fractures are common in:** *AP 09*
 A. Children B. Adolescent
 C. Adult D. Old age
5. **Orbital blow out fracture involves:** *AIIMS 09; FMGE 10; MP 10; JIPMER 11; Bihar 11; PGI 11*
 A. Lateral wall and floor of orbit
 B. Medial wall and floor of orbit
 C. Lateral wall and roof of orbit
 D. Medial wall and roof of orbit
6. **Teardrop sign is seen in:** *Kerala 08; JIPMER 08; Maharashtra 09*
 A. Fracture medial wall of orbit
 B. Fracture lateral wall of orbit
 C. Fracture floor of orbit
 D. Fracture roof of orbit
7. **Roof of orbit is fractured due to:** *AIIMS 09*
 A. Blow on forehead B. Blow on lower jaw
 C. Fall on back D. Blow in parietal region
8. **CSF rhinorrhea is due to fracture of:** *UP 08, 09; DNB 10; Bihar 10; AIIMS 10*
 A. Cribriform plate B. Sella turcica
 C. Petrous temporal bone D. Mastoid
9. **Characteristic of anterior cranial fossa fracture:** *WB 07*
 A. Black eye B. Pupillary dilatation
 C. CSF otorrhea D. Hemotympanum
10. **True about CSF rhinorrhea:** *PGI 03; UP 09*
 A. Commonly occurs due to break in cribriform plate
 B. Contains less amount of proteins
 C. Decreased glucose content confirms diagnosis
 D. Immediate surgery is required
11. **CSF otorrhea is caused by:** *Bihar 10; WB 11*
 A. Fracture of cribriform plate
 B. Fracture of parietal bone
 C. Fracture of petrous temporal bone
 D. Fracture of tympanic membrane
12. **CSF rhinorrhea is diagnosed by:** *MP 07*
 A. Glucose estimation B. Halo sign
 C. Immunoelectrophoresis D. All
13. **Specific for CSF in rhinorrhea:** *AI 10*
 A. b-2 microglobulin B. Albumin
 C. Macroglobulin D. b-2 transferrin

1. C 2. B 3. A 4. A 5. B 6. C 7. C 8. A 9. A
 10. A 11. C 12. D 13. D

14. **Battle's sign is:** *TN 11*
 A. Hemorrhage around eyes
 B. Mastoid ecchymosis
 C. Umbilical ecchymosis
 D. Vaginal ecchymosis
15. **Best prognostic indicator for head injured patients:** *AIIMS 10*
 A. GCS
 B. CT findings
 C. Age of the patient
 D. History
16. **Primary impact injury to brain:** *DNB 10*
 A. Concussion
 B. Cerebral edema
 C. Hypoxic injury
 D. Intracerebral hematoma
17. **Secondary brain injury is:** *JIPMER 10*
 A. Concussion
 B. Diffuse axonal surgery
 C. Depressed skull fracture
 D. Intracerebral hematoma
18. **Concussion causes:** *Karnataka 07*
 A. Small hemorrhages and swelling of brain tissues
 B. Momentary interruption of brain function with/without loss of consciousness
 C. Tearing or shearing of brain structures
 D. Bruising of the brain
19. **Antegrade amnesia is seen in:** *AIIMS 10*
 A. Post-traumatic head injury
 B. Drug induced
 C. Electroconvulsive therapy
 D. Stroke
20. **Shearing damage is seen in:** *CMC (Vellore) 07*
 A. Heart
 B. Liver
 C. Brain
 D. Spinal cord
21. **Diffuse axonal injury is characterized by lesion at:** *AI 08; FMGE 11*
 A. Junction of gray and white matter
 B. White matter
 C. Basal ganglia
 D. Corpus callosum
22. **A male was brought unconscious with external injuries. CT brain showed no midline shift, but basal cistern were compressed with multiple small hemorrhages. Diagnosis is:** *AIIMS 06*
 A. Cerebral contusion
 B. Cerebral laceration
 C. Multiple infarcts
 D. Diffuse axonal injuries
23. **'Retraction balls' after trauma are seen in:** *PGI 08, 11*
 A. Brain
 B. Spleen
 C. Liver
 D. Lung
24. **Apoplexy is:** *DNB 08*
 A. Learning disability
 B. Insanity leading to commitment of a crime
 C. Sudden onset of bleeding in the brain
 D. Injury to the brain due to trauma
25. **Brain hemorrhage limited by sutures:** *BHU 09; Punjab 12*
 A. EDH
 B. SAH
 C. SDH
 D. ICH
26. **Commonest source of extradural hemorrhage:** *UP 09*
 A. Middle meningeal artery
 B. Basilar artery
 C. Charcot's artery
 D. Middle cerebral artery
27. **Middle meningeal artery is a direct branch of:** *AI 06; Orissa 09; Punjab 12*
 A. External carotid artery
 B. Internal maxillary artery
 C. Superficial temporal artery
 D. Middle cerebral artery
28. **Artery usually torn in temporal bone fracture is:** *Orissa 11*
 A. Middle meningeal artery
 B. Posterior auricular artery
 C. Transverse facial artery
 D. Deep temporal artery
29. **Most common manifestation of increased intracranial pressure in a patient with head injury:** *UPSC 07*
 A. Change in the level of consciousness
 B. Ipsilateral pupillary dilatation
 C. Retching and vomiting
 D. Bradycardia
30. **The following are the clinical features of raised intracranial tension, except:** *UPSC 03*
 A. Headache
 B. Insomnia
 C. Bradycardia
 D. Papilloedema
31. **A rugby player hit his head on the post whilst involved in a tackle. He was unconscious for 5 min but regained full consciousness and sat on the sideline until the end of the game. He was then noted to be drowsy and over the past 30 min became confused and no longer obeyed commands. Most likely diagnosis is:** *Himachal 10*
 A. Extradural hematoma
 B. Subdural hematoma
 C. Subarachnoid hematoma
 D. Cerebral edema
32. **Lucid interval is classically seen in:** *COMEDK 07; PGI 07; Kerala 08; WB 09; FMGE 10; DNB 10*
 A. Intracerebral hematoma
 B. Acute subdural hematoma
 C. Chronic subdural hematoma
 D. Extradural hematoma

-
14. B 15. A 16. A 17. D 18. B 19. A 20. C 21. A 22. D
 23. A 24. C 25. A 26. A 27. B 28. A 29. A 30. B 31. A
 32. D

33. Subdural hemorrhage is due to rupture of:
AIIMS 04; UP 05; Bihar 11
- Middle meningeal artery
 - Dural venous sinus
 - Cortical bridging veins
 - Rupture of intracranial aneurysms
34. A 14 year-old boy was hit on the side of the head with a baseball bat during practice. A laceration with palpable bone fragment was found in the wound. After 5 h the boy died. Most likely cause of death is:
Himachal 10
- Subarachnoid hemorrhage
 - Epidural hemorrhage
 - Subdural hemorrhage
 - Intracranial hemorrhage
35. CT of subdural hematoma will show:
Orissa 09; NIMHANS 11
- Biconvex hyperdense opacity
 - Biconcave hyperdense opacity
 - Concavoconvex opacity
 - Hyperdense diffuse lesion
36. Circle of Willis is *not* formed by: *TN 11*
- Anterior choroidal artery
 - Anterior cerebral artery
 - Posterior cerebral artery
 - Anterior communicating artery
37. A female presented with severe headache of sudden onset. On CT scan, a diagnosis of subarachnoid hemorrhage is made. Most common cause is:
AI 06; UP 10
- Hypertension
 - Berry aneurysm rupture
 - Basilar artery rupture
 - Subdural venous sinuses rupture
38. A 40-year-old lady is brought to the emergency room after being unresponsive following a sudden bout of severe headache at work. O/E her BP is 180/100 mm Hg and her respiration is irregular and of Cheyne-Stokes type. She is agitated and doesn't follow commands, but moves her extremities spontaneously. Most likely diagnosis will be:
Karnataka 03; JIPMER 08
- Subarachnoid hemorrhage due to rupture cerebral aneurysm
 - Hypoglycemic coma
 - Conversion reaction
 - Addisonian crisis
39. A 45-year-old hypertensive male patient presented in the casualty with two hours history of sudden onset of severe headache associated with nausea and vomiting. On clinical examination, the patient had neck stiffness and right sided ptosis. Rest of the neurological examination was normal. Diagnosis is: *AIIMS 03*
- Hypertensive brain hemorrhage
 - Migraine
 - Aneurysmal subarachnoid hemorrhage
 - Arteriovenous malformation rupture
40. Investigation of choice in SAH:
NIMHANS 07; FMGE 11
- CT scan
 - MRI
 - X-ray skull
 - Radionuclide scan
41. Cause of Berry aneurysm: *AIIMS 11*
- Degeneration of internal elastic lamina
 - Degeneration of media/muscle cell layer
 - Deposition of mucoid material in media
 - Low grade inflammation of vessel wall
42. Commonest cause of thunderclap headache:
AIIMS 10
- Extradural hemorrhage
 - Aneurysmal SAH
 - Subdural hemorrhage
 - Basilar migraine
43. Traumatic bleeding may include all, *except*: *Kerala 09*
- EDH
 - SDH
 - SAH
 - ICH
44. Most common location of hypertensive intracranial hemorrhage is: *AI 06; NIMHANS 08; DNB 10; WB 11*
- Subarachnoid space
 - Basal ganglia
 - Cerebellum
 - Brainstem
45. NOT true about Berry aneurysms: *AP 08*
- Rupture leading to SAH
 - Most common in posterior circulation
 - Developmental anomaly
 - Common in anterior circulation
46. Duret hemorrhages are found in:
PGI 08, 10, 11; Kerala 11
- Brain
 - Heart
 - Kidney
 - Liver
47. 'Whip-lash' injury is caused due to:
AIIMS 03, 06; Karnataka 07
- Fall from a height
 - Acute hyperextension of the spine
 - Blow on top to head
 - Acute hyperflexion of the spine
48. Most common organ injured in blunt trauma to the abdomen is: *UP 04*
- Liver
 - Spleen
 - Pancreas
 - Intestine
49. Most common organ injured in penetrating injury of the abdomen: *AFMC 10*
- Liver
 - Spleen
 - Stomach
 - Small intestine

33. C	34. C	35. C	36. A	37. B	38. A	39. C	40. A	41. B
42. B	43. D	44. B	45. B	46. A	47. B	48. B	49. A	

50. **A green-stick fracture is:**
TN 06; UPSC 07; BHU 09; NIMHANS 10
- A. Seen mostly in the elderly
 - B. Fatigue fracture
 - C. Spiral fracture of long bone
 - D. Part of cortex is intact and part is crumpled
51. **Boxer's fracture is:** *MP 11*
- A. Fracture of first metacarpal base
 - B. Fracture of fifth metacarpal neck
 - C. Fracture of third metacarpal neck
 - D. Fracture of first metacarpal neck
52. **Most common site for fracture mandible:** *TN 11*
- A. Condyle
 - B. Angle
 - C. Body
 - D. Symphysis
53. **LeFort's fracture would include all of the following, except:** *Manipal 03, 10; WB 09; TN 09; Bihar 10*
- A. Maxilla
 - B. Mandible
 - C. Zygoma
 - D. Nasal bones

Thermal Injuries

14

Definition: Tissue injury due to application of heat or cold in any form to the external or the internal body surfaces.

Classification: Refer to Flow chart 14.1.

Cold Injury

Hypothermia

- Exposure to cold produce hypothermia which is defined as core temperature below 35°C (95°F).
- An esophageal or rectal probe that measures temperatures as low as 25°C is required; oral or axillary thermometers are inaccurate.
- Risk factors:
 - Low environmental temperature
 - Extremes of age (infants, children and elderly ≥ 60 years)
 - Immersion in water and wet clothing
 - Pre-existing diseases, such as hypothyroidism and atherosclerosis, dementia, inadequate nutrition
 - Intoxicated persons (alcohol, tranquilizers or opiates) and persons engaged in activities like mountaineering and sailing

Effects of hypothermia

- Direct effects are prominent in fatty tissues and myelinated nerve fibres.
- Indirect effects are mostly ischemic.

Clinical features

- When the temperature falls below 32°C to 24°C, there is disorientation, dulling of consciousness, loss of reflex, and fall in respiration, heart rate and blood pressure.
- Red patches and pallor of the skin, edema of the face, and stiffness of neck muscles may be seen. Death is common due to ventricular fibrillation or asystole.

Complications: Patient who survives for a short time may develop hemorrhagic pancreatitis, pneumonia, ulcers or focal hemorrhages in the GIT, acute tubular necrosis and myocardial fibre necrosis.

Postmortem findings: There are no definitive autopsy findings of hypothermia. However, there are several features which taken together and in the presence of history (scene and circumstances) allow a reasonably confident diagnosis.

Flow chart 14.1: Classification of thermal injuries

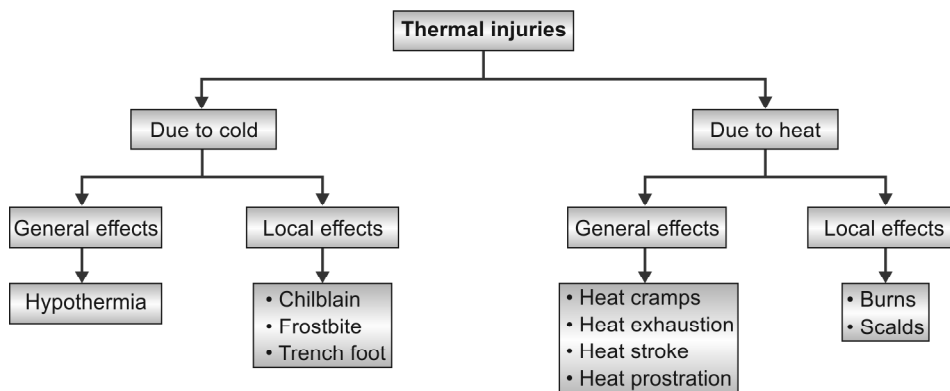

- Moreover, the autopsy is helpful to rule out other causes of death, collect evidence as necessary and contribute to the identification process.
- Viscera should be sent for blood alcohol and toxicological analysis.

External

- Patches of pink to brownish-pink discoloration may be seen on the external surface, most often present over the extensor surfaces of large joints (usually on knees, elbows or outside of the hip joint).
- Postmortem staining is pink/bright red due to antemortem binding of oxygen to hemoglobin and its postmortem diffusion through skin.
- The extremities may be cyanosed or white (*white deaths*).
- Edema of feet and blistering of skin may be seen.

Internal

- *Blood*: Bright red in color.
- *Trachea*: Frothy and sanguineous fluid.
- *Lungs*: Congested, edematous and shows hemorrhages.
- *Heart*: Dilatation of right atrium and ventricle.
- *Stomach*: Wischnewsky spots* may be seen.
- *Kidneys*: Acute tubular necrosis with accumulation of lipid in epithelial cells of proximal renal tubules.
- *Liver and spleen*: Congested. Fatty changes in liver and contracted spleen.
- *Muscles*: Hemorrhages into core muscles like iliopsoas.
- *Pancreas*: Hemorrhages in parenchyma and mucosa of the pancreatic duct.
- *Intestines*: Ulceration of the colon and ileum, and hemorrhages infarction of the colon.

- **Paradoxical undressing**: In deaths due to hypothermia, the body is found either partially or fully undressed. During hypothermia, the victim becomes disoriented, confused, and combative, and may begin discarding the clothing he/she has been wearing, which in turn increases the rate of temperature loss. This sometimes results in the assumption that the deaths are associated with sexual assault (homicide).¹
- **'Hide and die' syndrome**: In some hypothermic deaths, bodies are found in some strange places—under a bed or bench, on a shelf or behind a wardrobe, or alternatively may pull down household articles into a heap on top which may give the impression of their attempt to 'hide' (protective 'burrow-like' or 'cave-like' situation). This may also lead to the assumption of a homicide or robbery. It is due to mental confusion from hypothermia and may be related to hibernation reflex.

Cold or freezing temperature can produce localized effects, e.g. chilblain, trench foot/immersion foot, and frostbite which are phases of the same process.

Chilblain (Erythema Pernio)

These are red, itching, skin lesions, usually in the extremities, caused by exposure to cold. They may be associated with edema and blistering and are aggravated by warmth. On continued exposure, ulcerative or hemorrhagic lesions may develop.

Treatment: Elevation of the affected part and allowing it to warm gradually at room temperature. The areas should not be rubbed or massaged or subjected to heat application.

Immersion Syndrome (Trench/Immersion Foot)

Immersion foot, trench foot and trench hand are types of immersion syndrome injuries. Immersion foot/hand results from prolonged exposure to severe cold (< 10°C) and dampness; seen in soldiers during warfare, especially in trenches, and in persons exposed to prolonged immersion or exposure at sea. Extremities are affected in these conditions.

Clinically, it is divided into:

- Pre-hyperemic stage:** The affected parts are cold and anesthetic.
- Hyperemic stage:** The parts are hot with intense burning and shooting pains.
- Post-hyperemic stage:** Area is pale or cyanotic with diminished pulsations.

Treatment: Air drying, protecting the extremities from trauma and secondary infection, and gradual rewarming by exposure to air at room temperature (not ice or heat) without massaging or moistening the skin or immersing it in water.

Frostbite

- Frostbite (congelatio) is injury due to freezing and formation of ice crystals and obstruction of blood supply within tissues. It occurs due to exposure to great extremes of cold (−2.5°C).
- This is typically evident as blue-black discoloration of fingers, toes or other susceptible body parts such as the nose, ears and face (Fig. 14.1).
- In **mild** cases, only the skin and subcutaneous tissues are involved, and symptoms are numbness, prickling and itching.
- **Deep** frostbite involves deeper structures and there may be paresthesia and stiffness. Thawing causes

* Wischnewsky spots are blackish-brownish color gastric mucosal erosions/ulcerations seen in hypothermia (vary from 1 mm to 2 cm in size and from few to > 100). Similar changes are seen in drug/alcohol abuse and in stress/shock.

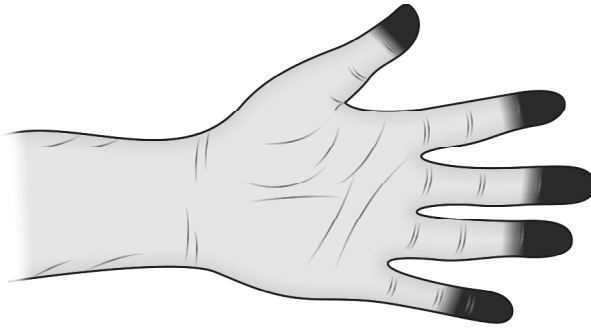

Fig. 14.1: Frostbite of fingers

tenderness and burning pain. The skin is white or yellow, loses its elasticity and becomes immobile. Edema, blisters, necrosis and gangrene may appear beyond the line of inflammatory demarcation.

- *Microscopically*, there might be a damage of endothelial cells, leakage of serum into the tissues and sludging of RBCs.
- Frostbite is only produced during life and cannot be caused postmortem.

Treatment

- Rewarming:** For superficial frostbite (frostnip): Firm steady pressure is applied with warm hand (without rubbing), by placing fingers in the armpits and for the feet, by covering with dry socks. For deep frostbite: Frozen extremity is immersed for several minutes in a moving water bath, heated to 40-42°C, until the distal tip of the part being thawed, flushes.
- Protection of the part:** Pressure or friction is avoided and physical therapy contraindicated in the early stage.
- Anti-infective measures:** Tetanus prophylaxis and antibiotics for deep infection are given.

Heat Injury

Heat Cramps (Miner's/Stoker's/Fireman's Cramps)

- They are due to fluid and electrolyte depletion.
- It usually occurs in workers in high temperature when sweating has been profuse.
- Cramping results from dilutional hyponatremia, as sweat losses are replaced with water alone.²
- There is a history of vigorous activity just preceding the onset of symptoms.

Clinical features

Onset is sudden.

- Severe and painful paroxysmal skeletal muscle contractions ('cramps') and severe muscle spasms

lasting 1-3 min, usually of the muscles most used (arms, legs and abdomen) occur. Involved muscle groups are tender, hard and lumpy.

- Face is flushed, pupils dilated and patient complains of dizziness, tinnitus, headache and vomiting.
- Skin is moist and cool.
- Body temperature may be normal or slightly increased.

Treatment: Patient should be moved into a cool environment and given oral saline solution to replace both salt and water, and advised rest for 1-3 days.

Heat Exhaustion

- It results from prolonged strenuous activity with inadequate water or salt intake in a hot environment and is characterized by dehydration, sodium depletion or isotonic fluid loss with accompanying cardiovascular changes.
- Symptoms associated with heat syncope and heat cramps may be present.

Clinical features

Nausea, vomiting, malaise and myalgia may occur. The patient may be quite thirsty and weak with CNS symptoms, such as headache, dizziness, fatigue, and in cases due chiefly to water depletion, anxiety, paresthesias, impaired judgment, hysteria and occasionally psychosis.

Heat exhaustion may progress to heat stroke, if sweating ceases.

Diagnosis: Prolonged symptoms, rectal temperature > 37.8°C, increased pulse (150% of the patient's normal) and moist skin.

Treatment: Patient is treated in a cool environment, adequate hydration (1-2 litres over 2-4 h), oral salt replenishment and active cooling (fans, ice packs), if necessary. Normal saline or isotonic glucose solution should be administered IV, if necessary.

Heat Hyperpyrexia or Heat Stroke

- Heat stroke a life-threatening medical emergency resulting from failure of the thermoregulatory mechanism.
- It is characterized by cerebral dysfunction with impaired consciousness, high fever [core (rectal) temperature $\geq 41^\circ\text{C}$ ($\geq 105^\circ\text{F}$)] and absence of sweating.³
- The term *thermic fever or sun stroke* is used when there has been direct exposure to the sun.
- It presents in one of the two forms:
 - Classic:** Seen in patients with compromised homeostatic mechanisms.

- ii. **Exertional:** Seen in healthy persons undergoing strenuous exertion in a thermally stressful environment.

Predisposing factors

- *Environmental causes:* High temperature, increased humidity, lack of acclimatization and physical exertion.
- *Non-environmental causes:* Extremes of age (infants and elderly ≥ 65 years), obesity, alcoholism, brain hemorrhage, malignant hyperthermia syndrome, chronically infirm, underlying medical conditions like thyrotoxicosis and sepsis, salicylate overdose, patients receiving medications like anticholinergics, antihistaminics and phenothiazines, and reactions to certain drugs of abuse such as cocaine.

Clinical Features (Fig. 14.2)

Onset is sudden with sudden collapse and loss of consciousness.

- *Prodromal symptoms* include dizziness, weakness, nausea, vomiting, confusion, faintness, staggering gait, purposeless movements, disorientation, drowsiness and irrational behavior.
- Skin is hot, and initially covered with perspiration, later it dries. Pulse is strong initially.
- Tachycardia and hyperventilation (with subsequent respiratory alkalosis) occur.
- Blood pressure may be elevated in early stages, but later hypotension develops.
- The core temperature is usually $> 40^{\circ}\text{C}$.
- Pupils are contracted.
- Delirium, blurred vision, convulsions, collapse and unconsciousness occur.

Morbidity or even death can result from cerebral, cardiovascular, hepatic or renal damage.

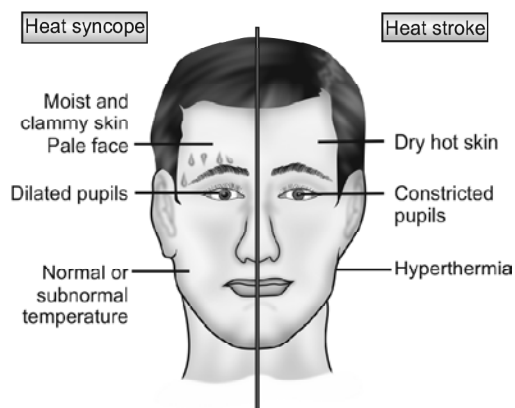

Fig. 14.2: Difference between heat syncope and heat stroke

Treatment

Immediate measures should be taken to lower the core temperature.

- The patient is unclothed to the minimum and sprayed with water (20°C) while air is passed across the patient's body. Immersion in an ice-water bath is very effective. Treatment should be continued until the rectal temperature drops to 39°C .
- Chlorpromazine (25-50 mg IV) or diazepam (5-10 mg IV) given every 4 hourly to control shivering.
- Fluid administration to ensure high urinary output (> 50 ml/h), mannitol administration (0.25 mg/kg) and alkalinization of urine (IV bicarbonate administration, 250 ml of 4%) are recommended.

Complications: Patients who survive > 24 h may show lobar pneumonia, acute tubular necrosis of kidneys, hepatic necrosis, myocardial fibre necrosis, disseminated intravascular coagulation, adrenal hemorrhage and myoglobinuria (due to rhabdomyolysis).⁴

Postmortem Findings

Deaths related to hyperthermia have no specific autopsy findings. When the body temperature is not available, but the circumstances of the death suggest hyperthermia, then it can be listed as the cause of death.

- Lungs:** Congested. Intrathoracic petechiae may be present, particularly in infants and children.
- Heart:** Subendocardial hemorrhages may be seen.
- Brain:** Congested and edematous. Convulsions are flattened and scattered patches are found in the walls of the third ventricle and floor of the fourth ventricle.

In *brain*, non-specific degenerative changes in cortical neurons may be visible in light microscopy in individual who survives for some period. There may also be marked changes in the cerebellum, including necrosis of Purkinje cells (which appear dense, red and eosinophilic) and a marked decrease in the number of Purkinje cells.

Medico-legal aspects: Deaths are usually accidental. Postmortem is done to rule out any other cause of death or contributory cause of death.

Heat Prostration (Heat Syncope/Collapse)

- It results from salt depletion and dehydration due to excess of sweating and cutaneous vasodilation with consequent systemic and cerebral hypotension, but without any rise of temperature, despite exposure to excessive heat.
- The condition is usually seen in the tropics and in the deserts.

- **Precipitating factors** are overexertion, heavy muscular work and use of unsuitable clothing.

Clinical features (Fig. 14.2)

- Patient suddenly feels weak, giddy and sick.
- Nausea, dizziness, flushing of face, throbbing headache in temples, dimness of vision may occur.
- Face is pale, pulse is weak and feeble, respiration sighing, skin cool and moist, and temperature sub-normal.
- Systolic BP is usually < 100 mm Hg.

Patient usually recovers and consciousness is never lost.

Treatment consists of rest and recumbency in a cool place and rehydration by mouth (or IV, if necessary).

Burns

Definition: Burn is an injury caused by heat or by a chemical or physical agent having an effect similar to heat.

Characteristics/Types of Burns

- Contact burns:* There is physical contact between the body and a hot object, like heated solid or molten metal. When applied momentarily, it produces a blister with erythema corresponding to the shape and size of the agent.
- Flame burns:* There is actual contact of body with flame. It may produce vesication, singeing of the hair and blackening of the skin. Hair singed by flame becomes curled, twisted and blackish, breaks off or is totally destroyed. If kerosene oil or petrol is used, it will produce sooty blackening of the parts and have a characteristic odor.

Flash burns are a variant of flame burns which are due to initial ignition from flash fires (sudden ignition or explosion of gases or petrochemicals). All exposed surface is burnt uniformly.
- Scalds:* They are caused by contact with hot liquids, most commonly water and usually occur on exposed skin.
- Radiant heat burns:* They are caused by heat waves, a type of electromagnetic wave. There is no contact between the body and flame or hot surface. Initially, the skin appears erythematous and blistered, and later it is light brown and leathery.
- Ionizing radiation burns (X-rays, radium, UV rays):* It can be localized or may involve the whole body depending on radiation exposure. The burn varies from redness of skin to dermatitis with shedding of hair and epidermis and pigmentation of the surrounding skin. Fingernails may show degenerative changes and wart-like growth.

vi. *Chemical burns:* Classified into acids, alkalis and vesicants (blister forming). Characteristically, there are ulcerated patches, no blisters, hair is not singed and the red line of demarcation is absent. Sometimes, the burn shows distinct coloration and is usually uniform in character.

vii. *Electric and lightning burns.*

viii. *Microwave burns:* The waves create heat through molecular agitation. The greater the water content of a particular tissue, the greater the heat produced, e.g. muscle tends to be heated more than fat. Burns caused by microwave ovens tend to be indirect, like the person ingests liquid without realizing how hot it is. Medico-legal implications are rare.

- Most burns are produced by dry heat and result from contact with a flame or a heated solid object or exposure to radiant heat of an object.
- The majority of burns in children are scalds caused by accidents and most electrical and chemical injuries occur in adults.
- Cold and radiation are very rare cases of burns.

Classification

Burns can be classified in many ways, but two classifications are given in Table 14.1 (Fig. 14.3).

Other types of classification: *Heba's* (similar to Wilson's, but uses the symbol of degree); and *Evan's* which categorizes burns into superficial, partial and full thickness.

Presently, the classification used is:

- **First degree (superficial) burns** involve the epidermis only. Red/pink in color, blanches, painful to stimuli such as touch or pinprick and no blisters. Sunburn is the most common first degree burn seen in temperate countries. Healing occurs in 3-6 days with skin peeling and no residual scarring.⁵
- **Second degree (partial and deep partial) burns** involve the epidermis and variable depth of the underlying dermis. Deep red in color, blanches or slow blanching, very painful, blisters present, moist in appearance and may heal by scar formation in 3 weeks.⁶
- **Third degree (full thickness) burns** involve structures deeper to dermis. Waxy white, gray or charred and black in color, no blanching, painless (due to destruction of nerve endings), no blisters, dry or leathery appearance. Spontaneous regeneration of skin will not occur and such burns require skin grafting.^{7,8}

Table 14.1: Classification of burns

Degree of damage	Dupuytren's	Wilson's
Erythema	1°	Epidermal
Vesication with blister formation	2°	Epidermal
Destruction of superficial skin	3°	Dermo-epidermal
Destruction of whole skin including dermis	4°	Dermo-epidermal
Destruction of deep fascia, muscles	5°	Deep
Complete charring involving vessels, nerves and bones	6°	Deep

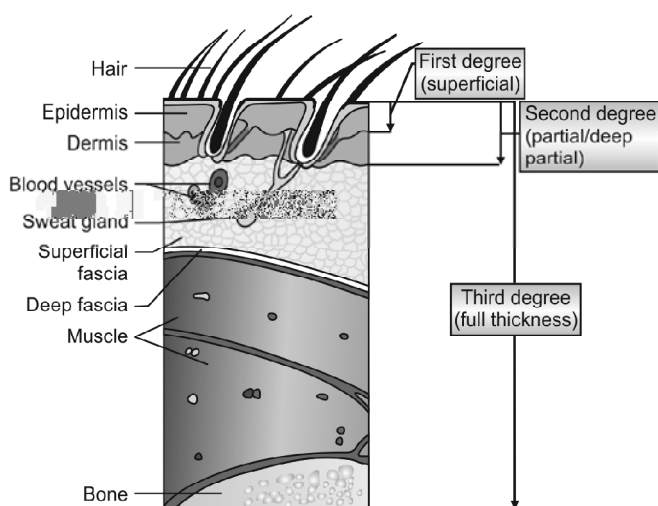
**Fig. 14.3:** Classification of burns (Wilson's)**Effect of Burns**

Effects will depend upon factors like:

- Degree of heat applied:** Effects are severe, if heat applied is very great.
- Duration of exposure:** More prolonged the exposure, more severe will be the effect as burning of human skin is temperature and time dependent. Indication of burn depth comes from history.
- Assessing the size** (extent of body surface affected): The total body surface area (TBSA) involved is usually worked out by the **Wallace Rule of Nine** wherein each upper limb is 9% of TBSA, 9% each for the front and back of lower limb, 9% for the front and back of chest, 9% for the front and back of abdomen, the head and neck 9% and 1% for the perineum (Fig. 14.4).⁹

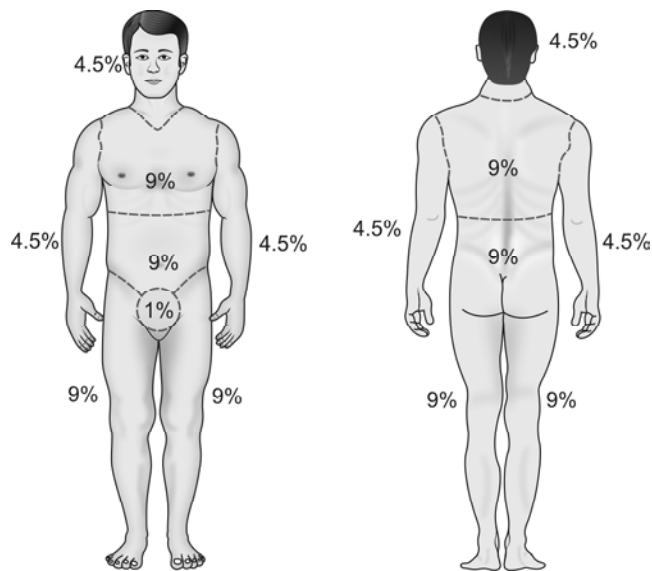
**Fig. 14.4:** Wallace rule of nine

- The patient's own hand is 1% TBSA and is a useful guide in small burns.¹⁰
- When burn surface involves 1/3rd of body surface area or more (usually 30-50%), the result is nearly always fatal.
- It is common error to underestimate the depth and to overestimate the extent.
- Estimation of the TBSA using the Wallace's Rule of Nine is not accurate in children because of the relatively larger head surface area. *Lund and Browder* described a method for compensating for the differences.
 - In children < 1 year, head is 18% of TBSA and each leg is 14% of TBSA.¹¹ Trunk and arms represent the same percentages as in adults.
 - For each year above 1 year old, add 0.5% to each leg and reduce 1.0% to the head until adult values are reached.¹²
- Site:** Burns of head and neck, chest and abdomen, especially anterior abdominal wall including genitals and perineum, even when superficial are more dangerous than deep burns involving the extremities or back.
- Age:** Children ≤ 2 years and elderly (> 60 years) are more susceptible ($\geq 20\%$ surface area involvement carries poor prognosis).
- Sex:** Women are more susceptible.
- History of natural disease or concomitant trauma, electrical injury or inhalation injury also results in poor outcome.

- **Fluid resuscitation:** In children with burns over 10% and in adults over 15% TBSA, IV fluids may be needed to prevent circulatory shock.^{13,14} Volume of fluid lost is directly proportional to the area of burn. If fluids are given orally, they should not be salt free. The key is to monitor urine output (50-60 ml/h).
 - The ideal fluid for resuscitation in burn is the one that restores plasma volume without any adverse effects. Isotonic crystalloids, hypertonic solutions and colloids have been used for this purpose, e.g. Ringer lactate (RL), plasma, human albumin solution, dextran and Hartmann's solution.¹⁵
 - Most commonly used fluid for burn resuscitation in UK is Hartmann's solution, and RL is mostly used in US and Canada.
 - Commonly used formulas:
 - **Parkland formula:** It calculates the fluid (Ringer lactate) to be given in the first 24 h (4 ml/kg/% burn for adults and 3 ml/kg/% burn for children). Half of this is given in the first 8 h and the second half in the next 16 h.^{16,17}
- TBSA (%) × Weight (kg) × 4 = Volume (ml) to be given
- **Muir and Barclay formula:** Amount of fluid that needs to be infused during the first 36 h. Initially, freeze-dried plasma and 5% dextrose were used which was replaced by human albumin solution (TBSA (%) × Weight (kg)/2 = Volume (ml) per period).¹⁸
 - **Brooke formula:** RL solution 1.5 ml/kg/% burn plus colloids 0.5 ml/kg/% burn plus 2000 ml glucose in water for initial 24 h.

Admission criteria for burn patients¹⁹

- Partial thickness burns involving > 10% of the TBSA (> 5% in children < 10 years and adults > 50 years).
- Full thickness burns involving > 2% of the TBSA in any age group or circumferential burns.
- Partial or full thickness burns involving the face, hands, feet, genitalia, perineum or major joints.
- Electrical burns, including lightning injury.
- Chemical burns or inhalation injury.
- Patients with preexisting medical disorders (e.g. diabetes), pregnancy or concomitant trauma (e.g. fractures).

Cause of Death

Burn individuals develop a host of complications; one or more can contribute to the cause of death. Following successful fluid resuscitation, sepsis became a leading cause of mortality.

Immediate cause

- Primary or neurogenic shock:* Due to pain or fright.
- Asphyxia:* Suffocation may result from inhalation of CO, CO₂, cyanide (produced by burning of materials containing nitrogen compounds such as

polyurethane in vinyl, wool or nylon) or falling of the building on the body during attempt to escape.

- CO poisoning is an important cause in most fire deaths (COHb ≥ 50% is confirmatory).
- iii. Smoke- or heat-induced laryngospasm, respiratory arrest, and/or a vagal reflex-caused cardiac arrest are other proposed mechanisms of rapid death.

Delayed cause

- Hypovolemic, burns or secondary shock:* More than half of the deaths occur due to secondary shock within 24-48 h due to loss of fluid and protein, causing decrease in cardiac output and multiorgan failure.²⁰
- Acute edema of glottis* occurs from inhalation of irritant smoke or hot gases with or without pulmonary edema. Respiratory failure (inhalation injury, pneumonia, ARDS) is also a significant cause of death within 3 days.
- iii. *Toxemia* due to absorption of toxic products from the burnt surface. Death occurs in about 3-4 days.
- iv. *Sepsis:* **Most important cause** of death, occurring in 4-5 days or longer after burn.²¹ Septicemia can be caused by burn wound infections (e.g. *Pseudomonas aeruginosa* and other Gram-negative bacteria, *Staphylococcus aureus*), pneumonia, urinary tract infection following catheterization, infected IV lines and infection of skin donor sites.
- v. *Infective complications:* Bronchitis, bronchopneumonia, enteritis may cause delayed death.

Remote cause

- Complications:* Anorexia, hematemesis, indigestion, respiratory complications or melena.
- Suppurative discharges* from infected burn areas lasting for weeks or months can result in disease of the internal organs and death.
- iii. Gangrene, tetanus, anemia, edema of dependant parts and jaundice.

Sequelae of burns: Scars, keloid, Marjolin's ulcer, Curling's ulcer, corneal capacity, obliteration of external auditory meatus, joint deformity or ankylosis can occur.

Postmortem Examination

An autopsy not only helps determine the cause of death, but also reveals findings unsuspected clinically. Before commencing with the autopsy, the following should be done:

- Photographic documentation.
- Clinical history is reviewed and information is obtained from other sources (e.g. police) depending on the circumstances of the death.

- X-ray to rule out any other trauma.
 - Any radio-opaque material such as bullets or lead shots may be detected.
 - Antemortem fracture may be found.
 - Sometimes, gunshot or stab wounds are often identifiable, although they may be shrunken to a small size.

External Findings

- i. **Clothing:** Should be carefully removed and examined for presence of kerosene, petrol or any other inflammable substance. Evidence of medical procedures (if any) is recorded including fasciotomies/escharotomies.
- ii. **Site, distribution and extent** of burning are recorded. Distribution is important in the analysis of whether the burns are appropriate for the position in which the body was found.
- iii. **Face:** Usually distorted, swollen. Tip of the tongue is usually burnt as it protrudes due to contraction of the tissues of the neck and face. Froth, often pink stained, may appear at the mouth and nose due to irritation of the air passages by smoke producing copious mucus in the airway as a result of acute pulmonary edema—a vital reaction.
 - There may be absence of burns and/or soot deposits in the corners of the eyes ('crow's feet') and incompletely singed eye-lashes, suggestive of squinting or closing of the eyes owing to smoke irritation.
 - In charred bodies, corneas acquire a white translucency and the lenses became opaque.
- iv. **Skin:** Owing to the effect of heat on blood, the veins stand out, giving a marbled appearance.
- v. **Postmortem staining** is cherry red in color from presence of carbon monoxide (CO), if the individual was alive and breathing during fire.
- vi. Kerosene oil burns gives characteristic odor and sooty blackening of the parts.
- vii. Antemortem burns will show redness (hyperemia)—a vital reaction.
- viii. **Blisters**, either ruptured/collapsed or filled with fluid may be seen. Blisters of a 2° may not be distinguished from blisters seen in:

- CO poisoning
- Antemortem/postmortem gasoline exposure
- Deep coma
- Peeling of skin in early putrefaction

- ix. **Degloving/destocking** may be seen due to cuticular peeling.
- x. **Hair:** It may be singed, or partially/completely burnt.
 - Gray hair becomes reddish or brown, but black hair stays black.
 - Singed hair looks curly/clubbed at its tip and is highly fragile.
 - *Cause of singeing:* Keratin of the hair shaft melt and resolidify.
 - *Sites where it can be seen:* Scalp hair, eye brows and eyelashes.
- xi. **Pugilistic attitude (boxing, fencing or defense attitude):** It is due to heat stiffening. The legs are flexed at the hips and knees, the arms are flexed at the elbows and held out in front of the body and the fingers are hooked like claws (Fig. 14.5).

Cause: Due to coagulation of proteins of muscles and dehydration which causes contraction.²² Flexor muscles being bulkier than extensor, contract more and a position of generalized flexion is adopted. It occurs *whether the person was alive or dead at the time of burning and has therefore no medico-legal significance.*²³

Extreme version of this phenomenon is reported in funeral pyres where the body may be seen to 'sit up' ('sit up and beg attitude') due to the intense action of the heat on the muscles during the open air cremation.

- xii. **Heat ruptures:** These are splits occurring in the skin due to contraction of the heated and coagulated tissue and the resultant breaches may simulate incised or lacerated wounds (Diff. 14.1). It is usually seen over the area of severe burning, over fleshy areas, like calves and thighs and over extensor surfaces and joints.

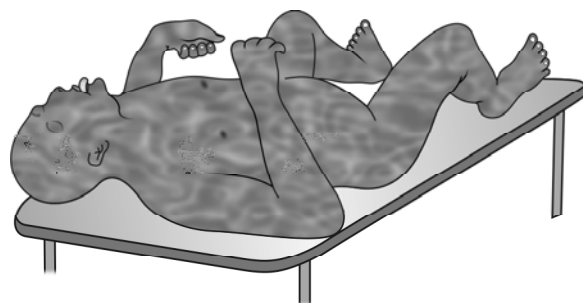

Fig. 14.5: Pugilistic attitude: Heat flexures of the limbs

Heat ruptures may be distinguished from the effects of violence by.^{24,25}

- Presence of nerves, blood vessels and connective tissue running across the split from side to side.
- There is no clotted blood in these fissures and no extravasation of blood in the surrounding tissues since heat coagulates the blood in the vessels.
- Presence of irregular margins.
- Absence of bruising or other signs of vital reaction in the margins.

Internal Findings

i. Skull

- **Heat hematoma** is an artefact and has the appearance of *extradural hematoma* (Diff. 14.2).
 - It is large, thick (about 1.5 cm) and contains 100-120 ml of blood.
 - *Cause:* The blood may come from the longitudinal venous sinuses or the diploic veins. The heat may force blood out of the marrow of the calvarium through veins and out over the surface of the dura.

Differentiation 14.1: Heat rupture and lacerated wound

S.No.	Feature	Heat rupture	Lacerated wound
1.	Cause	Exposure to heat	Blunt force
2.	Site	Fatty tissue	Anywhere
3.	Vessels and nerves	Intact	Torn
4.	Bruising around the margins	Absent	Present

- Skull bones may be fractured and burst open along the sutures due to intense heat.
- ii. **Brain:** Congested and appears swollen with widening and flattening of the gyri and obliteration of the sulci due to the contraction of the coagulating dura against the surface of the brain. Subdural hemorrhage may be present.
- iii. **Neck:** Hemorrhage in the root of the tongue and neck muscles—considered vital reactions in burn victims.
- iv. **Larynx, trachea and bronchioles:** Contain carbon and soot particles and the mucosa is congested with frothy mucus secretions. This is *suggestive of antemortem burns* due to inhalation of gases. However, soot usually disappears by the 2nd day of hospitalization.
 - Detachment of the mucosa of the tracheobronchial tree, pharynx, epiglottis or esophagus; and epiglottic swelling—indicators of vitality (air is a poor conductor of heat and thermal injury is usually limited to the upper airways).
- v. **Pleura:** Congested and inflamed with serous effusion.
- vi. **Lungs:** Congested and edematous, may be shrunken.
- vii. **Heart:** Chamber full of blood, cherry red in color due inhalation of CO.
- viii. **Stomach and intestines:** Stomach may contain carbon particles impregnated in mucous membrane. It may be red in color. There is inflammation and ulceration of Peyer's solitary glands of intestines. *Curling's ulcers* may be seen in severely burnt patient's gastric atrum and first part of duodenum

Differentiation 14.2: Epidural hematoma (EDH) due to burns and blunt force

S.No.	Feature	EDH due to burns	EDH due to blunt force
1.	Cause	Charring of the skull due to intense heat	Blunt force to the head
2.	Situation	Anywhere	Usually adjacent to sylvian fissure
3.	Position	Usually bilateral	Usually unilateral
4.	Distribution	Diffuse	Localized
5.	Characteristics ²⁶	Evenly distributed or sickle-shaped; honeycomb appearance; soft, granular, foamy, friable clot; chocolate brown color (pink, if CO is present)	Disk shaped; uniform, smooth, rubbery; reddish-purple color
6.	Skull fracture	Eggshell fracture—elliptical or circular defect without radiating fracture lines, seen above the temple	Fracture line radiating from a skull defect present in temporal area
7.	Crossing of suture lines	It may cross may cross suture and overlies the frontal, parietal and temporal area	Hematoma do not cross sutures as the dura is anchored at the suture lines
8.	Injury to CNS	Absent	May be present

after 72 h (3-10 days post-survival).²⁷⁻²⁹ It develops due to mucosal ischemia as a result of stress and shock, and not related to acidity.

- ix. **Spleen:** Enlarged and softened.
- x. **Liver:** Cloudy swelling and fatty liver or necrosis of the cells, if death is delayed. Jaundice may occur.
- xi. **Kidneys:** Show signs of nephritis, thrombosis and infarction.
- xii. **Adrenals:** May be enlarged and congested.
- The prolonged exposure of the body to high temperatures (results in vaporization of body fluids) along with the direct effect of the heat cause shriveling of the internal organs which became firm, hardened and cooked by heat—the so-called ‘puppet organs.’
- Samples of heart and femoral blood are collected in tubes containing sodium fluoride. Blood can be obtained even from a badly burnt body. If no blood is available, sections of the spleen or skeletal muscle may be used.

Heat artifacts

- Remnants of clothing around neck mimic ligature strangulation
- Pugilistic attitude
- Splitting of skin
- Fractures not associated with soft tissue hemorrhage (right-angled fractures of long bones—‘street and avenue fractures’)
- Bilateral epidural hemorrhage
- Shrunken, firm and light brown colored (‘cooked’) brain
- Introduction of soot into the trachea during incision of the charred neck at autopsy

Medico-legal Questions

Q. What is the identity of the deceased?

Identification is difficult when the body is completely burnt, however the following may be helpful:

- *Gender of the deceased:* It can be assessed by external and internal sexual characteristics. Prostrate and nulliparous uterus may not be burnt even at high temperatures.
- *Race:* Individuals from Afro-Caribbean origin have a dark gray deposit of melanin to the arachnoid of the medulla oblongata. Microscopic analysis of residual hair for melanin deposition and hair structure may be required.

- *Age:* It is usually established by teeth and ossification of bones.
- *Dental identification:* Dental charts should be prepared and X-rays of the jaws obtained which can be compared with the dental X-rays and charts of the individual who is believed to be deceased.
- *Clothing** (it is retained in body folds where the fire has not reached) and personal effects like watches, spectacles, dentures, hearing aid, jewelry and keys, and non-specific characters like scars, tattoos (may show up well, despite the loss of the epidermis) or absence of organs can help in identification. A clenched hand resulting from heat contracture preserves fingerprints.
- X-ray examination of a charred body (e.g. evidence of prior surgery, old fracture) can assist in identification by comparison of postmortem X-rays with antemortem X-rays of the individual the deceased is suspected of being.
- If conventional comparison methods are not possible, teeth or bone can be used for DNA analysis.

Q. When did the victim sustain the burn injury?

The question arises as to when the burns were caused and whether all the burns were caused simultaneously. Features which help in estimating the age of burns is given in Table 14.2.

Q. Whether the burns are antemortem or post-mortem?

Refer to Diff. 14.3.

Q. Whether the burns are the cause of death?

- Presence of carbonaceous or soot particles in the respiratory tract.³⁰

Table 14.2: Age of burns

Features	Age
Redness	Immediate
Vesication	1-2 h
Exudates begins to dry	12-24 h
Dry brown crust formation and pus formation	48-72 h
Superficial slough separates	4-6th day
Deep slough separates	15th day
Granulation tissue begins to cover	> 15 days
Formation of cicatrix and deformity	Several weeks

* It helps to determine the race of the individual from underlying intact skin and also useful for accelerant analysis.

Differentiation 14.3: Antemortem and postmortem burns

S.No.	Feature	Antemortem burns	Postmortem burns
1.	Line of redness	Present	Absent
2.	Vesicles	Contain serous fluid, rich in albumin, chloride and some polymorphs	Contain air, if fluid is present, it contain little albumin and no chloride
3.	Inflammation and repair	Present along with pus and slough	Nil
4.	Soot in upper respiratory tract	May be present	Absent
5.	Base of vesicles	Red and inflamed	Dull, dry, hard and yellow
6.	Carboxyhemoglobin	Present	Absent
7.	Enzyme reaction	Increase in enzymes in the periphery of burns	No such increase
8.	Healing	Granulation tissue seen in old cases	Absent

- Cherry red discoloration of blood due to CO confirm burns as cause of death.³⁰

If the hemoglobin saturation is > 10% CO, then the person was alive and inhaled the air during the fire. If death occurs due to the toxicity of CO, the blood carboxyhemoglobin (COHb) saturation is in the range of 50-80%. The COHb saturation level will not be artificially elevated in a dead person by being in or near a fire, i.e. CO will not diffuse through the skin or otherwise be absorbed by a dead body.

- Necklacing** is a method of homicidal burning which involves placing a vehicle tyre around the neck of the victim and setting it alight. It was followed in South African black townships during the apartheid period as a form of punishment for political opponents.
- Arson** is the willful and malicious burning of the dwelling of another or burning of one's own property for an improper purpose, e.g. to collect insurance. The presence of several points of ignition and liquid fire accelerants, such as petrol or paraffin provides strong evidence of fire has been ignited deliberately.

Q. Whether the burns are suicidal/accidental/homicidal/self-inflicted?

- Suicidal burns** are common among Indian women. They pour kerosene on their heads and clothes before setting fire to themselves. Some women stuff clothes inside the mouth to prevent their shouts from being heard by others. Classic religious examples were seen in certain Buddhist sects or the rite of 'sati' performed in some parts of India (now prohibited).
- Accidental burns** are common among children and elderly people. Accidental kerosene stove bursting is also reported. Accidents may result from smoking in bed, especially under the influence of alcohol or drugs, using faulty equipments and playing with fire.
- Homicidal burns** are quite common in India. Custom of dowry leads to young brides being murdered by pouring kerosene on them and setting them on fire by the husband and in-laws and later claimed to be accidental burns.
 - Sometimes, a homicide victim may be burned to conceal murder by other means in an attempt to cover up or destroy the evidence.
- Self-inflicted burns** for false accusation: These burns are usually seen on accessible parts of body.

Scalds

Definition: A scald is an injury which results from application of liquid > 60°C or from steam, and involves only the superficial layers of skin.

Types

It is of three types:

- Immersion burns:** Accidental or deliberate immersion in hot liquid, usually water.
 - Splash or spill burns:** Usually accidental.
 - Steam burns:** Exposure to superheated steam.
- Hot water accounts for most of the immersion or splash burns.
 - Scalds show sharp demarcation with tickle marks, soddening and bleaching, but do not singe the hair or blacken/char the skin.
 - With inhalation, there is laryngeal, tracheal and respiratory burns that may progress to adult respiratory distress syndrome.

Clinically, it is classified into three degrees:

- Erythema or reddening** by vasoparalysis
- Vesication or blister formation** due to increased permeability of the capillaries
- Necrosis** of the dermis when deeper layer of skin is involved

Medico-legal Aspects

- It is usually accidental due to splashing or pouring of fluid during cooking.
- Accidents are common in children and in the elderly.
- Boiling water may be thrown intentionally, usually domestic homicide intent with the husband being the victim.
- Deliberate scalding by hot water is common form of child abuse. Dipping injuries of the limbs appear as well-demarcated 'glove and stocking' distribution of scalds reflecting the flow of hot liquid under the influence of gravity. Areas of scalding round the buttocks with clear, unaffected areas on the upper thighs occur when the child is forcibly made to sit in a hot liquid (Fig. 14.6).

Important differentiating features of dry and moist heat and chemical burns is given are Diff. 14.4.

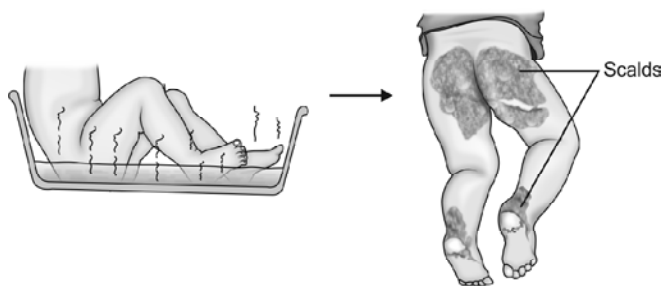

Fig. 14.6: Scalding (child abuse)

Electrical Injuries (Electrocution)

- Electricity exerts two major effects on the body: cellular depolarization of nerves and muscle and heat production, the latter reflecting a longer duration of exposure.
- Factors which determine the consequent pattern of electrical injury include:
 - Kind of current:* Alternating current (AC) is 4-5 times more dangerous than direct current (DC). DC injuries are uncommon, occurs in lightning strikes and from contact with certain equipment.³¹
 - At low amperage, AC causes tetany within the flexor muscles of hand and forearm and hence the patient is unable to release the device until the power is turned off. It also interferes with the normal cardiac pacing causing cardiac arrest.
 - In contrast, DC tends to cause a single muscle contraction, throwing the victim and resulting in a shorter duration of exposure to the electrical source, but increasing the chance of blunt trauma.
 - Amount of current:* The amount of current is expressed as Ohm's law: $I = V/R$, where 'I' is current (amperes [A]), 'V' is voltage (volts [V]) and 'R' is resistance (ohms). Flow of the current is great, if voltage is high or if resistance is low. Electrocution is rare at < 100 V and most deaths occur at > 200 V.³² Amperage is more important, as it indicates the actual intensity/amount of electricity which passes through the body.
 - Path of current:* Death is more likely to occur, if the brainstem or heart is in the direct path of the current.

Differentiation 14.4: Dry heat, moist heat and chemical burns

S.No.	Feature	Dry heat	Moist heat	Chemicals
1.	Cause	Flame, heated body or X-rays	Solid steam or liquid > 60°C	Corrosives
2.	Site	At or above the site of contact	At and below the site of contact	At or below the site of contact
3.	Splashing	Absent	Present	Present
4.	Skin	Dry, wrinkled and may be charred	Sodden, bleached	Corroded and devitalized
5.	Vesicles	At the circumference of burnt area	Over the burnt area	Usually not present
6.	Red line	Present	Present	Absent
7.	Color	Black	Bleached	Distinctive coloration
8.	Charring	Present	Absent	Absent
9.	Singeing	Present	Absent	Absent
10.	Ulceration	Absent	Absent	Present
11.	Scar	Thick, contracted	Thin, less contracted	Thick, contracted
12.	Clothes	Burnt	Wet, not burnt	May be burnt, with characteristic stains

- iv. **Duration of current flow:** Severity is directly proportional to the duration of current flow. For an electric shock to occur, the body must be in contact with both the positive and negative pole or with the earth.
- v. **Resistance:** The principal bodily barrier to an electrical current is the skin and once beyond the dermis, the current passes easily through the electrolytes-rich fluids. The greater the resistance, the more likely that burns will result. Dry skin offers high resistance (1000-1500 ohms), but resistance is decreased when the skin is moist or covered with sweat (200-300 ohms). Blood has low resistance and as such within the body electricity tends to be conducted along blood vessels. With high voltage, condition of the skin plays no significant role.
- vi. **Site of contact:** Electrical injuries on the face and arms are more serious than those on the palms.

Predisposing factors: Unexpectedness of the shock, anxiety, fear and emotions, exhaustion, cardiovascular and other diseases.

Effects due to Passage of Electricity

Electrical injuries are divided into low tension and high tension injuries (threshold 1000 V):

- i. **Low-tension injuries:** Skin burns results from heating of the tissues by the passage of the electric current.
 - Most common sites of low-voltage contact injury (entry) are the hands (fingers) and that of grounding (exit) is the foot or opposite hand.
 - Tissue damage from this heating effect may be insufficient to produce a visible injury, if the surface contact area is broad and the conductivity of the skin is high because of high water content—seen in bathtub electrocutions. Torture by electricity may be done using broad wet electrodes in order to avoid leaving evidential marks.
- ii. **High tension injuries:** Injuries can be caused by three sources—*flash, flame or the current itself*. In overhead lines, the patient acts as a conduction rod to the earth, causing damage to the subcutaneous tissues and muscles with damage at the entry and exit points. Burns may be severe with confluent areas of third-degree burns or charring of the body. There can be massive destruction of tissue with loss of extremities and rupture of organs.

Characteristics of Injuries

Local effects

- i. **Burns and blisters:** Characteristically, these are seen as puckering of the skin around the edges of the burns with surrounding areola of pallor. There is *no red line* surrounding the burns or reddening of the base at the point of entry and exit. *Joule burns*, also known as *electrical burns/mark* is *specific and diagnostic of electric burns* and is found at the point of entry.³³

Joule burns: These marks are round or oval or irregular, chalky white shallow centrally collapsed blister, from few millimeters to 1-1.5 cm in diameter and have a raised border of about 1-2 mm around, part or the whole circumference (Fig. 14.7).

- The crater floor is lined by pale flattened skin. There may be mild hyperemia of the adjacent intact skin, due to rapid dilatation of the pre-capillary vessels.
- The blister is created by the steam produced in the heating of the tissues by the electric current, the so-called *endogenous burns*. When the current ceases, the blister cools and collapses to leave a crater with a raised rim. It may sometimes reproduce the shape of the conductor.
- When contact is more prolonged, skin mark becomes brown and with further contact—charring occurs.

Microscopically, the epidermis shows a *Swiss cheese appearance*. There is vacuolization of epidermis and dermis, subepidermal blistering, nuclear streaming, elongation of epidermal cells and eosinophilia of dermal collagen. The nuclei are thin, elongated and lie parallel to each other.

- Exit marks:** Variable in appearance, but some features are those of the entry mark. Often seen as splits in the skin at points where the skin has been raised into ridges by passage of the current.
- In high-voltage current, the exit often appears as a 'blow-out' type wound.

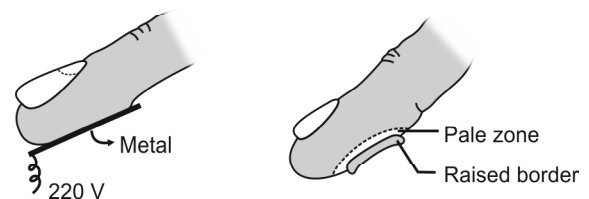

Fig. 14.7: Joule burn (entry mark)

- ii. **Flash or spark burns:** Where the contact is less firm, so that an air gap exists between skin and conductor, the current jumps the gap as a spark and causes the outer skin keratin to melt over a small area. On cooling, the keratin fuses into a hard brownish nodule, usually raised above the surrounding surface, the so-called '*flash/spark burn*'.
 - In high-voltage burns, such as those sustained from high-tension grid transmission cables, sparking may occur over many centimeters. It causes numerous individual and confluent areas of third-degree burns or red/brown punched-out spark lesions which are called as '**crocodile skin**' lesions and typically involve exposed areas of the body.
 - Flash burns are also called *exogenous burns* as the flame is produced outside the body. The flash can ignite the patient's clothes causing flame burns along with singeing of hair.
- iii. **Wounds:** These will be lacerated or punctured with contusions of the margins.
 - The heat generated at the site of entry may cause atomization of the metallic wire which may give a metallic lustre.
 - Small balls of molten metal derived from the metal of the contacting electrode, so-called **current pearls**, may be carried deep into tissues which can be identified by *scanning electron microscopy*.
 - Heat generated by the current may melt the calcium phosphate which is seen in X-rays of limbs as typical round dense foci known as **bone pearls or wax drippings**.³⁴

Systemic effects

- i. Immediate death from shock.
- ii. **CNS:** Hemiplegia or paraplegia, aphasia, headache, vertigo and convulsions.
- iii. **Eye:** Cataract, optic atrophy and choroido-retinitis may occur. In case of close range electrical flash, singeing of eyelash along with first degree burn of the skin of face may occur (*arch eye*).
- iv. Pulseless, hypotensive, loss of response to external stimuli, cold and cyanotic and without respiration—*suspended animation* like state may occur.

With recovery, there may be muscular pain, fatigue, headache and irritability.

Cause of death

- Ventricular fibrillation (low voltage current)—most common.
- Less commonly paralysis of the respiratory muscles (asphyxia) and rarely a direct effect on the brainstem as a result of current passing through the head and neck.

- Inhibition of respiratory centre, electrothermal injury or ventricular asystole (in high voltage).
- *Secondary causes:* Complications, like infection or septicemia (due to burns) or from mechanical injuries, like fall from height.

Acro-reaction test: It is a micro-chemical test for metals at the site of entry of electric current. The test is applicable for detection of metals which are soluble in HCl or HNO₃.

Postmortem Findings

- Before autopsy, it is important to examine the scene and the tools, appliances or machinery involved in the incident.
- Examination of the entire body, particularly the hands and especially the fingers along with examination of the feet and the shoes for evidence of electrical burns is of utmost importance.

External

- i. Face is pale, eyes are congested and pupils are dilated. Petechiae are seen on eyelids and conjunctiva.
- ii. Rigor mortis appears early and dark blue-red postmortem staining is well developed.
- iii. Joule burn at the site of entry is diagnostic.

Internal: Those of asphyxia.

- i. *Lungs:* Congested and edematous.
- ii. *Heart:* Focal necrosis with variable hemorrhage and acute contraction bands in the myocardium and conduction system may be seen.
- iii. Brain, meninges and parenchymatous organs are congested.
- iv. Petechial hemorrhages may be found along the line of passage of the current, under the endocardium, pericardium, pleura, brain and the spinal cord.

Medico-legal Aspects

- Deaths are usually accidental. Suicides are rare and homicides are even rarer.
 - Common method of homicide is to drop a plugged-in electrical device into a bucket/bathtub while the individual is taking a bath. There is usually no electrical burn and if the electrical device is removed, the cause of death will be missed.
- Iatrogenic accidents may lead to a charge of negligence. Traumatic injury may be sustained from electric shock itself from electro-convulsive therapy in treatment of mental disorder.
- It is not possible to differentiate between antemortem and postmortem electrical burns.

Judicial Electrocution

Death penalty is carried out in the electric chair in some states in US. The condemned man is strapped to a wooden chair and one electrode is put on the shaven scalp and the other on the right lower leg. An alternating current (2000 V and 7 amp) is passed for 1 min through the body. The same current is passed through the body a second time for 1 min.

Lightning Stroke

Lightning bolt (DC > 1000 million V) is produced when the charged undersurface (which is mostly negatively charged) of a thundercloud sends its electrical charge to the ground. It may injure or kill an individual by direct strike, a side flash or conduction through another object. Death is caused by high-voltage direct current leading to cardiopulmonary arrest or electrothermal injuries. *Effects due to lightning are:*

Lichtenberg Flowers/Arborescent Markings

These are superficial, several inches long, thin, irregular, tortuous, dendritic red marks on the skin. These marks have a resemblance to the branches of a tree.³⁵

- This fern-like pattern of erythema in the skin is usually found over the shoulders or flanks (Fig. 14.8).
- It is not associated with burning.
- They indicate the path taken by the discharge and tend to follow skin creases and the long axis of the body. It appears within 1 h and disappears in 24-48 h, if the person survive.

Cause: The exact mechanism has not yet been determined. There are various theories:

- Static electricity discharges along superficial vasculature (or perhaps nerves).

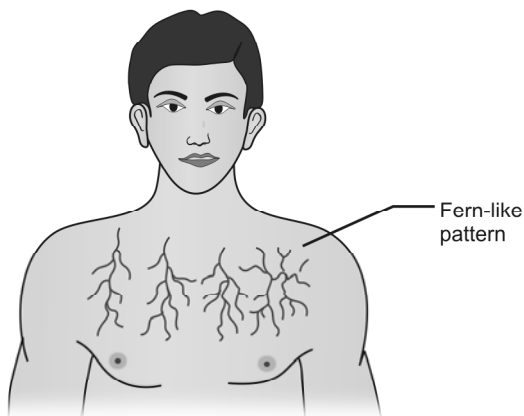

Fig. 14.8: Lichtenberg flowers/Filigree burns

- Hemoglobin staining the tissues in the pattern of a tree due to break down of RBCs within the capillaries of the skin.
- Electron showers eliciting an inflammatory response in the skin.
- Current following lines of perspiration and skin moisture.
- Minute deposits of copper in the skin.

Medico-legal aspects

- Its recognition may be lifesaving in the unaccompanied comatose patient and is important because even delayed resuscitation of lightning victims can be very successful.
- Death is accidental.
- It can help differentiate a natural death from murder.
- Appearance is *pathognomonic* for injury by lightning, but may closely resemble those produced by criminal violence.

Other features of lightning:

- Development of edema of skin at the point of entry wound in those who survive due to paralysis of capillary and lymphatic vessels.
- As the exit is often in the feet, shoe may be ripped apart or blown off the foot. Articles of clothing may be found some distance from the body with the body partly stripped which may suggest sexual assault, particularly when the body is found in the open.
- Linear burns and surface burns.
- Fusing and magnetization of metallic articles, such as rings, spectacle frames, pen-knives, keys and watches due to tremendous heat liberated by the electrical discharge. These are useful signs for eliminating suspicion of foul play.
- Injuries like contusions, lacerations, rupture of tympanic membrane and organs and spinal cord damage.
- Additional findings—singed hair and patterned skin burns marks underneath metal article of jewelry.

Lichtenberg flowers: It is known by different names like 'arborization', 'feathering', 'ferning', 'filigree burns' or 'keraunographic markings'.³⁶ The phenomenon is also known as 'keraunographism' from Greek *keraunos*, a thunder bolt.

MULTIPLE CHOICE QUESTIONS

1. Paradoxical undressing is seen in:
MAHE 06, 10; CMC (Vellore) 10
A. Hyperthermia B. Hypothermia
C. Transvestism D. Immersion syndrome
2. A person working in hot environment who consumes more water without salt is likely to develop a condition called:
UPSC 03, 04
A. Heat stroke B. Heat exhaustion
C. Heat cramps D. Heat hyperpyrexia
3. Sweating is absent in:
DNB 10
A. Heat syncope B. Heat exhaustion
C. Heat stroke D. Heat cramps
4. NOT seen in heat stroke:
Kerala 06
A. Hypovolemic shock B. Rhabdomyolysis
C. Pancreatitis D. Cerebral edema
5. Characteristic features of superficial burns are all, except:
TN 06; WB 09
A. Damage no deeper than papillary dermis
B. Blisters absent
C. Loss of epidermis
D. Pinprick is not painful
6. Blister formation in burn is classified as:
DNB 09; Bihar 11
A. First degree B. Second degree superficial
C. Second degree deep D. Third degree
7. All are features of deep burn, except:
UP 04
A. Leathery skin B. Painful
C. No blister/vesicles D. Involvement of fat
8. A lady with burns, skin appears waxy and dry with little pain, the degree of burn is:
CMC (Ludhiana) 11
A. First degree B. Second degree superficial
C. Second degree deep D. Third degree
9. According to 'rule of 9', perineum burns constitute:
FMGE 09
A. 1% burns B. 9% burns
C. 18% burns D. 27% burns
10. Percentage of surface area of palm of a burn patient:
FMGE 10; AI 11
A. 1% B. 9%
C. 18% D. 27%
11. Head and neck burns in infant constitute _____% of burns:
Kerala 08
A. 9 B. 18
C. 24 D. 36
12. In a 6-year-old child with burns involving whole of head and trunk, the estimated body surface area involved:
JIPMER 09
A. 44% B. 48%
C. 55% D. 58%
13. Most important aspect of management of burn injury in the first 24 h:
UPSC 07
A. Fluid resuscitation B. Dressing
C. Escharotomy D. Antibiotics
14. In adults, circulatory collapse occurs after a minimum of what percentage burns of total body surface area:
NIMHANS 08; TN 11
A. 5% B. 10%
C. 15% D. 20%
15. Best fluid for resuscitation in burns:
FMGE 11; Punjab 12
A. Dextran B. Ringer lactate
C. Albumin D. Hartmann's solution
16. Parkland formula for burns is for:
Maharashtra 09; UP 09
A. Ringer lactate B. Glucose saline
C. Normal saline D. 25% dextrose
17. A 65 years male weighing 50 kg was admitted with 80% burn and RL was transfused with Parkland method. How much fluid should be infused in first 8 hours:
UP 11
A. 200 ml/hr B. 500 ml/hr
C. 1000 ml/hr D. 8000 ml/hr
18. Muirs and Barclays formula is for:
AFMC 11
A. Colloid resuscitation in burns
B. Polytrauma fluid resuscitation
C. Crystalloid in trauma
D. Dextran in burns
19. Not an indication for admission in burns ward:
Bihar 10; Maharashtra 11
A. Acid burns
B. Inhalational injury
C. 5% partial thickness burns in an unmarried female
D. 10% deep burns in a male
20. Most common cause of death in thermal burns is:
UPSC 04
A. Convulsion B. Aspiration pneumonia
C. Hypovolemic shock D. Arrhythmias
21. Cause of late death in burn patients is:
UP 04
A. Neurogenic shock B. Hypovolemic shock
C. Sepsis D. Cardiogenic shock
22. Pugilistic attitude is due to:
Delhi 07; FMGE 10
A. Lipolysis
B. Protein coagulation
C. Carbohydrate coagulation
D. Lipogenesis
23. True about pugilistic attitude:
MP 09; PGI 10
A. Indicate antemortem burns
B. Indicate postmortem burns

1. B 2. C 3. C 4. C 5. D 6. B 7. B 8. D 9. A 10. A 11. B 12. B
13. A 14. C 15. B 16. A 17. C 18. A 19. C 20. C 21. C 22. B 23. C

- C. Cannot differentiate between ante- or postmortem
D. Indicate defense by victim
24. **Difference between incised wound and heat rupture favoring heat rupture are:** *AI 09*
A. Margins well-defined
B. Small and multiple wounds
C. Nerves and vessels are visible in floor
D. Seen only over scalp
25. **Feature of ruptured skin caused by excessive heat:** *AIIMS 10*
A. Irregular margin B. Clear regular margin
C. Contused margin D. Abraded margin
26. **Appearance of burn hematoma:** *DNB 09; Punjab 10*
A. Honeycomb like B. Disc shaped
C. Stellate shaped D. Smooth and rubbery
27. **Curling ulcer is seen in:** *UP 04; WB 10*
A. Head injury B. Burn
C. Corticosteroids D. TPN
28. **Curling's ulcer in burns is seen in:** *AIIMS 08*
A. Esophagus B. Stomach
C. Colon D. Duodenum
29. **Curling's ulcer common in which part of duodenum:** *DNB 09*
A. 1st part
B. 2nd part
C. 3rd part
D. Between 1st and 2nd part
30. **A 25 years female was found dead in room having 100% burns with tongue protruding out, body in pugilistic attitude, heat ruptures, peeling of skin, and heat hematoma and heat fractures of skull. Carboxyhemoglobin was 25% and soot particles were present in trachea. Which of the combinations of two findings will establish that the burns were antemortem in nature:** *AIIMS 04*
A. Heat hematoma and heat ruptures
B. Heat fracture of skull and peeling of skin
C. Heat hematoma and pugilistic attitude
D. Carboxyhemoglobin and soot particles in trachea
31. **True regarding electrocution injuries are all, except:** *SGPGI 04*
A. Direct current produces greater damage as compared to alternating current
B. The injuries are greater when associated with moist contact
C. The injuries are of higher intensity, if the body is partially not earthed
D. High voltages throw the victims clear
32. **Electrocution is rare below:** *MP 09*
A. 100 volt B. 150V
C. 200 V D. 240V
33. **Joule burn is seen in:** *Delhi 03; Bihar 11*
A. Blast injuries B. Electrocution
C. Firearm wounds D. Lightning stroke
34. **Bone pearl's or wax drippings is pathognomonic of:** *Orissa 11*
A. Burns B. Scalds
C. Lightening D. Electrocution
35. **A dead body is found to have marks like branching of a tree on front of the chest. Most likely cause of death could be:** *AIIMS 05; FMGE 10*
A. Firearm injury B. Lightning injury
C. Bomb blast injury D. Road traffic accident
36. **Filigree burn occur in:** *FMGE 09; NJI 10; JIPMER 11*
A. Lightning B. Electrocution
C. Vitriolage D. Infanticide

Definitions

- **Transportation injuries** are blunt force injuries that occur from travel on the ground, in the air and on water. The most frequent of these are motor vehicle collision and pedestrian injuries. Less common cases are associated with railway accidents and aircraft crashes.
- **Motor vehicle collision** or road traffic accident occurs when a vehicle collides with another vehicle, pedestrian, animal, road debris or other stationary barrier, such as a tree or utility pole.
- **Hit-and-run:** Failure to stop at scene of accident by the driver of a motor vehicle without giving assistance or informing the police.

- Those injured by accidents can be divided into three broad groups: pedestrians, cyclists (pedal or motor) and the drivers and passengers of vehicles.
- Pedestrians (most common), cyclists, children and the elderly are among the most vulnerable of road users.

Pedestrian Injuries

Three patterns of injuries are seen (Fig. 15.1):

- Primary impact injuries
- Secondary impact injuries
- Secondary injuries

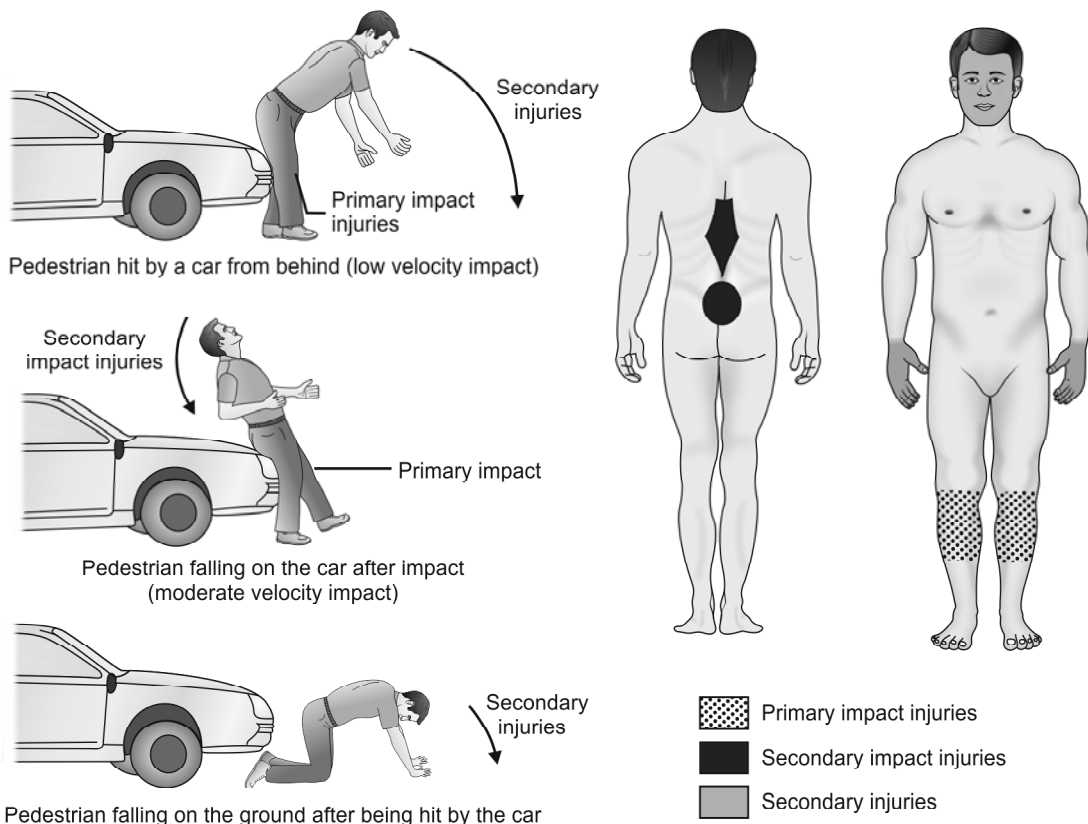

Fig. 15.1: Dynamics of pedestrian injuries and sites of primary impact, secondary impact and secondary injuries

Primary Impact Injuries

- Primary impact injuries indicate that part of the body which has been struck first by the vehicle and often form recognizable patterns.
- When an adult is hit by the front of a car, the front bumper or radiator usually strikes the victim at about knee level.¹ The exact point of contact, whether on the front, side or back of the leg(s), will depend on the orientation of the victim.
- They help to establish the position of the victim at the material moment when struck and help towards identification of the offending vehicle.

Behavior of the body and disposition of injuries will be modified by factors like:

- Whether both the feet were firmly placed on the ground or one of them was raised at the time of impact.
- *Speed of the vehicle:* At low speeds (e.g. 20 kph), the victim is usually thrown off the bonnet either forwards or to one side. Between 20 and 60 kph, the victim may be tipped onto the bonnet and the head may strike the windscreen or the metal frame that surrounds it. At higher speeds (60–100 kph), the victim may be projected into the air ('scooped-up'); sometimes pass completely over the vehicle and avoid hitting the windscreen and other points on the vehicle.
- *Nature of road surface:* Smooth, rough, full of gravel or mud and its skidding resistance.
- Point of impact in relation to centre of gravity.

When the pedestrian is knocked down from behind with both feet fixed to the ground: There will be fracture of the bones of the lower limbs, the buttocks and back of the pedestrian on being hit by head lamps or the radiator of car. It may result in fracture dislocation of the lumbar or thoracic spine and this injury may drive the femoral head through the acetabulum.

- Stretch-type lacerations are frequent in the inguinal (groin) regions.
- Where the vehicle is relatively larger than the victim—adults impacted by a truck or a bus and children impacted by cars—the point of contact is higher up the victim and it is likely that the victim will make contact with more of the front of the vehicle. This pattern of contact may result in primary injuries to the pelvis, abdomen, chest and head. Usually, the victim is projected along the line of travel of the vehicle, which may increase the risk of 'run-over' injuries.

Waddell's triad is a classic pattern of injury seen in pedestrian children who are struck by motor vehicles. It comprises of fractured femoral shaft, intra-thoracic or intra-abdominal injuries and contralateral head injury (Fig. 15.2). Mechanism of injury is an initial impact causing injury to the pelvis and femur (bumper injury) instead of the knees and tibias; followed by the chest and abdomen (grill, fender or hood). Then the child is thrown on the ground and sustaining injury to the opposite side of the head.

On being struck from behind and feet not firmly on the ground: The victim's feet will fall backward and may be propelled upwards and backwards so that the head may sustain *secondary impact injury* by striking against the windscreen. The victim can also be 'scooped-up' or fall to one side and may sustain head injuries by striking the ground on falling.

If the victim is struck from front, he may sustain injuries to the chest and abdomen with fracture of ribs or vertebrae. Victim can also sustain fracture of pelvis or fracture dislocation of sacroiliac joint from the impact of a mudguard and fracture of tibia and fibula of one or both legs can be sustained from impact by a bumper.

- Bumper impacts usually cause soft tissue damage and comminuted wedge shaped fractures of the tibia and fibula with forward displacement of the bony fragments.² Base of the triangular fractured fragment will suggest the site of impact and its apex will point to the direction of the moving vehicle (Fig. 15.3). Bumper injuries at different levels in two legs or when absent on one leg, will suggest that the victim was walking or running while struck.
- *Bumper fracture* when present, the measurement of the distance from the heel to the fracture site will give an idea about the height of the bumper of the offending vehicle. When brakes are applied before the accident, the distance from heel to the fracture is less than the height of the bumper (presence or absence of braking may help to determine the driver's intent).
- The lack of 'bumper injuries' and the presence of tyre marks could indicate the pedestrian was already prone or supine on the road when 'run over.'

When the pedestrian walks into the side of a moving vehicle: He will sustain glancing abrasions or crushing lacerations on the side or front of the face, chest and arms. Due to *primary impact injury* over the elbow, there may be fracture of ribs with/without laceration of the lungs. The victim on being struck on the side will be



Fig. 15.2: Waddell's triad

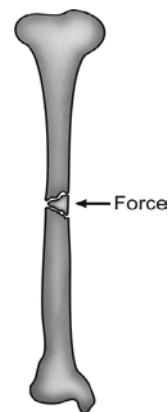

Fig. 15.3: A wedge type bumper fracture of the tibia

pushed forward or to the side and will sustain *secondary injuries* on striking the ground.

Fracture of the skull occurs due to direct impact of the vehicle on the head or when the head strikes the ground following secondary injuries.

Secondary Impact Injuries

- These are often seen in case of 'scooped up' victim being thrown over the bonnet, i.e. further injuries caused by the vehicle following primary impact. He may sustain injuries by hitting his head against the windscreen, its rim or side-pillars.
- Extensive abrasions, bruises and lacerations may be seen.
- Sometimes, pedestrians are 'run over' if knocked down by the vehicle. This will tend to occur if the pedestrian's centre of gravity is lower than the impact site or scooped-up victim being run-over by other vehicles. Injuries are variable, depending on the area of the body involved, the weight of the vehicle and the surface area of the contact.

There may be:

- i. Tyre tread marks over the unclothed or not very thickly clothed areas on one surface of the body, with graze-like abrasions on the opposite side, i.e. pavement side.
- ii. The head may be crushed causing gross distortion and externalization of the brain or severe injuries may occur to the chest, pelvis or abdomen.
- iii. Compression of the chest may result in multiple rib fractures, causing a 'flail chest' with rupture of internal organs along with fracture of the spine, sternum and ribs.

- iv. Avulsion injury occurs when the wheel moves over a fleshy part causing degloving of skin and subcutaneous tissue, by tearing it away from underlying tissues. It is also called '*flaying injury*', and is seen mostly in legs, arms and scalp.

- v. Burning and singeing of skin and hair resulting from discharge of hot exhaust.

Secondary Injuries

These result from body parts striking the ground following the primary impact. They are more lethal than the primary injuries, especially to the head, chest and pelvis. When the pedestrian is thrown to the ground, he sustains abrasions (skidding *brush burns* are common), bruises or lacerations over the bony prominences, such as elbows, knees, etc. which is most pronounced over unclothed areas.³

- Brain damage is frequent without any associated skull fractures. This is due to the moving head of the victim being suddenly stopped on impact (*contre-coup injury*)—diffuse damage to axons may be caused by the rotational or shearing forces acting upon the brain.
- Fracture of the skull and ribs due to direct contact with a surface, and fracture of the spine due to hyperflexion or extension may be seen. Fractures of the spine, especially in the cervical and thoracic segments may lead to cord damage.
- Fractures of the limbs are common but apart from those of the legs (primary impact sites), they are rather unpredictable because of the random movements of the limbs.

Usually, it is very difficult to classify the injuries as primary impact, secondary impact or secondary injuries.

In pedestrian accidents, the common cause of death is head injuries and fracture dislocations of cervical spine, mainly at the atlanto-occipital joint. Injuries to the chest and abdomen are minimal or absent.

Injuries Sustained by Vehicle Occupants

- After pedestrians, the driver is the most frequent casualty in road traffic accidents as a high proportion of vehicles are occupied only by a driver. Next in frequency is the front seat passenger, followed by rear seat passengers.
- Ejection of both driver and passenger from a vehicle is associated with significantly severe injuries or fatality as the doors often burst open.
- Unbelted rear seat occupants are also at increased risk of serious injury in motor vehicle accidents; they may be ejected or thrown forward against the front seat.
- The driver and passenger injuries depend upon the type of impact crash. It can be:

- Front impact
- Rear impact
- Side impact
- Roll-over

Front Impact Crash (Fig. 15.4)

This happens when one car strikes another car head-on or strikes a stationary object, like an electric pole/tree (approx. 80% of impacts). While the vehicle rapidly decelerates and stops, the occupants continue to move forward striking against the interior of the vehicle, unless they are restrained. If the head impacts against the windshield, the victim does not sustain severe cuts from the fragments of glass which used to happen when it

was made exclusively of glass. Windshields, nowadays, are made of a thin outer and inner layer of glass with thick plastic core.

The driver tends to receive a different pattern of injury as compared to either the front seat or rear seat passenger. The driver may receive a momentary warning of the impending collision and brace himself against the steering wheel. Fractures of the wrists and arms may thus occur, as well as fractures or dislocation of tibia, fibula and pelvis may occur from transmission of the force of impact from pressing on the brake and clutch pedals.

If the driver is unaware, his knees will impact against the dashboard, his chest against the steering wheel, and his head against the windshield. An impact of the knees against the dashboard commonly causes fractures of the tibia, fibula, femur and pelvis. Severe impact against the windshield pillar may cause avulsion of the skin of the forehead, basilar skull fractures, closed head injury and fracture or dislocation of the atlanto-occipital junction.

Steering wheel impact injury: The circular rim of the steering wheel may cause fractures of the jaws and facial bones, as well as imprint abrasions, minor bruises and contusions of the chest or bilateral rib fractures. Transverse fracture of sternum is usually seen at 3rd intercostal space. Damaged steering wheel spokes may penetrate the chest and lacerate the heart and lungs. Flail chest may occur.

With severe thoracic compression, partial or complete transection of aorta may occur usually at the junction of the aortic arch with descending aorta—classical injury. Lacerations of liver and spleen may be seen. Serious steering wheel injuries are less frequent, if the car is fitted with energy absorbing compressible steering wheel column.

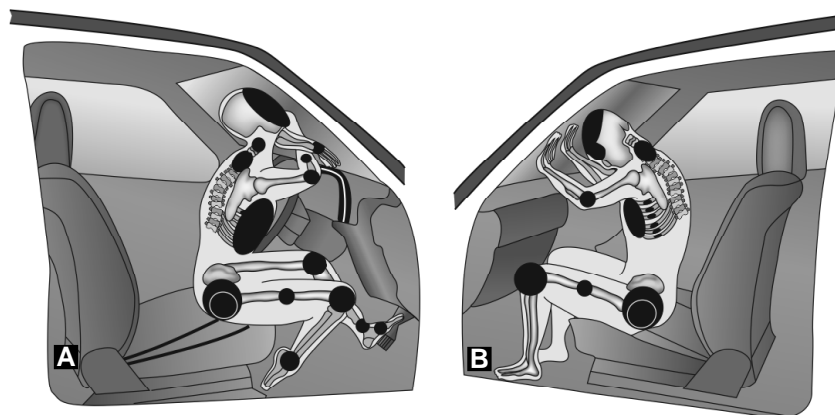

Fig. 15.4: Major sites of injury (black) in (A) Unrestrained driver and (B) Front seat passenger of a car

Front seat passenger: The most dangerous place in the car is the front passenger seat. He may not get the momentary warning of the impending collision. Without a seat belt, he is at risk of severe impact of his head against the windshield with its consequences. The occupant may be ejected out of the vehicle through the windshield, increasing the risks of secondary injuries or running over. There may be peculiar facial lacerations due to contact with the shattered windshield known as '*sparrow foot marks*' (similar to dicing injuries mentioned below).⁴ Contact with the dashboard may cause injuries to the knee.

Passengers of the rear seat often escape such injuries because of the absence of impact against the windshield and dashboard and of the cushioning effect of the front seat. However, they may be injured against internal fittings, like door handles or ejected through burst-open doors.

Rear Impact Crash

Low velocity rear impacts are relatively common. Usually, they cause whiplash injury. Neck fractures are rare. A high velocity rear impact crash can deform and rupture the gas tank with ignition of the fuel.

Side Impact Crash

The vehicle strikes on the side of another vehicle or skids sideways into a fixed object. This is a common pattern in an intersection and is therefore a frequent occurrence in urban areas.

Injuries are often severe, because the side of a car has a thin metal wall door and no other components to absorb the force of impact. Since the occupants of the vehicle move toward the side of impact, the persons sitting on that side run the greatest risk.

Dicing injuries may occur which are superficial cuts of the skin caused by fragments of tempered glass (designed to shatter into small glass cubes on violent impact). They are produced when the side and the back windows of a car shatter. They are linear, right angled or V-shaped laceration seen typically on the face, forehead and arm on the right side of the driver and left or right side of passengers. Fragments of tempered glass embedded in the wound may be seen. They help to locate the position occupied by the victim in the automobile.

Cervical spine fracture, fractured ribs, contusions, lacerations and explosive tearing of the lungs on the side of the impact are common. External injuries tend to

be on the right side of the driver, the right arm and leg may be fractured. Internally, fractures of ribs on the right side are seen. In the abdomen, a lateral impact on the right side commonly causes lacerations of the right lobe of the liver and right kidney. An impact on the left frequently lacerates the spleen, left kidney and left lobe of the liver. The pelvis may be fractured from impact on either side.

Roll-over Crash

Although the automobile may suffer severe damage in a roll-over crash, the occupants receive surprisingly moderate impact, if the vehicle is not brought to a sudden stop and the impact is spread over a period of time. It is usually less lethal than front or side impact collision. The crashing of different sides of the vehicle absorbs the forces of impact, if the passenger compartment remains intact, the belted occupants frequently survive the crash (anything that prevents ejection of occupants). Non-belted occupants are involved in two types of injury:

- Tumbling around inside and striking the interior of the vehicle
- Ejection out from the vehicle.

There is no specific injury pattern.

Role of Seat Belts and Air Bags

Numerous safety features such as safety belts, airbags, collapsible steering columns, softened interior dashboards and antilock brakes have contributed to the saving of lives.

The air bag system has reduced the gravity and incidence of chest and facial trauma, especially in those individuals not using seat belts. These are intended to provide protection only in frontal crashes and to be used in conjunction with seat belts. Compared to 3-point seat belts, air bags are significantly less effective. Seat belts offer the greatest benefits in frontal and roll-over crashes. Wearing seat belts reduces the risk of fatalities to front seat occupants by 45%, since:

- Injuries are of less severity, except whiplash injury.⁵
- Probability of severe head injury is lower.
- Probability of being ejected from the vehicle is lower.
- There are fewer fatal/major injuries to head, neck, chest and abdomen.

Lap belts can produce tears of the mesentery, omentum and laceration of the bowel.⁶ Shoulder belt may produce a linear abrasion running downward and medially on the right side of the driver and left side of front seat passenger.

Although, seat belts reduce mortality, they cause a specific pattern of internal injuries. Patients with seat belt marks on their body have been found to have a 4-fold increase in thoracic trauma and an 8-fold increase in intra-abdominal trauma compared with those without seat belt marks.

There are three forms of automobile belt restraints: Lap belts, shoulder (diagonal) belts and three-point belts (lap plus shoulder). Lap belts were the first form of restraint used in automobiles. The most popular and efficient seat belt is the 3-point belt which consists of both a diagonal and transverse strap set in inertia recoil housing.

Motorcycle and Cycle Injuries

- An accident that might result in minor injuries with an automobile, can result in death with a motorcycle.
- The common causes of motorcycle accidents are alcohol, drugs, environmental factors (bumps or potholes), reckless driving and failure by drivers of cars to see the motorcycle. The most common cause of motorcycle fatality is running off the road.
- Most injuries are due to ejection from the vehicle into the roads, due to high speed and instability of the vehicle. In a high speed impact of a motorcycle, there may be primary injuries due to the initial impact, followed by secondary injuries from striking the ground. Head and leg injuries are common. *Primary injuries* are mostly open fractures of the tibia and fibula. *Secondary injuries* are mostly fractures of the skull, ribs and cervical spine, as well as contusions of the brain. There are graze abrasions due to sliding across the road.
- **Fracture of the skull:** Transverse fracture of the base of the skull—the hinge fracture is common, sometimes referred to as '*motorcyclists fracture*'.⁷ Temporo-parietal fractures are also quite common. Ring fracture around the foramen magnum may be seen in some cases by an impact of the crown of the head.
- Passengers falling off the backs of the motorcycle will have lacerations of the back of the head, fractures of posterior cranial fossa, contrecoup contusions of frontal lobes of the brain and abrasions of back and elbows. If they fall forwards, there will be abrasions of the face.
- A unique injury is seen wherein the motorcyclist drives under the rear of the truck, causing head

injuries and even decapitation, which is known as 'under-running' or '*tail-gating*'.*

Pedal cycle injuries are common in India, but severity is less due to slow speeds. Primary injuries may occur from impact by cars and trucks, but secondary injuries involving the head and chest are common from falling. A unique injury seen among bicyclists is stripping of the skin from the leg due to limb being forced between the wheel spokes.

- *Motorcyclists* experience a death rate 35 times greater than occupants of cars. Helmets reduce the risk of fatal head injury by 1/3rd and reduce the risk of facial injury by 2/3rd. Fractures of the lower extremities are common, occurring in approximately 40% of motorcyclists hospitalized for non-fatal injuries.
- *Injuries to bicyclists:* Children aged 5-14 years have the highest rates of injury and head injury accounts for 75% of the deaths. Helmets have been shown to reduce the risk of brain injury for bicyclists by 88%.
- *Injuries to pedestrians occur* disproportionately among school going children, the elderly and the intoxicated.

Postmortem Examination

Photographs of the scene, clothing and injuries should be taken routinely. Since some countries limit the damages to be recovered if the victim was not wearing a seat belt, any injuries consistent with seat belt injuries should be noted. The role of the automobile to commit homicide is also postulated.

History

The history should include the condition of the eyes (corneal opacities), blindness, if the victim was suffering from any disease, e.g. heart, epilepsy or diabetes, drugs that he was using (or abusing), and if he was depressed or under unusual stress.

Clothing

The clothing should be described with special attention to tyre imprint marks, tears, amount of bleeding and foreign bodies, especially glass particles, metal, grease marks or oil stains and paint which may indicate the part of the vehicle that struck the victim and provide valuable evidence with respect to the suspected vehicle (hit and run cases). Similarly, hair, blood and other tissues can be transferred from the pedestrian to the vehicle. For this reason, autopsy surgeon should preserve hair and blood samples for comparison.

* This injury has been reduced by the presence of bars at the sides and rear of trucks to prevent both bikes and cars passing under the vehicle.

Injuries

External injuries: It should include:

- i. The nature of the wound, i.e. whether it is a bruise, abrasion or laceration.
- ii. The wound dimensions, e.g. length, width and depth. It is helpful to take a photograph of the wound with an indication of dimension (e.g. a tape measure placed next to the wound).
- iii. The position of the wound in relation to fixed anatomical landmarks, e.g. distance from the midline or below the clavicle.
- iv. The height of the wound from the heel (i.e. ground level)—this is important in cases where pedestrians have been struck by motor vehicles so that the height of an impact point can be compared with any suspect vehicle.

Internal injuries: The distribution of fatal injuries is mostly related to the head and chest. Due to extraordinary resilience of the skin, serious internal injuries may be present without any evidence of corresponding external injury. It is therefore necessary to incise suspected areas of impact.

Laboratory Specimens

A blood sample (of the driver or pedestrian) should be analyzed for the presence and amount of alcohol (taken from peripheral vein and not from heart or viscera, if death occurred within 12-24 h of accident) and drugs, since the question of contributory negligence may subsequently arise. If sufficient blood is not obtainable, vitreous fluid from the eye can be analyzed for alcohol. The urine should be screened for commonly abused drugs.

Whether the victim was the driver or a passenger?

Sometimes, it is necessary to know who was driving the vehicle for insurance purpose. Following can assist the autopsy surgeon in determining if a particular occupant was the driver:

- **Steering wheel impact abrasions** may be seen on the chest.
- **Dicing injuries** on the right side of the body.
- **Patterned seat belt abrasion** is seen on the right side of shoulder going diagonally across the chest to the left.
- **Imprint marks** of the brake and clutch pedals on the soles of shoe if pressed at the time of impact (patterns on the accelerator and brake pedals are purposefully different from one another).

In different jurisdictions, autopsy surgeons may rule the manner of death in hit-and-run pedestrian fatalities

as 'homicide' or 'accident' or 'undetermined' depending on the existing protocol.

Alcohol, Drugs and Trauma

Alcohol and substance abuse are major associated factors in all forms of trauma. About 10% of the drivers with blood alcohol level higher than the legal limit account for nearly 1/3rd of non-fatal and half of fatal driver deaths. Injury to drunken pedestrians shows even greater association, as pedestrian accidents account for nearly 3/4th of adult traffic accidents. There is a strong association with alcohol, drug dependency and dangerous driving, violent and aggressive behavior.

Drugs tested for should include alcohol, carbon monoxide, acid, basic and neutral drugs. Marijuana and opiates testing are indicated in select cases. Blood used for testing should be the one which has been drawn prior to starting of IV fluids and blood transfusion. In case of death, analysis of vitreous fluid is valuable as it reflects the alcohol and drug levels 1-2 h prior to death.

Railway Injuries

These are common in India and China because of a wide network and unprotected crossings. It is a common mode of suicide, but accidents are common in children. There is nothing specific about railway accidents, except the frequency of severe mutilation. The body may be severed into many pieces and soiled by axle grease and dirt from the wheels and track. When passengers fall off from the train, multiple injuries along with abrasions are seen due to contact with coarse gravel along the line ballast.

Suiciders either jump in front of a moving train from a platform, bridge or other structure near to the track, or place their head across a rail causing transected neck, either partial or complete with black soiling at the crushed decapitation or amputation site. There may be 'flail chest' along with traumatic asphyxia when the victim is crushed between the buffers of two bogies.

Furthermore, a careful search for unusual injuries (stabs, gunshots) and for vital reaction to the severe blunt force injuries should be made, as there many occasions when the victim of a homicide has been placed onto the rail track in an attempt to make it appear like an accident.

MULTIPLE CHOICE QUESTIONS

1. **Primary impact injury (1°) most commonly seen in:**
AIIMS 07; AI 10

A. Head	B. Thorax
C. Legs	D. Abdomen
2. **Bumper fracture is:** *Rohtak 06*
 - A. Primary impact injury
 - B. Secondary impact injury
 - C. Tertiary impact injury
 - D. Secondary injury
3. **Extensive abrasions are found on the body of a pedestrian. The cause is:** *AI 09*
 - A. Primary impact injury
 - B. Secondary impact injury
 - C. Secondary injury
 - D. Postmortem artifact
4. **Sparrow foot marks are associated with which type of injury:** *Orissa 11; AI 11*
 - A. Motor cyclist's fracture
 - B. Under-running or tail gating
 - C. Steering wheel impact
 - D. Wind screen impact
5. **In a motor vehicle accidents, the seat belt leads to following, except:** *UPSC 04*
 - A. Reduced incidence of severe thoracic injury
 - B. Occurrence of small intestine and mesenteric injury
 - C. Increased severity of decelerating head injury
 - D. Trauma to major intra-abdominal vessels
6. **When a seat belt is worn, if an accident occurs, sudden deceleration can result in:** *UP 05; CMC (Ludhiana) 10*
 - A. Rupture of mesentery
 - B. Liver injury
 - C. Spleen injury
 - D. Vertebral injury
7. **Motor cyclists fracture is:** *WB 09; AIIMS 10*
 - A. Ring fracture
 - B. Comminuted fracture of the vault
 - C. Skull base divided into two halves
 - D. Gutter fracture

Explosion Injuries and Fall from Height

16

Explosion Injuries

Definitions

- **Bomb** is a container filled with an explosive mixture and missiles which is fired either by detonator or a fuse.
 - **Incendiary bombs**, e.g. napalm bombs primarily cause burns. Usually phosphorus and magnesium are added. Temperature of 1000°C is produced.
 - **Molotov cocktail** is an incendiary bomb which is thrown by hand. In its crude form, a bottle is filled with gasoline and a rag to serve as a wick. The wick is lit and thrown at the target.¹
- **Blast injury** is a complex type of physical trauma resulting from direct or indirect exposure to an explosion.

Mechanism of Action

The explosive pressure that accompanies the bursting of bombs or shells, ruptures their casing and imparts a high velocity to the resulting fragments. These fragments have the potential to cause more devastating injury to tissues than bullets.

In addition, all explosives are accompanied by a **complex wave**. The two main components of this wave are a **blast wave** (known as *dynamic overpressure*) with a positive and negative phase, and the **blast wind** (*mass movement of air*) (Fig. 16.1). Injuries are mainly due to the initial shock wave, but are aggravated by the sub-atmospheric phase.

- The positive pressure phase of the blast wave lasts a few milliseconds, but close to an explosion it may rise to over 7000 kN/m². As the tympanic membrane ruptures at about 150 kN/m², the effects on the human body of such an explosion can be devastating. Like sound waves, the blast pressure waves flow around an obstruction and affect anyone sheltering behind a wall or a trench. Also, any person standing in front of a wall or any surface facing an explosion is subjected to the added effect of a reflected pressure.

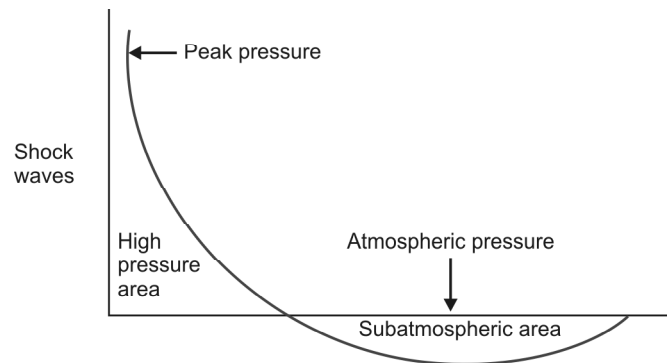

Fig. 16.1: Pressure changes occurring in bomb explosion

- The mass movement of air (*blast wind*) disrupts the environment, throwing debris and people. This phenomenon results in injuries ranging from traumatic amputation to disruption.
- When the body is impacted by a *blast pressure wave*, it couples into the body and sets up a series of stress waves which are capable of injury, particularly at air-fluid interfaces. Thus, injury to the ear, lungs, heart and the GIT is notable.

Classification of explosives (based on material used)

- High-order explosives (HEs)** undergo detonation producing an instantaneous blast wave under extremely high pressure causing severe primary blast injury, e.g. TNT, dynamite, ammonium nitrate and C-4 'plastic' explosives.
- Low-order explosives (LEs)** undergo deflagration rather than detonation and thus lacking in blast wave—uncommonly to cause the pulmonary and central nervous system injuries unique to primary blast injury. They are composed of propellants, such as black powder and pyrotechnics, such as fireworks and oil- or petroleum based explosives such as Molotov cocktails.

Classification of Injuries (Fig. 16.2)

Blast injuries are divided into four categories: primary, secondary, tertiary and quaternary.

- i. **Primary:** Primary injuries are caused by blast waves and characterized by the absence of external injuries. They are usually internal injuries which are often unrecognized and their severity underestimated. The ears are most often affected by the overpressure, followed by the lungs and the hollow organs of the gastrointestinal tract (GIT).² GIT injuries may present after a delay of hours or even days. Primary blast injuries are:
- **Acoustic barotrauma** commonly consists of rupture of the tympanic membrane, dislocation of the ossicles or widespread disruption of the inner ear leading to permanent deafness.
 - **Lungs:** Considerable disruption at the alveolar-capillary membrane (air-fluid interface) leads to capillary leakage, resulting in extensive hemorrhage of both lobes of lung. There is pulmonary contusion, systemic air embolism and free radical-associated injuries such as thrombosis and DIC or a combination of all these—*blast lung*. ARDS may be a result of direct lung injury or of shock from other body injuries.
 - Blast lung is the most common cause of death among people who initially survive an explosion.
 - Clinically characterized by the triad of dyspnea, bradycardia and hypotension and the patient may present with dyspnea, cough, hemoptysis or chest pain.
 - Chest radiographs in the initial stages may show localized contusion injury, but as the time passes, the effect becomes generalized with bilateral fluffy infiltrates spreading out from the hilum of both lungs—'butterfly' pattern.
 - **GIT:** Injury to gas-filled viscera is more common in underwater explosions than in air blasts.
- Although the colon is most commonly affected, perforation of the stomach, small intestine and caecum are also seen.
- **Brain:** It can cause concussion or mild traumatic brain injury without a direct blow to the head. There may be headache, fatigue, poor concentration, lethargy, depression, anxiety, insomnia or other constitutional symptoms.
- ii. **Secondary injuries** are due people being injured by shrapnel and other objects propelled by the explosion. These injuries may affect any part of the body and sometimes result in penetrating trauma. Most casualties are caused by secondary injuries. Some explosives, such as *nail bombs*, are purposely designed to increase the likelihood of secondary injuries.
- Penetrating thoracic trauma, including lacerations of the heart and great vessels is a common cause of death.
- iii. **Tertiary injuries:** These are the injuries resulting from blast wind that can throw victims against solid objects. Tertiary injuries may present as some combination of blunt and penetrating trauma, including bone fractures and coup contre-coup injuries. Children are at particular risk because of their lesser weight.
- iv. **Quaternary (miscellaneous) injuries:** Injuries not included in the first three categories. These include flash burns,* crush injuries, fall resulting from the explosion and respiratory injuries (toxic dust, gas) or radiation exposure. Psychiatric injury (some due to neurological damage sustained during the blast) is most common, and post-traumatic stress disorder (PTSD) may affect people who are otherwise completely uninjured.

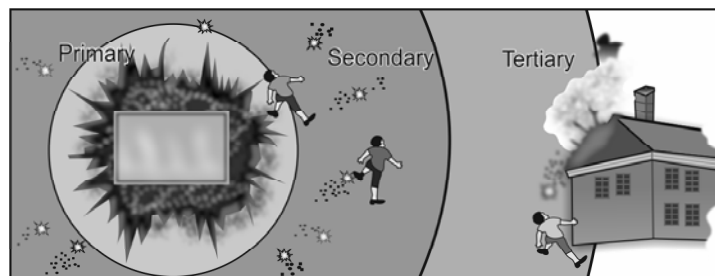

Fig. 16.2: Blast injuries

* When the bomb explodes, the temperature of the explosive gases can exceed 2000°C and the heat radiated momentarily can cause flash burns

Sequelae of traumatic injuries:

- Crush syndrome and acute renal failure may occur in patients rescued from collapsed structures.
- Increasing extremity pain after an explosion may indicate developing compartment syndrome.

Work up

The most common urgent clinical problem in survivors is usually the penetrating injury caused by blast-energized debris and fragments from the casing of the exploding device. Many of those exposed will have blunt, blast and thermal injuries, in addition to more obvious penetrating wounds (referred to as *combined injury*). The soft-tissue wounds are heavily contaminated with dirt, clothing and secondary missiles, such as wood, masonry and other materials from the environment (**flying missiles**).

Medico-legal Aspects

Forensic pathologist may encounter blast injuries in both routine case work and as part of mass casualty events. Therefore, recognition, proper interpretation and documentation of these types of injuries would assist with reconstruction of the incident.

i. **Whether a bomb has caused the explosion?**

- Full body photographs and complete X-rays of the whole body are indicated before the clothes are removed. Any radiopaque fragments and radiolucent material (paper fragments, wood and plastic) may be components of an explosive device.
- Residues are either burnt (black or gray) or unburnt (yellow, brown, gray) material. Swab the soiled skin and hands. Collect hair and fingernail scrapings.
- Foreign body (shrapnel or empty shell) may be found during autopsy.
- Toxicological analysis may also help.
- Extensive burns are usually not caused by localized bomb explosion.

ii. **Number of dead persons:** A major initial problem, correct fragments are to be allocated to the right individuals.

iii. **Identification of the dead:** The injuries can be extreme and thus make identification and interpretation difficult for the autopsy surgeon. All body parts and clothing are recovered (clothing is submitted in airtight containers).

- Dentition, dentures and artificial teeth also help in identification.
- Fingerprinting may also help.

Recognizing the 'suicide bomber' may be difficult. The nature of suicide bomber injuries is vital in locating and identifying these types of offenders. The hands are examined to determine whether he was holding the explosive.

iv. **Enlisting the injuries.** External and internal injuries are described in detail.

External injuries

Total body disintegration indicates high-order condensed explosive at close range.

- There may be mangling of body near explosion with parts of extremities amputated; craniofacial injuries are seen in case of suicide. Lower limb amputation is typical of standing or seated individual. Hand injuries are seen, if explosive device was held.
- There may be projectile injury.
- Punctate lacerations, dust tattooing and black soiling from explosive materials may be seen. **Triad** of bruises, abrasions and puncture lacerations with tattooing of the body indicates bomb explosion.
- Injuries may be seen due to fallen rubble.
- Burns (flash burns and singed hair seen on victims in immediate vicinity).

Internal injuries have been described earlier.

v. **Cause of death:** Death may result from variety of causes, viz. complete disintegration of body, blast shock, burns, blunt force injuries and crush asphyxia.

vi. **Circumstances of death** need to be looked for.

Fall from Height

Introduction

- Deaths due to fall from height are common in urban settings. In occupational settings, it is the most common type of accident. Builders, electricians, miners and painters are particularly at risk. It is also a major cause of personal injury, especially for the children and the elderly.
- Factors contributing to falls from heights include faulty equipment, such as ladders and scaffold structures and human factors, such as intoxication and inattention.

The evaluation of injuries alone during autopsy is not sufficient to assess whether the manner of death is suicide, accident or homicide. Findings at the scene of death and medical, psychiatric, social history and toxicology results of the victim should also be taken into account to determine the manner of death.

Investigation of Scene

- Falls or jumps from places where people normally do not go are highly suspicious of suicide. Suicide notes are also indicative of a suicidal fall.
- Dangerous work-places like building sites—most falls are usually accidental.
- Signs of a fight at the death scene always suggest homicide. Distance of the body from the jumping site can be used as an additional tool to determine the manner of death. In intentional jumps, the distance to the jumping site is likely to be higher than in accidental falls.

Psychiatric history: A history of psychiatric illness is most frequently found in suicidal falls from height which often includes depression, schizophrenia and/or substance abuse.

Injury Patterns

It is dependent on the part of the body that hits the ground first, the height of fall, ground composition, and age, clothing and body weight of the victim (Fig. 16.3).

External Examination

Examination of the clothing can provide some clues about the nature of a fall from a height. In feet-first impacts, longitudinal tears in the loin region of trousers may be seen due to inguinal stretching.

- Postmortem staining is sparse due to loss of blood.
- In feet-first impacts, longitudinal tears of the inguinal regions may be seen. Plantar injuries with open fractures of the ankle joint or calcaneus are

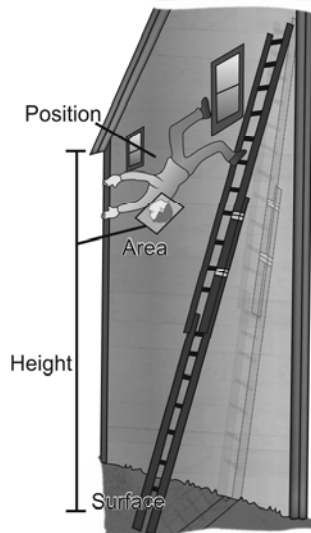

Fig. 16.3: Factors affecting injury patterns

characteristic (Fig. 16.4). Bruising in the perineal region is sometimes misinterpreted as a sign of sexual abuse prior to the fall.

- Palmar skin tears and open comminuted fractures of the wrists and knees are common in free falls wherein the victim may have attempted to cushion the impact.
- Blunt injuries such as abrasions and hematoma at the site of primary impact (planar impacts) are a frequent finding.
- Depending on the impact surface, the ground texture might be reflected as patterned injuries.
- Palmar injuries such as abrasions ('rope burns'), resulting from the attempt of the victim to hold on to objects preventing a fall, suggest a homicidal or an accidental fall or fresh wrist incisions ('hesitation marks') are indicative of a suicidal intention.

Internal Examination

Severe injuries of the internal organs and/or the musculoskeletal system can be found in all fatal falls from height.

Head injuries: All types of brain hemorrhages—subarachnoid, subdural, epidural and intracerebral, and brain contusion as well as severe disruption and complete or partial loss of brain structures may be seen.

- In head-first impacts there is usually open comminuted skull fractures with additional facial bone fractures and externalization of the brain over wide areas and rarely severe internal organ injuries.
- If feet-first impact, forces transferred upward can result in significant pelvic trauma, as well as a 'ring

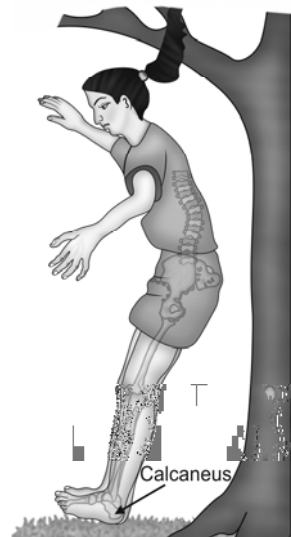

Fig. 16.4: Feet-first impact

fracture' of the skull, as forces drive the spinal column upward into the cranial cavity (Fig. 16.4). Brainstem injuries such as laceration, contusion or transection are frequent.

- Traumatic subarachnoid hemorrhage can be seen where there is no evidence of direct head trauma is present.

Neck injuries: If neck injuries along with subconjunctival hemorrhages are present, then possibility of strangulation prior to the fall should be considered. However, blunt force neck injuries directly related to the fall are frequent. Mild to moderate hemorrhage in subcutaneous and muscular layers, thyroid hematoma along with fractures of hyoid bone may be seen in falls from > 10 meters.

Chest Injuries

Thoracic cage injuries like abrasions and bruises of the chest wall and rib fractures are found in all fatal falls. Rib fractures are mostly bilateral; multiple fractures of the whole thoracic cage, including the sternum and thoracic spine are found when height of fall is > 25 meters.

- **Heart:** Cardiac injuries are frequently seen in fatal falls from height.
 - Pericardial tears are most common and occur in the right posterior part of the pericardium and tend to be of longitudinal orientation. Endocardial tears are more likely to be found in falls from greater heights.
 - Complete or incomplete transmural tears of the heart affect the right heart (atrial posterior wall) more often than the left heart. Tears of the interatrial septum are more common than interventricular septal tears.
 - In falls from great heights, the heart can be completely or subtotally torn off from the great vessels which usually results in immediate death.
- **Thoracic blood vessels:** Ruptures of the thoracic aorta are a common finding in free fall victims and are mostly located in the isthmus area (aortic arch). The frequency of aortic rupture increases with the increase of height of fall.
- **Lungs:** Contusions of the lungs can be found in almost all fatal falls. With greater falling heights,

pulmonary ruptures or complete hilus rupture can be found. Penetrating rib fractures with associated pulmonary injury are common.

- **Diaphragm:** Diaphragm rupture is relatively rare.

Abdominal Injuries

- **Liver:** Liver ruptures are more frequent in falls from height than in other mechanism of blunt abdominal trauma. The right lobe of the liver is involved more often than the left lobe. Tears are often irregular in nature but have been shown to be almost parallel in many cases.
- **Spleen:** Multiple splenic rupture is common.
- **GIT:** Ruptures or bruises of the intestinal root are a common finding in greater falling heights but traumatic ruptures of the esophagus, stomach and bowel are relatively rare—due to their compliance and relative mobility within the abdominal cavity.
- **Retroperitoneal organs:** Rupture of the abdominal aorta, in contrast to thoracic aortic rupture, is relatively rare. Psoas muscle bleeding may result from inguinal stretching especially in feet-first impacts. Renal injuries are seen rarely.

Cause of Death

- The majority of victims die instantaneously at the scene or within minutes, the cause of it is polytrauma, followed by head trauma and blood loss.
- In free-fall victims who survive for few hours to days, head trauma is most common cause of death.
- In victims who survive for few days, causes of death include septicemia, multiple organ failure and pulmonary embolism.

Medico-legal aspects: The questions of medico-legal importance in fatal falls concern the manner of death and the toxicology. The determination of manner of death is quite difficult in some cases and it may remain 'undetermined' even after complete autopsy.

- Most cases of fatal falls from height are suicidal.
- Accidents may occur at work, domestic settings and during recreational sports activity.
- Homicide is rare. There may be additional injuries that cannot be explained by the fall alone like defense or offence injuries. However, injuries inflicted prior to the fall might well be masked by the impact injuries.

MULTIPLE CHOICE QUESTIONS

1. **Molotov cocktail is:** *Kerala 06; Manipal 06; UP 07; Bihar 11*
- A. Mixture device of bomb
 - B. Simple petrol bomb thrown by hand
 - C. Molotov, foreign minister of Russia died after having the cocktail
 - D. Type of tank
2. **In blast injury, most common organ affected:** *CMC (Vellore) 07; AI 09; AIIMS 10*
- A. Eardrum
 - B. Stomach
 - C. Lungs
 - D. Liver

Definitions

- **Trauma:** A body wound or shock produced by sudden physical injury; from violence or an accident.
- **Assault:** An *offer of threat* or attempt to apply force to the body of another in a hostile manner (**Sec. 351 IPC**). It does not matter whether it injures him physically or not. Shaking of head or showing of fist at a person in hostile manner will constitute an assault.
- **Battery:** It is the *actual application of force* to the body. It is an assault brought to execution. Beating or wounding will constitute battery. Battery need not require body-to-body contact. Any volitional movement, such as throwing an object towards another can constitute battery. Additionally, an individual can consent to battery in some situations, e.g. in sports.
- **Homicide:** Killing of a human being as a result of conduct of the other. It may be *lawful or unlawful*.
 - I. Lawful homicide:** It can be justifiable or excusable.
 - a. Justifiable:** Homicide which is justified by the circumstances that led to killing of the person, e.g.:
 - i. Judicial execution
 - ii. Maintenance of justice, like suppressing riots or executing arrest
 - iii. In self-defense
 - iv. In preventing some forcible and atrocious act, such as rape, murder or burglary
 - b. Excusable:** Homicide caused unintentionally, e.g.:
 - i. In defense of one's home/family
 - ii. Causing death by accident/misadventure
 - iii. Death following lawful operation
 - iv. Homicide committed by an insane person
 - v. In sports, such as boxing
 - II. Unlawful homicide:** Implies both, the fact of death and an accompanying state of mind known as '*malice aforethought*' on the part of the killer. *Without such a state of mind*, the act is known as *culpable homicide not amounting to murder*.
- **Culpable homicide (Sec. 299 IPC, 'manslaughter'):** It is an offence wherein an individual by his/her act intentionally or knowingly causes death or causes such bodily injury which is likely to cause death.
- **Murder (Sec. 300 IPC):** Killing of a person with malice aforethought.

If the act by which death is caused:

 - i. With the intention of causing death.
 - ii. With the intention of causing such bodily injury which is likely to cause death of the person or sufficient in ordinary course of nature to cause death.

All 'murder' is 'culpable homicide', but not vice-versa. It does not include acts by which death is caused:

 - i. Under grave and sudden provocation.
 - ii. When there is no intention to kill, but death results from unlawful conduct by the person responsible.
 - iii. Without premeditation.
 - iv. In a person \geq 18 years of age, suffers death or takes the risk of death with his own consent.
- **Punishment for culpable homicide not amounting to murder (Sec. 304 IPC):** If an individual commits culpable homicide not amounting to murder then he/she is punished with imprisonment from 10 years to life imprisonment and fine; and if the act was done with the knowledge of possibility to cause death, but without any intention to cause death, then punishment is imprisonment for 10 years and/or fine.¹
- **Attempt to murder (Sec. 307 IPC):** Any individual who does any act with intention or knowledge and under such circumstances that it caused death, he would be guilty of murder, then he/she is punished with imprisonment for 10 years and fine; and if hurt is caused to any person by such act, then punishment is imprisonment from 10 years to life imprisonment and fine.

- **Capital murder** is murder which is punishable by death.
 - The law of India, differing from law of UK, does not regard every case of homicide as prima facie murder; it throws on the prosecution the burden of proving a certain intent or knowledge.
 - In US, murder or 'homicide' is normally a crime only under state law and a murder suspect will be arrested and held by local officials and tried in a local court on behalf of the state. For murders that are federal crimes (e.g. a killing of a federal official or on federal property), the trial would occur in a federal court.
 - In UK, homicide can be divided into several offences, including:
 - i. *Murder*—Killing of another person whilst having either the intention to kill or to cause grievous bodily harm.
 - ii. *Manslaughter*—Unintentional and unlawful killing of another person.
 - iii. *Infanticide*—Intentional killing of an infant under 1 year, by a mother.
- **Dowry death:** Where the death of a woman is caused by any burn or bodily injury or occurs in a manner other than under normal circumstances within 7 years of her marriage, and it is shown that she was subjected to cruelty or harassment by her husband or any relative of her husband for, or in connection with any demand for dowry, such death shall be called dowry death (**Sec. 304B IPC**).²
 - It is a cognizable and non-bailable offence and punished with imprisonment from 7 years to life imprisonment.
 - **Sec. 498A IPC:** Whoever, being the husband or the relative of the woman, subjects such a woman to cruelty, is punished with imprisonment for a term which may extend to 3 years and also fine.³
 - **Hurt:** Hurt means any bodily pain, disease or infirmity caused to any person (**Sec. 319 IPC**). It is of two types:
 - i. Simple
 - ii. Grievous.
- ### Simple Hurt/Injury
- Simple hurt is not defined in law. However, an injury which is neither extensive nor serious and which heals rapidly without leaving any permanent deformity or disfiguration is considered as simple hurt.
- ### Grievous Hurt/Injury
- Sec. 320 IPC** defines the grievous hurt and comprises of 8 clauses:⁴⁻¹⁰
1. **Emasculation:** Deprivation of a male of his masculine vigor by castration or by causing injury to testes or to spinal cord at the level of L2-L4 vertebrae resulting in impotence.
 - Only male castration comes under this clause.
 - If only one testis gets damaged or removed and the other testis with intact male organ is present, then it is not considered as emasculation.
 2. **Permanent privation of sight of either eye:** Gravity lies in its *permanency* as it deprives the use of organ of sight and also disfigures him. It includes deep abrasions (involving the corneal stromal layer) within the central visual axis, dislocation of lens, breaking of zonules, retinal or choroidal tears and optic disc lacerations.
 3. **Permanent privation of hearing of either ear:** It should be *permanent* deafness. It can be due to blow on the head or ears or blows which injure the tympanum, ear ossicles or auditory nerves or injury by foreign body. It may be noted that tympanic membrane perforations may heal spontaneously (especially central perforations).
 4. **Privation of any member or joint:** Privation is an act, condition or result of deprivation or loss. It is a state of being deprived.
 - 'Member' means any organ or limb of a subject responsible for performance of distinct function. It includes eyes, ears, nostrils, mouth, hands or feet.
 - 'Joint' may be both small or big ones.
 - Loss of hair/nails would not come under this clause.
 5. **Destruction or permanent impairment of the powers of any member or joint:** Use of limbs and joints are vital for discharge of normal functions of the body. It includes cutting (severing) of any tendon, anywhere along its route—at its origin, in between or at its insertion. If it is not repaired, its function is permanently lost. This may cause deformity, loss of movement and weakness.
 6. **Permanent disfigurement of the head or face:** 'Disfiguration' means change of configuration and personal appearance of the subject by some external injury which does not weaken him/her.
 - For example, chopping off an individual's ear or nose which would cause disfigurement, without consequential disability, so as to constitute grievous hurt under this clause.
 - A large cut on the face or branding may leave a permanent scar causing disfigurement.

- Permanent disfiguration is seen when injuries to the eyes leave residual defects after healing like ptosis, entropion or squint.
 - Opinion of disfigurement should be given after complete healing, since the doctor can judge whether disability is permanent or not.
7. **Fracture or dislocation of a bone or tooth:** If there is a break by cutting or splintering of the bone or there is a rupture or fissure in it, then it would amount to a fracture.
- For the meaning of 'fracture' under this clause it is not necessary that a bone should be cut through and through or that the crack must extend from the outer to the inner surface or there should be displacement of any fragment of the bone.
 - It should be seen whether the cuts in the bones noticed are only superficial or have affected a break in them.
 - Even if the extent of the cut is not mentioned, it would amount to grievous hurt if there has been a break in the bone.

Dislocation implies traumatic displacement of the position of the members of the joint along with injury of tissues. Mere looseness of a tooth due to disease or old age will not amount to dislocation.

8. **Any hurt which:**

- i. Endangers life
 - ii. Causes the victim to be in severe bodily pain for 20 days
 - iii. Unable the victim to follow his ordinary pursuits for a period of 20 days
 - Any hurt which endangers life' means that the life is only endangered and not taken away, i.e. placing a person in danger of death.
 - A mere stay in hospital for 20 days will not constitute grievous hurt.
 - *Ordinary pursuits* signify day-to-day personal acts of an individual, like going to the toilet, having food or taking bath or wearing clothes. It does not include going to work, running, jumping or driving a vehicle.
- **Dangerous injury** has not been defined in the IPC. Dangerous injuries are those which cause imminent danger to life by its direct or imminent effects because of being extensive in nature, involving important structures or organs of the body and also being likely to prove fatal in absence of medical/surgical aid. Any tear in dura mater, intracerebral hemorrhages, cerebral edema, laceration of lungs resulting in

hemothorax, rupture/perforation of GIT, any rupture of large arteries/veins are examples of dangerous injuries.

- The term 'endangers life' is much broader term than the expression 'dangerous to life'. All dangerous injuries can endanger life, but not vice-versa.
- **Injuries sufficient to cause death in ordinary course of nature, e.g:**
 - i. Injuries to the brain (intracranial hemorrhages) and spinal cord.
 - ii. Injuries to heart or large blood vessels.
 - iii. Injuries to respiratory organs.
 - iv. Injuries involving GIT, e.g. rupture of liver, spleen, perforation of intestines, etc.
 - v. Injuries (wounds) to highly vascular organs, like liver/spleen.
 - vi. Extensive burns or scalds (affecting > 1/3rd of the body surface area).
 - vii. Combined effect of number of injuries, none of which by itself may be sufficient to cause death, but together may cause it.
 - viii. Squeezing of testes.
- **Dangerous weapon or means:** Any instrument used for shooting, stabbing or cutting, or any instrument which if used as a weapon of offence is likely to cause death; or by means of fire or any heated substance, poison or any corrosive substance, explosive or any substance which is harmful to the human body to inhale, to swallow or to receive into the blood or by means of any animal (**Sec. 324 and 326 IPC**).

Common weapons of offence are grouped into:

- i. *Hard blunt* objects, e.g. sticks or stones
- ii. *Light weapons* with a sharp cutting edge, e.g. knife or razor
- iii. *Heavy weapons* with a sharp cutting edge, e.g. hatchet or axe
- iv. *Pointed weapons*, e.g. dagger or needle
- v. *Firearms*, e.g. shotgun or rifle

Punishments

Punishment for various offences is given in Table 17.1.

Cause of Death from Wounds

Immediate Causes

1. **Shock:** Types of shock

- Hypovolemic
- Vasovagal
- Neurogenic
- Burns
- Anaphylactic
- Traumatic
- Cardiogenic
- Septic
- Psychogenic

i. **Hypovolemic shock:** It is due to loss of intravascular volume by hemorrhage, dehydration, vomiting and diarrhea.

- Rapid loss of 1.5-2 litres of blood (25-30% or 1/3rd of blood in an adult) is sufficient to cause death due to irreversible hypovolemic shock (blood volume in normal adult is 8-8.5% of body weight or 65-75 ml/kg).
- *Methods to determine blood loss:* A clot, the size of a clenched fist is roughly equal to 500 ml.¹¹ Loss of blood in closed fractures of long bones are given in Table 17.2.
- *External blood loss:* Each 1 square feet of blood (on clothing or floor) represents approximately 100 ml of blood.
- Men resist hemorrhage better than women, although the latter can sustain enormous loss of blood during childbirth without a fatal result.

- *Petechiae* are minute hemorrhage spots, usually of capillary origin.
- *Ecchymoses* are larger areas of extravasated blood.
- *Traumatic hemorrhage:* Bleeding occurring due to wounds.
- *Spontaneous hemorrhage:* Bleeding occurring in the absence of trauma.

- *Primary hemorrhage:* Hemorrhage occurring at the time of injury.
- *Reactionary hemorrhage* occurs from the same site as primary hemorrhage, but is usually seen within 24 h (usually 4-6 h) after injury.¹² It may occur due to:
 - i. Rise in blood pressure (which accompanies the recovery from shock).
 - ii. Muscular movements, which may dislodge the blood clot or cause 'slippage' of the ligature from the vessel.
- *Secondary hemorrhage* may occur as a result of erosion of vessel wall due to infection (7-14th day).¹³
- *External hemorrhage:* If large vessels are involved, death is rapid. Sudden loss of blood is more dangerous than the same quantity lost slowly.
- *Internal hemorrhage:* The amount of blood loss can be judged accurately and can often be measured at autopsy.

ii. **Traumatic shock:** It occurs due to hypovolemia from bleeding externally (open wounds), from bleeding internally (torn vessels in the mediastinal or peritoneal cavities, ruptured liver, spleen or fractured bones) or loss of fluid into contused tissue or into distended bowel. Traumatic contusion of heart itself may cause pump failure and shock.

iii. **Vasovagal shock:** Pooling of blood in the larger vascular reservoirs (limb or muscles) and dilatation of the splanchnic vascular bed causing reduced venous return to the heart, low cardiac output and reflex bradycardia. Consequently, the reduced cerebral perfusion causes cerebral hypoxia and unconsciousness. Cause of death is arrived at from negative findings.

Table 17.1: Punishment for some offences committed by any individual

S.No.	Section of IPC	Offence	Punishment (Imprisonment)	Fine
1.	302	Murder	Death or life imprisonment	Yes
2.	304	Culpable homicide not amounting to murder	10 years to life imprisonment	Yes
3.	304-A	Death by rash and negligent act	Upto 2 years	With/without fine
4.	304-B ¹⁴	Dowry death	7 years to life imprisonment	With/without fine
5.	306	Abetment of suicide*	Upto 10 years	Yes
6.	307	Attempt to murder	10 years to life imprisonment	Yes
7.	309	Attempt to commit suicide	Upto 1 year	With/without fine
8.	323	Voluntarily causing simple hurt	Upto 1 year	With/without fine (upto 1000 rupees)
9.	324	Voluntarily causing simple hurt by dangerous weapons/means	Upto 3 years	With/without fine
10.	325	Voluntarily causing grievous hurt	Upto 7 years	Yes
11.	326	Voluntarily causing grievous hurt by dangerous weapons/means	Upto 10 years	Yes

* Suicide (Latin *sui caedere*: to kill oneself) is the act of intentionally ending one's own life. Shooting, hanging and stabbing are '*hard*' ways of committing suicide and typically male choice; poisoning and drowning are '*soft*' ways of committing suicide.

Table 17.2: Blood loss in fractures

Fracture	Blood loss
Humerus	200-500 ml
Tibia with/without fibula	500-700 ml
Femur	1000-1500 ml
Pelvis	> 2000 ml
Ribs	Variable, may be major

- iv. **Neurogenic shock:** It is caused by traumatic or pharmacological blockade of the sympathetic nervous system, producing dilatation of resistance arterioles and capacitance veins leading to hypovolemia, bradycardia and hypotension.¹⁴
- v. **Burn shock:** Secondary shock results from rapid plasma loss from the area of burn causing hypovolemia. When > 25% of the body surface is burnt, a generalized capillary leakage may cause hypovolemia in the first 24 h.
- vi. **Anaphylactic shock:** Penicillin administration is a common cause. Other causes include serum injections, anesthetics, dextrans, stings and consumption of shellfish. The antigen combines with IgE with the release of histamine and substance of anaphylaxis (SRA-A) causing bronchospasm, laryngeal edema, respiratory distress, vasodilatation, hypotension and shock (mortality is about 10%).¹⁵
- vii. **Cardiogenic shock:** It results from interference in the action of the heart as in the case of:
 - a. Deficiency of filling, e.g. cardiac tamponade.
 - b. Deficiency of emptying, e.g. myocardial infarction (when > 50% of left ventricle is involved).
 - c. *Acute pulmonary embolism* from a thrombus originating in a deep vein or due to air emboli (> 50 ml) causing obstruction of more than 50% of the pulmonary vasculature, causes right ventricular failure and sudden death or shock.
 - d. Fluid overload, particularly with colloids can lead to overdistension of the left ventricle and pump failure.
- viii. **Psychogenic shock:** It immediately follows sudden fright or severe pain, like blow to the testes.
- ix. **Septic (endotoxic) shock**
 - *Hyperdynamic (warm) septic shock:* It occurs usually in the case of Gram-negative infections. Initially, there is an increased cardiac output with tachycardia and warm skin, but the blood is shunted past tissues which become damaged by

anaerobic metabolism. The capillary membranes start to leak and endotoxin is absorbed into the blood stream causing generalized systemic inflammatory state.¹⁶

- *Hypovolemic hypodynamic (cold) septic shock:* It develops in the presence of sepsis or endotoxemia which may produce circulatory failure from generalized increased vascular permeability and peripheral vasodilatation. The systemic infection induces cardiac depression, pulmonary edema, hypoxia and decreased cardiac output. The patient becomes cold, clammy, drowsy and tachypneic.
2. **Death due to injury of an organ:** Extensive damage to vital organs, like brain, heart and lungs may be sufficient by itself to cause rapid death when even the quantity of blood loss may not be so important.

Remote Causes

- i. **Infection:** Wound infection may be caused by:
 - Organisms present on body surface, e.g. *Streptococcus*, *Staphylococcus* or *Proteus*.
 - Organisms may invade the injured area from the environment, e.g. *Streptococcus*, *Staphylococcus*, *Clostridium welchii* or *Clostridium tetani*.
 Infection may be:
 - a. *Primary:* Caused by organisms which are carried into the wounds at the time of injury, e.g. from skin, clothing or dirt.
 - b. *Secondary:* Caused by organisms which invade the wound after injury, e.g. airborne droplet infection or contaminated dressings.
 - c. *Direct:* Infection at the site of an open wound, such as a stab or gunshot wound with exposure to outside contamination.
 - d. *Remote:* Local sepsis can cause septicemia or pyemia; septic endometritis following criminal abortion can cause meningitis.
 - e. *Traumatic:* Trauma over an area of pre-existing infected lesion can cause dissemination of infection.
 - f. *Debilitating:* In case of poor vitality and debilitating disease, infection easily occurs in form of hypostatic pneumonia or ulcers.
- ii. **Gangrene or necrosis:** It implies death, often with putrefaction of macroscopic portions of tissue.
 - Traumatic gangrene may have a *direct cause* (crushes, pressure sores and constriction groove of strangulated bowel) or *indirect cause* from injury of vessels at some distance from the site of gangrene,

e.g. pressure on popliteal artery by the lower end of a fractured femur.

- A gangrenous part lacks arterial pulsation, venous return, capillary response to pressure, sensation, warmth and function.
 - It is usually dark brown, greenish black or black in appearance due to disintegration of hemoglobin and formation of iron sulphide.
- iii. **Crush syndrome:** Traumatic tubular necrosis occur in case of crushing of muscles, especially those that involve the lower limbs, e.g. under fallen masonry, industrial and vehicular accidents, extensive burns and certain poisons, like mercuric salts and CCl_4 .
Cause: Disturbance of renal blood flow and ischemia.
- iv. **Neglect of injured person:** Death may occur from complications arising from a simple injury due to improper treatment/negligence on part of doctor/nurse.
- v. **Surgical operation:** Assaulted person is not bound to submit himself for operation. If death occurs due to this omission, assailant becomes responsible. If death follows surgical operation for the treatment of injury, the assailant is responsible for the result, if it is proved that the victim would have died even without the operation.
- vi. **Natural disease:** Some natural disease may be present which was the cause of death, but death was accelerated by assault, e.g. person with fatty degeneration of heart may die with slight violence.
- vii. **Supervening of disease from traumatic lesion**
- Head injury followed by meningitis may result in death.
 - Abdominal injury on healing may be followed by strangulated hernia/stricture and obstruction.
- viii. **Thrombosis and embolism (thromboembolism)**
- It is a common complication of traumatic lesions of lower extremities.
 - *Most common sites of thrombosis are:* Deep femoral, popliteal and posterior tibial veins.
 - Factors which predispose to leg vein thrombosis after injury are:
 - a. Local tissue damage, causing injury to veins.
 - b. An increase in clotting time, which is maximum at about 2 weeks after injury.
 - c. Immobility and bed rest.
 - d. General debility, especially in old age, leading to poor general circulation and cardiac output.

Thrombus usually develops in 10-20 days after injury, gets detached in part or whole and can cause pulmonary embolism (*saddle embolism*).¹⁷

Embolism means partial or complete obstruction of some part of the vascular system by any mass transported through circulation. The transported mass is known as *embolus* which can be:

- i. Solid, e.g. detached thrombi (pulmonary embolism)
- ii. Liquid, e.g. fat globules
- iii. Gaseous, e.g. air

The embolus can be bland or septic; venous, arterial or lymphatic.

Pulmonary Embolism

- Pulmonary embolism is a complication of venous thromboembolism, *most commonly* deep venous thrombosis (DVT) of the legs.^{18,19} Less common causes include air, fat droplets, amniotic fluid, clumps of parasites or tumor cells and talc in drugs of IV drug abusers.
 - It is present in 60-80% of patients with DVT.
 - As a cause of sudden death, it is 2nd only to sudden cardiac death. Most patients die within the first few hours of the event.
 - **Risk factors:** Venous stasis, hypercoagulable states, immobilization, surgery and trauma, pregnancy, oral contraceptives and estrogen replacement, malignancy, hereditary factors and acute medical illness.
 - **Types**
 - Acute: If the embolus is situated centrally within the vascular lumen and occludes a vessel.
 - Chronic: If it is eccentric and contiguous with the vessel wall and reduces the arterial diameter > 50%.
 - **Signs and symptoms**²⁰
 - *Classical presentation* includes abrupt onset of pleuritic chest pain, shortness of breath and palpitation. Severe cases can lead to collapse, abnormally low blood pressure and sudden death.
 - *Signs:* Tachypnea, tachycardia, fever, accentuated second heart sound, diaphoresis, lower extremity edema, cyanosis and signs of thrombophlebitis.
 - **Diagnosis:** Pulmonary angiography is diagnostic but with the improved sensitivity and specificity of CT angiography, it is now rarely performed.
- Fat embolism:** Causes of fat embolism are:
- a. Fracture of long bones, especially of femur.²¹⁻²³
 - b. Injury to adipose tissue which forces fat into damaged blood vessels.

- c. Injecting oil into circulation, e.g. criminal abortion.
- d. Natural disease without any trauma as in sickle cell anemia, diabetes, blood transfusion or in chronic alcoholics.
- e. Burns and septicemia.
 - Fat embolism is rare in children, since bone marrow fat is scanty.
 - *About 12-120 ml of free fat* causes embolic death.
 - *Clinical features:* Cyanosis, precordial pain, rapid pulse and respiration, tachycardia, thrombocytopenia, hyperpyrexia and petechial hemorrhages in the axillae and neck may develop in 8-20 h. Later, the patient will have respiratory distress with hypoxemia and bilateral patchy infiltrates on chest X-ray. Fat globulin may be seen in urine.^{22,23}
 - Death usually occurs in about 10 days, but may be delayed upto 3 weeks.
 - Cerebral fat embolism causes death in about 1-2 days.

Air embolism: Its causes are:

- a. Incised wounds of lower cervical region involving jugular/subclavian vein. It may also happen when the subclavian vein is opened to the air, e.g. in supraclavicular node biopsies, central venous line placement or CVP lines that become disconnected.
- b. Wounds of sagittal sinus inside the skull.
- c. Injection of fluid mixed with soap and air into pregnant uterus for procuring abortion.
- d. Caesarean section, version or manual extraction of placenta.
- e. Injection of air under pressure in fallopian tube to test its patency.
- f. Faulty technique in giving IV injection with gravity.
- g. Crush injuries of chest.
- h. Positive pressure ventilation in newborn infant.
- i. Artificial pneumothorax and pneumo-peritoneum.
- j. Air encephalography.
- k. Caisson's disease.
 - *About 100 ml of air* introduced under pressure produce fatal pulmonary air embolism.
 - *Detection:* X-ray examination of whole body. Air bubbles in retinal arteries can be seen by ophthalmoscope.
 - For systemic air embolism, *1-2 ml of air* may be enough to produce death.
 - Death from air embolism occurs within few minutes, and usually not delayed beyond 45 min.²⁴
- ix. **Adult respiratory distress syndrome (ARDS)** occurs due to heavy impact on the thorax, blast

injuries, injections, toxins, shock, irritant gases, aspiration of gastric contents or near drowning, in which there may be diffuse alveolar damage. Lungs become stiff, edematous and retain their shape after removal and may be double their weight.

- x. **Disseminated intravascular coagulation (DIC):** It occurs due to trauma, infection and other acute events. It is a consumption coagulopathy associated with blood clotting mechanism. There is an abnormal activation of the coagulation process within the blood vessels. Fibrin is consumed and precipitated in vessels, causing both vascular obstructive effects and a hemorrhagic diathesis from depletion of coagulative system.

Complications are microvascular destruction leading to infarction and bleeding.

Martius Scarlet Blue (MSB) stain: This trichrome stain is useful for examining thrombi and emboli and for seeking fibrin in DIC.

Medico-legal Questions

Q. Whether the injuries are antemortem or post-mortem in nature?

Refer to Diff. 17.1.

Histochemical changes

In trauma to the living tissue, two zones are seen around the wound:

- i. **Central (superficial) zone:** Close to the edge of the wound, there is a zone, 0.2-0.5 mm wide which becomes necrotic and has decreased enzyme activity—zone of *negative vital reaction* (Fig. 17.1).
- ii. **Peripheral zone:** Immediately beyond this layer, there is a 0.1-0.3 mm zone where enzymes become increased in concentration during reparative process—*zone of positive vital reaction*, compared to the normal level in the area outside the wound (Fig. 17.1).
 - In postmortem wounds, positive vital reaction does not develop.
 - It is demonstrable as a diminishing stainability and becomes visible in 1-4 h after wounding.
 - In the positive zone, the activity of adenosine triphosphatase and esterase increases within 1 h after injury, amino-peptidase by 2 h, acid phosphatase by 4 h and alkaline phosphatase by 8 h (Fig. 17.2). These changes can be demonstrated for a few days after death, if autolysis is prevented by refrigeration.

Differentiation 17.1: Antemortem and postmortem wounds

S.No.	Feature	Antemortem wounds	Postmortem wounds
1.	Hemorrhage	Abundant, copious	Slight or absent
2.	Nature	Arterial	Venous
3.	Signs of spurting	Present on body and clothes	No evidence
4.	Coagulation	Firmly coagulated blood	No clotting or soft clot
5.	Extravasated blood	Infiltrate in and around injured tissues and resist washing	Tissues are not deeply stained, can be easily washed with water
6.	Wound edges	Swollen, everted and retracted	Do not gape and edges are closely approximated
7.	Vital reaction	Present	Absent
8.	Histological examination	Evidence of infiltration by leucocytes, macrophages, formation of new capillaries, fibroblasts	No sign of cellular infiltration or proliferation
9.	Histochemical examination	Increased activity of adenosine triphosphatase, esterase, amino-peptidase, acid and alkaline phosphatase. Increase in serotonin and free histamine	No enzyme activity

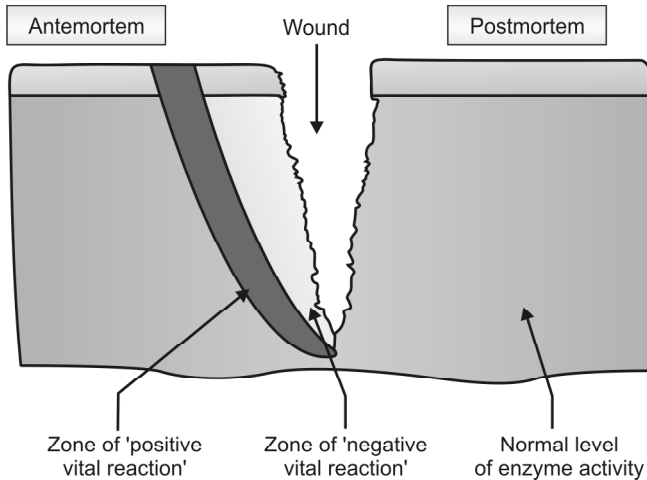

Fig. 17.1: Enzyme activity in antemortem and postmortem wound

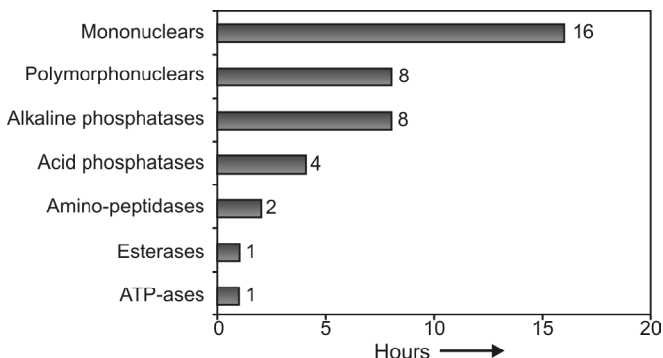

Fig. 17.2: Age of wounds

Q. Whether the time of infliction of the injury can be determined?

It is not possible to determine the exact age of a wound by naked eye or histopathological examination. Only an approximate time can be determined (Table 17.3). Moreover, the changes vary according to the size and type of wound, the tissue, and age and health of the patient.

Biochemical timing

- It depends upon the measurement of histamine and serotonin contents of the injured tissue.
- Serotonin becomes maximum in about 10 min and histamine in 20-30 min after wounding.
- To establish the antemortem nature of the wound, the level of histamine should be at least 50% greater and that of serotonin, at least twice the concentration of the control samples.
- Postmortem wounds do not show any increase.

Connective tissue histochemistry

- **Fibroblasts:** It shows increased RNA content in the cytoplasm, prominent glycogen and metachromatic granules.
- **Mucopolysaccharides:** They disappear immediately after injury (abrasion, bruises and electric marks), but reappear during healing process. But they can be seen in antemortem hanging and strangulation marks.
- **Fibrin:** In 4-12 h: network of fine fibrils are seen; > 24 h: coarse fibrils; > 4 days: small concentrated areas appear; > 2 weeks: solid areas predominate; > 1 month: granular areas appear amid solid areas; and at > 4 months: only granular appearance.
- **Elastic tissue:** In antemortem wounds these are wavy and straight in postmortem wounds.

Table 17.3: Age of the wounds

S.No.	Age	Gross appearance	Microscopic
1.	4 h	Reddish with clotted blood	Nothing specific, but some extravascular emigration of leucocytes may be seen
2.	12 h	Edges of wound are gaping, reddish and swollen	Margination of leucocytes (neutrophils); lymphocytes and monocytes appear
3.	12-24 h	Small wound may show scab	Macrophages and mononuclear cells increases
4.	48 h	Scab, pus may form	Maximum leucocytic infiltration, fibroblasts and elastic fibres are seen
5.	72 h	Epithelial growth clearly visible	New capillary buds seen, granulation tissue forms
6.	4-5 days	Epithelialization of small wounds complete	Profuse growth of capillaries, hemosiderin, new collagen fibrils and giant cells appear
7.	6-7 days	Fibrous scar may be seen in small wounds	Lymphocytes are maximum, epithelium grows on the surface
8.	10-14 days	Vascular scar is formed, later it becomes dense and avascular	Fibroblasts are active, collagen fibres are laid, vascularity decreases, cellular reaction subsides

• **Esterases:** Two fractions of the esterase pattern show up more intensely in antemortem wounds, as compared to postmortem wounds or undamaged skin using disc electrophoresis.

Q. Can a fatal internal injury be present without any external injury?

Yes. Sometimes, the weight of the individual applied on the upper abdomen of another may cause laceration of the liver and death without leaving any visible injury mark. Manual strangulation and smothering may not leave any external signs of trauma. Fractures of ribs, vertebrae or pelvis with accompanying fatal visceral injuries can occur without external indications of serious violence.

Q. Which of the injuries caused death?

When there is more than one wound, it is necessary to determine which one of them caused death, since the wounds may not have been made by the same assailant or at the same time.

Q. How long did the victim survive and could he have carried out any voluntary acts after receiving the injury?

It is usually not possible to opine from an examination of wounds in a dead body as to how long the person might have lived or how much voluntary activity he might have performed before death, after receiving the injury. Unless, it can be proved that a particular injury would immediately be incompatible with life, it is rarely possible to state that the deceased could not have performed some activity (speaking, walking or running) after receiving the injury. Most injuries do not cause sudden death or rapid loss of function (details in Chapter 12).

- A person may remain conscious for several minutes before dying from a severe intracranial injury.
- Muscular powers are retained in ruptures of liver, spleen or kidneys, unless there is marked immediate blood loss.

Q. Would the victim have survived, had he been given immediate medical care?

It depends on the nature and extent of injuries, as there is individual variation.

Q. Can the wounds be altered from their original appearance?

The wounds may be altered in many ways.

- In the living, the wound may be altered by surgical procedures and healing.
- In the dead person, the wound might have been deliberately altered by the assailant to mislead the investigators or by resuscitative measures applied or by insects, animals and decomposition.

Q. Whether the injuries can be produced by more than one type of weapon?

Several persons with different types of weapon may attack the victim producing diverse types of injuries.

Q. What is the relationship of trauma and natural disease?

Relationship of trauma and disease is important mainly for two reasons: compensation and insurance.

- Trauma and myocardial infarction:** Heart attack may occur while working, either incidentally (normal progression of chronic disease) or due to unusual physical/mental strain. A blow or physical

trauma may precipitate myocardial infarction or arrhythmia. If the attack occurs within minutes after unusual effort, the causal connection can be established. It may occur few days later due to subintimal hemorrhage in coronary artery leading to coronary thrombosis.

- Physical effort can damage a diseased heart due to unusual work or doing unfamiliar or unaccustomed work or accidents.
- Causal connection can be established with certainty only in direct trauma to the heart during work.

ii. **Trauma and neoplasia:** In some cases there is apparent relationship, between tumor and some preceding trauma to the part, e.g. development of osteogenic sarcoma and osteoclastoma after injury, malignancy in burn scars or on the skin adjacent to a chronic osteomyelitic sinus.

Since trauma disrupts tissue, it might activate a pre-existing tumor to grow and spread more rapidly. In accepting a relationship between trauma and malignancy, following *Ewing's postulates* should be satisfied:

- i. The tumor site prior to injury was normal.
- ii. Undeniable and adequate trauma to disrupt the continuity must be proved.
- iii. The tumor followed the injury within a reasonable time interval (between a minimum of 3-4 weeks and maximum of 3 years after receipt of injury).
- iv. The tumor must have originated in the part of the body that has sustained the injury.
- v. The tumor must be of histological type that could originate from the cells that have been disrupted by the trauma.

iii. **Trauma and nervous system:** Some instances are there wherein trauma (head injury) was subsequently followed by meningitis, epilepsy, psychosis and rupture of congenital cerebral aneurysm.

Traumatic epilepsy: Sometimes, it is a late effect of a depressed fracture of the skull. Traumatic epilepsy usually manifests as a tonic and clonic fits which may be difficult to differentiate from idiopathic epilepsy, if injury occurred in early life. When fits begin within weeks to upto 2 years of a major head injury (depressed fracture impinging on the underlying cortex, often in the parietotemporal area) in a person who never had fits before, the diagnosis is easier.

Injury Report

An injury report is a form of medico-legal report (MLR) giving the details of the condition of a patient, solicited

for legal purposes. Casualty medical officer or any other medical officer may be called upon to examine the injured person.

Salient Features

- Medico-legal injury cases should be examined without delay at any time of the day or night and are prepared immediately after the examination is done.
- The medical practitioner should enter all details of examination of the injured person in a **Medico-legal Register** in his own handwriting with a ball-point-pen. It should be prepared in duplicate, one copy of which is given to the IO in a sealed cover and the other retained for future reference. This register is a confidential record and should be in safe custody of the medical officer. It has to be produced in the court of law, if summoned.
- The report should be written legibly and in understandable English. Cutting/overwriting should be avoided and all corrections should be properly initialed.
- Medical terminology, jargon, abbreviations ('#' for 'fracture' or 'c.l.w' for 'contused lacerated wound') and an unduly technical description should be avoided.
- The practitioner should ensure that the report contains both the patient's history and examination findings.
- A complete list of the injuries or conditions complained of by the patient along with line diagrams (pictograph) showing the location of the injury should be present. Color photographs of injuries are recommended.
- Details of all sample and specimens should appear in the report to establish the chain of custody. Failure to collect, destruction or loss of such an exhibit is punishable under Sec. 201 of IPC.
- The report should be impartial and unbiased, comprehensible and easy to read. Further, it should be clear about the opinion regarding the nature, cause and duration of injury.
- Whenever possible, a senior faculty should be asked to review and comment upon the report, particularly in complicated cases. It is difficult to alter the report once it has been issued.
- The report should always be signed by the medical practitioner along with date, full name, registration number, qualifications, designation and current employment.

An injury report comprises of three parts as given in Flow chart 17.1.

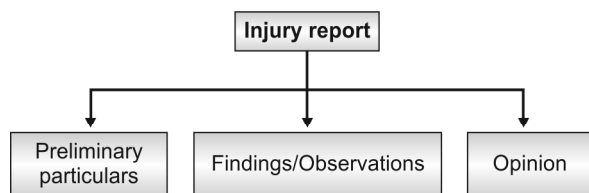
Flow chart 17.1: Contents of an injury report**Preliminary Particulars**

- i. Serial number, admission number.
- ii. Preliminary particulars: Name, age, sex, address, and father's/guardian's name.
- iii. Date, time, and place of examination.
- iv. Name and number of the accompanying police constable and police station to which he belongs. A police case reference number where appropriate, if already reported (DDR/FIR No.)
- v. Name of the person who accompanied the injured person with address and relation.
- vi. If an unconscious patient is brought for examination, the name and address of the person bringing that patient is noted.
- vii. Brief statement of the injured, as to how he was injured.
- viii. Two identification marks.
- ix. Size of the victim, i.e. stature, weight and development.
- x. Informed consent of the person for examination.
- xi. If the condition of the patient is serious, dying declaration should be recorded.

Findings/Observations

General physical examination: Consciousness, orientation, pulse, temperature, blood pressure and reaction of pupils to light are to be noted.

Following are the various entries in the injury report

- i. **Nature of each injury:** All injuries observed, even insignificant should be noted. Nature of injuries, i.e. abrasion, contusion, laceration, incised wound, etc. should be noted. Multiple injuries can be grouped anatomically, e.g. injuries of the head, of the trunk or of limb. A lens should be used to get an accurate idea of the nature of edges, ends and floor of the wound. Presence of any foreign material in wound, e.g. glass, hair or dirt should be noted. Features that may help in differentiating the common injuries are given in Diff. 17.2.
- ii. **Size, shape and direction of each injury:** All injuries should be measured with a tape and never guessed and amount of blood extravasated should be measured, and photographs (wherever possible) or sketches showing the position and size of the wound are desirable.
 - Shape of the wound, e.g. circular, oval or triangular should be noted and also the beveling of the edges.
 - Direction of the wound, i.e. horizontal, vertical or oblique should be noted with regard to anatomical position of the body.
- iii. **Part of body on which injury is inflicted:** Exact situation of wound with reference to some

Differentiation 17.2: Lacerated, incised and stab wound

S.No.	Feature	Lacerated wound	Incised wound	Stab wound
1.	Causative object	Blunt	Sharp edged	Pointed sharp
2.	Site	Usually over bony prominences	Anywhere	Usually over chest, abdomen or neck
3.	Shape	Irregular	Spindle shaped	Spindle shaped, but depends on the weapon
4.	Margins	Irregular	Clean cut and everted	Clean cut
5.	Dimensions	Variable	Length greater than depth, gaping	Depth greater than length
6.	Hair and blood vessels	Crushed	Clean cut	Variable
7.	Hemorrhage	Not pronounced, except in scalp	Profuse	Variable, may be concealed internally
8.	Surrounding abrasion and bruise	Usually present	Absent	May be seen (hilt mark)
9.	Foreign bodies	Present	Absent	May or may not be present

anatomical landmark, e.g. midline, bony structure or umbilicus should be mentioned. Technical terms should be avoided as far as possible.

- For example, when assessing a bruise, the examiner needs to document its size (length and width), shape, location, color(s), distinction of margins, any particular pattern and whether indurated or painful.

Opinion

- Simple, grievous and dangerous injury:** Against each injury, it should be noted whether it is simple, grievous or dangerous. Injured person must be kept 'under observation', if nature of particular injury cannot be made out at the time of examination, e.g. head injury or abdominal injury. In all injuries, when fracture of a bone is suspected, an X-ray should be done for confirmation.
- Whether an injury is simple, grievous or dangerous, is decided on the basis of *status of injury at the time of infliction* and not after medical/surgical intervention. When deciding the question one has to only regard the nature of the injury itself. If left untreated, would the injury have led to the defined result?
- Weapon used to inflict the injury:** In many cases, examination of the wound and clothing give fairly definite information about the kind of weapon. With stab and incised wound, there is not much difficulty.
- Any weapon sent by the police which is alleged to have been used in producing injuries should be examined for marks of bloodstains, hair or pieces of cloth adherent to it, and should be returned to the police after it is sealed.

- Clothes should be examined for the presence of cuts, tears or burns and it should be seen whether these correspond to the injuries on the body.

iii. **Duration of injuries:** Opinion is based on the state of healing of the injuries as was recorded in the column of examination of the injuries.* However, the Supreme Court has stated that a doctor can never be absolutely certain on the point of the time of infliction of injuries.

iv. **Cause of the patient's condition:** The court usually wants to know whether the injury for which damages are claimed or punishment sought was caused, aggravated or accelerated by the accident or events complained of. Opinion on the precipitation factor or cause of the patient's condition is based on the history and the nature of injuries on his/her person.

- Whether the weapon was dangerous or not?**

Doctor is guided by **Sec. 324 and 326 IPC.**

Handing Over the Report

The initial or provisional report should be made available immediately. A subsequent report (supplementary report) may be given, once the investigation results (reports of blood examination, X-rays and CT scans) become available which reflects the final conclusions drawn from the examination findings that was available at the time of the initial consultation.

Remarks: When a victim of suicide, homicide or accident dies in hospital, the medical officer should report the matter to the police immediately. When a dead body is brought to the hospital, the injuries should not be examined and a postmortem examination is advised.

* When opining on the duration of the injuries, undue and complete dependence is placed on the history given by the patient or his/her relatives; while the doctor's own observations regarding the features of the injuries are often not taken into consideration or overlooked.

MULTIPLE CHOICE QUESTIONS

- Punishment for culpable homicide not amounting to murder is dealt under:** TN 11

- | | |
|-----------------|-----------------|
| A. Sec. 299 IPC | B. Sec. 300 IPC |
| C. Sec. 302 IPC | D. Sec. 304 IPC |

- IPC section dealing with dowry death:**

Punjab 08; DNB 10; Orissa 11

- | | |
|--------------|--------------|
| A. 307 IPC | B. 304 IPC |
| C. 304 A IPC | D. 304 B IPC |

- If a woman is assaulted by her husband then he is charged under:** FMGE 11

- | | |
|-------------------|-------------------|
| A. Sec. 498 A IPC | B. Sec. 304 A IPC |
| C. Sec. 304 B IPC | D. Sec. 504 IPC |

- IPC section for grievous injury:**

JIPMER 03; Kerala 06, 08; Punjab 09

- | | |
|-------------|-------------|
| A. Sec. 420 | B. Sec. 320 |
| C. Sec. 299 | D. Sec. 351 |

5. **Grievous injury includes all, except:**
PGI 03, 10; Manipal 06; CMC (Vellore) 10
A. Emasculation
B. Loss of 15 days work
C. Permanent disfigurement
D. Fracture of bones
6. **False about grievous hurt:** *AIIMS 07*
A. Loss of one kidney
B. Loss of hearing in one ear
C. Loss of vision of one eye
D. Abrasion on face
7. **A 25-year-old person developed right corneal opacity following injury to the eye. Corneoplasty of right eye was done and vision was restored. Medico-legally such injury is:** *AI 04; TN 06*
A. Grievous
B. Simple
C. Dangerous
D. Serious
8. **Simple fracture of terminal phalanx of the little finger:** *UP 04*
A. Simple injury
B. Grievous injury
C. Dangerous injury
D. None
9. **Injury that comes under Sec. 320 IPC:** *Bihar 10*
A. Abrasion over face
B. Nasal bone fracture
C. Epistaxis
D. Lacerated wound over scalp
10. **Teacher slaps a student which results in permanent deafness, the injury is:** *AIIMS 09*
A. Simple injury
B. Grievous injury
C. Dangerous injury
D. Being a teacher it is not an illegal act
11. **Amount of blood loss when the clot is of fist size:** *Rohtak 06; UP 10*
A. 100-200 ml
B. 250-300 ml
C. 300-400 ml
D. 400-500 ml
12. **True about reactionary hemorrhage following surgery:** *UP 10; MP 10; Orissa 11*
A. Hemorrhage occurring within 48 h
B. Hemorrhage occurring within 36 h
C. Hemorrhage occurring within 24 h
D. Hemorrhage occurring during surgery
13. **Secondary hemorrhage is seen:** *AP 06; FMGE 10; Bihar 10; Jharkhand 11; AI 11*
A. During anesthesia
B. 6 h after surgery
C. 24 h after surgery
D. 7-14 days after surgery
14. **Neurogenic shock is characterized by:** *BHU 11*
A. Cool and moist skin
B. Increased cardiac output
C. Decreased peripheral vascular resistance
D. Bradycardia
15. **Not a manifestation of anaphylactic shock:** *CMC (Ludhiana) 11*
A. Hypotension
B. Vasoconstriction
C. Bronchospasm
D. Laryngeal edema
16. **All are true of septic shock, except:** *MP 11*
A. Tachycardia
B. Warm skin
C. Decreased cardiac output
D. Caused by gram-positive bacteria
17. **Venous thrombi embolize most commonly to:** *AP 09*
A. Heart
B. Lung
C. Brain
D. Kidneys
18. **Risk of thromboembolism is highest with:** *DNB 08*
A. Deep femoral vein thrombus
B. Anterior tibial vein thrombus
C. Posterior tibial vein thrombus
D. Popliteal vein thrombus
19. **Commonest cause of pulmonary embolism is:** *CMC (Vellore) 09*
A. Fat
B. Amniotic fluid
C. Thrombus
D. Air
20. **Features of pulmonary embolism are all, except:** *CMC (Vellore) 07*
A. Cyanosis
B. Bradycardia
C. Precordial pain
D. Hyperpyrexia
21. **Fat embolism commonly occurs in:** *UP 04*
A. Scurvy
B. Fracture of long bones
C. Paget's disease
D. Psoriasis
22. **A man operated for fracture femur developed dyspnea, severe chest pain, streaky hemoptysis and hypotension on 4th day, cause is:** *PGI 04, 05; AI 05; UPSC 11*
A. Air embolism
B. Fat embolism
C. Pulmonary embolism
D. Meningitis
23. **A woman arrived at the emergency with long bone fracture few hours back with complaints of breathlessness, petechial rashes over chest, probable diagnosis:** *AIIMS 08; CMC (Vellore) 10; JIPMER 11*
A. Air embolism
B. Fat embolism
C. Pulmonary embolism
D. Amniotic fluid embolism
24. **Sudden death occurring after maxillary sinus irrigation is due to:** *DNB 10*
A. Fat embolism
B. Pulmonary embolism
C. Air embolism
D. Maxillary artery thrombosis

Decompression, Radiation and Altitude Sickness

18

Decompression Sickness

Definitions

- **Decompression sickness** (diver's or Caisson disease, 'bends') is a disorder in which nitrogen (main inert gas) dissolved in the blood and tissues by high pressure forms bubbles as pressure decreases.¹
- **Dysbarism** is a term that covers all the adverse effects of pressure.
- **Barotrauma** describes the mechanical damage from gas released into the tissues.

Decompression sickness is hazardous for fliers and divers who are involved in recreational diving (e.g. scuba diving), deep-water exploration and rescue or salvage operations.

At low depths, the greatly increased pressure (e.g. at 100 feet the pressure is four times greater than at the surface) compresses the respiratory gases into the blood and other tissues. During ascent from depths > 9 meters (30 feet), gases dissolved in the blood and other tissues escape as the external pressure decreases.²

Predisposing factors: Exercise, injury, right to left cardiac shunt, obesity, dehydration, alcoholic excess, hypoxia, medications (e.g. narcotics, antihistaminics) and cold.

Signs and Symptoms

The onset occurs within 30 min to 6 h.

- Symptoms are pain in the joints [('bends') in 60-70% cases due to gas bubble formation] with shoulder being the most common site; neurological symptoms ('stagers' in 10-15% cases) with headache and visual disturbances; skin manifestations (10-15% of cases) like itching, sensation of tiny insects crawling over the skin (*formication*) and pruritic rash, and pulmonary decompression sickness ('chokes') with pleuritic substernal pain, persistent cough and dyspnea (rare in divers).

- Other symptoms include numbness, confusion, nausea, vomiting, loss of hearing, weakness, paralysis, dizziness, vertigo, dyspnea, paraesthesias, aphasia and coma.
- Sequelae include hemiparesis, neurologic dysfunction and bone damage.

Treatment

- i. Administration of 100% oxygen.
- ii. Aspirin may be given for pain, but narcotics should be used cautiously.
- iii. Rapid transportation to a treatment facility for recompression, hyperbaric oxygen, hydration treatment of plasma deficits, and supportive measures is necessary.

Autopsy in Decompression Sickness

Skin diving fatalities are usually caused by drowning. Head and cervical injuries may be responsible for loss of consciousness and drowning in individuals drowning in shallow water. With scuba diving fatalities, investigation of the equipment and circumstances is usually more important than the autopsy as drowning is the terminal event. Some of the important features that may be found during autopsy are given in Table 18.1.

- Photograph the victim as recovered and after removal of suit and other diving gear.
- Take X-ray chest, elbows, hips and knees.
- Complete toxicological sampling should be carried out.

Ionizing Radiation Reactions

The extent of damage due to radiation exposure depends on the quantity of radiation delivered to the body, dose rate, organs exposed, type of radiation (X-rays, neutrons, γ rays, α or β particles), duration of exposure and energy transfer from the radioactive wave to the exposed tissue.

Table 18.1: Autopsy changes in decompression sickness (diving accidents)

Region	Possible and expected findings
External examination	Mask, fins, weight belt, life vest, scuba tank may be missing. Clothing may be torn. Mask, mouthpiece or exhalation hose may contain vomitus. Cyanosis, cherry red coloration, marbling. Facial edema, froth in mouth and nostrils. Mottled pallor of tongue and bite marks. Crepitation from subcutaneous emphysema. Antemortem and postmortem abrasions, contusions, lacerations, bites or puncture wounds may be seen.
Head and neck	Fracture of skull and cervical spine. Gas bubbles in cerebral arteries, nitrogen bubbles in cerebral vessels. Subdural and subarachnoid hemorrhages, cerebral edema with ischemic necrosis and focal hemorrhages.
Eyes and ears	Rupture of tympanic membrane, gas in retinal vessels (air embolism).
Chest, tracheobronchial tree and lungs	Foam, aspirated vomitus, pneumothorax and pneumomediastinum. Lacerations, bullae and atelectasis of lungs. Pulmonary edema and petechial hemorrhages. Nitrogen bubbles in precapillary pulmonary arteries and pulmonary fat embolism in decompression sickness.
Blood (from heart)	Air embolism, alcohol intoxication and CO poisoning.
Heart	Ischemic heart disease, patent foramen ovale.
Other organs	Fatty change of liver, ischemic infarction of many organs.
Spinal cord	Nitrogen bubbles in spinal cord arteries.
Bone and joints	Aseptic necrosis (<i>dysbaric osteonecrosis</i>) most often in head of femur, distal femur and proximal tibia. Nitrogen bubbles in and about joints and in periosteal vessels.

In US, the National Committee on Radiation Protection has established the maximum permissible radiation exposure for occupationally exposed workers (≥ 18 years) as 0.1 rad/week for the whole body (but not to exceed 5 rad/year) and 1.5 rad/week for the hands (routine chest X-rays deliver 0.1-0.2 rad).

The **acute radiation syndrome** may be dominated by CNS, GIT or hematologic manifestations depending on dose and survival.

- Fatigue, weakness, and anorexia can occur following exposures exceeding 50 cGy [1 rad = 0.01 gray (Gy) = 1 cGy].
- Hematopoietic effects consisting of anemia, platelet loss and bone marrow suppression can occur 1-3 weeks after exposures exceeding 100 cGy.
- Whole body exposure levels of 1000-3000 cGy destroy GIT mucosa which may lead to toxemia and death within 2 weeks.
- Total body doses > 3000 cGy cause widespread vascular damage, cerebral anoxia, hypotensive shock and death within 48 h.

Acute (Immediate) Ionizing Radiation Effects

- *Skin and mucous membranes*: Erythema, epilation, destruction of fingernails or epidermolysis.
- *Hematopoietic tissues*: Bone marrow suppression.

- *CVS*: Pericarditis with effusion.
- *Reproductive system*: Aspermatogenesis, sterility, cessation of menses or abortion.
- *RS*: Pneumonitis.
- *GIT*: Mucositis.
- *Liver*: Hepatitis.
- *Renal*: Nephritis.

Systemic Reactions (Radiation Sickness)

Radiation sickness occurs when X-ray therapy is given over the abdomen, less often with thorax and rarely when given on the extremities. The basic mechanism is not known.

Symptoms include anorexia, nausea, vomiting, weakness, exhaustion, lassitude and in some cases prostration may occur. Dehydration, anemia and infection may follow.

Death after whole body acute lethal radiation exposure is usually due to hematopoietic failure, GIT mucosal damage, CNS damage, widespread vascular injury or secondary infection.

Prevention: Persons handling radiation sources can minimize exposure to radiation by decreasing the time of exposure, maintaining distance and shielding. Special protective clothing is necessary to protect against contamination with radioisotopes.

Nuclear Terrorism

The proliferation of radiation equipment and nuclear energy plants, terrorism and the increasing need for transportation of radioactive materials have made necessary hospital plans for managing patients who are accidentally exposed to ionizing radiation or are contaminated with radioisotopes. The threat of nuclear terrorism is raising the level of awareness about medical aspects of ionizing radiation exposure.

Treatment

The success of treatment of local radiation effects depends on the extent, degree and location of tissue injury.

- i. Particulate or radioisotope exposures should be decontaminated in designated confined areas.
- ii. Ondansetron, 8 mg orally twice or thrice daily, is given for nausea and vomiting.
- iii. Blood and platelet transfusions, blood stem cell transplantation, bone marrow transplants, antibiotics, fluid and electrolyte maintenance and other supportive measures may be useful.
- iv. Recombinant hematopoietic growth factors have been effective in accelerating hematopoietic recovery.

Altitude Illness

Five manifestations of altitude illness are:

- i. Acute mountain sickness
- ii. High-altitude pulmonary edema
- iii. High-altitude encephalopathy
- iv. Subacute mountain sickness
- v. Chronic mountain sickness (Monge's disease)

Lack of sufficient time for acclimatization, increased physical activity and varying degrees of health may be

responsible for the acute, subacute and chronic disturbances that result from (hyperbaric) hypoxia at altitudes > 2000 meters (6560 feet).

Acute Mountain Sickness (AMS)

The severity of acute mountain sickness correlates with altitude and rate of ascent.

Initial manifestations include headache (most severe and persistent symptom),³ lethargy, drowsiness, dizziness, chilliness, nausea, vomiting, facial pallor, dyspnea and cyanosis.

Later, there is facial flushing, irritability, difficulty in concentrating, vertigo, tinnitus, visual and auditory disturbances, anorexia, insomnia, dyspnea and weakness on exertion, increased headaches (due to cerebral edema), palpitations, tachycardia, Cheyne-Stokes breathing and weight loss.⁴ More severe manifestations include pulmonary edema and encephalopathy.

Voluntary periodic hyperventilation may relieve symptoms. In most individuals, symptoms clear within 24-48 h, but in some instances, if the symptoms are sufficiently persistent or severe, the patient must return to lower altitudes.

Treatment: Definitive treatment is immediate descent, which is essential, if reduced consciousness, ataxia or pulmonary edema occurs.

Administration of oxygen, 1-2 l/min, will often relieve acute symptoms. If immediate descent is not possible, portable hyperbaric chambers can provide symptomatic relief depending on altitude and severity.

Acetazolamide, 250 mg every 8-12 h or dexamethasone, 8 mg initially, followed by 4 mg every 6 h for as long as symptoms persist is recommended.

MULTIPLE CHOICE QUESTIONS

1. Caisson disease is due to:

- A. Fat embolism
- B. Air embolism
- C. Foreign body embolism
- D. Amniotic fluid embolism

AIIMS 10

2. Decompression sickness occurs:

- A. Ascend low to high atmospheric level
- B. Descend high to low atmospheric level
- C. Ascend high to low atmospheric level
- D. Causes oxygen toxicity

UP 04

3. Earliest symptom of acute mountain sickness is:

- A. Blurring of vision
- B. Fever
- C. Nausea and vomiting
- D. Headache

UP 05

4. The following are associated with high altitude, except:

- A. Cerebral edema
- B. Hypoventilation
- C. Visual disturbances
- D. Dyspnea

Karnataka 11

Starvation Deaths

19

Definitions

- **Starvation** is the result of irregular and continuous deprivation of nutrients (food alone or food and drink) necessary for the maintenance of the body.
- **Inanition:** It refers to the exhausted state due to prolonged undernutrition caused by lack of assimilation of food by the tissues.

Starvation can be:

- **Acute starvation or total fasting** which results from sudden and total withholding of food, or food and drink.
- **Chronic starvation or malnutrition** which results from prolonged, but gradual and continuous deficiency in the intake of food and nutrients.

Mode of Starvation

Failure of Taking Food

- Ignorance:* Lack of knowledge of gross nutrition value of foodstuff, particularly among uneducated masses.
- Diseased conditions:* Low intake (e.g. diabetes), loss of appetite (e.g. major depressive disorder), deficient absorption (e.g. celiac disease) or inability to eat (e.g. carcinoma esophagus).
- Deliberate:* Deliberate improper feeding and withholding of food in case of unwanted baby, old, invalid or diseased family member.
- Circumstantial:* Accidents (e.g. shipwreck, air crash, colliery entombment) or famine.

Refusal to Take Food

- In observance of religious rituals which is common in India.
- Intentional fasting as a form of protest against some alleged injustice—hunger strike or fast-into-death.
- Mental illnesses like schizophrenia and anorexia nervosa.

Historically, starvation has been used as a death sentence. From the beginning of civilization to the Middle Ages, people were immured or walled in, and would die for want of food. In ancient Greco-Roman societies, starvation was sometimes used to dispose of guilty upper class citizens, especially erring female members of patrician families.

Pathophysiology

Individuals experiencing starvation lose adipose and muscle mass as the body breaks down these tissues for energy. Initially, the body's glycogen stores are used up in about 24 h. After that, the main means of energy production is lipolysis. Adipose tissue releases free fatty acids in starvation and these are used by many as fuel. Furthermore, in the liver they are the substrate for synthesis of ketone bodies (which are major metabolic fuels for skeletal and heart muscle and brain). There is an increase in plasma free fatty acids and ketone bodies as starvation progresses which can be detected in urine.^{1,2}

Constituent	Starvation	
	40 h (mmol/l)	7 days (mmol/l)
Glucose	3.6	3.5
Free fatty acids	1.15	1.19
Ketone bodies	2.9	4.5

Signs and Symptoms

Acute Starvation

In the beginning, there is initial feeling of hunger and hunger pains for first 2 days with craving for food wearing off very rapidly. Intense thirst is felt along with epigastric pain and subsequent loss of sense of thirst. This is followed by both mental and physical lethargy, fatigue, irritability, loss of libido and progressive loss of weight. Later, emaciation sets in and the body emits offensive odor. As the starvation continues, the lethargy becomes extreme, with mental

impairment, loss of self-respect and interest in everything.

Characteristic Findings

- *Skin*: Dry, dirty, lusterless, loose, cracked and inelastic with increase of pigmentation, creases and wrinkles.
 - *Face*: Eyes—shrunken, pupils—dilated, lips—dry and cracked, cheek—shallow with prominent malar bones (loss of Bichat's fat pad is among the last subcutaneous adipose depots to disappear).³
 - *Tongue*: Dry, furred and coated, foul smelling breath.
 - *Temperature*: Hypothermia with sensitivity to cold.
 - *Blood pressure*: Hypotension.
 - *Pulse*: Quick, weak and feeble.
 - Abdomen concave, prominent ribs and hip bones.
 - *Bowel*: Constipated in early phase, followed by diarrhea and dysentery.
 - *Renal*: Oliguria with concentrated, highly acidic urine.
 - Muscle atrophy leading to weakness.
 - All bony joints and bones look prominent.
- Progressive cardiac insufficiency leads to death. Loss of 40-50% of original body weight usually leads to death.

Chronic Starvation

- Anemia (first sign), hypoproteinemia, emaciation, weak pulse and blood pressure, cyanosis and edema of feet, legs and face with ascitis, hepatitis, diarrhea or dysentery.
- Reduced resistance to infections in general and development of bronchopneumonia, tuberculosis and enteritis along with poor wound healing.
- In females, irregular menstruation can occur.
- Loss of weight is very rapid in the first place, but becomes slower after 3 months.
- In the terminal stages, adults may experience a variety of neurological and psychiatric symptoms, including hallucinations and convulsions, as well as severe muscle pain and disturbances in heart rhythm.

Fatal period

- Total withholding of food and water: 14-21 days.⁴
- With total deprivation of food only: 3-6 weeks (8-12 weeks in some cases).

Factors influencing the fatality

- i. *Age*: Children and infants are most vulnerable. Old person stands starvation better.
- ii. *Sex*: Women stand starvation better than men due to their body fat.
- iii. *Body condition*: Fatty and healthy individual stands starvation better.
- iv. *Environmental factors*: Exposure to cold and extreme heat shortens life.
- v. *Intercurrent infection*: It may cause early death.
- vi. *Physical exertion*: It will enhance the effects of starvation.

Postmortem Findings

Typical picture of emaciation, and exclusion of any other coexisting cause of death are pre-requisite for a definite diagnosis of death due to starvation. The main autopsy finding is emaciation with loss of body weight and organ weights.

- i. Complete lack of fat in the subcutaneous and deep fat depots.
- ii. *Skin* is pale and cadaverous in most of the cases and dark brown in few.
- iii. There is severe atrophy of skeletal muscles, lungs, heart, liver, spleen, kidneys, endocrine and reproductive organs (ovaries or testes), except for the brain.⁵ In infants, complete atrophy of thymus is pathognomonic of starvation.
- iv. *GIT*: Stomach and small bowel are empty along with presence of dry stools in the colon. Even foreign bodies may be found in the colon (starving person may try to eat everything accessible prior to death).
 - There is atrophy of GIT with thin parchment-like translucent walls and loss of mucosal folds.
 - Gallbladder bigger in size and distended with bile (food acts as the natural stimulant of bile excretion).⁶
 - The small intestinal wall appears swollen with reddish discolored mucosa and ulcerations of the mucosa of the colon, described as '*pseudo-dysentery*'.
- v. Edema and peritoneal effusions may occur.
- vi. *Liver*: It may show centrilobular necrosis due to protein deficiency.
- vii. *Kidneys*: It may show atrophy of nephrons.

Typical autopsy findings in starvation⁷

- Emaciation with sunken eyes and loss of Bichat's fat pad
- Complete disappearance of body fat with pronounced rib cage
- Loss of adipose tissue of the mesentery
- Disuse atrophy of the GIT with translucent small intestinal walls
- Distention of gallbladder

Medico-legal Questions

Q. Whether the death was caused by starvation?

The diagnosis of starvation is done on the basis of history and postmortem findings.

Before opining on starvation as cause of death, the doctor should rule out tuberculosis, carcinoma, stricture of esophagus, anorexia nervosa, radiation sickness, pernicious anemia, inflammatory bowel disease and Addison's disease (chronic adrenocortical insufficiency).

Q. Whether it was suicidal/homicidal/accidental starvation?

If the diagnosis of death as a result of starvation is established, the underlying cause of starvation has to be determined: any pre-existing disease or deliberate withholding of food or neglect.

- **Suicidal:** Some individuals starve voluntarily for the fulfillment of their grievances. Sometimes, prisoners, mentally ill or hysterical women may refuse to take food. Fasting may also be undertaken to attract public attention. Right to life is guaranteed under the Constitution of India, so forcible feeding in these individuals is lawful.

- **Homicidal:** These cases are related to elderly person or victims of child abuse. It is mostly seen in illegitimate children who are starved to death, by depriving them of food and exposing to severe cold.
- **Accidental:** It may occur during famine, shipwreck or trapped in mines or landslides during earthquakes.
 - Deaths caused by starvation are mostly natural deaths in India, accidental cases are also common.
 - It relatively rare in US/industrialized countries. For the most part, they occur either as a result of child abuse, fasting or in mentally ill person.

MULTIPLE CHOICE QUESTIONS

- A person on fasting for 7 days, the source of energy is:** *NIMS 11*
 - Acetone
 - Acetoacetate
 - Glucose
 - Alanine
- Brain in starvation uses:** *TN 11*
 - Amino acids
 - Cellulose
 - Ketone bodies
 - Glycerol
- In starvation, last to disappear:** *JIPMER 10*
 - Buccal fat
 - Fat around the abdomen
 - Fat around the eyes
 - Fat in the mesentery
- If food and water is withheld then the person will die after:** *WB 11*
 - 1-2 days
 - 2-5 days
 - 7-10 days
 - 15-20 days
- In starvation death, atrophy is seen in all, except:** *Maharashtra 08*
 - Heart
 - Kidney
 - Liver
 - Brain
- Gallbladder in starvation death is:** *TN 08*
 - Contracted
 - Distended
 - Mummified
 - Not affected
- In starvation, all are true, except:** *FMGE 09*
 - Shrunken gallbladder
 - Translucent intestine
 - Lack of fat in mesentery
 - Prominent rib cage

Definitions

- **Infanticide** is killing of an infant at any time from birth upto the age of 12 months.
- **Feticide** is the killing of fetus at any time prior to birth.
- **Filicide** (Latin *filii*: son) is deliberate act of killing of a child by the parents.

Infanticide does not include the death of fetus during labor, when it is destroyed by craniotomy or decapitation.

- In Canada, Italy, UK and Australia murder of a child < 1 year of age by his/her own mother is not considered homicide. Instead, the mother is charged with a lesser offence of infanticide, for which the punishment is lesser. This is because such murders could be due to '*post-partum depression*' or '*baby-blues*'.
- In India, there is no such special Act and there is no distinction between the murder of a newborn infant and that of any other individual.

Postmortem Examination of Infants

The relatives should identify the body and radiological examination should be done prior to autopsy.

- Whole-body radiographs (anteroposterior and lateral) are taken.
- Photographs of the external features—frontal pictures of the entire body and close-ups of the face and side of the head as well as any other unusual aspects are taken.

The procedure for autopsy is nearly the same as in adults, except for certain variations. The presence of malformations is often the major consideration and the dissection should be made to preserve anatomic relationships in order to define the abnormal anatomy.

External Examination

- **Clothings and wrappings** should be examined and retained for identification.
- **Measurements:** Head, chest and abdominal circumferences, length (crown-rump, crown-heel, and foot for fetuses) and weight of the body helps to assess the gestational age.

- Distribution and quality of hair over the head and rest of the body are noted. Fontanelle dimensions are measured. Configuration of the ear is examined and plasticity (indicating amount of cartilage) evaluated as an index to developmental stage.
- Facial features are examined and noted and distances between inner and outer canthi are measured, color of the sclera and iris, relative sizes of the pupils and color of the conjunctiva are noted.
- Abnormalities of the shape of the head related to molding, trauma, soft tissue edema, hemorrhage or autolysis.
- **Changes of putrefaction:** It helps in ascertaining the time since death. Bodies of the newborn infants are normally sterile. When they breathe and swallow, microorganisms enter into the body. Therefore, in the stillborn, putrefaction occurs from outside to inwards and in liveborn infants, from within to outwards. Decomposition must be differentiated from maceration, as the latter is a sure sign of a dead-born fetus.
- **Presence or absence of vernix caseosa:** Presence of vernix caseosa is not as useful a sign as its absence, as it indicates that the child had been washed, suggesting that it survived for sometime after birth.
- **Placenta:** Placenta should be weighed to evaluate maturity and any abnormality should also be observed (about 15-20 cm in diameter, central thickness 2.5 cm, weighs 500 g at term).
- **Umbilical cord:** The cut end of the cord should be looked for vital reaction, whether actually cut and tied or torn or any abnormal twists, knots and presence of infection. A cut with a sharp instrument, like scissors or knife will appear clean-cut, but occasionally may appear ragged, if the instrument is relatively blunt.
- All the injuries and bruises (particularly around nose, mouth and frenulum) should be noted.
- Swabs should be taken of every orifice, as if it were a case of sexual assault.

Internal Examination

The *modified Y-shaped incision* from both mastoid to the top of the sternum is used, extending down the midline to the pubis. The *ear-to-ear incision* is used for the removal of the vault of the cranium.

Brain: While reflecting the scalp, note whether there is any subaponeurotic hemorrhage to exclude asphyxia or deep bruises.

Procedure: In fetuses and infants, **Beneke's technique** is used to open the skull. The cranium and dura on both the sides are cut with blunt scissors starting at the lateral edge of the anterior fontanelle extending the incisions along the midline and the lateral sides of the skull. The midline strip about 1 cm wide containing the superior sagittal sinus and the falx is left and also an intact area in the temporal squama on either side, which serves as a hinge when the bone is reflected in a 'butterfly' manner (Fig. 20.1A).

- An alternative method of cutting which follows the cranial suture lines is shown in Figure 20.1B.
- After carefully inspecting the hemispheres, falx cerebri and tentorium cerebelli through the openings, the midline bone and sinus are removed. Injuries to fontanelles (e.g. punctured wounds through anterior fontanelle) and subdural/subarachnoid hemorrhages are looked for.

Neck: This is examined for internal injuries and the trachea for foreign body, froth, mucus or amniotic fluid.

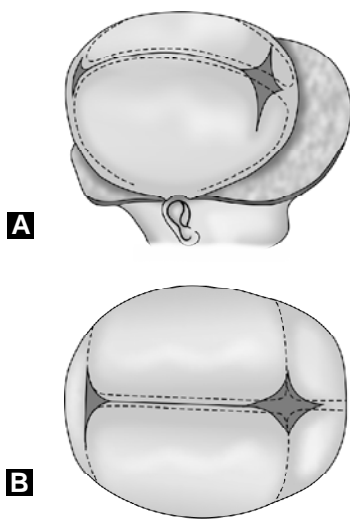

Fig. 20.1: Two methods of opening the calvarium in fetus and neonate (A) Beneke's technique (B) Reflection of cranial bones along the suture lines (For color version see Plate 3)

Thorax: Before opening the thorax, the abdomen is opened first and position of diaphragm is noted by passing a finger.

- The whole chest cavity can be opened under water in order to demonstrate a pneumothorax.
- In infants and fetuses, **Letulle's technique** of en masse removal is the preferred in most cases so that certain rare malformations can be properly preserved, e.g. pulmonary venous connections.
- Note is made of whether there is free blood or fluid, pus or stomach contents present in the thoracic or abdominal cavity, or whether the diaphragm is ruptured or not. If there is any fracture of the ribs, it should be noted.
- Any evidence for malformations or birth-injuries should be meticulously searched which may reveal obvious incompatibility with the continuation of life.
 - The lungs, stomach, heart, genitalia and other viscera are examined for different parameters as outlined below.

Limbs and sternum: They are examined for presence of ossification centres to determine the age of the fetus. Centre of ossification for the calcaneum appears by the 5th month, four divisions of sternum by the 6th month, talus by the 7th month and lower end of femur by the 9th month (36th week). At birth, a centre of ossification is usually present for the cuboid and upper end of tibia (Fig. 20.2).

Age of Fetus

It is determined as given in Table 20.1.

- **Conceptus:** Any product of conception at any stage of development from fertilization until birth including extra embryonic membranes as well as the embryo or fetus.
- **Pre-embryo:** Fertilized ovum upto 14 days after conception, until the implantation occurs.
- **Embryo:** Prefetal product of conception from implantation to the end of 8th week (2nd month or 56 days).
- **Fetus:** Unborn young from the end of 8th week after conception till delivery.
- **Infant:** Child from the time of birth to 1 year of age.
- **Neonate:** Infant in the first 28 days of extra-uterine life.
- **Meconium:** Mixture of bile, mucus and shredded-off mucosa.
- **Vernix caseosa** (Latin *vernix*: varnish; *caseosa*: cheese): White, cheesy substance composed of sebum and desquamated epithelial cells which covers the skin of the fetus.
- **Lanugo hair** (Latin *lanugo*: down, like the fine small hairs of plants): Fine, soft, downy, usually unpigmented hair on the body of the fetus and newborn.

Table 20.1: Determination of age of fetus^{1,2}

Lunar months	Features
1st	Length: 1 cm, weight: 2.5 g. Eyes are seen as 2 dark spots and mouth as cleft.
2nd	Length: 4 cm, weight: 10 g. Eyes and nose recognizable, hands and feet are webbed. Anus is seen as dark spot. Placenta is formed.
3rd	Length: 9 cm, weight: 30 g. Eyes are closed and pupillary membrane appears, nails appear, neck is formed.
4th	Length: 16 cm, weight: 120 g. Sex can be recognized ; lanugo hair is visible on body; pupillary membrane is visible and meconium is seen in the upper part of small intestine. ¹
5th	Length: 25 cm, weight: 400 g. Nails are distinct and soft, vernix caseosa appears on the body. Fine hair on scalp, meconium at the beginning of large intestine. Centre of ossification for calcaneum appears (Fig. 20.2A).
6th	Length: 30 cm, weight: 700 g. Eyebrow and eye lashes appear, eyelids are adherent and pupillary membrane is still present; skin is red and wrinkled for want of fat; testes are close to kidneys and scrotum is empty; meconium is seen in upper part of large intestine.
7th	Length: 35 cm, weight: 900-1200 g. Eyelids are open, pupillary membrane disappears; nails are thick, but do not extend to the tips of fingers and toes; skin is dusky-red, thick and fibrous; meconium present in entire large intestine. Centre of ossification for talus appears (fetal viability) ³ (Fig. 20.2A).
8th	Length: 40 cm, weight: 1-1.5 kg. Scalp hair is thick; nails reach the tips of fingers; skin is not wrinkled; lanugo hair on face; left testes in scrotum, right testes near the external inguinal ring.
9th	Length: 45 cm, weight: 2.5-3 kg. Scalp is covered with dark hair; lanugo hair is seen only in shoulders; vernix caseosa is present over the flexures of joints and neck folds; scrotum is wrinkled and contains both testes. Meconium is near the end of large intestine. ⁴
10th (Full term)	Ossification centres for lower end of femur (36-37 weeks), cuboid and capitate appear (Fig. 20.2A). ⁵ Length: 50-53 cm, weight: 3-3.5 kg. Lanugo hair is seen only in shoulders; nails project beyond finger tips, but reach only the tip of toes; rectum contains dark green or black meconium; six fontanelles are present. Umbilicus is midway between xiphisternum and symphysis pubis. Centre of ossification for upper end of tibia appears (38-40 weeks) (Fig. 20.2B).

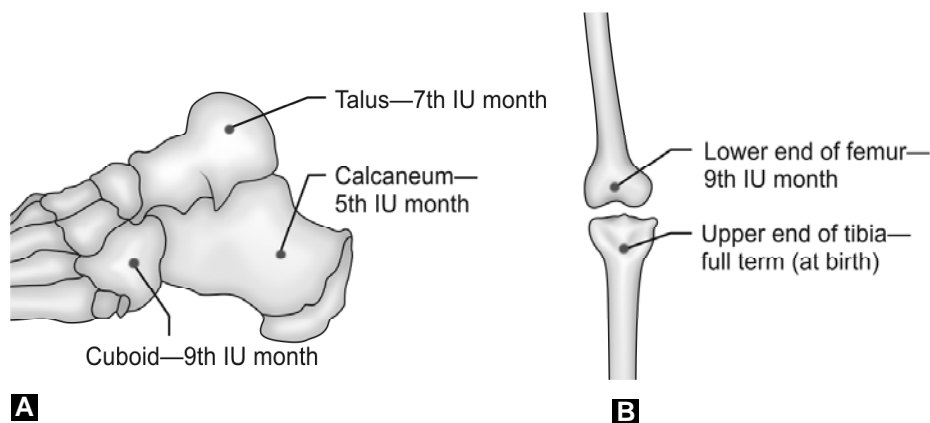

Fig. 20.2: Ossification centres in (A) Tarsal bones (B) Lower end of femur and upper end of tibia

Rule of Hasse

It is a rough method of calculating the age of fetus.⁶

- The length of fetus is measured from **crown to heel** in centimeters.
- During first 5 months of pregnancy—square root of length gives approximate age of fetus in months.
- During the last 5 months—length in centimeters divided by 5 gives age in months.

Non-osseous method of estimating maturity: Progressive development of surfactant-producing alveolar Type-II cells in fetal lungs.

After birth, increase in the length of the child is given in Table 20.2. Length is measured in a child before they are able to stand; height is measured once the child can stand. Birth weight doubles by about 5-6 months of age, triples by about 1 year.⁸

Demonstration of Centres of Ossification

- **Sternum:** The bone is placed on a wooden board and sectioned in its long axis with a cartilage knife which exposes the centres of ossification.
- **Lower end of the femur and the upper end of tibia:** The leg is flexed against the thigh and a horizontal incision made into the knee joint and the patella is removed. A number of cross-sections are made through the epiphysis starting from the articular surface and continuing until the largest cross-section of the ossification centre is reached. In the lower end of the femur, this is seen as brownish-red nucleus which is surrounded by a bluish-white cartilage.
- **Bones of the foot:** The heel of the foot is held by one hand and with the other hand an incision is made through the interspace between the 3rd-4th toes and carried downwards through the sole of the foot and heel.

Diagnosis of fetal death

Ultrasonography: On ultrasonography, absence of all fetal movements for 10 min is taken as evidence of fetal death.

Table 20.2: Length/height of infant/child

Age	Length (cm)
At birth	50
6 months	68
1 year	75
4 years ⁷	100

Features of Dead-Born Fetus

- **Rigor mortis:** It may be seen in dead-born fetus.
- **Maceration:** It is a process of aseptic autolysis.⁹ This occurs when the dead child remains in the uterus for about 3-4 days surrounded with liquor amnii with exclusion of air.
 - *Earliest sign of maceration is skin slippage* of face, back or abdomen which may be seen in 12 h after death in utero. By 24 h, skin is brown or purplish in color.
 - The dead fetus is soft, flaccid with emission of sweetish disagreeable smell, but no gases are formed.
 - Internal organs show autolytic decomposition, but the lungs and uterus remain unchanged for a long time.
 - Cranial compression is seen in ≥ 36 h, desquamation over 75% of body surface is seen in 72 h, overlapping of cranial sutures in ≥ 96 h and the mouth is widely open in ≥ 1 week.

Putrefaction is characterized by an unpleasant odor, greenish discoloration of skin and formation of foul smelling gases. Rarely, the fetus may show adipocere formation.¹⁰

- **Spalding's sign:** A pathognomic sign of intra-uterine death. There is loss of alignment and overlapping of fetal skull bones on X-ray, occurs due to liquefaction of cerebrum and softening of ligamentous structures supporting the vault. It appears in about 7 days after death.¹¹⁻¹³
- **Mummification:** It results from deficient supply of blood or scanty liquor amnii. Fetus is dried up and shriveled in ≥ 2 weeks.
- **Robert's sign:** Appearance of gas shadow in chambers of heart and great vessels may appear by 12 h, but difficult to interpret.
- **Hyperflexion of spine** is more common.
- **Crowding of the ribs shadow** with loss of normal parallelism.

The difference between stillborn and dead-born fetus is given in Diff. 20.1.

Viability of infant: It means physical ability of fetus to lead a separate existence after birth, apart from its mother by virtue of a certain degree of development which depends on biological, physiological and extrinsic factors. *Legally*, the age of viability is 210 days (30 weeks) of intrauterine life.

Differentiation 20.1: Stillborn and Dead-born fetus¹⁴

S.No.	Feature	Stillborn fetus	Dead-born fetus
1.	Definition	Fetus which is born after 28 weeks of pregnancy and which did not breathe or show any other signs of life, at any time after being completely born	Fetus which has died in utero
2.	Condition in utero	Fetus was alive in utero, but dies during the process of delivery	Dead in utero
3.	Predominance	Seen mostly among illegitimate and immature male children in primiparae	No such predominance
4.	Findings	Signs of prolonged labor, like edema, bleeding into scalp, caput succedaneum and severe moulding of head may be seen	<ul style="list-style-type: none"> • Rigor mortis at delivery • Maceration • Spalding's sign • Robert's sign • Mummification
5.	Cause	Anoxia, prematurity, birth trauma or toxemia	Congenital anomaly, ABO and Rh incompatibility

- In UK, a baby is stillborn, if after 24 weeks' of gestation it did not at any time after being completely expelled from its mother, breathe or show any other sign of life.
- In English law, a period of 24 weeks is fixed for the legal age of viability, for the purposes of the Infant Life (Preservation) Act, 1929 as a result of advancement in neonatal medicine and obstetric management.
- In other developed countries, fetal death occurring \geq 20 weeks of fetal life or a birth weight of at least 400-500 g is considered as 'stillbirth.'

Signs of Live Birth

The law presumes that every newborn child found dead was born dead, until the contrary is proved. In India, live birth means the fetus was alive after complete birth or when at least one part of its body comes out of mother's womb. In UK, it means the baby should be alive after complete birth.

In civil cases

Any sign of life after complete birth of child is accepted as proof of live birth. Following are considered as **signs of live birth:**

- Baby's cry—Strong evidence in favor of live birth and respiration having taken place. Fetus may inhale air and cry when the head is inside the vagina—*vagitus vaginalis*, or inside the uterus—*vagitus uterinus*.¹⁵
- Muscle twitching/movements of limbs.
- Sneezing and yawning.

In criminal cases: Signs of live birth have to be demonstrated by postmortem examination.

Postmortem Examination

External Findings

- General findings
- Changes in the chest, umbilical cord and skin
- Caput succedaneum
- Cephalhematoma
 - i. **General findings:** Presence of clothing and absence of vernix caseosa—suggestive of live birth.
 - ii. **Changes in the chest:** Chest is more flat antero-posteriorly in still/dead born. The circumference of the chest is about 2-3 cm less than that of the abdomen at the level of the umbilicus. After respiration, the chest expands and becomes drum-shaped.
 - iii. **Changes in umbilical cord:** The presence of marks of crushing by artery forceps, clean-cut margins and ligature—suggestive of live birth (Table 20.3).
 - iv. **Changes in skin:** Vernix caseosa is present on axilla, inguinal region, folds of neck and buttocks. It is either cleaned or gets removed in 1-2 days. Skin of abdomen exfoliates during the first 3 days after birth (Table 20.4).
 - v. **Cephalhematoma and caput succedaneum.** (Diff. 20.2, Figs 20.3 and 20.4)

Table 20.3: Time since birth by umbilical cord changes

Changes observed	Time since birth
• Drying up of cut margin	2 h
• Drying up of cord	1 day
• Inflammatory line at the base of stump	2 days
• Obliteration and mummification changes	3 days
• Detach (falls off)	5-6 days
• Complete healing (scar)	10-12 days

Table 20.4: Changes in skin color

Color of skin	Time since birth
Bright red	Just born
Darker	2-3 days
Brick red→ yellow→ normal	1 week

Internal Findings

- i. **Changes in lungs:** Refer to Diff. 20.3.
- ii. **Fodere's test:** The blood flow in lung beds increases after breathing, weight becomes double after respiration, but it is not constant. Weight of the lungs may increase in the stillborn due to:
 - a. Edema of lungs
 - b. Congenital pneumonitis
 - c. Inhalation of amniotic fluid
- iii. **Ploucquet's test:** This test helps to demonstrate establishment of respiration. The ratio of the weight of the lungs and the whole body is reduced to half (1/35 of body weight) as compared to the said ratio before respiration (1/70 of body weight).²⁰
- iv. **Hydrostatic test**

Principle: It is based on the fact that specific gravity of lung before respiration is 1040-1050 and becomes 940-950 after respiration which is less than that of water and makes the respired lung to float.

Procedure: Dissect out the fetal lungs. Put both the lungs (tied at their hilar region) into a trough of water and observe.

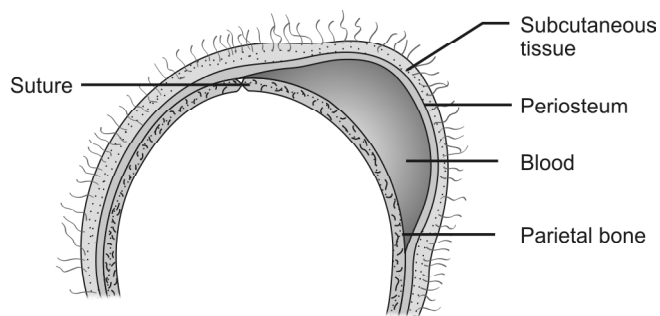

Fig. 20.3: Cephalhematoma (For color version see Plate 3)

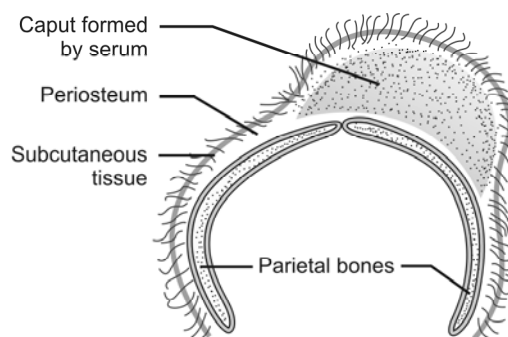

Fig. 20.4: Caput succedaneum (For color version see Plate 3)

Inference

- If they sink—unrespired lung.
- If they float—remove them from water, cut into small pieces and then squeeze or compress firmly between sponges and again put into water.

Differentiation 20.2: Cephalhematoma and caput succedaneum¹⁶⁻¹⁹

S.No. Feature	Cephalhematoma	Caput succedaneum
1. Definition	Collection of blood in between the periosteum and the skull due to rupture of a small emissary vein from the skull and may be caused by forceps delivery	Swelling due to stagnation of fluid between the layers of scalp beneath the girdle of contact (dilated cervix or vulval ring)
2. Situation	Usually unilateral and present over parietal bone	May be bilateral
3. Impulse on crying	No impulse	No impulse
4. Limitation by suture line	Yes	Not limited
5. Underlying pathology	May be associated with fracture of skull bone	Not pathological
6. Occurrence	It is never present at birth	It is present at birth
7. Development and disappearance	Develops after 12-24 h after birth and decreases in 6-8 weeks	Disappears spontaneously within 24 h
8. Medico-legal importance	Regression process help to conclude about the separate existence and how many days the infant survived after birth	Definite evidence of live born fetus. But in prolonged labor, the fetus may die before birth

Differentiation 20.3: Unrespired and respired lung (stillborn and live born)

S.No. Feature	Unrespired lung	Respired lung
A. Gross		
1. Color	Bluish red	Mottled
2. Volume	Small	Large, cover heart
3. Thoracic cavity	Not full	Occupies fully
4. Pleura	Loose, wrinkled	Taut, stretched
5. Margins	Sharp	Rounded
6. Surface	Smooth	Uneven
7. Consistency	Dense, firm, noncrepitant (liver-like)	Soft, spongy, elastic, crepitant
8. Weight		
• Ploucquet's test	1/70 of body weight	1/35 of body weight
• Fodere's (static) test	30-40 g	60-70 g
9. Diaphragm	4th-5th rib level	6th-7th rib level
B. Cut section		
10. Blood oozing	Little frothless blood	Abundant frothy blood
11. Floatation (Hydrostatic) test	Whole and parts sink in water	Floats in water
12. Alveoli	Not expanded	Expanded, rise above the surface
13. Microscopically	Alveolar sacs closed, lined with cuboidal/columnar cells	Sacs dilated, lined with flat squamous cells with prominent vascularity
14. Medico-legal importance	Indicates still/dead born infant	Indicates live birth

- If they sink—unrespired lung.
- If they float—respired lung.

Explanation: Floatation observed for second time is because of *residual air* that remains in the lungs which cannot be squeezed out by pressing, if the fetus has breathed after birth.

Fallacies

- False positive is seen in accumulation of putrefying gases or artificial inflation.
- False negative is seen in atelectasis (non-expansion of lungs), obstruction by alveolar duct membrane, edema, pneumonia and congenital syphilis.²¹

Hydrostatic test is not necessary if:

- Fetus is born before 180 days of gestation.
- Fetus shows congenital anomaly, like anencephaly.
- Fetus is macerated or mummified.
- Umbilical cord has separated and a scar has formed.
- Stomach contains milk.
- Bruises on lungs indicating efforts to artificially respire the child.

v. Histology

- Unrespired lung looks like the parotid gland with closed alveolar sacs lined with cuboidal/columnar cells, and less vascularity.

- Respired lung cells get flattened with dilatation—pavement (squamous) epithelium with increased vascularization.

- Changes in middle ear (Wredin's test):** Absence of gelatinous embryonic connective tissue which was present during fetal life and presence of air in middle ear is seen after live birth.²²
- Changes in stomach and intestines:** Live born infant swallows air into the stomach during respiration, and if present in small intestine it further confirms live birth. But air may be present in the stomach after decomposition or in the stillborn attempting to free the air passages of fluid obstruction.

Demonstration: The stomach and intestines are removed after tying double ligatures at each end. They are kept under water and incision is given between the ligatures. Air bubbles will come out, if respiration has taken place—**Breslau's second life test or stomach bowel test.**²³

If milk is present in the stomach, it is a positive evidence of live birth.

- Meconium:** In case of live birth, the large intestine is completely free of meconium within 24 h after birth, but in stillbirths it will be present in the

intestine. In case of breech presentation and hypoxia, meconium may be completely expelled before birth and thus may be absent even in such stillborn fetuses.

- ix. **Changes in the blood vessels:** Umbilical arteries are obliterated within 12 h to 3 days. Obliteration of umbilical vein and ductus venosus is complete by 4th day. The ductus arteriosus obliterates in about 10 days.
- x. **Changes in heart:** Closure of foramen ovale occurs by 2-3 months after birth. In few cases, the foramen may not completely close.
- xi. **Changes in the blood:** Nucleated RBCs are absent in peripheral circulation within 24 h after live birth. Fetal hemoglobin may be present in the blood upto 6 months or more.
- xii. **Incremental line in enamel of teeth:** Neonatal incremental line in the enamel of the teeth is formed at birth which is one of the surest sign of live birth.
- xiii. **Ossification centres:** Their presence at the lower end of radius, heads of humerus and femur and capitulum of humerus may also be taken as signs of separate existence for a few months.
- xiv. **Closure of fontanelle:** Closure of different fontanelle occurs at different periods after birth. Closure of posterior fontanelle may occur at birth.

Flow chart 20.1: Causes of infant death

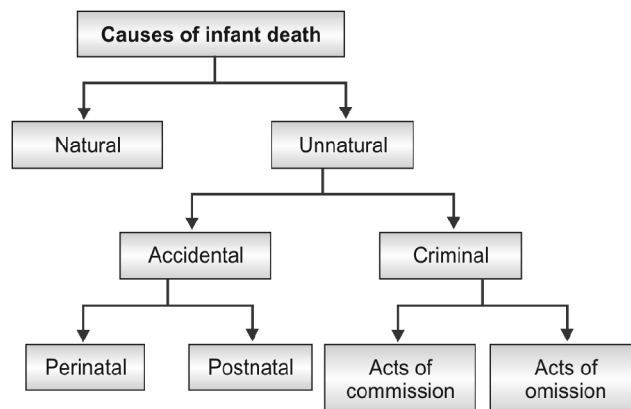

(concussion of brain/fracture/rupture of blood vessels) and lead to death of the baby.

- ii. **Prolonged labor:** It causes death of the fetus due to injury to the brain because of compression of the head or due to asphyxia.
- iii. **Prolapsed cord or pressure on cord:** It may cause stoppage of fetal circulation during birth, and death of the newborn may occur during or just after birth.
- iv. **Twisting of cord around the neck or knots of the cord:** It causes death of the fetus during birth or immediately after birth from asphyxia due to strangulation.
- v. **Death of the mother.**

Postnatal

- i. **Suffocation:** Due to non-availability of nursing care, the neonate may die due to smothering or choking due to inhalation of amniotic fluid or blood immediately after birth.
- ii. **Precipitate labor** (in this condition, all the 3 stages of labor occur in very quick succession so that delivery occurs suddenly, commonly seen in multipara): It may cause death of the newborn due to head injury (Diff. 20.4), suffocation or drowning or occasionally due to bleeding from torn end of attached umbilical cord.

Medico-legal aspects

- Death of the newborn due to precipitate labor may be taken as a case of deliberate infanticide.

Infant Death (Flow chart 20.1)

a. Natural Causes

- Prematurity
- Birth trauma
- Neonatal infection
- Post-maturity
- Pre-eclamptic toxemia
- Congenital malformation
- Intrapartum asphyxia
- ABO and Rh-incompatibility
- Early separation of placenta
- Sudden infant death syndrome (SIDS)

b. Unnatural Causes

I. Accidental causes

Perinatal

- i. **Injuries to the mother:** It may cause premature separation of the placenta or injury to the fetus

Differentiation 20.4: Head injury due to precipitate labor and blunt force

S.No.	Feature	Precipitate labor	Blunt force
1.	Contusion	Present on presenting part of scalp	Present anywhere on the scalp
2.	Laceration	Absent	May be present
3.	Fracture	Fissured fracture involving the parietal bones	Comminuted/depressed fracture, may involve all the bones
4.	Brain	Usually not injured	Contusions, lacerations and hemorrhage may be seen

- The mother may claim infanticide (negligence on part of the doctor), but death of the newborn is due to precipitate labor.

II. Criminal causes

- a. **Acts of commission:** These are acts done positively to cause death of infant.
 - i. **Strangulation** by a ligature material or the umbilical cord (to simulate natural twisting of cord round the neck) or by throttling.
 - ii. **Poisoning:** Earlier, opium was used for the purpose (*ideal infanticidal poison*). Nowadays acids and insecticides are used.
 - iii. **Smothering** the baby to death with the help of hand or clothes.
 - iv. **Head injury:** The head of the fetus may be struck against a wall or on the floor by holding its legs, this may leave an impression on the legs also.
 - v. **Concealed punctured wound** may be caused by a nail or a needle through the fontanelle, nape of the neck or inner canthus of eye.
 - vi. **Twisting the neck:** Death occurs due fracture dislocation of the cervical vertebrae and injury to the medulla.
 - vii. **Burning** the newborn alive or disposing the living newborn inside an oven.
 - viii. **Drowning** which also serves the purpose of disposal of the unwanted child.
 - ix. **Cut throat injury.**
- b. **Act of omission or neglect:** Intentional failure on the part of the mother to extend care to the newborn leading to its death; this may amount to infanticide. It may be failure to:
 - Provide proper assistance during labor.
 - Clear air passages which may be obstructed by amniotic fluid/mucus.
 - Tie the cord after it is cut.
 - Protect the child from exposure to heat/cold.
 - Supply the child with proper food.

Abandoning of Children

Sec. 317 IPC deals with abandoning by the father or mother of the child under the age of 12 years with imprisonment upto 7 years and with/without fine.

Battered Baby Syndrome (Caffey/Maltreatment Syndrome)

Definition: A battered child is one who has received repetitive physical injuries as a result of non-accidental violence produced by a parent or a guardian.

Features

Related to the child

- i. **Age:** The majority is below 3 years of age.
- ii. **Sex:** More common with male children (M:F ratio 2:1).
- iii. **Status of the child:** Usually illegitimate and unwanted children—pregnancy before marriage, failure of contraception.
- iv. **Position in family:** Commonly the eldest or the youngest. The child may be a mentally abnormal one.

Related to the parent/guardian

- i. **Marital status:** Unmarried couple, commonly seen in some Western societies.
- ii. **Age of parents:** Usually the parents are young.
- iii. **Educational status:** Lower level of education.
- iv. **Addiction:** Reckless life style, often indulging in drugs.
- v. **Childhood history:** Often the parents themselves were the victims of battering during their childhood.
- vi. **Psychological factors:** Low tolerance threshold, impulsive nature, aggressive personality and imbalanced temperament.

Socio-familial factors

- i. Low social background.
- ii. Lack of equality between members of the family with lack of family harmony.
- iii. Long-standing emotional problem.
- iv. Financial hardship.
- v. Trouble at the place of work.

Precipitating factors

- i. Act of disobedience by the child.
- ii. Frequent crying may create annoyance.
- iii. Refusal to take food.
- iv. Soiling of napkin or bedclothes.
- v. At times, any trifle act of the child may annoy the mentally challenged father or mother.

Features Arising Suspicion of Abuse

- Parents give vague history of accident to be the cause of the injuries, like fall from stairs or cot which does not appear consistent with the type of injuries or time narrated by the parents (Fig. 20.5). Often the parents' gives a history of tendency of the child to bruise easily.

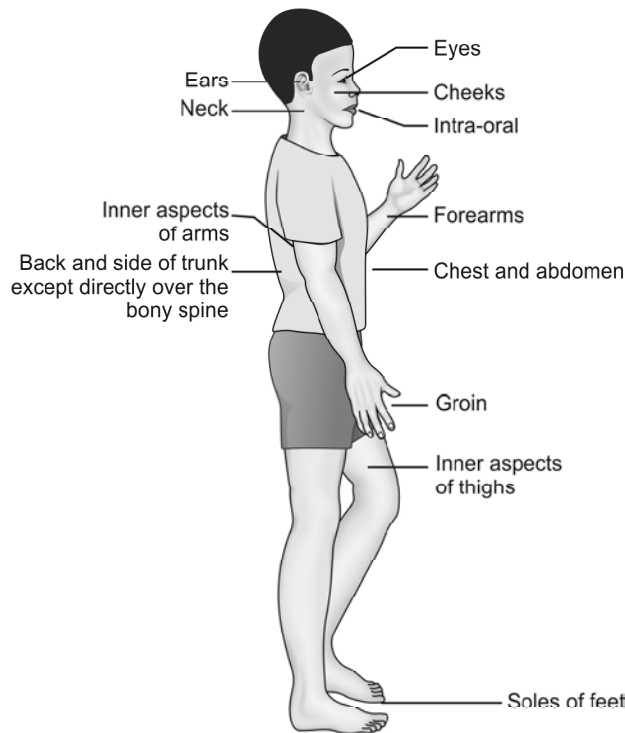

Fig. 20.5: Sites of non-accidental injury

- The parents of the child seek medical aid rather late or when the condition of the children becomes serious.
- Often injuries in different stages of healing are found in the child.
- In many cases, the parents later admit to have assaulted their children, but 'only mildly' for punishment.

Accidental injuries typically involve bony prominences [head (forehead, occipital or parietal region), nose, chin, palm, elbows, knees and shin], match the history given by the parents and are keeping with the development of the child.

Injuries

The injuries may be caused by hand, foot, teeth, stick, belt, shoe, hot water, lighted cigarette, hot frying pan or any household article.

- i. **Surface injuries:** Bruises, abrasions and lacerations may be seen. Laceration of the oral mucosa along with labial frenulum of the lower lip is a characteristic lesion. Slap marks, lash mark, knuckle punches, pinch mark [butterfly-shaped bruise with one wing (caused by thumb) larger than other], bald patches on scalp due to pulling out the hair (traumatic alopecia) may be seen (Fig. 20.6).

- ii. **CNS:** Injuries are inflicted by throwing the child, striking the child with fist or object or against a wall, dropping the child or vigorous shaking of the infant (*shaken baby syndrome* or *infantile whiplash syndrome*) leading to intracranial hemorrhage. A strong suspicion of child abuse should be made in a child presenting with altered mental status, unresponsiveness, coma, convulsions or with focal neurologic deficit.^{24,25}
- iii. **Eyes:** Retinal hemorrhages and lens displacement may be seen.
- iv. **Visceral injuries:** Injury to spleen, liver or hollow viscera can occur resulting in massive hemorrhage, shock and death of the child.
- v. **Burns:** Small circular pitted burns may indicate deliberate stubbing of cigarette ends on skin. Scalds are also common (Fig. 20.6).
- vi. **Skeletal injuries:** Bony injuries include transverse fractures, impacted fractures, spiral fractures, metaphyseal chip fractures, subperiosteal hematoma, and multiple deformities of the long bones and rib cage of the body due to multiple healed fractures and callus formation.
 - Fractures of long bones, ribs, skull and vertebral bodies are highly suggestive of abuse.
 - Antero-posterior compression of chest causes fractures in midaxillary line.
 - Multiple rib fractures also occur along posterior angle of ribs on side-to-side squeezing. After 1-2 weeks, callus is formed and on X-ray '*string of beads*' appearance is seen in paravertebral gutter.
- vii. **CVS:** Blunt trauma to chest may cause multiple rib fractures leading to lung and heart contusions, pneumothorax, hemothorax, rupture of diaphragm and cardiac tamponade.
- viii. **Genitourinary system:** Physical and sexual abuse should be considered in a child presenting with hematuria, dysuria, frequency of urination and enuresis.

Diagnosis

- i. Nature of injuries.
- ii. Delay in seeking medical treatment.
- iii. Recurrent injuries.
- iv. Radiological manifestations, especially those involving the ribs, metaphyseal-epiphyseal injuries, and avulsive fractures of the clavicle and acromium process.

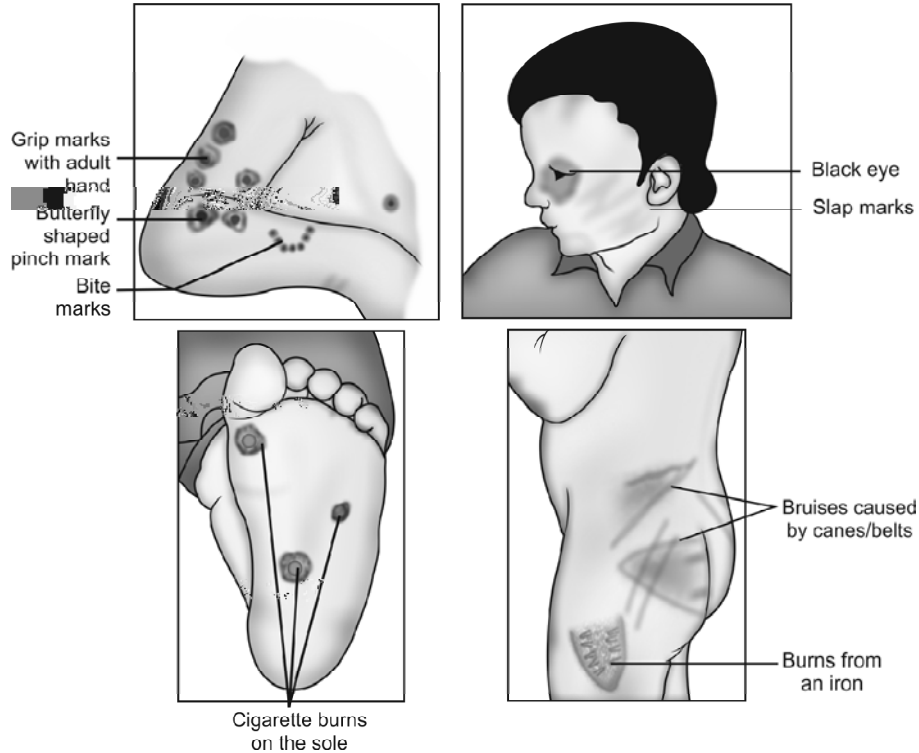

Fig. 20.6: Surface injuries

Head injury with or without skull fracture is the leading cause of death in child abuse followed by rupture of an abdominal viscus.

Child abuse can be defined as causing or permitting of any harmful or offensive contact to a child's body and/or any communication or transaction which humiliates, shames, or frightens a child.

Major types of abuse

- i. Physical abuse
 - ii. Sexual abuse
 - iii. Emotional abuse
 - iv. Neglect
- i. *Physical abuse* of children includes any non-accidental physical injury caused by the child's caretaker. It can be beating or battering of a child and has been described above.
 - ii. *Sexual abuse* refers to inappropriate sexual behavior with a child. It includes fondling a child's genitals, making the child fondle the adult's genitals, intercourse, incest, rape, sodomy, exhibitionism, indecent exposure and commercial exploitation through prostitution or the production of pornographic materials.
 - iii. *Emotional abuse (verbal/mental abuse or psychological maltreatment)*: Acts of commission and omission which can be potentially damaging psychologically. This can include parents/caretakers using extreme and/or bizarre forms of punishment, such as confinement in a closet or dark room or being tied to a chair for long periods.

- iv. *Neglect* is the failure to provide for the child's basic needs. Neglect can be physical, educational or emotional. In general, neglect is an act of omission.

Differential diagnosis of childhood fractures should be made from the several 'brittle bone diseases' that can cause abnormal skeletal fragility—congenital syphilis, rickets, scurvy, leukemia, osteogenesis imperfecta, copper deficiency, Menke's syndrome, infantile cortical hyperostosis (Caffey's disease) and juvenile osteoporosis.

It can be defense in a criminal trial of alleged child abuse on the grounds that such fractures can be observed within normal parental handling or spontaneous movements of the child.

Shaken baby syndrome: Infants (< 1 year of age) are susceptible to subdural/subarachnoid hematoma and retinal hemorrhages due to vigorous shaking of the baby as a method of punishment.

- *Predisposing factors:* Infant's relatively large head, weak neck muscles and delicate subarachnoid bridging vessels.
- *Signs and symptoms:* Seizures, irritability, meningismus and focal or general neurologic deficit.
- *Diagnosis:* Confirmation by CT/MRI scan, bloody spinal or subdural fluid and normal skull X-rays.

Reporting of suspected child abuse: It is mandatory to report any suspected child abuse case in US, Argentina, Finland, Israel, Korea and Spain. In other countries such as Croatia, Japan, Netherlands and Romania reporting is voluntary.

Sudden Infant Death Syndrome [SIDS, Cot Death (in UK) or Crib Death (in US)]

Definition: Sudden and unexpected death of seemingly healthy infant whose death remains unexplained even after complete autopsy. It is an autopsy diagnosis, not a clinical.

Features

- i. **Incidence:** 0.2-0.4% of all live births.
- ii. **Geographical distribution:** Worldwide.
- iii. **Age:** Between 2 weeks to 2 years. Mid infancy is the most vulnerable age (peak 2-4 months).
- iv. **Sex:** Male infants have a proportionately higher death rate (M:F ratio 3:2).
- v. **Socio-economic status:** Low and middle class family with poor housing condition, large family and lack of health consciousness.
- vi. **Time of death:** In most cases, the infant is discovered dead, either in the early morning (death possibly occurring at late night) or sometime after first feed in the morning.
- vii. **Season:** In most occasions, deaths are seen to occur commonly in rainy and winter seasons in temperate zones, but no clear pattern in tropical zones.
- viii. **Twinning:** More among twins (two-fold) as opposed to singletons. Prematurity and low birth weights which are often present in twins increases the risk of SIDS.
- ix. **Addiction:** Smoking (pre- or postnatal) and drug abuse by pregnant women increases risk.

Cause

No definite cause is known.

- i. **Prolonged sleep apnea** is presently accepted as the most acceptable of the suggested causes. A periodic failure to breath during sleep makes them susceptible to hypoxia. Hypoxic state may be promoted by many allied factors, e.g. some infective condition of the respiratory tract.
- ii. **Respiratory infection** may cause viremia which leads to sleep depression of respiratory centre and death.
- iii. **Nasal edema and mucus secretion** may narrow upper respiratory passages, a flaccid pharynx and neck posture may reduce airway.
- iv. Local **hypersensitivity of the respiratory tract** lumen to cow's milk was thought to cause laryngeal spasm.

- v. **Bedclothes and pillow falling accidentally** over the mouth by the movement of the child.
- vi. **Overlying** of the baby by a sleeping or intoxicated mother. Infants placed to sleep prone or on their side increases the risk of SIDS.
- vii. **Other causes:** Conduction system anomalies; hypoparathyroidism; deficiency of selenium, antibodies, calcium, magnesium and vitamins B, C, D and E; house-mite allergy; sodium overload in feeds and hypothermia.

There is an increased risk of SIDS as well as other causes of death in families that have one SIDS death.

Postmortem Findings

- Postmortem findings are negative.
- Trachea contains milky vomit, sometimes blood-stained with shed epithelial cells.
- Multiple petechial hemorrhages on heart (posterior epicardial surface), lungs and thymus—agonal in nature.
- Pulmonary edema is common.
- Milk or bloodstained froth on child's mouth or bedding. Hands are often clenched around fibres from bedclothes.

Medico-legal Aspects

- SIDS is a natural death in which the parents may be wrongfully linked for having criminal involvement or negligence.
- Some infanticide cases may be presented as cot death cases.

Munchausen syndrome by proxy [MSBP or Factitious disorder (Latin *factitious*: made by art)]:²⁶ MSBP is a form of abuse in which parent or guardian fabricates or produces symptoms of an illness in a child in order to gain sympathy or attention for themselves.

- The parents frequently have abnormal or borderline personality disorder.
- Diagnosis may require a high level of suspicion and may be met with considerable resistance from family.

Features²⁷

- i. The child may be brought with vague complaints such as vomiting, diarrhea, fever or seizures inflicted by the parent intentionally and repeatedly, for e.g. bleeding may be caused by anticoagulants and simulated by exogenous blood, seizures can be caused by suffocations, shaking or intoxications, vomiting can be caused by giving ipecac syrup and fever triggered by injecting contaminants into IV lines while the child is in the hospital.
- ii. The parent or guardian derives some non-economic benefit at the expense of the victim.

- iii. Some perpetrators 'doctor shop' while some maintain a constant relationship with one or more health care providers.
- iv. When confronted, the parent or guardian usually denies any allegations of causing the victim's condition.

Diagnosis

- i. The illness does not conform to the expected presentation or follow the usual course.

- ii. Signs and symptoms are not substantiated by laboratory or imaging findings.
- iii. Failure of wounds to heal.
- iv. The child becomes ill or worsens when the parent or guardian is present, with recovery when separated.
- v. Positive drug or toxicological analysis for something not prescribed for the patient.
- vi. Finding that the patient has been admitted to multiple hospitals and has been seen by multiple physicians.

MULTIPLE CHOICE QUESTIONS

1. Lanugo hair first appears in a fetus at: *UP 07*
 A. 2nd month B. 3rd month
 C. 4th month D. 5th month
2. Consider the following four events of development of fetus: *UPSC 08*
 1. Development of external genitalia
 2. Appearance of scalp hair
 3. Centres of ossification in bones
 4. Formation of eyelashes and eye brows
What is the order in which they appear from lower to higher gestation?
 A. 1, 3, 2, 4 B. 1, 3, 4, 2
 C. 3, 1, 4, 2 D. 3, 1, 2, 4
3. The centre of ossification used as medico-legal evidence for fetal viability: *COMEDK 07; Punjab 08*
 A. Head of femur B. Distal end of femur
 C. Talus D. Calcaneum
4. Testes completely descend in the scrotum by the: *DNB 09*
 A. End of 7th month B. End of 8th month
 C. End of 9th month D. After birth
5. Centre of ossification of femur appears at: *PGI 07*
 A. 36 weeks B. 38 weeks
 C. 40 weeks D. 28 weeks
6. Rule of Hasse is used to determine: *AIIMS 03; DNB 09; Punjab 10*
 A. Age of fetus B. Height of an adult
 C. Race of a person D. Identification
7. At what age, does the birth length doubles: *UPSC 07; FMGE 10, 11*
 A. 1 year B. 2 years
 C. 3 years D. 4 years
8. Birth weight triples at: *Orissa 11*
 A. 9 months of age B. 1 year of age
 C. 2 years of age D. 2.5 years of age
9. Aseptic autolysis is seen in: *Kerala 04; AP 08*
 A. Adipocere B. Maceration
 C. Putrefaction D. Mummification
10. Dead-born fetus does not show: *AIIMS 03; Kerala 11*
 A. Rigor mortis at birth
 B. Adipocere formation
 C. Maceration
 D. Mummification
11. Spalding sign is seen in: *AI 07; BHU 09*
 A. Maceration B. Mummification
 C. Putrefaction D. Saponification
12. Spalding sign is seen in: *AI 06; CMC (Ludhiana) 10*
 A. Abortion B. Stillbirth
 C. Intrauterine death D. Infanticide
13. Spalding's sign is evident in: *TN 05*
 A. 2 days B. 5 days
 C. 7 days D. 14 days
14. All are true about stillbirth, except: *Maharashtra 08, 09, 11*
 A. Fetus was alive in utero
 B. Birth weight < 1000 g
 C. Diaphragm at 4-5th rib level
 D. Hydrostatic test is negative
15. 'Vagitus uterinus' is: *AIIMS 05*
 A. An infection of vagina
 B. An infection of uterus
 C. Cry of unborn baby from uterus
 D. Infection of both vagina and uterus
16. Not true about cephalhematoma: *AP 08; Kerala 08*
 A. Not limited by sutures
 B. Swelling develops in 12-24 h after birth
 C. Swelling subsides in 2-3 months
 D. Caused by periosteal injury of skull
17. Consider the following statements regarding a cephalhematoma: *UPSC 04, 08*
 1. Present at birth.
 2. It can occur after a normal delivery.
 3. The commonest site is over the parietal bone.
 4. The bleeding is sub-periosteal.
Which of the statements given above are correct?
 A. 1 and 4 B. 1 and 2 only
 C. 1, 2 and 3 D. 2, 3 and 4

1. C 2. D 3. C 4. C 5. A 6. A 7. D 8. B 9. B 10. B 11. A
 12. C 13. C 14. B 15. C 16. A 17. D

18. **Caput succedaneum in a newborn is:** *Karnataka 07*
 A. Collection of blood under the pericranium
 B. Collection of sero-sanguineous fluid in the scalp
 C. Edema of the scalp due to grip of the forceps
 D. Varicose veins in the scalp
19. **The following are the characteristics of caput succedaneum, except:** *UPSC 04; AFMC 12*
 A. It is present at birth
 B. It does not cause jaundice in newborn
 C. It is limited to individual bone
 D. It disappears within a few hours of birth
20. **Test in which weight of lung is compared to body weight:** *PGI 08, 09*
 A. Fodere's test B. Cavett test
 C. Ploucquet's test D. Precipitin test
21. **False negative hydrostatic test in live born:** *AI 08*
 A. Atelectasis B. Meconium aspiration
 C. Emphysema D. Congenital heart disease
22. **Wredin's test is to demonstrate:** *MP 09*
 A. Live birth B. Insanity
 C. Putrefaction D. Assault
23. **Breslau's second life test utilizes:** *Manipal 09*
 A. Liver B. Stomach
 C. Ear D. Lungs
24. **Not the signs of accidental injury in a child:** *CMC (Vellore) 10*
 A. Subdural hematoma
 B. Abrasion on the knees
 C. Swelling in the occiput
 D. Bleeding from the nose
25. **An infant is brought to casualty with reports of violent shaking by parents. Most characteristic injury is:** *AI 11*
 A. Long bone fracture answer
 B. Ruptured spleen
 C. Subdural hematoma
 D. Skull bone fracture
26. **Munchausen syndrome by proxy is:** *JIPMER 03; NIMHANS 10*
 A. Factitious disorder
 B. Malingering
 C. Hysteria
 D. Conversion disorder
27. **Munchausen by proxy includes all, except:** *Maharashtra 11*
 A. Admission of abuse by parents
 B. Illness does not suggest particular disease
 C. Child becomes ill in presence of the caregiver
 D. Laboratory and X-ray findings are negative

Morbidity and mortality during anesthesia has been markedly reduced due to better understanding of human physiology and pathology of disease processes. Introduction of improvised drugs, devices, techniques and previous experience have also contributed to safety during anesthesia.

Deaths during anesthesia may be broadly classified into two groups:

1. Death during administration of anesthesia, but not due to anesthesia
2. Deaths which are the direct result of administration of an anesthetic

Death during Administration of Anesthesia (not due to anesthesia)

- i. The injury or disease process which necessitated surgical intervention is serious enough, the anesthetic may have only precipitated the death.
- ii. Patient may be suffering from a severe systemic illness, e.g. valvular heart disease or severe coronary disease and undergoes surgery for another disease or problem in which operation or anesthetic may have precipitated death.
- iii. Patient may be having some undiagnosed serious lesion, e.g. major vascular aneurysm or severe coronary artery disease which could have been an important contributory factor in causing death.
- iv. *Surgical shock and exhaustion*: When surgery has been unduly delayed and preoperative condition of patient is poor, shock and exhaustion may be major factors responsible for causing the death of the patient or the patient has been unable to bear the stress of anesthesia and surgery.

Deaths Directly Related to Administration of an Anesthetic

- i. **Inexperience**: Lack of adequate experience is the most common cause of death. Inability to take precautions and corrective measures when required is commonly observed, e.g. death during endotracheal intubation is due to:

- Inability to place the tube in the trachea.
- Esophageal intubation.
- Inability to protect the airway against aspiration of foreign bodies, including regurgitant gastric content, tooth and blood.
- Disconnection of circuit.

- ii. **Equipment/device failure** due to:

- Faulty connections or mislabeling of anesthetic gases and drugs.
- Explosion and fire in operation theatre. This problem is now rare due to advent of newer anesthetic agents which do not form explosive mixtures.

- iii. **Respiratory failure**: Death occurs due to an inadequate supply of oxygen to tissues. It may be due to:

- Depression of respiratory centre by overdose of drugs used for pre-medication and pain relief or overdose of anesthetic agent used.
- Inadequate reversal of muscle relaxant leading to inefficient ventilation of lungs.
- Obstruction of the respiratory tract from laryngeal spasm, impaction of loose material, like swabs and dentures in larynx, trachea and bronchi, and tongue falling back leading to airway obstruction. Regurgitant matter aspirated into lungs may affect gaseous exchange in the lungs.
- Large tidal volumes used during intermittent positive pressure ventilation may result in lung trauma leading to pneumothorax or tension pneumothorax. Nitrous oxide used during general anesthesia leads to a rapid expansion of the pneumothorax. If pneumothorax is significant, gaseous exchange is affected leading to hypoxic injury and death.

- iv. **Neurogenic cardiovascular failure**: It is the *most common cause of sudden death* under general anesthesia. It usually occurs when some intervention is done at a time when the depth of anesthesia is still inadequate, e.g. traction on viscera or peritoneum, laryngoscopy and endotracheal intubation and dilatation.

- v. **Malignant hyperthermia:** When it occurs, it is usually seen with halogenated anesthetics and succinylcholine.
- Individual involved usually has a genetic predisposition to the syndrome.
 - *Signs and symptoms:* Rapid rise in body temperature and a two- to three-fold increase in total body oxygen consumption, arrhythmias, tachycardia and skeletal muscle rigidity.
 - May be fulminant or insidious; may or may not occur every time anesthesia is administered.
 - *Complications:* Rhabdomyolysis, electrolyte abnormalities (especially hyperkalemia) and disseminated intravascular coagulopathy (DIC).
- vi. **Local anesthetics:** Toxicity results from overdose or allergic reactions, hypersensitivity and idiosyncrasy. Important factors influencing toxicity are:
- General condition and susceptibility of the patient
 - Total dose administered
 - Rate of administration of anesthetic agent
 - Vascularity of the area injected
 - Accidental intravascular injection
 - Concomitant use of adrenaline: Adrenaline used along with local anesthetic agent can cause tachycardia, palpitation, sweating, high blood pressure and ventricular fibrillation.
- There may be general effect on CNS which can be:
- a. **Excitatory:** Causing convulsions, or
 - b. **Depressive:** Causing respiratory paralysis
- Very rarely, the heart may be affected directly, or when an abnormally high concentration is injected into a nerve, permanent loss of function may occur.
- vii. **Spinal anesthesia:** During spinal anesthesia (block), sympathetic blockade occurs along with sensory and motor blockade. This sympathetic blockade leads to varying degrees of hypotension which may be fatal, if not detected and corrected early.
- Marked hypotension is observed in elderly, in fluid deficit states, like hemorrhage and dehydration and whenever there is a pre-existing decompensating heart disease.
 - Cardiac activity may be inhibited leading to death due to vagus stimulation.
 - The vital centres in the brainstem may be affected by diffusion of drug upward. Cardiac or respiratory arrest may occur.
 - Post-lumbar puncture headache occurs when a large bore needle is used for lumbar puncture.
 - Contamination of the needle, syringe and ampoules with sterilizing and cleansing agent may lead to

arachnoiditis and may cause bladder-bowel dysfunction and paraplegia. Sepsis can also occur.

Complications of Anesthesia

Minor complications are not uncommon in anesthesia. These include—hypoxemia, atelectasis of lungs, pneumonia, pulmonary edema, pneumothorax, bronchospasm, oxygen toxicity and aspiration of gastric contents, blood or foreign bodies.

Neurological sequelae of these complications can be blindness, paraplegia, paraesthesia, vegetative state and death.

Postmortem Examination

Most deaths concerning anesthesia are unlikely to be evident at autopsy. Surgical mistakes being anatomical, may be observable at the postmortem and anesthetic mistakes being physiological, are usually not appreciable after death, except where overdose with specific drug is involved. Findings of the autopsy surgeon alone will not be sufficient to explain death and therefore, it is advisable to hold a discussion across the autopsy table involving forensic expert, anesthetist and the surgeon/clinician concerned.

In case of death following anesthesia/surgery, the forensic pathologist must answer the following questions:

- i. Was the death due to the effects of the operation or anesthesia or is it due to the disease for which operation was being carried out?
- ii. Would the patient have died, if he has not undergone through the anesthesia or operation?
- iii. Was there any defect in anesthetic or surgical technique?
- iv. Was the patient suffering from any predisposing condition that made him more susceptible to death from anesthetic or operative procedure?
- v. Was the death due to some unsuspected natural disease, directly unrelated to the disease for which surgery was being performed?

During postmortem examination, the following are to be taken into consideration:

- i. Detailed hospital record of the patient, including full clinical and pre-anesthetic checkup.
- ii. Surgical intervention and its sequelae, like sepsis, hemorrhage or edema.
- iii. Postmortem changes need to be differentiated from abnormalities existing during life (e.g. resuscitative artifacts and agonal regurgitation).
- iv. Instances of surgical mishap which may not be negligence, if the operating conditions were difficult,

like ligation of arteries and veins, ureters, bile ducts and perforation of large blood vessels, should be looked for.

- v. Presence of pre-existing natural disease, such as heart disease or respiratory insufficiency and their contribution to the cause of death must be evaluated.
- vi. Pneumothorax, air embolism or surgical emphysema should be clearly evaluated.
- vii. Surgical and anesthetic devices, such as airways, endotracheal tubes, needles or catheters should not be removed prior to autopsy. In esophageal intubation, a radiograph will show a ring of edema of esophageal mucosa at the level of the tube along with distention of stomach and intestines.
- viii. All the organs should be dissected and surgical sutures should be inspected.
- ix. Chloroform and halothane are hepatotoxic and chloroform may cause ventricular fibrillation sometimes. Halogenated hydrocarbons cause cardiac irritability.
- x. A full range of specimens for histological, toxicological and bacteriological examinations and those required to exclude hazards associated with blood or fluid transfusions, must be collected.

Histological examination of the brain is vital which is primarily intended to demonstrate the effects of hypoxia, particularly in the region of Sommer's area of the hippocampal gyrus and the cerebellum where changes are expected, even if the victim suffers hypoxia for a short period.

Toxicological examination: Following samples should be collected:

- | | |
|---------------------------------------|--------------------------------|
| • Blood 10 ml (under liquid paraffin) | • One lung sealed in nylon bag |
| • Liver 100 g | • Skeletal muscle 10 g |
| • Fat from mesentery 2 g | • Cerebrum 100 g |
| • Kidney 100 g or half of each kidney | • Urine |

In case of inhaled anesthetic, specimens should be kept in containers of appropriate size to avoid empty space, and are sealed and refrigerated/frozen. Alveolar air should be collected with needle and syringe by puncturing the lung underwater before the chest is opened.

Anesthetic Drugs and Suicide

- Mostly doctors and paramedics misuse anesthetic drugs. There are instances when these have been used for suicidal purpose.
- Opioids, like morphine, pethidine and pentazocine are administered along with muscle relaxants for painless death. While opioids produce analgesia, muscle relaxants cause paralysis of muscles including those of the diaphragm. Due to failure of ventilation of lungs, hypoxia results, leading to death.
- Death can be averted, if detected early, by instituting positive pressure ventilation of lungs till there is recovery from effects of muscle relaxants and opioids.

Definition: *Medically*, abortion (Latin *aboriri*: to get detached from the proper site) is expulsion or extraction from its mother of an embryo or fetus weighing 500 g or less, when it is not capable of independent survival (WHO). This 500 g of fetal development is attained at about 22 weeks of gestation. But in India, independent viability of fetus is taken as more than 28 weeks of gestation.¹

- *Legally*, abortion means expulsion of products of conception from the uterus at any period before full term.
- **Abortus:** The non-viable product of abortion.
- **Abortifacient:** Any agent that induces abortion.
- Some authors use the term *abortion* as expulsion of ovum within first 3 months of pregnancy; *miscarriage* the expulsion of fetus from 4th-7th months; and *premature delivery*, the delivery of baby after 7 months of pregnancy and before full-term.
- The term miscarriage is synonymous with spontaneous abortion.

Classification of Abortion (Flow chart 22.1)

Abortion procedures, whether performed legally by trained professionals using modern technology or illegally using 'traditional' methods are subject to

Flow chart 22.1: Classification of abortion

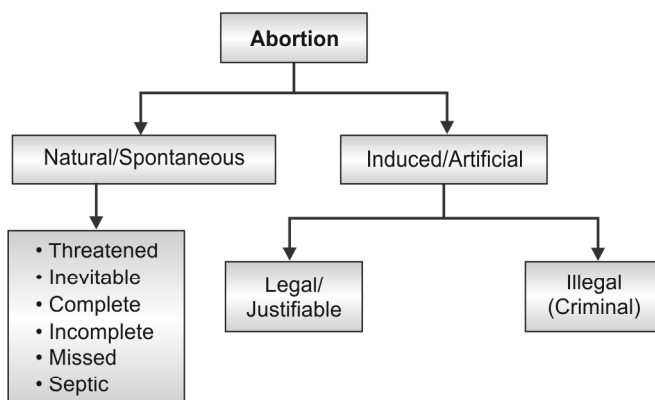

substantial underreporting. There is no valid data on the incidence of abortion in India.

Natural or Spontaneous Abortion

- **Incidence:** 10-20% of all pregnancies (approx).
- Most frequent within first 3 months, owing to weak attachment of ovum to uterine wall (75% abortions occur before 16th week and out of these, 75% before 8th week of gestation).
- Abortion occurs without any induction procedures and usually coincides with menstrual flow.

Causes

- | | |
|--------------------------|-----------------------|
| i. Genetic (50%) | ii. Anatomic (10-15%) |
| iii. Endocrine (10-15%) | iv. Infections (15%) |
| v. Immunological (5-10%) | vi. Others |

- Genetic:** Majority of early abortions are due to chromosomal abnormality.²
 - Autosomal trisomy is the commonest cause (50%) and most common is trisomy 16 (30%).
 - Monosomy and chromosomal aberration (including deletion, duplication, translocation and inversion) constitutes 20% and 2-4% of all abortions respectively.
- Anatomic:** Cervico-uterine factors usually cause second trimester abortions.
 - Cervical incompetence
 - Congenital malformation of uterus, e.g. hypoplasia, bicornuate/septate uterus or duplication of upper part of uterus
 - Uterine fibroid
- Endocrine and metabolic abnormalities**
 - Diabetes mellitus
 - Hypo- or hyperthyroidism
 - Luteal phase defect
 - Deficient progesterone secretion from corpus luteum
- Infections**
 - *Viral:* Rubella, cytomegalovirus, vaccinia, variola or HIV.

- **Bacterial:** Ureaplasma, Chlamydia or Brucella.
 - **Parasitic:** Toxoplasma or malaria.
- v. **Immunological:** Both autoimmune and allo-immune factors can cause miscarriage.
- vi. **Others**
- **Maternal illness:** Cyanotic heart disease or hemoglobinopathies.
 - Antifetal antibodies.
 - **Blood group incompatibility:** Incompatible ABO and Rh group.
 - Premature rupture of the membranes.
 - **Environmental factors:** Cigarette smoking, drugs, chemicals, noxious agents, in-situ contraceptive agents, X-ray exposure and antineoplastic drugs.

Unexplained (40%): In spite of the numerous factors mentioned, it is sometimes difficult to pinpoint exact cause of abortion.

Common causes of abortion

- **First trimester:** Genetic factors, endocrine disorders, immunological disorders, infections and unexplained.
- **Second trimester:** Anatomic abnormalities, maternal medical illness and unexplained.

Artificial or Induced Abortion

It means willful termination of pregnancy before viability. It can be:

- **Legal or justifiable:** When it is done in good faith to save the life of the woman and performed within the legal provisions of the MTP Act (Details in Chapter 2).
- **Criminal:** Induced destruction and expulsion of fetus from womb unlawfully. It is usually induced before the 3rd month, and causes infection and inflammation of the endometrium.³

Criminal Abortion

Legal aspects: Dealt under Section 312-316 IPC.

- **Sec. 312 IPC:** Whoever voluntarily causes criminal abortion with the consent of the patient is liable for imprisonment upto 3 years and/or fine, and if the woman is quick with child, imprisonment may extend upto 7 years.
- **Sec. 313 IPC:** If miscarriage is caused without the consent, imprisonment upto 10 years and fine.
- **Sec. 314 IPC:** If pregnant woman dies from this act, imprisonment upto 10 years and fine.
- **Sec. 315 IPC:** Any act done with intent to prevent the child being born alive or cause its death before birth is punished with imprisonment upto 10 years and/or fine.

- **Sec. 316 IPC:** Any act which cause death of quick unborn child amounts to culpable homicide and imprisonment upto 10 years and fine.

Methods for Inducing Criminal Abortion (Fig. 22.1)

- Abortifacient drugs
 - General violence
 - Local violence
- I. **Abortifacient drugs:** Most of them have no effect on the uterus or fetus, unless given in toxic doses and often sold to exploit distressed woman. Usually used in the 2nd month of pregnancy.
- Ecbolics:** They increase uterine contractions, e.g. ergot preparations, synthetic estrogens, pituitary extract, strychnine and quinine.
 - Emmenagogues:** These drugs initiate or increase menstrual flow, e.g. estrogen, savin, borax and sanguinarin.
 - GIT irritants:** These causes irritation of uterus, e.g. purgatives, like castor or croton oil, julap, senna and MgSO₄.
 - Genitourinary irritants:** They produce reflex uterine contraction, e.g. cantharides, and oil of turpentine or tansy or pennyroyal.
 - Drugs having systemic toxicity**
 - Inorganic irritants, e.g. lead, copper, iron and mercury.
 - Organic irritants, e.g. *Abrus precatorius*, *Calotropis*, seeds of cutard apple and carrots, and unripe fruit of papaya or pineapple.
- vi. Abortion pills made of lead or diphenyl-ethylene.

II. General violence

- Any act directly on the uterus or indirectly to produce congestion of pelvic organs or hemorrhages between uterus and membranes.

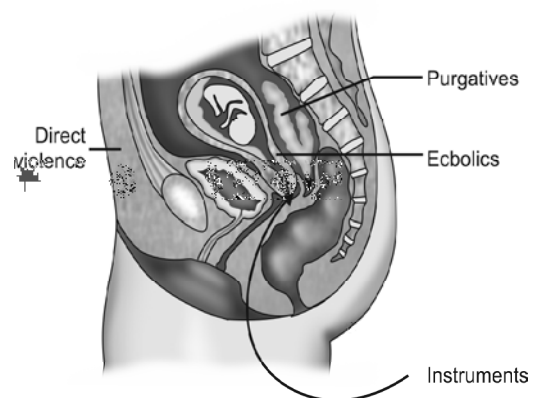

Fig. 22.1: Various sites of action of methods designed to induce an abortion

- Resorted to upto end of 1st month.
- It is more likely to cause injury than abortion.
- It can be **intentional or accidental**.

Intentional

- Severe pressure on abdomen by kneeling, blows, kick, tight bandage and massage of uterus through abdominal wall.
- Violent exercise, like horse riding, cycling, skipping or jumping from height.
- Cupping:** A mug is turned upside down over a lighted wick and placed on the hypogastria. Air escapes due to heat and the mug sets tightly on the abdomen. The mug is then pulled which may result in partial separation of placenta.
- Very hot and cold hip bath alternately.

Accidental: A general shake-up in advanced pregnancy can produce abortion, but if the fetus is healthy, abortion will not occur.

III. Local violence (Table 22.1 and Fig. 22.2)

- Usually employed in 3rd-4th month when other methods have failed.
- Interference may be skilled, semi-skilled or unskilled.

Various methods are:

- Syringing:** Ordinary enema syringe with a hand bulb is commonly used to inject fluid into uterus, the hard nozzle being inserted into cervix.

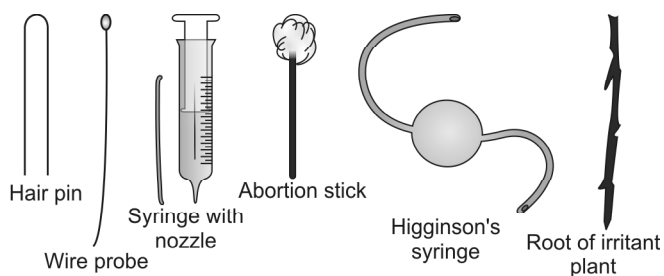

Fig. 22.2: Common methods used to procure criminal abortion

Higginson's syringe can also be used. Soap water is often used as injection material. Irritating substances are added to water, such as lysol, cresol, alum, KMnO_4 or formalin.

- Syringe aspiration:** Large syringe with a plastic cannula is inserted into cervix; develops suction which ruptures early gestational sac and leads to aspiration and expulsion of contents.
- Vacuum aspiration:** The cervix is dilated and a tube attached to a suction pump extracts the fetus.
- Rupturing of membranes:** The membranes are ruptured by introduction of an instrument, like probe, stick, uterine sound, catheter, pencil, pen holder, knitting needle and hairpin.
- Abortion stick:** It is a wooden or bamboo stick, 12-18 cm long, wrapped at one end with cotton, wool or piece of cloth and soaked with juice of marking nut, calotropis or paste made of arsenious oxide or lead.
 - It is introduced into the vagina or os by *dais* (traditional birth attendants) and retain there, till contraction starts.⁴
 - Instead of this stick, a twig of some irritant plant, like *Plumbago rosea*, *Calotropis* or *Nerium odorum* may be used.
- Dilation of cervix:** Foreign bodies are introduced and left in cervical canal, like pessaries, laminaria (a dried seaweed) or sea tangle tent which dilate the cervix, irritate uterine mucosa and produce marked congestion and uterine contractions with expulsion of fetus.
 - Cervical canal may be dilated by introducing a compressed sponge into the cervix and leaving it there. Sponge swells from moisture in the uterine segment with expulsion of fetus.
 - *Slippery elm* bark (*Ulmus fulva*) obtained from tree in Central America, is inserted into cervical canal in portions of 1-3 inches long. It absorbs moisture

Table 22.1: Different methods of interference

Unskilled interference	Semi-skilled interference	Skilled interference
<ul style="list-style-type: none"> • Self-instrumentation • Abortion stick 	<ul style="list-style-type: none"> • Instrumentation • Abortion paste—Utus paste • <i>Slippery elm</i> bark • Syringing 	<ul style="list-style-type: none"> • Dilatation and evacuation • Vacuum aspiration • Laminaria tent • Prostaglandins • Electric current • Intrauterine instillation of hyperosmotic solution

and on each side of the bark, a jelly like layer is produced that is as thick as the bark itself, due to which the cervical canal is dilated.

- vii. **Air insufflations:** Air is introduced into vagina and uterus by various means, like pumps or syringes leading to abortion.
- viii. **Electric current:** An electric current of 110 V with negative pole applied to posterior vaginal cul-de-sac and positive pole to lumbosacral region, leads to contraction of uterus and expulsion of contents.
- ix. **Pastes:** Utus paste (semi-solid soap mixed with potassium iodide, thymol and mercury) or Fetex paste is introduced in the extra-ovular space for abortion.

- Other orally ingested abortifacients include indigenous and homeopathic medicines, chloroquine tablets, prostaglandins, high dose progesterones and estrogens and liquor before distillation.
- Chloroquine is given IM as an abortifacient.

Complications of Criminal Abortion

Complications that may occur due to criminal abortion is given in Table 22.2.⁵

Septic Abortion

Microorganisms causing uterine sepsis (mixed infection is more common):

- **Anaerobic:** *Bacteroides* group (*fragilis*), anaerobic *Streptococci*, *Clostridium welchii* and tetanus bacilli.
- **Aerobic:** *E. coli*, *Klebsiella*, *Staphylococcus aureus*, *Pseudomonas* and hemolytic *Streptococcus*.

Cause of sepsis:

- Proper antiseptic and asepsis is not maintained
- Incomplete evacuation
- Inadvertent injury to the genital organs and adjacent structures particularly the gut.

Amniotic fluid embolism

Most of the cases occur during:

- 1st and 2nd trimester abortion
- Active labor
- Amniocentesis
- Abdominal trauma

In half the cases, death occurs in the first hour. It causes DIC and fibrin deposition in many organs. *Diagnosis* is established by demonstration of mucin, lanugo hair, vernix caseosa, fat globules, meconium and squamous cells in cut sections of the lung.

- **Lendrum's stain (Phloxine-Tartrazine):** This stain is useful to detect amniotic fluid embolism deaths, since keratin of amniotic squames is stained red, nuclei blue and cytoplasm yellow.
- **The 'WHO' method:** It is helpful to demonstrate keratin and mucin-like substances in amniotic fluid embolism.

Medico-legal Aspects

- Nearly all criminal abortion take place at about 2nd and 3rd month of pregnancy, when the woman in certain about her condition.
- It is resorted mostly by widows and unmarried girls.
- **Fabricated abortion:** Rarely, when a woman is assaulted, she may try to exaggerate the offence by alleging that it caused her to abort. She may acquire a human or an animal fetus to support the charge.

Medico-legal Importance of Placenta

- Gives an idea of the length of gestation.
- Transfer of poisons, bacteria and antibodies across the placenta may result in death, disease or abnormalities of fetus.
- In criminal abortion, pieces are often retained in the uterus.

Table 22.2: Cause of death and complications of criminal abortion

Immediate	Delayed	Systemic complications	Remote complications
<ul style="list-style-type: none"> • Vagal inhibition • Air embolism • Fat embolism • Hemorrhage • Amniotic fluid embolism • Poisoning (rare) 	<ul style="list-style-type: none"> • Septicemia • Generalized peritonitis • Pyemia • Toxemia • Local infection • Tetanus 	<ul style="list-style-type: none"> • Jaundice, hepatitis • Acute renal failure • Endocarditis • Pneumonitis • Pulmonary embolism • Endotoxic shock 	<ul style="list-style-type: none"> • Chronic debility • Chronic pelvic pain • Dyspareunia • Ectopic pregnancy • Secondary infertility • Depression

- Second trimester abortion (rate is among the highest in the world) increases the risk in women—they are more likely to go to an uncertified provider and the risk of complications is higher for physiological reasons.
- Most common reasons for second trimester abortions—sex selective abortions and delay of accessing abortion services for an unwanted pregnancy.
- Legal abortion is not an option for most Indian women from lower socio-economic classes, hence these women get the abortion done from less trained, but more accessible providers.

Duties of a Doctor in Suspected Criminal Abortion

- He must ask the patient to make a statement about the induction of criminal abortion. If she refuses, he should not pursue the matter, but inform the police.
- Doctor should keep all the information obtained by him as professional secret.
- He must consult a professional colleague.
- If the woman's condition is serious, he must arrange to record the dying declaration.
- If the woman dies, he should not issue a death certificate, but should inform the police for postmortem examination.

Examination of a Woman with Alleged History of Abortion

The doctor may have to examine a living subject or sometimes a dead body may be sent for postmortem examination for alleged abortion. The findings are similar to those found in the recent delivery and will depend upon the period of gestation, the mode of abortion procured and the time elapsed between abortion and examination. The major differentiating features between natural abortion and criminal interference are given in Diff. 22.1.

Examination of a Living Individual

It includes:

- Requisition from the concerned authority
- Identification of the female
- Written informed consent of the female
- A female nurse (if the doctor is male)
- Brief history—date time, place of abortion, method used to procure abortion. History of illegal termination by an unauthorized person is mostly concealed.

Clothing must be examined, especially the undergarments for bloodstains, stains from abortifacients (fluid, soapy materials)—preserved and sent to CFSL.

Clinical examination

- Since most of the abortifacients are irritants, the woman may show signs of ill health, GIT disturbances and exhaustion.
- In case of sepsis, there will be pyrexia with chills and rigor, pain abdomen and increased pulse rate (100-120/min).

Local examination

- Appearance of perineum, vulva and vagina is noted.
- Presence/absence of injuries (abrasions/contusions/lacerations) is noted.
- Condition of os is noted. It remains dilated for few days and may also show some injuries due to instrumentation.
- Presence of recent tears, the marks of forceps or other instruments in and around genitalia should be noted.
- Character and amount of discharge is noted. In case of sepsis, offensive purulent vaginal discharge or a tender uterus with patulous os may be found.

Laboratory investigations: Serum and urine gives positive result for the test for hCG upto 7-10 days.

In abortion during early months of gestation, the signs will be ill-defined, whereas signs persist for a

Differentiation 22.1: Natural and criminal abortion

S.No.	Feature	Natural abortion	Criminal abortion
1.	Cause	Predisposing diseases	Pregnancy in unmarried woman or widow
2.	Injuries on genital organs	Absent	Contusions and lacerations may be present
3.	Marks of violence on abdomen	Absent	May be present
4.	Foreign bodies in genital tract	Absent	May be present
5.	Fetal injuries	Absent	May be present
6.	Toxic effect of drugs	Absent	Inflammation of vagina, cervix, GIT or urinary tract may be present
7.	Infection	Rare	Frequent

longer time if sepsis has taken place and if abortion has been carried out in late months of gestation.

Examination of a Dead Body

The conviction of a person for criminal abortion should be based on autopsy, laboratory and circumstantial findings.

- a. Sudden death of a woman of child-bearing age should give rise to the suspicion of criminal abortion if:
 - The deceased was pregnant and deeply cyanosed
 - Instruments to procure an abortion or abortifacient drugs are found at scene of death
 - Underclothing appears to be disturbed after death
 - Fluid, soapy material or blood coming out of vagina
- b. Following point should be proved to convict the abortionist:
 - The dead woman was pregnant
 - The accused was responsible for the act which resulted in the interruption of pregnancy
 - The accused acted for the purpose of procuring an illegal abortion
 - Death occurred as a result of attempt to interrupt the pregnancy

Moreover, any criminal charge must be substantiated not only by positive evidence of interference relating to the deceased's death, but also to exclude the possibility of self-induced abortion.

Postmortem Examination

- Autopsy examination should include absolute identification of the victim and careful examination of the clothing including undergarments which must be preserved for any traces of foreign solutions.
- External features of pregnancy should be looked for. If death is due to hemorrhage, body will look pale.
- Presence of injuries (general or local) is noted. If abortifacient drug was injected, then the injection mark(s) can be detected over usual sites.
- *Local examination:* Labia majora, minora, vagina, cervix may show injuries and may be congested. It may be stained by locally used abortifacient agents.
- *To confirm or exclude air embolism,* the body must be opened after radiological examination as it may show translucency of the right ventricle and pulmonary artery (details in Chapter 6).

- The *abdominal cavity* is opened and may be full of blood, if there is perforation of uterus. Uterine and adnexal tissues are assessed for crepitation due to gas formation in the uterine wall, and venous channels and the inferior vena cava is inspected for air or soap embolism bubbles.
- The *skull vault* must then be carefully removed, avoiding puncture of the meninges and vessels over the brain surface which allows air to enter these vessels; a detailed examination of the basal sinuses, veins and arteries is made for the presence of air embolism.
- Following removal of the thoracic and abdominal organs in the usual manner, the pelvic organs are excised en-masse following separation of the symphysis pubis and a circular dissection to include vagina, vulva and rectum with adjacent skin, taking care to collect any foreign fluid or material for chemical and bacteriological examination. The vagina and uterus are opened along their anterior surface because injuries are more likely to occur on the posterior vaginal wall following criminal interference.
- *Findings in the uterus:* Cavity may show presence of products of conception in full or in parts. It may be enlarged, soft and congested. Wall may show thickening in longitudinal section.
- Samples to be collected are given in Box 22.1.

Trauma and Abortion

- Travel, in the absence of trauma, does not increase the incidence of abortion.
- Trauma may rarely cause an abortion, in the absence of serious or life-threatening injury to mother.
- Following *criteria suggests a causal relationship between trauma and abortion:*
 - a. The traumatic event was followed within 24 h by processes that ultimately lead to abortion.
 - b. Appearance of the fetus and placenta should be compatible with the period of pregnancy at which the traumatic event occurred.

Box 22.1: Samples to be collected in criminal abortion

- Vaginal contents pipetted in a clean sterile container for chemicals, drugs or soap.
- Pubic hair.
- Blood, urine and stomach contents.
- Blood from the inferior vena cava and both cardiac ventricles.
- Any fluid from the uterine cavity.
- Swabs of the uterine wall.
- Tissues for histology from all organs.

- c. The fetus and placenta should be normal.
- d. Factors known to cause abortion should be absent, such as:
 - i. History of repeated abortion without any cause or exposure to abortifacients, e.g. X-ray or lead.
 - ii. Chronic infections in mother, e.g. syphilis, toxoplasmosis or tuberculosis.
 - iii. Abnormalities of uterus including congenital defect of uterine development, leiomyomas, endometrial polyps and incompetent os.
 - iv. Physical attempt to induce abortion.

MULTIPLE CHOICE QUESTIONS

1. **Abortion is defined as expulsion of fetus:** *TN 06*
 - A. Before viability
 - B. Before 28 weeks
 - C. Any of the above
 - D. None of the above
2. **Most common cause of first trimester abortion is:** *UP 09; JIPMER 10; Kerala 11*
 - A. Chromosomal defect
 - B. Endocrine disturbances
 - C. Anatomic abnormality of uterus
 - D. Infections
3. **Mechanism of criminal abortion:** *AIIMS 06*
 - A. Infection and inflammation of endometrium
 - B. Uterine contraction
 - C. Placental separation
 - D. Stimulation of nerve
4. **Mechanism of action of abortion stick used in criminal abortion:** *AIIMS 06; AI 08*
 - A. Necrosis of endometrium causing infection
 - B. Uterine contraction
 - C. Stimulation of uterine nerves
 - D. Inducing uterine relaxation
5. **All are complications of illegal abortion, except:** *TN 05*
 - A. Cerebral hemorrhage
 - B. Acute renal failure
 - C. DIC
 - D. Bacterial shock

Definitions

- **Impotence:** It is the inability of a person to perform sexual intercourse and achieve gratification (unable to copulate).
- **Erectile dysfunction:** Inability to develop and maintain an erection for satisfactory sexual intercourse in the absence of an ejaculatory disorder such as premature ejaculation.
- **Quod** (*impotence quode hanc, 'as regards'*): A male may be impotent with one particular female, but not with another.
- **Sterility:** It is the absolute inability of either a male or a female to procreate. In male, it is inability to make a female conceive, and in females, it is inability to conceive children.
- **Fertility:** Capacity to reproduce or the state of being fertile.
- **Infertility:** Failure to conceive (regardless of cause) after 1 year of unprotected and regular intercourse.¹
- **Frigidity** (Latin, coldness): It is the inability to initiate or maintain the sexual arousal pattern in female (absence of desire for sexual intercourse or incapacity to achieve orgasm).

Question of impotence and sterility arises in:

- **Civil cases**, like divorce, adultery, nullity of marriage, suits of adoption, disputed paternity and legitimacy, claims for damages where loss of sexual function is claimed.
- **Criminal cases**, like adultery, rape, unnatural offences where impotence is cited as defense.

Causes of Impotence and Sterility in Males

- i. **Psychological:** Most important and frequent cause, though transient in nature.² Absence of desire for sexual intercourse may result from dislike of partner, fear of failure, anxiety or mood disorder, guilt, aversion, low self-esteem, hypochondriacs, childhood sexual abuse, masturbatory anxiety ('*dhat*

syndrome'—passage of whitish discharge in urine and believed to be semen), widower syndrome, post-traumatic stress disorder or over-indulgence. Excessive masturbation may also lead to impotence.

- ii. **Age:** Before puberty, boys are usually impotent and sterile with certain exceptions, like precocious puberty. Poor physical development of penis is common cause of impotence—examination depends more on its development than the age. In advanced age, libido diminishes, but they are not impotent or sterile. As long as live spermatozoa are present in seminal fluid, individual is presumed to be fertile.
- iii. **Developmental and acquired abnormalities:** Absence of penis, intersexuality, malformations, e.g. hypospadias, epispadias, absence of testicles, Klinefelter syndrome and cryptorchidism.
- iv. **Local diseases:** Priapism, hydrocele, elephantiasis, phimosis, Peyronie disease, adherent prepuce, orchitis following mumps, syphilis and tuberculosis. Mumps may cause sterility, not impotence. Exposure to X-rays may cause sterility.
- v. **General diseases:** Impotence is common during acute illness and in any severe or debilitating illnesses.
 - **Neurological conditions**, like tabes dorsalis, multiple sclerosis, paraplegia, hemiplegia, syringomyelia, temporal lobe damage and 3rd ventricle tumors; **endocrine disorders**, e.g. diabetes, thyroid dysfunction and testicular atrophy following renal failure, hemochromatosis or cirrhosis; **blood vessel and nerve trauma** (e.g. long-distance bicycle riding), **CVS disorders**, e.g. Leriche syndrome, and diseases like tuberculosis and nephritis may cause impotence and sterility.
 - Malnutrition and zinc deficiency may cause erectile dysfunction.
- vi. **Chronic poisoning:** Exposure to poisons, e.g. lead, arsenic, pesticides or aphrodisiac agents may lead to impotence and/or sterility.

- vii. **Medications:** Antidepressants (e.g. SSRIs), antipsychotics, anti-hypertensives, antiulcer agents (e.g. cimetidine), cholesterol-lowering agents and finasteride may cause impotence.
- viii. **Behavioral factors:** Lifestyle choices—chronic alcoholism, smoking, being overweight and avoiding exercise are possible causes of impotence.
- ix. **Addictions:** Certain drugs, e.g. morphine, heroin, opium, cannabis, cocaine and tobacco may cause impotence and sometimes sterility.

Causes of Impotence and Sterility in Females

- i. **Age:** Being passive partners in intercourse, age has no effect on potency. Women are fertile from puberty to menopause, but may become pregnant before menarche and after menopause.
 - Kraurosis vulvae in old women may cause narrowing of the vagina.
 - The occurrence of infertility rises significantly as age increases.
- ii. **Developmental and acquired abnormalities**
 - Impotence may result from total occlusion of vagina, adhesion of labia, imperforate hymen—can be cured by surgery.
 - Injury or operation of vagina may cause stricture which can lead to impotence.
 - Absence/abnormal uterus, ovaries or fallopian tubes produces sterility, but not impotence.
- iii. **Local diseases**
 - Bartholin cyst, chancre of vulva, stricture due to perineal tear during previous pregnancy, prolapse of uterus/urinary bladder and dyspareunia causes impotence, but not sterility.
 - Pelvic inflammatory disease, peritoneal adhesions secondary to previous pelvic surgery, endometriosis, and ovarian cyst rupture may produce blockage of fallopian tubes and sterility.
 - Diseases of the genital organs (e.g. gonorrhoea), leucorrhoea, acidic vaginal secretions and recto-vaginal fistula do not cause impotence but may produce sterility.
- iv. **General disease:** General infective, metabolic and hormonal conditions may cause sterility, but not impotence.
- v. **Chronic poisoning:** Exposure to poisons, e.g. lead and arsenic may lead to sterility, but not impotence.
- vi. **Environmental factors and addictions:** Occupational exposure to excessive heat, lead,

microwave radiation or X-rays lead to sterility. Drug dependence (alcohol, opium) may lead to sterility.

- vii. **Medications:** Chemotherapy, cessation of oral contraceptives—hormonal imbalance may remain for some time after stopping the pill.
- viii. **Psychological:** In males, psychological factors lead to non-erection (passive), but in females it is active in nature. Fear, pain, disgust or apprehension for intercourse may give rise to *vaginismus* [severe spasm of the lower one-third of vagina involving the paravaginal muscles (levator ani and adductor femoris muscle)]. The spastic contraction of vaginal outlet is an involuntary reflex which replaces the rhythmic contraction associated with anticipated or actual attempt of vaginal penetration.
 - It may occur with equal severity in the women who has borne children, as in virgins.
 - *Etiological factors:* Male sexual dysfunction, psychosexually inhibiting influence due to religious orthodoxy, incidents of prior sexual trauma, secondary to dyspareunia or personal dislike/disgust for coitus.

Examination of a Person in an Alleged Case of Impotence and Sterility

- A sterile person may or may not be impotent and an impotent person may or may not be sterile.
- A simple way to distinguish between organic and psychological impotence is to determine whether the patient 'ever' had an erection. If never, the problem is likely to be organic; if sometimes, it could be organic or psychological.
- Permanent impotence is a ground for nullity of marriage/divorce as he is incapable of fulfilling the rights of consummation of marriage (physical union by coitus), but sterility is not.
- The person is examined only when asked by court or by the police. Informed consent of the person should be taken and the consequences of the examination should be explained.

History: Complete history of previous illness (including surgery), mental condition and sexual history is taken. History of smoking, dietary habits, obesity and the use of various medications are also evaluated.

Psycho-social examination: A psycho-social examination using an interview and a questionnaire, reveals psychological factors. A man's sexual partner

may also be interviewed to determine expectations and perceptions during sexual intercourse.

Examination of a Male

- Complete medical examination including CNS is done, especially if there is history of CNS illness, peripheral neuropathy, diabetes or penile sensory deficit.
- It includes pulse, blood pressure, any abnormal secondary sexual characteristics (hair pattern or breast enlargement), site of urethral meatus, urethral stenosis, sensitivity of the penis to touch or if there is any deformity in the penis itself—whether it is bent or curved when erect, or any other congenital anomalies of the genitalia.
- Testicular size, epididymis, spermatic cord and presence of varicocele are also noted.
- **Bulbocavernosus reflex test** is done to determine if there is adequate nerve sensation in the penis. The doctor squeezes the glans of the penis which immediately causes the anus to contract, if nerve function is intact.

Laboratory examination

It will vary depending upon the history and clinical findings.

- Examination of semen is essential in cases of infertility.
- Tests for systemic diseases include blood counts, blood sugar (evaluation of diabetes), urinalysis, lipid and thyroid profiles, creatinine, liver enzymes and prostate-specific antigen.
- Serum testosterone, LH and serum prolactin.

Other tests

- Evaluation of penile function can be done by direct injection of PGE1 into the corpora. If the penile vasculature is adequate, an erection will develop.
- *Duplex ultrasonography*: Vascular function within the penis including signs of atherosclerosis and scarring or calcification can be evaluated.
- *Ultrasonography of testes*: Detect abnormalities in testes and epididymides. Transrectal ultrasonography can disclose abnormalities in the prostate and pelvis.
- *Nocturnal penile tumescence testing*: Normally, a man has 5-6 erections during sleep, especially during REM—their absence may indicate defect in nerve function or blood supply in the penis. It may be useful in distinguishing psychogenic from organic impotence.
- *Penile biothesiometry*: This test uses electromagnetic vibration to evaluate sensitivity and nerve function in the glans and shaft of the penis.

Examination of a Female

- Gynecologic examination should include an evaluation of hair distribution, clitoris size, Bartholin glands, labia majora and minora and any lesion that could indicate the existence of venereal disease.
- In case of impotency in females, the defect usually lies in vagina and can be clearly observed. The inspection of the vaginal mucosa may also indicate a deficiency of estrogens or the presence of infection.
- The evaluation of the cervix should include a Papanicolaou test and cultures for sexually transmitted diseases.
- The post-coital test (*Sims-Huhner test*) consists of evaluating the amount of spermatozoa and its motility within the cervical mucus during the pre-ovulatory period.
- *Bimanual examination* should be performed to establish the direction of the cervix and the size and position of the uterus to exclude the presence of uterine fibroids, adnexal masses, tenderness or pelvic nodules indicative of infection or endometriosis.

Laboratory tests: Besides routine blood and urine analysis, HSG, pelvic ultrasonography, hysterosonogram and MRI are required.

Opinion

- An opinion of impotence (in males) cannot be given, unless there is gross deviation from normal.
- The opinion should be given in *negative form*—stating that from examination of the male, there is nothing to suggest that the person is incapable of sexual intercourse.
- In case of infertility, opinion can be given with certainty depending on clinical and laboratory findings.

Sterilization

Definition: It is the process to cause a person sterile without affecting his/her potency or sexual functions.

Classification: Sterilization can be classified as given in Flow chart 23.1.

- **Compulsory:** It is performed on a person, compulsorily by an order of the State, carried out on mentally or physically defective person or punishment to sexual criminals or for the purpose of eugenics. It is not done in India.
- **Voluntary:** It is carried on married persons with consent of both the husband and wife. It can be:
 - i. *Therapeutic*: It is done to prevent danger to health or life of women due to future pregnancy.

Flow chart 23.1: Classification of sterilization

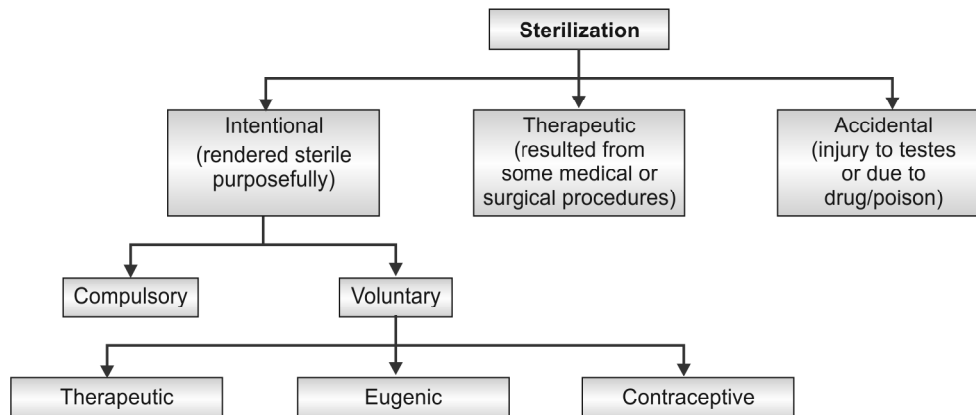

ii. *Eugenic*: It is carried out to prevent conception of the children who are likely to be physically or mentally defective.

iii. *Contraceptive*: It is done as a family planning measure.

Contraception: The term contraception includes all measures (temporary or permanent) designed to prevent pregnancy due to coital act.

Methods (Flow chart 23.2)

*Permanent*³

- **In males:** Vasectomy (dividing the vas deferens). Newer technique uses chemical sclerosing agents, like ethanol, formaldehyde and AgNO₃ that can eliminate the need of surgery.
- **In females:** Tubectomy (fallopian tubes are ligated), hysteroscopy using electro-coagulation/cauterization, laparotomy or minilap (Pomeroy, Madelener, Aldridge methods, Cornual resection and fimbrectomy) and laparoscopy using clips.

Flow chart 23.2: Methods of contraception

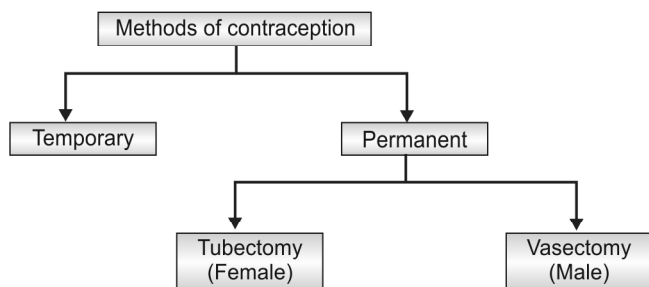

Temporary

- Natural contraception—rhythm method, coitus interruptus and breast feeding.
 - Rhythm period: Observing safe period—abstinence during fertile period of a cycle
 - Coitus interruptus—withdrawal of penis shortly before ejaculation
- Barrier contraceptives (spermicidal agents, diaphragm in females, condom in males).
- Intrauterine devices (IUD) or hormone containing IUD (Copper T 200, Cu T 380A, Multiload 250/375, levonorgestrel intrauterine system, progestasert and Lippes loop).
- Steroidal contraception
 - *Oral contraceptive pills:* Commonly used progestins are levonorgestrel, norethisterone or desogestrel; and estrogens are ethinyl-estradiol or mestranol.
 - *Injectable steroids:* Depo medroxy progesterone acetate (DMPA), norethisterone enanthate (NET-EN).
 - *Implants:* Norplant (levonorgestrel), Implanon (desogestrel).

Medico-legal Aspects

- i. There is no absolute guarantee to sterility after the operation, and the procedure may prove irreversible.
- A man is not sterilized immediately after vasectomy. Additional protection is needed for about 2-3 months following this operation. Condom should be advised for at least 20 ejaculations. Impotency may occur which is mostly psychological.

- Overall failure rate in tubal sterilization is about 0.7%—failure due to fistula formation or due to spontaneous reanastomosis.
- ii. Doctor may be implicated, if he performs sterilization without consent and proper indication. *A written consent of both husband and wife* is essential.
- iii. It is desirable to sterilize only individuals above 30 years of age and having two children, one of whom is male.
- iv. Healthy unmarried/married persons without any issue should not be permanently sterilized, even if they volunteer for the same.
- v. Failure of contraceptive measure adopted by males may lead to suspicion of wife having sexual relationship with another man who may initiate litigation—divorce, illegitimacy, disputed paternity.

Newer contraceptives

- *Per cutaneous vas occlusion* is an effective and reversible method, popular in China. Polyurethane elastomere is injected into vas which forms a plug and blocks the sperm passage. This plug can be removed under local anesthesia.
- *Gossypol*, an extract from cotton seed (discovered in China) and GnRH analogues are other male contraceptives.
- In females, centchroman, transdermal delivery system (nestorone), vaginal rings containing levonorgestrel, LNG rod, uniplant (nomegestral), biodegradable injectable contraceptives, LHRH agonist, quinacrine pellet, frameless IUD (GyneFix) and anti HCG vaccine are being tested.

Artificial Insemination (AI)

Definition: It is the process of introduction of semen from the husband or a donor by instruments into the vagina or uterus of a female to bring about pregnancy which is not attainable by sexual intercourse.

- Semen can be introduced into the vagina (intra-vaginal insemination—IVI), cervix (intracervical—ICI), fallopian tube (intratubal—ITI) or uterine cavity (intrauterine—IUI) of the recipient.
- IUI is the most commonly used method of AI (higher success rate); and IVI (low success rate) and ITI (more invasive, greater risk of infection and higher costs) are the least commonly done AI.

Female infertility accounts for one third of infertility cases, male infertility for another third, combined male and female infertility for another 15%, and the remainder of cases is 'unexplained'.

Types (Diff. 23.1)

- i. AIH (artificial insemination homologous/husband)
- ii. AID (artificial insemination donor)
- iii. AIHD: 'Pooled' donor semen to which semen from husband has been added. There is technical possibility of husband being father of the child.

Procedure: Semen is obtained by masturbation after a week's abstinence and 1 ml is deposited by means of a sterile needleless syringe just above the internal os, at the time of ovulation (14th day after menstruation) (Fig. 23.1).

- The semen to be implanted is 'washed' in a laboratory and concentrated in Hams F10 media without L-glutamine, warmed to 37°C. This 'washing' increases the chances of fertilization while removing mucus and non-motile sperms in the semen.
- A more efficient method of AI is to insert semen directly into the woman's uterus. When this method is employed it is important that only 'washed' semen is used and inserted by means of a catheter.

The success rates of AI vary depending on the type of insemination used, but typically the success rate varies between 5-30%. The success rate can be affected by factors such as stress and quality of the egg and sperm.

Medico-legal Aspects

- i. **Danger of litigation:** The doctor may be sued following the birth of a defective child. To avoid this, the donor must be screened for any genetic defects.
- ii. **Nullity of marriage and divorce:** It is not a ground for divorce, if AI is done for sterility. If AI is due to impotence, it is a ground. If AI is done without the consent of the husband, then he can file for divorce and sue the doctor (regarded as an act of cruelty for the purpose of divorce).

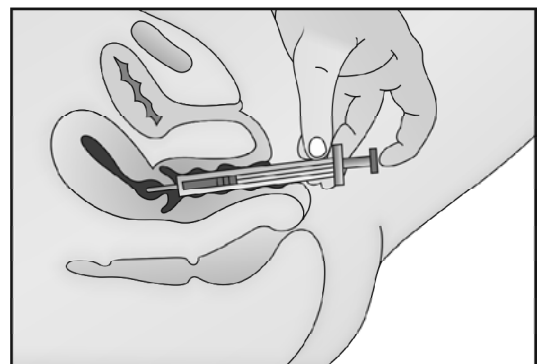

Fig. 23.1: Artificial insemination (intracervical)

Differentiation 23.1: AIH and AID

S.No.	Feature	AIH	AID
1.	Principle	Semen used is derived from woman's husband	Semen of person other than husband is used
2.	Indications	<p><i>Male factor</i></p> <ul style="list-style-type: none"> • Impotency • Defects of the penis, e.g. hypospadias • Retrograde ejaculation • Decreased sperm counts, motility or quality <p><i>Female factor</i></p> <ul style="list-style-type: none"> • Scant/unreceptive mucus • Persistent cervicitis • Cervical stenosis 	<ul style="list-style-type: none"> • Husband sterile • Husband suffering from hereditary disease • Widows/unmarried women desiring children • Rh incompatibility
3.	Consent	Needed from both husband and wife	Needed from husband, wife, donor and donor's wife
4.	Pre-condition	None	Donor should have his own child
5.	Relation with recipient	Husband	Must not be related to either spouses
6.	Donor characteristics	Nothing specific	Must be < 40 years, should resemble closely to the husband in race
7.	Medical tests	Routine tests	Tuberculosis, diabetes, epilepsy, Rh grouping, psychosis, endocrine dysfunction, hereditary or familial disorders and AIDS are ruled out
8.	Disclosure of identity	Not a problem, wife knows	Donor and recipient should not know
9.	Outcome of AI	Known to the husband	Donor should not know
10.	Confidentiality	None	Strictly maintained
11.	Doctor's role	May deliver the child who administered the AI	Should avoid delivering the child, as it would lead to disclosing the identity of father in birth record
12.	Legal problems	No legal complications, except for divorce	Legal problems, like litigation against the doctor, illegitimacy, inheritance claims, divorce, incest and mental trauma may arise

- iii. **Legitimacy:** The artificiality of the process would make no difference in legitimacy in case of AIH and the child would be legitimate child. Since, the husband is not the actual father of the child in AID, child is illegitimate and cannot inherit property, but for all practical purpose, the husband is accepted as father of the child and treated as legitimate and can inherit property.
 - iv. **Adultery:** Recipient cannot be held guilty of adultery because there is no physical union by coitus. Moreover, the Indian law specifically provides that the woman cannot be punished for adultery in any case.
 - v. **Incest:** Risk of incestuous relationship between the offspring born by AI and children of donor is possible.
 - vi. **Natural birth:** Status remains legitimate, but that of AID remains illegitimate.
 - vii. **Unmarried women or widow:** They may have child, but the child would be illegitimate.
 - viii. **Psycho-social aspect:** If it is known that the husband consented to AID and the husband was not capable of consummating the marriage, difficulties may arise. The identity of the donor is kept secret; nevertheless, it is not uncommon for such secrets to be leaked out with adverse consequences.
 - ix. **Rights of sperm donors** are debatable issue nowadays.
- The artificial insemination with donor's semen has not been legalized in India, and should only be undertaken at infertility centres after appropriate

counseling and explanation of its implications to both partners.

Assisted reproductive technology (ART)

Definition: Any fertility treatment in which the gametes (sperms and eggs) are manipulated outside of the body. The gametes or embryos are replaced back into the body to establish pregnancy.

- Surgical removal of eggs is known as *egg retrieval*.
- In-vitro fertilization is the most common ART procedure.

Types of ART procedures

1. **In-vitro fertilization:** IVF involves controlled ovarian hyperstimulation with exogenous gonadotropins, oocyte retrieval via transvaginal ultrasonographic-guided aspiration, fertilization of oocytes with sperm in culture (or intracytoplasmic injection of sperm into the oocyte), and subsequent transfer of the resultant zygotes (3-5 days later) transcervically under ultrasound guidance into the uterine cavity.⁴
2. **Gamete intrafallopian transfer (GIFT):** This involves ovarian stimulation; egg retrieval, followed by laparoscopically guided transfer of a mixture of unfertilized eggs and sperms into the fallopian tube (fertilization takes place inside the female's body).⁵
3. **Zygote intrafallopian transfer (ZIFT):** Eggs are removed, day 1 fertilized eggs (zygotes) are laparoscopically transferred into the fallopian tube, rather than uterus.
4. **Intracytoplasmic sperm injection (ICSI):** Indicated in male factor infertility. One sperm is directly injected into an egg prior to intrauterine transfer of the fertilized eggs.
5. **Ovum donation:** Donor egg IVF is used for patients with poor egg numbers or quality. After inducing super ovulation in an egg donor and followed by egg retrieval; eggs are fertilized by the sperms of the patient's husband and the embryos transferred to the patient's uterus.

6. Micromanipulation techniques include zona drilling and partial zona drilling.

The *Assisted Reproductive Technology (Regulation) Bill* is expected to be passed by the Parliament, which provides guidelines for regulating and supervising ART procedures and clinics throughout India.

Surrogate Mother

Definition: A surrogate (Latin *subrōgare*: to substitute) mother is a woman who carries a child for a couple or single person with the intention of giving that child up, once it is born (also called **surrogate pregnancy**).

The surrogate mother may be the baby's biological mother (*traditional surrogacy*) or she may be implanted with someone else's fertilized egg (*gestational surrogacy*). She accepts pregnancy either by AI or by implantation of in-vitro fertilized ova at the blastocyst stage, till delivery, for the woman who is incapable to bear child.

- **Surrogate parenting** involves a woman bearing the child of another woman, who is not in a position to bear children as a result of blocked fallopian tubes or lack of a uterus. It is the reverse of donor insemination.
- The most common reason for using a surrogate mother is infertility. Gay male couples have also used surrogate mothers in order to have children that at least one partner is biologically related to.
- Surrogacy and posthumous reproduction are the extensions and ramifications arising out of ART. However ethical, legal, religious and social issues surrounding these procedures need to be clarified and understood. These are gray areas to be cautious about.

MULTIPLE CHOICE QUESTIONS

1. **Infertility can be defined as:** UP 11
 - A. Not conceiving after 3 years of marriage
 - B. Not conceiving after 2 years of unprotected intercourse
 - C. Not conceiving after 1 year of unprotected intercourse
 - D. Not conceiving after 1 year of marriage
2. **Most common cause of erectile dysfunction:** FMGE 10
 - A. Psychological
 - B. Drug induced
 - C. Alcohol
 - D. Diabetes
3. **Permanent sterilization are all, except:** PGI 05
 - A. Electrocoagulation
 - B. Vasectomy
 - C. Tube ligation
 - D. Medroxy progesterone
4. **Test tube baby is produced when:** PGI 05
 - A. Sperm and ovum are directly implanted into fallopian tube
 - B. Sperm and ovum are fertilized in test tube and implanted
 - C. Fetus is grown in test tube
 - D. Only sperm is transferred into the cervix
5. **All are steps of GIFT, except:** NIMHANS 11
 - A. Ovulation stimulation
 - B. Oocyte retrieval
 - C. Fertilization of oocyte in lab
 - D. Transfer of unfertilized egg into the fallopian tube

Definitions

- **Virgin** (Latin *virgo*: maiden, *intacta*: untouched): A female who has not experienced sexual intercourse.
- **Defloration**: The act of depriving a woman of her virginity.
- **Marriage**: Legally, marriage is a contract between a man and a woman which implies physical union by coitus.
- **Divorce**: Dissolution of previously valid marriage.

Questions of virginity and defloration arises in:

- Nullity of marriage/divorce
- Defamation
- Rape

Normal Female Anatomy (in Virgins) (Fig. 24.1)

- **Vulva** includes female genitalia visible externally—the *mons veneris* (pad of fat lying in front of the pubis), labia majora and minora, clitoris, vestibule, hymen and urethral opening.
- **Perineum** is the wedge shaped area between the lower end of posterior wall of vagina and the anterior anal wall.
- **Labia majora** are the two elongated folds of skin projecting downwards and backwards from the mons veneris—homologous with the scrotum in males. They

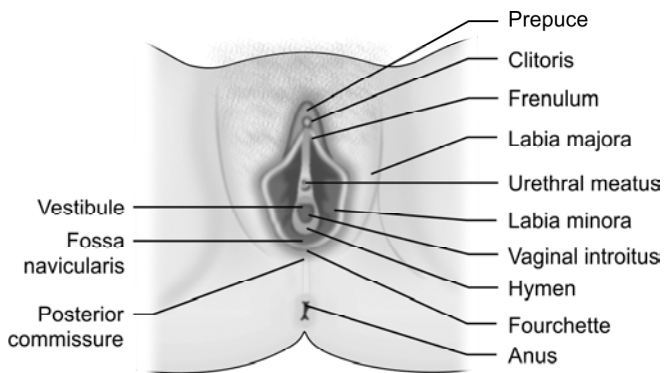

Fig. 24.1: Normal female genitalia (Vulva)
(For color version see Plate 4)

meet in front to form the *anterior commissure*, and in back, the *posterior commissure* in front of the anus.

- **Labia minora** are two pinkish, thin folds of skin just within the labia majora. Anteriorly, they divide to enclose the clitoris and unite with each other in front and behind the clitoris to form the *prepuce* and *frenulum* respectively. The lower portions of labia minora fuse in midline to form a fold called *fourchette*. The depression between fourchette and the vaginal orifice is called *fossa navicularis*.
- **Vestibule** is the triangular space bounded anteriorly by clitoris, posteriorly by fourchette and laterally by labia minora. The clitoris is small and the vestibule is narrow in virgins.
- **Vagina** is narrow and tight, the mucosa is rugose, reddish in color and its walls are approximated. After frequent sexual intercourse, the rugae become less marked, and the vagina lengthens into the posterior fornix.

Hymen: The hymen is a fold of mucous membrane, about 1 mm thick, situated at the vaginal outlet.

- It is usually a thin transparent membrane, but it may be tough, fleshy or cartilaginous.
- In infants, a small swab can be passed through the hymenal orifice into the vagina.
- At ten years of age, the tip of the small finger and at puberty, one finger may be passed into the vagina.

Types of Hymen (Fig. 24.2)

- Annular:** Opening is situated centrally.
- Semilunar or crescentic:** Opening is placed anteriorly.
- Infantile:** Small linear opening in the middle.
- Septate:** Two openings occur side by side, separated by thin hymenal tissue.
- Cribriform:** Multiple openings.
- Vertical:** Opening is vertical.
- Imperforate:** No opening.

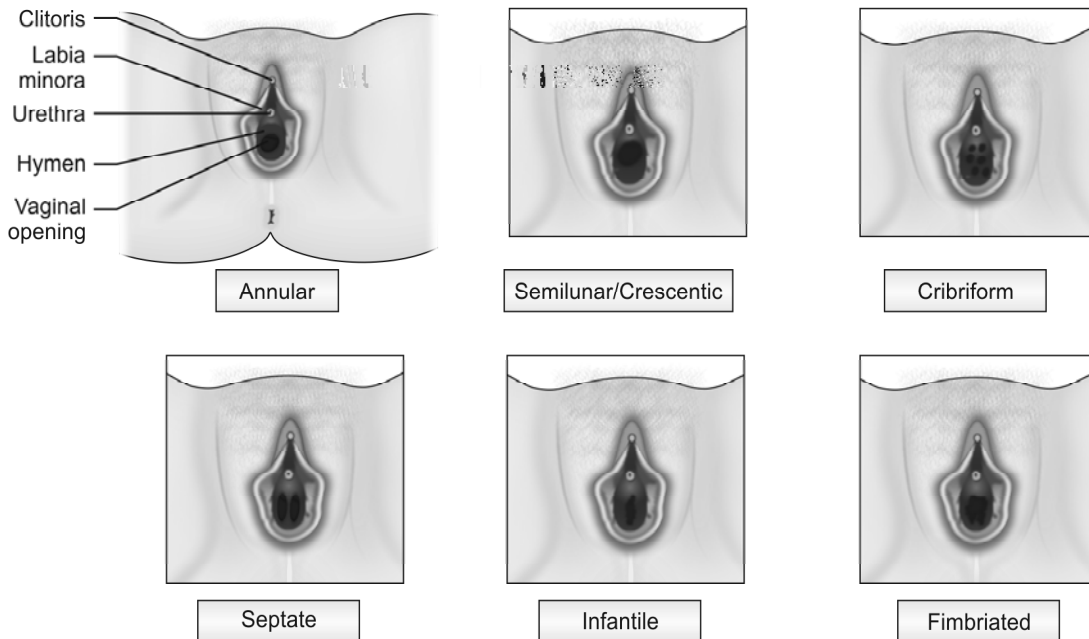

Fig. 24.2: Types of hymen (For color version see Plate 4)

The margin of the hymen is sometimes *fimbriated* and shows multiple notches which may be mistaken for artificial tears.*

Causes of Rupture of Hymen

- i. **Sexual intercourse:** Commonest cause of defloration.
- ii. **Masturbation**, especially with some large foreign body. Hymen is not injured in most cases, as manipulation is usually limited to parts anterior to the hymen.
- iii. An **accident**, like fall on a projecting substance or by slipping on the furniture or fence. It does not rupture by jumping, riding, vigorous exercise and dancing.
- iv. **Gynecological examination** or **surgical operation**.
- v. **Foreign body insertion** for rendering minors fit for sexual intercourse.
- vi. **Sanitary tampons**.

Medico-legal Aspects

Presence of intact hymen is a presumption, but is not an absolute proof of virginity. With an intact hymen, there can be true and false virgins (Diff. 24.1).

- The features will be same for a deflorate woman and a false virgin with the exception of presence of hymen in the latter.

- After the birth of child, hymen is completely lost and the remnants are represented by cicatrized nodules of varying sizes called *the carunculae hymenales* or *myrtiformes*. On both sides, it is lined by stratified squamous epithelium.

When a virgin is placed in lithotomy position with legs wide apart, the vagina remains closed and only the edges of labia minora are seen slightly protruding from between the closed labia majora. A single intercourse does not alter the parts much, except rupture of the hymen.¹

The principal signs of virginity are:

- i. An intact hymen
- ii. Normal condition of fourchette and posterior commissure
- iii. Narrow vagina with rugose walls

PREGNANCY

Definition: It is a condition which occurs in the female when she carries a fertilized ovum within the uterus.

Diagnosis of Pregnancy in the Living
(Flow chart 24.1)

* The notches are usually symmetrical, occur anteriorly, do not extend to the vaginal wall, mucous membrane over the notches is intact, and with no signs of inflammation

Differentiation 24.1: True and false virgin

S.No. Feature	True virgin	False virgin
1. Basic difference	Woman has not experienced sexual intercourse	Woman has experienced sexual intercourse
Genital signs		
2. Hymen	<ul style="list-style-type: none"> Intact, rigid, inelastic Admits tip of little finger through orifice painfully 	<ul style="list-style-type: none"> Intact, but loose, elastic or thick, tough and fleshy Easily admits two fingers through orifice
3. Labia majora	Thick, fleshy, completely close the vaginal orifice	Less fleshy, not apposed to each other, not prominent, vaginal orifice may be seen
4. Labia minora	Small, pinkish, covered by majora and are in close contact with it	Enlarged, pigmented, not in contact, exposed and separated from majora
5. Vagina	<ul style="list-style-type: none"> Narrow Marked rugosity of wall Full length of finger cannot be admitted 	<ul style="list-style-type: none"> Capacious Rugae less obvious Full length can be admitted
6. Fossa navicularis	Present	Disappears
7. Fourchette	Intact	Torn, may show healed scar
8. Vestibule	Narrow	Gaping, wide, spacious
9. Clitoris	Small	Enlarged
10. Posterior commissure	Intact	May be torn
Extra-genital signs (in breasts)		
11. Size, shape and consistency	Small, hemispherical, firm	Large, pendulous, flabby
12. Areola	Pink	Pigmented
13. Nipples	Small, pink	Enlarged, pigmented

Presumptive Signs/Symptoms

- i. **Amenorrhea:** This is the *earliest and one of the most important symptoms of pregnancy*.² Cessation of menstruation may result from ill-health, intense desire for pregnancy or fear of pregnancy after illicit intercourse. Women who have never menstruated may become pregnant, and pregnancy may also occur in a woman during lactational amenorrhea.
- ii. **Changes in breasts:** Changes are quite characteristic in primigravidas, but are of lesser value in multiparas. Tenseness and tingling in the breasts is evident by 6-8th week. The nipples become deeply pigmented and more erectile and the areola becomes dark-brown.
 - Around the nipple, the sebaceous glands become enlarged (*Montgomery's tubercles*) by the end of 3rd month. *Colostrum* (thin, yellowish fluid) is secreted as early as 12th week which becomes thick and yellow by 16th week.
 - Secondary areola, especially in primigravida usually appears by 20th week.
 - After 6th month, *silvery lines or striae* are seen, especially in primiparae due to the stretching of the skin.
- iii. **Morning sickness:** It usually appears about the end of the 1st month and disappears by end of 3rd month. Nausea and vomiting are usually present in the morning and pass off in a few hours. It more prominent in primigravidas.
- iv. **Quickening:** Near about 18th week (16th week in multipara), the pregnant woman feels slight fetal movements in her abdomen (their first appearance is known as '*quickening*'), which gradually increase in intensity.³
- v. **Pigmentation of the skin:** The vulva, abdomen and axillae become darker due to the deposition of pigment and a dark line extends from the pubis to beyond the umbilicus which is called the *linea nigra* (Latin, black line; seen by 20th week).

Flow chart 24.1: Signs of pregnancy

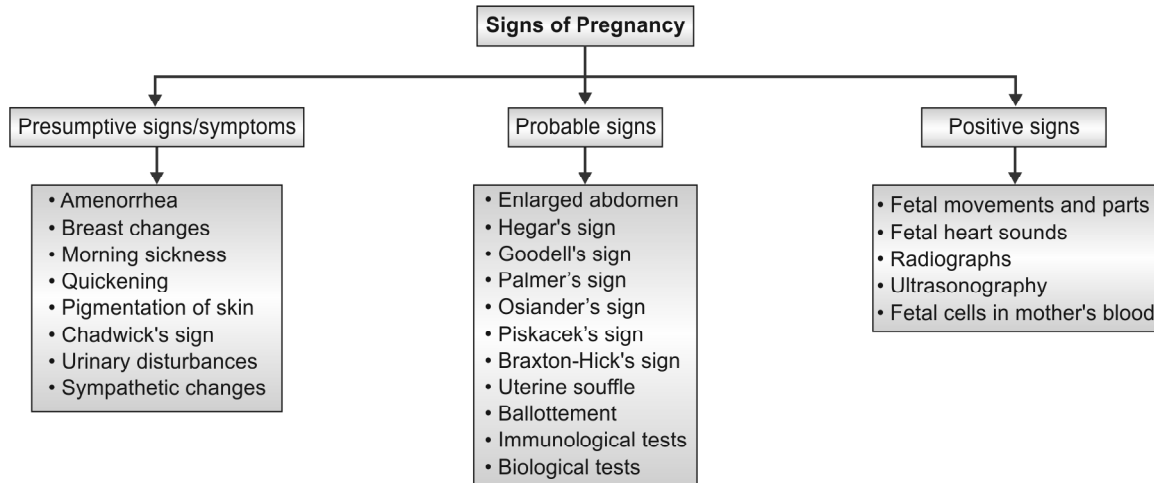

- vi. **Chloasma:** Pigmentation over forehead and cheek may appear at about 24th week.
- vii. **Jacquemier's or Chadwick's sign:** The mucous membrane of the vagina changes from pink to violet, deepening to blue as a result of venous obstruction at about 8th week of pregnancy.
- viii. **Urinary disturbances:** During 8-12th week of pregnancy, the enlarging uterus exerts pressure on the bladder and produces frequent micturition. This gradually disappears after 12th week as the uterus straightens up into the abdomen and reappears a few weeks before term when the head descends into the pelvis.
- ix. **Fatigue:** Easy fatigue is very frequent.
- x. **Sympathetic disturbances:** Salivation, altered appetite and irritable temper are common.

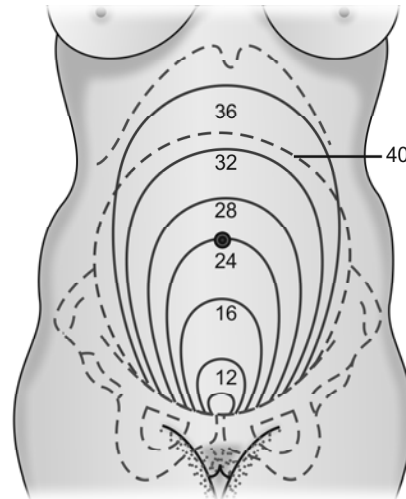

Fig. 24.3: The level of fundus uteri at different weeks
(For color version see Plate 4)

Probable Signs of Pregnancy

- i. **Enlargement of the abdomen (fundal height):** During pregnancy, abdomen gradually enlarges in size after the 12th week as shown in Figure 24.3. During the last two months, the uterus sinks into the pelvis and tends to fall forward due to its weight.⁴
- Uterus feels soft and elastic and becomes ovoid in shape which changes to spherical shape beyond 36th week.
 - The umbilicus becomes level with the skin by about the 7th month.
- ii. **Hegar's sign** is positive between 6-10th week.
Demonstration: If one hand is placed on the abdomen and two fingers of other hand in the

vagina, the firm hard cervix is felt and above it the elastic body of the uterus, while between the two, isthmus is felt as a soft compressible area.⁵ This is the most valuable physical sign of early pregnancy.

- iii. **Goodell's sign:** As early as 6th week, the cervix progressively softens from below upward.⁶ Pregnant woman's cervix feels like lips and non-pregnant woman's like the tip of the nose. The cervical orifice, during the last months of pregnancy, becomes circular instead of being transverse and admits the point of finger to a greater depth.
- iv. **Palmer's sign:** Regular rhythmic contractions of uterus can be elicited by bimanual examination as early as 4-8th week.

- v. **Osiander's sign:** There is an increased pulsation felt through the lateral fornices at about 8th week.
- vi. **Piskacek's sign:** Asymmetrical enlargement of uterus occurs, if there is lateral implantation. Here one half of uterus is more firm than the other.
- vii. **Braxton-Hick's contractions:** Intermittent, spasmodic, painless uterine contractions are observed rarely before the 3rd month, but are easily felt after the 4th month. Each contraction lasts for about a minute and relaxation for about 2-3 min. *They are present even when the fetus is dead.*⁷
- viii. **Ballottement** (toss up like a ball): This is positive during the 4th-5th month of pregnancy as the fetus is small in relation to the amount of amniotic fluid present.⁸
Demonstration
 - *Vaginal/internal ballottement:* Two fingers are inserted into the anterior fornix and a sudden upward motion given. This causes the fetus to move up in the liquor amnii and after a moment, the fetus drops down on the fingers, like a ball bouncing back.
 - *External ballottement:* A sudden motion is given to the abdominal wall covering the uterus, in a few seconds the rebound of the fetus can be felt.
- ix. **Uterine soufflé:** It is a soft blowing murmur, which is synchronous with the mother's pulse. It is heard towards the end of 4th month by auscultation, on either side of the uterus (due to passage of blood through the uterine vessels) just above inguinal ligament.
- x. **Biological tests:** These are based on the reaction of test animals to human chorionic gonadotropins (hCG) in the pregnant woman's serum or urine. The tests are: (rarely done nowadays)
 - a. Aschheim-Zondek test (classical biological test)
 - b. Rapid rat test
 - c. Freidman test or female rabbit test
 - d. Hogben or female toad test
 - e. Galli-Mainini test or male frog test (most popular biological test)
- xi. **Immunological tests:** hCG can be detected in maternal serum/urine by 8-11 days after conception (maximum level is reached in 10-11 weeks).⁹ The test is not reliable after 12 weeks. The advantages of this tests are:
 - a. Convenient and sensitive (accuracy 98%)
 - b. No animal is required
 - c. Results are quicker (2 min)

Immunological tests have replaced biological tests for routine screening. The first voided urine in the morning contains the highest level of hCG and is preferable for testing.

Limitations: It will give positive test with ectopic pregnancy, hydatidiform mole and chorio-carcinoma.

1. **Immunoassays without radioisotopes**
 - a. **Indirect agglutination inhibition test:** A simple rapid test using latex particles coated with a purified preparation of hCG as the antigen and an antiserum to hCG. A drop of antiserum is mixed with a drop of urine on a glass slide for thirty seconds. Then, 2 drops of the sensitized latex particles are added and the slide shaken for 2 min (Flow chart 24.2).
 - b. **Direct agglutination test:** The latex particles are coated with anti-hCG antibodies. This reagent is mixed directly with the urine. If hCG is present in the urine, it will combine with the antibodies and cause agglutination of the latex particles (**positive test**). If no hCG is present in the urine, there will be no agglutination of the latex particles (**negative test**).

Flow chart 24.2: Indirect agglutination inhibition test

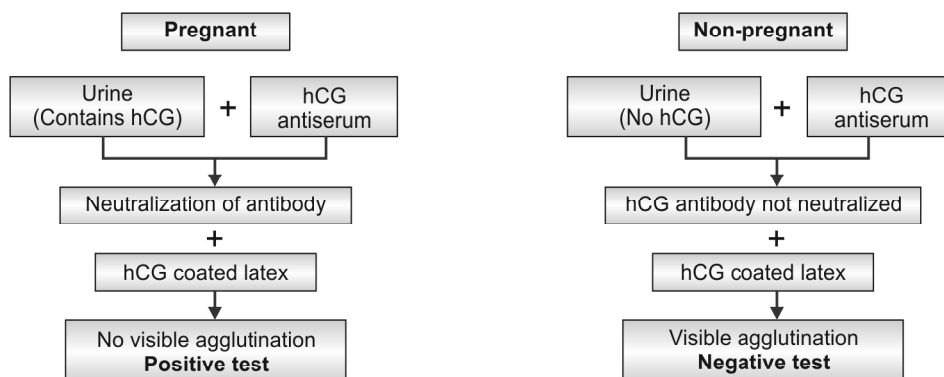

- c. Enzyme-linked immunosorbent assay (ELISA).
- d. Fluoroimmunoassay.

2. Immunoassays with radioisotopes

- a. Radioimmunoassay (RIA).
- b. Immuno-radiometric assay (IRMA).

Positive/Conclusive Signs of Pregnancy^{4,10}

- i. **Fetal movements and parts:** Fetal movements and fetal parts can be identified distinctly by 20th week on abdominal palpation.¹¹
- ii. **Fetal heart sounds:** *Definite sign of pregnancy.* They are heard between 18-20th week with an ordinary stethoscope. The sounds are like the ticking of a watch placed under a pillow. The rate is usually about 160/min at 5th month and 140/min at 9th month, and is not synchronous with the mother's pulse.
 - Uterine soufflé and fetal soufflé (due to inrush of blood through umbilical arteries) may be confused with fetal heart sound.

Fetal heart sounds are not audible:

- Before 18 weeks of pregnancy
- When the fetus is dead
- Hydramnios (excessive quantity of liquor amnii)
- Obese patient
- Fetal position in the uterus is such which prevents transmission of sounds

- iii. **Radiographic imaging:** The earliest fetal skeletal shadow of vertebral dots is visible at about 16th week of pregnancy. The shadows to be searched in the pelvis of the mother are:
 - Series of small dots in a linear arrangement of the vertebral column

- Crescentic or annular shadows of the skull
- Series of fine curved parallel lines of the ribs
- Linear shadows of the limbs

Radiological signs of fetal death

- Spalding's sign (loss of alignment and overriding of skull bones)
- Robert's sign (presence of gas in the heart and great vessels)
- Collapse of the spinal column due to absence of muscle tone

- iv. **Ultrasonography:** Intra-decidual gestational sac is identified as early as 29-35 days of gestation. Gestational sac and yolk sac by 5th menstrual week, fetal pole and embryonic movements by 7th week.¹² *Transvaginal sonography* (TVS) can detect cardiac activity by 5th week and transabdominal sonography by 6th week.^{13,14} Doppler ultrasound can pick up the fetal heart rate reliably by 10th week.
- v. **Fetal cells in mother's blood:** It can be detected by 5th week of pregnancy. Even the sex of the fetus can be determined by karyotyping these cells.

Betke-Kleihauer test: This is a staining technique in which fetal cells can be distinguished from adult red cells. A blood smear is prepared from the mother's blood and exposed to an acid bath. This removes adult hemoglobin, but not fetal hemoglobin from the red blood cells. Subsequent staining makes fetal cells (containing fetal hemoglobin) appear rose-pink in color, while adult red blood cells are only seen as 'ghosts'.¹⁵

Sequential appearance of signs and symptoms of pregnancy are highlighted in Table 24.1.

Table 24.1: Signs and symptoms of pregnancy

Duration	Signs and Symptoms
At 6-8 weeks	
• Symptoms	Amenorrhea, morning sickness, frequent micturition, fatigue and breast discomfort.
• Signs	Breast enlargement. Signs—Jacquemier's, Osiander's, Goodell's, Hegar's and Palmer's. ¹⁶ Immunological tests positive. Sonography: Cardiac activity and embryonic movements.
At 16-18 weeks	
• Symptoms	Amenorrhea, quickening, other symptoms disappear.
• Signs	Breast—pigmentation of areola, prominence of Montgomery's tubercles, colostrum. Uterus—midway between pubis and umbilicus, Braxton-Hick's contractions, uterine soufflé and internal ballottement. X-ray: Fetal shadow.
At 20 weeks	
• Symptoms	Amenorrhea, quickening.
• Signs	Breast—appearance of secondary areola, linea nigra, Uterus—at level of umbilicus (24 weeks), Braxton-Hick's contractions, external ballottement and internal ballottement (16-28 weeks). Fetus—parts, movements and heart sounds.

Maximum and Minimum Period of Gestation

- The usually accepted average is 280 days from the first day of the last menstrual period, so that the actual period of gestation is about 270 days or less.
- The woman may over-carry the fetus to post-maturity upto a period of 320 days or even upto 350 days.
- Expulsion of fetus may occur at any period before full term. But for a fetus to be viable, it should be of 210 days gestation.
- A fetus born after 180 days of gestation may survive, if proper care is taken.

Diagnosis of Pregnancy in the Dead

External physical changes should be noted. In the internal examination, the following should be looked for:

- Presence of embryo, fetus, placental tissue or membranes—*positive proof of pregnancy*
- Enlarged and thickened uterus
- Corpus luteum in ovary—corroborative evidence.

Pseudocyesis (Spurious/False/Phantom Pregnancy)

Definition: It is a psychological disorder where the woman has the false but firm belief that she is pregnant, although no pregnancy exists.

- It is generally observed in infertile females or women nearing menopause, who desire a child intensely.
- Most of these women suffer from some form of psychic or hormonal disorder.
- Such patients may present with all the subjective symptoms of pregnancy including cessation of menstruation and associated with a considerable increase in the size of the abdomen which may be due to abnormal deposition of fat or due to pathological conditions, like ovarian tumor or ascites.
- The woman may have secretions from the breasts and intestinal movements which she imagines as fetal movements and may have false labor pains.
- Obstetrical examination along with ultrasonography and/or immunological tests for pregnancy will clear the patient of her imagination.

Superfecundation

Definition: Fertilization of two ova discharged from ovary at the same period of ovulation by two different acts of coitus committed at short intervals.

- The term is also used to refer to instances of two different males fathering fraternal twins, though this

is more accurately known as heteropaternal superfecundation. This leads to the possibility of twins also being half-siblings, classic example being one baby is white and the other black.

- **Medico-legal aspect:** Gross variations may occur in the complexion and features of the two babies and may give rise to the doubt of adultery and infidelity.

Superfetation

Definition: Fertilization of two ova discharged from ovary at different periods of ovulation.

- It is fertilization of second ovum in a pregnant woman.
- In this, one fetus always remains more developed than the other and may be born either at the same time showing different maturation or may be born at different periods, varying from 1-3 months.
- Possibility is more with septate or double uterus.

Fetus compressus or papyraceus: In a twin pregnancy, one fetus may grow at the cost of the other. The latter may die, flattened by pressure into a 'mummified' parchment-like state known as *fetus papyraeus* and may not be recognizable. It is retained till labor expels it.

- The term superfecundation is derived from *fecund*, meaning the ability to produce offspring.
- **Fraternal twins** (non-identical twins) occur when two fertilized eggs are implanted in the uterine wall at the same time and form two zygotes. They are also known as *dizygotic twins*.¹⁷
- **Identical twins** occur when a single egg is fertilized to form one zygote (*monozygotic*), but the zygote then divides into two separate embryos which develop into fetuses sharing the same womb.
- **Vanishing twin syndrome** (*twin embolisation syndrome/fetal resorption*) is the presence of a multifetal gestation with subsequent disappearance of one or more fetuses. This syndrome has been diagnosed more frequently since the use of sonography in early pregnancy. In this, there may be complete resorption of a fetus or formation of a fetus papyraceus or development of a subtle abnormality on the placenta such as a cyst, subchorionic fibrin or amorphous material.

Legitimacy and Paternity

Definitions

- **Legitimacy:** It is the legal state of a person born in a lawful marriage.

- **Legitimate child:** Person who is born during the continuance of a legal marriage or within 280 days after the dissolution of the marriage by divorce or death of the husband and the mother remaining unmarried (Sec. 112 IEA).
- **Illegitimate child or bastard:** Child born out of lawful wedlock or not within a competent time after dissolution of marriage or if it can be proved that the alleged father is:
 - i. Under the age of puberty
 - ii. Physically incapable to beget children, because of illness, impotence or sterility
 - iii. Not having access sexually to his wife during the time that the child was begotten
 - iv. Having incompatibility of blood groups.

Questions of legitimacy and paternity arise in:

- i. **Inheritance claims:** A legitimate child born during lawful wedlock can inherit the property of its father.
- ii. **Affiliation cases:** A woman may allege a particular man to be the father of her child and file a case in the court for fixing the paternity.
- iii. **Supposititious child (fictitious child):** A woman may pretend pregnancy and delivery and later produce a living child as her own, or she may substitute a male child for female child born of her, or after an abortion.¹⁸ This is done for obtaining money or for the purpose of claiming property.
- iv. **Posthumous births:** Birth of a child after the father has died.
- v. **Nullity of marriage and divorce.**

Atavism (Latin *atavus*: ancestor; *atta*: father + *avus*: grandfather): The reappearance of a characteristic in an individual after several generations of absence, usually caused by the chance recombination of genes. The child may not resemble its parents, but resembles its grandparents.¹⁹

Signs and Symptoms of Recent Delivery in Living

Definition: Delivery is the expulsion or extraction of the child at birth.

Symptoms

- Indisposition and fatigue
- Diuresis: 2-5 days
- Loss of weight
- Intermittent contraction of uterus—*after pains*
- Rise in temperature—first 24 h (100-101°F)
- Transient depression—puerperal psychosis

Signs

- i. **Breast changes:** Voluminous and pendulous. Colostrum or milk may be expressed. Areola is dark, nipples are enlarged and superficial veins are prominent. Montgomery's tubercles are present.
- ii. **Abdomen:** Walls are pendulous, wrinkled with striae gravidarum and linea nigra.
- iii. **Perineum:** Rupture of fourchette and posterior commissure with/without a sutured incision of episiotomy may be seen.
- iv. **Vagina:** Purple hue, loss of rugosity, relaxed, spacious and may show recent tears.
- v. **Labia majora and minora:** Tender, swollen, gaping and congested.
- vi. **Cervix:** Soft, collapsed and congested; external os shows transverse laceration of its outer margins and admits 2 fingers easily. At the end of 1 week, the cervix admits 1 finger with difficulty and comes back to normal within 2 weeks.
- vii. **Uterus** (Fig. 24.4)
 - Upper border lies 4-5 cm below umbilicus (13.5 cm above the symphysis pubis): 1st day after delivery²⁰
 - Fundus midway between umbilicus and symphysis pubis: 6th day (steady decrease in height by 1.25 cm/day)²¹
 - Descends within true pelvis: 2 weeks²²
 - Returns to parous size: 6-8 weeks.
- viii. **Laboratory investigations:** Immunological tests are positive for about 7-10 days after delivery.
- ix. **Lochia** (Greek *lochia*: of childbirth): It is an alkaline discharge from uterus, cervix and vagina with peculiar, disagreeable fishy odor.
 - It lasts for 2-3 weeks after delivery.

Types

- a. **Lochia rubra** (1-4 days) is bright red in color and consists of blood, shreds of fetal membranes and deciduas, vernix caseosa, lanugo and meconium.
- b. **Lochia serosa** (5-9 days) is watery and pale, and consists of less RBC but more leucocytes, wound exudates, mucus from the cervix and microorganisms (anaerobic Streptococci and Staphylococci).
- c. **Lochia alba** (10-15 days) is scanty, thicker, grayish yellow and then whitish till final disappearance. It contains decidual cells, leucocytes, mucus, cholesterol crystals, fatty and granular epithelial cells and microorganisms.

Significance of lochia: The average amount of discharge for first 4-5 days is about 250 ml. If it smells offensive, then it indicates infection. If scanty or absent or excessive— infection; persistence of red color beyond normal— subinvolution or retained bits of conceptus; and duration beyond 3 weeks suggest local genital lesion.

Signs of Recent Delivery in Dead

All the local signs mentioned above may be present. The size of uterus will vary with the time after delivery at which death occurred (Table 24.2). The ovaries and fallopian tubes are congested and become normal in few days. A large corpus luteum is present in one of the ovaries.

Signs of recent delivery (both living and dead)

- Engorged breasts
- Pink striae on the abdomen
- Enlarged uterus
- Fresh tears of the vulva, vagina or cervix
- Lochia from the uterus

Signs of Remote Delivery in Living

The only sign which proves delivery is the *appearance of the internal os*.

- **Breasts:** Flabby, dark areola with Montgomery's tubercles, nipples are prominent and white striae.
- **Abdominal wall:** Lax, loose, presence of striae gravidarum and linea alba.
- **Perineum:** Lax, old scarring from previous perineal laceration or episiotomy may be seen.

Table 24.2: Size of uterus after delivery

Time after delivery	Dimension (cm)	Weight (g)	Placental site diameter (cm)
Immediate	20 × 15 × 5	1000	10-15
1st week	14 × 8 × 4	500	4
2nd week	12 × 7 × 3	300	2.5
3rd week	9 × 5 × 2	100	1.5

- **Introitus:** Gaping; labia majora are not in close apposition and labia minora is pigmented and protrude out; presence of carunculae myritiformes.
- **Uterine wall:** Less rigid, contour of uterus is broad and round rather than ovoid.
- **Vagina:** Roomy with loss of rugosity.
- **Cervix:** Cylindrical, external os is transverse, patulous slit and may admit tip of finger.

Signs of Remote Delivery in Dead

In addition to the signs seen in the living subjects, there will be findings in the uterus as mentioned in Diff. 24.2 and shown in Figure 24.4.

Medico-legal Aspects of Pregnancy and Delivery

Questions of pregnancy and/or delivery may arise in the following cases:

- i. *Execution of judicial death sentence:* When a woman sentenced to death, pleads that she is pregnant to avoid execution. The High Court can postpone execution upto 6 months post-delivery of the child.

Differentiation 24.2: Nulliparous and parous uterus (Fig. 24.4)

S.No. Feature	Nulliparous uterus	Parous uterus
1. Size	Small (7 × 5 × 2 cm ³)	Large (10 × 6 × 2.5 cm ³)
2. Weight ²³	40-50 g	80-100 g
3. Length	Body and cervix have same length	Body twice the length of cervix
4. External os	Circular, dimple like	Transverse patulous slit
5. Internal os	Circular, well defined	Ill-defined, margin wrinkled
6. Shape of cervix ²⁴	Conical	Cylindrical
7. Upper surface of fundus	Less convex and in same line as broad ligament	More convex and at higher level than the line of broad ligament
8. Uterine cavity	Inner walls convex, smaller and triangular cavity	Inner walls concave, spacious and rounded cavity
9. Arbor vitae*	Present	Disappears (absent)
10. Scar for placental attachment	Absent	Present

* Mucosal folds in the cervical canal which extends from internal to external os.

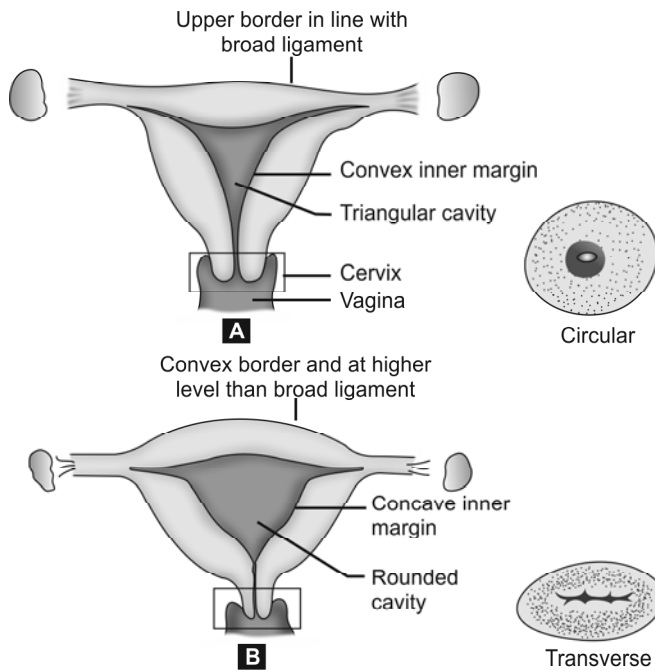

Fig. 24.4: Shape of uterine cavity in (A) Nulliparous
(B) Parous woman

- ii. *Deferring trial of a case:* When a woman pleads pregnancy (delivery is imminent) to avoid attendance as witness in the court.
- iii. *Feigned pregnancy and delivery:* When a woman feigns pregnancy soon after death of her husband and later produces a child to claim greater share of property and compensation.
- iv. *Criminal breach of trust/rape:* When pregnancy is claimed to be the result of rape, kidnapping and seduction or breach of promise of marriage.
- v. *Blackmail:* When a woman blackmails a man and claim's that she is pregnant by him to compel marriage. She may produce a suppositious child to extort money.
- vi. *Disputed chastity:* In allegations of an unmarried woman, widow or a wife, living apart from her husband that she is pregnant or delivered a child.
- vii. *Homicide or suicide:* When pregnancy is alleged to be the motive for murder or suicide of an unmarried woman or widow.
- viii. *Affiliation cases:* The woman may claim a child fathered by her husband who has subsequently divorced her or by a person who is not her legally wedded spouse and force him to adopt the child as his own and pay maintenance allowance.

- ix. *Concealment of birth:* In cases of alleged concealment of birth or pregnancy in an unmarried woman or widow or out of wedlock.
- x. *Criminal abortion and infanticide:* When there is an allegation of sex selective abortion or killing of an infant.
- xi. *Nullity of marriage and divorce:* When there is allegation of the woman becoming pregnant when the husband was not having access physically, or delivery occurring before the minimum period of gestation, the issue may be brought to the court for nullity of marriage.
- xii. *Maternity/Paternity leave:* For claiming benefit of leave facility for working women or men.
- xiii. *Legitimacy:* For such claims, it must be proved that the woman indeed delivered a child at the time claimed by her.

Written informed consent needs to be taken before examination after explaining reasons and possible consequences.

Nullity of Marriage and Divorce

Sec. 11, 12 and 13 of the Hindu Marriage Act, 1955 deals with grounds for void and voidable marriages, and grounds for divorce respectively.

i. Grounds for void and voidable marriage

Void marriage, i.e. null from the time of inception

- Bigamy (another marriage without dissolution of earlier marriage)
- Prohibited degree of relationship (related by blood) unless custom permits such marriage
- Sapinda relationship (relationship extending to 3rd generation in the line of ascent through mother and 5th generation through father)

Voidable marriage, i.e. it remains valid until annulled by the court

- Impotence
- Unsoundness of mind of either party at the time of marriage
- Consent of either party was obtained by force, fraud or misconception of facts
- Pregnancy of the female by some other person and the husband was ignorant of the fact at the time of marriage

ii. Grounds for divorce

- *Adultery:* Voluntary sexual intercourse with any person other than his/her spouse.
- *Cruelty:* Willful and unjustifiable conduct so as to cause danger to life, limb or health of another (including mental health).

- *Desertion*: Abandonment of one spouse without reasonable cause and without consent or against the wish of other.
- *Apostasy*: Change of religion.
- *Unsoundness of mind*.
- *Virulent leprosy and sexually transmitted diseases* including AIDS.
- *Renouncing the world*.
- *Additional grounds for woman*: Husband convicted of rape, sodomy or bestiality.

MULTIPLE CHOICE QUESTIONS

- Definitive finding in deflorate woman:** *Maharashtra 10*
 - Pigmented labia minora
 - Roomy vagina
 - Large clitoris
 - Torn hymen
- First symptom of pregnancy is:** *Kerala 07*
 - Tingling in the breasts
 - Amenorrhoea
 - Morning sickness
 - Quickening
- Quickening appears at about:** *PGI 09*
 - 6 weeks
 - 8-10 weeks
 - 16-20 weeks
 - 20-24 weeks
- Wrong statement about pregnancy is:** *UP 08*
 - Amenorrhoea is the earliest symptom
 - Fetal heart sounds heard between 18-20th weeks
 - Fetal parts are palpable at 20 weeks of gestation
 - At 40th week, fundal height is at xiphisternum
- Softening of uterine isthmus and lower segment in early pregnancy is known as:** *UP 07; Manipal 11*
 - Hegar's sign
 - Braxton Hick's sign
 - Goodell's sign
 - Osiander's sign
- Goodell's sign means:** *JIPMER 07*
 - Pulsation in the lateral vaginal fornix
 - Bluish color change in the vagina
 - Softening of the cervix from below upward
 - On bimanual palpation, the fingers can be approximated, as if nothing is in between
- True about Braxton-Hicks contraction are all, except:** *Maharashtra 09*
 - Felt at 4th month
 - Painful
 - Contraction last for 1 minute
 - Present even when fetus is dead
- External ballottement can be done after how many weeks of gestation:** *Manipal 10*
 - 6 weeks
 - 16 weeks
 - 20 weeks
 - 24 weeks
- In a normal pregnancy, maternal hCG level is maximum at gestational age of:** *UPSC 07*
 - 8 to 10 weeks
 - 12 to 14 weeks
 - 16 to 18 weeks
 - after 20 weeks
- Definite diagnosis of pregnancy include all, except:** *Kerala 09; 11*
 - Fetal heart sound
 - Palpation of fetal parts
 - Fetal skeleton on X-ray
 - hCG in blood
- Fetal parts are palpable at the earliest by:** *Maharashtra 08*
 - 16 weeks
 - 18 weeks
 - 20 weeks
 - 28 weeks
- Gestational sac can be seen using ultrasonography at the earliest by:** *Gujarat 07*
 - 3rd week
 - 4th week
 - 5th week
 - 8th week
- Fetal heart activity can be detected by sonography at about:** *PGI 02*
 - 5 weeks
 - 6 weeks
 - 7 weeks
 - 8 weeks
- Transvaginal USG can detect fetal cardiac activity in:** *PGI 03; DNB 10*
 - 5 weeks
 - 6 weeks
 - 7 weeks
 - 8 weeks
- Fetomaternal transfusion of fetal RBCs in mother can be detected by:** *UPSC 08; TN 08; AIIMS 10*
 - Direct Coomb's test
 - Betke-Kleihauer test
 - Electrophoresis
 - Indirect Coomb's test
- NOT a sign of early pregnancy:** *UPSC 07*
 - Goodell's sign
 - Hegar's sign
 - Cullen's sign
 - Palmer's sign
- True about fraternal twins are:** *UP 11*
 - Dizygotic twins
 - Comes from single egg
 - Two eggs fertilized at different period of gestation
 - Unrelated by birth

1. D 2. B 3. C 4. D 5. A 6. C 7. B 8. C 9. A 10. D
 11. C 12. C 13. B 14. A 15. B 16. C 17. A

18. **True about suppositious child:** *PGI 07, 08; Manipal 11*
 A. Child who is born after father dies
 B. Child born through artificial insemination
 C. Woman claim the child as her own
 D. Child born out of wedlock
19. **Atavism is inheritance of features of:** *Kerala 11*
 A. Father B. Mother
 C. Grandfather D. Uncle
20. **Immediately after delivery, uterus is at the level of:** *MP 07*
 A. Midway between the umbilicus and symphysis pubis
 B. Just below umbilicus
 C. Midway between xiphisternum and umbilicus
 D. Descends into true pelvis
21. **Rate of involution uterus following delivery:** *FMGE 09, 11*
 A. 1 cm/day B. 1.25 cm/day
 C. 2.25 cm/day D. 2.5 cm/day
22. **Following delivery, uterus becomes a pelvic organ after:** *UPSC 07; Manipal 11*
 A. 2 weeks B. 4 weeks
 C. 6 weeks D. 8 weeks
23. **Weight of a virgin uterus is:** *Orissa 04*
 A. 50 g B. 100 g
 C. 200 g D. 150 g
24. **Shape of nulliparous cervix is:** *AI 07*
 A. Conical B. Circular
 C. Longitudinal D. Cylindrical

Natural Sexual Offences

25

Definition: Sexual offences are acts of illegal sexual intercourse with another person or with an animal or any other illegal act to obtain sexual gratification.

It can be classified into four types (Table 25.1):

- i. Natural offences
- ii. Unnatural offences
- iii. Sexual perversions
- iv. Other sex-linked offences.

NATURAL SEXUAL OFFENCES

Definition: It includes those offences which are committed *in order of nature*, i.e. by penetration of the vagina by the penis.

Rape

Definition: Rape (Latin *rapere*: to seize or take by force) is an unlawful sexual intercourse by a man with a woman and is defined under **Sec. 375 IPC**.¹

A man is said to commit rape, when he has sexual intercourse with a woman:

- i. Against her will
- ii. Without her consent
- iii. With or without consent, when she is under 16 years of age²
- iv. With her consent when:
 - It has been obtained by putting her or any person she is interested, in fear of death or hurt.

- The man knows that he is not her husband and she believes that he is the man to whom she is or believes herself to be lawfully married (*impersonation*).
- At the time of giving such consent by reason of unsoundness of mind or intoxication or the administration by him or through another of any stupefying substance, she is unable to understand the nature and consequences of that to which she gives consent.

Exception: Sexual intercourse by a man with his wife (even against her will) is not rape, if she is more than 15 years of age.³

- **Custodial rape:** Rape of a woman by persons who are in position of authority, e.g. police officers, jail warden or hospital staff and who abuse their position to commit the offence, when the woman is under their custody/care.
- **Gang rape (pack rape):** When more than one person rapes a woman, each one is deemed to have committed gang rape.⁴
- **Statutory rape:** It is the crime of having sexual intercourse with a girl under the age of consent. In India, the age of consent is 16 years (not being his wife).⁵

Punishment for rape and intercourse not amounting to rape

As per **Sec. 376 IPC**:⁶

- i. Punishment for rape may extend from 7 years to life imprisonment and also fine.⁷ If the woman

Table 25.1: Classification of sexual offences

Natural sexual offences	Unnatural sexual offences	Sexual perversions	Other sex-linked offences
<ul style="list-style-type: none"> • Rape • Incest • Adultery 	<ul style="list-style-type: none"> • Sodomy • Tribadism/lesbianism • Bestiality • Buccal or oral coitus 	<ul style="list-style-type: none"> • Sadism • Masochism • Fetishism • Transvestic fetishism • Exhibitionism • Masturbation • Voyeurism • Frotteurism 	<ul style="list-style-type: none"> • Indecent assault

raped is his wife and is not under 12 years, the imprisonment may extend to 2 years with/without fine.

- ii. Whoever commits rape—being a police officer, public servant, the management or the staff of a jail or a hospital, or on a woman knowing to be pregnant, or on a girl below 12 years, or commits gang rape, is punished with rigorous imprisonment of not less than 10 years or life imprisonment and also fine.

Following new sections have been introduced under Sec 376 IPC with a view to prevent sexual abuse of a woman by persons who are under their custody and may take advantage of his official position, and wherein such sexual intercourse may not amount to the offence of rape:

- i. Intercourse by a man with his wife during judicial separation without her consent—punishment is for 2 years and fine [Sec. 376 (A) IPC].
- ii. Intercourse by public servant with woman in his custody—punishment is for 5 years and fine [Sec. 376 (B) IPC].
- iii. Intercourse by superintendent of jail or remand home—punishment is for 5 years and fine [Sec. 376 (C) IPC].
- iv. Intercourse by any member of the management or staff of a hospital with any woman in that hospital—punishment is for 5 years and fine [Sec. 376 (D) IPC].⁸

Limitations of rape laws

In present circumstances, definition of rape falls extremely inadequate and fails to address many situations:

- It is silent on forced penetration of objects and parts of body into vagina and anus, and forced oral or anal intercourse.
- It also does not recognize other forms of sexual assaults like protracted sexual assaults by relatives or marital rape as aggravated forms of rape.

In many cases of child abuse, the child has been penetrated through fingers or objects or been forced to perform oral sex, yet this is not considered rape by the court.

- **Carnal knowledge** (Latin *carnalis*: fleshly, sexual relations): The act of a man having sexual relation with a woman and includes even 'slight penile penetration of the labia minora'.
- Three elements are necessary for rape of a female: carnal knowledge, force and commission without consent.

- **Sexual battery:** It means non-consensual oral, anal or vaginal penetration by or union with the sexual organ of another, or the anal or vaginal penetration of another by any other object; however, sexual battery shall not include acts done for bona fide medical purposes. This is more term inclusive phrase than *rape*.
- Under the *British Sexual Offences Act 2003*, rape was redefined from non-consensual vaginal or anal intercourse and is now defined as non-consensual penile penetration of the vagina, anus or mouth of another person. The changes also made rape punishable by a maximum sentence of life imprisonment.
- **Drug-facilitated rape:** Drugs, such as flunitrazepam (Rohypnol) and gamma-hydroxybutyrate are referred to as 'date rape drugs' have been used by rapists to render their victims unconscious, before raping them.

Consent

A woman of 16 years and above can give valid consent for sexual intercourse. The consent must be free and voluntary and given while she is of sound mind and not intoxicated. The consent should be obtained prior to the act.

Presumption and proof of consent

Consent or its absence can be presumed from the attendant circumstances of each case.

- The foremost circumstance is the evidence of resistance (tearing of clothes or infliction of personal injuries on the body and even on the genitalia) from a woman unwilling to yield to sexual intercourse forced upon her.
- It is necessary to prove that the woman offered resistance and all means had been tried to prevent sexual intercourse, e.g. shouting, crying, beating and biting.
- The woman may yield from fear or exhaustion in which case it is regarded as rape. A woman may faint due to fear and suddenness of the situation or may have been drugged or may get unconscious from any cause, and children may not be able to resist.
- The resistance offered depends upon the type of woman, her age, development and on her social status.

Consent is invalid when:

- i. Obtained by fraud as by impersonation of the husband or by misrepresentation of facts.
- ii. Obtained by putting her or any person whom she is close, in fear of death or hurt.
- iii. Obtained from a woman who is of unsound mind, insensible, asleep, unconscious or in a state of drunkenness.
- iv. The woman is < 16 years of age.
- v. Obtained after the act.

- The age at which individuals are considered competent to give consent for sexual intercourse is called the **age of consent**. The age set by each country/state vary in accordance with local standards.
- In Manipur, it is statutory rape if sexual intercourse is done with a girl is < 14 years of age and it will be considered rape if intercourse is done with his wife < 13 years of age (state amendment of Sec. 375 IPC).

Medico-legal Aspects of Definition of Rape

Will and consent are different: Every act done *against the will* is done *without her consent*, but an act done *without the consent* of a person is *not necessarily against her will*. Sexual intercourse with an unconscious woman cannot be said to be against her 'will', but it will be 'without her consent'. But an act against her will is necessarily 'without her consent'.

- A woman may have the will for sexual intercourse, but she may not give consent for shyness, fear of detection and social stigma of getting pregnant.
- Women may be raped during sleep, thus being unable to give prior consent. But rape is usually not possible without waking up the lady.
- A man can impersonate as the husband of the victim in the darkness, or in case of twins one may impersonate the other.
- A woman may give her consent suppressing her unwillingness due to some other factor, e.g. for monetary benefit.
- Sometimes, a girl may give her consent for intercourse, and then later deny that she agreed and accuses the man of rape. This may be due to fear of pregnancy, venereal disease or breakdown of relationship where motive of revenge is present.
- Ordinarily, the burden to prove unwillingness and absence of consent lies with the prosecution. But in rape case, under Sec. 376 IPC, if the victim states in the court of trial that she did not give consent, it then lies with the accused to prove that she consented for the intercourse.
- The law provides the same protection to a prostitute against sexual assault, as it does for chaste woman (i.e. consent is required for intercourse).⁹ But when a prostitute makes a charge of rape, the case must be more closely scrutinized, something more than medical evidence would be required to establish such a charge.
- **Medical proof of intercourse is not legal proof of rape.** In short, rape is not a medical diagnosis, but a legal definition.

By a man: In India, the law does not presume any limit of age under which a boy is considered physically incapable of committing rape.¹⁰ In a charge of rape brought against a boy, the court decides the question of his potency from evidence of the case and is guided by Sec. 82 and 83 IPC in awarding punishment. Likewise, there is no upper limit and even old people have committed rape.

In England and Wales, a boy under 14 years of age cannot be charged of rape.

Of a woman: Only a man can rape a woman as per law on rape in most countries, *except in France* where just like a man, a woman can be charged for committing rape on a man.

- In India, a woman may be charged for committing an indecent assault on a man.
- There is no age limit of a female, below or above which a man cannot commit rape.

What constitutes rape?

- *The slightest penetration of penis within the vulva* (passage of glans between the labia) with or without emission of semen or rupture of hymen constitutes rape. There need not be intercourse and the act may not be completed.
- Rape can be committed even when there is inability to produce an erection or ejaculation.
- Rape can occur without causing any injury and hence negative evidence does not exclude rape. The doctor should mention only the negative facts, but should not give his opinion that rape has not been committed.

Legal sections related to rape

- *Punishment of revealing the identity of rape victim:* If anyone prints or publishes the name or any matter which may reveal the identity of victim of rape, then he is punished with imprisonment for a term upto 2 years and fine (Sec. 228A IPC).¹¹
- *Presumption of consent:* In a prosecution for rape under Sec. 376 IPC when sexual intercourse by the accused is proved, and the question is whether it was without the consent of the woman and she states in her evidence before the court that she did not consent, *the court shall presume that she did not consent* (Sec. 114 IEA).
- *Cross-examination in rape trial:* It is not permissible to put questions in cross-examination of victim about her general immoral character and court should not describe her to be of loose character (Sec. 146 IEA).
- *Courts in which rape offences to be tried:* The offence under Sec. 376 and Secs. 376 (A) to 376 (D) IPC should be tried as far as practicable by a court presided over by a woman [Sec. 26 (a) CrPC].

- *Place for recording of statement:* Recording of statement of victim should be done at her residence or at a place of her choice and as far as practicable by a woman police officer in the presence of her parents or guardian or near relatives or social worker of the locality [Sec. 157 (7) CrPC].
- *Time period of trial of rape cases:* The inquiry/trial of an offence under Secs. 376 to 376D IPC should be completed within a period of 2 months from the date of commencement of the examination of witnesses and without any adjournment on frivolous grounds (Sec. 309 CrPC).
- *Trial of rape case* are to be held in-camera by a woman judge/Magistrate if available, and allowed the printing or publication of proceedings in rape cases subject to maintaining anonymity of the parties [Sec. 327 (2) & (3) CrPC].
- *Report of police officer on completion of investigation:* The investigation in relation to rape of a child may be completed within 3 months from the date on which the information was recorded by the officer in-charge of the police station [Sec. 173 (7) (1A) CrPC].

- **In-camera:** 'In a room'. In-camera proceedings are heard in a Judge's private chamber or in a courtroom which has been cleared of all spectators.
- The Supreme Court has held that there is no need for corroborating evidence, if the victim's version inspires confidence and appears credible since Indian girls will not lie about sexual assault. At the same time, the Court has stated that rape victim's testimony cannot be considered to be the gospel truth. Although, the statement of victim must be given primary consideration, there can be no presumption that she is telling the ultimate truth as the charge has to be proved beyond reasonable doubt as in any other criminal case.

Duties of a Doctor in case of an Alleged Victim of Rape¹²

- i. Any female of any age (including any child) who claims to be a victim of rape/sexual abuse should always be treated as a possible rape victim. The sexual abuse victim must be treated as a priority case by all staff and doctors (although life-threatening cases may be given priority over a rape victim who is not in immediate danger).
- ii. Victims should be seen within all health facilities, such as clinics, nursing homes and hospitals.
- iii. Under Sec. 164-A CrPC, the examination should be conducted without delay by a registered medical practitioner (RMP) employed in a Govt. hospital

or any other RMP with the consent of the victim or person competent to give consent on her behalf, and she should be sent to the RMP within 24 h from the time of receiving the information relating to the commission of such offence.

- iv. Parents/guardians can request medical treatment on behalf of a rape/sexual abuse victim, if the victim is:

- Under 18 years
- Mentally retarded
- Under the influence of alcohol
- Unconscious

- v. Victims of rape should at all times be treated with dignity and respect by the medical staff. The examiner must be reassuring, empathetic and nonjudgmental and should not rush the patient.
- vi. Privacy should be ensured like by allowing her to be brought into the examining room through a separate entrance.
- vii. The doctor should prepare a detailed report mentioning the reasons for each conclusion arrived at and description of material taken from the person of the woman for DNA profiling.
- viii. Senior medical staff, if possible, should examine the suspected rape case. This is especially necessary to ensure that the doctor is seen as a reliable expert witness.
- ix. Even if the rape/sexual abuse occurred outside the jurisdiction of the hospital, the victim must first be examined and treated before referring her to the hospital in the appropriate area.
- x. Forensic evidence should be collected as soon as possible during the process of examination. However, the serious injuries of the victim must be treated and are more important than forensic needs.

Examination of the Rape Victim

The police should advise the victim not to change clothes or have a bath—to prevent the loss of physical evidence and to ensure that medical attention is not delayed.

Objectives of Medical Examination

- i. To search for physical signs that will corroborate the history given by the victim.
- ii. To search for, collect and preserve all trace evidence for laboratory examination.

- iii. To treat the victim for injuries, to prevent/treat venereal disease (STDs) or pregnancy and to prevent or alleviate psychological damage.

Procedure

A visit to the scene of alleged offence may be desirable.

- i. A requisition for examination of the victim should come from an authorized person, either a Magistrate or in-charge of a police station. If the victim has approached the doctor herself to have a medical examination, the doctor should conduct her medico-legal examination without any delay. Information is sent to the police for recording her statement and lodging of complaint.
- ii. Written witnessed consent should be obtained before the examination, collection of specimens, release of information to authorities and taking of photographs. It must be 'informed consent', as she must be told that any evidence obtained may be used in court and that she will then be exposed to publicity and cross-examination. The court or the police have no power to compel a woman for medico-legal examination against her will.
- iii. The victim should be identified by the escorting police constable, whose name and number should be recorded and by the relatives or the attendants accompanying her. Police officers, regardless of their sex, should never be in the examining room.
- iv. If possible, the victim is examined by or under the supervision of a female doctor. If a board of doctors is examining the victim, at least one doctor must be a female. Otherwise, a female nurse/attendant should be there, if the victim is examined by a male doctor. However, as per directions of Punjab and Haryana High Court, it is mandatory for the victim to be examined by a female doctor only.
- v. The examination should be carried out without delay. Minor degrees of injury may fade rapidly and swelling and tenderness of vulva may disappear in few hours. Chances of detection of spermatozoa from the genital tract diminish with delay.
- vi. Statement of the victim and others accompanying her are recorded separately.

Preliminary Data

Following details should be noted:

- i. Name of the victim, age, height, marital status, residence, occupation and social status.
- ii. Date, time and place of examination. Date and time is important, because the interval between the alleged incident and the examination is important.

- iii. Two identification marks.
- iv. Ability to consent (drunk or mentally retarded); whether any drug or alcohol was taken within the previous 120 h (it may help establish lack of consent).
- v. Circumstances of attack including date, time and place of alleged offence, description of the perpetrator(s) [name (if known) and number of persons], use of threats or restraints, type of sexual contact (vaginal, oral, rectal), exact relative positions of the partners, details of struggle or resistance, calls for help, sensation as to penetration and emission (whether emission was within the vagina or outside), any condom used during the act and any bleeding or pain during or after the incident.
- vi. Details of the events after the alleged assault, such as douching or bathing, use of a tampon or sanitary napkin, urination or defecation, eating or drinking and use of toothpaste, mouthwash, enemas or drugs.
- vii. Whether consciousness was lost at any time during the attack.
- viii. The time of the complaint and if there was any undue delay, the reason for such a delay.
- ix. Date and time of the last consensual intercourse (because sperm from this encounter may still be present in the vaginal canal and cervix and confuse the issue).
- x. History of menarche, last menstrual period, gravidity, parity and the method of contraception, venereal disease, discharge and operation, if any, should be documented.

Examination

Physical Examination

Before beginning, the examiner should ask for the patient's permission. When feasible, photographs of injuries are taken.

- **General:** Stature and weight (for children, and if age appropriate for adult), nutritional status and gait. Whether the victim is anxious, fearful, tearful, happy or withdrawn is noted.
- **Clothes:** It should be ascertained whether the clothes are those which were worn at the time of the attack or changed. The patient, in the presence of the doctor, should remove each item of clothing herself. She should be standing on a clean sheet of paper and anything that falls, e.g. earth, buttons, hair and fibres should be preserved.

- Clothing should be examined for stains (blood, seminal, sand or grass), soiling, tears and loss of buttons, and the site and type of damage.
- If the offence has been committed outside, corroboration can sometimes be obtained by finding grass, leaves or mud on the buttock or on the back.
- It should be air dried at room temperature and stored in a clean paper bag and sent to the laboratory. Clothes are very important in corroborating or contradicting her story.
- **Breasts:** Sexual maturation (described by Tanner stage 1-5 or as 'pre-pubertal,' 'pubertal,' 'mature') is noted.
- **Examination with Wood's lamp** (filtered UV light): Examination using a Wood's lamp may detect semen or foreign debris on the skin. Dried seminal stains on the skin appear as pale yellow glistening areas and will fluoresce under a Wood's lamp.

Rape may result in the following:

- Extragenital injury
- Genital injury
- Psychologic symptoms
- Sexually transmitted diseases (STDs)
- Pregnancy

Extragenital injury

Frequent sites for extragenital trauma include breasts, extremities, neck, buttocks and oropharynx. They represent residual features to the use of force and restraint. Ligation marks and traction alopecia are additional signs of use of restraint and force.

The victim's entire body must be thoroughly examined for areas of tenderness, soft-tissue swelling, abrasions, contusions, bite marks, lacerations, fractures and other evidence of violence—their appearance, extent, situation and approximate age (whether they correspond to the alleged time of infliction) should be noted (Fig. 25.1).

- The back of the head may be banged against the ground resulting in soft tissue swelling and lacerations.
- Facial injuries including fracture of mandible and nose, and broken or loose teeth are often present.
- If the assailant pulls and twists the victim's clothing, petechial hemorrhages or a line of punctuate bruising may occur on the skin, commonly in the area of the bra-strap or near the axilla.

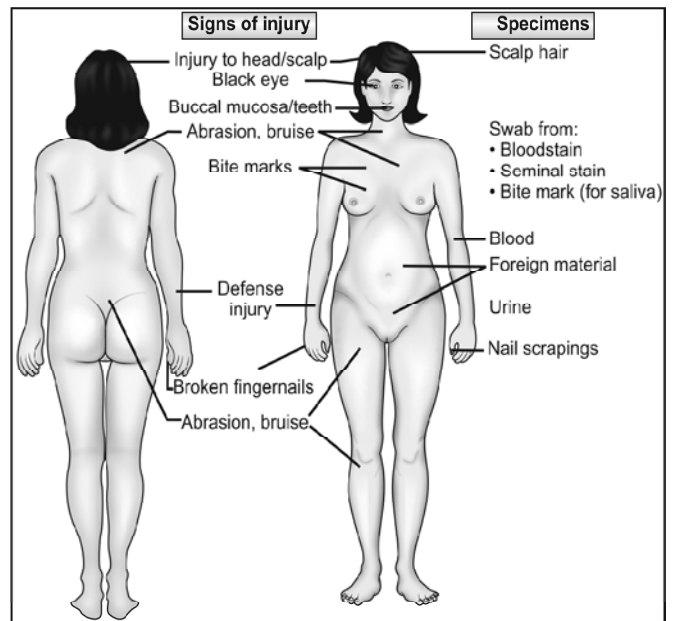

Fig. 25.1: General physical examination and specimens to be preserved in a victim of rape

- Marks of violence, especially contusions and abrasions, particularly fingernail abrasions may be found (Fig. 25.1):
 - i. Around the mouth and throat, inflicted while preventing her from calling for help. Contusion of the lips and even tearing of the inner aspect may be found due to blows or rough handling.
 - ii. About the wrists and arms where the man gripped her in restraint.
 - iii. Around the medial aspects of thighs and knees caused by forcing her thighs wide apart.
 - iv. On the back from pressure on gravel or hard ground on being held down on rough surface.
 - v. On breasts because of manual squeezing and manipulation.
 - vi. True bite marks and love bites (*suction petechiae* result from rupture of small vessels due to reduced pressure) may be found on the breasts, neck, chest wall and also on the lower abdomen and upper part of the thighs. The nipples may be bitten off.

The extent and nature of the general injuries should correspond to the victim's description of the assault. If the throat has been gripped or if a severe blow is struck on the head, the victim's capacity for resistance becomes greatly impaired. Injuries found on the body must be described specially with reference to the possibility of self-infliction or corroboration of victim's tale.

Local Examination

- **Genitals:** The patient is laid in the lithotomy position on the examination table, in good light with the parts fully exposed (Fig. 25.2). The examination of genitalia is done using a speculum, or a glass globe (Glaister-keen globe), sometimes transilluminated to stretch the hymen around for inspection of the edges.¹³
- **Stains:** The presence or absence of bloodstains about the legs or vagina should be looked for and preserved.
- **Pubic hair:** The pubic hair should be examined for matting from seminal fluid or blood and for foreign hair. If the hair are matted together, a portion must be cut off and kept for examination. The pubic hair should also be combed out to collect loose foreign pubic hair and a comparison sample (15-20 hair) of cut/plucked hair is preserved.

Genital Injury

- Acute findings of injury, whether in the genital or anal area include abrasions, bruising, edema and lacerations [acronym is TEARS: tears (T), ecchymosis (E), abrasions (A), redness (R) and swelling(S)].
- In case of sexual assault, the victim’s vagina is not lubricated, physical constraints may place the pelvis in an awkward position and insertion of penis into the vagina is usually by excessive force which results in injuries to the vulva, hymen, vagina and the perineum (Fig. 25.3).
- i. **Vulva:** Women with unclean habits often have superficial areas of erythema, irritation and

occasionally abrasions on their genital region, therefore any superficial injuries found in this area must be carefully assessed.

- ii. **Labia:** Injury to labia is not common, but fingernail scratches may be present on the labia, particularly the labia minora. Swelling and tenderness of the labia minora may be indicative of sexual activity. Swelling and engorgement of the vulva at the introitus, clitoris and labia minora are caused by penile stimulation, but they may be caused by digital stimulation or masturbation. These signs normally fade in 1-2 h.

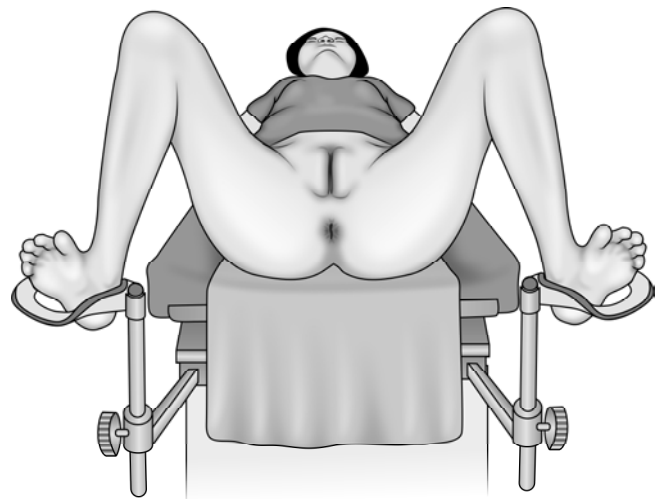

Fig. 25.2: Lithotomy position for genital examination

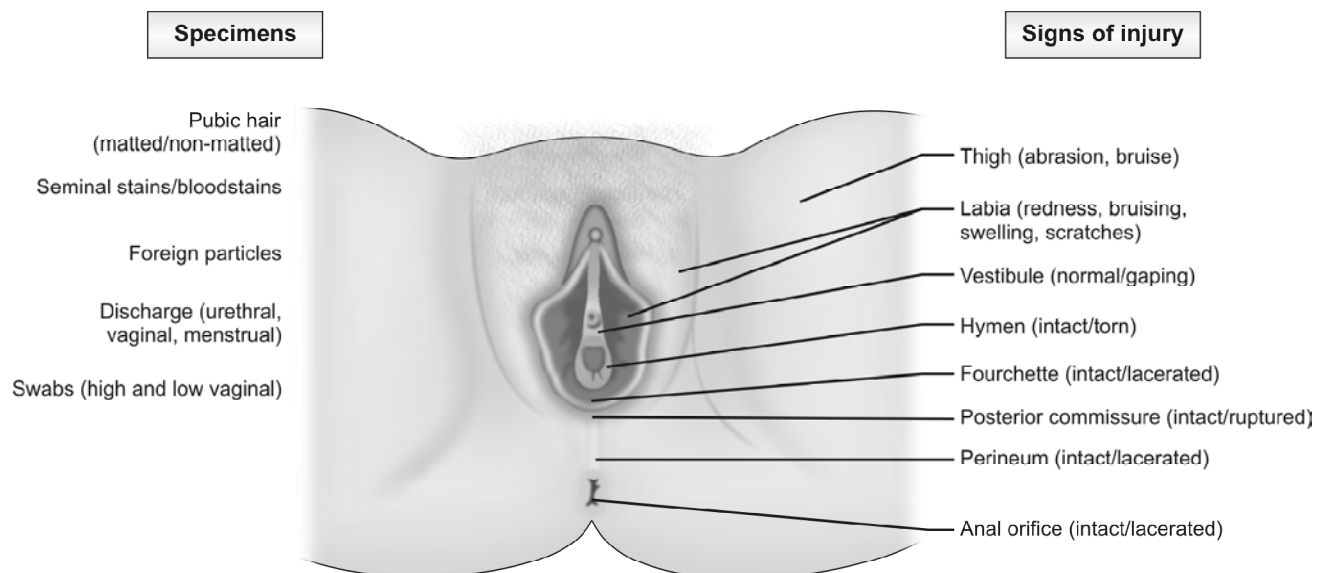

Fig. 25.3: Local examination and specimens to be preserved in a victim of rape (For color version see Plate 5)

- iii. **Hymen:** *Laceration of hymen occurs with the first intercourse and in a virgin, this is the principal evidence of the same.* Tearing of hymen usually occurs postero-laterally or in the middle (5 to 7 o'clock position)¹⁴ (Fig. 25.4).
- The semilunar hymen often ruptures on both sides. The annular hymen which nearly closes the vaginal orifice may suffer several tears.
 - Soon after the act, the torn margins are sharp, red and bleed on touch. Even when examined after 3-4 days of offence, the edges are swollen, congested and smaller.
 - *Signs of recent rupture of hymen* are ragged tears in the hymen with lack of epithelial healing, edema and hemorrhage.

Hymen may not rupture after rape if:

- Penetration was not full
- Hymen is tough, fleshy and elastic
- In young child full penetration may not occur
- In deflorated woman

- iv. **Posterior commissure:** The posterior commissure may be ruptured, especially if there is disparity in size between the male and the female organs.
- v. **Fourchette:** The fourchette is fragile and often tears during first intercourse.
- vi. **Fossa navicularis:** Fossa navicularis is obliterated.
- vii. **Vagina**
- Vaginal examination will enable the examiner to assess elasticity of the hymen and to determine the degree of penetration which would be possible without its rupture.
 - In virgins, inserting the tip of index finger into the vagina with intact hymen is painful and is felt as constricting ring around the tip of the finger.

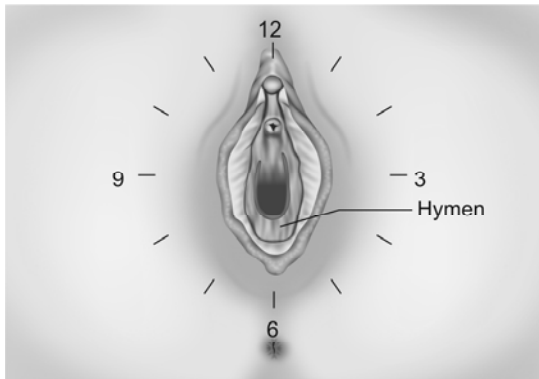

Fig. 25.4: Face of clock orientation with patient in lithotomy position

- If the vaginal opening is enough to admit two fingers easily, the possibility of sexual intercourse having taken place without rupture of hymen may be inferred.

After per vaginum examination, a Pederson speculum is inserted into the vaginal canal. The cervix, vaginal walls and vault is inspected and any secretions or injury is noted.

- Contusions of the vagina are seen as dark red areas against the overall redness of the vaginal mucosa, and within 24 h the color becomes deep red or purple. They are more frequently seen on the anterior vaginal wall in lower third and posterior vaginal wall in upper third.
 - In rape or digital penetration without consent, initial lubrication is lacking due to which more severe local bruising or abrasion can result.
 - With violent intercourse or where there has been considerable disproportion between the penis and the vagina, laceration of the vaginal wall occurs posteriorly. The gait is broad based and painful.
- viii. **Cervix:** Abrasion of the cervix occurs almost invariably due to vaginal penetration and usually due to digital rather than penile penetration. The abrasion is found away from the external os and the margins are not clearly defined.

Colposcopic examination

Colposcopy is particularly sensitive for subtle genital injuries. Some colposcopes have cameras attached, making it possible to detect and photograph injuries simultaneously. Using of toluidine blue may highlight the areas of injury. Using colposcopy, it has been found that the injury to the posterior fourchette is the most commonly seen in women after rape.

Hymeneal examination

- The hymen is examined by application of gentle traction outwards and downwards at posterior edge of labia majora. The patient is asked to 'push against' the fingers which will open up the hymeneal orifice if not visible on traction. A cotton swab inserted through the hymeneal orifice may also be used to look at the hymeneal rim. It can then be used as a specimen for laboratory examination.
- *Glaister-keen globes* are glass rods (diameter of 0.6 mm with one end of the rod being expanded into globe from 1-2.5 cm in diameter) which can be inserted gently behind the hymen to display its edges over the glass. In this way, apparent folds and indentations smooth out and small nicks and tears can be easily identified.
- Hymeneal swelling is often difficult to document at the time of initial examination
- A statement about the state of the hymen should be made: words such as *intact or nonviolated, remnants, parous and old scarring* are preferable; *marital* should be avoided.

Corroborative Signs of Rape

Based on Locard's principle of exchange principle 'every contact leaves traces'; evidence is collected during and soon after the examination is completed.¹⁵

Evidence from Seminal Fluid

The thighs, pubic hair and vagina of the victim should be examined. The presence of spermatozoa in the vagina is proof of connection, but not of rape; *their absence is no proof that connection has not taken place.*

Sometimes, the history and examination suggests sexual intercourse, but evidence is often absent or inconclusive. There may be number of explanations besides the obvious suggestion of a false complaint (Table 25.2). Evidence becomes weaker or disappears as time passes, particularly after > 36 h; mechanical elimination (drainage, hygiene), biological degradation and physiologic dilution may yield negative results.

Swabbing of mouth, vagina and anus for sperm detection should always be performed on rape victims. The presence of smegma bacilli is suggestive of coitus. Its absence is without any significance.

Evidence from Vaginal Discharge

Vaginal discharge may arise from local infection, worms or uncleanliness. If the assailant is suffering from venereal disease such as hepatitis, syphilis, gonorrhoea, chlamydial infection, trichomoniasis or HIV infection, he may transmit it to his victim which is a strong corroborative evidence of intercourse.

- In gonorrhoea, an inflammation with abundant micropurulent discharge will be seen in 2-4 days (occasionally a week), while in syphilis, an indurated ulcer on the external genitals may appear in about 3 weeks.
- An initial negative smear may be of value, if a positive smear is obtained within a few days of the assault.
- A blood sample should be taken for serological examination for syphilis. An initial negative reaction

may be of value, if a positive reaction is obtained after 6 weeks.

- Sometimes, the sores on the genitals may be due to chancroid. Smears from sores or bubo fluid, when stained show the Ducey's bacillus.

Evidence of Struggle

Signs of active resistance may be present. The fingernails may be broken due to scratching the accused. Under the nails, debris may be present, e.g. blood, fibres, hair and skin fragment from the accused. Other signs of defense may also be present.

Time of Assault

- Wounds:** Age of abrasions and contusions should corroborate with the alleged time of assault.
- Seminal fluid:** Survival time of spermatozoa in vagina of living individual is quite variable.
 - Normally, sperms remain motile in the vagina for about 6-8 h and occasionally upto 12 h and very rarely upto 24 h. In the later case, it is probable that the specimen was obtained from cervical mucus.
 - Non-motile forms are detectable for about 24 h with occasional reports of 48-72 h.
 - If motile sperms were seen in wet smears on a slide, it would mean that intercourse has taken place within about 12 h.¹⁶ If the sperms are not motile, it is not possible to say exactly when intercourse took place, except that it may be over 12 h and within about 24-48 h and occasionally upto 72 h.
- Venereal disease:** Development of venereal disease may be helpful in estimating the time of assault.

Swabs from Vagina

- A Papanicolaou smear is prepared as it provides a permanent record of sperm.
- Two millilitre of normal saline is injected into the posterior fornix of vagina, retrieved and labeled 'vaginal aspirate' and examined for motile sperms.

Table 25.2: Factors resulting in failure to detect semen from the victim

No seminal constituents recovered	No spermatozoa recovered
<ul style="list-style-type: none"> • Sexual dysfunction in the assailant • Time delay between assault and examination (drainage and degradation) • Victim's hygiene (douching, bathing, gargling) • Condom use • Physiologic activity (urination, defecation, menstruation) • Poor technique of the examining doctor 	<ul style="list-style-type: none"> • Impaired spermatogenesis (azoospermia) • Impaired delivery (vasectomy, trauma, congenital anomalies) • Depleted stores (due to frequent ejaculation) • Very old age

- Two cotton-tip swabs soaked with material from the vaginal pools are air dried and placed preferably in card-board boxes (not test tubes).
- Oral and rectal smears and swabs should be obtained and retained in all autopsy cases.

The presence of spermatozoa in the vaginal secretion is a positive sign of sexual intercourse. In most rape cases, numerous sperm will be seen in each smear.

- **Motile sperms:** The technique requires the preparation of a 'wet mount' slide (vaginal or cervical swab sample placed with a drop of saline plus cover slip) and examined with a phase-contrast microscope.
- Swabs should be taken from the vaginal pool and not the cervix because sperm can survive in cervical mucus much longer than in the vagina. It is important when searching for motile sperms in an individual of alleged raped only few hours before to obtain the specimen from the vaginal pool and not from the cervix, since sperm seen on a cervical swab may not be caused by the rape, but by sexual intercourse 2-3 days before (if history of consensual intercourse is present).
- Sperms have been identified in the vagina of dead individuals 1-2 weeks after death. In dead, the sperm are destroyed by decomposition and not by drainage or by the action of vaginal secretions. Sperms that are deposited on materials like cotton, cloth or paper and air dried can be identified years after the event.
- When no sperm are observed, part of each of the swabs from the vagina, rectum and mouth can be used for presumptive tests for acid phosphatase. If however, sexual intercourse is still strongly suspected or if acid phosphatase test was weakly positive, an assay for prostate specific antigen (p30) should be performed. Occasionally, p30 is positive in the face of a negative acid phosphatase.
- **Acid phosphatase:** It is usually present in the vagina for upto 18-24 h after sexual intercourse and occasionally upto 72 h. The highest levels are within the first 12 h with gradual disappearance by 48-72 h. Because it usually disappears in the first 24 h after intercourse, it is most useful as an indicator of recent intercourse, compared with non-motile sperm which can be identified upto 2-3 days after intercourse.

Rape on Deflorate/Sexually Active Woman

In deflorate women, even without childbirth, the hymen is completely destroyed, the vaginal orifice dilated and the mucous membrane wrinkled and thickened with complete loss of rugosity. Complete penetration can occur in such women and leaves no evidence, except semen. *The only proof that the penetration has occurred is presence of spermatozoa in the vagina.* The absence of injury

under certain circumstances, therefore, does not exclude even complete penetration. However, mark of genital injury should be looked for, as rape is generally associated with greater violence than consensual sexual intercourse.

The majority of adult rapes are associated with a sudden forcible dilation of vagina resulting in some degree of local or general injury. Bruising, abrasion or lacerations are at all times consistent with forcible intercourse with a consenting woman and do not necessarily indicate rape. A second examination of the victim would be made, for bruising may take a little time to come to the surface, especially in the lower vagina.

The vagina may show laceration or bruising with effusion of blood, and swelling and inflammation of the vulva, even when no marks of violence indicating a struggle may be found externally. Tearing or perforation of the vagina may occur when it is thin or friable. In case of older women, senile atrophy and friability of their genitalia results in extensive vaginal lacerations and perineal trauma. In women who have been used to sexual intercourse, injuries from rape normally disappear or become obscure in 3-4 days. When there has been much violence, the signs may persist longer. The presence of violence in other parts of the body is the chief evidence of the crime.

All injuries of the labia and vagina found in cases of sexual assault are not due to rough manual and penile contact. Tears in the deeper part of vagina and gross lacerating wounds of the vault are not likely to occur during sexual intercourse, but are often caused by sexual perverts using instruments. The acts may be separate incidents or they may follow coitus.

Rape on Children

A small child must never be held down during examination of the genital area, this is equivalent to sexually assaulting the child and will intensify the trauma. When indicated, the child should be taken to the operating room and anesthetized so that proper assessment and treatment can be done.

- In a young child, there are few or no signs of general violence, for the child usually has no idea of what is happening and also incapable of resisting.
- As the hymen is deeply situated and the vagina is less capacious, it is impossible for penetration of the penis to take place. Usually the penis is placed either within the vulva or between the thighs. As such, the

hymen is usually intact and there may be little redness and tenderness of the vulva.

- During forceful penetration, the penis can compress the labia both anteriorly and laterally, producing bruising of both the labia majora and minora. Further penetration forces the penis backwards (symphysis pubis prevents its anterior movement) and the hymen is torn posteriorly. If the penis advances into the vagina, the hymenal tear extends into or through the perineal body and often involves the anterior wall of the ano-rectal canal.
- The younger the child, the more widespread are the injuries. Full penile penetration produces bruising of the vaginal walls and frequently tears of the anterior and posterior vaginal walls. Anterior tears can involve the bladder and posteriorly the ano-rectal canal. Vaginal vault may rupture and there may be vaginal herniation of abdominal viscera.
- In digital penetration of the infant vagina, there is frequently some scratching or bruising of the labia and vestibule, but circumferential tears are absent. The hymen shows a linear tear in the posterior or posterior-lateral quadrant which may extend into the posterior vagina and on to the skin of the perineum. Ano-rectal canal is rarely torn.

Any attempt to separate the thighs for examination causes great pain because of the local inflammation. The child walks with difficulty due to pain. The absence of marks of violence on the genitals of the child when an early examination is made, is strong evidence that sexual intercourse has not taken place.

Specimens Preserved for Laboratory Examination (Figs 25.1 and 25.2)

- i. Clothing: stained, torn, foreign material.
- ii. Scraping of dried bloodstains: grouping, DNA characteristics.
- iii. Scraping of dried seminal stains: grouping, sperms, acid phosphatase, semen specific glycoprotein (P₃₀), DNA profiling.
- iv. Hair: matted pubic hair, foreign hair, plucked/cut hair from pubis and scalp.
- v. Broken nails and scraping from under the nails.
- vi. Bite mark examination: Bite marks can be as individual as fingerprints.
- vii. Blood: grouping, alcohol, drugs, VDRL, HIV, DNA profiling.
- viii. Saliva: secretor status.
- ix. Swabs from any soiled area of skin, bite marks and swabs from mouth, pharynx, vagina and anus for spermatozoa, microorganisms, P₃₀ glycoprotein and sexually transmitted diseases.

Vaginal swabs are invariably taken in all cases. Other specimens, e.g. body hair and urine (for drug, pregnancy) are collected at the discretion of the examiner. The examination should be tailored to the requirements of the particular case and collection of all samples may not be necessary.

A chain of custody must be maintained. Thus, specimens are placed in individual packages, labeled, dated, sealed and held until handed over to police personnel after receiving a receipt.

After the evaluation, the patient is provided with facilities to wash, change clothing, use mouthwash and urinate or defecate, if needed.

Rape kit: It is a set of items used by medical personnel for gathering and preserving physical evidence following an allegation of sexual assault. It is also called sexual assault evidence collection kit, sexual assault forensic evidence (SAFE) kit or physical evidence recovery kit (PERK) kit. The kit was developed by *Louis Vitullo* and was referred to as the *Vitullo kit*. Although a rape kit's contents may vary, typically it includes:

- Detailed instructions and authorization for collection and release of evidence form
- One 30" × 20" white paper sheet, two bags for outer clothings and one for panty
- Debris collection for nail scraping and envelopes
- Towel and comb for pubic hair combing
- Envelope for pulled head hairs
- Glass slides, swabs and boxes for vaginal, rectal and oral swabs and smear
- Paper disk and envelope for saliva sample
- Two blood vials for known blood sample collection
- Anatomical drawings chart and labels

Opinion

The opinion of whether sexual intercourse has taken place or not is based on a consideration of:

- i. Examination of the scene
- ii. Signs of struggle
- iii. Presence of blood and/or seminal stains on clothes and body
- iv. Presence of seminal matter in the vagina
- v. Transmission of venereal disease
- vi. Laboratory reports

The report should contain negative as well as positive findings. The doctor should never make a diagnosis of rape. He may give opinion that there are signs of recent vaginal penetration, general physical injury and/or intoxication and that the signs are consistent with the history given. In short, the opinion should be regarding sexual intercourse and not regarding rape which will be decided in the court. *Rape is an allegation, easy to be made, hard to be proved and harder to disprove.*

Follow-up: It involves:

- i. Treatment of injuries.
- ii. Tetanus prophylaxis.
- iii. Prevention and termination of pregnancy.
- iv. Prevention and treatment of any venereal disease.
- v. Psychiatric consultation to regain dignity and self-respect and prevention of development of Post Traumatic Stress Disorder (PTSD).

Medico-legal Questions

Q. Whether resistance was offered by the victim?

- In ordinary conditions, it is not possible for a male to have sexual intercourse with a healthy adult female in full possession of her senses and against her will.
- The victim may not be able to offer marked resistance from terror or from an overwhelming feeling of helplessness or when her movements may have been obstructed by her clothing.
- The social status, physical development and type of woman should also be considered—a woman used to look after herself is less likely to be terrified than a woman who has led a sheltered life.
- When a woman is overpowered by two or more men, she cannot resist much and marks of violence may not be marked.

Q. Whether any drug/narcotic was given before the act?

- Rape may be committed without the knowledge of the woman while she is under the influence of drugs, such as opium, cocaine, hyoscine, alcohol, anesthetic or in a coma and in a hypnotic trance.
- When a woman takes alcohol voluntarily in order to encourage caressing or increase sexual feeling and becomes a victim of sexual intercourse, the question of consent depends on the extent to which she had become affected. If she is conscious, she can refuse consent. In such cases, complete history should be taken, and blood and urine should be preserved for examination.
- The use of anesthetic agent for surgical or dental operations may result in a charge of rape, especially in neurotic women, who in their anesthetic flights of imagination believe themselves to have been sexually assaulted.
- It is as difficult to put a woman under the influence of chloroform, ether or halothane by force so as to rape her. There is no drug which can produce immediate unconsciousness when placed in front of the nostrils.

Psychologic symptoms: They are potentially more significant with patients experiencing fear, nightmares, sleep problems, anger, embarrassment, shame, guilt or a combination.

Rape Trauma Syndrome

It is a psychological trauma and is regarded as post traumatic stress disorder (PTSD). PTSD is an anxiety disorder marked by biological changes as well as psychological symptoms.

It is characterized by two phases:¹⁷

- i. *Phase of disorganization* where there is headache, GIT complaints, immune system problems, dizziness, chest pain, discomfort, emotional imbalance, depression and feeling of guilt.

It is followed by:

- ii. *Phase of reorganization* in which there is gradual adjustment with occasional phobia and fear state (nightmares), avoidance of thoughts, feelings and situations related to the assault and increased arousal (e.g. difficulty in sleeping and concentrating, jumpiness, irritability).

Symptoms last for > 1 month and significantly impair social and occupational functioning.

Treatment: PTSD is treated by psychotherapy and drug therapy (selective serotonin reuptake inhibitors). At present, cognitive-behavioral therapy appears to be somewhat more effective than drug therapy.

False Allegations

The possibility of accusation and false allegation must be suspected when:

- i. Statement of the victim which is neither convincing nor consistent with relation to the description of assailant, time of assault, scene, consent, clothing and circumstances.
- ii. Injuries—the dating of which does not correspond to the time of the alleged incident.
- iii. Doubtful story about administration of drugs.
- iv. Injuries are not serious and are made either by fingernails, instruments or irritants.
- v. Injuries do not involve sensitive areas, such as face, genitals, nipples and lips.
- vi. Confirmatory laboratory findings are absent.

Intra-marital Rape

Legally, it is assumed that consent for sexual intercourse is implicit in the contract of marriage. So, it has been assumed that husband cannot rape his wife. But now, the concept of marital rape is being considered in modern law.

The common law must take prevailing social attitudes into account. Marriage is regarded as a partnership of equals and females are no longer considered as a weaker sex and subordinate to the husband. Husband has got no extra privilege or an absolute right to enjoy his wife's body even against her will and less so, by the use of force causing pain or injury.

Husband may be charged with cruelty and assault on wife. On the other hand, if the wife continuously and unreasonably refuses sexual intercourse, he may plead for divorce.

Findings: Anal and rectal injuries are known as markers for marital rape. In married couples, the most frequent type of forced sex is vaginal intercourse followed by forced anal intercourse. Rectal penetration can also be associated with an increased risk of genitorectal injury.

Examination of Rape Accused

It is better to examine the accused after the victim and to look specifically for any injuries which she says, she has inflicted. The procedure of examination of the accused is similar to the victim.

Preliminary Data

- i. Name, age, occupation, address, brought by whom, identification marks, date, place and time of examination should be noted.
- ii. Development of genital organs and physical built of the accused is noted.
- iii. Consent should be asked for. But if refused, then he can be examined and necessary evidence, e.g. blood, swabs, etc. can be collected with application of reasonable force [Sec. 53-A CrPC].
- iv. Presence of attendant is not necessary.
- v. History of his version of the case is recorded.
- vi. Mental state and behavior should be noted.

Clothes should be examined for tears, loss of buttons, foreign matter, stains—blood, seminal, mud and cosmetic stains.

Marks of injury (bruises, scratches or bite marks) on the body should be noted. A thorough examination should be done of fingers and nails, as well as knees and elbows for any abrasions. Age of the injuries should be determined.

Local Examination

Genitals¹⁰

1. **Pubic hair:** Any foreign hair, matted hair and female pubic hair to be preserved. His pubic hair is also preserved.

2. **Development of genital organs** with special reference to the potency. Any injury to the genital organs is to be noted. Forceful penetration against the resistance into a hymen may produce tears or bruising of the frenulum of the prepuce in uncircumcised penis and abrasion of the glans in both the uncircumcised and circumcised penis.
3. The penis should be examined for:
 - i. **Smegma** (thick cheesy secretion along with desquamated epithelial cells and smegma bacilli), if present under the prepuce and corona glandis is inconsistent with recent sexual intercourse. The smegma is rubbed off during intercourse which takes about 24 h for re-deposition.
 - ii. **Lugol's iodine test:** It is now redundant. Iodine solution painted on the glans would reveal the presence vaginal epithelial cells by turning brown due to the glycogen present in them.¹⁸
 - iii. Suspect penis is washed with saline and the material is stained with Papanicolaou's stain. Vaginal and cervical cells and Barr body identification suggest recent intercourse, unless the assailant has used a condom.
 - iv. Presence of venereal discharge or syphilitic chancre.

Specimens to be preserved

- Clothing: stained, torn, missing buttons, foreign matter.
- Scrapings of blood and seminal stains: grouping, DNA characteristics.
- Hair: matted pubic hair, foreign hair and control hair sample from the scalp (minimum of 20 hair).
- Saliva: secretor status
- Debris under the nail.
- Blood: grouping, alcohol, drugs, VDRL, ELISA for HIV.

If samples from both the victim and the suspect are packed on the same table or surface, contamination of the samples can occur. Therefore, care must be taken to ensure that accidental contamination of samples does not occur.

Examination of rape accused (Sec. 53-A CrPC)

If a person is arrested on a charge of committing rape and an examination may afford evidence, then a RMP working in a Govt. hospital or local authority or any other RMP (in the absence of such a doctor) within the radius of 16 kms from the place where the offence has been committed, at the request of a police officer (not below S.I.) may examine the person using reasonable force as necessary. The doctor should prepare a report without delay, giving reasons for each conclusion arrived at and document the specimens taken from the accused for DNA profiling. The report is handed over to the I.O. who then forwards it to the Magistrate.

Incest

Definition: Sexual intercourse by a man with a woman who is closely related to him by blood or by marriage (prohibited degrees of relationship), e.g. a daughter, grand-daughter, sister, stepsister or aunt.¹⁹

Examples are:

- Between father and daughter (e.g. the Electra complex).
- Between mother and son (e.g. Oedipus complex).
- Between brother and sister (e.g. Pharaonic incest).

Circumstances of incest can be both social and environmental:

- i. Family strife and disorganization
- ii. In low socioeconomic groups
- iii. Overcrowding
- iv. Lack of parental supervision
- v. Low morality and delinquency
- vi. Where alcohol removes natural inhibitions
- vii. In case of cerebral diseases—general paralysis or senile degeneration
- viii. Where brother and sister have been separated in childhood and meet later as strangers.

Medico-legal Aspects

- It may lead to progression of genetic defects arising from mating of close relations.
- In India and many Asian countries, incest is not a criminal offence (unless it amounts to rape/adultery, i.e. if it comes under Sec. 376 and 497 IPC) because of social acceptability of intra-caste marriage.^{20,21}

- It is punishable by legislation and constitutes a valid ground for divorce and is prohibited by religious laws in many developed countries. In UK, the law forbids marriage between a man and his close relatives. In Romania, all forms of incest are punishable by upto 7 years of imprisonment.
- Three European Union nations—France, Spain and Portugal—do not prosecute consenting adults for incest.

Adultery

Definition: Voluntary natural sexual intercourse between a married man and someone other than his wife or between a married woman and someone other than her husband i.e. having sexual intercourse with someone who is not his/her legally wedded spouse. Sec. 497 IPC (imprisonment upto 5 years with/without fine) and Sec. 498 IPC (imprisonment upto 2 years with/without fine) deals with adultery.²¹

The differences between rape and adultery are summarized in Diff. 25.1.

Legal Aspects

- If proven, adultery is a valid ground for divorce and nullity of marriage.
- In Indian law, only an aggrieved husband can charge another man with adultery and the adulterous wife is not considered as an abettor of the offence, i.e. like rape, women cannot be charged with the offence of adultery.
- Many Muslim nations practicing Sharia Islamic law, retain the death penalty for adultery.

Differentiation 25.1: Rape and adultery

S.No.	Feature	Rape	Adultery
1.	Basic difference	Offence against body	Offence against marriage
2.	Consent	Offence is committed without the consent of woman	Offence is committed with the consent of woman but lacks the consent of her husband
3.	Aggrieved party	The woman	Husband of the woman
4.	Offence by husband	Woman can be raped by her husband if she is < 15 years	Husband cannot commit this offence against his wife
5.	Marital status	Committed against married or unmarried woman	Committed with married woman only
6.	Punishment	7 years to life imprisonment and fine	Upto 5 years and fine

MULTIPLE CHOICE QUESTIONS

1. Rape is defined under: *TN 09; FMGE 10*
 A. Sec. 320 IPC B. Sec. 375 IPC
 C. Sec. 376 IPC D. Sec. 351 IPC
2. It is considered rape even after consent if: *PGI 10*
 A. Age < 16 years B. Age < 17 years
 C. Age < 21 years D. Age < 25 years
3. A 24-year-old man gets married with 14-year-old female. Having sex with her will be considered rape because: *JIPMER 08*
 A. No consent taken from wife
 B. Wife age < 18 years
 C. Wife age < 15 years
 D. Wife age < 17 year
4. All are true about gang rape, except: *Bihar 11*
 A. Sexual intercourse by one person
 B. Sexual intercourse by two persons
 C. Sexual intercourse by three persons
 D. Sexual intercourse by many persons
5. Statutory rape is: *TN 10*
 A. Rape of an insane woman
 B. Rape of another person's wife
 C. Rape in police custody
 D. Rape of < 16 years old girl
6. Punishment for rape is given under which section of IPC: *TN 09; FMGE 10; AI 10; Kerala 11*
 A. Sec. 320 B. Sec. 375
 C. Sec. 376 D. Sec. 351
7. Punishment for rape: *Maharashtra 09*
 A. 3 years imprisonment + fine
 B. 5 years imprisonment + fine
 C. 7 years imprisonment + fine
 D. Death sentence + fine
8. Punishment for sexual intercourse not amounting to rape by attendant in a hospital is under: *Punjab 10*
 A. Sec. 376 A IPC B. Sec. 376 B IPC
 C. Sec. 376 C IPC D. Sec. 376 D IPC
9. For sexual intercourse with a prostitute: *Bihar 03*
 A. Consent is required
 B. Consent is not required
 C. Consent may or may not be taken
 D. None
10. A 16-year boy is accused of raping of a 12-year-old girl. The following can prove the boy is innocent, except: *PGI 05*
 A. No abrasion in body and genitalia
 B. Absence of blood and semen in cloths and genitalia
 C. Age of the boy is 16 years
 D. Presence of smegma in corona glandis
11. Disclosure of name of rape victim punishable under: *AI 12*
 A. Sec. 304 A IPC B. Sec. 354 IPC
 C. Sec. 376 IPC D. Sec. 228A IPC
12. An 11-year-old rape victim is brought to casualty for medical examination. The medical officer is required to do the following things, except: *AIIMS 04*
 A. The consent is to be taken from the patient
 B. The patient should be examined in presence of a female attendant
 C. The patient should be given necessary emergency treatment
 D. All the necessary forensic samples should be collected
13. Following is used to document tear of hymen in a victim of rape: *AI 12*
 A. Vaginal speculum B. Glaister-keen rod
 C. Cylinder rod D. Hegar's rod
14. Position of rupture of hymen in a virgin after rape: *PGI 09; AP 09*
 A. 3'o clock B. 5'o clock
 C. 11'o clock D. 12'o clock
15. When two objects come in contact, an exchange of energy takes place. This is known as: *PGI 08*
 A. Galton exchange
 B. Locard exchange principle
 C. Bertillion system
 D. Hasse rule
16. Motile spermatozoa found in wet mount of vaginal secretions are indicative of intercourse within the past: *Karnataka 03, 09; UP 09; Manipal 11*
 A. 6 h B. 12 h
 C. 24 h D. 48 h
17. NOT a feature of post-traumatic stress disorder: *AI 08*
 A. Hyperarousal B. Emotional numbing
 C. Flashbacks D. Hallucinations
18. Test for vaginal cells collected for investigation for rape: *AI 08*
 A. Lugol's iodine test B. Acro-reaction test
 C. Precipitin test D. Berberio's test
19. Incest is: *UP 09*
 A. Intercourse with blood relation
 B. Intercourse with children
 C. Intercourse with friends
 D. Intercourse with a married woman
20. True about incest is: *Karnataka 11*
 A. Punishable under Sec. 294 IPC
 B. Punishable under Sec. 377 IPC
 C. Punishable under Sec. 304A IPC
 D. Not punishable in India
21. Not punishable under Indian law: *TN 10*
 A. Incest
 B. Adultery
 C. Rape
 D. Indecent assault

1. B 2. A 3. C 4. A 5. D 6. C 7. C 8. D 9. A 10. C 11. D 12. A
 13. B 14. B 15. B 16. B 17. D 18. A 19. A 20. D 21. A

Unnatural Sexual Offences

26

Definition: An unnatural sexual offence means sexual intercourse *against the order of nature*, i.e. when the act does not involve penetration of a woman's vagina by the man's penis.

- It can be any form of sexual intercourse which does not have the potential for procreation.

Unnatural sexual offences include:

- i. Sodomy
- ii. Tribadism/Lesbianism
- iii. Bestiality
- iv. Buccal/Oral coitus

- These offences are punishable under **Sec. 377 IPC** with an imprisonment for life or with imprisonment which may extend to 10 years and fine.¹
- Furthermore, the offence is cognizable, non-bailable, non-compoundable and tried by a magistrate of first class. In a trial of an accused under this Section, the prosecution must prove that the:
 - i. Accused had carnal intercourse with a man, woman or an animal
 - ii. Such intercourse was against the order of nature
 - iii. The act was done voluntarily by the accused
 - iv. Penetration had occurred.

In 2009, the Delhi High Court decriminalized consensual homosexual activities between adults. The court stated that the judgment would hold until Parliament chose to amend the law. However, the judgment keeps intact the provisions of **Sec. 377 IPC** in-so-far as it applies to non-consensual non-vaginal intercourse and intercourse with minors.

Sodomy

Definition: It is the anal intercourse between two males (homosexual sodomy) or between a male and a female (heterosexual sodomy). It is also called **buggery**.²

- **Pederasty** is intimate sexual relations, especially anal intercourse with a boy outside his immediate family as the passive partner (the boy is known as *catamite* and the man as *pederast*).³ Habitual passive agents are called fairies, gays or queens in the West, and in India they are called *hijras* (castrated males) and *zenanas* (male transvestites).

- The Greeks of Golden Age were said to practice it and is also called '*Greek Love*.'
- It is frequently seen among sailors, prisoners and in military barracks and prevails at all levels of society.

Brief anatomy of anal canal

Normally, the anal orifice is slit-like and running antero-posteriorly with marked ridges (folds) due to the action of corrugator cutis ani muscle. The perianal skin is pigmented and keratinized and has skin appendages (e.g. hair, sweat glands and sebaceous glands). The external anal sphincter has the ability to dilate significantly without any obvious injury to the sphincter or anal canal.

Examination of Passive Agent of Sodomy

Pre-requisites and Preliminary Particulars

- Written authorization from Magistrate or in-charge of a police station is a must before undertaking an examination. If the passive agent is a victim (non-consenting), he can also request for an examination, but the doctor should inform the police.
- General information—name, age, sex, address, occupation, time, date and place of examination.
- Two identification marks are noted.
- Written informed consent should be obtained in case of non-consenting victim. Consent in case of accused is guided by **Sec. 53 (1) CrPC**.
- History, date and time of the incident, defecation, change of clothing, bathing or washing the anal area after the alleged act, use of lubricant and degree of penetration is specifically asked for.
- Any history of pain/burning sensation associated with defecation or walking is specifically asked for.
- Gait of the victim is noted.

Clothings: Clothings are examined for damage, loose pubic hair, stains of blood/semen/lubricant/feces.

General examination: General physical examination including development of secondary sexual characters is noted. Any injuries, like abrasions and bruises indicating resistance should be noted.

Local Examination (in knee-elbow position) (Fig. 26.1)

A number of variables may affect the possibility of finding physical evidence of anal intercourse:

- Frequency of the acts
- Time interval between intercourse and examination
- Age, built and size of the orifice in the individual
- Degree of force applied during the act
- Size of the penile organ
- Cooperativeness of the partner
- Use of lubricants

Non-habitual Passive Victim

Lesions are marked in children because of great disproportion in size between anal orifice of victim and penis of the accused. A perianal and rectal swab should be taken first and any matted (anal/pubic) or foreign hair should be preserved for examination.

- i. There is pain/tenderness during examination.
 - ii. Smears of lubricant and loose foreign pubic hair around/in the anus.
 - iii. Fresh/dried semen may be present around/in the anus.
- iv. **Injuries:** Superficial injuries include perianal abrasions, bruising, erythema, hematoma, edema and anal fissures. Deep injuries include anal lacerations/tears extending onto the perineum, complete transection of the external anal sphincter and perforation of the rectosigmoid (more common in children).
- Abrasions may be present around the anal opening—produced by frictional shearing of the penetrating penis but may be caused by fingernails or due to poor hygiene. Extensive abrasions are seen when there is disproportion between anal orifice and the penis.
 - Anal fissures (splits in the skin of anal margin) may involve the external skin or may extend within

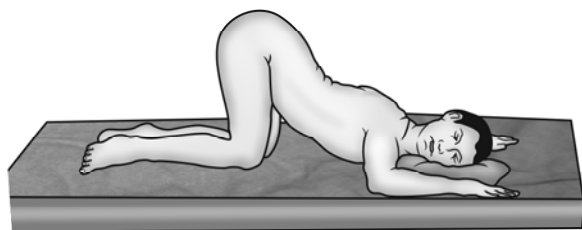

Fig. 26.1: Knee-elbow (genupectoral) position

anal canal to mucocutaneous junction and are usually present in the posterior quadrant. It is generally wedged shaped (triangular), directed radially towards the anal canal.

- Hematoma may be present which is diffuse and present around anal margin with obliteration of normal anal skin folds or appears as localized swelling.
 - There may be anal prolapse.
 - First intercourse may result in overt tearing of anal skin and underlying sphincter muscle or splitting of skin and production of anal fissure or mere abrasion/contusion of the opening.
- v. Digital examination is extremely painful, may show loss of elasticity and tone.
 - vi. At the end, anal canal and lower rectum is examined with the help of proctoscope (if there is spasm of the sphincter, it may be carried under anesthesia).

Habitual Passive Agent (Fig. 26.2)

- i. There may be shaving of anal hair.
- ii. Bloodstains are usually not observed.
- iii. Loose foreign hair and smears of lubricant may be present.
- iv. Perianal skin may be thickened and keratinized.
- v. Person does not experience any pain or tenderness during digital examination. Anal sphincter is lax, opening is patulous, canal is dilated and there may be loss of fine symmetric rugal pattern along with congested or dilated veins.
- vi. *Lateral traction test:* External anal sphincter relaxes reflexly when bimanual traction is applied to the buttocks.
- vii. *Anal opening* is more deeply situated than usual due to absorption of subcutaneous fat, giving a *funnel-shaped* depression of buttocks.
- viii. *Rectum:* Thickened, congested and prolapse of mucosa with disappearance of radial fold.

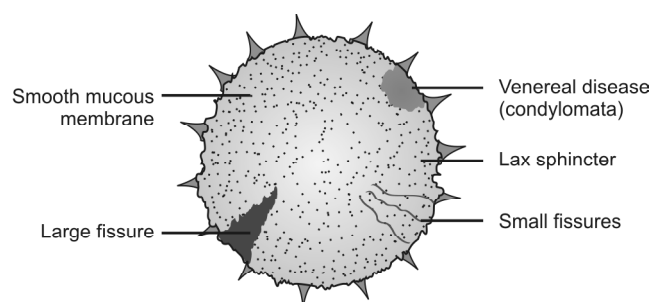

Fig. 26.2: Findings in a habitual passive agent of sodomy
(For color version see Plate 5)

- ix. *Other signs*: Venereal disease, cryptitis, piles, fissures, anal scars from healed injuries and homosexual mannerism regarding dress, gait, manner of speaking and cosmetics.

Opinion

Opinions should be restrained, but not vague, especially on matters where lack of experience makes it dangerous to be assertive.

The opinion is based on:

- Presence of semen/seminal stains in and/or around the anus
- Soiling of the anal region with lubricants
- Smearing of clothes with semen, blood, lubricants or any other material
- Injuries in and around the anus
- Foreign hair
- Changes in the general anatomy of the anal opening and the surrounding area.

There may or may not be any residual findings from either the single or repeated acts of anal intercourse. Signs may be minimal when lubricant has been used or the organ been introduced slowly into the anus without using undue force. Moreover, the acute signs of penetration get healed in about 24-48 h. Hence, time interval between alleged offence and examination is vital in documentation of the findings.

- Non-specific findings such as erythema, perianal abrasions and pigmentary venous changes along with history may be suggestive of alleged contact.
- If any dilatation of anus is present, opinion should be given that it is consistent with entry of penis.
- The presence of semen, feces, soft paraffin and pubic hair on clothes is almost diagnostic of sodomy.
- The only absolute proof of sodomy is the presence of semen in the anus.

Diagnostic findings

- Transection of the anus
- Perforation of the rectosigmoid colon
- Recovery of seminal products from the anorectal canal
- Perianal scarring

Examination of Active Agent of Sodomy

Pre-requisites and preliminary particulars

- General information—name, age, sex, address, occupation, time, date and place of examination.
- Two identification marks are noted.
- Consent in this case is guided by **Sec. 53 (1) CrPC**.
- History of his version is noted.

Examination

- Clothes are examined for the presence of stains—blood, fecal, seminal or mud.
- The accused is examined for abrasions and contusions on glans or tearing of the frenulum. Forceful penetration against resistance may produce tears or bruising of frenulum or prepuce and abrasion of glans penis.
- There may be traces of feces and lubricant about his genitalia and the peculiar smell of anal glands.
- There may be presence of blood, seminal stains, venereal disease and foreign hair.
- In habitual active agent, the penis is usually twisted with constriction at some distance from glans due to constriction force of the sphincter ani.

Specimens to be preserved for passive and active agent

Passive agent	Active agent
<ul style="list-style-type: none"> • Clothing • Swab from anal canal • Swab from bite mark • Blood • Nail scrapings • Matted and foreign pubic hair and his own for comparison 	<ul style="list-style-type: none"> • Clothing • Swab from glans • Urethral discharge • Blood • Pubic hair • Nail scrapings • Urine

Medico-legal Aspects

- Presently in India, if the act is done without the consent of the adult passive partner, the active partner is held guilty, otherwise it is not considered as an offence.
- Marriage contract gives implied consent for sexual intercourse per vaginum, not per anum. Under Sec. 13 of Hindu Marriage Act, conviction for natural or unnatural sexual act is a valid ground for divorce.
- Penetrative anal sex is legal in UK between consenting adults who are over the *age of consent*, i.e. at least 16 years of age. The sexual act had to take place in private and members of the Armed Forces and merchant seamen were excluded, whatever their age.

- The term **sodomy** is derived from the name of the ancient city of Sodom, which according to the Bible was destroyed by God for its misdeeds. Traditionally, the misdeeds of Sodom have been understood to be male homosexual anal intercourse.
- **Sin of Gomorrah**: According to the Bible, the men of Sodom and Gomorrah desired to perform homosexual

gang rape on the angels. Homosexuality was the reason God poured fiery sulfur on the cities, completely destroying them and all of their inhabitants.

- At the extreme, homosexuality remains punishable by death in Afghanistan, Iran, Nigeria, Pakistan, Saudi Arabia, Sudan, United Arab Emirates and Yemen.
- **Intragluteal coitus** occurs when the penis is placed between the gluteal fold which may result in edema, contusion and abrasions involving the natal cleft, perineal and anal tissues due to friction. There may be presence of seminal stains on the back or buttocks and pubic hair and other trace elements (e.g. fibres) may also be found on the body.

Tribadism/Lesbianism

Definition: It is female homosexuality in which two women by mutual acts of sexual indulgence achieve gratification.⁴

Features

- Many lesbians are masculine in type, possibly due to endocrine disturbances and are indifferent towards men.
- Lesbians who are morbidly jealous of one another when rejected may commit homicide, suicide or both.
- It is usually indulged by women who have repulsion for men or who suffer from *nymphomania*.
- The predominant forms of sexual activity to achieve orgasm are oral-genital and manual genital stimulation. Self-stimulation of clitoris is frequently the preferred method. Use of artificial phallus, anal stimulation and other practices are infrequently used.
- The acts include lip kissing, massaging the breasts and private parts, generalized body contact and mutual rubbing of private parts.
- On examination, the external genitalia may show scratch marks and/or bite marks.

- The word '*tribadism*' is derived from the obsolete word *tribade*, meaning 'lesbian'.⁵
- The word '*lesbian*' originally referred to an inhabitant of the island of Lesbos, in ancient Greece. The term has come to have its current meaning due to the ancient Greek poet *Sappho*, who lived on the island; some of her poems concerned love between women. This led to the term **sapphism** being used for lesbianism.
- **Nymphomania:** Abnormal, excessive, insatiable desire in a woman for sexual intercourse.
- **Satyriasis:** Morbid, insatiable sexual need or desire in a man.⁶

Homosexuality: It is the phenomenon wherein an individual (male or female) prefer a partner of the same sex for sexual activity and intimate bonding.

- The most frequent form of male homosexual activity is fellatio and masturbation; anal intercourse occurs much less often.
- In the past, homosexual couples often lived together but downplayed their relationship in public to avoid discrimination. Many couples now assert the legitimacy of their relationship through marriage (recognized by religious and political institutions) and parenthood.
- Lesbian couples are conceiving and bearing children through various artificial methods like infertile heterosexual couples. Adoption is another means to parenthood for gay and lesbian couples.

Bestiality (Zoophilia)

Definition: It is sexual intercourse with animal, either vaginal, anal or oral. This includes all animals, including birds, the usual victims being pets and farm animals.

- Generally, sheep are used by males, and dogs or cats by females as they are easily available and relatively docile.
- Doctor may sometimes be asked to examine genital injuries or infections in a man acquired during such episodes. The sure evidence of bestiality is finding of human spermatozoa in the genital tract of the animal. The penis may be contaminated with fecal matter, vaginal secretion or hair of the animal. There may be injury to the penis, dung stains, general body injuries or bloodstains.

In UK, under '*Sexual Offences Act 2003*' reduced the sentence to a maximum of 2 years imprisonment for penile penetration of or by an animal.

Buccal Coitus

Definition: It denotes penile or vaginal oral sexual intercourse and can be performed by both males and females.

- It is also called the '*Sin of Gomorrah*', because it is alleged that buccal coitus was prevalent in Gomorrah, the Biblical twin city of Sodom.
- **Fellatio** (Latin *fellare*: to suck) means oral stimulation of the penis either by the female or male.
- **Cunnilingus** means oral stimulation of female genitalia.
- Earlier buccal coitus was considered as a sexual deviation, but nowadays it is considered normal sexual foreplay.

- **Injuries:** A person who is forced to perform fellatio may have trauma in the oral cavity, such as petechiae of the palate and/or posterior pharynx. Tears to the labial frenulum may result from forceful traction on the upper lip. If a fellator's scalp hair is grasped forcibly during the act, traction alopecia may be seen.
 - If the victim has fellatio or cunnilingus performed on him/her, acute signs include petechiae, abrasions or bite marks to the genitalia.
- The only material evidence of buccal coitus is the presence of seminal products including spermatozoa in oral cavity and nasopharynx of the fellator (dependent upon time since contact and a history of ejaculation) and buccal mucosal cells on the external genitalia of the subject.
- The mouth and pharynx should be swabbed with nonabsorbent cotton swabs and a smear should be made similar to that made of the vaginal material. A culture for gonorrhoea should be taken from the nasopharynx.

Medico-legal Aspects

- In India, under the Hindu Marriage Act, insistence on buccal coitus, if it is non-consensual and repetitive, constitutes a valid ground for divorce.
 - Buccal coitus performed by consenting adults over 21 years of age is permitted by law in UK.
- **Anilingus:** The practice of oral stimulation of the anus.
 - **Uringism:** Sexual practice in which sexual desire is only for one of the same sex (obsolete word for male homosexuality).

MULTIPLE CHOICE QUESTIONS

1. **Sec. 377 IPC deals with:** AIIMS 09

A. Rape	B. Adultery
C. Sadism	D. Sodomy
2. **Buggery is:** Maharashtra 10
 - A. Anal intercourse between man and woman
 - B. Anal intercourse between man and animal
 - C. Sexual intercourse between two women
 - D. Passive victim of anal intercourse
3. **Catamite is:** AP 08
 - A. Any passive victim of sodomy
 - B. Young passive victim of sodomy
 - C. Elderly passive victim of sodomy
 - D. Female passive victim of sodomy
4. **Tribadism is:** AP 06
 - A. Man having anal sex with man
 - B. Woman having sex with woman
 - C. Man having anal sex with women
 - D. Women having sex with animal
5. **Lesbianism is also called as:** TN 06

A. Tribadism	B. Eonism
C. Sodomy	D. Onanism
6. **Irresistible sexual desire in a male is known as:** AIIMS 08

A. Nymphomania	B. Tribadism
C. Satyriasis	D. Sadism

Definitions

- **Sexual perversions** are conditions in which sexual excitement or orgasm is associated with acts or imagery that are considered unusual, abnormal or deviant within the culture.
- **Paraphilia** (Greek *para*: beside, *philos*: loving) is used to indicate sexual arousal in response to sexual objects or situations that are not part of societal normative arousal/activity patterns or which may interfere with the capacity for reciprocal affectionate sexual activity.
 - It is characterized by a 6-month period of intense, recurrent sexual urges or behaviors that involve nonhuman objects, or causing pain/suffering to the individual or sexual partner, or involve harmful sexual contact with non-consenting children or adults.
 - The most common paraphilias as described in Diagnostic and Statistical Manual of Mental Disorders, Fourth Edition (DSM-IV) are:¹

i. Sadism	ii. Masochism
iii. Transvestic fetishism	iv. Voyeurism
v. Exhibitionism	vi. Fetishism
vii. Frotteurism	viii. Pedophilia

- **Paraphilia not otherwise specified:** This include paraphilias that do not meet the criteria for any of the other specific categories, e.g. masturbation, urophilia, coprophilia, scatologia, partialism, zoophilia and klismaphilia.

Sadism (Algolagnia)

Definition: Person gets sexual gratification by infliction of pain or physical cruelty, like beating, biting, whipping, cigarette burns or ill-treating the partner.

- Multiple injuries are inflicted on any body parts, but breasts and external genitalia are generally selected. In extreme cases, even a murder is committed (lust murder).²

- This perversion is more common in males.
- The name **sadism** is derived from the French writer *Marquis de Sade* (1740-1814) who regarded sexually deviant acts as being natural and which was apparent in both his writings and actions. His life consisted of numerous acts of extremely violent physical and sexual abuse; most of his victims were female prostitutes, and male and female employees of his estate. He wrote pornographic and erotic books in which characters enjoyed being cruel.

Lust Murder

Definition: It is a homicide in which the offender stabs, pierces, slashes or otherwise mutilates the sexual organs or areas of the victim's body. With torturing the partner, sexual arousal starts and with death of the partner, full gratification is obtained.

- The mutilation of the victim may include evisceration and/or displacement of the genitalia.
- After murder, the sadist may have sexual intercourse with her (*necrophilia*). He may tear out the genitalia or other organs, may suck or lick the wounds or eat the flesh of his victim to derive sexual pleasure (*necrophagia/anthropophagy*).
- It is the consequence of extreme sadist practice.
- A lust murder begins with the obsessive compulsions of the offender. Generally, they have a sexual obsession with their victims and organized lust murderers may stalk their victims for months or weeks before the actual killing.
- The *signature component* of the crime that which names it a 'lust murder' is the killer acting out their fantasies with their victims and the bodies of those victims.

Masochism (Passive Algolagnia)

Definition: Sexual gratification is obtained only when they receive painful stimulus from opposite partner.^{3,4}

- It is the *reverse of sadism*.
- More commonly seen in males.

- The term is derived from the 19th century author *Leopard Von Sacher Masoch*, an Austrian novelist who portrayed his principle male character suffering from this perversion. His story appeared to parallel his relationship with his wife as he used to plead her to treat him as a slave and whip him, and his eccentric requests gradually became more demeaning to satisfy his sexual appetite.
- Masochistic asphyxial death may occur due to accidental hanging or strangulation (*autoerotic death*).⁵ Sadism and masochism are rarely found in pure state (combined entity is known as sadomasochism). They are usually found together with one type dominant over the other. The combination is known as **bondage**.

This is found in all age groups and among all socio-economic strata. These acts of cruelty may completely substitute the sexual intercourse.

Transvestic Fetishism (Eonism)

Definition: It is a disorder characterized by recurrent, intense, sexually arousing fantasies, sexual urges or behaviors involving cross-dressing.

- Sexual gratification is obtained by wearing the dress of opposite sex. In contrast, transsexuals wear clothes of other sex because they feel a part of the other sex and *not* for sexual excitement.
- It is usually seen in males. They collect items of distinct feminine look and feel like nightgowns, slippers, bras, lingerie, stockings and pantyhose and may dress in these feminine garments and take photographs of themselves while living out their secret fantasies.
- *Magnus Hirschfeld* coined the term 'transvestism' (Latin *trans*: across, over; *vestitus*: dressed) to refer to the sexual interest in cross-dressing.⁶ The term has undergone several changes of meaning since it was first coined. Hirschfeld's group of transvestites consisted of both males and females with heterosexual, homosexual, bisexual and asexual orientations.
- The term 'eonism' is derived from the Frenchman, *Chevalier d'Eon de Beaumont*, who practiced this perversion.

Cisvestism: It is a disorder characterized by obtaining sexual pleasure from dressing up in clothes typical of one's own sex but inappropriate to the individual's position or status, e.g. biker's 'leathers' or cowboy's outfit.

Voyeurism (Scotophilia)

Definition: There is a morbid desire of the individual to observe unsuspecting people undress or naked, taking bath, see the genitalia or watch intercourse to get erotic excitement and sexual gratification.

- It is commonly seen in males.
- Voyeurs (French *voir*: to see, observer) frequently peep into the bedrooms of others and are therefore called as '*Peeping Toms*'.
- Some voyeurs prefer to observe their own wives being seduced by other men. The act of observation may be accompanied by exhibitionism or masturbation.
- It occurs in case of sociopathic personality disorder and such individuals may commit sexual crimes.
- Psychoanalysts postulate that voyeurism may be attributed to a child witnessing episodes of his/her parents engaged in sexual intercourse.
- In UK, non-consensual voyeurism is a criminal offence, and in US video voyeurism is criminalized in many states.

Troilism: The pervert gets sexual gratification by inducing his wife to have sexual intercourse with another man and by observing the same.

Exhibitionism

Definition: It is a desire and intentional exposure of genitalia in public places while in presence of others (mostly in front of unsuspecting children or females) to obtain sexual pleasure.

- This perversion is mostly seen in males and are called *flashers*. Occasionally women may expose themselves in public.
- Most of them are psychopathic or suffer from compulsive neurosis.
- *Narcissism*, the extreme form of self-admiration is also believed to contribute to exhibitionism.

Legal aspect: It is an obscene act punishable under Sec. 294 IPC with imprisonment upto 3 months and/or fine.

Fetishism

Definition: It is a fixation on an inanimate object or body part that is not primarily sexual in nature and the compulsive need for its use in order to obtain sexual gratification.⁷

- *Alfred Binet*, the French psychologist coined the term 'erotic fetishism' (French *fétiche*: attribution of mystical qualities to inanimate objects).
- It is mostly seen in males.
- *Fetish objects*: Although the list of objects is inexhaustible, more commonly fetish objects are handkerchief, dress, particularly the undergarments—panties, bras, slippers, stockings, panty hose or negligees.
- *Essential feature* is recurrent intense sexual urges and sexually arousing fantasies involving specific objects. They cannot suppress their desire to steal the fetish object.
- *Diagnosis* is made if an individual has acted on these urges and is markedly distressed by them or the fetish object is required for gratification.

Frotteurism (Toucherism)

Definition: Obtaining sexual arousal and gratification by rubbing of one's genitals against a non-consenting person in public places.

- It is usually seen in males.
- Frotteurism occurs in crowded trains, buses, elevators and at bicycle stands (where people bent over for unlocking locks).
- It is prevalent in Japan, where it is known as *chikan* and is regarded as a public safety problem.
- Fondling (groping) the victim may be part of the condition and is called *toucherism*.
- This is an offence and punishable under Sec. 290 IPC (fine of ₹ 200) and Sec. 291 IPC (imprisonment for 6 months and/or fine) for creating public nuisance.

Pedophilia

Definition: It is the recurrent, intense sexual fantasies, urges or behaviors involving sexual activity with a prepubescent child or children (≤ 13 years) by a person who is ≥ 16 years old and at least 5 years older than the child.

- Pedophiles are usually men and can be attracted to either or both sexes.
- Typical activities vary from just looking at a child undressing and fondling, to acts like oral-genital contact, rubbing the penis between orifice or thighs and actual penetration.
- Usually the child is not able to understand the nature and consequences of the act and the perpetrator is influential (elder), i.e. having parental or other position of authority with respect to the child (incestuous or non-incestuous relationship).

- It is one of the few psychiatric diagnoses for which the symptom behavior constitutes a criminal act. If a person is having pedophilia, it is not illegal but an adult having sexual contact with a prepubescent child is illegal.

- **Infantophilia** is a subcategory of pedophilia in which the victims are < 5 years.
- **Ephrophilia**, also known as **hebephilia**, is the sexual attraction of an adult to pubescent or post-pubescent adolescents.
- **Gerontophilia** refers to the sexual preference for the elderly.

Masturbation (Onanism)

Definition: Deliberate self-stimulation which results in sexual arousal.⁸

- Masturbation is common in both men and women.
- *In males*, methods are mostly manual—by moving the penis against a bed or other object. Anal stimulation and insertions are rare. Hollow articles, like bottles or test tubes or articles made of rubber and plastic which stimulate female genitalia are sometimes used.
- *In females*, a finger or a hand is gently and rhythmically moved over clitoris or labia minora. The genitalia may be rubbed against a pillow, bed or some other object. She may insert fingers, wooden rods, test tubes, metallic bars, bananas or artificial phallus made of rubber or plastic into the vagina.
- It is an offence when practiced openly, e.g. in telephone booths, bus or toilets.

The word **onanism** was formerly used as a synonym because in biblical times under Jewish law, a brother was required to procreate with his brother's widow. Onan of Judah refused and ejaculated on the ground instead. This is the origin of the term onanism (*The Sin of Onan*) which is incorrectly used in place of masturbation.

Uranism

The pervert gets sexual gratification by fingering, fondling or licking (homosexuality in males).

Urolagnia (Urophilia, Undinism)

- The pervert gets sexual gratification by sight or odor of urine and/or by urination.
- Those who enjoy urolagnia (Greek *ouron*: urine, *lagneia*: lust) may enjoy urinating on another person or being urinated upon (*golden showers*).
- In New Zealand, publishing anything promoting or supporting urolagnia, whether in print or online, is punished with imprisonment upto 10 years.

Coprophilia

Coprophilia (Greek *koprós*: excrement, *filía*: fondness) is a morbid attraction to, and sexual gratification obtained from feces (liking the smell, taste or feel). Eating of feces is known as *coprophagia*.

- **Scatologia** involves making obscene phone calls.
- **Partialism** is sexual interest exclusively focused on a particular body part.
- **Klismaphilia** is sexual activity involving enemas.

Indecent Assault

Definition: Any unwanted sexual behavior or touching of a female without her consent, with the intention or knowledge to outrage her modesty.

- Males usually do it often to females or adolescents.
- The meaning of indecency depends upon prevailing views of what is unacceptable behavior.
- This can mean many things, from an unproven rape to merely touching the buttocks in a crowded bus.

- Forcing someone to watch pornography or masturbation, disrobing or compelling a female to get naked in public place, fondling the breasts, thighs, perineum, kissing a woman forcefully, or putting a hand up a woman's skirt constitute indecent assault.

Allegations Against Doctors

One particular risk in medical practice is the vulnerability of male doctors to the allegations by women patients of indecent assault during consultation or treatment session which may vary from intimate touching, to kissing, fondling the breasts or pudenda and even actual intercourse (which may amount to rape). Stripping naked a female patient for medical examination is regarded as an assault.

Legal aspect: It is punished under **Sec. 354 IPC** with 2 years imprisonment and/or fine. The offence is cognizable, bailable, non-compoundable and can be tried by any Magistrate. In UK, indecent assault is an offence under Sec. 3 of Sexual Offences Act, 2003.

MULTIPLE CHOICE QUESTIONS

1. **Following is not a paraphilia:** *DNB 10*
 - A. Lesbianism
 - B. Fetishism
 - C. Frotteurism
 - D. Voyeurism
2. **Lust murder is an extreme form of:** *MP 09*
 - A. Troilism
 - B. Allogagnia
 - C. Masochism
 - D. Frotteurism
3. **Masochism means:** *Jharkhand 03; TN 09*
 - A. Sexual intercourse with dead body
 - B. Sexual pleasure by contact with articles of opposite sex
 - C. Sexual pleasure by suffering of pain
 - D. Sexual pleasure by self-stimulation
4. **Perversion with pain to self:** *TN 09; Maharashtra 11*
 - A. Transvestism
 - B. Fetishism
 - C. Sadism
 - D. Masochism
5. **Sexual asphyxia is seen in cases of:** *AIIMS 06*
 - A. Masochism
 - B. Voyeurism
 - C. Sadism
 - D. Fetishism
6. **Eonism is:** *Delhi 05*
 - A. Sexual urge to dress like opposite sex
 - B. Intercourse with a lower animal
 - C. Female homosexuality
 - D. Obtaining sexual gratification by seeing naked bodies
7. **Fetishism is a sexual perversion characterized by:** *COMEDK 08*
 - A. Sexual focus on children
 - B. Sexual focus on genital rubbing
 - C. Sexual pleasure for pain
 - D. Sexual pleasure derived from inanimate objects
8. **Onanism is:** *TN 07*
 - A. Natural sexual offence
 - B. Unnatural sexual offence
 - C. Perversion
 - D. Indecent assault

Postmortem Artifacts

28

Definition: Artifacts (Latin *arte*: art, *factum*: something made) are any changes caused or features introduced in a body after death which may lead to misinterpretation of findings.

Ignorance and misinterpretation of such postmortem artifacts leads to:

- Wrong cause/manner of death
- Undue suspicion of criminal offence
- A halt in the investigation of criminal death
- Unnecessary wastage of time and effort as a result of misleading findings
- Miscarriage of justice

Postmortem artifacts can be classified into:

- i. Artifacts due to postmortem changes
- ii. Third party artifacts
- iii. Environmental artifacts
- iv. Other artifacts

Artifacts due to Postmortem Changes

These artifacts are due to rigor mortis, postmortem staining, autolysis, putrefaction and heat.

- i. **Rigor mortis:** Existing rigor mortis may be broken down while removing the body from the scene of crime to the mortuary which may cause error in interpretation of time since death. Rigor affecting the heart may simulate hypertrophy of the heart.
 - ii. **Postmortem staining:** Isolated patches of postmortem lividity may be mistaken for bruises. Such patches on the front and sides of the neck may be mistaken for bruising due to throttling. Lividity of the internal organs may be mistaken for congestion due to disease.
- Postmortem staining in the posterior left ventricle of the heart in an individual lying supine after death may cause confusion of ischemic myocardial damage, in the lungs—pneumonia, and in the GIT—irritation due to poisoning.
 - Certain poisons, like CO, HCN or nitrites may change the color of the hypostatic area.

Prinsloo Gordon artifact: A common artifact seen in all types of autopsy. It represents hemorrhage on the anterior aspect of the cervical spine, posterior to the trachea and esophagus which happens due to hypostasis. Hence, caution must be used in interpreting bleeding into the posterior neck tissues.

iii. **Autolysis:** Autolysis leads to discoloration of skin and viscera, like gallbladder, pancreas, liver, kidney, GIT mucosa and brain where it may simulate injury or disease. Pancreas is one of the first organs to undergo autolysis because of proteolytic enzymes within it, which can be mistaken for acute hemorrhagic pancreatitis. Perforation of the stomach due to autolysis have to be distinguished from that due to corrosive acid or peptic ulceration. Absence of cellular response in discolored areas establishes the postmortem origin of these changes.

iv. Putrefaction

External

- Swelling of lips, nose, eyelids and extremities, distension of the chest and the abdomen may occur, giving a false impression of antemortem obesity.
- Large quantities of sanguineous fluid may escape from the mouth and nose in case of pulmonary edema, giving the impression of hemorrhage.
- A deep groove simulating ligature mark of strangulation may be seen around the neck if the deceased has been wearing buttoned shirt or beaded threads or ornaments around the neck.
- The bulging of eyes, protrusion of tongue and discharge of red stained froth from mouth and nose may be mistaken for signs of throttling.
- Owing to pressure effects of putrefactive gases, postmortem staining may be displaced in any direction and may simulate antemortem bruises.
- Putrefactive blisters may be confused with blisters from burns and contact with petroleum products. The skin from the hand may peel like a glove as in burns.

- Froth and stomach contents coming out from the nose and mouth may tan the facial skin, simulating antemortem burning.
- Splitting of skin may give a false impression of antemortem lacerations, incised wounds or thermal injuries.
- The female genitalia appear pendulous and may simulate antemortem sexual assault.

Internal

- Softening of 'synchondrosis' between the body and greater cornu of the hyoid bone may produce abnormal mobility which may be confused as a fracture.
- Gas bubbles in the blood and air in the right side of the heart may be mistaken for air embolism. Oxygen in right heart will indicate antemortem air embolism.
- Internal lividity with hemolysis of red cells may resemble hemorrhage, especially in the meninges, kidneys and retroperitoneal tissues.
- The blood becomes darker and the brain, heart and lungs appear congested which may be mistaken for asphyxia.
- Bluish discoloration of the loop of bowels, especially in the pelvic cavity may be confused as an infarcted bowel.
- If a body lies on its back, blood get accumulated in the posterior part of the scalp due to gravity. Lysis of red blood cells and breakdown of vessels cause the blood to seep into the soft tissues of the scalp giving the appearance of a bruise.
- Postmortem separation of the sutures of child's skull and bursting of the abdomen with protrusion of the abdominal viscera due to advanced decomposition may be mistaken for trauma.

Third Party Artifacts

Artifacts due to Animal and Insect Activity

- The bites by dogs are clear-cut, with deep impression of teeth in a small area. Individual punctures may resemble stab wounds.
- Insect bites (ants or roaches) are dry, brown with irregular margins and usually seen in moist parts of the body, e.g. armpits, groin, scrotum and anus, these may resemble antemortem abrasions.
- Rodents gnaw away the tissue over localized areas. They produce shallow craters with irregular borders and leave long grooves.
- Bodies recovered from water may show gnawing by fish, crabs and other aquatic animals.
- Flies, maggots and larvae may alter the wounds.

Insects can also cause misinterpretation of blood spatter pattern analysis. Roaches walking through pooled and splattered blood will produce trailing. Specks of blood in unique and unusual areas (such as on ceilings) may mislead forensic scientists.

Therapeutic Artifacts

- External cardiac massage, especially in elderly patients is associated with the fracture of ribs and sometime fracture of the sternum along with laceration of the lungs, liver, spleen and diaphragm which can create an impression of a crushing force applied to the chest.
- Use of defibrillator may leave an impression of circular contusion over the pericardium. Multiple intra-cardiac injections may result in bruising of heart and hemopericardium.
- Gastric contents are aspirated in the windpipe due to the handling of the body or as a terminal agonal event in natural deaths or due to resuscitation.
- Investigative procedures, like carotid angiography may result in bruising of the neck muscles giving a false impression of constriction of the neck.
- Surgeons may often take laparotomy incision through incised or stab wounds leading to misinterpretation of wounds.
- Endotracheal intubation, positive pressure and artificial respiration may lead to surgical emphysema and pneumothorax.
- Washing may alter the appearance of entrance and exit gunshot wounds and their dimensions changed by suturing or excision.
- Drainage wounds may be mistaken for firearm wounds.

Deliberate Mutilation, Dismemberment

- Sometimes criminals may inflict injuries, mutilate or dismember the body after death to mislead the investigation.
- Some mutilations are produced in a ritualistic sense displaying significant psychopathology of the assailant. It may include removal of the breasts, genital mutilation such as removal of the penis and scarification type injuries.
- Persons may be killed and thrown into water or set on fire. Careful examination for violence will help in the correct diagnosis of the cause of death. Chemical analysis of the viscera for poisons may be necessary.
- Occasionally, a person may be beaten to death or poisoned and then hanged to mislead people.

Embalming Artifacts

- Trocar wounds may be mistaken for stab wounds or bullet wounds.
- Bruises may be markedly accentuated due to increased transparency of the overlying skin resulting from the embalming process.
- Embalming fluid used may pose problems in toxicological analysis of the viscera as high levels of methanol, anticoagulants and various other dyes are often detected by sophisticated screening methods.

Autopsy Surgeon Induced Artifacts

- Skull fractures:** During the opening of the skull by forceful sawing or by using a chisel and a hammer, an existing fracture of the skull may become extensive or fresh fractures may be caused.
- Air in blood vessels:** During pulling of the dura, air may enter the blood vessels. This may lead to an erroneous diagnosis of air embolism. When neck structures are pulled forcefully, air may enter the neck vessels or there may be seepage of blood around the neck structures leading to erroneous traumatic neck pathology.
- Visceral damage:** The liver, if pulled instead of being dissected out, may cause tears in the diaphragm and laceration in the bare area of the liver. While the abdomen and the peritoneum are being cut open, bowel coils may be cut.
- Extravasation of blood**
 - When viscera are pulled apart in toto, as in evisceration, there would be profuse bleeding into the pleural and peritoneal cavities that may be mistaken as antemortem hemorrhage.
 - The handling of organs and the incision of the vessels may result in extravasation of blood into the tissues.
 - The removal of the neck structures en block as in routine autopsies may produce artifacts in the neck tissues which resemble bruises (as seen in throttling).
 - Rough handling of the brain during removal may damage the dura and the dural venous sinuses that may lead to an escape of blood into the subdural space, simulating an antemortem subdural hemorrhage.
- Fracture of hyoid bone:** While removing neck structures, the hyoid bone and thyroid cartilage may be fractured, especially in old persons which may be mistaken for being antemortem in origin.

vi. Toxicological artifacts

- Faulty technique in collecting a sample or faulty storage or use of preservatives.
- While collecting blood from the heart, the blood may get diluted due to pericardial fluid. Use of anticoagulants, e.g. EDTA, formalin, heparin or methenamine may give a false positive result for alcohol or methanol.
- Collection of the viscera in a single bottle or use of contaminated bottles/instruments/preservatives may result in wrong analysis of visceral poisons.
- Decomposition of the tissues after death produces ethyl alcohol and significant amounts of cyanide. Decomposition also causes an increase in concentration of CO in the blood.
- In cases of death due to burns, significant amounts of cyanide may be found in blood, possibly due to inhalation of hydrogen cyanide.
- In buried bodies, arsenic may be imbibed from the surrounding earth.

Environmental Artifacts**Heat Effects**

- Heat applied to the skin of a dead body may loosen the epidermis from the dermis and produce a postmortem blister.
- Heat hematoma may simulate extradural hemorrhage.
- An unburnt groove around the neck due to a tight collar may resemble a ligature mark.
- Fat droplets may be found in the pulmonary vessels which may be mistaken for antemortem pulmonary fat embolism.
- Heat ruptures may resemble lacerated or incised wounds.

Postmortem Corrosion

Dead bodies exposed or lying in kerosene, water or gasoline show chemical injuries. The epithelium detaches while handling the body and then the underlying dermis turns yellow to brown which may be misinterpreted as antemortem chemical injury or abrasion or burns.

Postmortem Maceration

Physical contact of the body with water, soil or air may cause marked changes, depending upon the chemical constituents of earth, water and the duration of contact. The body may be totally skeletonized leaving decalcified and deformed bones.

Other Artifacts

Artifacts due to Refrigeration

Pink hypostasis is seen in bodies kept in cold storage. If the bodies are kept in a cold storage immediately after death, goose skin may develop.

Artifacts due to Mishandling of the Body

- During the process of transfer of the body from the scene of crime to the mortuary, abrasions may be produced over the back or bony prominences, clothes may get bloodstained or torn.
- Sometimes, fractures of the ribs or long bones or cervical spine may occur by rough handling of the bodies, especially in the elderly or debilitated, during attempts to straighten limbs which are contracted due to rigor mortis.

- Contusion may occur over occiput due to bumping of the head on hard surface.
- *Undertaker's fracture* may be seen which is a subluxation of the lower cervical spine due to tearing of the intervertebral disc at about C6-C7.

Exhumation Artifacts

- Gravedigger's tools can produce postmortem fracture, abrasions and lacerations.
- The discoloration of the skin beneath fungus growth simulates contusion.
- Postmortem imbibition of toxicological elements in the earth may pose problems of inaccurate toxicological analysis.

Artifacts due to Delay in Autopsy

Uncal grooving, seen in cerebral edema, tends to be more prominent when there is a delay in removing the brain.

Definitions

- **Psychiatry:** It is that branch of medical science which deals with the study, diagnosis, treatment and prevention of mental illness and behavioral disorders.
- **Forensic psychiatry:** It deals with the application of knowledge of psychiatry in the administration of justice.
- **Insanity or unsoundness of mind:** Disease of the mind which affects the personality, mental status, critical faculties, emotional processes and interaction with the social environment.
- **Mentally ill person:** Any person who is in need of treatment by reason of any mental disorder other than mental retardation.

Some of the *important symptoms* commonly associated with psychiatric disorders are:

- | | |
|---------------|-------------------|
| i. Delusion | ii. Hallucination |
| iii. Illusion | iv. Impulse |
| v. Obsession | |

Delusion

Definition: False belief, based on incorrect inference about external reality that is *firmly held*, despite objective and obvious contradictory proof or evidence.¹

- A thought disorder is not unusual in normal persons, but he is capable of correcting it by reasoning power, arguments or when convinced by others.²
- Delusion is a symptom of schizophrenia. Delusions are not seen in neurotic illnesses, like anxiety neurosis or obsessive compulsive disorder (OCD).

Types

- Delusion of grandeur or exaltation:** The patient imagines himself to be very rich, while in reality he may be a pauper. It is usually seen in mania, and may be associated with delusion of persecution.³
- Delusion of poverty:** The patient is convinced that he is, or will be, bereft of all material possessions.

- Delusion of infidelity/jealousy (Othello syndrome):** Person holds a delusional belief that his spouse is unfaithful. It is named after the character in Shakespeare's play Othello, who murders his wife based on his false belief that she has been disloyal. Males are more affected.
- Delusion of reference:** The person believes that he is being referred to by all agencies, media and persons around him in all matters (usually of negative nature) concerning him or others.
- Delusion of persecution:** The patient imagines that he is going to be poisoned by his relatives (wife, sons or parents) or someone is going to rob his property. He may even commit suicide or kill his own family members or some innocent person thinking him to be his enemy.⁴
- Delusion of influence/control:** The patient complains that his thought processes, feelings and actions are being influenced and controlled by some external power, like radio, hypnotism or telepathy. On the basis of this imaginary 'command', he may commit an unlawful act.
- Hypochondriacal delusion:** Persistent concern with a fear or belief of having one or more serious disease (like cancer) based on patient's own unrealistic interpretations of physical signs and symptoms.⁵
- Delusion of self-reproach or self-criticism:** The person criticizes himself for some imaginary offence or misdeed committed by him in the past. In serious cases, the person may punish himself by committing suicide.
- Nihilistic delusion:** The patient does not believe in his existence or the existence of earthly matters or that there is any world. It is commonly seen in depression.⁶
- Delusion of doubles (doppelganger):** Patients believe that another person has been physically transformed into themselves.

Medico-legal importance: The *doctrine of diminished responsibility* is applicable to an insane person who does an unlawful act due to delusion, which reduces his

power of reasoning and understanding capacity, e.g. if he commits some act which is not directly related with the effect of the delusion, but has an indirect bearing, such person cannot be regarded as fully responsible for his illegal acts.

Erotomania (de Clérambault's syndrome): It is a condition in which a person holds a delusional belief that another person, usually of a higher social status, is in love with him/her. The erotomaniac tries to get close to the person through telephone calls, e-mails, letters, gifts and visits. It is more common in women than in men.⁷

Other types of delusions

- i. *Delusion of replacement of significant others (Capgras syndrome):* Patient believes that someone close to him has been replaced by an exact double.
- ii. *Delusion of disguise (Fregoli's phenomenon):* Strangers are identified as familiar people in the patient's life.
- iii. *Folie à deux:* Mental illness shared by two persons, usually involving a common delusional system.
- iv. *Cotard delusion/syndrome:* Person holds a delusional belief that he is dead, does not exist, is putrefying or has lost his blood or internal organs.

Hallucination

Definition: Hallucination (Latin *hallucinere*: to wander in mind) is false perception by senses *without any external object or stimulus*.^{8,9} They are seen in insanity and in conditions, like high fever, drug intoxication and during withdrawal from drug addiction.

Types

- i. **Visual hallucination:** It involves the sense of sight. In this condition, the sufferer experiences (visualizes) non-existent sights. He observes something without anything being present. A person sees a plane flying in the sky when there is none.
- ii. **Auditory hallucination:** False perception of sound, usually noises, but also music. The patient hears voices or sounds without any source.
- iii. **Olfactory hallucination:** Hallucination primarily involving smell or odors. There is a false sense of smelling (pleasant/unpleasant/sweet/sour/bitter) without any source. They are felt in schizophrenia and temporal lobe epilepsy.^{10,11}
- iv. **Gustatory hallucination:** Hallucination involving taste. Without any food or drink, the patient experiences different tastes.

- v. **Tactile/haptic hallucination:** Hallucination of touch. The sufferer experiences crawling of insects or rats over his body without any such thing happening in reality.
 - vi. **Psychomotor hallucination:** There is a feeling of movement of a part of the body, say a limb, though in reality, there is no such movement.
 - vii. **Lilliputian hallucination (micropsia):** Visual sensation that persons or objects are reduced in size; more properly regarded as an illusion.
- Visual hallucinations are the commonest in organic mental disorders (delirium tremens), auditory in functional (non-organic) disorders (schizophrenia), gustatory in temporal lobe epilepsy, olfactory in medical disorders (especially in the temporal lobe) and tactile in cocaineism.
 - Auditory hallucinations are the most common, followed by visual.
 - Hallucinations are not under voluntary control and a person suffering from unpleasant hallucinations may be incited to commit suicide or homicide.¹²

Illusion

Definition: It is a false interpretation by the senses of an external object or stimulus *which has a real existence*.¹³

- For example, when a person mistakes his doctor/nurse for his father or mother or for the devil coming to take him away, or when a person sees a dog and mistakes it for lion, or hears the notes of birds and imagines them to be human voices, or imagines a string hanging in his room to be snake.
- A sane person may experience illusion, but is capable of correcting the false impressions. An insane person continues to believe in the illusions, even though the real facts are clearly pointed out.
- Illusions are a feature of psychoses, particularly of the organic type.

Impulse

Definition: This is a sudden and irresistible force compelling a person to the conscious performance of some act without motive or forethought.

Types

- i. **Kleptomania:** Pathological compulsion to steal articles which may be of little value and may not even be useful to the person.^{14,15}

- ii. **Dipsomania:** Compulsion to drink alcoholic beverages.
 - iii. **Pyromania:** Irresistible desire to set things on fire, which is characterized by two or more acts of fire setting without apparent motive.
 - iv. **Mutilomania:** Irresistible desire to injure and mutilate animals, commonly domestic pets.
 - v. **Oniomania:** Compulsive desire to shop (*shopping addiction*).¹⁶
 - vi. **Trichotillomania:** Noticeable hair loss caused by person's persistent and recurrent failure to resist impulses to pull out hair.¹⁷
 - vii. **Suicidal impulse:** Often intoxication (e.g. LSD) may lead to suicidal impulse.
 - viii. **Homicidal impulse:** With certain chronic intoxications, e.g. cannabis, a man may go on a sudden killing spree.
- A sane person is capable of controlling an impulse. An insane person having no judgment and no reasoning power may do things on impulse.
 - These are usually seen in dementia, acute mania and epilepsy.

Obsession

Definition: Persistent and recurrent idea, thought, or emotion that cannot be eliminated from consciousness by logic or reasoning.

- It is a *disorder of content of thought* and is regarded as senseless by the patient (insight is present).^{18,19} This is a sort of compulsive phenomenon which is involuntary and ego-dystonic (foreign to one's personality).
- For example, a person while going to sleep, bolts the door from inside, but after going to the bed he

needs to verify and does so, to see if he has bolted the door or not. He repeats this act again and again, in spite of his consciousness and desire to stop the act. A sane person will stop after repeating the act of verification once, but an insane person may continue the act all through the night without sleeping.

Neurosis and Psychosis

Neurosis is when a patient suffers from emotional or intellectual disorders which causes subjective distress, but does not lose touch with reality. Psychosis is characterized by gross impairment in reality-testing (withdrawal from reality), as if living in a world of fantasy (Diff. 29.1).

Lucid Interval

Definition: It is a period in insanity during which all the signs and symptoms of insanity disappear, and behavior is like that of a normal person.²²

- Lucid interval is common in mania and melancholia.
- The person is responsible for all his acts performed during the period of lucid interval.
- If he commits a crime, then he may take the plea of previous insanity. Moreover, it is difficult to know whether he was suffering from some mental illness at the time of committing the crime.
- Lucid interval is also seen in head injuries (e.g. extradural hemorrhage) (Diff. 29.2).

Some More Definitions

- **Abreaction:** Process by which repressed material, particularly a painful experience or a conflict, is brought back to consciousness.²¹
- **Ambivalence:** Coexistence of two opposing impulses toward the same thing in the same person at the same time.

Differentiation 29.1: Psychosis and neurosis

S.No.	Feature	Psychosis	Neurosis
1.	Contact with reality	Lost	Preserved
2.	Interpersonal behavior	Marked disturbance in personality and behavior	Preserved
3.	Empathy	Absent	Present
4.	Insight	Absence of understanding of current symptoms (insight absent)	Symptoms are recognized as undesirable (insight present)
5.	Organic causative factor	Present	Absent
6.	Symptoms	Delusions, illusions and hallucinations	Usually physical or psychic symptoms
7.	Dealing with reality	Capacity is grossly impaired	Preserved
8.	Examples	Dementia, schizophrenia	Anxiety, phobia, depression, conversion disorder ²⁰

Differentiation 29.2: Lucid interval in insanity and head injury

S.No.	Feature	Insanity	Head injury
1.	History	Of insanity	Of trauma
2.	Preceding symptoms	Of insanity	Of concussion
3.	Following symptoms	Of insanity	Of cerebral compression
4.	Occurrence	Repeated	Once

- **Aphasia:** Any disturbance in the understanding or expression of language caused by a brain lesion.
- **Cognition:** Mental process of knowing and becoming aware.
- **Confabulation:** Unconscious filling of gaps in memory by imagining experiences or events that have no basis in fact, commonly seen in amnesic syndromes; should be differentiated from lying.
- **Echopraxia:** Repeating the act of another.
- **Empathy:** The degree to which the observer is able to enter into the thoughts and feelings of the patient and establish good contact.
- **Negativism:** Doing just the opposite of what he is asked to do.
- **Neurasthenia:** A condition arising out of physical or mental exhaustion.
- **Paranoia:** Rare psychiatric syndrome marked by the gradual development of a highly elaborate and complex delusional system, generally involving persecutory or grandiose delusions, with few other signs of personality disorganization or thought disorder.
- **Parasuicide** (attempted suicide or *pseudicide*) is a conscious often impulsive, manipulative act, undertaken to get rid of an intolerable situation.
- **Stupor:** Used synonymously with mutism and does not necessarily imply a disturbance of consciousness; in catatonic stupor, patients are ordinarily aware of their surroundings.
- **Twilight state:** Disturbed consciousness of short duration with hallucinations during which the patient may carry out actions of which he has little or no subsequent memory.
- **Vegetative signs:** In depression, denoting characteristic symptoms, such as sleep disturbance (especially early morning awakening), decreased appetite, constipation, weight loss and loss of sexual response.

Role of Forensic Psychiatrist

Forensic psychiatrists are often called upon to produce legally binding documents which are presented before

the courts that can determine the course of an individual's life and liberty, and his/her life choices.

An individual with a mental disorder should be assumed to have mental capacity to decide on various matters unless the contrary can be shown. The criterion for incapacity is based upon the following when it is proved that the person is:

- Unable to comprehend and retain information relevant to the decision and its consequences
- Incapable of believing the information
- Incapable of weighing up information to reach a decision

Feigned insanity: With some motive, a person may pose to be insane or a sane person may be presented as an insane person.

The process of deciding fitness or otherwise is of vital importance and 'opinions' are regularly issued by forensic psychiatrists in the following situations:

Criminal Cases

- When an accused on the ground of mental illness, expresses his inability to stand trial and plead his defense.
- When a defense is attempted on the ground that an act has been committed by a mentally ill person.
- When the individual after being convicted in a court of law, pleads insanity so as to defer the execution of the punishment or to send him in a mental asylum.
- When it is claimed that a person has committed suicide due to mental illness.
- In connection with abetment of suicide of a mentally ill person.
- In connection with criminal breach of trust or fraud committed against a mentally ill person, relating to business or property matter.

Civil Cases

- Validity of consent given by a mentally ill person.
- Competency as a witness.
- Continuance/dissolution of a business contact on the ground of mental illness of either partner.
- Nullity of marriage or divorce cases.
- Take custody of a child whose parents are mentally ill.
- Certain eventuality, like appointment of a caretaker to a mentally ill person who is unable to look after his property.
- Capacity to make a valid will (*testamentary capacity*).

In western countries, legal incapacity decisions are done under very high statutory prescription, ethical

dialogue and technical development of tools of assessments. In India, the opinion regarding 'fitness' is often a personal judgment based on clinical assessment and hence should be undertaken diligently.

To differentiate feigned insanity from true insanity, guiding principles are given in Diff. 29.3.

Psychiatric Assessment

- I. **Identification data**, informants (if any) and their relationship with patient.
- II. **History**: It should be done confidentially. Interview should be taken with maximum patience, and should include:
 - Presenting chief complaints and history of present illness.
 - Past psychiatric, medical, surgical, neurological, and treatment history, any accident and hospitalization.
 - *Family history*: Family origin, pedigree chart (family tree), history of similar illnesses.
 - *Personal history*: Perinatal, childhood, educational, play, puberty, menstrual and obstetric (in females), occupational, sexual and marital history, premorbid personality, like interpersonal relationship, mood, religious belief and habits.
- III. **Physical examination**: Detailed general physical and systemic examination should be done.
- IV. **Mental Status Examination (MSE)**: It is done using a standardized protocol:
 - i. *General appearance and behavior* along with his gait, posture, motor activity, social manner, attitude and rapport towards the examiner.
 - ii. *Speech*: Its volume, tone, rate, quantity, flow and rhythm.
 - iii. *Affect and mood*
 - **Affect** is the subjective and immediate experience of emotion attached to ideas or mental representations of objects. Quality, range, depth or intensity and appropriateness of affect are assessed.
 - **Mood** is pervasive and sustained feeling tone that is experienced internally and that can markedly influence all aspects of a person's behavior and perception of the world. Quality, stability, reactivity and persistence of mood are assessed.
 - iv. *Thought*: Stream, form, content and possession of thought is assessed. There can be thought insertion, latency, broadcasting or withdrawal.
 - v. *Perception*: Mental process by which all kinds of data—intellectual, emotional and sensory are meaningfully organized.

Differentiation 29.3: True and feigned insanity

S.No.	Feature	True insanity	Feigned insanity
1.	Onset	Gradual	Sudden
2.	Motive	Absent	Present, e.g. commission of crime
3.	Predisposing factors	Usually present, like history of insanity in parents	Absent
4.	Signs and symptoms	Uniform, specific for some type of insanity	Not directed to any particular type of insanity
5.	Activity	Careless, present whether the patient is being observed or not	Present only when conscious of being observed; variable and always exaggerated
6.	Mood	Excited, depressed or fluctuating	May overact to show abnormality in mood
7.	Facial expression	Peculiar vacant/agitated/worried look	No peculiarity; frequently changing, exaggerated and voluntary
8.	Insomnia	Present	Cannot persist, patient sleeps soundly after a day or two
9.	Exertion	Can withstand exertion of fatigue, hunger and sleep for several days	Cannot stand exertion for few days and breaks down
10.	Habits	Dirty and filthy	Not dirty and filthy
11.	Dressing up	Carelessly dressed	Dressed reasonably properly
12.	Skin and lips	Dry, harsh and dirty	Normal
13.	Tongue	Coated	Clean
14.	Repeated examination	Does not mind	Resents for fear of detection

Perception is assessed by presence or absence of hallucinations, illusions, depersonalization/derealization and somatic passivity phenomenon.

vi. **Cognition (neuropsychiatric)/higher mental function assessment:** Mental process of knowing and becoming aware and is closely associated with judgment. It is assessed under:

- **Consciousness:** State of awareness, with response to external stimuli. Grading the level of consciousness is done.
- **Orientation:** State of awareness of oneself and one's surrounding. Whether he is well oriented in time, place and to person is noted.
- **Attention:** Patient is asked to repeat digits forwards and backwards.
- **Concentration:** Simple test, like counting backwards from 20 is given.
- **Memory:** Process whereby what is experienced or learned is established as a record in the CNS. It can be immediate retention, recall or remote.
- **Intelligence:** Capacity to learn and ability to recall, to integrate constructively and to apply what one has learnt. Tests for reading, writing and calculation are given depending on patient's educational background.
- **Abstract thinking:** Thinking characterized by the ability to grasp the essentials of a whole (situation or concept), to break a whole into its parts and to discern common properties.

vii. **Insight:** Conscious recognition of one's own condition. Attitude towards the illness, its causation and need for treatment is assessed.

viii. **Judgment:** Ability to assess a situation correctly and act appropriately within that situation. Both social (assessed during the interview) and test (certain situation is given, like house on fire) judgments are assessed.

Classification of Mental and Behavioral Disorders (ICD-10)

At present there are two major classification—ICD-10 (1992) and DSM-IV-TR (2000). ICD-10 is easy to follow and has been tested extensively. The disorders are classified into following categories as given in Table 29.1.

Organic Mental Disorders

These disorders are associated with transient or permanent brain dysfunction and include those with demonstrable cerebral disease which may be either primary brain pathology or secondary to systemic diseases. It can be:

- i. Delirium
- ii. Dementia
- iii. Organic amnestic syndrome.

Delirium

Definition: Acute reversible mental disorder characterized by confusion and impairment of consciousness;

Table 29.1: Classification of mental and behavioral disorders

S.No.	Classification	Types
1.	Organic mental disorders	Delirium, dementia, organic amnestic syndrome
2.	Psychoactive substance use disorders	Acute intoxication, harmful use, dependence syndrome, withdrawal state, amnestic syndrome
3.	Schizophrenia and delusional disorders	Schizophrenia, schizotypal disorder, persistent delusional disorder, acute and transient psychotic disorder, schizo-affective disorder
4.	Mood disorders	Manic, depressive, bipolar affective, recurrent depressive and persistent mood disorders
5.	Neurotic and somatoform disorders	Anxiety, phobic, obsessive compulsive, dissociative, reaction to stress and adjustment disorders
6.	Behavioral syndromes (earlier psychosomatic disorders)	Eating disorders, non-organic sleep disorders, sexual dysfunctions; disorders associated with puerperium
7.	Adult personality and behavior disorders	Personality, habit and impulse disorders, gender-identity disorders; disorders of sexual preference and orientation
8.	Mental retardation	Mild, moderate severe and profound mental retardation
9.	Disorders of psychological development	Speech, language, scholastic skills and motor function disorders; and pervasive developmental disorders
10.	Behavioral and emotional disorders in children	Hyperkinetic, conduct and tic disorders
11.	Unspecified mental disorders	

disorientation (most commonly in time), emotional lability, hallucination, or illusion and inappropriate, impulsive, irrational or violent behavior.²⁰⁻²⁵

- It usually occurs in physical diseases, in which there is continuous high temperature or due to overwork, mental stress, acute poisoning (dhatara), chronic alcoholics or drug intoxication.²⁵
- Commonest organic disorder (5-15%).
- A delirious person may become impulsive and violent and may commit suicide. Such person is not responsible for his criminal acts.

Dementia

It is characterized by:²⁶⁻²⁸

- Impairment in intellectual functioning
- Disturbance of orientation (late)
- Failing memory
- Reduced facility with language
- Alterations in mood and affect
- Impaired judgment and abstraction
- Distractibility
- No impairment of consciousness

Usually irreversible and impairment of all functions occurs globally, causing interference of day-to-day activities and interpersonal relationships. The sufferer may lead a vegetative life. At some phase, the person may become agitated, aggressive and violent.

Sometimes, the syndromes of delirium and dementia may overlap; differentiating features are given in Diff. 29.4.

Organic amnestic syndrome

Impairment of memory due to underlying organic cause with no disturbance of consciousness and no disturbance of intellectual function or personality.

Psychoactive Substance use Disorders

Psychoactive substance is one that is capable of altering the mental functioning. Major dependence producing drugs are: alcohol, opioids, cannabis, cocaine, amphetamine, hallucinogens (LSD, phencyclidine), barbiturates, nicotine, inhalants and caffeine.

Four patterns of drug use disorders are observed:

- Acute intoxication
- Dependence syndrome
- Withdrawal state
- Harmful use

Details are given in Chapter 61.

Schizophrenia

Major non-organic psychotic disorders are schizophrenia and mood disorders.

Schizophrenia is characterized by:²⁹⁻³⁸

- Thought and speech disorders (hallmark feature)**
 - **Autistic thinking:** Thoughts are narcissistic (all source of pleasure are recognized as coming from within self), egocentric (self-centered, lacking interest in others) and without regard for reality.
 - **Thought blocking** (sudden interruption of stream of speech before the thought is completed) to loosening of association and incoherence.

Differentiation 29.4: Delirium and dementia

S.No.	Feature	Delirium	Dementia
1.	Onset	Acute	Insidious
2.	Course	Recovery in 1 week-1 month	Protracted
<i>Clinical features</i>			
3.	Consciousness	Clouded	Normal
4.	Orientation	Grossly disturbed	Normal, disturbed in late stages
5.	Memory	Immediate retention and recall disturbed	Normal
6.	Comprehension	Impaired	Impaired only in late stages
7.	Sleep-wake cycle	Grossly disturbed	Normal
8.	Attention and concentration	Grossly disturbed	Normal
9.	Diurnal variation	Marked	Absent
10.	Perception	Illusions and hallucinations are common	Hallucinations may occur

- **Neologisms:** New word or phrase whose derivation cannot be understood (headshoe for hat).
- **Delusions** (persecution, reference, grandeur, influence and hypochondriacal are common), *mutism* (absence of the faculty of speech), *poverty of speech* (restriction of amount of speech), *echolalia* (repeating of words or phrases of the examiner), *perseveration* (persistent repetition of specific words or concepts in speech),³⁹ *verbigeration* (meaningless or stereotype repetition of words or phrases) are other features of schizophrenia.
- ii. **Disorders of perception:** Hallucinations (commonest—auditory) are frequent. Visual hallucination can also occur, usually along with auditory hallucinations.
- iii. **Disorders of affect** includes apathy, emotional blunting, *anhedonia* (loss of interest in and withdrawal from all regular and pleasurable activities),^{40,41} and inappropriate emotion.
- iv. **Disorders of motor behavior:** There may be decrease (inertia or stupor) or increase (excitement, restlessness or agitation) in psychomotor activity. *Stereotypy* (continuous mechanical repetition of speech or physical activity) and grimacing are seen in catatonic schizophrenia.
- v. **Negative symptoms** include attention impairment, anhedonia, alogia (inability to speak) and affective flattening.⁴²

Types of Schizophrenia

- i. **Simple:** Early onset and insidious, difficult to diagnose and poor prognosis. There is gradual deterioration of the condition and presence of characteristic '*negative symptoms*'. Delusion and hallucination are usually absent.
- ii. **Disorganized/hebephrenic:** Onset is insidious with worst prognosis and usually seen in early 2nd decade;⁴³ characterized by wild or silly behavior or *mannerisms* (constant repetition of a trick of gesture or speech), inappropriate affect, 'mirror-gazing', poor self-care and hygiene, markedly impaired social and occupational functioning, extreme social withdrawal, delusions and auditory hallucinations that are transient and unsystematized.
- iii. **Catatonic** (*cata:* disturbed, *tonic:* tone): Onset is acute and in adolescent age or early adulthood. There is disturbance in motor functions with extreme alteration of behavior from stupor (catatonic stupor) to excitement (catatonic excitement). Automatic obedience, negativism and postures for long periods may be seen.^{44,45}

- iv. **Paranoid:** Onset is late, features include delusions (grandeur, reference, persecution or infidelity, auditory hallucinations, but no prominent disturbance of affect, speech and motor behavior).⁴⁶
- v. **Residual and latent:** In addition to other features of schizophrenia, prominent negative symptoms are present with past one episode of psychotic attack.
- vi. **Undifferentiated:** Very common, general criteria of schizophrenia present, but does not fit into any type or mixed features are present.
- vii. **Post-schizophrenic depression:** Depression occurring within 1 year of an acute attack of schizophrenia; increased risk of suicide is present.
 - Prognosis is best with acute onset.⁴⁷
 - Common age group affected is late adolescence and early second decade.

- The term 'schizophrenia' (Greek *schizo:* split, *phren:* mind) was coined by *Eugene Bleuler* (1911) to refer to the lack of interaction between thought processes and perception.⁴⁸ Bleuler described the *fundamental symptoms* of schizophrenia as 4 A's—Ambivalence, Autism, Affect disturbances and Association disturbances.⁴⁹
- Despite its etymology, schizophrenia is not synonymous with dissociative identity disorder, also known as multiple personality disorder or '*split personality*'; the two are often confused and misunderstood.
- **First rank symptoms** were given by *Kurt Schneider* for diagnosis of schizophrenia.⁵⁰ It includes:⁵¹
 - i. Thought echo
 - ii. Thought broadcasting
 - iii. Somatic passivity
 - iv. Thought withdrawal
 - v. Voices heard arguing
 - vi. Delusional perception
 - vii. Thought insertion
 - viii. Voices commenting on one's action
 - ix. 'Made' feelings, impulses and acts

- Recently, schizophrenia has been categorized into two types:
- i. **Type I or positive schizophrenia:** Acute onset of positive symptoms—hallucinations, delusions, bizarre behavior and confused thinking.
 - The patient functioned well before appearance of symptoms and responds to anti-psychotic drugs. During clarity, social behavior is reasonably intact.
 - It is believed to be due to problems in dopamine neurotransmission.
 - ii. **Type II or negative schizophrenia:** Negative symptoms—poverty of speech, emotional unresponsiveness, seclusiveness and impaired attention are predominant.

- Usually, they have a poor history of social and educational functioning prior to onset and are unresponsive to antipsychotic drugs.
- It is believed to be due to structural brain abnormalities, but CT is usually normal.⁵²

Mood (Affective) Disorders⁵³

Mood disorders are classified as:

- Manic episode:** Symptoms should last for at least 1 week for its diagnosis (usually last 3-4 months) and cause disruption in social and occupational activities.⁵⁴

It is characterized by:⁵⁵

- *Elevated or irritable mood:* Usually pass through 4 stages—euphoria (exaggerated sense of wellbeing), elation, exaltation and ecstasy. Sometimes, irritable mood may predominant.
 - *Psychomotor activity:* Increased psychomotor activity (overactiveness, restlessness and excitement).
 - *Speech and thought:* More talkative (joking, teasing or rhyming), flight of ideas (rapid speech with shift in topics), delusions (grandeur) and distractable.⁵⁶
 - *Goal-directed activity:* Patient is unusually alert and try to do many things at one time.
 - *Other features:* Insomnia and increase appetite may be present. Insight is absent (in mania).
- In **hypomania** (mood abnormality of lesser intensity than mania), ability to perform becomes better and there is marked increase in productivity and creativity.
 - In **mania**, there is striking increase in activity and execution of multiple activities with distractibility and decrease in functioning ability. Patient may become hypersexual, impulsive, drive recklessly and be involved in buying sprees.

- Depressive episode:** Lifetime risk of depression is more in middle-aged females.

It is characterized by following features (should last for at least 2 weeks for its diagnosis):⁵⁷

- *Depressed mood:* Sadness of mood or loss of interest in all activities and throughout the day which results in social withdrawal, impaired occupational activity and interpersonal relationship.
- *Depressive ideation/cognition:* Patient becomes pessimistic and feels hopeless, helpless and worthless. He may have guilt feelings, indecisiveness, poor memory, lack of initiation and suicidal ideation.

- *Psychomotor activity:* In young patients (< 40 years), retardation is seen (decreased energy, slowed thinking and stuporous), but in older patients, agitation is common (hand-wriggling or inability to sit still). Anxiety, irritability and frustration are common.
 - *Physical symptoms:* Headache, heaviness of head, bodyache, easy fatigability and decreased energy are common.
 - *Disturbance of biological functions:* Insomnia, loss of appetite and weight, and loss of sexual drive.
 - *Psychotic features:* Delusions (nihilistic, poverty or guilt), hallucinations, inappropriate behavior and stupor may be seen.^{58,59}
- Bipolar mood disorder:** Earlier called *manic depressive psychosis* (MDP), it is characterized by recurrent episodes of mania and depression in the same patient at different times with period of normalcy in between the episodes.⁶⁰
 - Recurrent depressive disorder:** It is characterized by recurrent (at least two) depressive episodes (unipolar depression).
 - Persistent mood disorder:** It is characterized by persistent mood symptoms which last for 2 years (1 year in children and adolescents), but not severe enough to be called hypomania/mild depression.

Involuntional melancholia: It is a form of severe depression which occurs during involuntional period (40-65 years of age). It is characterized by agitation, hallucinations (auditory or tactile) and delusions (persecution or hypochondrial).

Other Psychotic Disorders

Delusional disorder (earlier *paranoid disorder*) is characterized by persistent delusions (persecution, grandeur, jealousy, hypochondriacal or erotomanic) which are more prominent and most important clinical feature and present for at least 3 months without any significant hallucinations, organic mental disorder, schizophrenia and mood disorders.

Neurotic and Somatoform Disorders

- Anxiety disorder:** It is the commonest symptom and commonest disorder in psychiatry. Anxiety is normal and defined as feeling of apprehension caused by anticipation of danger. It becomes pathological when it causes significant distress and impairment in functioning of the person.

The symptoms are:

- **Physical:** Restlessness, tremors, muscle twitchings, palpitations, sweating, dyspnea, dry mouth, diarrhea and dizziness.
- **Psychological:** Apprehension, fearfulness, insomnia, irritability, depersonalization and poor concentration. *The symptoms of anxiety can be classified into two groups:*

- a. **Generalized anxiety disorder:** Insidious onset in the third decade, usually chronic which may or may not be punctuated by repeated panic attacks (episodes of acute anxiety).
- b. **Panic disorder:** It is characterized by discrete episodes of acute anxiety; onset is usually in third decade, seen more often in females. The symptoms usually sudden in onset, unexpected or out-of-the-blue, last for few minutes and characterized by very severe anxiety.⁶¹
- ii. **Phobic disorder:** Persistent, pathological, unrealistic and intense fear of an object or situation. The phobic person (usually seen in women) may realize that the fear is irrational (insight present) but, nonetheless, cannot dispel it.⁶²

Types of phobia

- a. **Agoraphobia:** Morbid fear of open places, public places, crowded places or leaving the familiar setting of the home. It may be present with or without panic attacks; commonest type of phobia and common in women.⁶³⁻⁶⁵
- b. **Social phobia:** Irrational fear of social activities and interaction. For example, abnormal fear of blushing (*erythrophobia*), public speaking, stage performance or speaking to authority figures.
- c. **Specific (simple) phobia:** Irrational fear of a specified object or situation. For example, dread of high places (**acrophobia**);⁶⁶ abnormal fear of closed or confining spaces (**claustrophobia**); persistent, intense fear of receiving an injection (**needle phobia**); dread of pain (**algophobia**); abnormal fear of strangers (**xenophobia**); and abnormal fear of animals (**zoophobia**).
- iii. **Obsessive-compulsive disorder (OCD):** It can be predominantly obsessive thoughts or compulsive acts or mixed. Depression is common, and insight is present.^{67,68}
There are:⁶⁹
 - a. **Washers:** Commonest type; obsession is of contamination and compulsion is washing of hands or body, repeated many times in a day.⁷⁰
 - b. **Checkers:** Patient has multiple doubts (whether door has been locked or proper counting of money) and

compulsion is checking repeatedly to remove doubt.

- c. **Pure obsessions:** This is characterized by repetitive intrusive thoughts (usually sexual or aggressive in nature), impulses or images which are not associated with compulsive acts.
- d. **Primary obsessive slowness:** It is characterized by severe obsessive ideas and/or extensive compulsive rituals in the relative absence of manifested anxiety which leads to marked slowness of daily activities.
- iv. **Dissociative and conversion disorder:** *Hysteria* comprises of conversion, dissociation and somatization components.
 - a. **Conversion disorder:** It is characterized by sudden onset of deficits, affecting motor (paralysis or abnormal movements) and sensory functions (blindness, deafness, tubular vision and 'glove and stocking' anesthesia), and dissociative convulsions (hysterical fits—convulsive movements and partial loss of consciousness).
 - b. **Dissociative disorder:** It is characterized by sudden onset with:
 - **Dissociative amnesia:** Inability (total or partial) to recall past experiences, usually following traumatic or stressful event.
 - **Fugue:** It is characterized by a period of almost complete amnesia during which a person actually flees from an immediate life situation (usually from home) and begins a different life pattern.⁷¹
 - **Dissociative identity (Multiple personality disorder):** Patient is dominated by two or more personalities and one is manifest at a time and the other is not aware of its existence.
 - v. **Somatoform disorders:** It is characterized by repeated physical symptoms (abdominal pain, nausea, vomiting, numbness, itching, tingling, dysmenorrhea or dyspareunia) which do not have adequate physical basis and not explained by the presence of other psychiatric disorders.
It includes somatization disorder (multiple somatic symptoms in the absence of any physical disorder), hypochondriasis (fear or belief of having a serious disease based on patient's own interpretation of normal body function).^{72,73}
 - vi. **Other neurotic disorders** include *neurasthenia* (persistent complaints of fatigue after mental effort, bodily weakness, exhaustion, muscular aches, sleep disturbances, irritability and tension headaches).
 - vii. **Reaction to stress and adjustment disorders** include acute stress reaction (characterized by anxiety,

depression, anger, despair and constriction of the field of consciousness), post-traumatic stress disorders (PTSD) and adjustment disorders.

Behavioral Syndromes

It includes eating disorders, non-organic sleep disorders and sexual dysfunctions and behavioral disorders associated with peripartum.

1. **Eating disorders** include:

- i. *Anorexia nervosa*: Intense fear of becoming obese. Appetite may be preserved, but the patient refuses to eat.
- ii. *Bulimia nervosa*: Similar to anorexia nervosa, except there are episodes of overeating with attempts to counteract it by vomiting or purgatives.
- iii. *Binge eating disorders*: Large amount of food is consumed in short period, followed by severe discomfort.

2. **Postpartum psychiatric disorders** include 'postnatal blues' (mild depression and irritability) and postpartum psychosis (severe psychiatric symptoms including depressive episode, schizophrenia, manic episode or delirium).

3. **Sleep disorders**: It is classified into dysomnias and parasomnias.

A. *Dysomnias can be*:

- i. **Insomnia**: Difficulty in falling asleep or difficulty in staying asleep and includes frequent awakenings during night and early morning awakening.
- ii. **Hypersomnia**: Excessive time spent asleep. It can be:
 - a. Excessive daytime sleepiness.
 - b. 'Sleep attacks' during daytime (falling asleep unintentionally).
 - c. *Somnolentia or semisomnolence*: It is the condition when a person is in between sleep and wakefulness. The person needs much more time to awaken and during this period he is confused or disoriented. This is often termed as **sleep-drunkenness**.

When suddenly awoken from a deep sleep, such person may perform some violent act without awareness and understanding. He is not responsible for any criminal act performed by him during such a state of mind.

- **Narcolepsy**: Common cause of hypersomnia; characterized by excessive daytime sleepiness, often diminished night-time sleep and dis-

turbances in REM sleep. Hallmark is decreased REM latency.

The classical tetrad of symptoms are:⁷⁴

- i. *Sleep attacks* (most common) from which he awakens refreshed and can occur at any time of day, even while driving.
- ii. *Cataplexy*: Temporary sudden loss of muscle tone causing weakness and immobilization which may result in a fall.⁷⁵
- iii. *Hypnagogic hallucinations*: Vivid perceptions, usually dream-like which occur at the onset of sleep (if occurring at awakening—hypnopompic hallucinations) and associated with fearfulness.
- iv. *Sleep paralysis* (least common) usually occurs at awakening in morning. The individual is conscious but unable to move his body for 30 secs to few minutes.

B. **Parasomnias**: Dysfunctions and episodic nocturnal events occurring during sleep, sleep stages or partial arousals. It can be **stage IV sleep disorders** occurring during deep sleep (stage III and IV of NREM sleep).

Common parasomnias are:

- i. **Somnambulism (sleep walking)**: The patient walks during sleep and carries out automatic motor activity. He may get up from the bed, open the door, walk out a distance and return to his bed to sleep again, and remember nothing on awakening. During the whole episode, the subject is in a state of dissociated consciousness and arousal is difficult.

If, in a fit of somnambulistic automatism, a person commits a criminal act, he will not be held responsible for the same.

- ii. **Somniloquy (sleep-talking)**: Patient talks during this stage, but does not remember about it in the morning on awakening.
- iii. **Bruxism (tooth-grinding)**: Patients forcefully and involuntarily grind teeth during this phase and are unaware of it on awakening.
- iv. **Sleep-terrors (pavor nocturnus)**: Patient gets up screaming with tachycardia, sweating and hyperventilation, but rarely recalls anything in the morning.

Mental Retardation

Subaverage general intellectual functioning that originates in the developmental period and is associated with impaired maturation, learning and social

maladjustment. Retardation is commonly defined in terms of IQ.

Retardation can be:

- i. **Mild (IQ: 50-70):** Commonest type, 85-90% of all cases, can achieve vocational and social self-sufficiency with little support.
- ii. **Moderate (IQ: 35-50):** 10% of all cases, can learn to speak, drop out of school after 2nd grade, can be trained to perform semi-skilled or unskilled work under supervision.
- iii. **Severe (IQ: 20-35):** Recognized early in life with poor motor development (delayed milestones) and absent speech. Later in life, elementary training in personal health care can be given and taught to talk.
- iv. **Profound (IQ: < 20):** 1-2% of cases, developmental milestones markedly delayed, associated physical disorders are present and often need nursing care or life-support.

Disorders of Adult Personality and Behavior

It includes specific personality disorder, habit and impulse disorders, disorder of sexual preference and behavioral disorder associated with sexual development and orientation.

Disorders of Psychological Development

It includes disorders of speech and language, and developmental disorders of motor function, scholastic skills, etc.

Behavioral and Emotional Disorders in Childhood and Adolescence

It includes hyperkinetic disorders, conduct disorders and tic disorders (characterized by involuntary, spasmodic, stereotyped movement of small groups of muscles).

Mental Disorder and Responsibility

Responsibility, in the legal sense, means the liability of a person for his acts or omissions, and if these are against the law, the liability to be punished for them. *The law presumes that every person is mentally sound, until the opposite is proved.*

Civil Responsibility

The question of civil responsibility arises in the following conditions:

- i. **Management of property:** The court may appoint a guardian to take care of the mentally ill and may appoint a manager to manage the property. The

court may order the sale of the mentally ill person's property for the payment of his debts and expenses. Only persons competent to contract are authorized to transfer property.

- ii. **Contracts:** A contract is invalid, if one of the parties at the time of making it was, by reason of mental illness, incapable of understanding it and forming a rational judgment as to its effect upon his interests. However, a mentally ill person is liable for contracts entered into during lucid intervals.
- iii. **Marriage and divorce:** As per *Hindu Marriage Act*, marriage can be declared null and void, if one of the parties, at the time of ceremony, was incapable of giving valid consent or was unfit for marriage due to unsoundness of mind. As per *Muslim Marriages Act*, a woman can obtain a divorce on ground of husband's insanity within 2 years of marriage, but a man can get divorce by pronouncing '*talak*' at any time, without assigning any reason.
- iv. **Adoption:** Under *Hindu Adoption and Maintenance Act*, taking/giving adoption of a child is not allowed, if either of the parents is mentally ill.
- v. **Competency as a witness:** Under Sec. 118 IEA, a mentally ill person is not competent to give evidence, if he is prevented by his illness from understanding the questions put to him and giving rational answers to them.
- vi. **Validity of consent:** The consent given by an insane or intoxicated person, who is unable to understand the nature and consequences of that to which he gives his consent is invalid (Sec. 90 IPC).
- vii. **Testamentary capacity:** This means the capacity of a person to make a valid will.⁷⁶ The law defines it as the possession of a sound disposing mind (*compos mentis*) which must be certified by a doctor.

Holograph will: Will written by the testator in his own handwriting.

Valid will must fulfill the following conditions:

- The testator must be a major, should understand the nature of the will, have knowledge of the property to be disposed and the ability to recognize those who have justifiable claims on his property.
- It should be executed voluntarily without any undue influence of any person.
- The testator must sign it in presence of two witnesses.
- Will is valid under special circumstances
 - a. Made by deaf, dumb or blind persons
 - b. Made during lucid intervals of mental illness
 - c. Suicide by testator immediately after making the will, in the absence of any mental illness

- Will is invalid when made by imbecile or drunk persons or under insane delusions, because the test-ator was incapable of rational views and judgment.

Criminal Responsibility

Sec. 84 IPC deals with the criminal responsibility of insane persons.⁷⁷

It states that:

"Nothing is an offence which is done by a person who, at the time of doing it, by reason of unsoundness of mind, is incapable of knowing the nature of the act, or what he is doing is either wrong or contrary to the law".

There is minor a difference between Sec. 84 IPC and the McNaughten's rule, which is the guideline followed in British Courts for consideration of the liability of a mentally ill person who commits a crime.^{78,79}

McNaughten rule(s): In 1843, Mr. Edward Drummond, the private secretary of the then Prime Minister of England, Sir Robert Peel, was shot dead by a young Scotsman Daniel McNaughten. McNaughten was suffering from delusion of persecution and believed that his life was in danger due to the acts of persecution by the Tory Party on him. He shot dead Mr. Drummond on the belief that he was going to kill the Tory Party Prime Minister Mr. Peel. It was established that McNaughten suffered from paranoid delusions and was acquitted on the ground of insanity. Upon this development, the Supreme Court Judges of UK were summoned by the House of Lords to know the position of the law of England regarding crime and insanity. From the answers given by them, rules were framed for criminal responsibility of the insane, and they have been named after McNaughten.

The most important and relevant part of the McNaughten rules states: 'Every man is to be presumed to be sane, and to possess a sufficient degree of reason to be responsible for his crimes, until the contrary be proved; and that to establish a defense on the ground of insanity, it must be clearly proved that at the time of committing the act, the party accused was laboring under such a defect of reason from disease of the mind, so as not to know the nature and quality of the act he was doing, or if he did know it, that he did not know that what he was doing was wrong'.

These rules are given the status of 'legal test' for insanity.

The Legal test of Insanity (The 'Right or Wrong' test)

Under this test, a person was not criminally responsible, *if at the time of the crime, he did not know the nature of the act or that it was wrong.* It excludes responsibility of the

insane for the commission of crime, and has the following requirements:

- There should be evidence of mental disease.
- This mental disease or defect must exist at the time of commission of crime.
- It should be of such degree that the person is unable to understand that the act is wrong and/or contrary to the law.

Comments

- The insanity must be directly related to the offence in such a way as to satisfy the court that the mental abnormality had a direct causative relationship to the offence and that the offence would not have occurred, if there was no mental abnormality.
- The law recognizes as 'abnormality of the mind' as any disease which is capable of producing mental dysfunction. The law is not concerned with the brain, but with the mind, as the term means reason, memory and understanding. However, when mental dysfunction is attributable to external factors (e.g. alcohol and drugs consumed voluntarily), this is not called as the abnormality of the mind. It is usually assumed to mean one of the major functional or organic psychoses.
- It must be clearly established that the reasoning powers of the accused were not functioning normally due to defect in intellectual and cognitive faculties.
- The rule concerns itself with the ability of the accused to distinguish between 'right' and 'wrong' with reference to the particular crime. If at the time of the commission of the crime, the accused had the capacity to know that his act was wrong, he will be fully responsible, even if he was mentally ill and unable to refrain from doing the act at that time. If a person commits a crime under the influence of an insane delusion, he is judged as though the delusionary facts were real.

Examples

- If under the influence of an insane delusion, a person thinks another man is attempting to kill him and he kills that man in self-defense, he will not be held criminally responsible.
 - If under the influence of an insane delusion, a person thinks another man to be a wild animal and kills him, he will not be held criminally responsible.
 - If under an insane delusion, a person thinks that another person has caused serious injury to his character, family or property and kills him, he becomes responsible because under the law, no one can kill a person in revenge.
- The defect of McNaughten rule is that, from deciding that a person is insane, only cognitive (intellectual)

faculties are taken into consideration, whereas emotional factors, hallucinations and the ability of the individual to control the impulse (resistible impulse) are not considered.

To assess the criminal responsibility of insane persons, certain other rules have come into use in subsequent periods in different countries at different times.

- **Durham's rule** (1954): An accused person is not criminally responsible, if his unlawful act is the product of mental disease or mental defect.⁷⁹
- **Curren's rule** (1964): This rule states that an accused person is not criminally responsible, if at the time of committing the act, he did not have the capacity to regulate his conduct to the requirements of the law as a result of mental disease or defect.
- **American Law Institute test** (1970): A person is not responsible for criminal conduct, if at the time of such conduct as a result of mental disease or defect, the person lacked adequate capacity either to appreciate the wrongfulness of his conduct or to conform his conduct to the requirements of law.
- **The Brawner rule** (1972) argues that insanity should be decided by a jury. Under this proposal, juries are allowed to decide the 'insanity question' as they see fit.
- **The Irresistible Impulse:** It argues that a person may have known an act was illegal, but because of a mental impairment, he couldn't control his actions. In 1994, *Lorena Bobbitt* was found not guilty of a crime, when her defense argued that an irresistible impulse led her to cut off her husband's penis.

Procedure of examination of a mentally ill person (Secs. 328 & 329 CrPC)

- If during trial, the Magistrate finds the accused to be of unsound mind and incapable of making his defense, then he should order such person to be examined by the civil surgeon or any medical officer as the State Government may direct, and postpone further proceedings in the case.
- If the civil surgeon finds the accused to be of unsound mind, he should refer such person to a psychiatrist/clinical psychologist for treatment and prognosis of the condition and should inform the Magistrate regarding the same.
- If the accused is aggrieved by the report given to the Magistrate, he can make an appeal before the Medical Board consisting of:
 - i. Head of psychiatry unit in the nearest government hospital; and
 - ii. A faculty member in psychiatry in the nearest medical college.

Release of person of unsound mind pending investigation or trial (Sec. 330 CrPC):

On the basis of medical opinion, whenever a person is found incapable of entering defense by reason of unsoundness of mind or mental retardation, the Magistrate may decide to order release of such person on bail or kept in such a place where regular psychiatric treatment can be provided.

Resumption of trial/inquiry (Sec. 331 CrPC): Whenever a trial is postponed under Sec. 328 or 329, the Magistrate may resume it at any time after the person concerned has ceased to be of unsound mind.

MULTIPLE CHOICE QUESTIONS

1. **False but firm belief about something which is not a fact:** *WB 10; MP 11*
 - A. Illusion
 - B. Delusion
 - C. Hallucination
 - D. Obsession
2. **Delusion is a disorder of:** *AI 07; AIIMS 06; Gujarat 07; MP 11*
 - A. Thought
 - B. Perception
 - C. Insight
 - D. Cognition
3. **Delusion of grandiosity is commonly seen in:** *PGI 11*
 - A. Schizophrenia
 - B. Depression
 - C. Mania
 - D. Dementia
4. **A 25-year-old university student had a fight with the neighboring boy. Next day, he started feeling that two men in police uniform were observing his movements and would arrest him. His symptoms represent:** *AIIMS 03*
 - A. Delusion of persecution
 - B. Ideas of reference
 - C. Passivity
 - D. Thought insertion
5. **A 35-year-old male, with pre-morbid anxious traits and heavy smoker, believes that he has been suffering from 'lung carcinoma' for a year. No significant clinical finding is detected on examination and relevant investigations. He continues to stick to his belief despite evidence to the contrary. He is most likely suffering from:** *AIIMS 04*
 - A. Carcinoma lung
 - B. Nihilistic delusion
 - C. Hypochondriacal delusion
 - D. Malingering

6. **Depressive delusions that the world and everything related to it cease to exist is called:** *COMEDK 07; NIMHANS 11*
 A. Persecutory delusion
 B. Delusion of infidelity
 C. Nihilistic delusion
 D. Delusion of reference
7. **A 30-year-old unmarried woman of average socioeconomic background believes that her boss is secretly in love with her. She holds this belief, despite contradiction from her family members and his denial. She is most likely to be suffering from:** *AIIMS 04*
 A. Depression
 B. Schizophrenia
 C. Delusional disorder
 D. No psychiatric ailment
8. **False perception without any external stimulus is:** *AIIMS 03, 06; Kerala 08, 09*
 A. Illusion
 B. Hallucination
 C. Delirium
 D. Delusion
9. **Hallucination is disorder of:** *Maharashtra 09*
 A. Perception
 B. Thought
 C. Memory
 D. Intelligence
10. **A mentally ill person smells unpleasant odor when none is present. This is an e.g. of:** *COMEDK 07*
 A. Illusion
 B. Delusion
 C. Obsession
 D. Hallucination
11. **Olfactory hallucinations are seen in:** *PGI 11*
 A. Temporal lobe epilepsy
 B. Schizophrenia
 C. Mania
 D. OCD
12. **All are true regarding hallucinations, except:** *AIIMS 09*
 A. Represents a state of inner mind's spatial orientation
 B. Independent of the observer
 C. Under voluntary control
 D. Perception which occurs in the absence of stimulus
13. **Illusion is:** *AIIMS 07*
 A. Misinterpretation of real objects
 B. False firm belief
 C. Absence of sensory stimulus
 D. Hearing of voices
14. **Kleptomania means:** *UP 08*
 A. Irresistible desire to steal things
 B. Irresistible desire to drink
 C. Irresistible desire to dress like opposite sex
 D. Irresistible desire to set fire things
15. **Kleptomania/pyromania is a:** *PGI 07, 11; AP 09*
 A. Conduct disorder
 B. Impulse disorder
 C. Personality disorder
 D. Conversion disorder
16. **Excessive buying is termed as:** *DNB 08*
 A. Kleptomania
 B. Oniomania
 C. Trichotillomania
 D. Pyromania
17. **Compulsive hair pulling that produces bald spots is called:** *Orissa 11*
 A. Trichotillomania
 B. Kleptomania
 C. Pyromania
 D. Diposomania
18. **Obsession is a disorder of:** *MP 09*
 A. Perception
 B. Thinking
 C. Memory
 D. Judgment
19. **Statement which differentiates the obsessional idea from delusions:** *AIIMS 05*
 A. The idea is not a conventional belief
 B. The idea is held in spite of contrary evidence
 C. The idea is regarded as senseless by the patient
 D. The idea is held on inadequate ground
20. **Psychosis is NOT associated with:** *DNB 08; TN 08*
 A. Delusion
 B. Depression
 C. Phobia
 D. Mania
21. **Abreaction is:** *TN 05*
 A. Test for detecting injury due to electric shock
 B. Test for detecting injury due to lightning
 C. Test for detecting injury due to laser beam
 D. Reviving and bringing into consciousness, forgotten traumatic experiences from unconscious level by catharsis
22. **Delirium is a disorder of:** *UP 08*
 A. Thought
 B. Perception
 C. Insight
 D. Cognition
23. **Fluctuating level of consciousness is seen in:** *Karnataka 04*
 A. Hysteria
 B. Delirium
 C. Dementia
 D. Mania
24. **Visual hallucinations are most commonly seen in:** *PGI 09; FMGE 11*
 A. Delusional syndrome
 B. Delirium
 C. Mania
 D. OCD
25. **A 20-year-old boy presented with fever along with hearing of voices, aggressive behavior, muttering to self since 2 days. Diagnosis is:** *AIIMS 10*
 A. Dementia
 B. Acute psychosis
 C. Delirium
 D. Delusional disorder
26. **NOT a feature of dementics:** *WB 09*
 A. Loss of sensorium
 B. Wearing of dirty clothes
 C. Forgetfulness
 D. Loss of neurons in brain matter

6. C	7. C	8. B	9. A	10. D	11. A & B	12. C	13. A	14. A
15. B	16. B	17. A	18. B	19. C	20. C	21. D	22. D	23. B
24. B	25. C	26. A						

27. **True about dementia is:** *Karnataka 07*
 A. Alzheimer's disease is due to multiple small strokes in the cerebral cortex
 B. Dementia is the loss of distant memory
 C. Dementia due to atherosclerosis does not progress like Alzheimer's
 D. Alzheimer's disease is associated with an increase in ACh release in the cerebral cortex
28. **Consider the following features:** *UPSC 07*
 i. Impaired judgment
 ii. Impaired memory
 iii. Alteration of mood
 iv. Clouding of consciousness
Which of the above are characteristic of dementia?
 A. i. and ii B. i, ii and iii
 C. iii and iv D. i, ii, iii, iv
29. **Schizophrenia is characterized by all, except:** *PGI 03; Punjab 09*
 A. Elation B. Auditory hallucination
 C. Catatonia D. Delusion
30. **NOT included in schizophrenia:** *AIIMS 07*
 A. Formal thought disorder
 B. Third person hallucination
 C. Mood swings
 D. Persistent depressive disorder
31. **A 23-year-old student is brought to the hospital with history of gradual onset of suspiciousness, muttering and smiling without clear reason, decreased socialization, violent outbursts and lack of interest in studies for 8 months. Mental status examination revealed a blunt affect, thought broadcast, a relatively preserved cognition, impaired judgment and insight. He is likely to be suffering from:** *AIIMS 06; MP 09*
 A. Delusional disorder B. Depression
 C. Schizophrenia D. Anxiety disorder
32. **Mohan, 40 years, has recently started writing books. But the matter in this book could not be understood by anybody, since it contained words which are not there in dictionary and the theme was very disjoint. Likely diagnosis is:** *AP 11*
 A. Mania B. Schizophrenia
 C. Genius writer D. Delusional disorder
33. **Not diagnostic of schizophrenia:** *WB 10*
 A. Disorganized behavior
 B. Suicidal attempt
 C. Delusions
 D. Catatonia
34. **Thought disorder is seen in:** *Karnataka 04*
 A. Obsessive compulsive disorder
 B. Anxiety neurosis
 C. Schizophrenia
 D. Psychopathic personality
35. **Schizophrenia is a disorder of:** *TN 06; Delhi 06; DNB 09; JIPMER 10*
 A. Thought B. Mood
 C. Perception D. Cognition
36. **Neologism is characteristically seen in:** *Gujarat 07*
 A. Depression B. Mania
 C. Schizophrenia D. Delirium
37. **Schizophrenia is characterized by:** *UP 05; Kerala 06*
 A. Delusion and hallucination
 B. Tremor and delusion
 C. Obsession and delusion
 D. Autonomic disturbance
38. **Schizophrenia is characterized by all the following positive symptoms, except:** *Karnataka 03, Kerala 09*
 A. Hallucinations
 B. Delusions
 C. Conceptual disorganization
 D. Anhedonia
39. **Perseveration is:** *AI 05; Maharashtra 08*
 A. Persistent and inappropriate repetition of the same thoughts
 B. Characteristic of depression
 C. Characteristic of schizophrenia
 D. Characteristic of obsessive compulsive disorder
40. **Anhedonia is:** *MP 08*
 A. Abnormal lack of activity
 B. Coexistence of two opposing impulses toward the same thing in the same person
 C. Disturbance in the understanding or expression of language
 D. Inability to experience pleasure from normally pleasurable life events
41. **A 25-year-old woman complains of intense depressed mood for 6 months with inability to enjoy previously pleasurable activities. This symptom is known as:** *AIIMS 05*
 A. Anhedonia B. Avolition
 C. Apathy D. Amotivation
42. **All are negative symptoms of schizophrenia, except:** *NIMHANS 08; UPSC 11*
 A. Anhedonia B. Hallucination
 C. Alogia D. Affective flattening
43. **Which of the following types of schizophrenia carries a bad prognosis:** *UPSC 03*
 A. Paranoid
 B. Catatonic
 C. Hebephrenic
 D. Undifferentiated
44. **Psychomotor symptoms and negativism are associated with which type of schizophrenia:** *Delhi 03*
 A. Hebephrenic B. Catatonic
 C. Paranoid D. Simple

27. B 28. B 29. A 30. D 31. C 32. B 33. B 34. A, C 35. A 36. C
 37. A 38. D 39. A & C 40. D 41. A 42. B 43. C 44. B

45. One of the following is not a feature of catatonic schizophrenia: *UPSC 07; AP 10*
 A. Negativism B. Automatic obedience
 C. Catalepsy D. Cataplexy
46. Delusion of grandeur, persecution and reference is seen in: *PGI 09; UP 11*
 A. Catatonic schizophrenia
 B. Paranoid schizophrenia
 C. Simple schizophrenia
 D. Disorganized schizophrenia
47. Prognosis of schizophrenia is best, if: *Kerala 09, 11*
 A. Acute onset
 B. Insidious onset
 C. Family history is positive
 D. Negative symptoms
48. Term 'schizophrenia' was coined by: *Delhi 03; TN 06; Ranchi 10*
 A. Eugene Bleuler B. Kraepelin
 C. Freud D. Schneider
49. Four A's of schizophrenia was described by: *MP 09*
 A. Kurt Schneider B. Eugene Bleuler
 C. Karl Jaspers D. Emil Krapellin
50. Schneider's first rank symptoms are seen in: *PGI 04*
 A. Delusion B. Hallucination
 C. Schizoid personality D. Schizophrenia
51. All are first rank symptoms of schizophrenia, except: *Delhi 03; TN 06; UPSC 08; Karnataka 11; NIMHANS 11*
 A. Audible thoughts
 B. Thought broadcasting
 C. Voice arguing or discussing or both
 D. Perplexity
52. All are true of type II Schizophrenia, except: *AIIMS 08; Bihar 11*
 A. Negative symptoms more
 B. Disorganization
 C. Abnormal CT
 D. Poor prognosis
53. Mood disorder is: *MP 07*
 A. Psychosis B. Disturbance in affect
 C. Anxiety D. Neurosis
54. Minimum time of diagnosis for manic illness: *DNB 10*
 A. 1 week B. 1 month
 C. 1 year D. 2 years
55. All are features of mania, except: *PGI 03, 06; MP 07; Maharashtra 11*
 A. Flight of ideas B. Psychomotor agitation
 C. Low self-esteem D. Pressure to talk
56. During a manic episode, a patient typically exhibits: *Karnataka 03; FMGE 10*
 A. Delusion of persecution
 B. Low self-esteem
 C. Crying spells
 D. Grandiosity
57. Major depression is diagnosed after minimum of: *Maharashtra 09*
 A. 1 week B. 2 weeks
 C. 3 weeks D. 4 weeks
58. Following delusions are common in depression, except: *TN 05*
 A. Delusion of poverty B. Delusion of nihilism
 C. Delusion of grandeur D. Delusion of persecution
59. Nihilistic ideas are seen in: *PGI 08*
 A. Depression B. Schizophrenia
 C. OCD D. Anxiety disorders
60. Bipolar disorder is a: *TN 11*
 A. Mood disorder
 B. Neurotic disorder
 C. Behavior disorder
 D. Personality disorder
61. A 30 year-old-female presented in the emergency with sudden onset tachycardia and sense of impending dooms. Possible diagnosis is: *AIIMS 10*
 A. Conversion reaction B. Anxiety disorder
 C. Acute psychosis D. Panic attack
62. True about phobia are all, except: *NIMHANS 08*
 A. Generalized anxiety
 B. Avoiding particular situation
 C. Fear and anxiety of specific thing
 D. Insight is present
63. Fear of open spaces is: *NIMHANS 07; Kerala 11*
 A. Agoraphobia B. Acrophobia
 C. Claustrophobia D. Algophobia
64. Agoraphobia is: *Kerala 08; UP 09*
 A. Fear of closed spaces B. Fear to be in public
 C. Fear of arachnids D. Fear of open spaces
65. A middle aged person presented with the complaints of fear of leaving home, fear of travelling alone and fear of being in a crowd. He develops marked anxiety with palpitations and sweating, if he is in these situations. The most likely diagnosis is: *AIIMS 06; NIMHANS 11*
 A. Generalized anxiety disorder
 B. Schizophrenia
 C. Personality disorder
 D. Agoraphobia
66. Dread (or fear) of high places is called: *Orissa 11*
 A. Abreaction B. Acrophobia
 C. Agoraphobia D. Acting out
67. All are true about obsession, except: *PGI 03, 10*
 A. Recurrent foolish thoughts
 B. Associated with dim light
 C. Attempts to resist intrusive ideas
 D. Associated depression

68. A 15-year-old boy feels that the dirt has hung onto him whenever he passes through the dirty street. He knows that there is actually no such thing after he has cleaned once, but he is not satisfied and is compelled to think so. The most likely diagnosis is:
AI 03; Gujarat 07
- A. OCD
B. Conduct disorder
C. Agoraphobia
D. Adjustment disorder
69. Fear of contamination, counting behaviors and having to check and recheck are features characteristic of:
UPSC 09
- A. Panic attacks
B. Agoraphobia
C. Obsessive-compulsive disorder
D. Generalized anxiety disorder
70. Repetitive hand washing is a symptom of:
Karnataka 04; NIMHANS 07; AFMC 11
- A. Post-traumatic stress disorder
B. Depression
C. Anorexia nervosa
D. Obsessive compulsive disorder
71. Dissociative fugue is:
Maharashtra 08
- A. Person has sudden onset of paralysis
B. Person is fearful of a specified object
C. Person has multiple identities
D. Person flees from an immediate life situation
72. A patient is always preoccupied with feeling of illness. Diagnosis is:
Kerala 06; NIMHANS 08; UP 08; Punjab 11
- A. Hypochondriasis
B. Somatization disorder
C. Conversion disorder
D. Obsession
73. A patient presents with a history of continuous headache for the past 8 years. Repeated examinations had failed to reveal any lesion. The patient is convinced that he has a tumor in his brain. The diagnosis is:
NIMHANS 08
- A. Hypochondriasis
B. Somatization
C. Somatoform pain disorder
D. Obsessive Compulsive Disorder
74. Classic tetrad of narcolepsy includes all, except:
CMC (Vellore) 07; NIMHANS 08; Kerala 11
- A. Hypnagogic hallucination
B. Sleep attacks
C. Sleep paralysis
D. Catalepsy
75. A person laughs to a joke, then suddenly loses tone of all muscles. Diagnosis is:
DNB 09
- A. Cataplexy
B. Catalepsy
C. Sleep attack
D. Sleep paralysis
76. Testamentary capacity refers to:
AP 10
- A. Ability to make a valid will
B. Criminal liability
C. Right to vote
D. Ability to give evidence
77. To plead for insanity in a court of law, the IPC is:
AP 06; UP 09; Rajasthan 11
- A. Sec. 84
B. Sec. 85
C. Sec. 88
D. Sec. 90
78. McNaughten rule is concerned with:
PGI 03, 06; NIMS 11
- A. Civil responsibility in drunken person
B. Criminal responsibility in insane person
C. Professional misconduct by doctors
D. Capacity of a person to make a valid will
79. Rules for criminal responsibility of the insane are all, except:
MP 08; Kerala 08, 09; PGI 09
- A. Hasse's rule
B. McNaughten's rule
C. Durham's rule
D. Curren's rule

Bloodstain Analysis

30

Forensic serology involves the examination and analysis of a variety of body fluids which includes blood, saliva, semen and urine.

Uncontrolled exposure to heat and humidity can destroy much of the biochemical information contained in a stain by enhancing degradation of the chemical substances of importance to the analyst.

Analysis of Blood

Blood is a complex fluid with pH-7.4, cells about 45% and plasma about 55%. Legal requirements state that identification of the stain should be established to a scientific certainty, before it can be presented in the court.

The protocol applied to blood as regards forensic serology is given in Flow chart 30.1.

A visual observation of an untested stain, coupled with positive chemical presumptive and confirmatory tests will provide sound data to support the identification.

Bloodstain Pattern Analysis

Interpreting bloodstain patterns can yield information on the manner in which a bloodstain was deposited and helps in the reconstruction of crime scenes.

- The distance from the impact origin, the object that may have been responsible for the impact, the direction of the impact, the number of impacts (e.g. shots, blows) or the movement of an individual after injury may be determined by studying blood deposition.
- Bloodstain shapes are determined by the angle of impact. When a drop of blood strikes a horizontal surface at an angle of 90°, the resulting bloodstain will be round with spiked edges giving a 'crown' appearance. The bloodstain becomes longer and narrower as the angle decreases and a tapering or 'tear-drop' stain is formed, the sharp end points to the direction the droplet was travelling in when it impacted on the surface (Fig. 30.1). Sometimes, a small separate spot may be present in front of the sharp end of the stain resembling 'exclamation mark' (lance-shaped).

- Smearing indicates movement of the bloodstained object across the surface. Sometimes, a pattern may be left which may help to indicate the shape of a weapon, or fingerprints in blood may help in identification.

Presumptive Tests for Blood

Presumptive or screening test, when positive, leads to the conclusion that blood is present and further tests are usually undertaken to confirm the presence of blood, since no single test is absolutely specific for blood. When negative, stains need not receive further consideration. The screening tests are exceedingly sensitive (1:100,000), specificity is not very satisfactory.

Presumptive tests may be recognized as those that produce a *visible color reaction or result in release of light*. Both types rely on the catalytic properties of blood to drive the reaction.

Catalytic Color Tests^{1,2}

- Catalytic tests employ chemical oxidation of a chromogenic substance by an oxidizing agent (H₂O₂).
- The heme group of hemoglobin exhibit *peroxidase* activity which catalyzes the breakdown of hydrogen peroxide.

H₂O₂ + reduced reagent (color 1) ↔ H₂O + oxidized reagent (color 2)

- Misleading results may be given by pus, saliva, mucus, milk, infected CSF, formalin, plant juices (vegetable peroxidases are thermolabile and can be destroyed with heating), metallic salts (copper and nickel) and oxidizing agents.

Method: A questioned stain is sampled with a clean, moistened cotton swab. To it, one drop of the color reagent solution is added, followed by a like amount of hydrogen peroxide. Nascent oxygen is liberated by the action of peroxidase on hydrogen peroxide. The immediate development of the color, typical of particular reagent used, indicates the presence of blood in the sample.

Flow chart 30.1: Approaches to bloodstain analysis

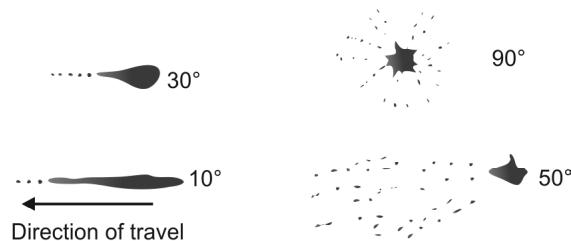
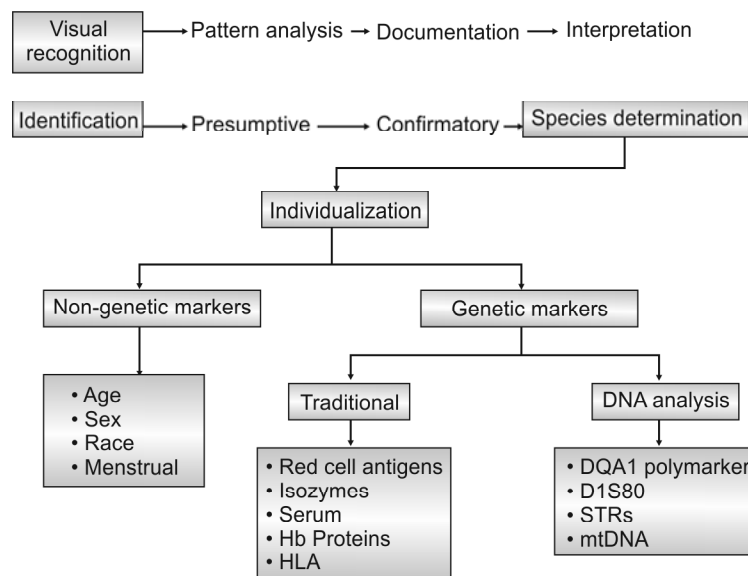

Fig. 30.1: The angles of impact of bloodstains against a target surface

- Benzidine (Adler) test:** The reaction is carried out in ethanol/acetic acid solution and results in a characteristic *blue color*.³ The test is given by blood of almost any age or even by blood that has been subjected to heat or cold. Benzidine is seldom used nowadays because of its carcinogenic effect.
- Phenolphthalein (Kastle-Meyer) test:** This test is commonly used. The reagent consists of reduced phenolphthalein in an alkaline solution that is oxidized by peroxide in the presence of hemoglobin in blood. The reaction shows phenolphthalein (colorless in alkaline solution) being oxidized to phenolphthalein (*bright pink* in an alkaline environment). It is more specific than benzidine, but less sensitive.
- o-Toluidine (Kohn or O'Kelly) test:** The reaction, similar to that of benzidine, is conducted under acidic conditions and produces a *blue color* reaction.

iv. **Tetramethylbenzidine (TMB):** Color change is from *green to blue-green*.

v. **Leucomalachite green (LMG)** produces a *green color*.

Tests using chemiluminescence and fluorescence: A washed drag/spatter pattern in large areas is tested with luminol and fluorescein tests. This involves spraying a chemical mixture on a suspected bloodstained area and observing the result, either in darkness or in reduced light. Luminol (3-amino-phthal-hydrazide) gives *blue-white to yellowish-green glow* which indicates presence of blood.

Other Tests

Spectroscopic examination: It is a *delicate and reliable test* for detecting presence of blood in both recent and old stains, but seldom used. The blood is dissolved in water or normal saline and is placed in a small test tube which is then kept between the spectroscope and the source of the light. The solution has the property of absorbing some of the rays from the spectrum, producing characteristic dark absorption bands which vary with the type of blood pigment present.

Spectra of hemoglobin and its derivatives

- Oxyhemoglobin** is marked by two distinct bands in yellow, between the Fraunhofer lines D and E, the one nearer D being about half the breadth of the other and more defined.

- ii. *Reduced hemoglobin* shows a broad band which lies between D and E.
- iii. *Carboxyhemoglobin* has a spectrum similar to oxyhemoglobin, which remains unchanged after addition of ammonium sulphide which reduces oxyhemoglobin.
- iv. *Methemoglobin* spectrum is similar to oxyhemoglobin with third dark band in the red, between C and D, and the fourth between E and F which is more indistinct.

Thin layer chromatography (TLC): A thin layer of silica gel is prepared on a suitable glass plate. An appropriate quantity of sample extract, standard hematin chloride solution and control sample of blood are placed on the prepared gel. The plate is then placed in a chamber having a convenient solvent system. After the desired run of the solvent to a certain height (front), it is removed from the chamber. When the plate is dry, benzidine and hydrogen peroxide are sprayed on it. If the stain contains blood, the sample extract gives a blue spot at the same height.

Microscopic Examination

Aging, environmental factors or heating can alter blood cells (erythrocytes and leucocytes) and make it difficult to produce reliable results. Intact red blood cells (RBCs) are observed only when the stain is fresh or when a clot is available, but become unrecognizable when the stain has dried. Sometimes, microscopic appearance of RBCs may reveal additional information—sickle shaped erythrocytes may indicate that the sample originated from a person having sickle cell disease.

Procedure: The stained piece is cut and dipped and teased in a watch glass with 2-3 drops of Vibert's fluid (sodium chloride, mercuric chloride and distilled water or normal saline) for half an hour and then examined under a microscope.

- *Non-mammalian RBCs*, e.g. bird, fish, reptile and amphibian are oval, biconvex and nucleated (Fig. 30.2).
- *RBCs of humans and mammals* are circular, biconcave and non-nucleated with the exception of *camel and llama* which are oval and biconvex, but non-nucleated (Fig. 30.3). In primates, nucleated RBCs may be found.

Confirmatory Tests for Blood

Crystal Tests¹

Crystal tests are regarded as confirmatory tests. These tests involve the non-protein heme group of hemoglobin, called porphyrins.

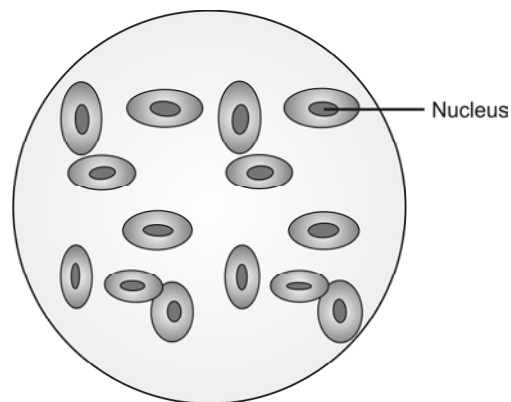

Fig. 30.2: Animal RBCs

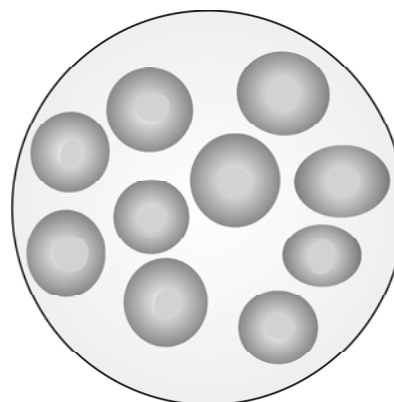

Fig. 30.3: Human RBCs

- i. **Teichmann or Hemin crystal test:** Place a sample of suspected blood on a glass slide, add few crystals of sodium chloride and a few drops of glacial acetic acid from the side of the cover slip and heat it to form a hematin derivative.
 - These hemin or hematin chloride crystals are *brownish rhombic shaped*, arranged singly or in clusters (Fig. 30.4).
 - The reaction is negative, if the stain is old, is washed or treated with chemicals, too much salt is added, if there is moisture in the acid or by over heating.
- ii. **Takayama or Hemochromogen crystal test:** Place a small stain sample under a coverslip and allow the Takayama reagent (sodium hydroxide, pyridine and glucose) to flow under and saturate the sample. After a brief heating, the crystals are viewed microscopically.
 - *Pink feathery crystals* of reduced alkaline hematin (hemochromogen) arranged in clusters are seen (Fig. 30.5).

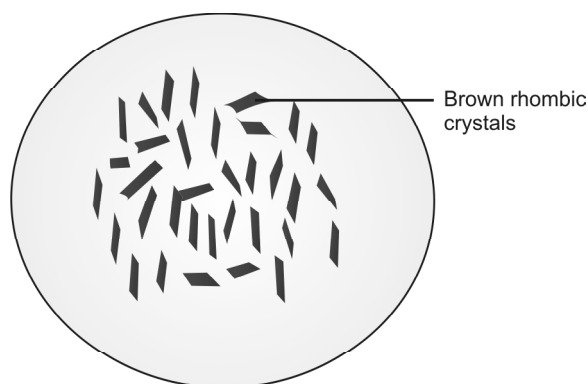

Fig. 30.4: Teichmann test (hemin crystals)
(For color version see Plate 5)

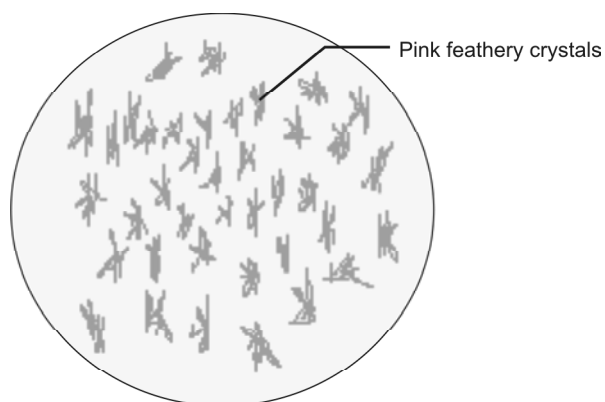

Fig. 30.5: Takayama test (hemochromogen crystals)
(For color version see Plate 5)

- It can be carried out on a small stain quantity, is effective on aged stains and is more dependable.

Species Identification

A wide variety of tests are available for the determination of species origin of an identified bloodstain, and most use immunoprecipitation to effect a result.

Electrophoretic Methods

Two methods are usually used for identifying bloodstains:

- Separation and identification of hemoglobin by electrophoresis
- Separation and identification of serum proteins by immunoelectrophoresis

Precipitin Methods

If host animal (e.g. a rabbit) is inoculated with a human serum protein, the immune system of the rabbit will

normally recognize the protein as foreign and produce antibodies (γ globulins) against it. Harvesting the antibodies provides an antiserum to the protein (antigen) and when a sample of the antiserum and the antigen are brought in contact, a precipitin reaction normally occurs.

The tests are:⁴

- Ring precipitin test
- Antiglobulin consumption test
- Ouchterlony method
- Crossed-over electrophoresis
- Latex test
- Diffusion precipitation test
- Passive hemagglutination test

Some are described below:

- Ring precipitin test:** The ring precipitin test employs simple diffusion between two liquids in contact inside a test tube. The two liquids are the antiserum and an extract of the bloodstain in question. If the antiserum (anti-human) is placed in a small tube and a portion of the (human) bloodstain extract is carefully layered over the denser antiserum, dissolved antigens and antibodies from the respective layers will begin to diffuse into the other layer. The result will be a fine line of precipitate at the interface of the two solutions. In cases where the bloodstain extract is not human, no reaction will occur (Fig. 30.6).
- Antiglobulin consumption test (Hemagglutination inhibition test):** When human globulin is mixed with antihuman globulin serum, the latter is absorbed and is no longer capable of agglutinating Rh positive red cells sensitized with incomplete anti-D. This detects globulins.
- Ouchterlony method (double diffusion in two directions):** It involves the use of agar gel plates with wells for both antibodies and antigens. The two reactants diffuse into the gel where the soluble antigens and antibodies form an insoluble complex—a precipitate.
- Crossed-over electrophoresis:** It involves both quantitative and qualitative determination of blood sample. Under the influence of an electric field, the antigen and the antibody migrate toward each other and a precipitate is formed at the point of their interaction.
- Latex test:** A saline extract of bloodstain is mixed with dilute suspension of latex particles sensitized with antiserum. A positive reaction is shown by agglutination of the particles into clumps.

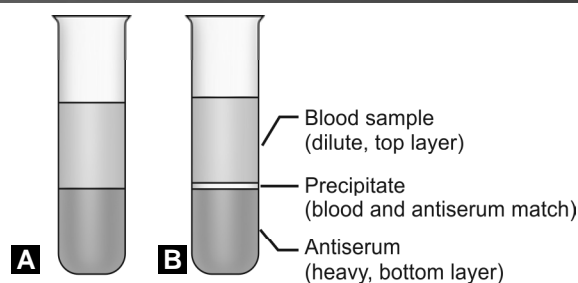

Fig. 30.6: Ring precipitin test (A) Non-human blood
(B) Human blood

Other Methods

- **Nonserum protein analysis:** *Antihuman hemoglobin serum:* Highly specific anti-hemoglobin precipitin sera have been used for the identification of human bloodstains in a single procedure, i.e. it confirms the sample as blood of human origin.
- **Isoenzyme methods:** These are based on the electrophoretic demonstration of the existence of enzymes in blood of the same species in multiple molecular forms known as isoenzymes. These methods (commonly used methods are LDH and Px) are relatively less sensitive than immunological methods.
- **Rapid immunoassay:** Immunoassay test strips for human blood are available which is highly sensitive and specific as confirmatory test. Such procedures involve the reaction of antigens in the extract with monoclonal antibodies within the test strip resulting in antigen-antibody complex where it reacts with dye particles to create visible reactions.

Once human origin of bloodstain is confirmed, its individualization is attempted (whose blood is it?).

Genetic Markers in Blood

Antigen-based Markers: Blood Groups

ABO system: The first and best known blood grouping is the ABO system discovered by Karl Landsteiner in 1900. The types A, B, O and AB refer to the antigens on the surface of the red blood cells. The corresponding antibodies (agglutinins), anti-A (α -A) and anti-B (α -B) are present in plasma.

A person of blood group A will have α -B in his plasma and if that plasma is mixed with group B cells, the two are said to be homologous, and agglutination is the result. The characteristics of the person with group O blood present a different picture. There are no antibodies in humans for red cell H antigens (Table 30.1).

Table 30.1: ABO system

Blood group	Antigen present	Antibody present	Population (%)
A	A	Anti-B	23
B	B	Anti-A	32
AB	A, B	None	6.5
O	H	Anti-A and Anti-B	38.5

Forensic testing for the ABO system in dried bloodstains centres on identifying the antigens and antibodies present. Different methods have been devised, but the most commonly used technique is *absorption elution*.

- This technique involves the exposure of a portion of the stain bearing the blood (and antigen) to absorb the homologous antibody.
- Unreacted antibody is then washed away and the absorbed antibody is eluted and mixed with a known cell suspension to be identified.
- For example, a group A stain exposed to α -A, α -B, and α -H lectin in separate containers, will absorb the α -A and not the α -B or α -H. After allowing sufficient time for absorption, the unreacted antibodies (and lectin) are washed away and gentle heating is applied to release (elute) the absorbed α -A. This α -A is detected by addition of group A cells which agglutinates and can be viewed microscopically. The other two containers exhibit no reaction as no antibody or lectin was absorbed and eluted to react with the B and O cells added.

Secretors

- Some individuals secrete their ABO antigenic characteristics (A, B and H blood group substances) into body fluids, such as saliva, semen, gastric juice and vaginal fluid in a high concentration and in a low concentration in sweat, tears and urine.⁵
- This ability to secrete is under the control of a pair of genes, *Se* and *se*. With *Se* being dominant, homozygous (*Se Se*) and heterozygous (*Se se*) individuals are 'secretors' (80% of the general population) and homozygous (*se se*) are 'nonsecretors' (20% of the population).
- The secretor phenomenon is intimately related to the Lewis blood group antigens.
- It is of great value in medico-legal studies when bloodstains are not available.

Lewis system: Lewis antigens in the blood is another method of establishing secretor status. Lewis (a- b+)

phenotypes are 'secretors' and Lewis (a+ b-) are not. Testing a known blood sample for ABO and Lewis groups usually allows a conclusion with regards to ABO group and secretor status (whether an individual's ABH blood group substances should be found in evidential body fluids). Lewis antigen phenotypes have different distributions in various racial groups.

Rhesus (Rh) system: The Rh system has proven valuable in forensic work in spite of the larger quantity of sample required for dried stain analysis and the degree of sophistication of available techniques. The method used in grouping dried stains is an absorption elution technique. In cases of disputed paternity, five anti-Rh reagents are used, each defining different Rh specificity: anti-D, anti-C, anti-E, anti-c and anti-e.

Gm and Km systems: The Gm and Km systems present distinct advantages to the forensic serologist because of stability of the antigens and the variety of types possible (especially with Gm). The antigens are stable at moderate heat, may be stored at room temperature for extended periods, and can be frozen for years.

Medico-legal Aspects of Blood Groups

The application of blood groupings to medico-legal problems is based on the following principles:⁶⁻⁸

- i. A blood group antigen cannot appear in a child, unless present in one or the other parent.
- ii. If an individual is homozygous for a blood group factor, it must appear in the blood of all his children.
- iii. If a child is homozygous for a blood group factor, the gene for the same must have been inherited by him/her from each of his/her parents.
- iv. The blood group characters are characteristic to the individual and are unchanged throughout life.

Many cases can be solved by means of the blood groups of the parent and the child. However, the tests have their limitations. They may exclude a certain person as the possible father of the child, but they cannot definitely establish paternity.⁹ They can only indicate its possibility. For example, a child with the blood type AB whose mother is type A could not have a father whose blood type is A or O. The father must have blood type B.

Exclusion of Paternity

- *First-order exclusion:* Where the child has a blood group gene that is absent in both the mother and the alleged father.

- *Second order exclusion:* Where the alleged father is homozygous for a blood group gene, but the gene is not present in the child.
- The ABO system can exclude paternity in 1/6th of all cases. Addition of the MN system can exclude paternity in about 44% of all cases. Addition of Rh subgroups can clear about 60% of wrongly accused men.
- The addition of blood protein and red cell enzyme variants, such as phosphoglucomutase can raise 'non-father' exclusion to about 90%.
- The HLA system alone can exclude non-paternity in 90% of cases, but in combination with other grouping systems, it can achieve exclusion rate upto 98%.¹⁰
- DNA fingerprinting provides absolute certainty, rather than a probable exclusion as in other systems.

Medico-legal Application of Blood (Groups)

Identification of blood and bloodstains has importance both in civil and criminal fields of investigation:⁹

Civil Cases

1. **Disputed paternity:** The question of disputed paternity arises in the court in the following conditions:
 - a. *Adultery and divorce:* When a child is born in lawful marriage, but the husband denies that he is the father of the child.
 - b. *Blackmail:* When a child is born out of lawful marriage, and the mother accuses a certain man of being the father of the child, while the man denies the accusation.
 - c. *Maintenance claims:* Under Sec. 125 CrPC, an individual must adopt his illegitimate child or support him upto certain age. A first class Magistrate can order an allowance upto ` 500 per month for this purpose.
 - d. *Share of property:* When a woman pretends pregnancy and delivery, and obtains a child claiming him/her as her own in order to obtain a share in her husband's property.
2. **Disputed maternity:** The question of disputed maternity arises in the following circumstances:
 - a. When the same child is claimed by two women.
 - b. When there has been an allegation of interchange of a child with another in the maternity hospital, either purposely or accidentally.
 - c. In case of a kidnapped child, when the woman who has kidnapped the child claims to be the mother.
 - d. In case of a suppositious child, when a woman pretends pregnancy and delivery, and brings forth a child to pass it off as her own.

3. **Inheritance claims:** The question of legitimacy arises, since a legitimate child only can inherit the parent's property.
4. **Divorce and nullity of marriage cases**, e.g. question of intersex and some forbidden diseases.
5. **Civil negligence** cases arising in hospital or medical practices, e.g.:
 - a. Incompatible blood transfusion.
 - b. Neglect of expiry dates leading to transfusion reactions from leakage of electrolytes from damaged red cells.
 - c. Presence of pathogenic organisms, such as malaria, syphilis, hepatitis B and AIDS virus in the transfused blood.

Criminal Cases

1. **Identification of victim or offenders** of crime in circumstances, such as murder, wounding, rape and vehicular accidents.
 - Bloodstains may be found on the clothing and person of the suspect. If the character of these stains is similar to that of blood of the victim, it establishes association.
 - Bloodstains may be present under the fingernails of assailant in a case of throttling.
 - If there has been a struggle, bloodstains derived from the accused may be found under the fingernails of the victim due to scratching.
 - Vehicles which have caused injury can be identified when they show bloodstains resembling that of the victim.
2. **Stains due to body fluids:** The blood group antigens can be demonstrated in stains on clothes due to semen, sweat or saliva ('secretors'). This may be a corroborative evidence of the accused.
3. **Crime scene reconstruction:** Blood spatter interpretation can be valuable in determining how blood was deposited on an item or at a scene.
4. **Corroborate or refute an individual's allegation:** It can substantiate a complainant's or suspect's account of alleged events of an assault and can be critical in establishing guilt or innocence during criminal proceedings.
5. **Cases of malingering:** The specificity of various blood group combinations is like that of the fingerprints. When an individual has some rare blood group, he can be identified with certainty.
6. **Cause of death**, e.g. detection of poison in the blood.
7. **Time since death** can be estimated by use of different chemical or biochemical tests.

- **Sample collection:** In the case of the adults, 5 ml of venous blood is taken and placed in plain tube. Neither party should have had a blood transfusion within 3 months, before taking the sample. The infants should preferably be 6 months of age, but not < 2 months before testing is performed; one ml of blood is obtained by a heel or ear prick or venepuncture into a plain tube. The same person should do the testing of mother, child and alleged father in the same laboratory, on the same day, and using the same batch of reagents and antisera.
- The blood groups in current use in the investigation of cases of doubtful paternity are ABO, MNS, Rh, Kell, Lutheran, Duffy, and Kidd.
- **Grouping based on white cell antigens:** The *Human Leucocyte Antigen (HLA)* system consists of protein substance on the surface of a wide variety of tissues and organs, tumors, white cells and platelets. They are reported to be present on spermatozoa, but not on ovum or trophoblast. They are found both on lymphocytes and granulocytes. The major human leucocyte antigens HLA-A, B, C, D, and DR are determined by a single chromosomal segment, the major histocompatibility complex (MHC), which is situated on the short arm of human chromosome 6.
- **Protein markers:** *Hemoglobin (Hb)*: It exhibits 180 or more variants, but only four (Hb A, Hb F, Hb S, and Hb C) are readily distinguished forensically with electrophoresis or IEF based on the positioning of bands.
- **Enzyme markers:** *Phosphoglucomutase (PGM)* is found in many tissues of plants, animals, and micro-organisms. In humans, the enzyme exists in significant concentrations in blood and semen and in small amounts in vaginal secretion and cervical mucus.
- Electrophoresis of forensic samples for PGM analysis using IEF methods can detect 10 phenotypes. With this, it is possible to place the subtypes of PGM in 10 different population groups and thus presents the highest discrimination probability of any enzyme system used in forensic serology.
- **Human DNA quantitation:** A sample can be determined to be blood of human origin with a probe specific for human DNA. Probes complementary to primate specific DNA sequences, such as those found at the locus D17Z1 are used primarily to determine the amount of human DNA extracted from the sample prior to DNA typing.

Medico-legal Questions

Q. Whether the stain is due to blood or some other material?

It is essential to establish positively that stain is in fact blood before conducting further analyses. Presumptive tests (color tests) and confirmatory tests such as,

chemical methods, spectrophotometric analysis are done for this purpose. Some substances that may resemble bloodstains are:

- i. *Rust stains*, tests are positive for iron.
- ii. *Synthetic dyes* stain changes to yellow with nitric acid, blood remains unchanged.
- iii. *Mineral stains* contain oxides of iron or red lead.
- iv. *Vegetable stains*: Fruits, like mulberry, gooseberry and currants produce stains resembling bloodstains. Tests are negative for blood, and ammonia turns the vegetable stain green.
- v. *Other stains*, like grease or tar on dark fabrics may resemble bloodstains.

Q. If it is blood, is it human?

In some cases, it may be necessary to confirm the presence of human blood in questioned stain before obtaining a known sample from a suspect or a victim. Confirmation is done by immunological methods.

Q. If it is human, what information towards individualization is possible? (victim or assailant)

- Blood groups (ABO) may be different. Stains on the inner side of the clothes usually belong to the victim, while those on the outer side may be of the victim or assailant. Bloodstains may bear marks of fingerprints or footprints of the assailant.
- Sometimes there may be some disease, like leukemia, filariasis or sickle cell anemia either in the victim or the assailant which may provide valuable information.
- Traces of blood may be found underneath the fingernails of the victim as a result of struggle or of the assailant in case of throttling; these can be typed and grouped.
- An individual bloodstain can also be identified by using DNA typing.

Q. Whether the sex of the person can be determined from the bloodstain? (male/female)

Sex can be determined from presence of sex chromatin in leucocytes.

- *Barr body* count in WBC can be done using orcein and acriflavine reagent.
- *Y chromosome* is fluorescent to quinacrine when examined under fluorescent microscope.
- *Fluorescent in situ hybridization (FISH)* technique can also be used for sex determination. Probes specific for X and Y chromosomes are applied.

Q. Whether the bloodstain came from an infant or adult?

- *In infants*, the red blood cells exhibit more fragility, the hemoglobin is of the fetal type (fetus specific

hemoglobin $\alpha_2\gamma_2$ detectable upto about 6 months) and the blood when shed forms a thin and soft coagulum.

- *In adults*, the red blood cells are non-nucleated, their fragility is within certain limits, hemoglobin is of the adult type and the blood when shed forms a thick and firm coagulum.

Q. How long the stain has been on the object/surface? (recent/old)

- *Recent stains* on white cloth are at first red due to conversion of hemoglobin to methemoglobin and hematin.
- The color changes to dull red within hours and to reddish brown within 24 h, dark brown or even blackish within *few days* and remains so for several years.

So, it is only possible to state that the stain is recent or not very recent.

Q. What could be the source of the blood?

Bleeding due to disease, accident, menstruation, parturition, abortion, hematemesis or hemoptysis may cause stains.

- Most common defense in cases of assault on females is that the stain is from *menstruation*. It has a disagreeable smell, being mixed with urine and vaginal mucus, it is more fluid and dark in color. Menstrual blood does not clot, due to extensive degradation of the clotting factor fibrinogen. Fibrinogen degradation products are present in high concentration that can be detected immunologically.
- *Hemoptysis* blood is bright red, frothy and alkaline in reaction.
- *Hematemesis* blood is dark in color, not frothy and is acidic in reaction.
- *Parturition and abortion* blood may have some clot or products of conception, like decidual tissue, fetal parts, chorionic villi, vernix caseosa or lanugo hair. Color may be yellowish or greenish from admixture with meconium.

Q. What could be the site of bleeding (arterial/venous)? (Fig. 30.7)

Damage to different types and sizes of blood vessels will result in different degrees of bleeding, but it is difficult to predict the exact type of flow of blood from an injury.

- *Arterial bleeding* has a spurting effect (jet-like ejection) from the wound. It is bright red in color when fresh.
- *Venous bleeding* occurs passively in drops without any projectile force, has stellate appearance and dark

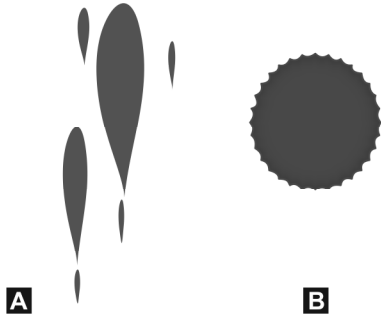

Fig. 30.7: (A) Arterial bleeding (B) Venous bleeding

in color. It may ooze and produce a pool, if the victim falls down.

Q. Whether the bleeding was antemortem or postmortem?

- Blood which has effused during life can be peeled off in scales on drying, due to presence of fibrin and the clot can be taken *en masse*.
- Blood which has flowed after death tends to break up into powder on drying and the clot cannot be taken *en masse*.

MULTIPLE CHOICE QUESTIONS

- All are tests done on blood, except:** *TN 11*
 - Acid phosphatase test
 - Benzidine test
 - Hemochromogen test
 - Teichmann's test
- Hydrogen peroxide is used in all the following chemical tests for blood, except:** *AI 04*
 - Benzidine tests
 - Phenolphthalein test
 - Orthotolidine test
 - Teichmann's test
- Benzidine test is done to detect:** *Delhi 03; PGI 07*
 - Semen
 - Blood
 - Bile
 - Saliva
- Species identification is done by:** *AIIMS 03; COMEDK 08; Punjab 11*
 - Takayama test
 - Precipitin test
 - Benzidine test
 - Spectroscopy
- ABO antigens is not found in:** *AIIMS 09*
 - CSF
 - Semen
 - Sweat
 - Saliva
- An Rh-negative woman married to a heterozygous Rh-positive man has three children. The probability that all three of their children are Rh-positive is:** *Himachal 10*
 - 1: 2
 - 1: 4
 - 1: 8
 - Zero
- A baby's blood group was determined as O Rh negative. Select the blood group, the baby's mother or father will not have:** *WB 07*
 - A positive
 - B positive
 - AB negative
 - A negative
- In a case of disputed paternity, father's blood group is A, mother's blood group is B, the child's blood group may be:** *Karnataka 07*
 - A only
 - B only
 - AB only
 - A, AB, B or O
- Following statement about blood grouping is NOT correct:** *AIIMS 04*
 - It can be used to resolve confusion of identity in alleged exchange of babies in maternity unit
 - It is the method to conclusively fix the paternity
 - It can assist in matching fragmented human remains in mass disaster
 - It can help to show whether bloodstain on the weapon belongs to the suspect or victim
- HLA typing is useful in:** *PGI 06*
 - Disputed paternity
 - Thanatology
 - Organ transplant
 - Dactylography

Seminal Stains and Other Biological Samples

31

Introduction

Semen is the fluid discharged from the penis during ejaculation, usually at the time of orgasm. Like blood, semen consists of two compartments, the cellular compartment (spermatozoa) and noncellular compartment (seminal plasma) which is secreted from the prostate gland, seminal vesicles, Cowper's glands and the glands of Littre.

The normal quantity of seminal fluid in a single emission is 2-5 ml and contains about 60-150 million sperms/ml of which 90% are motile at time of ejaculation. Spermatozoa constitute about 10% of the volume of the semen which contains water and small amounts of salt, protein and fructose. Prostatic secretions in humans contain high levels of citric acid, acid phosphatase and zinc. The secretion is alkaline with a pH of 7.4.

Purpose of Seminal Identification

Seminal stains may have to be detected/examined in criminal and civil cases.

Criminal cases	Civil cases
<ul style="list-style-type: none">• Rape/attempted rape• Sodomy• Bestiality• Sexual murder of the female	<ul style="list-style-type: none">• Disputed paternity• Legitimacy• Artificial insemination• Divorce• Compensation on grounds of acquired sterility/failure of vasectomy cases

Collection of Material

The stains are usually found on the clothing, but may be found on the person of either the victim or the accused. They may also be found on bedclothes, furniture, vehicles, carpet, floor or grass, where the offence was committed or any item the victim may have used to clean up after the assault (tissue or washcloth). Seminal stains have to be differentiated from those due to starch, pus, leucorrhoeal discharge and egg albumen.

Before proceeding with the examination, stains may have to be collected and preserved from different sources:

- Clothing:** Portion of cloth with the stain is cut, dried in shade (not heated) and preserved.
- Vaginal fluid:** Fluid from the vagina is collected with a pipette or vaginal washing is done which is concentrated by centrifugation. Swabs are taken with sterile gauze and smears are prepared on sterile slides.
- Dried stains on other parts of body:** Dried seminal fluid on the perineum or thighs is collected with a wet swab.
- Matted pubic hair:** It is plucked/cut and placed in a small container.
- Stains on smooth surface:** These are gently scraped off into a glass container and preserved.

Samples must be packed in containers that allow air circulation; never in plastic bags or sealed nonporous tubes, jars or boxes. Chain of custody must be documented and adhered to the prevailing polices.

Examination of Seminal Stains

Evidence material for analysis of possible semen consists of swabs taken from various locations on or in the victim and objects that may contain semen. The sequence of analyzing the evidence is given in Flow chart 31.1.¹

Screening Tests

Physical Examination

- *When fresh*, semen is a whitish or yellowish-white in color, slightly viscous, jelly-like, sticky and has a characteristic odor. On standing, viscosity is lost due to prostatic fibrolysin and it becomes thin.
- *Dried seminal stains* on clothes are grayish-white or yellowish-gray color, show an irregular outline and starchy hard in feeling. When examined under filtered UV light, they fluoresce with a bluish-white color (due to choline in semen) which is not specific,

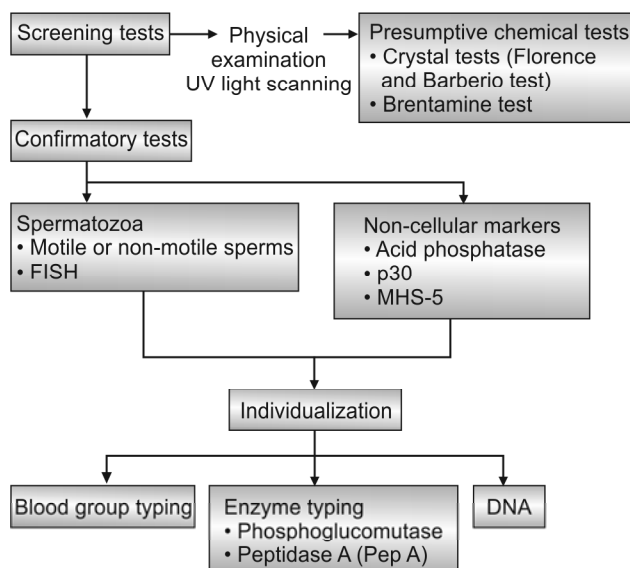
Flow chart 31.1: Evaluation of a suspected seminal stain in sexual assault

as other albuminous materials, such as nasal or leucorrhoeal discharges and detergents also fluoresce.

- A fresh stain on a non-absorbent material appears translucent. After a month, it becomes yellow to brown.

Presumptive Chemical Examination

Presumptive tests for semen are based on colorimetry and are qualitative in nature. Positive presumptive tests must be followed by a confirmatory test, such as microscopic examination, quantitative acid phosphatase test or detection of p30.

i. **Florence test:** The stain is extracted, dried on a glass slide and covered with a coverslip and a drop of Florence solution (8% w/v of iodine in water containing 5% w/v of potassium iodide) is allowed to run under the coverslip. If semen is present, *dark brown rhombic crystals* resembling hemin (but larger) arranged in clusters or rosettes of choline periodide appear immediately (Fig. 31.1).² Choline originates from the seminal vesicles. A positive test is not proof of seminal fluid, but confirms the presence of some vegetable or animal substance. A negative reaction proves that the stain is not semen, but may occur if choline content is low or the stain is decomposed.

ii. **Barberio's test:** A saturated aqueous or alcoholic solution of picric acid when added to dried stain extract on a glass slide covered with a coverslip, produces *yellow needle-shaped crystals* of spermine

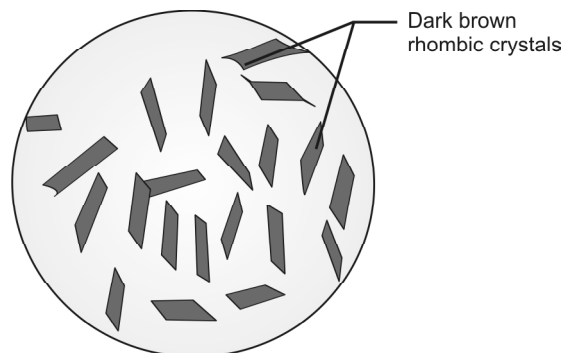

Fig. 31.1: Florence test (choline iodide crystals)
(For color version see Plate 6)

picrate (Fig. 31.2). The reaction depends on the presence of spermine from prostatic secretions.^{3,4} This test is positive without the presence of spermatozoa.

iii. Brentamine fast blue test

- It is the most common presumptive test for seminal *acid phosphatase*. Acid phosphatase activity is 500-1000 times greater in human semen than in any other bodily fluid.
- An enzyme substrate, sodium α -naphthyl phosphate is converted to sodium phosphate and naphthol by the acid phosphatase enzyme in the semen and a coupled reaction with bentamine fast blue dye takes place, forming a purple color.
- It can produce false positives because similar enzyme activity is found in other body fluids (e.g. vaginal secretions and fecal stains), human red cells, semen of higher apes as well as in presence of fungi, bacteria and even plants (juice of cauliflower). Moreover, pregnancy, menstruation, bacterial vaginosis may also elevate its level.

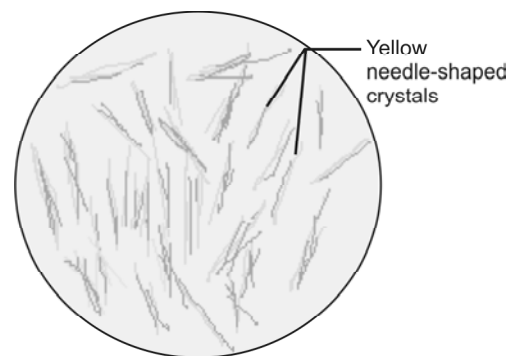

Fig. 31.2: Barberio's test (spermine picrate crystals)
(For color version see Plate 6)

- Dried and old seminal stains which have not undergone putrefaction give positive reaction.

Confirmatory Tests

- Confirmatory testing involves solubilization of sample followed by centrifugation which yields a supernatant and a cell pellet. The cell pellet is used to detect spermatozoa and for DNA analysis, whereas the supernatant is useful to detect non-cellular markers when sperms are not detected and for grouping or genetic profiling.
- Sometimes, the sample is contaminated by other bodily fluids (saliva, vaginal secretions), epithelial cells, cellular debris wherein selective degradation may be done by treating the cell extract with a mixture of proteinase K and sodium dodecyl sulfate before staining and microscopic examination.
- Most commonly used confirmatory test for semen is visualization of one or more intact spermatozoa after staining with dyes such as hematoxylin and eosin and 'Christmas tree' stain.

Microscopic Examination

Procedure: A small piece of the stained fabric is moistened with a few drops of 1% HCl in a watch glass for half to one hour, if the stain is fresh or 2-4 h if it is old. Slides are prepared by dabbing the fabric gently on them. Films are dried in the air without heat fixed and then stained.

- Slide is stained either with hematoxylin for 2-5 min and eosin for 3 min or methylene blue for 15-30 min and counterstained with eosin for 2 min.
- Posterior half to one-third of head and the tail takes eosin and is stained deep red or pink, while anterior half to two-third takes very light or faint basic or blue stain or may appear unstained (Fig. 31.3).
- Size of human spermatozoa is about 55 μ length. Head is ovoid and flattened, 5 \times 3.5 μ in dimensions. It has a short neck and a long filamentous tail (50 μ) which tapers to a fine point (Fig. 31.4).
- Bacteria, fungi, trichomonas, yeast, monilia and naked nuclei from vaginal epithelial cells give false positive test.
- Older the stain, lesser is the chance of finding intact sperms.
- *Single photon fluorimetry* has been used to differentiate between different semen.

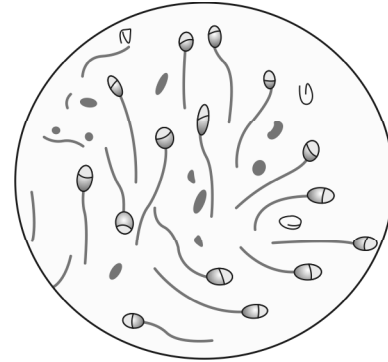

Fig. 31.3: Spermatozoa under light microscope
(For color version see Plate 6)

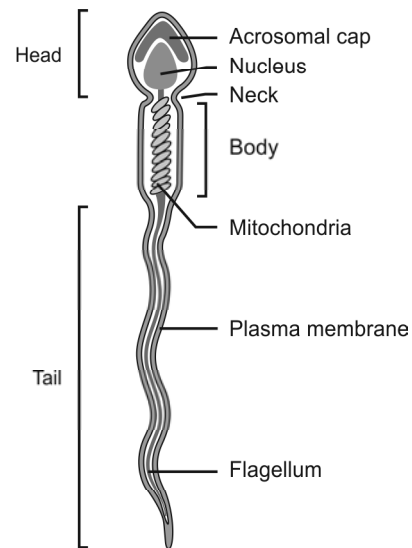

Fig. 31.4: Morphological appearance of spermatozoon

Others staining methods

- **Christmas tree stain:** This staining technique was developed by *Oppitz* which consist of nuclear fast red (red stain for sperm head) and picroindigocarmine (green counter-stain for the tail and other cytoplasmic material) and are sometimes referred to as 'Christmas tree' stain because of the red-green combination.
- **Papanicolaou staining:** In Pap smear, acrosome is stained pink, postacrosome—dark blue, and tail—pink.
- **Giemsa stain:** Acrosome stained pink, postacrosome—dark blue.
- **Ziehl-Neelsen's method:** Smear is stained and examined for the presence of spermatozoa and smegma bacilli (*Mycobacterium smegmatis*). It is an acid fast, rod shaped bacillus and thicker than the tubercle bacillus.
- **Other stains:** Bryan-Leishman stain, Shorr stain and alkaline fuchsin.

Motility of Sperms

- At room temperature, motility depends on time elapsed since ejaculation.
- At body temperature (in living victims), sperms retains full motility in vagina between 6-12 h. The sperms remain motile in the uterine cavity for 3-7 days. Later, the sperms disintegrate into head and tails which may be recovered from the vagina upto 7-10 days and 12-14 days in the cervix and uterus.
- Complete motile sperms may be seen upto 28 h in vagina after ejaculation (non-motile sperms may be found upto 10 days).
- Non-motile sperms may be seen in the oral cavity from 2-31 h, in rectum from 4-113 h and in anus from 2-44 h.

Fluorescence in situ hybridization (FISH): This cytogenic analysis uses a Y chromosome specific DNA probe to identify Y-bearing (male) cells. This technique identifies not only spermatozoa, but also cells of male origin and also confirms male-female contact.

Non-cellular Semen Markers

Markers are specific and unique to seminal plasma but independent of spermatozoa. The two most commonly employed constituents are acid phosphatase and the prostate-specific glycoprotein p30 (PSA). These tests are conclusive even in the absence of demonstrable sperms, azoospermia or vasectomized individuals.⁵

- Acid phosphatase test (quantitative):** Finding a significantly elevated acid phosphatase level is consistent with the presence of semen. Undiluted semen has an acid phosphatase level of 340-360 Bodansky units/ml. A value of > 100 Bodansky units with/without motile sperms indicate that ejaculation occurred within 12 h of examination.
 - Isoenzymes can be detected using polyacrylamide gel electrophoresis followed by staining with methyl umbelliferyl phosphate reagent which can distinguish the acid phosphatase present in other substances.**
 - Prostate specific antigen or PSA (p30):** The glycoprotein p30 is derived from prostrate and is found in seminal plasma, male urine and blood and has not been found in any female body tissue or fluid.
- p30 in sample reliably identifies semen regardless of whether acid phosphatase is elevated or spermatozoa are detected.
 - It is determined serologically using antiserum that is specific for the p30 antigen. Traditional detection

tests utilize electrophoretic methods such as crossover electrophoresis or diffusion methods, such as Ouchterlony double diffusion wherein a precipitation band is formed due to the formation of antibody-antigen complex. It can also be done using immunochromatographic strip test using antibodies raised against the human PSA and enzyme-linked immunoassay (ELISA).

- Its normal range in semen is 300-4200 $\mu\text{g/ml}$ with mean of 1200 $\mu\text{g/ml}$ and is detectable in vaginal fluid upto 27 h (range 13-47 h) after intercourse as compared to 14 h for acid phosphatase.
- p30 can be detected in dried and old stains (> 10 years in material stored at room temperature) and in cadavers.

Other tests

- **Creatine phosphokinase test:** Spermatozoa contain a high concentration of creatine phosphokinase, which is more than double, than that found in any other body fluid. Values > 400 units/ml are diagnostic of seminal stains. The enzyme is stable and can be demonstrated even in old stains. The test will be negative in case of aspermia.
- **Choline and spermine test:** Fresh and dried seminal stains can be identified by a thin layer chromatographic technique due to the combination of choline and spermine which is present only in semen.
- **Ammonium molybdate test:** It gives a yellow color (due to presence of phosphorus) when the reagent is added to the seminal stain extract.
- **Lactate dehydrogenase (LDH) isoenzyme:** Polyacrylamide gel electrophoresis is used to separate the various isoenzymes. This method gives a specific biochemical detection of spermatozoa in semen in the presence of vaginal fluid, blood, urine and saliva.
- **Monoclonal antibody mouse antihuman semen-5 (MHS-5)** produced in the seminal vesicle and is not found in any other bodily fluid besides semen. It is not widely used in forensic evaluation of seminal stain.
- **mRNA analysis:** Another confirmatory test for detecting the semen-specific protamine 1 and 2 and kallikrein 3 gene.

Identification of Species Origin

- Confirmation of species is done by precipitin test. Specific anti-human-semen serum may be used in place of anti-human serum which is commonly used.
- LDH isoenzyme pattern may be used for detection of human origin of semen as it is different in animals.
- Detection of Y bodies in spermatozoa heads using fluorescent microscope which is not seen in animals.

Individualization of Seminal Stains

The genetic profile can be compared with the genetic profiles of the victim and the suspect(s). The subject can thus be included as possible assailant or excluded from consideration. Conventional serology is limited to blood group antigens (ABO and Lewis antigens) that are secreted into bodily fluids such as semen and vaginal secretions; phosphoglucomutase (PGM) and peptidase A (Pep A).

- a. **Blood group typing:** If the seminal stain is from secretor, absorption-elution method is used to determine the ABO blood group. In sexual assault cases, it requires the comparison of blood group substances recovered in the evidence material with those of the victim and the suspect (Table 31.1).
 - Traditional grouping is cheap, fast and universally available.
 - ABO blood grouping is superior to DNA analysis for typing semen that contains few or no sperm.
 - Seminal blood groups have been detected in the vagina upto 21 h after deposition.
- b. **Enzyme typing:** PGM and Pep A are two enzyme markers commonly used in the genetic profiling of semen. These enzymes are found in semen and vaginal secretions regardless of ABO type or secretor status. Pep A is most commonly used as a discriminator in cases in which the perpetrator is thought to be Negro. PGM can be detected till 6 h and Pep A till 3 h.
- c. **DNA profiling:** The primary advantage of DNA profiling is its ability to accurately individualize semen that contains only minimal numbers of spermatozoa. It has a high degree of sensitivity and discrimination.

Medico-legal Questions

Q. Did sexual assault occur?

Positive recovery of any component of semen (especially intact spermatozoa) from the victim is considered

Table 31.1: ABO blood types and antigens useful in forensic evaluation

Victim's phenotype	Expected antigens from the victim	Foreign antigens from the assailant
O	H	A and/or B
A	A and H	B
B	B and H	A
AB	A, B and H	None

conclusive proof of sexual contact. Recovery of spermatozoa from anal swabs of a male or a female sodomy victim is consistent with anal intercourse.

Q. When did the sexual contact occur?

The interval between semen deposition and sample collection may be estimated by comparing the specific findings in the case with the published normal and maximum recovery intervals.

Q. Can a specific suspect be included or excluded?

Genetic profiles from the evidence material, the victim and the suspect can be developed using conventional serology and DNA.

Q. Was the sexual contact consensual or nonconsensual?

If the victim is beyond the age of consent, finding of semen is not helpful but if the victim is underage, then consent is invalid and the recovery of semen is consistent with the commission of the crime.

Identification of Biological Samples and Body Fluids

1. **Saliva:** Identification of saliva on bite marks, cigarette or '*bidi*' ends and on clothes and determination of secretor status is important in criminal offences. The salivary stains are identified from the presence of enzyme α -amylase and buccal epithelial cells. The two most commonly used methods for α -amylase detection are radial diffusion and dyed starch substrates.
 - i. *Radial diffusion* utilizes agar gel containing starch. The α -amylase activity is detected by the classical starch-iodine reaction that gives a characteristic purple reaction.
 - ii. *Dyed starch substrates:* Starch is covalently linked to a dye such as cibachron blue or procion red to form insoluble complex. Subsequently to α -amylase activity the dye is released from the complex and becomes soluble causing change of color which can be measured by spectrophotometry. This forms the basis of the *Phadebas test* which uses starch-cibachron blue tablets as the substrate.
- Precipitin test is used for species identification and absorption-elution technique is preferred for blood grouping.
- As with blood, antibody tests using lateral flow strips have been developed that are specific for saliva. mRNA can also be isolated from saliva.

2. **Fecal matter:** Identification may be necessary in cases of sodomy and bestiality. The stains can be identified from odor and presence of undigested muscle fibres, plant cells, starch, bacteria, stercobilin and urobilinogen.
 - **Urobilin:** Urobilinogen (a precursor of urobilin) is oxidized to urobilin by alcoholic mercuric chloride. Subsequent addition to alcoholic zinc chloride produces a green fluorescence which is due to the formation of a stable zinc-urobilin complex.
3. **Urine:** The stains may have to be identified in cases of murder and sexual assault. It is identified from the presence of urea, uric acid and creatinine.
4. **Vaginal secretion:** It consists of white coagulated material consisting of shed vaginal epithelium and Doderlein's bacilli. Glycogen-rich squamous epithelial cells of the vaginal tract may be stained with Lugol's iodine.
5. **Dental tissue:** Absorption-elution technique is preferred for blood grouping of dental tissues including dentin, cementum and dental pulp. Results are most accurate with dental pulp.
6. **Hair:** With absorption-elution technique, a single hair shaft can determine blood group. Blood grouping is practicable with scalp hair from fetuses and newborn infants and also with gray scalp hair. If hair is heated at 250°C, it is impossible to detect blood groups.
7. **Nails:** The human nails contain mainly ABO blood group antigens. MN blood groups have been detected in some cases.

MULTIPLE CHOICE QUESTIONS

1. **All are tests for seminal stains, except:** *Delhi 05*
 - A. Takayama test
 - B. Barberio's tests
 - C. Florence test
 - D. Acid phosphatase test
2. **Florence test is used for:** *Delhi 06*
 - A. Blood stains
 - B. Seminal stains
 - C. Salivary stains
 - D. Sweat stains
3. **Test used to detect semen:** *AI 06; Gujarat 10; Manipal 11*
 - A. Phenolphthalein test
 - B. Reine's test
 - C. Barberio's test
 - D. Paraffin test
4. **Spermine is detected by:** *TN 08*
 - A. Takayama test
 - B. Barberio's test
 - C. Florence test
 - D. Acid phosphatase test
5. **Conclusive test for semen:** *Jharkhand 11*
 - A. Acid phosphatase test
 - B. Barberio test
 - C. Florence test
 - D. Phenolphthalein test

DNA Fingerprinting

32

Introduction

DNA fingerprinting (DNA typing, DNA identification, DNA profiling or genetic typing) is a technique that is capable of distinguishing every individual with the exception of identical twins and clones. It depends on the fact that no two people have exactly the same DNA sequence (with the exception mentioned) and that although only limited segments of a person's DNA are scrutinized in the procedure, those segments will be statistically unique. Consequently, DNA fingerprinting is rapidly becoming the primary method for identifying and distinguishing among individual human beings.

- DNA is a sturdy molecule which can tolerate wide range of temperature, pH and other factors. DNA mixed with detergents, oil, gasoline and other adulterants does not alter its typing characteristics.
- DNA fingerprint was first developed in England in 1985 by Alec Jeffreys, professor of genetics at the University of Leicester who made the discovery by accident while tracking genetic variations in myoglobin.¹
- Two methods of DNA analysis are in common use (Diff. 32.1):
 - i. RFLP (restriction fragment length polymorphism)
 - ii. PCR (polymerase chain reaction)

RFLP

In the human genome, in between the active base pairs which code for a particular protein, there is large number of inactive base pairs forming 95% of DNA, which is considered as 'junk DNA' or 'filler DNA' or 'nonsense DNA'. Technically, these 'introns' separate the 'exons' which serve as protein patterns. DNA fingerprinters overlook the DNA in genes, in favor of 'junk DNA' between the genes.²

In 'junk DNA' short sequences of base repeat themselves over again like a *stutter* (repetitive DNA), e.g. CGTA, CGTA, GACA, GACA, etc. The regions containing repetitive DNA demonstrating hyper-variability from person to person are called 'satellite DNA' which shows an extremely high degree of variability, and these variants are called 'variable number tandem repeats' (VNTR) or 'minisatellites'.² Selected regions of VNTR are broken into fragments using special enzymes (restriction endonucleases).³ The resulting fragments are called *restriction fragments length polymorphisms* (RFLP). Gel electrophoresis can be used to separate and determine the size of the RFLPs (fragments are of variable lengths). The exact number and size of fragments produced by a specific restriction

Differentiation 32.1: RFLP and PCR

S.No.	Feature	RFLP	PCR
1.	Amount of DNA sample required	Large (300-500 ng)	Small (25 ng)
2.	Sensitivity	Less	More
3.	DNA degradation	Useless when degradation is present	Useful
4.	Decomposed sample	Not useful	Useful
5.	Time required	More	Less
6.	Tedious	More	Less
7.	Labor intensive	More	Less
8.	Sensitivity to contamination with other samples	Less sensitive	More sensitive
9.	Result of the test	Non-discrete	Discrete (binary 'yes/no')

enzyme digestion varies from individual to individual, i.e. they are individualistic in nature and establish 100% identity.

Procedure (Fig. 32.1)

The most common method of DNA typing is RFLP analysis of VNTR loci.

- i. **Isolation/extraction of DNA:** DNA must be recovered from the cells or tissues of the body. Only a small amount of tissue—blood, hair or skin—is needed. For example, the amount of DNA found at the root of one hair is usually sufficient.

- ii. **Cutting and sizing:** Special enzymes called *restriction enzymes* are used to cut the DNA at specific places. For example, an enzyme called EcoR1, found in bacteria, will cut DNA only when the sequence GAATTC occurs.

- iii. **Sorting by gel electrophoresis:** The DNA pieces are sorted according to size by a sieving technique called electrophoresis. The DNA pieces are passed through an agarose gel. This results in separation of the DNA fragments based on their length (size) (Fig. 32.2).

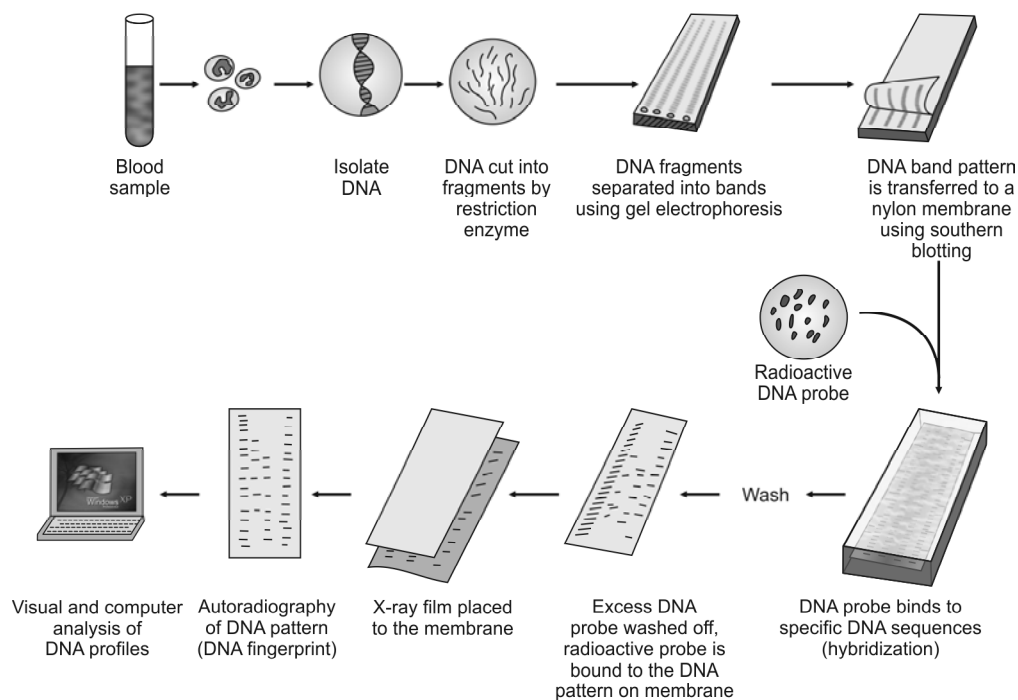

Fig. 32.1: Procedure of DNA profiling (RFLP)

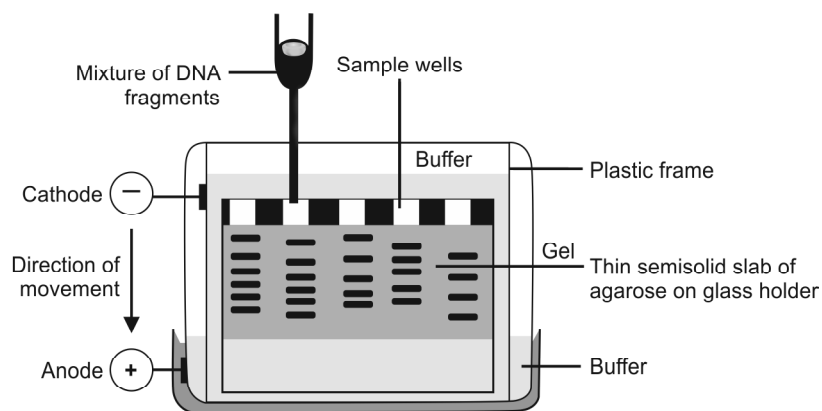

Fig. 32.2: Gel electrophoresis

iv. **Transfer of DNA to nylon (Southern blotting)**

- It is possible to identify specific DNA fragments that hybridize with a complimentary genetic probe. However, it is impossible to hybridize a probe to DNA fragments contained in a gel. For this reason, the DNA is usually denatured and then transferred to a nitrocellulose or nylon membrane which picks up the DNA like a blotter picks up ink. DNA is transferred to the membrane by capillary action and fixed by baking, making it accessible to a probe. The resulting blot formed is essentially a replica of the gel.
- This method of detecting DNA fragments—separating them by gel electrophoresis and then transferring them to a nitrocellulose/nylon membrane—is called *Southern blot*, named after its inventor,⁴ Dr Edward Southern. Similar blotting techniques are used to study RNA (*Northern blot*), and proteins or polypeptides (*Western blot*).^{5,6}

v. **Hybridization:** Adding known radioactive DNA-probes (short sequence probe, complimentary to the region of DNA which one wishes to detect) to the nylon sheet leads to fragment location. The nylon membrane is immersed in a solution that contains DNA probe impregnated with radioactive P³². Each probe typically sticks in only one or two specific/complementary sequences on the nylon sheet. This process is termed as *hybridization*.

vi. **Washing:** The membrane is washed to remove excess or unbound probe and exposed to an X-ray film.

- The resulting spots on the X-ray film correspond to the locations of the fragments in the gel that are complimentary to the probe (*autoradiography*).
- Nowadays, many radioactive probes are detected by chemical luminescence which is analyzed by computer scanners, eliminating the need for autoradiography.

vii. **DNA fingerprint:** The final print is known as an autoradiograph or 'DNA fingerprint' which appears as lines on the film.

Current practice in the use of DNA samples for crime investigations and paternity suits does not use multilocus DNA analysis, but utilizes highly polymorphic single locus genes such as the VNTR genes. Due to the large number of distinguishable alleles in most populations, it is possible to establish a 'DNA signature' for almost any individual.

Limitations

- It takes few weeks to perform.
- For every probing, the membrane is stripped off the previous probe and rehybridized and autoradiography performed again.

- It is not useful where DNA is degraded—limited value in testing cadaveric tissue for identification of human remains, unless fresh.

- **Gel electrophoresis:** Technique that separates macromolecules—either nucleic acids or proteins—on the basis of size, electric charge and other physical properties, across a span of gel, motivated by an electrical current.
- Both DNA and RNA migrate through the gel towards the positive pole of the electrical field because they are negatively charged due to their phosphate groups (Fig. 32.2).

PCR

- PCR is a technique used for amplifying sample of DNA fragments in vitro.
- PCR won its discoverer *Kary B. Mullis*, a Nobel Prize in chemistry for his work in 1993.
- In this process, a particular DNA segment from a mixture of DNA chains is rapidly replicated, producing a large, readily analyzable sample of a piece of DNA; the process is also called **DNA amplification**.^{7,8}
- PCR itself does not accomplish DNA typing, but increases the amount of DNA available for typing.
- It is used to produce multiple copies of segments from a very limited amount of DNA. Once a sufficient sample has been produced, the pattern of the alleles from a limited number of genes is compared with the pattern from the reference sample.
- A nonmatch conclusively excludes a suspect, but the technique provides less certainty when a match occurs.

Procedure

The theory behind PCR is based on certain aspects of DNA replication. The enzyme DNA polymerase helps to expand a short sequence into a longer one or a polymer. But DNA polymerase needs single stranded DNA that acts as a template for the synthesis of a new strand. It also requires a small portion of double stranded DNA to initiate synthesis (primers). Then, new DNA strands are synthesized and amplified behind the primer.

Requirements for PCR⁹

- Heat resistant DNA polymerase (Taq polymerase)
- Primers (short sequences of nucleotides designed to bind at the end of the desired DNA segment)
- Deoxynucleoside triphosphates (equal amounts of dATPs, dTTPs, dCTPs, dGTPs)
- DNA-fragments

Three steps are involved in this process (Fig. 32.3):

- i. **Denaturation:** Heating the double stranded DNA to almost boiling will dissociate and become single stranded.
 - ii. **Annealing:** Cooling the reaction will cause the primers to pair up with the single-stranded template (annealing). On the small length of double-stranded DNA (the joined primer and template), the polymerase attaches and starts copying the template.
 - iii. **Extension:** DNA building blocks complementary to the template are coupled to the primer, making a double stranded DNA molecule.
- Each separated strand can serve as a template for synthesis as long as primer is provided for each strand, and the reaction is cooled to cause the primers to bind. The primers are chosen to flank the region of DNA that is to be amplified. New primer binding sites are generated on each synthesized DNA strand.
 - This cycle of DNA denaturing, primer annealing and strand synthesis is repeated multiple times, thereby amplification of the target DNA.
 - After 20 heating and cooling cycles, this exponential process yields 2^{20} , or more than a million copies of the target sequence.
 - The process is completely automated with thermocyclers that contain a heating block and microprocessors. The time and temperature can be programmed for repetitive cycles of heating and cooling, alleviating manual intervention.

Other PCR based methods

- Dot blots, involving a series of DNA probes to detect target sequences such as the HLA DQa locus in chromosome 6, producing a pattern of colored dots

- Amplified fragment length polymorphism (AmpFLP)
- Short tandem repeats (STRs) in which the core repeat unit are 3-7 bp length
- System utilizing mitochondrial DNA
- Digital DNA typing

STR analyzes the DNA segments for the number of repeats at 13 core loci. STR analysis is less susceptible to DNA degradation than other AmpFLPs. The chance of misidentification in this procedure is one in several billion.

Applications: PCR technique has virtually limitless applications. It enables researchers to amplify and analyze tiny DNA samples from variety of sources—ranging from crimes scenes to archeological remains.

Limitation: It is too sensitive; a tiny amount of contaminant DNA in a sample may become amplified if it includes a DNA sequence complimentary to the primers, leading to an erroneous conclusion.

- PCR can be carried out efficiently if the DNA polymerase can remain stable through many heating cycles since denaturation and primer extension often occur at approximately 92°C and 72°C respectively, so a heat resistant enzyme known as *Taq polymerase* (derived from *Thermus aquaticus*, a bacterium) is used.
- **Criteria to determine the source:** DNA testing laboratories use a two-step process to determine if two samples arose from one source. First, DNA-banding patterns are compared visually. If banding patterns of a sample in question do not match a known DNA sample, exclusion is declared and no further analysis is required. Second, a visualized match is verified by a technique called computer assisted allele sizing which is done by computer software. Basically, the calculated sizes of an

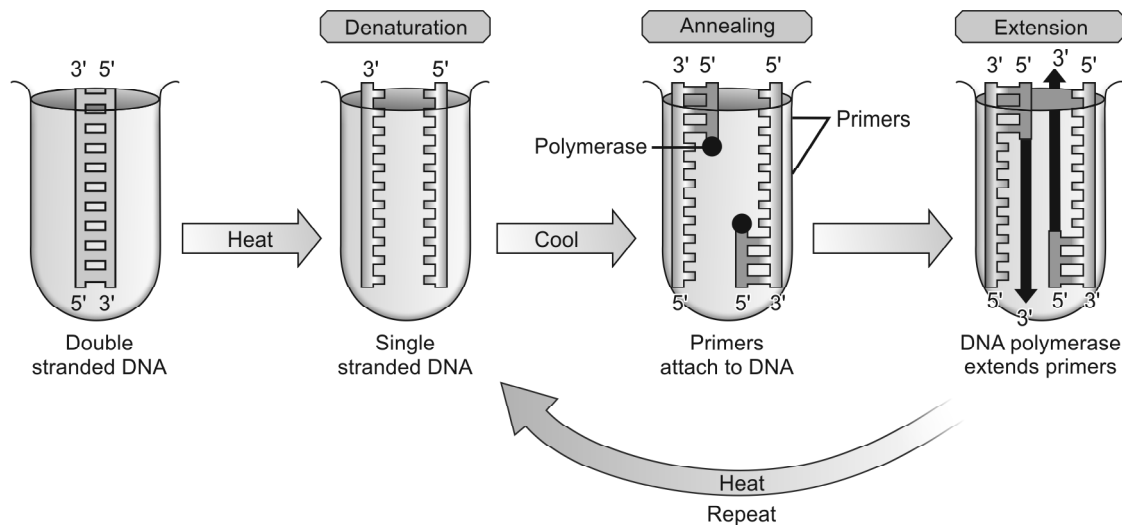

Fig. 32.3: Steps in PCR

apparent match should fall within 2.5% of each other. When samples fall outside of the 2.5% window, they should be considered 'nonmatching.' If the DNA-banding pattern of a sample cannot be positively determined due to technical problems, the results should be considered 'inconclusive.'

Specimen Selection and Preservation

Samples Collected from Living Subjects

- i. Blood (*most common sample*)
- ii. Buccal epithelial cells (buccal swabs)
- iii. Hair follicles with roots (plucked hair)

Samples Collected from Dead Bodies

(Flow chart 32.1)

DNA can be isolated and tested from practically any postmortem tissue, although after death it will undergo progressive degradation. DNA is broken down into fragments by autolytic and bacterial enzymes, especially DNases.

- i. In relatively fresh dead bodies, unclotted 10 ml of blood (EDTA anticoagulated in a sterile tube) is the preferable source of DNA.^{10,11} Buffers (e.g. those containing EDTA) are designed to inhibit the activity of nucleases that can breakdown DNA. Due to settling out of WBCs, clotted blood is not a good source of DNA.¹²
- ii. Brain tissue is a good source of DNA in intermediate postmortem intervals.

iii. Hard tissue (bone and vascular pulp of teeth) is the best source of DNA in cases of advanced decomposition.

- Best material is said to be muscle or spleen if decomposition is establishing; bone marrow (from femur) and teeth (usually molars) are also recommended.
- Postmortem material is inferior to live blood and tissue for DNA testing. Any disturbance to nuclear chromatin due to putrefaction is dangerous.
- Ten ml of blood or some tissue or swabs in a sterile tube should be taken and frozen at -20°C , if there is likely to be some delay in transmission to the laboratory.

Samples Encountered in Forensic Practice

- Blood (EDTA/heparinized/clotted/stain on cloth, newspaper, wood or tiles)
- Semen (stain on cloth/paper/floor)
- Hair (head/body/pubic)
- Tissue (bone marrow/muscle/spleen/fingernail scrapings)
- Mouth swabs and saliva stain on cigarette buds/licked envelope

Uses of DNA Fingerprinting

- i. **Identification:** It is used to link suspects to biological evidence—blood or semen stains, hair or items of clothing—found at the scene of a crime. It is used to establish identity of an assailant in sexual assaults, like rape, incest and bestiality.
- ii. **Diagnosis of inherited disorders** in adults, children, newborn and prenatal babies. It includes cystic fibrosis, hemophilia, Huntington's disease, familial Alzheimer's, sickle cell anemia and thalassemia. Genetic counselors use DNA fingerprint information to help prospective parents understand the risk of having an affected child or decisions concerning affected pregnancies.
- iii. **Developing cures for inherited disorders:** By studying the DNA fingerprints of relatives who have a history of some particular disorder or by comparing large groups of people with and without the disorder, it is possible to identify DNA patterns associated with the disease in question.
- iv. **Establish paternity** in custody and child support litigation. In these applications, DNA fingerprints bring a nearly perfect accuracy to the determination.

Flow chart 32.1: Sources of DNA

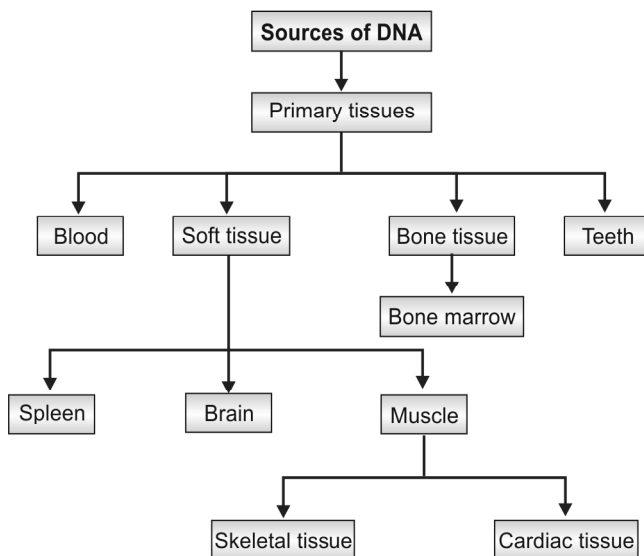

In this, DNA from both the children and their parents is cut by the same restriction enzyme. The DNA fragment is separated by gel electrophoresis for each individual in a separate lane. The patterns of bands thus formed (DNA fingerprints) is then compared between the children and his/her parents (Fig. 32.4). It should be noted that each band present in one of the children is also found in at least one of the parents.

- v. **Identifying the remains of soldiers:** In US armed services, a program is there to collect DNA fingerprints from all personnel for use later, in case they are needed to identify casualties or persons missing in action.
- vi. Biologists routinely use it, particularly to protect endangered species.
- vii. Accidents/mass disaster investigations and postmortem identification of skeletal remains/mutilated bodies.
- viii. Pedigree analysis of pets.

Limitations of DNA Testing

Generally, courts have accepted the reliability of DNA testing and admitted DNA test results into evidence. But, DNA fingerprinting is controversial in a number of areas:

- i. **Uniqueness of DNA fingerprinting:** DNA segments rather than complete DNA strands are 'fingerprinted', a DNA fingerprint may not be unique.
- ii. **Time constraints:** The process is lengthy, with each of four or five loci exposed sequentially, it usually takes 10 weeks.
- iii. **Accuracy of the results:** Tests are often performed in private laboratories that may not follow uniform testing standards and quality controls. Ambiguity in interpretation of the bands may arise from scientist's own misinterpretation of band-pattern and on the other hand, it may occur from actual

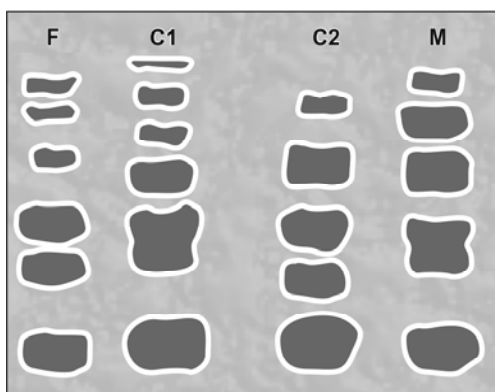

Fig. 32.4: DNA fingerprints for two children (C1 and C2) and their parents; father (F) and mother (M)

shifts, degradation, missing bands, extra bands—all due to technical problems.

Moreover, forensic specimens are often contaminated, making the extraction of pure DNA difficult and cross contamination of DNA between two specimens, or aerosol DNA from previous reactions on one's hands at very small concentrations can alter results.

- iv. **Cost:** Testing is expensive.
- v. **Invasion of privacy and ethical concerns:** In the US, the FBI has created a national database of genetic information called the Combined DNA Index System (CODIS). Similar database is present in UK also. The database contains DNA obtained from convicted criminals and from evidence found at crime scenes. Some experts fear misuse of the database, such as identifying individuals with stigmatizing illnesses such as AIDS.
- vi. Suspects who are unable to provide their own DNA experts may not be able to adequately defend themselves against charges based on DNA evidence.
- vii. Unlike fingerprints, DNA profile cannot be enlarged and shown in the court of law.

- In 1986, DNA fingerprinting was used by Jeffreys for the first time in UK, clearing a suspect of two rapes and murders and helping convict the culprit Colin Pitchfork.¹³ The first criminal conviction based on DNA evidence in the US occurred in 1988. It was only in 1996 that the DNA evidence was accepted in a court in India (in the 'tandoor murder case' reported in New Delhi).
- **Mitochondrial DNA (mtDNA)**, a small circular genome located in the mitochondria, has provided forensic scientists with a valuable tool for determining the source of DNA recovered from damaged, degraded or very small biological samples. Cells contain hundreds of copies of mtDNA genomes, as compared to two copies of the DNA located in the nucleus. This increases the likelihood of recovering sufficient DNA from compromised DNA samples, and for this reason mtDNA can play an important role in missing persons investigations, mass disasters and other investigations involving samples with limited biological material. Additionally, mtDNA is maternally inherited.¹⁴ Therefore, barring a mutation, an individual's mother, siblings, as well as all other maternally-related family members will have identical mtDNA sequences. As a result, comparisons can be made using a reference sample from any maternal relative, even if the unknown and reference sample are separated by many generations.
- **Nucleic Acid Sequence Based Amplification (NASBA)**, is used to amplify RNA sequences.⁸
- **Ligase chain reaction:** Method of DNA amplification similar to PCR.⁸
- **DNA sequencing:** Biochemical methods for determining the order of the nucleotide bases in a DNA oligonucleotide.⁸

MULTIPLE CHOICE QUESTIONS

1. DNA fingerprinting was discovered by: *PGI 06*
 A. Southern B. Galton
 C. Crick D. Jeffery
2. What is matched in DNA fingerprinting: *PGI 08; WB 11*
 A. Introns
 B. Exons
 C. Constant number of tandem repeats
 D. Minisatellites
3. Restriction endonuclease is: *Maharashtra 08*
 A. Break single stranded DNA
 B. Break double stranded DNA
 C. Break peptide chain
 D. Break RNA
4. Restriction fragment length polymorphism uses the technique of: *UP 10; NIMHANS 11*
 A. Southern blotting B. Northern blotting
 C. Western blotting D. Eastern blotting
5. Northern Blotting is for: *JIPMER 11*
 A. RNA B. DNA
 C. Proteins D. Maternal DNA
6. Western blot is used for: *FMGE 09; AIIMS 09*
 A. RNA B. DNA
 C. Proteins D. Maternal DNA
7. PCR is done for: *UP 11*
 A. Cloning of DNA in cells
 B. Replication of DNA in vitro
 C. Sequencing of DNA
 D. Both A & B
8. DNA amplification is done in by all, except: *PGI 06*
 A. Polymerase chain reaction
 B. Nucleic Acid Sequence Based Amplification
 C. Ligase chain reaction
 D. DNA sequencing
9. PCR does not require: *PGI 05; AIIMS 07*
 A. Primer
 B. DNA-fragments
 C. DNA polymerase
 D. Radio-labeled DNA probe
10. For DNA test, liquid blood is preserved in: *Karnataka 07; DNB 09; UP 10*
 A. Sodium citrate B. Potassium oxalate
 C. EDTA D. Sodium fluoride
11. Best forensic sample for DNA analysis is: *TN 09*
 A. Blood in EDTA B. Hair
 C. Vitreous humor D. Femur bone
12. DNA fingerprinting can be done with all, except: *UP 07; Delhi 08*
 A. RBC B. WBC
 C. Saliva D. Spermatozoon
13. DNA fingerprinting was first used by Jeffrey in a criminal case for detecting: *Manipal 11*
 A. Murder B. Rape
 C. Disputed paternity D. Immigration purpose
14. Mitochondrial DNA inheritance is transmitted from: *UP 10*
 A. Mother B. Father
 C. Grandfather D. Grandmother

1. D 2. A & D 3. B 4. A 5. A 6. C 7. B 8. D 9. D 10. C
 11. A 12. A 13. B 14. A

Definition: Torture (Latin *tortura*: act of twisting) is 'a deliberate, systemic or wanton infliction of physical or mental suffering by one or more persons acting alone or on the orders of any authority, to force another person to yield information, to make a confession, or for any other reason' (as per WMA's **Declaration of Tokyo**).

- This declaration states that doctors should refuse to participate in, condone or give permission for torture, degradation or cruel treatment of prisoners or detainees.
- Throughout history, torture has often been used as a method of effecting political re-education. Nevertheless in the 21st century, torture is almost universally considered to be an extreme violation of human rights, as stated by the Universal Declaration of Human Rights.
- Torture medicine is one of the recent branches of medicine dealing with various aspects of torture from medical point of view.

Ethical Issue

Organizations, like Amnesty International argue that the universal legal prohibition is based on a universal philosophical consensus that torture and ill-treatment are repugnant, abhorrent and immoral. But to obtain information from suspected terrorists by using torture methods to save innocent civilians, is debatable.

Reasons for Torture

UN Convention identifies four reasons for torture:

- To obtain a confession
- To obtain information
- To punish
- To coerce the sufferer or others to act in certain ways

Types of Torture

Four types

- | | |
|----------------------|-------------------|
| i. Physical | ii. Psychological |
| iii. Pharmacological | iv. Sexual |

Physical Torture

It is the inflicting of pain on the body.

Various methods are:

- Beating:** It is the most common form of torture. Beating can be from head to toe using fist, shoe, wooden bars, rods, whips or similar objects.
 - The victim may be suspended upside down and then beaten on the soles by blunt instruments such as sticks, clubs or rifle butts [*bastinado* or *falanga*].¹
 - Poking the victim with a baton or rod is common.
 - *Beating buttocks:* Literally, this is called 'passing the board'. A victim is forced to the ground and beaten viciously with a board, club or baton.
 - Beating on the abdomen while lying on a table with the upper half of the body unsupported ('operating table' or '*el quirofano*').
 - A pole is placed on the back of victim and is pressed down with great weight and then rolled up over the legs and the body ('the roller' or '*belena*').
 - *Ear torture:* Repeated and simultaneous slapping of both the ears by open hands of the torturer ('*telefono*').²

Beating/flogging results in scars, bruises, lacerations and fractures at different stages of healing and which have not been treated medically. Many of these weapons leave a characteristic patterned bruising (including tramline bruising, finger grip or slap mark) on the skin.

- Forcing the person in abnormal positions:** It can be:
 - Prolonged standing ('*el planton*') like in the 'Army Corps' posture or body-folding or on one leg.
 - Sitting (iron chair sitting) or forced to squat for a long time.
 - Forced straddling on a bar ('saw horse' or '*el cabellete*') or tied up in an abnormal position for hours ('hogtie').
- Suspension**
 - Victim may be suspended by his wrists ('*la bandera*'), ankles ('*murcielago*'), arms or hair.

- Person may be suspended head down from a horizontal pole placed under the knees with the wrists bound to the ankles ('parrot's perch', 'jack' or 'pau de arara').
 - iv. **Burns:** Torturers use hot iron, cigars and lighters to burn fingers, toes, faces, nipples, vagina and other parts of victim's bodies.
 - In *Black Slave*, a hot metal skewer is inserted up the anus.
 - v. **Suffocation:** Near-suffocation may occur by means of a plastic bag placed over the head of the victim ('dry submarine').³
 - vi. **Waterboarding** (simulated drowning) consists of submerging the victim's head repeatedly under water or in foul liquid, like sewerage water. Forced suffocation and water inhalation cause the subject to experience the sensation of drowning. It has been referred to as 'water torture,' 'water cure,' 'el submarino' ('wet submarine'), 'pileta' and dunking.
 - vii. **Pulling/twisting of nail/hair/teeth/genitalia or forcing bamboo sticks under the fingernails:** One or combination may be used.
 - Victim is dragged by hair or the hair is cut short or shaven.
 - Teeth may be pulled out or broken down by clips or forceps causing hemorrhage and fracture.
 - Pencil or similar objects are placed in between two fingers and then squeezed hard or twisted.
 - viii. **Electric baton shock:** Electric shock is given by putting the charged batons over the sensitive parts of the body, like nipples, genitalia or anal canal.
 - Prior to the development of stun batons and the taser, *electric cattle prods* ('picana') were used to torture humans wherein the current is applied with a pointed object.
 - ix. **Irritant torture:** Irritating chemicals (e.g. chillies) may be inserted into the rectum or vagina, or applied on the eyes or external genitalia.
 - After contact with hemp (a plant), the skin immediately becomes inflamed, extremely itchy and painful. Victims are slapped, or stripped naked and thrown onto a pile of hemp.
 - x. **Cold torture:** Icy water is poured over head or forced to strip naked and stand outside on a winter night or forced to stand in snow or on ice with bare feet or submersing in ice-cold water.
 - xi. **Force-feeding** of saturated salt-water, vinegar, liquor, pepper, mustard oil, boiling water, urine or feces.
 - xii. **Shooting** as means of execution or nonfatal punishment is carried out in some parts of the world.
 - Victims are sometimes shot either through knee joint or thigh (*knee-capping*).
- Some acute findings in physical torture are highlighted in Table 33.1.
- Battered body:** Deaths usually result from severe closed blunt force head injuries with cerebral contusion and laceration, with or without skull fracture. Blunt trauma to the abdomen is the second most common cause of death due to tearing of the mesentery or laceration of internal organs.
- Psychological Torture**
- It uses non-physical methods to induce pain in the subject's mental, emotional and psychological states.

Table 33.1: Findings in some specific physical torture methods

Method	Findings
Beating	
• Falanga	Hematoma of the soles of the feet
• Quirofano or operating table	Bruise, ruptured abdominal viscera
• Telefono	Ruptured tympanic membranes
• Belana	Crushing of soft tissue and damage to muscles of the legs and the body
Forced posture	
• Saw horse (el cabellete)	Perineal bruising
• Prolonged standing (el planton)	Dependent edema and petechiae
Suspension (bandera, murcielago, parrot's perch/pau de arara)	Bruising, nerve and muscle damage, joint injuries
Waterboarding (wet submarine)	Fecal matter and other debris in the airways
Plastic bug suffocation (dry submarine)	Lung petechiae
Electric cattle prod (picana)	Reddish brown lesions at points of contact, burning and scarring
Burns (Black slave)	Peri-anal or rectal burns
Nail torture	Hemorrhage

Psychological torture includes deliberate use of extreme stressors and situations, such as mock execution*, shunning, violation of deep-seated social or sexual norms or taboos and extended solitary confinement.

It is categorized into:

- i. **Deprivation technique:** Deprivation of sleep, food or water, deprivation of use of toilet, sanitary napkins, shower or change of clothes, or prohibition of eye contact and talk (social deprivation) are some of the methods.
- ii. **Coercion technique:** Threats, humiliations and sexual torture are included in this category.
- iii. **Communication technique:** Disinformation and conditioning of new reflexes are some of the methods.
- iv. **Witness torture:** Victims are forced to witness the torture of another prisoner.

Pharmacological Torture

It uses psychotropic and/or other chemicals to induce pain and cause compliance with the torturer's goals. It includes forced ingestion or injection of psychotropic drugs (e.g. dimenhydrinate, R015-4513), or being forced to ingest (or be injected with) chemicals or other products (such as broken glass, heated water or soaps) that cause pain and internal damage.

Sexual Torture

It includes:

- Undress or paraded naked or photographed in humiliating position (usually in women)
- Sexual assault like rape/gang rape, fellatio or forced masturbation, sodomy (usually in males)
- Forced abortion
- Pinching or biting off of nipples
- Electric baton shock of nipples and vagina
- Inserting bottles and rods inside the vagina
- Psychological assault, like forced nakedness, sexual humiliation or forced witness of sexual torture

It is usual for the torturer to use more than one method to traumatize the victim.

Sequelae of Torture

- i. Physical problems can be wide-ranging, e.g. STDs including AIDS, musculoskeletal pain, fractures, brain injury, post-traumatic epilepsy or chronic pain syndromes.

- ii. Psychological includes post-traumatic stress disorder (PTSD), phobia, sleep disturbances, irritability, aggressiveness, sexual problems, suicide ideation, depression and anxiety disorder.
- iii. Social sequelae includes loss of job, stigma or rejection by society.

Management: Treatment of torture victims might require expertise and often specialized experience. Common treatments are psychotropic medication, e.g. SSRI antidepressants, counseling, cognitive behavioural therapy, family systems therapy and physiotherapy.

Medical Practitioner and Torture

At times, medicine and medical practitioners have been drawn into the ranks of torturers, either to judge what victims can endure, to apply treatments which will enhance torture, or as torturers in their own right. Medical torture may involve the use of their expert knowledge to facilitate interrogation or corporal punishment, in the conduct of unethical human experimentation or in providing professional medical sanction and approval for the torture of prisoners.

Torture is often difficult to prove, particularly when some time has passed between the event and a medical examination. Many torturers around the world use methods designed to have a maximum psychological impact, while leaving only minimal physical traces.

Medical and Human Rights Organizations worldwide have collaborated to produce the Istanbul Protocol, a document designed to outline common torture methods, consequences of torture and medico-legal examination techniques. Typically, deaths due to torture are shown in an autopsy as being due to 'natural causes' like heart attack due to extreme stress.

Legal aspects: Apart from various sections relating to injury, assault and homicide, Secs. 330 and 331 IPC respectively deals with voluntarily causing hurt and grievous hurt for the purpose of extorting confession or any information which may lead to the detection of an offence or misconduct.

- Offences under these sections are cognizable and non-compoundable; punishment for hurt is imprisonment for 7 years and fine, and for grievous hurt imprisonment for 10 years and fine.

* *Sham execution:* Victim is blindfolded and made to stand before a wall and then threatened that a vehicle is going to hit him.

Custodial Deaths

Definition: Death in custody (Latin *custosodis*: guardian) should include the following categories:

- i. The death of a person in prison/police custody.
 - ii. The death of a person is caused or contributed by traumatic injuries sustained, or by lack of proper care while in custody or detention.
 - iii. The death of a person in the process of police or prison officers attempting to detain that person.
 - iv. The death of a person in the process of escaping or attempting to escape from prison/police custody.
- The postmortem report is the most valuable record and considerable importance is placed on this document in drawing conclusions about the death, and hence should be carried out properly without inordinate delay in writing.
 - A meticulous autopsy is needed to confirm or dispel the allegations of custodial deaths.
 - Exhaustive notes must be made, including the description of how the deceased was identified.
 - Elongated X-shaped incision on the back for subcutaneous tissue dissection is carried out in custodial death cases. This is useful to evaluate the extent of blunt injuries which are usually missed when superficial imprints are faint, particularly when present on the skin and not on overlying bone (Fig. 33.1).

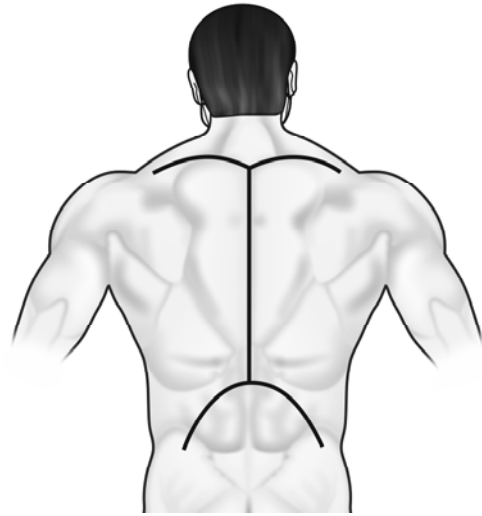

Fig. 33.1: Elongated X-shaped incision on the back

- The National Human Rights Commission (NHRC), a statutory body has directed the law and order agencies at the district level throughout the country to report matters relating to custodial death or rape within 24 h of occurrence.
- With a view to prevent tampering of postmortem reports, the NHRC issued instructions to all the States to video-film the postmortem examination of all suspected cases of custodial deaths and send the CDs to the Commission. The Commission also decided to revise the autopsy form to plug the loopholes and to make it more incisive and purposeful.

MULTIPLE CHOICE QUESTIONS

1. 'Falanga' is: *AIIMS 08; TN 09; DNB 10*
 - A. Sitting in abnormal position
 - B. Hitting the feet with stick
 - C. Electric current for torture
 - D. Pulling of hair
2. 'Telefona' is: *AIIMS 07; DNB 10*
 - A. Beating on soles
 - B. Bilateral beating on ears
 - C. Pulling of ears
 - D. Hitting with telephone
3. 'Dry submarine' in custodial torture refers to: *Karnataka 04*
 - A. Beating on soles of feet
 - B. Tying of a plastic bag over the head
 - C. Immersing head in contaminated water
 - D. Suspending the accused by ankles

Hospital and health care workers are concerned about the transmission of AIDS from the patient's blood and body fluids. Patients are concerned that they may be exposed to AIDS from healthcare workers or other patients in the hospital-setting.

Body fluids responsible for transmitting HIV include blood, semen, vaginal secretions, breast milk, and cerebrospinal, peritoneal, amniotic, pericardial and synovial fluids. Other fluids, such as saliva, tears and urine are not implicated in the transmission of HIV, unless they contain visible blood.^{1,2}

HIV Testing Policy

Testing can be:

- i. Compulsory
- ii. Mandatory
- iii. Voluntary

- For *compulsory testing* to be legally acceptable, there must be a strong public interest that overrides the individual's right to privacy, e.g. HIV testing of all military recruits, compulsory screening of prison inmates or applicants for immigration.
- *Mandatory testing* is recommended only for screening donors of blood, semen, organs or tissues in order to prevent transmission of HIV to the recipient of the biological products. In Andhra Pradesh, legislation was passed, making the AIDS/HIV test mandatory for all persons of marriageable age.

National AIDS Control Organization (NACO) Guidelines

The American Medical Association advises against mandatory testing and recommends voluntary informed consent testing of patients in the high-risk groups undergoing surgery or other invasive procedures. Some states in US allow nonconsensual antibody testing of hospital patients, when health care providers are immediately threatened by exposure to disease.

As per NACO policy, *HIV testing is to be carried out on a voluntary basis* with appropriate pre-test and post-test counseling. Moreover, the disclosure of HIV status of the

person should not in any way affect his rights to employment, position at the workplace, right to medical care and other fundamental rights.

- HIV positive women should have the complete choice to make decisions about pregnancy and childbirth, and proper counseling should be given to them to enable them to decide whether to continue or terminate the pregnancy.
- They should be advocated to avoid pregnancy as there is a one in three chance of having an infected child.
- There should be no forcible abortion or even sterilization.
- As far as the breast-feeding is concerned, it may result in transmission of HIV from mother to child.

HIV Testing

- The result of the HIV test must be kept confidential and even health care workers who are not directly involved in the care of the patient should not be told about the result.
- Surveillance of HIV positive cases in the country does not require reporting of the identification data of the patient.
- Purpose of HIV surveillance is to measure the level and trends of HIV infection in a given geographical area over a period of time.

Health Care Workers and HIV Infection

A sensitive question is whether an employer, particularly a health care employer may screen employees for HIV infection and refuse to employ, terminate employment or limit employment of people who are seropositive.

The Government of India has issued a comprehensive HIV testing policy and the following issues are reiterated here:

- No individual should be made to undergo a mandatory testing for HIV.
- No mandatory HIV testing should be imposed as a precondition for employment or for providing health care facilities during employment.

- Equal rights to education and employment for HIV positive persons.
- HIV status to be kept confidential.

Health care workers who are known to have antibodies to the virus might be advised to refrain from participating in certain surgical procedures.

- When a health care provider is seropositive or develops AIDS, the hospital should review the staff's privileges and determine whether or not the medical condition interferes with the person's ability to perform the job, and whether the condition creates a health risk to the patients.
- The health care provider's performance must be continuously monitored and evaluated with the goal of protecting the patient.
- It has been recognized that certain direct patient care areas, such as surgery, may create an increased risk of transmission of HIV from the doctor to the patient. Although NACO does not recommend that HIV-positive individuals be routinely restricted from performing surgery, it does recommend that the restrictions be determined on a case by case basis.
- There is no generally accepted medical evidence that HIV can be transmitted through normal day-to-day contact in typical private workplace settings. Since, present medical evidence indicates that the HIV infected individuals pose virtually no threat of infection to fellow workers, HIV-positive persons in most settings may be permitted to continue their employment as long as they are able to perform their job.

The Centre for Disease Control (CDC), estimates that 5.5% of all HIV positive persons are employed in the health care field. According to the guidelines issued by CDC, with the exception of health care workers and personal service workers who use instruments that pierce the skin, no testing or restriction is indicated for workers known to be infected with HIV, but otherwise able to perform their jobs.

Partner Notification (Contact Tracing, Partner Counseling)

It refers to activities aimed at identifying, notifying and counseling the sexual and needle sharing partners of an individual with HIV ('index person') about their exposure, and offering services.

There are two approaches to partner notification:

- Patient referral:** HIV-positive persons are encouraged to notify partners of their possible

exposure to HIV, without the direct involvement of health care providers.

- Provider referral:** HIV-positive persons give partners' names to health care providers or other health workers, who then confidentially notify the partners directly.

There are two approaches to informing third parties:

- Contact tracing:** The contact tracing approach emerged from sexually transmitted disease programmes. It is based on the patient's voluntary cooperation in providing the names of contacts, this entailed protecting the absolute confidentiality of the entire notification process, without disclosure of the identity of the index case.
- Duty to warn:** This approach came out of the clinical situation where the physician knew the identity of the person deemed to be at risk, e.g. sexual partner of an HIV positive individual. It argued for disclosure to endangered persons without consent of the patient, due to his moral 'duty to warn'. It could also involve the revelation of the patient's identity.

Patient confidentiality continues to be a central issue, even in those subjects in whom the 'duty to warn' tradition has been invoked.

- Persons unknowingly placed at risk from an ethical perspective of a clinical relationship, have a moral right to information in order to protect themselves, seek testing and commence treatment, if necessary.
- Since most public health strategies for dealing with HIV are based on individuals coming forward voluntarily for testing, counseling and treatment, failure to maintain confidentiality could threaten the continued cooperation of people with HIV.

Neither the principle of confidentiality nor the value attached to professional autonomy is absolute. Early identification of HIV infection in asymptomatic individuals has become increasingly beneficial with the availability of antiviral therapy and prophylactic antimicrobial agents.

Today, however, it is almost universally recognized that partner notification programs can make a positive contribution to a successful HIV/AIDS public health and prevention program, particularly with regard to persons who may be unaware that they are at any increased risk of HIV infection, and as a result are not informed or aware of any need to practice risk-reducing behavior. Partner notification programs can encourage these persons to seek HIV testing.

The Supreme Court of India has recently ruled for disclosure of the HIV positive status by the doctor to his patient's wife/spouse. Though, the decision has correctly dealt with the legal position of when confidentiality of a patient should be breached by the doctor, it has not laid down the parameters around which such disclosure should or should not be made. The judgment went on to state that persons with HIV infection who knowingly expose others to health risk are guilty of an offence punishable under law.

Clinical Trials and HIV

The highest ethical standards must be upheld when collecting behavioral or biological data on sexually transmitted infections, including HIV/AIDS. Because of the stigma and human rights issues around HIV/AIDS, study participants may experience psychological, social, physical or economic harm, even when precautions are taken. Data collection protocols or procedures should include an explicit description of the measures that will be taken to protect the subjects.

Blood Donation and HIV

It is mandatory for every unit of blood collected at blood banks in India to undergo screening and test negative for HIV-1 and HIV-2 prior to being declared fit for transfusion and/or further processing for preparation

of blood products and blood components. The result of such testing must be clearly indicated on the label.

According to guidelines laid by the Government of India, the status of HIV should not be disclosed to blood donor. The intention is to spare him of the agony of knowing the helplessness of his situation. If the blood drawn is positive, it should be discarded. Once blood sample is drawn, the register of patient identities should be kept separate and samples identified only with a code number. If the donor wants to know the result of HIV test, he should be referred to an accessible HIV testing centre where supplemental tests with counseling will be offered to him.

Legal Aspects

If a person suffering from AIDS, knowingly marries or has sexual intercourse with a normal person and thereby transmits the infection to other person, he would be guilty of offences under Sec. 269 IPC (imprisonment for 6 months with/without fine) and Sec. 270 IPC (imprisonment for 2 years with/without fine). He may even be charged under Sec. 302 and Sec. 299 IPC, if the person intentionally has sexual intercourse in order to infect the other person.

A civil suit may be filed to claim compensation for violation of the fundamental rights to personal liberty.

MULTIPLE CHOICE QUESTIONS

1. **Body fluid NOT responsible for the transmission of HIV:**

Kerala 06

- | | |
|----------|----------------|
| A. Semen | B. CSF |
| C. Tears | D. Breast milk |

2. **Which of the following has more HIV load:**

JIPMER 09

- | | |
|----------------|-----------|
| A. Urine | B. Sweat |
| C. Breast milk | D. Saliva |

Polygraph

A **polygraph** ('lie detector') is a device which makes a continuous record of several physiological variables, such as *blood pressure, heart rate, respiration* and *electrodermal reaction**, while a series of questions are being asked, in an attempt to detect lies (Fig. 35.1). The above measurements are believed to be indicators of anxiety due to sympathetic stimulation that accompanies the telling of lies. However, if the subject exhibits anxiety for other reasons, a measured response can result in unreliable conclusions.

- A polygraph test is also known as a *psychophysiological detection of deception* (PDD) examination.

Procedure

There are two major testing techniques in use—the Relevant/Irrelevant Technique (RIT) and the Control Question Technique (CQT). Polygraph test starts with a pre-test interview to gain some preliminary

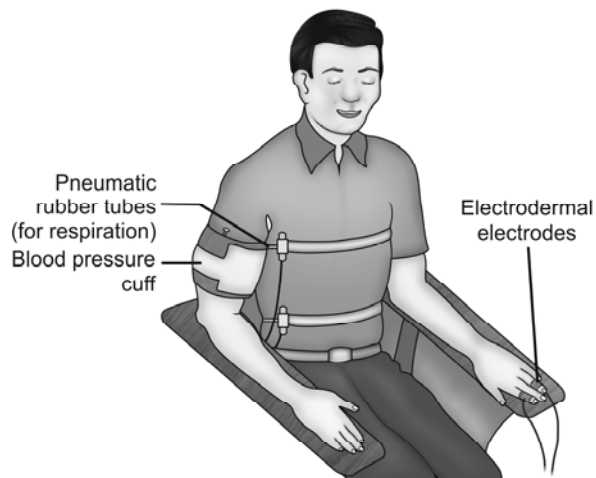

Fig. 35.1: Polygraph test

information which will later be used for 'control questions,' CQ. Some of the questions asked are 'irrelevant' or IR, others are 'probable-lie' control questions that most people will lie about and the remainder are the 'relevant questions,' or RQ, that the tester is really interested in. The different types of questions may alternate.

Accuracy

Examiners maintain that the accuracy is 90% and the errors tend to be false negative rather than false positive, i.e. a person who actually lied is reported as 'truthful'.

Admissibility of Polygraphs in the Court

- While lie detector tests are commonly used in police investigations in US, no defendant or witness can be forced to undergo the test. The US Supreme Court left it up to individual jurisdictions as to whether polygraph results could be admitted as evidence in court cases.
- In most European jurisdictions, polygraphs are not considered reliable evidence and are not generally used by police forces.
- In Canada, the use of a polygraph is sometimes employed in screening employees for government organizations. However, in the 1987, the Supreme Court of Canada rejected the use of polygraph results as evidence in court.
- The Australian High Court has not yet considered the admissibility of polygraph evidence.

Brain Fingerprinting (Brain Mapping)

Brain mapping is a group of neuroscience techniques based on the mapping of quantities or properties (biological) onto spatial representations of the brain.

* It is also known as galvanic skin response (GSR), electrodermal response (EDR) or skin conductance response (SCR)—a method of measuring the electrical conductance of the skin, which varies with its moisture level.¹

While various brain imaging techniques (e.g. CT, MRI, PET, SPECT) measures properties such as cerebral blood flow, metabolism or structural integrity, QEEG (quantitative EEG) measures electrical activity of the brain which is usually known as **brain mapping**.²

Brain fingerprinting, invented by Lawrence Farwell, is a computer-based test that is designed to discover, document and provide evidence of guilty knowledge regarding crimes. This test detects the presence or absence of information and not guilt or innocence per se.

Procedure

- An elastic cap (headband) with 19 electronic sensors is placed on the shaven scalp of the subject and connected to the recording device that measures the EEG. The subject is shown stimuli consisting of sounds, words, phrases or pictures on a computer screen.
- It detects response to the stimuli related to the crime or other investigated situation. The theory is that the suspect's reaction to the details of an event or activity will reflect, if the suspect had prior knowledge of the event or activity. As the test is based on EEG signals, it does not require the subject to issue verbal responses to questions or stimuli.

Principle

Farwell's brain fingerprinting originally used the P300 brain response (emitted from an individual's brain approximately 300 milliseconds after it is confronted with a stimulus of special significance) to detect the brain's recognition of the known information. Later, he used the MERMER ('Memory and Encoding Related Multifaceted Electroencephalographic Response'), which includes the P300 and additional features and is reported to provide a higher level of accuracy than the P300 alone.

Uses

- Criminal cases:* Investigators use it to determine if a suspect is telling the truth or make him reveal facts pertaining to a case.
- Medical diagnosis:* Brain functioning evaluation for early detection of Alzheimer's and other cognitive degenerative diseases.
- Advertisement:* Evaluates the effectiveness of advertising by measuring brain responses.
- National security:* Screening employees, especially in military and foreign intelligence and counter-terrorism.
- Insurance fraud.*

Drawbacks

The test may not be useful in a case in which:

- Two suspects were present at a crime—one as a witness and the other a perpetrator.
- Investigators do not have sufficient information about a crime so as to test a suspect for crime-relevant information stored in the brain.

Brain Fingerprinting vs Polygraph

Since it depends only on information stored in the brain and cognitive brain responses, brain fingerprinting does not depend on the emotions of the subject, nor is it affected by emotional responses. Brain fingerprinting is fundamentally different from the polygraph as it measures emotion-based physiological signals. Also, unlike polygraph testing, it does not attempt to determine whether or not the subject is lying or telling the truth.

Legal Aspects

- An Iowa Court in US accepted brain fingerprinting as scientific evidence in the reversal of the murder conviction of Terry Harrington.
- Data from Brain Electrical Oscillation Signature (BEOS) profiling was recently admitted as evidence in court in a murder trial in India.
- There has been not even a single case, in which the court has convicted a subject based *only* on the results of the brain fingerprinting. In fact, in the cases, wherein results of such tests were positive, but were not supported by other oral or documentary evidences, the subjects in those cases have been acquitted of the charges against them.

- Brain Signature Profiling (BSP) or BEOS is another EEG procedure which was developed in 2003 by CR Mukundan which is similar to brain fingerprinting.
- In the case mentioned above, the woman was convicted of murdering her former fiancé based on BEOS profile. But subsequently, the Mumbai High Court suspended her sentence and released her on bail due to a lack of sufficient evidence.

Narco-Analysis

Definition: It is a scientific procedure to obtain information from an individual in a natural sleep-like state.

Principle: The narco-analysis procedure dwells upon the effect of bio-molecules on the bioactivity of an individual.

- A person is able to lie by using his imagination. During the test, the subject's imagination is neutralized by making him semi-conscious. In this

state, it becomes difficult for him to lie and his answers would be restricted to facts he is already aware of.

- The subject is not in a position to speak up on his own, but can answer specific and simple questions.
- In such sleep-like state, efforts are made to obtain 'probative truth' about the crime.

Procedure: The individual is put to trance-like state and loses all his inhibitions by administering *sodium amytal* or *thiopentone sodium*, (known as 'truth drug' or 'truth serum') 2.5-5% solution, slow IV.

Other Methods

- 0.5 mg scopolamine hydrobromide, subcutaneously, followed by 0.25 mg every 20 min (average 3-6 injections), till proper stage of questioning is reached.³
- 100 mg sodium seconal, 15 mg morphine and 0.5 mg of scopolamine hydrobromide may be given IV.

The dose is dependent on the person's sex, age, health and physical condition. A wrong dose can result in a person going into a coma or even death.

Team required: A team comprising of an anesthetist, psychiatrist, clinical/forensic psychologist, audio-videographer and supporting nursing staff does the test. The forensic psychologist will prepare the report about the revelations which will be accompanied by a compact disc of audio-video recordings.

Legal Aspects

- Supreme Court has recently declared that narco-analysis, polygraph tests and brain-mapping cannot be done without the consent of the individual. If the person consents for such methods, then any information obtained can be used for further probe. Results of such tests will not be admissible as evidence, even if done with consent.

- Use of such methods are illegal and as against constitution. As per Article 20(3) of the Constitution 'No person accused of any offence shall be compelled to be a witness against himself'. Therefore, a suspect of the crime cannot be compelled to disclose facts which he can recall from his memory, and likely to implicate him in a crime in which he was involved.

Recent advances and development

- A non-surgical postmortem technique has been pioneered by forensic pathologists and radiologists for natural and unnatural deaths, for either single cases or mass fatalities. They have developed a quick and simple technique of 'minimally invasive targeted coronary angiography' where they inject contrast into the body of a deceased person through a small incision in the neck and then perform a full body CT scan. Using this method they were able to determine the cause of death in upto 80% of cases (in the series analyzed).
- There has been an increase in the use of condoms by sexual offenders either to avoid contacting STDs or to prevent transfer of DNA evidence. However, they are less likely to consider the possibility of condom lubricant transferring onto their fingertips and then into fingerprints left at the scene. Researchers have developed a method wherein they can detect this condom lubricant. They used MALDI-MSI (matrix-assisted laser desorption/ionization mass spectrometry imaging), a powerful technology that can be used to map fingerprint ridge patterns.
- Forensic researchers in UK have devised a method to detect smoking from the chemicals left behind in the fingerprints. The technique involves dusting the prints with a solution of gold nanoparticles, attached to which are antibodies that bind to cotinine—a metabolite of nicotine. Then the print is soaked in a fluorescent dye that binds to the antibodies.

MULTIPLE CHOICE QUESTIONS

1. In polygraph test 'GSR' stands for: *Karnataka 11*
 - A. Guilt Score Reaction
 - B. Galvanic Skin Reaction
 - C. Galvanic Sensor Reaction
 - D. Guilt Sensitivity Reaction
2. Brain fingerprinting: *PGI 06*
 - A. Used as lie detector
 - B. Uses EEG on lead
 - C. Used for quantitative measurement of sulci and gyri
 - D. Uses DNA
3. Commonly used in narco-analysis: *AI 10*
 - A. Atropine sulfate
 - B. Scopolamine hydrobromide
 - C. Opium compounds
 - D. Phenobarbital

Question Bank

All questions are must know and are either short notes or viva, if not mentioned otherwise. **Desirable to know questions** are given in the boxes. (**LQ**—long question, **Diff.**—differentiation)

Medical Jurisprudence and Acts

1. Forensic medicine, medical jurisprudence, ethics and etiquette
2. Functions of MCI and State Medical Council
3. Professional misconduct, penal erasure
4. Professional secrecy
5. Privileged communication
6. Unethical acts
7. Duties, rights and privileges of a RMP
8. Prevention of medical negligence and defenses in medical negligence suits
9. Medical maloccurrence, therapeutic misadventure
10. Professional negligence, Res ipsa loquitur
11. Contributory negligence
12. Consent, types, informed consent, rules
13. Vicarious responsibility
14. Malingering
15. Euthanasia
16. Acts—CPA, PNMT, MTP and Mental Health
17. Civil and criminal negligence (**Diff.**)
18. Professional misconduct and negligence (**Diff.**)

Desirable to know

Human Organ Transplantation Act

Legal Procedure

1. Inquest; Police and Magistrate inquest
2. Courts in India and their powers
3. Subpoena/summons
4. Conduct money
5. *Recording of evidence*: Oath, examination-in-chief, leading question, cross-examination, perjury
6. Documentary evidence, dying declaration
7. Types of witness: Expert, common, hostile
8. Conduct of a doctor in the witness box
9. Police and Magistrate inquest (**Diff.**)
10. Dying declaration and dying deposition (**Diff.**)

Desirable to know

Medical examiner system, coroner's inquest

Identification

1. Identification, types, corpus delicti
2. Cephalic index, types of skull
3. Nuclear sexing, Barr body, Davidson body
4. Intersex, types, Klinefelter and Turner syndrome
5. Eruption of temporary and permanent teeth
6. Gustafson's method
7. Spacing of jaw, superadded and successional teeth, period of mixed dentition
8. Age estimation: Ossification of long bones
9. Fusion of skull sutures: Metopic, anterior and posterior fontanelle, basiocciput with basisphenoid, coronal and sagittal
10. Tattoo marks, scars
11. Dactylography, types, MLI
12. Medico-legal importance of age (**LQ**)
13. Male and female skull, pelvis and mandible (**Diff.**)
14. Human and animal hair (**Diff.**)
15. Age changes in mandible (**Diff.**)

Desirable to know

1. Age changes in symphysis pubis
2. Anthropometry
3. Poroscopy
4. Odontology

Medico-legal Autopsy

1. Autopsy, types, objectives
2. Procedures, formalities of medico-legal autopsies
3. Types of incisions
4. Antemortem and postmortem thrombus
5. Subendocardial hemorrhage
6. Preservation of viscera and preservatives used
7. Exhumation

Desirable to know

1. Evisceration techniques
2. Dissection of the heart
3. Delivery of the brain
4. Demonstration of pneumothorax and air embolus

5. Obscure and negative autopsy
6. Chain of evidence
7. Examination of bundle of bones

Thanatology

1. Thanatology, death
2. Brain death
3. Clinical and molecular death
4. Cause, manner and mechanism of death
5. Agonal period
6. Sudden death, causes
7. Coronary atherosclerosis
8. *Signs of death*: Immediate, early and late changes
9. Suspended animation
10. Changes in eye
11. Algor mortis
12. Postmortem staining, color of PM staining in different conditions
13. Cadaveric spasm, cold and heat stiffening
14. Putrefaction, early and late putrefaction of organs
15. Rigor mortis, factors affecting and conditions simulating rigor mortis, rule of 12 (LQ)
16. Time since death (LQ)
17. PM staining and bruise (Diff.)
18. Rigor mortis and cadaveric spasm (Diff.)
19. Adipocere and mummification (Diff.)

Desirable to know

1. Modes of death: Coma, syncope, asphyxia
2. Persistent vegetative state
3. Anoxia, types
4. Congestion and PM staining (Diff.)
5. Rigor mortis and heat stiffening (Diff.)
6. Rigor mortis and cold stiffening (Diff.)
7. Casper's dictum
8. Entomology
9. Embalming

Asphyxia

1. Asphyxia, etiology, Tardieu spots
2. Judicial hanging, lynching
3. Classification of strangulation; mugging, garroting, bansdola
4. Throttling, PM changes
5. Smothering
6. Choking, gagging, café coronary, burking
7. Traumatic asphyxia, PM findings
8. Gettler's and Diatom test
9. Sexual asphyxia
10. Hanging, classification, PM changes (LQ)
11. Ligature strangulation, PM changes (LQ)

12. Drowning, classification, PM changes (LQ)
13. Hanging and strangulation (Diff.)
14. Antemortem and postmortem hanging (Diff.)

Desirable to know

1. Hyoid bone fractures
2. Antemortem drowning and postmortem submersion (Diff.)

Injuries

1. Injury (Sec. 44 IPC), Classification
2. Abrasion, types, age, medico-legal importance (MLI)
3. Bruise, types, color changes, ectopic bruise, patterned bruise, MLI
4. Which is more important medico-legally—abrasions or bruise?
5. Laceration, types, characteristics, MLI
6. Incised wound, characteristics, hesitation cuts, tailing, beveling, MLI
7. Langer's lines
8. Chop wounds
9. Stab wound, classification, characteristics, MLI
10. Defense wounds, fabricated wounds
11. Suicidal and homicidal cut throat wounds (Diff.)
12. Hypostasis and bruise (Diff.)

Desirable to know

1. Antemortem and postmortem bruise (Diff.)
2. Age of incised wound and lacerated wound

Firearm Injuries

1. Ballistics, bore/calibre, cartridge, classification of firearms
2. *Bullet*: Dum-dum, hollow point, tandem, duplex, frangible, souvenir, ricochet.
3. Tattooing, blackening; abrasion and grease collar
4. Choke and cylinder bore, paradox guns, wad
5. Advantages of rifling, choking and wads
6. Types of gunpowder
7. Puppe's rule
8. Multiple exit wounds from single bullet
9. Entry and exit wound of a bullet (Diff.)
10. Bullet and shotgun cartridge (Diagram)

Desirable to know

1. Characteristic of shotgun and rifle injuries at varying ranges
2. Shored exit wound
3. Yawing and tumbling of a bullet
4. Class characteristics
5. Dermal nitrate test, Harrison Gilroy test, neutron activation analysis, AAS
6. Accidental, suicidal and homicidal firearm injury (Diff.)

Regional Injuries

1. Black eyes
2. Types of fracture of skull
3. Closed and open head injury
4. Coup and contre-coup injury
5. Berry aneurysm
6. Whiplash injury
7. Railway spine
8. Flail chest
9. Cardiac concussion
10. Greenstick fracture
11. Intracranial hematomas, causes, features (**LQ** and **Diff.**)
12. Drunk and concussion (**Diff.**)

Desirable to know

1. Hematoma and depressed skull fracture (Diff.)
2. Diffuse axonal injury, concussion
3. Age of subdural hematoma
4. Post-traumatic intracerebral hemorrhage and apoplexy (Diff.)
5. Cerebral edema
6. Complications of abdominal injury
7. Open, closed and comminuted fracture
8. Healing of fracture
9. Punch drunk syndrome

Thermal Injuries

1. Frost bite, trench foot (immersion syndrome)
2. Heat cramps, heat stroke, heat syncope
3. Scalds, classification, features
4. Joule burn, crocodile skin, current pearls, wax drippings
5. Arborescent marks (Lichtenberg's flowers)
6. Burns, types, rule of nine, classification, cause of death, PM changes, pugilistic attitude (**LQ**)
7. Antemortem and postmortem burns (**Diff.**)
8. Dry heat, moist heat and chemicals burns (**Diff.**)

Desirable to know

1. Heat exhaustion
2. Heat hematoma
3. Heat ruptures

Transportation Injuries

1. Pedestrian injuries (primary and secondary impact and secondary injuries)
2. Front impact injuries for vehicle occupants
3. Steering wheel impact injury
4. Role of seat belt, seat belt injuries

Explosion Injuries*Desirable to know*

1. Blast lung
2. Injuries sustained in bomb blast
3. Characteristics of bomb blast injuries

Medico-legal Aspects of Injuries

1. Assault, battery, manslaughter, murder, dowry death
2. Hurt (Sec. 319 IPC); simple, grievous (Sec. 320 IPC) and dangerous injuries
3. Injuries sufficient to cause death in ordinary course of nature
4. Common weapons of offence, dangerous weapons
5. Punishments for various offences
6. Cause of death due to mechanical injuries
7. Thrombosis and embolism
8. Antemortem and postmortem wounds (**Diff.**)
9. Lacerated, incised and stab wounds (**Diff.**)

Desirable to know

1. Shock
2. Histochemical changes in injured tissue
3. Age of wounds
4. Relationship of trauma with natural disease

Decompression, Radiation and Altitude Sickness*Desirable to know*

1. Decompression sickness
2. Acute radiation syndrome, radiation sickness
3. Acute mountain sickness

Starvation Deaths

Death due to acute and chronic starvation

Infanticide and Child Abuse

1. Infanticide, feticide
2. Estimation of age of fetus from its features
3. Appearance of centre of ossification—calcaneum, talus, femur, tibia
4. Rule of Hasse
5. Features of dead-born fetus, Spalding's sign, maceration
6. Age of viability, medico-legal aspects
7. Vagitus vaginalis and uterinus
8. Signs of live birth
9. Hydrostatic test
10. Wredin's test, Breslau's second life test
11. Precipitate labor (medico-legal aspects)
12. Battered baby syndrome
13. SIDS (cot/crib death)

14. Stillborn and dead-born (**Diff.**)
15. Stillborn and liveborn infant (**Diff.**)
16. Cephalhematoma and caput succedaneum (**Diff.**)

Desirable to know

1. Changes in umbilical cord after birth
2. Causes of infant death
3. Munchausen syndrome by proxy
4. Head injury due to precipitate labor and blunt force (**Diff.**)

Anesthetic Deaths*Desirable to know*

Causes of death due to anesthesia

Abortion

1. Abortion, classification, causes of natural abortion
2. Methods of criminal abortion
3. Abortifacients drugs, cupping, abortion stick
4. Complications of criminal abortion
5. Natural and criminal abortion (**Diff.**)

Desirable to know

Relation of trauma and abortion

Impotence and Sterility

1. Impotence, sterility, frigidity, quod
2. Causes of impotency and sterility in males and females
3. Vaginismus
4. Sterilization, classification, methods
5. Artificial insemination, medico-legal aspects
6. Surrogate mother
7. AIH and AID (**Diff.**)

Virginity, Pregnancy and Delivery

1. Virgin, defloration, marriage, legitimate and illegitimate child
2. Normal female anatomy
3. Causes of rupture of hymen, signs of virginity
4. Presumptive, probable and positive (conclusive) signs of pregnancy
5. Medico-legal aspects of pregnancy
6. Pseudocyesis
7. Superfetation and superfecundation
8. Fetus compressus
9. Signs and symptoms of recent delivery in living
10. Signs and symptoms of remote delivery in dead
11. Lochia
12. Atavism
13. True and false virgin (**Diff.**)
14. Nulliparous and parous uterus (**Diff.**)

Desirable to know

1. Types of hymen
2. Medico-legal aspects of delivery, legitimacy

Natural Sexual Offences

1. Sexual offence, natural sexual offence
2. Classification of sexual offence
3. Rape, gang rape, statutory rape, custodial rape, invalid consent, punishment for rape
4. Locard's principle of exchange
5. Examination findings in the accused
6. Incest
7. Procedure and examination findings of a rape victim (virgin) (**LQ**)

Desirable to know

1. Carnal knowledge, adultery
2. Medico-legal aspects of definition of rape
3. Examination findings of rape in a deflorate woman and in a child
4. Rape trauma syndrome
5. Specimen collection of rape victim and accused

Unnatural Sexual Offences

1. Unnatural sexual offence, buccal coitus, lesbianism, bestiality
2. Sodomy, examination findings of habitual and non-habitual passive agent (**LQ**)

Desirable to know

Specimens to be preserved from active and passive agent involved in sodomy

Sexual Perversions

1. Sexual perversions, paraphilia, sadism, masochism, fetishism, exhibitionism, transvestic fetishism, voyeurism, frotteurism, masturbation
2. Indecent assault

Postmortem Artifacts*Desirable to know*

Postmortem artifacts

Forensic Psychiatry

1. Forensic psychiatry, delusion, hallucination, illusion, obsession, impulse
2. Lucid interval, delirium, dementia, fugue, twilight state, insight, cataplexy
3. Schizophrenia, types
4. Phobic disorder
5. Obsessive compulsive disorder (OCD)

6. Somnambulism and somnolentia
7. Civil and criminal responsibility (Sec. 84 IPC) of an insane
8. McNaughten's rule (legal test of insanity)
9. Psychosis and neurosis (**Diff.**)
10. True and feigned insanity (**Diff.**)

Desirable to know

1. Lucid interval of head injury and insanity (Diff.)
2. Hallucination and illusion (Diff.)
3. Role of forensic psychiatrist
4. First rank symptoms of schizophrenia
5. Mood disorders (manic and depressive episode)

Bloodstain Analysis

1. Chemical examination (color and crystal tests)
2. Microscopic findings
3. ABO system
4. Secretors
5. Precipitin test
6. Medico-legal aspects and application of blood groups

Desirable to know

1. Source and origin of bleeding
2. Antemortem or postmortem bleeding

Seminal Stains

1. Chemical tests
2. Microscopic findings
3. Proof of semen
4. Medico-legal importance

DNA Fingerprinting

1. RFLP technique
2. PCR
3. Collection of samples for DNA fingerprinting
4. Uses of DNA fingerprinting

Torture and Custodial Deaths*Desirable to know*

1. Torture, types
2. Falanga, dry submarine, wet submarine, telefona
3. Custodial deaths

Medico-legal Aspects of HIV*Desirable to know*

1. Health care personnel and HIV
2. Partner notification

Newer Techniques*Desirable to know*

1. Polygraph
2. Brain fingerprinting
3. Narco-analysis

Section Two



Toxicology

36. General Toxicology	411	50. Deliriant—Datura/Datura	496
37. Corrosive Poisons	427	51. Deliriant—Cannabis	499
38. Inorganic Metallic Irritants—Arsenic	433	52. Deliriant—Cocaine	501
39. Inorganic Metallic Irritants—Mercury	438	53. Spinal and Peripheral Nerve Poisons	504
40. Inorganic Metallic Irritants—Lead	441	54. Cardiac Poisons	507
41. Inorganic Metallic Irritants—Copper	446	55. Hydrocyanic Acid	512
42. Inorganic Metallic Irritants—Thallium	449	56. Asphyxiants	516
43. Other Inorganic Metallic Irritants	451	57. War Gases and Biological Weapons	521
44. Non-Metallic and Mechanical Irritants	455	58. Agricultural Poisons	525
45. Organic Irritants—Vegetable	458	59. Alphas (Aluminum Phosphide)	534
46. Organic Irritants—Animal	464	60. Medicinal Poisons	538
47. Somniferous Poisons (Narcotic Poisons)	475	61. Drug Dependence	545
48. Inebriants—Alcohol	479	62. Kerosene Oil Poisoning	552
49. Barbiturates	493	63. Food Poisoning	554

'The dose makes the poison...' Paracelsus once said.

Definitions

- **Toxicology***: Science dealing with properties, actions, toxicity, fatal dose, detection, estimation, treatment and autopsy findings (in case of death) in relation to the poisonous substances.
- **Forensic toxicology**: It deals with the medical and legal aspects of the harmful effects of chemicals on human beings. It involves not only the identification and quantifying of a drug, poison or substance in human tissue, but also the ability to interpret the results of one's findings.
- **Poison**: It is a substance (solid, liquid or gaseous) which if introduced in the living body or brought into contact with any part thereof will produce ill-health or death by its constitutional or local effects or both. Thus, almost anything is a poison.
- **Clinical toxicology**: It deals with human diseases caused by or associated with abnormal exposure to chemical substances.
- **Toxinology**: It is the science which deals with toxins produced by plants, animals, bacteria and fungi which are harmful to human beings.
- **Acute poisoning** is caused by an excessive single dose or several dose of a poison taken over a short interval of time.
- **Chronic poisoning** is caused by smaller doses over a period of time, resulting in gradual worsening, e.g. arsenic, phosphorus, lead and opium.
- **Subacute poisoning** shows features of both acute and chronic poisoning.
- **Fulminant poisoning** is caused by massive dose of poison where death occurs rapidly, sometimes without preceding symptoms.

Medico-legal Aspects of Poisons

- In law, the real difference between a medicine and a poison is the intent with which it is given. If the substance is given with the intention to save life, it is medicine, but if it is given with intention to cause bodily harm, it is a poison. The law does not make any difference between murder by means of poisons and murder by any other means.
- Sec. 284 IPC states that whoever causes hurt/injury with rash or negligent conduct with respect to poisonous substance shall be punished with imprisonment upto 6 months with/without fine (upto ` 1000).
- Sec. 328 IPC deals with administering of any poison, stupefying or intoxicating agent with the intent to cause hurt and facilitate the commission of an offence. Punishment is imprisonment upto 10 years and also fine.

Narcotics Drugs and Psychotropic Substances Act, 1985

- '*Narcotic drug*' means coca leaf, cannabis (hemp), opium, poppy and all drugs manufactured from them.¹
- '*Psychotropic substance*' means any substance, natural or synthetic, or any salt or preparation of such substance or material included in the list of psychotropic substances specified in the Schedule (76 drugs and their derivatives are listed), e.g. amphetamine, pentobarbital, psilocybine and diazepam.¹

Punishment

- If any person produces, possesses, transports, imports, sells, purchases or uses any narcotic drug/psychotropic substance (except 'ganga'), he shall be punished with rigorous imprisonment (RI) for ≥ 10 years (which may extend to 20 years), and a fine \geq ` 1 lakh (which may extend to ` 2 lakh). Punishment for a repeat offence is a RI for ≥ 15 years (which may extend to 30 years) and a fine of \geq ` 1.5 lakh (which may extend to ` 3 lakh).

* Toxic (Greek 'tox': bow): This is thought to be associated with their use of poisoned arrows in warfare.

- Punishment for ganja handling is a RI for 5 years and/or a fine of ₹ 0.5 lakh. For a repeat offense, the imprisonment may extend to 10 years and the fine to ₹ 1 lakh.
- However, if a person is carrying 'small quantities' (e.g. 250 mg of heroin, 5 g of charas, 5 g of opium, 125 mg of cocaine), then the punishment is a simple imprisonment

which may extend to 1 year or fine (unspecified) or both. For ganja (< 500 g), imprisonment is upto 6 months.

- In a later enactment, the Prevention of Illicit Traffic in NDPS Act, 1988, there is a provision for preventive detention and seizure of property. The maximum punishment is death penalty, if a person is found to be trafficking, for example, ≥ 1 kg of pure heroin, twice (despite conviction and warning on the first attempt).

Classification of Poisons

According to their **mode of action**, poisons are classified as:

I. **Corrosives:** They produce inflammation and ulceration of the tissues.

Strong acids	Strong alkalis	Metallic salts
<ul style="list-style-type: none"> • <i>Mineral or inorganic acids</i>, e.g. HCl, HNO₃, H₂SO₄ • <i>Organic acids</i>, e.g. carbolic, oxalic and acetic acid 	Caustic soda, caustic potash, carbonates of sodium, potassium and ammonium	Zinc chloride, ferric chloride or AgNO ₃

II. **Irritants**

Inorganic	Organic	Mechanical
<ul style="list-style-type: none"> • <i>Metallic</i>, e.g. arsenic, antimony, copper, lead, mercury, zinc • <i>Non-metallic</i>, e.g. phosphorus, chlorine, iodine, CCl₄ 	<ul style="list-style-type: none"> • <i>Vegetable</i>, e.g. rati, castor, croton, calotropis • <i>Animal</i>, e.g. snakes, cantharides, scorpions, spiders 	Powdered glass, hair, diamond dust, needles

III. **Neurotics:** They act mainly on the CNS, though some have local irritant action.

Cerebral	Spinal	Peripheral
<ul style="list-style-type: none"> • <i>Somniferous</i>, e.g. opioids • <i>Inebriants</i>, e.g. alcohol, anesthetics, ether • <i>Delirians</i>, e.g. datura, cannabis, cocaine² 	Nux vomica, gelsemium	Curare, conium

IV. **Cardiac:** Digitalis, oleander, aconite, nicotine, hydrocyanic acid.

V. **Asphyxiants:** CO, CO₂, H₂S, war gases.

VI. **Miscellaneous:** It includes poisons having widely different pharmacological actions.

i. **Agrochemicals**

Pesticides	Fumigants	Rodenticides	Herbicides
Organophosphates, organochlorines	Alphos, ethylene dibromide	Thallium sulphate, zinc phosphide	Paraquat, bromoxynil

ii. **Drugs of dependence:** Tranquillizers, antidepressants, hallucinogens.

iii. **Petroleum products:** Kerosene, petrol, naphtha.

iv. **Food poisoning:** Bacterial, chemical (botulism).

v. **Others:** Analgesics and antipyretics.

Factors Modifying the Action of Poisons

- i. **Quantity/dose:** More the quantity, more severe will be the toxic effects.
- ii. **Form**
 - *Physical state:* Gases and vapors act more rapidly than liquid. Liquid poisons act more rapidly than solid ones, of which fine powders act more quickly than coarse ones.
 - *Chemical combination:* Action of poison depends upon the solubility or insolubility resulting from chemical combination, e.g. AgNO₃ and HCl are both strong poisons, but when combined, form an insoluble salt of AgCl which is harmless.
 - *Mechanical combination:* Action of poison is altered when combined mechanically with inert substances. Corrosives when sufficiently diluted with water act as irritants.
- iii. **Mode of administration:** In order of rapidity of action:
 Inhaled in gaseous/vaporous form > Intravenous injection (IV) > Intramuscular (IM), subcutaneous and intradermal injection > Application to a wound > Application to serous surface > Ingestion > Introduction into the natural orifices, e.g. rectum, vagina, urethra and sublingual > Application to unbroken skin (e.g. nicotine patch).
 ('>' indicates more rapidly acting)
 As a rough estimate, if the active dose by mouth is considered as one unit, the rectal dose about 1½-2 times and the hypodermic dose is about ¼.
- iv. **Condition of the patient**
 - *Age:* Poisons have greater effect at the two extremes of age. A child does not have fully developed drug metabolizing enzymes and effective blood-brain barrier and as such more susceptible to the effect of most drugs.
 - *State of health:* A healthy person tolerates poisons better than a diseased person. General debility, senility, chronic or disabling disease may cause death of a person to a dose that is ordinarily safe, e.g. opium in bronchial asthma or mercury in chronic nephritis.
 - *Sleep and intoxication:* Action of poison is delayed, if a person goes to sleep soon after taking it. Action is also delayed, if one takes a poison in an intoxicated state.
 - *Tolerance and idiosyncrasy:* People have widely varying susceptibility, but tolerance can build up

to a substance, so that same dose no longer has the effect that originally it had, e.g. alcohol, barbiturates, amphetamines, benzodiazepines, tobacco and the morphine-heroin-methadone group.

The opposite situation is that of idiosyncrasy, where there is an inherent hypersensitivity towards drugs or food resulting in symptoms, like dyspnea, rigors, fever, diarrhea, hemorrhage from bowel and albuminuria, e.g. penicillin, aspirin, cocaine, sulphonamides, sera, certain articles of food, e.g. mushrooms, eggs, shell-fish, fruits and heroin.

- *State of stomach:* Presence of food in stomach delays the action of the poison in most cases. It also dilutes the concentration of the ingested poison.
- *Cumulative action:* Poisons which are not excreted readily tend to accumulate in the body when given in repeated doses and produce symptoms when their concentration reaches the threshold.

Routes of elimination: The absorbed portion of poison is mainly excreted by the kidneys and to some extent by the skin. Other routes are bile, milk, saliva, mucous and serous secretions. Unabsorbed portion is excreted in the vomit and feces.

Action of Poison

- **Local**
 - i. Chemical destruction by corrosives.
 - ii. Congestion and inflammation by irritants.
 - iii. Effect on motor and sensory nerves, e.g. tingling of skin and tongue by aconite or dilatation of pupils by atropine.
- **Remote:** Remote action produced either by shock, acting reflexly through severe pain or exerting a specific action on certain organs and tissues.
- **Combined:** Substances, like carbolic acid, oxalic acid and phosphorus have local and remote actions.

Diagnosis of Poisoning in Living

There is no single symptom and no definite group of symptoms which are absolutely characteristic of poisoning.

Following should arouse suspicion of poisoning

- i. Symptoms appear immediately or within a short period after food or drink.
- ii. Symptoms are uniform in character and increase rapidly in severity.
- iii. When several persons eat or drink from the same source of food or drink at the same time, all suffer from similar symptoms at or about the same time.

iv. Discovery of poison in food taken, in the vomitus or in the excreta is strong proof of poisoning.

Symptoms Suggestive of Poisoning

- i. Sudden onset of abdominal pain, nausea, vomiting, diarrhea and collapse.
- ii. Sudden onset of coma with constriction of pupils.
- iii. Unexplained coma, especially in children.
- iv. Coma in an adult, known to have a depressive illness.
- v. Rapid onset of a peripheral neuropathy, such as wrist-drop.
- vi. Rapid onset of a neurological or GIT illness in persons known to be occupationally exposed to chemicals.
- vii. Sudden onset of convulsions.
- viii. Delirium with dilated pupils.
- ix. Paralysis, especially of lower motor neuron type.
- x. Jaundice and hepato-cellular failure.
- xi. Oliguria with proteinuria and hematuria.
- xii. Persistent cyanosis.

Qualities of ideal homicidal and suicidal poison are given in Diff. 36.1.

Features Indicative of Chronic Poisoning

- i. Symptoms are exaggerated after the administration of suspected food, fluid or medicine.
- ii. Malaise, cachexia, depression and gradual deterioration of general condition of the patient.
- iii. Repeated attacks of diarrhea and vomiting.

iv. Removal of patient from his usual surroundings causes the symptoms to disappear.

v. Traces of poison found in the urine, blood, stool or vomit.

Diagnosis of Poisoning in Dead

Evidence of poisoning will depend on postmortem examination, chemical analysis, experiments on suitable animals and circumstantial evidence.

Postmortem Examination

External Findings

- i. The **color changes** in the corroded skin and mucous membrane is given in Table 36.1.
- ii. **Color of PM staining** in poisoning (Table 36.2).

Table 36.1: Color changes in skin and mucous membrane due to poisoning

S.No.	Poison	Color observed
1.	Sulphuric and hydrochloric acid	Gray, becoming black from blood
2.	Nitric acid	Brown or yellow
3.	Hydrofluoric acid	Reddish-brown
4.	Carbolic acid	Grayish-white
5.	Oxalic acid	Gray, blackened by blood
6.	Caustic alkalis	Grayish white
7.	Mercuric chloride	Bluish white
8.	Zinc chloride	Whitish
9.	Chromic acid, potassium chromate	Orange and leathery

Differentiation 36.1: Ideal homicidal and ideal suicidal poison

S.No.	Feature	Ideal homicidal poison	Ideal suicidal poison
1.	Cost	Immaterial	Cheap
2.	Availability	Easily available	Easily available
3.	Physical characteristics	Colorless, odorless and tasteless	Tasteless or pleasant taste, no repulsive smell
4.	Toxicity	Highly toxic	Highly toxic
5.	Antidote	None	None
6.	Solubility in food/drink	Soluble without producing any obvious change	Should be easily taken in food or drink
7.	Signs and symptoms	Should resemble a natural disease or delayed for the accused to escape suspicion	Capable of producing painless death
8.	Metabolism	Must be rapidly destroyed or undetectable in urine/blood	Not particularly so
9.	Detection	Should not be detected by chemical tests or other methods	Not particularly so
10.	Postmortem changes	Should be none	Not particularly so
11.	Examples	Arsenic, aconite, thallium, oleander, insulin and other drugs	KCN, HCN, opium, barbiturates, alphas or organophosphorus

Table 36.2: Color of PM staining in some poisons

S.No.	Poison	Color of PM staining
1.	Carbon monoxide (CO)	Cherry red
2.	Carbon dioxide (CO ₂)	Deep blue (reduced hemoglobin) ³
3.	Cyanide	Bright red/pink
4.	Phosphorus or copper	Dark brown/yellow
5.	Hydrogen sulphide	Bluish green ⁴
6.	Opiates	Black
7.	Nitrites, aniline, nitrobenzene, chlorates (methemoglobin formation)	Chocolate or coffee-brown ⁵

iii. **Smell** present about the mouth and nose is given in Table 36.3.

- The natural orifices, e.g. mouth, nostrils, rectum and vagina may show presence of poisonous material or the signs of it.
- *Injection marks* should be looked for with care.
- Skin should be examined for lesions, like hyperkeratosis and pigmentation, seen in chronic arsenic poisoning.
- Jaundice may occur in poisoning with phosphorus and potassium chlorate.

Internal Findings

- Smell:** The skull should be opened first to detect unusual odors in the brain because the opening of the body masks such odors.
- Mouth and throat:** Examine for any evidence of inflammation, erosion or staining. Areas of necrosis of the pharynx may be seen in death associated with agranulocytosis caused by amidopyrine, thiouracil, dinitrophenol, sulphonamide and barbiturates.

Table 36.3: Smell due to various poisons

S.No.	Poison	Odor
1.	Phosphorus, heavy metal poisoning (arsenic, phosphorus, selenium, thallium), parathion, malathion, alphas	Garlic-like
2.	Ethanol, methyl or propyl alcohol, chloroform, nitrites, acetone	Sweet and fruity
3.	Paraldehyde, chloral hydrate	Acrid
4.	H ₂ S, mercaptans, disulfurum	Rotten eggs
5.	HCN	Bitter almond
6.	Carbolic acid	Phenolic
7.	Organophosphates	Kerosene-like
8.	Zinc phosphide	Fishy
9.	Methyl salicylates	Oil of wintergreen

- Respiratory system:** Corrosives may cause edema of glottis and congestion and desquamation of mucous membrane of trachea and bronchi due to trickling of acid or alkali into the respiratory tract.
- Esophagus:** Corrosive alkalis produce marked softening and desquamation of the mucous membrane.
- Heart:** *Subendocardial hemorrhage* in left ventricle is seen in poisoning with arsenic, antimony, barium, mercury, phosphorus, and viper bite and in certain conditions, like heat stroke, acute infectious disease, e.g. influenza, and traumatic asphyxia.
- Stomach:** Hyperemia of mucous membrane (ridges are more involved) is caused by irritant poison, usually at the cardiac end and greater curvature of stomach.
 - Redness of mucosa is also found during digestion, in asphyxial deaths, venous congestion, and when exposed to the atmosphere.
 - Hyperemia due to disease is spread uniformly over the whole surface and not in patches.
 - Color changes of mucous membrane of stomach seen in different poisoning are given in Table 36.4.
 - *Softening:* Softening of mucous membrane of the stomach, especially at cardiac end and greater curvature is usually caused by corrosives, especially alkaline corrosives.
 - *Ulcers:* Ulceration due to corrosives or irritants is usually found at greater curvature, ulcer from disease is usually seen on the lesser curvature—margins are well-defined, thickened and indurated.
 - *Perforation:* Usually observed when strong mineral acids, especially H₂SO₄ has been taken. The stomach in such cases is blackened and extensively destroyed. Acid escapes into the abdomen and causes peritonitis.
- Duodenum and intestines:** A strong acid reaction from its constituents is of greater significance than that of stomach contents. Normal GIT rules out poisoning by corrosives (acids, alkalis and phenol), mercury and arsenic.
- Liver (hepatotoxic poisons):** Arsenic, phosphorus, CCl₄, alcohol, chlorpromazine, chloroform, TNT, paracetamol, thallium, alphas and zinc phosphide.
 - *Liver necrosis* is caused by phosphorus, chloroform, TNT and CCl₄.
 - *Fatty liver* is caused by arsenic, CCl₄, amanita phylloides and FeSO₄.
 - *Jaundice:* Phosphorus and potassium chlorate.

Table 36.4: Color of mucous membrane of stomach due to poisoning

S.No.	Poison	Color
1.	Copper sulphate, amytal capsule	Blue
2.	Ferrous sulphate	Green
3.	Sulphuric, hydrochloric or acetic acid	Black/charred
4.	Nitric acid	Yellow
5.	Carbolic acid	Buff/white
6.	Arsenic	White particles
7.	Mercury	Slate
8.	Cresols	Brown

- ix. **Kidneys (nephrotoxic poisons):** Arsenic, mercury, oxalic acid, carbolic acid, CCl_4 , cantharides, turpentine, thallium, alphas and zinc phosphide.
- Parenchymatous degenerative changes are seen in metal and cantharidin poisoning.
 - Necrosis of proximal convoluted tubules (PCT) is observed in mercuric chloride, phenol, lysol and CCl_4 poisoning.⁶

Chemical Analysis

The most important proof of poisoning is the analytical detection of poison in the parenchyma of the organs of the body. The finding of poison in the food, medicine or fluid alleged to have been taken is corroborative.

Experiments on Animals

The suspected food, medicine or fluid or poison extracted from viscera can be fed to domestic animals, such as dogs or cats. The poison affects these animals in the same way as human beings.

Circumstantial Evidence

Clues regarding recent purchase of poison by the victim or accused, his behavior, the conduct of those living with the victim, suicide note and history of quarrel or financial problems may provide valuable information.

Failure to Detect Poison

In some cases, no trace of poison is found on analysis, although from other circumstances, it is almost or quite certain that poison was the cause of illness or death.

Possible explanations for negative findings:

- Poison may have been eliminated by vomiting and diarrhea, e.g. irritant poison.
- Poison has disappeared from the lungs by evaporation or oxidation.

- Poison after absorption may be detoxified, conjugated and eliminated from the system.
- Some alkaloidal poisons cannot be definitely detected by chemical methods.
- Some drugs are rapidly metabolized, making extraction difficult.
- Biological toxins and venoms which may be protein in nature, cannot be separated from body tissues.
- Some organic poisons, especially alkaloids and glucosides may detoxify by oxidation during life or due to faulty preservation or from decomposition of the body, and cannot be detected chemically.
- In a slow acting poison, death may be delayed and by then the poison may have been completely excreted following production of irreversible changes.
- Many drugs may be present in small amount and these may require considerable amount of viscera for their identification.
- Wrong or insufficient material may have been sent for analysis.

Duties of a Doctor in a Case of Suspected Poisoning

Medical: Care and treatment to save the life of the patient.

Legal: Assist the police to determine the manner of poisoning.

- Note preliminary particulars of the patient, viz. name, age, sex, occupation, address, date and time, brought by whom, identification marks, and history.
- In case of *suspected homicidal poisoning*, the doctor must confirm his suspicion before expressing an opinion. For this he must:
 - Collect vomitus and urine and submit it for analysis.
 - Carefully observe and record the symptoms in relation to food, any change in color, taste or smell of food/drink and other persons affected at the same time.
- Consult in strict confidence a senior practitioner and keep him informed about the case.
- Remove the patient to the hospital. If the patient refuses, the doctor should engage nurses of his confidence who should administer the medicine and food and allow no one to be with the patient alone.

3. Once the suspicion is confirmed, he should request the removal of the patient to the hospital. If the victim is an adult, it desirable to seek his consent.
4. Any suspected articles of food, excreta, and stomach wash samples should be preserved. Non-compliance is punishable under **Sec. 201 IPC**, if it is proved that the doctor did it with the intention of protecting the accused.
5. If a private practitioner is convinced that the patient is suffering from homicidal poisoning, he is bound under **Sec. 39 CrPC** to inform the police or Magistrate. Non-compliance is punishable under **Sec. 176 IPC**.
6. If the *private practitioner* is sure that the patient is suffering from *suicidal/accidental poisoning*, he is *not bound to inform the police*, since **Sec. 309 of IPC** is not included in the section of IPC for which information has to be given under Sec. 39 CrPC. But, attempted suicide is an unlawful act and possibility of homicide cannot be ruled out. It is the duty of the police, not doctors, to decide whether the case was actually of attempted suicide or not, not even if the patient was successfully cured. So, it is better to inform the police.
7. If the practitioner is summoned by the investigating officer (I.O.), he is bound to give all information regarding the case that has come to his notice. If he conceals the information, he is liable to be prosecuted under **Sec. 202 IPC**. If he gives false information, he is liable to be charged under **Sec. 193 IPC**.
8. A *government medical officer* is required to *report to police all cases of suspected poisoning*, whether accidental, suicidal or homicidal, attended in the hospital.
9. If the condition of the patient is serious, he must make arrangement to record the dying declaration.
10. If the patient dies, he should not issue a death certificate, but should inform the police.
11. Any opinion about the nature of poison should be given only after getting the report from the forensic science laboratory.

Management of Poisoning Cases

If the poison is known, specific treatment must be started. If not, treatment is given on general lines.

Main aim of treatment: Help the patient to stay alive by attention to respiration and circulation, while he is assisted in getting rid of the poison by metabolism or excretion.

Emergency Management of Symptomatic Patient

In symptomatic patients, treatment of life threatening complications takes precedence over diagnostic evaluation.

- i. **Coma**
The initial can be remembered by the mnemonic ABCD, for Airway, Breathing, Circulation and Drugs respectively.
 - **Airway:** Establish a patent airway by positioning, suctioning or insertion of an artificial nasal or oropharyngeal airway or endotracheal intubation.
 - **Breathing:** Provide assistance, if necessary, with a bag-valve-mask device or mechanical ventilator. Provide supplemental oxygen.
 - **Circulation:** Measure the pulse and blood pressure, and estimate tissue perfusion (e.g. by measurement of urinary output, skin signs and arterial blood pH). Place the patient on continuous ECG monitoring.
 - **Drugs⁷**
 - a. Dextrose 50%: 50-100 ml IV (unless bedside glucose is normal)
 - b. Thiamine: 100 mg IM or IV.
 - c. Naloxone: 0.45-2 mg IV.
 - d. Consider flumazenil: 0.2-0.5 mg IV.
- ii. **Hypothermia:** Gradual rewarming is preferred, unless the patient is in cardiac arrest.
- iii. **Hypotension:** Most patients respond to empiric treatment (200 ml IV bolus of 0.9% saline or other isotonic crystalloid upto a total of 1-2 l). If unsuccessful, give dopamine, 5-15 µg/kg/min by infusion.
- iv. **Hypertension:** Treat hypertension, if the patient is symptomatic or if the diastolic pressure is > 105-110 mm Hg. Hypertensive patients who are agitated or anxious may benefit from a sedative, such as lorazepam, 2-3 g IV. For persistent hypertension, administer phentolamine, 2-5 mg IV, or nitroprusside sodium, 0.25-8 µg/kg/min IV.
- v. **Convulsions/seizures:** Administer lorazepam, 2-3 mg IV over 1-2 min, or if IV access is not immediately available—midazolam, 5-10 mg IM. If convulsions continue, administer phenobarbital, 15-20 mg/kg slow IV over 30 min, or phenytoin, 15 mg/kg IV over 30 min.
- vi. **Hyperthermia:** It is treated aggressively by removing all clothing, spraying with tepid water, and fanning the patient. If this is ineffective, induce neuro-muscular paralysis with a nondepolarizing neuro-muscular blocker (e.g. pancuronium, vecuronium).

Dantrolene (2-5 mg/kg IV) may be effective for hyperthermia that does not respond to neuromuscular blockade (i.e. malignant hyperthermia).

Removal of Unabsorbed Poison

- **Inhaled poisons:** In case of inhalation of gaseous poisons, the patient should be removed into fresh air, artificial respiration and O₂ (6-8 l/min) should be given. Air passages should be kept free from mucus by postural drainage or by suction.
- **Injected poisons:** If the poison has been injected subcutaneous, a tourniquet may be applied immediately above the point of injection, which must be loosened for 1 min after every 10 min to prevent gangrene. Immersion of the extremity in water at 10°C or below, slows capillary blood flow and limits absorption.
- **Contact poisons:** Immediate, copious flushing with water, saline or any other available clear, drinkable liquid is the initial treatment for topical exposures (except alkali, metals, calcium oxide and phosphorus). Saline is preferred for eye irrigation. A triple wash (water, soap and water) is best for dermal decontamination. The removal of liquids from body cavities, such as the vagina or rectum is done by irrigation.

Ingested Poisons (Gastric Decontamination)

- Gastric lavage (stomach washing)** is most useful within 1 h after ingestion of any poison (can be done even 4-6 h after ingestion). Gastric lavage is performed by sequentially administering and aspirating about 5 ml fluid/kg of body weight with

a 36-40 French orogastric tube (22-28 French tube for children). It is repeated, till clear and odorless fluid comes out. If there is any bleeding, the procedure is abandoned.

- **Procedure:** The patient is placed in Trendelenberg (mouth is at lower level than larynx so as to aid respiratory drainage and prevent aspiration) and in left lateral decubitus position (pylorus points upward in this orientation and helps prevent the poison from passing through the pylorus during the procedure), even if an endotracheal tube is in place for ventilatory support.
 - **Confirmation of tip in the stomach:** For confirmation, a little air in a syringe is forced down the tube, bubbling sounds are heard through the stethoscope applied over the stomach. If the tube has entered the trachea, a hissing noise is heard at the other end and if the patient is conscious, reflex coughing takes place and bubbles of air will be found coming out, if outer end is dipped in water.
 - After testing, about 250 ml of water is injected. Allow few minutes for fluid to act in the stomach. The fluid is then taken out and preserved for chemical analysis (Fig. 36.1).
 - **Fluid for gastric lavage:** Except for infants, where normal saline is recommended, tap water is acceptable.
- Others agents used:* 1:5000 KMnO₄, 5% NaHCO₃, 4% tannic acid, 1% NaI/KI, 1-3% calcium lactate, saturated lime water or starch solution.
- When the poison has been removed, a small quantity of the fluid is left behind in the stomach,

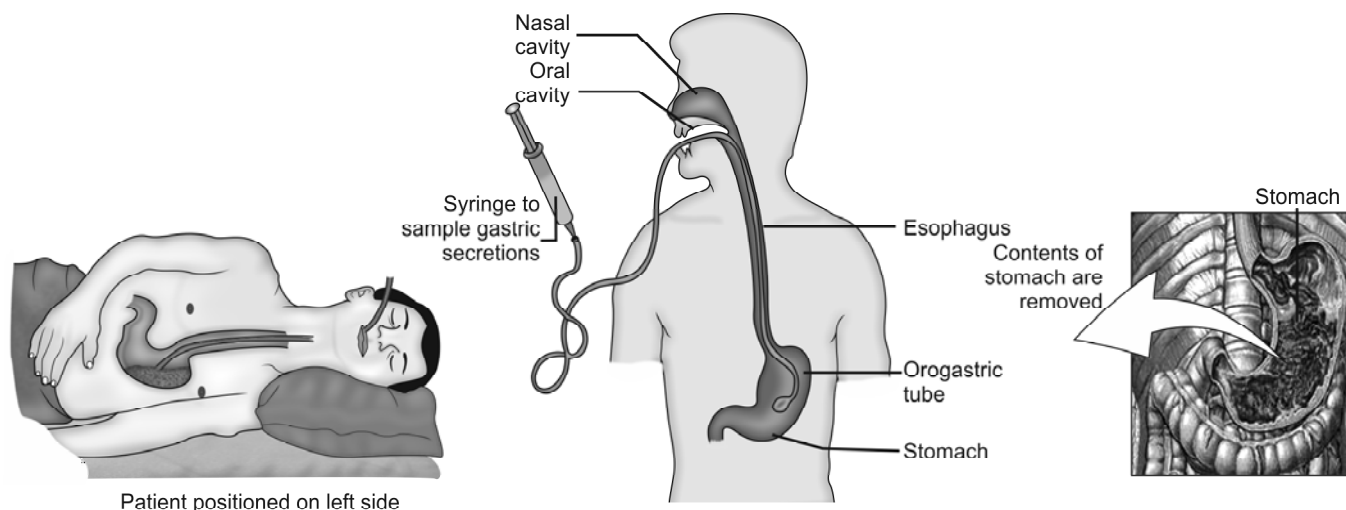

Fig. 36.1: Gastric lavage

so that it may neutralize whatever small quantity of the poison is left behind.

- **Complications:** Aspiration is a common complication (10% of patients) and serious complications (like esophageal and gastric perforation, tube misplacement in the trachea) occur in about 1% of patients.

Contraindications for gastric lavage⁸⁻¹⁰

- Corrosive poisoning (except carbolic acid) owing to danger of perforation.
- Convulsant poison, as it may lead to convulsions (e.g. strychnine).
- Comatose patients because of risk of aspiration into air-passages.
- Volatile poisons and hydrocarbons (petroleum distillate and kerosene oil) which may cause aspiration pneumonitis.
- Risk of hemorrhage or perforation due to esophageal or gastric pathology, like upper alimentary diseases (esophageal varices) or recent surgery.
- Hypothermia or hemorrhagic diathesis.
- Compromised unprotected airway.
- Ingestion of a foreign body (e.g. drug packet).

- Ryle's tube of appropriate size may be used for gastric lavage. In adults, it is inserted through the nose, upto the second marking wherein the tip reaches the midway of body of stomach (1st marking: at the level of cardiac end of stomach, 3rd marking: pyloric end).
- Gastric lavage can be done with a stomach tube (**Ewald or Boas tube**, Fig. 36.2). It is a non-collapsible rubber tube of 1 cm diameter and 1.5 meter in length with a filter funnel attached at one end and a mark at about 50 cm from the other end which should be rounded with lateral openings. At about the midway of the tube, there is a suction bulb to pump out the stomach contents. A wooden mouth gag is provided, one end of which is pointed, so that it can be forcefully inserted by the side of the mouth in non-cooperative patients.
- In the **Trendelenburg position** the body is laid in supine position with the feet higher than the head by 15-30°.

- ii. **Emetics:** They should be used only if there is difficulty in obtaining gastric lavage. Vomiting can be produced if the medullary centres are still responsive. Due to danger of aspiration of gastric contents, vomiting should only be induced in a conscious patient.

Methods

a. **Household emetics¹¹**

- Large amount of warm water.
- A table-spoonful (15 g) of mustard powder in 200 ml of warm water—not very effective.

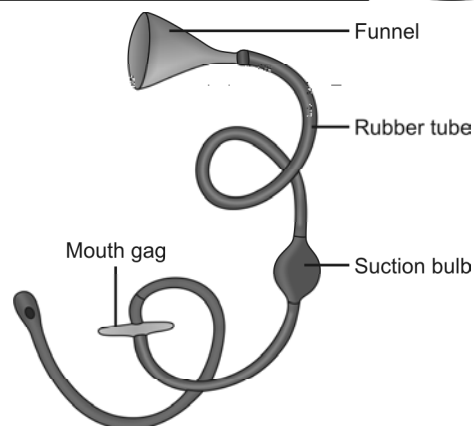

Fig. 36.2: Ewald or Boas tube for gastric lavage

- Two table-spoonfuls of common salt in a tumbler (200 ml) of warm water—may result in severe salt poisoning.

b. **Other methods**

- Syrup of ipecac (home management of accidental ingestions; 30 ml for adults, 15 ml for children).
- $ZnSO_4$, 1-2 g in 200 ml of water, repeated in 15 min, but no longer used as an emetic.
- $(NH_4)CO_3$, 1-2 g in 200 ml of water.
- Apomorphine, 6 mg subcutaneously followed by naloxone hydrochloride 5-10 mg IM—may cause CNS depression with an increased risk of aspiration, hence not recommended.
- Tickling the back of throat (fauces) with a wooden tongue depressor or finger-down-the-throat technique is quick and easy method, but it is ineffective and potentially traumatic.

Side-effects include lethargy in children and protracted vomiting. Except for aspiration, serious complications (e.g. gastric or esophageal tears and perforations) are rare.

Contraindications: Same as stomach wash, in addition to:

- Severe heart and lung diseases.
- Advanced pregnancy.
- In cases of CNS depression, seizures or rapidly acting CNS poisons (camphor, cyanide, tricyclic antidepressants, propoxyphene and strychnine).

- iii. **Dilution** (i.e. drinking 5 ml/kg of body wt. of water or any other clear liquid) is recommended only after the ingestion of corrosives (acids or alkali).

- iv. **Other methods:** Endoscopic or surgical removal of poisons may be useful in rare situations, such

as ingestion of a toxic foreign body that fails to transit the GIT, lethal amount of a heavy metal (arsenic, iron, mercury or thallium) or agents that have coalesced into gastric concretions or bezoars (barbiturates, glutethimide, heavy metals, lithium, meprobamate, salicylates or sustained-release preparations). Patients who become toxic from cocaine due to its leakage from ingested drug packets, require immediate surgical intervention.

Administration of Antidotes

Antidotes counteract the effects of poisons by neutralizing them (e.g. antibody-antigen reactions, chelation, chemical binding) or by antagonizing their physiologic effects (e.g. activation of opposing nervous system activity, provision of competitive metabolic or receptor substrate).

Mechanical/Physical Antidotes

It neutralize poisons by mechanical action or prevent their absorption.

- i. **Activated charcoal:** Fine, black, odorless powder produced by destructive distillation of various organic materials, usually wood pulp and then treating at high temperature with a variety of activating agents, such as steam or CO₂, to increase its adsorptive capacity.
 - **Dose:** 40-80 g (dose: 0.5-1 g/kg body wt.) is mixed with water to form a soup-like mixture and given orally. Palatability may be increased by adding a sweetener (sorbitol) or a flavoring agent (cherry, chocolate or cola syrup) to the suspension.
 - **Action:** It acts mechanically by *adsorbing* and retaining within its pores, especially alkaloid poisons, allowing the charcoal-toxin complex to be evacuated with stool. The network of pores adsorbs 100-1000 mg of drug/g of charcoal.
 - **Uses:** It is used in cases of poisoning with strychnine, morphine, atropine, nicotine, barbiturates, alcohol, salicylic acid, KCN and phenol.¹² Charged (ionized) chemicals, such as mineral acids, alkalis and highly dissociated salts of cyanide, fluoride, iron and lithium are not well adsorbed by charcoal. Activated charcoal does not bind metals and thus is of limited usefulness in cases of acute metal ingestion.
 - **Side-effects:** Nausea, vomiting and diarrhea or constipation. Charcoal may also prevent the absorption of orally administered therapeutic agents.

- **Complications** include mechanical obstruction of the airway, aspiration, vomiting, bowel obstruction and infarction caused by inspissated charcoal.
- ii. **Demulcents** are substances which form protective coating on the gastric mucous membrane, e.g. milk, starch, egg-white, mineral oil, aluminum hydroxide and milk of magnesia.

Contraindications: Fats and oils should not be used for oil-soluble poisons, such as kerosene, phosphorus, OPC, DDT, phenol, turpentine, aniline and CCl₄.
- iii. **Bulky foods** acts as mechanical antidote to glass powder by imprisoning its particles within its meshes.

Chemical Antidotes

They counteract the action of poison by forming harmless or insoluble compounds or by oxidizing poison when brought into contact with them.

- i. **Potassium permanganate** has oxidizing properties, 1:5000 solution is used. The wash must be continued till the solution coming out of stomach is pink in color. It is effective against most of the alkaloids (opium, strychnine or atropine), barbiturates, phosphorus and cyanide.
- ii. **Tannic acid** (4%) in the form of strong tea precipitates alkaloids, lead, silver, aluminum, cobalt and copper.
- iii. **Dilute alkalis**, e.g. milk of magnesia, alkaline hydroxide or ammonia will neutralize acid; bicarbonates should not be given because of risk of rupture of stomach due to liberated CO₂.
- iv. **Tincture iodine** or Lugol's iodine precipitates alkaloids, lead, mercury, silver and quinine.
- v. **Common salt** reacts with AgNO₃ by direct chemical action forming insoluble AgCl.
- vi. **Albumin** precipitates HgCl₂ and **CuSO₄** precipitates phosphorus.
- vii. **Chemical action:** Canned fruit juice and lemon juice are other alternatives.

Universal Antidote: It is a combination of physical and chemical antidotes; used in those cases where the nature of ingested poisons is unknown or when it is suspected that 2 or more poisons were taken.¹³

Constituents	Quantity	Purpose/Action
• Powdered charcoal (burnt toast)	2 parts	Adsorbs alkaloids
• Magnesium oxide (milk of magnesia)	1 part	Neutralizes acids
• Tannic acid (strong tea)	1 part	Precipitates alkaloids, glycosides and metals

The use of universal antidote declined by the mid-1980s and is no longer available. Activated charcoal was found superior to the universal antidote in decreasing absorption and that the decreased efficacy of the universal antidote was caused by tannic acid interfering with activated charcoal's absorbance of other toxins. Moreover, tannic acid was found to be hepatotoxic in nature.

Physiological/Pharmacological Antidotes

These agents produce effects which are opposite to that of poison. They are used after some of the poison is absorbed into the circulation. The antagonism is usually not complete and it may itself produce undesirable side-effects. For example, atropine for pilocarpine, diazepam for strychnine, naloxone for morphine, amyl nitrite for cyanide, N-acetyl cysteine for acetaminophen, atropine and oximes for OPC, and anti-snake venom for snake bite poisoning (serological antidote)*.

Chelating Agents

They are widely used as specific antidotes against some *heavy metal poisoning*, as they have greater affinity for the metals as compared to the endogenous enzymes.

- i. **BAL (British anti-lewisite, dimercaprol):** It is used in arsenic, lead, bismuth, copper, mercury, gold and other heavy metal poisoning.¹⁴ Many heavy metals have affinity for sulfhydryl (-SH) radicals, combine with them in tissues and deprive the body of the use of respiratory enzymes. BAL has two unsaturated -SH groups which combine with the metal and thus prevent the union of the metal with the -SH group of the respiratory enzyme system.¹⁵
 - *Dose:* 10% solution in oil, 3-5 mg/kg IM 4 hourly for 2 days, 6 hourly on 3rd day and then 12 hourly for next 10 days.
 - *Side-effects:* Nausea, vomiting, headache and hypertension.
 - *Contraindicated* in liver damage, G-6-PD deficient individuals, and cadmium and iron poisoning (since dimercaprol-cadmium and dimercaprol-iron complex is itself toxic).
- ii. **EDTA (Ethylene diamine tetra acetic acid, calcium disodium versenate):** Effective in lead, copper, cobalt, cadmium, iron and nickel poisoning; superior to BAL for treatment of poisoning with arsenic and mercury.¹⁶ It is highly ionized, therefore distributed only extracellularly and rapidly excreted in urine

by glomerular filtration carrying the toxic metal along. Since CaNa_2EDTA is ionized, it is not absorbed from GIT—must be given IV (IM is painful).

- *Dose:* 25-35 mg/kg body wt. in 250-500 ml of 5% glucose or normal saline IV over a 1-2 h period, twice daily for 5 days and may be repeated after 2-3 days.
 - *Contraindication:* Renal damage.
- iii. **Penicillamine (cuprimine):** It is a hydrolysis product of penicillin, has got a stable -SH group. Treatment of choice for copper, lead and mercury poisoning. It is also useful in hepatolenticular degeneration (Wilson's disease which is due to disorder of copper metabolism), cystinuria and scleroderma. The d-isomer is used, because the l-isomer and the racemate produce optic neuritis. *Dose:* 30 mg/kg body wt. upto a total of 2 g/day in 4 divided doses, orally for about 7 days.
 - iv. **Desferrioxamine** is very useful in acute iron poisoning, hemochromatosis (characterized by excessive retention of iron in the tissues) and transfusional chronic iron overload. *Dose:* 2 g in 5% of laevulose solution given IV and repeated after 12 h.

Recently, deferiprone and deferasirox (20-30 mg/kg, once daily) has been developed which are orally effective iron chelator.
 - v. **Succimer or DMSA (dimercaptosuccinic acid):** It is similar to dimercaprol in chelating properties, water soluble and orally effective. Succimer is useful in lead, mercury and arsenic poisoning. It is superior to EDTA in the treatment of lead poisoning, as it is less toxic to the kidneys and can be given in G-6-PD deficient patients. *Dose:* 10 mg/kg orally, every 8 hourly for 10 days.

Elimination of Poison by Excretion

Indications

- Severe poisoning.
- Progressive deterioration, in spite of full supportive care.
- When there is high risk of morbidity and mortality.
- When normal route of excretion of poison is impaired.
- When poison produces delayed, but serious toxic effects.

* Studies have shown that the antitoxic sera do not act as chemical antidotes in destroying the venom, but as physiological antidotes.

Methods

- i. **Renal excretion** may be improved by giving large amounts of fluid or tea orally.
- ii. **Forced diuresis and alteration of urinary pH:** Saline diuresis can enhance the renal excretion of alcohol, fluoride and thallium.
 - *Alkaline diuresis* (producing a urine pH ≥ 7.5 and a urine output of 3-6 ml/kg body wt/h by adding sodium bicarbonate to an IV solution) enhances the excretion of chlorpropamide, 2,4 dichlorophenoxyacetic acid, diflunisal, fluoride, mecoprop, methotrexate, phenobarbital and salicylate.¹⁷
 - While *acid diuresis* can enhance the excretion of amphetamines, cocaine, local anesthetics, phen-cyclidine, quinidine, quinine, strychnine, sympathomimetics and tricyclic antidepressants, such therapy is *not recommended* because of potential cardiovascular and renal (myoglobinuric renal failure) complications and lack of clinical efficacy.
- iii. **Whole-bowel irrigation** is performed by administering a bowel-cleansing solution containing electrolytes and polyethylene glycol orally or by gastric tube at a rate of 2 l/h (0.5 l/h in children), until rectal effluent is clear.
- iv. **Cathartics** are salts (disodium phosphate, magnesium citrate/sulfate or sodium sulfate) or saccharides (mannitol or sorbitol) that promote the rectal evacuation of GIT contents.
 - Most effective cathartic is sorbitol in a dose of 1-2 g/kg of body wt.
 - *Contraindications:* Ingestion of corrosives and pre-existing diarrhea.
 - Magnesium-containing cathartics should not be used in patients with renal failure.
- v. **Diaphoretics (sudorifics):** Application of heat (blankets or hot water bottles) and administration of warm beverages—alcohol, ipecac, pilocarpine, opium, sweet spirits of nitre and salicylates will cause increased perspiration and speeds up the excretion of toxic agents, but its usefulness is doubtful.¹⁸
- vi. **Extracorporeal removal:** Peritoneal dialysis, hemodialysis, charcoal or resin hemoperfusion, hemofiltration, plasmapheresis and exchange transfusion are capable of removing any toxin from the bloodstream.

Dialysis is useful in poisoning with:^{19,20}

- | | |
|-------------------|---------------------------|
| • Acetone | • Barbiturates |
| • Bromide | • Chloral hydrate |
| • Cocaine | • Cannabis |
| • Ethanol | • Methanol |
| • Ethylene glycol | • Isopropyl alcohol |
| • Salicylates | • Heavy metals (possibly) |

*Dialysis is NOT useful in poisoning with:*²¹

- | | |
|--------------------|-------------------|
| • Kerosene oil | • Copper sulphate |
| • Organophosphorus | • Digitalis |
| • Benzodiazepines | • Digoxin |
| • Amphetamine | |

Hemoperfusion should be considered in cases of severe poisoning due to caffeine, CCl₄, hypnotic-sedatives (barbiturates, meprobamate or methaqualone), mushrooms (amatoxin-containing) and paraquat.²²

Symptomatic Treatment

It should be applied as indications arise. Morphine is given to relieve pain, O₂ or artificial respiration for respiratory failure and anesthetic, barbiturates or diazepam for convulsions, sodium bicarbonate to treat acidosis, glucose infusion for hypoglycemia, and restoration of electrolyte imbalance.

Maintenance of Patient's General Condition

Patient should be kept warm and comfortable, prevent development of urinary tract infection, particularly those unconscious, prophylactic antibiotics and physiotherapy to prevent bed sores are indicated.

Samples Preserved for Toxicological Analysis

The samples must be meticulously labeled with the patient's name, address, hospital number and the date of collection. The doctor's signature should also be placed on the label. The sample should be handed to a specific person, often a police officer, whose name is noted, and who will take the sample to the laboratory—maintaining the chain of evidence.

Collection of Specimens (Details in Chapter 6)

- i. **Blood:** It is important to obtain blood samples from the correct site, when postmortem analysis is to be carried out. During life, any venous sample is usually satisfactory, except in unusual circumstances where arterial blood is required. However, at autopsy, the results of analysis can be distorted by an incorrect sample.

It should not be taken from the heart or great vessels in the chest, as postmortem contamination can occur from the stomach or even from aspirated vomit in the air passages. *The best place to obtain blood is from the femoral or iliac veins, or from the axillary veins.*

- ii. **Vomit and stomach contents:** Vomit is placed either in a clean glass jar or a plastic tub with a tight-fitting lid.
- iii. **Feces:** The contents of the rectum are not often required for analysis, except in suspected heavy metal poisoning, such as arsenic, mercury or lead. A sample of 20-30 g should be taken in a plain screw-topped jar or in a plastic container with a snap-on lid.
- iv. **Liver and other organs:** Liver concentrates many drugs, making them identifiable when the blood and urine concentrations may have declined to very low levels. After cutting the organ to examine it, the entire or half of the liver along with the gallbladder should be placed in a clean container. Sometimes, bile may be required for analysis, it is particularly useful for seeking presence of chlorpromazine and morphine.
- v. **Hair and nail clippings:** If a heavy metal poison is suspected, such as antimony, arsenic or thallium, some hair, cut or pulled at the roots, together with nail clippings, should be submitted for analysis. These metals are laid down in keratin in a sequence depending on the time of administration and their detection may be possible by *neutron-activation analysis*.

Toxicological analysis of urine and blood (and occasionally of gastric contents and chemical samples) can sometimes confirm or rule out suspected poisoning. A negative result means that substance is not detectable by the test used or that its concentration is too low for detection at the time of sampling. In the latter case, repeating the test at a later time may yield a positive result.

Quantitative analysis is useful for poisoning with acetaminophen, alcohols, barbiturates, heavy metals, paraquat, salicylate, carboxyhemoglobin, and methemoglobin.

- **'Screening tests'** are said to be *'qualitative,'* where a test is either positive (indicating that the drug/toxin is present) or negative (indicating that the drug/toxin is not present).
- When specific levels of drugs or toxins are determined, the tests are said to be *'quantitative.'*

Notes

Diagnostic ECG

- **Bradycardia and atrioventricular block:** Cholinergic agents (carbamate and OPC insecticides), cardiac glycosides, and tricyclic antidepressants.
- **Ventricular tachyarrhythmia:** Cardiac glycosides, fluorides, methylxanthines, sympathomimetics, chloral hydrate, aliphatic and halogenated hydrocarbons.

Diagnostic X-ray

- **Pulmonary edema (ARDS):** CO, cyanide, opioid, paraquat, phencyclidine, sedative-hypnotic, salicylate, inhalation of irritant gases, fumes, vapors (acids and alkali, ammonia, aldehydes, chlorine, hydrogen sulphide, isocyanates, metal oxides, mercury, phosgene).
- **Aspiration pneumonia:** Petroleum distillate ingestion.
- **Presence of radiopaque densities on abdominal X-rays:** Calcium salts, chloral hydrate, chlorinated hydrocarbons, heavy metals, illicit drug packets, iodinated compounds, potassium salts, psychotherapeutic agents, lithium, enteric-coated tablets, or salicylates.

Response to antidotes useful for diagnostic purposes:

Resolution of altered mental status and abnormal vital signs within minutes of IV administration of dextrose, naloxone, or flumazenil is diagnostic of hypoglycemia, narcotic poisoning and benzodiazepines respectively and of anticholinergic poisoning by physostigmine.

Signs associated with poisons

System	Signs	Poisons suspected
Eyes	Miosis	Narcotics (opium), phenol, organophosphorus, carbamates, muscarinic type mushrooms, physostigmine, neostigmine, pilocarpine, ethanol, nicotine, barbiturates, benzodiazepines, caffeine, clonidine.
	Mydriasis	Datura, atropine, belladonna, cannabis, ergot, endrin, strychnine, oleanders, HCN, anticholinergics, antihistamines, amphetamine, cocaine, methanol, LSD.
	Nystagmus	Sedatives, hypnotics, barbiturates, ethanol.

Contd....

Contd...

Pulse	Bradycardia	Digoxin, narcotics, OPC, petroleum products, cyanide.
	Tachycardia	Alcohol, amphetamine, sympathomimetics, substances containing atropine, tricyclic antidepressants, salicylates, cocaine.
Respiration	Cyanosis	Aniline dyes, nitrites, phenacetin - causing methemoglobinemia.
	Slow and depressed Tachypnea	Alcohol, barbiturates (late), narcotics, sedatives, hypnotics. Barbiturates (early), methanol, salicylates, CO, amphetamines.
Blood pressure	Hypotension	Narcotics, barbiturates, iron, antidepressants, phenothiazines, disulfiram, cyanide, CO, H ₂ S, arsenic, certain mushrooms, nitrites, nitrates.
	Hypertension	Antihistaminics, anticholinergics (atropine), amphetamines, phenylpropranolamine, cocaine, monoamine oxidase (MAO) inhibitors.
Temperature	Hypothermia	Ethanol, opioids, barbiturates, sedatives, hypnotics, phenothiazines, hypoglycemic agents, benzodiazepines, tricyclic antidepressants, CO.
	Hyperpyrexia	Amphetamines, atropine, quinine, cocaine, dinitrophenol, phencyclidine (PCP), salicylates, strychnine, tricyclic antidepressants, marking nut, dhatura, cocaine, aspirin, strychnine, antihistaminic, pethidine, barbiturates, nicotine.
CNS	Altered consciousness Restless, delirious	Narcotics, sedatives, hypnotics, alcohol, ethylene glycol, CO, OPC, insecticides. Dhatura, alcohol, marijuana, cocaine, heroin, methaqualone, sympathomimetics, anticholinergics, heavy metals.
	Ataxia	Alcohol, barbiturates, sedatives, benzodiazepines, CO, insulin.
	Paralysis	Botulin, heavy metals, poison hemlock.
	Coma	Antihistaminics, barbiturates, benzodiazepines, ethanol, opioids, phenothiazines, antidepressants.
	Arrhythmias	Chlorinated solvents, chloral hydrate, digitalis glycosides, OPC, opioids, sedative-hypnotics, tricyclic antidepressants, amphetamines, anticholinergics, caffeine, cocaine, phenothiazine, arsenic, methadone.
	Seizures	Amphetamines, antidepressants (especially tricyclic antidepressants), cocaine, PCP, withdrawal from alcohol or sedative-hypnotics.

Antidotes at a glance

S.No.	Toxic agent	Specific antidote
1.	Acetaminophen	N-acetyl cysteine
2.	Anticholinergics (e.g. dhatura, atropine)	Physostigmine
3.	Anticholinesterases (e.g. OPCs)	Atropine and pralidoxime (2-PAM)
4.	Benzodiazepines	Flumazenil
5.	CO	Oxygen, hyperbaric oxygen
6.	Cyanide	Sodium nitrite, sodium thiosulphate
7.	Heavy metals (lead, mercury, iron) and arsenic	Specific chelating agents
8.	Methanol, ethylene glycol	Ethanol or fomepizole
9.	Opioids	Naloxone
10.	Snake venom	Specific antivenin

Classification of poisons based on their effect/outcome

S.No.	Category	Poisons
1.	Stupefying poisons	Alcohol, dhatura, cannabis, chloral hydrate.
2.	Abortifacients	Calotropis, aconite, lead, arsenic, mercury, KMnO ₄ , croton, marking nut, cantharides.
3.	Cattle poisons	Rati, oleander, calotropis, aconite, arsenic, OPC, strychnine.
4.	Arrow poisons	Rati, croton, calotropis, aconite, strychnine, curare, snake venom.
5.	Poisons resisting putrefaction	Arsenic, antimony, mercury, thallium, cyanide, phosphorus, fluoride, alphas, ZnP, barbiturates, OPC, strychnine, yellow oleander, dhatura, hyoscine, nicotine, CO.

Contd...

6.	Poisons rapidly destroyed in body	Chloral hydrate, sodium nitrite, volatile poisons, thiopental sodium, cocaine, aconite.
7.	Knock-out agents	Potassium bromide, chloral hydrate, dhatura, cannabis (<i>bhanga</i>).
8.	Froth producing	Barbiturates, opium, Tik-20, endrin, copper sulphate, kerosene, OPC.
9.	Hallucinogens	LSD, mescaline, alcohol, cannabis, cocaine, amphetamine.
10.	Artificial bruise producing	Calotropis, marking nut, plumbago.
11.	Blister forming	Barbiturates, meprobamate, marking nut, plumbago, calotropis, croton, CO, tricyclic antidepressants.
12.	Curiosity poisons	Castor, borax paste, iodine, rati, poisonous mushrooms.
13.	Formication (as if ants creeping under skin)	Cocaine, phosphorus, ergot
14.	Acidic drugs secreted into the stomach	Salicylic acid, probenidol, phenylbutazone, thiopental, barbital.
15.	Basic drugs secreted into the stomach	Theophylline, quinine, aniline, antipyrine, phenacyclidine, dextromorphan, tolazoline.

MULTIPLE CHOICE QUESTIONS

- Under the 'NDPS Act' following drugs are included, *except*: *NIMHANS 08*
 A. Opium/heroin B. Hashish
 C. Amphetamine D. Alcohol
- Delirium is seen in all of the following poisonings, *except*: *PGI 03*
 A. Dhatura B. Nux vomica
 C. Cocaine D. Lead
- Deep blue color of hypostasis is seen in death due to poisoning with: *AI 04*
 A. Potassium cyanide B. Phosphorous
 C. Aniline dyes D. Carbon dioxide
- A dead body is having cadaveric lividity of bluish green color. The most likely cause of death is by poisoning due to: *AIIMS 06; DNB 10*
 A. Hydrocyanic acid B. Hydrogen sulphide
 C. Oleander D. Sodium nitrite
- A dead body with suspected poisoning is having hypostasis of red brown in color. It is suggestive of poisoning due to: *AIIMS 03; Maharashtra 08; DNB 10; PGI 07, 08, 10, 11*
 A. Nitrites/Aniline B. CO
 C. Cyanides D. Barbiturates
- Mercury will affect which part of kidneys: *AI 07*
 A. PCT B. DCT
 C. Collecting duct D. Loop of Henle
- Drugs useful in the treatment of poisoning is/are: *Karnataka 04*
 A. Naloxone B. Diazepam
 C. Bicarbonate D. All of the above
- Gastric lavage can be done in poisoning with: *WB 10; Orissa 11*
 A. Carbolic acid B. Oxalic acid
 C. Sulphuric acid D. Caustic potash
- Gastric lavage is contraindicated in the following: *Karnataka 04; PGI 08, 11; FMGE 11; Kerala 11*
 A. Barbiturate poisoning
 B. Kerosene poisoning
 C. Paracetamol poisoning
 D. Carbolic acid
- Consider the following: *UPSC 09; PGI 11*
 1. Kerosene poisoning
 2. OPC poisoning
 3. Corrosive poisoning
 4. Iron poisoning
 In which of the above is gastric lavage contraindicated?
 A. 1 only
 B. 1 and 3 only
 C. 2 and 4 only
 D. 1, 2, 3 and 4
- True about household emetics are all, *except*: *DNB 08*
 A. Ipecac syrup is potent and safe
 B. NaCl solution in warm water is the safest
 C. Apomorphine is effective orally
 D. Tickling the fauces with a tongue depressor is the best method
- Activated charcoal is used in: *PGI 03*
 A. Alcohol poisoning
 B. Barbiturate poisoning
 C. Heavy metal poisoning
 D. Lead poisoning

1. D 2. B 3. D 4. B 5. A 6. A 7. D 8. A 9. B 10. B 11. C
 12. B

13. **Universal antidote consists of:** *Jharkhand 11*
 A. Activated charcoal B. Copper sulfate
 C. Egg white D. Starch
14. **BAL is useful in treating poisoning due to all, except:** *AI 04; WB 10*
 A. Lead B. Mercury
 C. Cadmium D. Arsenic
15. **Drug containing two sulfhydryl groups in a molecule:** *Maharashtra 09*
 A. BAL B. EDTA
 C. Penicillamine D. None
16. **Disodium EDTA is used as an antidote for:** *DNB 10*
 A. Mercury poisoning
 B. OPC poisoning
 C. Mushroom poisoning
 D. Belladonna poisoning
17. **Urinary alkalization increases urine elimination of all the following drugs, except:** *Orissa 11*
 A. Salicylate B. Methotrexate
 C. Amphetamine D. Phenobarbital
18. **Alcohol, salicylates and pilocarpine can be used as:** *Orissa 11*
 A. Chelating agents B. Diaphoretics
 C. Purging D. Forced alkaline diuresis
19. **Hemodialysis is done in:** *Delhi 05*
 A. Organophosphorus poisoning
 B. Diazepam overdose
 C. Methanol poisoning
 D. CuSO_4 poisoning
20. **Hemodialysis is used in all the poisonings, except:** *AIIMS 05, 07; Gujarat 07; PGI 11*
 A. Kerosene oil B. Barbiturates
 C. Alcohol D. Cocaine
21. **Hemodialysis is NOT used in case of poisoning with:** *UP 05*
 A. Salicylates B. Methanol
 C. Barbiturates D. Benzodiazepines
22. **Charcoal hemoperfusion is useful in which poisoning:** *AIIMS 07*
 A. Barbiturates B. Methanol
 C. Salicylate D. Digoxin

Corrosive Poisons

37

Mineral Acids

Introduction

- Mineral acids produce coagulative necrosis, precipitate proteins with resultant hard eschar or scab (which may protect the underlying tissue from further damage), have no remote action and act as irritants when slightly diluted, but as stimulants when well diluted.¹
- Acids usually causes second degree, deep partial thickness burns, tend to be clearly demarcated and are dry, hard and mildly edematous.

- The stomach is the most commonly involved organ following an acid ingestion. This may due to some natural protection of the esophageal squamous epithelium.

*Common acids are:*¹

- Sulphuric acid (*oil of vitriol*, H₂SO₄)
- Nitric acid (*aqua fortis*, HNO₃)
- Hydrochloric acid (HCl)

The signs and symptoms, fatal dose, fatal period, post-mortem appearances and medico-legal aspects of these acids are given below in tabulated form.

Features	H ₂ SO ₄	HNO ₃	HCl
Physical properties	Colorless, odorless, burning taste, oily, non-fuming	Colorless, pungent, choking, burning taste, fuming	Colorless, pungent, sour, burning taste, fuming
Action			
• Local	Corrosive	Corrosive	Corrosive
• Indirect	<ul style="list-style-type: none"> Shock, asphyxia Perforation of stomach Chemical peritonitis Esophageal stricture 	Respiratory distress (inhalation) Pain → circulatory failure	Respiratory tract inflammation Pain → circulatory failure
Fatal dose (conc.)	5-10 ml	10-15 ml	15-20 ml
Fatal period	12-18 h	12-24 h	18-30 h
Signs and symptoms			
• Oropharyngeal burns and burning pain in throat, epigastrium	Present	Present	Present
• Dysphagia, dysphonia and dyspnea	Present	Present	Present
• Eructation, vomiting	Present	Present	Present
• Thirst	Present, drinking causes more vomiting	Same	Same
• Vomitus	Strongly acidic, with altered blood and mucous shreds	Same	Same
• Teeth	Chalky white, brittle	Yellowish coating, not brittle	No change
• Constipation	Usually present	Same	Same
• Urination	Suppressed	Same	Same
• Tenesmus	Present	Present	May be present
• Nature of stool	Mucus, altered blood	Same	Same
• Tenderness over abdomen	Present	Present	Present
• Stiffness of abdomen	Present, due to peritonitis	Present, due to distension	Present, due to distension
• Abdominal distension	Not usual	Present, due to gas in stomach	Present, due to gas in stomach
• Erosion of skin, mucous membrane of mouth and tongue	Over angles of mouth, lips, fingers with blackening, excoriation	Over angles of mouth, lips, fingers with yellow discoloration	Usually no erosion, epidermis may fall off after few days
• Perforation of stomach	Common	Less common	Less common

Contd...

Contd...

Features	H ₂ SO ₄	HNO ₃	HCl
Cause of death	<ul style="list-style-type: none"> • Shock • Perforation of stomach • Peritonitis • Laryngeal spasm • Malnutrition (due to esophageal stricture) 	<ul style="list-style-type: none"> • Shock • Perforation of stomach • Peritonitis • Laryngeal spasm • Respiratory distress 	<ul style="list-style-type: none"> • Shock • Laryngeal spasm • Pulmonary edema (due to inhalation of vapor)
Postmortem findings	<ul style="list-style-type: none"> • Erosion of skin, angles of mouth, lips • Corrosion of the trachea and larynx • Blackish charring of the stomach, peppery feel • Perforation of the stomach • Toxic swelling of the liver and kidneys 	<ul style="list-style-type: none"> • Yellow discoloration of skin • Corrosion of skin • Larynx and trachea: Congested • Stomach wall is soft, friable and ulcerated 	<ul style="list-style-type: none"> • Not much corrosion of skin • Brownish parchmentization • Inflammation of respiratory passages • Stomach contains brownish fluid
Medico-legal aspects	<ul style="list-style-type: none"> • Accidental, mistaking it for glycerin • Suicidal: common • Homicide is rare • Abortifacient • Vitriolage 	<ul style="list-style-type: none"> • Accidental or suicidal • Homicide is rare 	<ul style="list-style-type: none"> • Mostly suicidal • Accidental: few • Homicide and abortifacient: rare

Treatment

- i. Avoid gastric lavage or emetics.
- ii. Acid should be immediately diluted by giving a glass of milk or water to drink and 4 tablespoonfuls of aluminum hydroxide gel.
- iii. Give a demulcent, like olive oil, milk, egg white, starch water or butter.
- iv. Do not give bicarbonate or other neutralizing agents.
- v. Prednisolone 60 mg/day may be given in divided doses.
- vi. Correct circulatory shock, IV fluids and blood products are administered in the event of significant bleeding or vomiting. Antibiotics should be given, if evidence of perforation exists.
- vii. Tracheostomy, if there is edema of glottis.
- viii. Give nothing by mouth. Nutrient substances are given by IV route for about a week. Then, try liquids, soft food and finally a regular diet.
- ix. Morphine by injection to relieve pain.
- x. Symptomatic treatment.

Skin burns are washed with large amounts of water for 15 min. No chemical antidotes are used as the heat of the reaction may cause additional injury. For hydrofluoric acid burn, soak the area in benzalkonium chloride solution or apply 2.5% calcium gluconate gel.

Complications: Delayed perforation may occur as many as 4 days after an acid exposure. Delayed upper GI bleeding may occur in acid burns 3-4 days after exposure as the eschar sloughs. Gastric outlet obstruction may develop 3-4 weeks after an acid exposure.

Preservative: Viscera and skin are preserved in absolute alcohol or rectified spirit and the clothes are sent without any preservatives.

Abandonment of neutralizing agents for caustic ingestion

Earlier, recommendations for the treatment of acid ingestion included the use of magnesium hydroxide, lime water or calcium carbonate and for alkali ingestions included vinegar (acetic acid), lemon juice or dilute HCl. However, due to the rapid onset of action of corrosive agents, it may be too late to reverse the caustic process. Furthermore, the addition of neutralizing agents could increase the potential for a consequential exothermic reaction and/or gas production. Such reaction in an already weakened hollow viscus may lead to extension of the tissue injury or perforation. Hence, the use of neutralizing agents is no longer recommended.

Vitriolage (Vitriol Throwing)

Definition: It is the throwing of any corrosive, not necessarily sulphuric acid, on a person with malicious intent. Sulphuric acid is most commonly used for this purpose, hence it is called vitriolage.²

Other substances used: Nitric acid, carbolic acid, caustic soda, caustic potash, iodine, marking nut juice or calotropis.

Characteristics of Burns

- i. Discoloration and staining of the skin and clothings (brown or black in sulphuric acid and yellow in nitric acid).
- ii. Trickle marks.
- iii. Painless burns with absence of vesication and red line of demarcation.

- iv. Presence of chemical substance in the stains.
- v. Repair is slow and scar tissue causes contractures.

Treatment

- i. Wash the parts with plenty of water and soap.
- ii. Apply thick paste of MgO or carbonate.³
- iii. Cover raw surface with antibiotic ointment.
- iv. For *eye burns*, the conjunctiva and corneal surfaces are anesthetized with topical anesthetic drops (e.g. proparacaine) and irrigated with water for 15 min holding the eyelids open. Repeat irrigation using 0.9% saline, till pH is near 7.0. Eye drops containing antibiotics and steroids are helpful.

Medico-legal Aspects

These fluids are usually thrown on the face with the object of destroying vision or causing facial disfigurement, and this results in *grievous hurt*.

Oxalic Acid (Acid of Sugar, C₂H₂O₄)

Physical properties: Colorless, transparent, prismatic crystals and resembles MgSO₄ and ZnSO₄. Oxalic acid is a naturally occurring component of plants and is found in relatively high levels in dark-green leafy foods, e.g. beet leaves, purslane, spinach, rhubarb and parsley.⁴

Uses: Oxalic acid forms soluble chelates with iron. This property makes it useful for removing blood and rust stains, cleaning metals other than iron and flushing car radiators. It is used in many chemical processes like bleaching and dyeing. It may be used to remove signatures/writings from documents in cases of forgery.

Action: It acts *locally* as a corrosive on both skin and mucosa, and remotely affects several systems after being absorbed.

- CVS → shock → death
- Electrolyte system → extracts tissue calcium → hypocalcemia
- Renal system → tubular necrosis → uremia → death

Signs and Symptoms

Poisoning presents in three forms:

- i. **Fulminating poisoning:** Intake of large dose (> 15 g) produces immediate symptoms and death within minutes. There is a burning, sour or bitter taste in the mouth with a sense of constriction around the throat and burning pain from the mouth to stomach, radiating all over the abdomen.

Nausea and eructation are immediately followed by vomiting which contains altered blood, mucus and has a *coffee-ground appearance* (black in color). Severe thirst, diarrhea, electrolyte imbalance and ultimately death occur.

- ii. **Acute poisoning:** All findings are due to hypocalcemia—tingling and numbness of fingers and limbs, weakness, parasthesia, carpopedal spasm, hyperirritability of peripheral nerves (*Chvostek/Weiss sign*), tetany, convulsions, coma and death.
- iii. **Delayed poisoning:** It is characterized by nephritis—uremia, scanty urine, hematuria, albuminuria, oxaluria (presence of envelope-shaped calcium oxalate crystals in the urine is seen under microscope).

Fatal dose: 15-20 g.

Fatal period: 1-2 h. In case of renal failure, death may occur between 2 days to 2 weeks.

Treatment

- i. Gastric lavage with calcium lactate (2 teaspoons/lavage).
- ii. **Antidotes:** Limewater, calcium lactate, calcium gluconate or calcium chloride when given orally (150 mg/kg), act as specific antidotes and form insoluble calcium oxalate and are excreted.
- iii. **Calcium gluconate:** 10 ml of 10% solution IV frequently.
- iv. **Parathyroid extracts:** 100 units IM.
- v. Demulcent drink, bowel washes by enema and purgatives.
- vi. Hemodialysis and exchange transfusion can be helpful.
- vii. Symptomatic treatment.

Postmortem Findings

External: No specific findings. Burns may be present on face and skin.

Internal

- i. Mucosa of the mouth, tongue, pharynx and esophagus are bleached and corroded. There are desquamation and hemorrhages.
- ii. **Stomach:** Mucosa is reddened and punctate due to erosions, giving velvety red or blackish appearance. Wall of the stomach is softened, but no perforation and contains gelatinous brown material (due to acid hematin formation).

- iii. *Kidneys*: Swollen and congested. Tubules on histopathology show oxalate crystals. Renal tubules are necrosed, primarily the PCT.
- iv. All other viscera are congested.

Medico-legal Aspects

- Usually consumed accidentally, mistaken for $MgSO_4$ or sodium bicarbonate.
- Suicidal or homicidal cases are rare due to its sour/bitter taste.
- Abortifacient to induce criminal abortion.

Carbolic Acid (Phenol, C_6H_4OH)

Physical properties: Pure phenol is colorless, prismatic needle-shaped and crystalline in form. On exposure to air, it turns pink and liquefies.

Phenol is slightly acidic; the molecules have weak tendencies to lose the H^+ ion from the hydroxyl group, resulting in the highly water-soluble phenolate anion $C_6H_5O^-$ (also called *phenoxide*).

Uses: It is used as an antiseptic or disinfectant. *Lysol* is a 50% solution of cresol in saponified vegetable oil. *Dettol* is a chlorinated phenol with turpeneol.

Absorption: It is ingested, inhaled and absorbed through skin, per rectum/per vaginam.

Metabolism and Excretion

- Phenol is metabolized mainly through the kidneys, wherein it gets converted into *hydroquinone* and *pyrocatechol* and excreted in the urine, partly free and partly in an unstable combination with glucuronic acid. Further oxidation of hydroquinone and pyrocatechol cause a dark smoky green coloration of the urine known as *carboluria*.^{5,6}
- It may also cause pigmentation in the cornea and various cartilages, a condition called *ochronosis*.⁷

Ochronosis is the bluish black discoloration of tissues, such as the ear cartilage and the ocular tissue (sclera, between the margin of the cornea and the outer or inner canthus), seen with alkaptonuria (autosomal recessive metabolic disorder caused by deficiency of homogentisic acid oxidase). It can also occur from exposure to various substances, such as phenol, trinitrophenol, resorcinol, mercury, picric acid, benzene, hydroquinone and antimalarials.

Signs and Symptoms

Poisoning by carbolic acid is known as **carbolism**.

System*	Signs and symptoms
Local	Damage to nerve endings with initial tingling sensation (<i>pins and needles sensation</i>). Later, there is numbness, coagulation necrosis and gangrene of tissues that becomes a grayish white slough. Painless, white, opaque eschar is formed and falls off in few days and leaves a brown stain.
GIT	Initially, there is burning and tingling sensation and later on anesthesia. Diarrhea, pain in abdomen, but vomiting is rarely seen.
RS	Odor of phenol in breath. Inhalation of phenolic vapors causes laryngeal and pulmonary edema. Stertorous breathing and cyanosis are seen.
MS	Muscular spasms, convulsions.
CNS	Headache, giddiness, tinnitus, pupils are contracted.
CVS	Pulse is rapid, feeble and irregular. Skin is cold, clammy and sweating. Collapse, unconsciousness and coma.

Phenol being fat-soluble, attacks the nervous system and causes paralysis of respiratory and CVS centres leading to death.

Fatal dose: 1-2 g.

Fatal period: 3-4 h.

Treatment

- i. Stomach is washed carefully with plenty of lukewarm water containing charcoal, olive oil, $MgSO_4$ or Na_2SO_4 . Medicinal liquid paraffin or 30 g of $MgSO_4$ may be left in the stomach after the lavage.
- ii. Demulcents may be given.
- iii. Saline containing 7 g of $NaHCO_3$ /l is given IV to combat circulatory depression, dilute carbolic acid in blood and encourage diuresis.
- iv. If phenol falls on the body, contaminated clothing should be removed at once, skin cleaned and the area washed with soap and water. To prevent further absorption, apply olive oil/methylated spirit.

There is not much of a role for emetics.

Postmortem Findings

External: Grayish or brownish corrosions at the angle of the mouth, chin, front of the body, arms and hands with phenolic odor. Putrefaction is retarded.⁸

* GIT—Gastrointestinal Tract, RS—Respiratory System, MS—Muscular System, CNS—Central Nervous System, CVS—Cardiovascular System

Internal

- i. Corrosion of the GIT mucosa, and laryngeal and pulmonary edema.
- ii. *Stomach*: Marked corrosion of gastric mucosa and swelling of mucosal folds with coagulated grayish or brownish silvery mucus on it.
 - Intervening normal mucosal folds appear dark red in color.
 - Hardening of the stomach wall—**leathery stomach**.⁹
 - Vomitus and gastric lavage collection show partially detached gastric mucosa.
- iii. *Kidneys*: Hemorrhagic nephritis.

Medico-legal Aspects

- It is used for suicidal purposes.
- Accidental poisoning may occur.
- Phenol is rarely used for homicidal poisoning because of its odor and taste.
- Sometimes, it is used as an abortifacient.

Boric acid (*Hydrogen borate/Orthoboric acid*)

Boric acid is a weak acid of boron which is used as an antiseptic, insecticide (especially for cockroaches), flame retardant, as a neutron absorber and as a precursor of other chemical compounds. Boric acid crystals are white, odorless, nearly tasteless and dissolves in water.

Metabolism: Boric acid is not metabolized; it is eliminated unchanged in the urine.

Signs and symptoms

System	Signs and symptoms
GIT	Nausea, vomiting, diarrhea and occasionally crampy abdominal pain—may be confused with acute gastroenteritis. Emesis and diarrhea may be bluish-green.
Dermal	Generalized erythema creating a 'boiled lobster' appearance with massive areas of desquamation indistinguishable from toxic epidermal necrolysis or staphylococcal scaled skin syndrome in the neonate. Rash is particularly seen on the palms, soles and buttocks. ¹⁰
CNS	Irritability, seizures, delirium and coma may occur.
Renal	Oliguria, renal tubular damage and elevated serum creatinine.
CVS	Tachycardia, hypotension.
Other	Hepatic injury, hyperthermia.

Death results from circulatory collapse.

Fatal dose: 15-20 g in adults; 5-6 g in children and 2-3 g for infants.

Treatment: Supportive treatment. Activated charcoal is not recommended because of its poor adsorptive capacity for

boric acid. Hemodialysis and exchange transfusion may be helpful.

Medico-legal: Because of the wide availability of boric acid, accidental intake by children occurs frequently. It may be taken by mistake and suicidal purposes. The abandonment of boric acid as an irritant and particularly its removal from nursery setting (for treatment of napkin dermatitis) have led to a marked decrease in the incidence of significant boric acid poisoning.

Strong Alkalis (Caustic Alkalis)

Common poisons are ammonia, potassium hydroxide, sodium hydroxide, and carbonates of ammonia, potassium and sodium.

Action: Caustic alkalis produce more severe injury than acids because they absorb water from tissues, precipitate protein and produce liquefaction necrosis resulting in deeper penetration and saponification of fats with marked edema.

Signs and Symptoms

Lesions caused by caustic alkalis are of same extent and distribution as those of acids.

- i. There is caustic taste and sensation of burning heat from the throat to the stomach. The vomited matter is alkaline and does not effervesce on contact with the ground. It is at first thick and slimy, but later contains dark altered blood and shreds of mucosa.
- ii. Purging is a frequent symptom accompanied by severe pain and straining.
- iii. Motions consist of mucus and blood.
- iv. Blisters and brownish discoloration is seen on the lips and the skin around the mouth.
- v. Mucosa of the digestive tract is soft, swollen with gray slough which readily detaches.
- vi. Esophageal stricture formation is a major long-term complication.

Ammoniacal vapor when inhaled causes congestion and watering of eyes, violent sneezing, coughing and choking. Sudden collapse and death may occur from suffocation.

Fatal dose

- KOH and NaOH: 5 g.
- Ammonia: 30 g.
- Sodium and potassium carbonate: 15-30 g.

Fatal period: 24 h.

Treatment

Supportive care, rather than specific antidotes is the mainstay of management following caustic ingestions.

- i. Gastric lavage or emetics are contraindicated.
- ii. Dilute immediately with water.
- iii. Demulcents, like egg white and milk may be given.
- iv. In poisoning by ammonia vapor, O₂ inhalation should be given.
- v. Keep airway patent, tracheostomy if necessary.
- vi. Give adequate parenteral analgesics and antibiotics.
- vii. Steroid is of no benefit and is contraindicated in case of esophageal perforation.

Complications: Airway edema or obstruction may occur immediately or upto 48 h following alkali ingestion.

Postmortem Findings

- i. The marks about the mouth become dark in color and parchment-like after death.
- ii. Inflammatory edema with corrosion and sliminess of the tissues of the esophagus and stomach are

prominent features. Most severely affected is the *squamous epithelium of the esophagus* with the stomach much less frequently involved after alkaline ingestions.¹¹

- iii. Mucosa may be brownish due to formation of alkali hematin.
- iv. Perforation of the esophagus or stomach is rare.
- v. Kidneys are inflamed and congested.

Medico-legal Aspects

- Accidental poisoning is common in children.
- Homicidal cases are rare, and few suicidal cases are seen.
- Poisoning by ammonia is more common than with other alkalis.

MULTIPLE CHOICE QUESTIONS

1. **Poison having local action only:** *COMEDK 07*
 A. Sulphuric acid B. Carbolic acid
 C. Oxalic acid D. Phosphorus
2. **Vitriolage means:** *PGI 03*
 A. Using vitriol for suicide
 B. Using vitriol for murder
 C. Vitriol throwing
 D. Perforation of stomach after consuming H₂SO₄
3. **Antidote for mineral acid poisoning is:** *TN 08*
 A. MgSO₄ B. CuSO₄
 C. NaHCO₃ D. MgO
4. **Common toxin through vegetables:** *DNB 08*
 A. Boric acid B. Carbolic acid
 C. Tartaric acid D. Oxalic acid
5. **Green colored urine is seen after ingestion of:** *Kerala 09; AP 09; PGI 11*
 A. Copper sulphate
 B. Phenol
 C. Organophosphorus
 D. Cyanide
6. **Color of urine in phenol poisoning:** *JIPMER 10, 11*
 A. Red B. Green
 C. Yellow D. Blue
7. **Ochronosis is seen in poisoning with:** *DNB 09; FMGE 11*
 A. HCl B. Boric acid
 C. Oxalic acid D. Carbolic acid
8. **Which of the following poison retards putrefaction:** *Delhi 07*
 A. Organophosphorus B. Carbolic acid
 C. Oxalic acid D. HCl
9. **Leathery stomach is seen in poisoning with:** *BHU 09*
 A. HCl B. H₂SO₄
 C. Carbolic acid D. Oxalic acid
10. **'Boiled lobster' appearance is seen in poisoning with:** *DNB 08*
 A. Carbolic acid B. Boric acid
 C. Oxalic acid D. H₂SO₄ poisoning
11. **Maximum damage to esophagus is with:** *Punjab 11*
 A. H₂SO₄ B. Sodium hydroxide
 C. Acetic acid D. Nitric acid

-
1. A 2. C 3. D 4. D 5. B 6. B 7. D 8. B 9. C 10. B
 11. B

Inorganic Metallic Irritants— Arsenic

38

Physical properties: Metallic arsenic (black in color) is not poisonous, as it is not absorbed from the GIT. It is a normal constituent of all animal tissues, in minute amounts.

Toxic Compounds and its Uses

- i. **Arsenious oxide or arsenic trioxide** (*sankhya, somalkhar*, white arsenic or arsenic): Most toxic form of arsenic. It has no taste or smell and is sparingly soluble in water. It is used in fruit sprays, sheep-dips, weed-killers, insecticides, rat poisons, flypapers, calico-printing, wallpapers, artificial flowers and as mordant in dyeing.
- ii. **Copper arsenite** (Scheele's green) and **copper acetoarsenite** (Paris green or emerald green): It is used as coloring agent for substances including confectionary.
- iii. **Sodium and potassium arsenate.**
- iv. **Arsenic sulphide:** Yellow orpiment (*hartal*) or arsenic trisulphide, and red realgar or arsenic disulphide are used as depilatory, coloring pigment and in flypaper.
- v. Arseniuretted hydrogen or arsine is a colorless gas with garlic-like odor.
- vi. The **natural sources** of arsenic are soil, water and some sea fish (mussels, prawns). High arsenic content of soil and subsoil water of some places is the cause of endemic toxicity (from shallow tube-wells inserted for drinking water).
- vii. Tobacco smoke, particularly cigars also contain arsenic, and in some beers as impurities.

Action

- Arsenic interferes with cellular respiration by uncoupling mitochondrial oxidative phosphorylation by combining with the sulphhydryl groups of mitochondrial enzymes, especially pyruvate

dehydrogenase and certain phosphatases. Consequently, conversion of pyruvate to acetyl CoA is decreased, citric acid cycle activity is decreased and production of cellular ATP is decreased.

- It inhibits cellular glucose uptake, gluconeogenesis, fatty acid oxidation and further production of acetyl CoA.
- Locally, it causes irritation of the mucous membranes, and remotely, depression of the nervous system.
- Arsenic is a carcinogenic substance since lung, skin and bladder (transitional cell) carcinoma has been observed in populations with multiple exposures.

Absorption and Excretion

It is absorbed orally through the GIT, skin and lungs (arsine) or parenterally.

- It is present in almost all tissues and found in the greatest quantity in the liver, followed by kidneys and spleen.¹
- In cases, where the patient survives, it is found in the muscles (for months), bones, hair, nails and skin (sulfur-containing keratin) for years. Normally, the hair contains < 2 parts/million arsenic.

It is excreted mainly by the kidneys, but some part through feces, bile, sweat, milk, nails and hair.

- The arsenic is excreted in the hair and nails within few hours of ingestion, and in cases of intermittent chronic poisoning there will be successive deposits of arsenic in the hair and nails.
- Arsenic is secreted into the stomach and intestines after absorption, even when given by routes other than mouth.

Signs and Symptoms (Acute Poisoning)

Symptoms usually appear by 1 h after ingestion, but may be delayed, if arsenic is taken with food.

System	Signs and symptoms
GIT	Sweetish metallic taste, nausea, persistent vomiting, burning in mouth and throat, and difficulty in swallowing, garlic odor in breath, intense thirst, pain in esophagus and abdomen, purging accompanied by tenesmus, pain and irritation about the anus. Initially, defecation is frequent and involuntary, dark-colored, but later it become colorless, odorless and watery resembling <i>rice-water</i> .
Renal	Oliguria, uremia, albuminuria, red cells and casts, pain during micturition.
CVS	Hypotension, circulatory collapse, ventricular tachycardia and fibrillation.
Hepatic	Fatty infiltration.
MS	Pain in limbs, weakness.
CNS	Headache, vertigo, hyperthermia, tremors, convulsions, coma, general paralysis.
Skin	Delayed loss of hair, skin eruptions.

In **fulminant type**, when large dose (> 3 g) is taken, the GIT symptoms are absent and death occurs in 1-3 h from shock and peripheral vascular failure.

In **narcotic type**, the GIT symptoms are less. There is giddiness, formication, tenderness of the muscles, delirium, coma and death. Rarely, there is complete paralysis of the extremities.

Arsine gas exposure causes hemolysis, damages the liver and kidneys (hemoglobinuria and renal failure) and depresses the CNS. There is nausea, vomiting, shaking chills, backache and anemia. The urine appears black due to hemoglobinuria. Death may be preceded by anuria and convulsions.

Acute exposures generally manifest with the cholera-like gastrointestinal symptoms of vomiting and severe diarrhea (Diff. 38.1).²

Fatal dose: 120-200 mg of arsenic trioxide (adults), 2 mg/kg (children).

Fatal period: 1-2 days.

Laboratory Investigations

Urine, stool, blood, vomit, hair and nails from patients and in addition, stomach and intestinal contents, bone, liver, bile and kidneys from dead bodies are tested.

- **Urine:** Excretion of > 50 µg/l in 24 h urine is indicative of poisoning. Metabolites of arsenic including methylarsonic acid and dimethylarsenic acid may be recovered in a urine specimen.
- **Blood** (serum arsenic > 0.9 µg/dl), stool, liver, kidneys and bones show presence of arsenic. As with all heavy metals, microcytic hypochromic anemia is common.
- **Hair:** Arsenic > 75 µg% is suggestive of poisoning.
- **Nails:** Presence of > 100 µg% of arsenic is suggestive of poisoning.
- Radiopaque sign on abdominal X-ray.
- **ECG:** QRS broadening, QT prolongation, ST depression and T-wave flattening.
- *Marsh, Reinsch and Gutzeit tests* are obsolete.³

Neutron activation analysis and atomic absorption spectroscopy helps in estimating concentration of arsenic in hair, nails and bone.

Treatment

Hemodynamic stabilization is of primary importance, and large amounts of crystalloid solutions may be required because of significant GI losses (i.e. vomiting and diarrhea).

Differentiation 38.1: Arsenic poisoning and cholera

S.No.	Feature	Arsenic poisoning	Cholera
1.	Pain in throat	Before vomiting	After vomiting
2.	Vomiting and purging	Purging follows vomiting	Vomiting follows purging
3.	Vomit	Contains mucus, bile and blood	Watery, without mucus, bile or blood
4.	Stools	Rice-watery, may contain blood	Rice-watery, no blood and passed in a continuous involuntary jet
5.	Tenesmus and pain around anus	Present	Absent
6.	Voice	Not affected	Rough and whistling
7.	Conjunctiva	Inflamed	Not inflamed
8.	Laboratory investigation	Arsenic present	<i>Vibrio cholerae</i> present
9.	Circumstantial evidence	Poisoning may be present in an individual or a family or a group	May occur in sporadic or epidemic form in the locality
10.	Motive	Homicidal, rarely accidental	No such thing

- i. Gastric lavage is done repeatedly with large amount of warm water and milk; activated charcoal does not adsorb arsenic appreciably and is not recommended in patients whom co-ingestants are not suspected.
- ii. Demulcents (butter or greasy substances) prevent absorption.
- iii. Whole bowel irrigation with polyethylene glycol may be effective to prevent GIT absorption of arsenic.
- iv. **Antidote** is BAL or *dimercaprol*, given in a dose of 3-5 mg/kg IM 4 hourly for 2 days, 6 hourly for 1 day and then 12 hourly for 10 days. Oral *succimer* (DMSA), 10 mg/kg every 8 hourly for 10 days or *dimerval* (DMPS, drug of choice for treating most heavy metal poisonings), 200 mg IV 4 hourly until oral product can be given in a dose of 100 mg TDS or QID may be used instead of BAL.
- v. Alkalis should not be given by mouth as they increase the solubility of arsenic.
- vi. Purgatives (castor oil/magnesium sulphate) are given to remove unabsorbed poison from intestine.
- vii. Glucose-saline with sodium bicarbonate is helpful to combat shock and improve alkali reserve.
- viii. Hemodialysis or exchange transfusion may be done.
- v. *Stomach*: Mucosa is swollen, edematous, desquamated and red, either generally or in patches, especially in the pyloric region. Usually, groups of petechiae are seen scattered over the mucosa, but sometimes large submucosal and subperitoneal hemorrhages may be seen—**red velvety appearance**.⁵ A mass of sticky mucus covers the mucosa in which particles of arsenic may be seen. Congestion is most marked along the crest of the rugae. Inflammation is more marked at the greater curvature, posterior part and the cardiac end of the stomach.
- vi. *Small intestine*: It contains large flakes of mucus with very little fecal matter. The mucosa is pale-violet and shows signs of inflammation with submucous hemorrhages along its whole length.
- vii. *Caecum and rectum* show slight inflammation.
- viii. *Liver, spleen and kidneys*: Congested, enlarged and show cloudy swelling and occasionally fatty degeneration. Nephritis is seen.
- ix. *Brain*: Edema with patchy necrosis or hemorrhagic encephalitis. The meninges are congested.

Earlier, freshly precipitated ferric hydroxide (*antidotum arsenici*) was used for stomach wash in the treatment of arsenic poisoning which formed ferric arsenite, is no longer recommended.

Postmortem Findings

External

- i. The body looks emaciated due to dehydration.
- ii. Rigor mortis appears early.
- iii. Putrefaction is delayed due to anti-bacterial action of arsenic and partly due to dehydration.⁴
- iv. The eyeballs are sunken and the skin is cyanosed.
- v. Blood tinged vomitus and fecal matter may be present on body and clothes.

Internal

- i. The mucous membrane of the mouth, pharynx and esophagus may show inflammation or ulceration.
- ii. Hemorrhages may be found in the abdominal organs, mesentery and occasionally in the larynx, trachea and lungs.
- iii. *Lungs*: Congested with subpleural ecchymoses.
- iv. *Heart*: Subendocardial petechial hemorrhages of the ventricle may be found, even when the stomach shows little signs of irritation.

Chronic Arsenic Poisoning

It may occur due to:

- Recovery from an acute poisoning.
- Accidental ingestion of small doses repeatedly by those working with the metal.
- Intake of food/drink in which there are traces of arsenic (may be homicidal in nature).

Tolerance: Some people take arsenic daily as a tonic or as an aphrodisiac and they acquire tolerance to 250-300 mg or more in one dose. Such people are known as *arsenophagists*.

Signs and Symptoms

It is divided into four stages (Table 38.1):

- i. GIT disturbances
- ii. Catarrhal changes
- iii. Skin rashes
- iv. Nervous disturbances

Chronic exposure also causes diabetes, vasospasm, peripheral neuropathy and peripheral vascular insufficiency.

Treatment

- i. Remove the patient from the source of exposure and administer BAL in usual doses.
- ii. Vitamin B complex and IV sodium thiosulphate are useful.
- iii. Symptomatic treatment.

Table 38.1: Signs and symptoms in chronic arsenic poisoning

System	Signs and symptoms
GIT	Nausea, vomiting, abdominal cramps, loss of appetite, diarrhea, salivation.
Ocular	Congestion, watering of the eyes, photophobia.
RS	Cough, hoarseness of voice, bronchial catarrh, hemoptysis, dyspnea.
Skin and nails	There may be a rash resembling fading measles rash. Speckled brown pigmentation, mostly on the skin flexures, temples, shoulders, eyelids and neck (raindrop appearances with patches of leucoplakia). Hyperkeratosis of the palms and soles with irregular thickening of the nails and development of white bands of opacity in the nails of fingers and toes (called Aldrich-Mees lines). Brittle nails and alopecia are also seen. ⁶⁻⁹
CNS	Tingling, numbness of hands and feet, polyneuritis, anesthesia, paraesthesia with painful swelling (<i>erythromelalgia</i>), encephalopathy. Neuritis resembles chronic alcoholism.
CVS	Cardiac failure, dependent edema.
Renal	Chronic nephritis.
Hepatic	Hepatomegaly, jaundice, cirrhosis of the liver.
Hematologic	Bone marrow suppression, hypoplasia, anemia, thrombocytopenia and leukemia.

Postmortem Findings

External: Emaciation, pigmentation, keratosis, alopecia, white streaks on nails, jaundice, wasting of muscles, and ulceration of nasal septum.

Internal

- i. *Stomach:* It may be normal or may show a chronic gastritis. Some rugae may show patchy inflammatory redness.
- ii. *Small intestine:* Reddish with thickened mucosa.
- iii. *Liver:* Fatty degeneration or even necrosis.¹⁰
- iv. *Kidneys:* Tubular necrosis.
- v. *Heart:* Myocardial necrosis may be seen.

If arsenic poisoning is suspected, hair or tissue samples should be obtained for confirmation.

Medico-legal Aspects

Arsenic poisoning can be homicidal, suicidal, accidental, occupational or unintentional.

- i. **Homicide:** Arsenic was a popular homicidal poison because:

- | | |
|---|---------------------|
| • Onset of symptoms is gradual | • Cheap |
| • Symptoms simulate those of cholera | • Colorless |
| • Small quantity is required to cause death | • Tasteless |
| • Can be administered easily with food, drink or betel leaf (<i>paan</i>) | • Odorless |
| • Chronic cases causing debility resemble certain diseases | • Easily obtainable |

Disadvantages of arsenic as homicidal poison:

- It retards putrefaction.
- It can be detected in decomposed/buried bodies.

- Arsenic can be found in bones, hair and nails for several years.^{11,12}
- It can be detected in charred bones or ashes.¹²
- ii. **Suicide** is rare, because it causes too much of pain.
- iii. **Accidental** death may be due to admixture with articles of food or from its improper medicinal use. Chronic poisoning results from drinking well water containing arsenic.
- iv. Arsenic exposure can be occupational in those working in metal foundry, mining, glass production or in the semiconductor industry.
- v. It is sometimes ingested or applied locally in the form of a paste or ointment on abortion sticks to procure abortion.
- vi. It may be used as cattle poison.

Postmortem Imbibition of Arsenic

Arsenic is the 12th most abundant element on earth. This makes it essential that in postmortems and exhumations, the possibility of imbibition from the surrounding earth should be considered. Adequate controls should be taken from surrounding and distant soil and ground water, as any arsenic found in the body may find its way by percolation from natural sources. Keratin tissues absorb arsenic by contamination from outside. The concentration in hair and nails thus contaminated is likely to be much greater than the concentration of arsenic in the contaminating fluid. In poisoning cases, the concentration of arsenic will be more than in the soil/ground water.

MULTIPLE CHOICE QUESTIONS

- In arsenic poisoning, greatest amount is found in: *PGI 04, 06*
 A. Muscle B. Kidney
 C. Liver D. Brain
- Cholera presents with symptoms mimicking: *TN 10*
 A. Arsenic poisoning
 B. Dhatura poisoning
 C. Barbiturate poisoning
 D. Morphine poisoning
- Reinsch test is used in diagnosis of poisoning due to: *UP 11*
 A. Arsenic B. Lead
 C. Iron D. Copper sulphate
- In a suspected case of death due to poisoning where cadaveric rigidity is lasting longer than usual, it may be a case of poisoning due to: *AIIMS 03; UP 07; DNB 10; Bihar 10*
 A. Lead B. Arsenic
 C. Mercury D. Copper
- 'Red velvety' stomach mucosa is seen in poisoning with: *Gujarat 07*
 A. Mercury B. Arsenic
 C. Lead D. Copper
- Arsenic causes all, except: *PGI 06; WB 09*
 A. Raindrop pigmentation
 B. Alopecia
 C. Palmar hyperkeratosis
 D. Blue line in gums
- A middle aged man presented with paraesthesia of hands and feet. Examination revealed presence of 'Mees' lines in the nails and raindrop pigmentation in the hands. The most likely diagnosis is: *AI 04, 08; AIIMS 08, 09, 11*
 A. Lead poisoning
 B. Arsenic poisoning
 C. Thallium poisoning
 D. Mercury poisoning
- Raindrop pigmentation is seen in: *Jharkhand 03; Kerala 07; BHU 10*
 A. Arsenic poisoning
 B. Phosphorous poisoning
 C. Mercury poisoning
 D. Thallium poisoning
- Mees's lines are characteristic of: *Delhi 06; PGI 09; CMC (Ludhiana) 10*
 A. Mercury poisoning B. Arsenic poisoning
 C. Lead poisoning D. Copper poisoning
- Fatty yellow liver is seen in poisoning with: *AI 08*
 A. Arsenic B. Aconite
 C. Oxalic acid D. Mercury
- The poison that can be detected in hair/bones long after death is: *Gujarat 07; COMEDK 08; FMGE 08*
 A. Lead B. Mercury
 C. Arsenic D. Cannabis
- In chronic arsenic poisoning, the following samples are useful for laboratory examination, except: *AI 05*
 A. Nail clippings B. Hair samples
 C. Bone biopsy D. Blood sample

1. C 2. A 3. A 4. B 5. B 6. D 7. B 8. A 9. B 10. A
 11. C 12. D

Inorganic Metallic Irritants— Mercury

39

Physical properties: Mercury (quicksilver/*para*) is a heavy, silvery liquid and volatile at room temperature. Liquid metallic mercury is not poisonous, if swallowed, as it is poorly absorbed from the GIT. It is not a constituent of the human body.

Toxic Compounds

A. Inorganic salts

- i. **Mercuric chloride** (corrosive sublimate): Colorless, odorless, prismatic crystals or white crystalline powder, but has a nauseous metallic taste. It is the most toxic salt and commonly the cause of acute poisoning.
- ii. **Mercurous chloride** (calomel): Heavy, amorphous, white and tasteless powder.
- iii. **Mercuric sulphide** (*cinnabar* or *vermilion*): It is not absorbed through skin and is as such non-poisonous (red crystalline powder).
- iv. **Mercuric cyanide, oxide** and **iodide** (scarlet red powder).

B. *Organic salts* include methyl mercury, dimethyl mercury, ethyl mercury and phenyl mercury.

Uses

- **Medicine:** Disinfectant, dental amalgam, purgative and diuretic, and earlier used in the treatment of syphilis.
- **Industry:** Manufacture of thermometer, barometer, calibration instruments, fluorescent and mercury vapor lamp, electrical equipment, explosives and fireworks.
- **Miscellaneous:** Electroplating, photography, insecticide, germicide, and constituent of fingerprint powder, paints and embalming fluid.

Action

- Mercury binds with sulfhydryl groups resulting in enzyme inhibition and pathological alteration of cellular membranes.
- Elemental mercury and methyl mercury are toxic to the CNS. Metallic mercury vapor is also a pulmonary

irritant. Inorganic mercury salts are corrosive to the skin, eyes and GIT and nephrotoxic. Inorganic and organic forms may cause contact dermatitis.

Absorption and Excretion

- It is absorbed through the GIT and respiratory tract.
- After absorption, mercury gets deposited in all tissues, particularly in the liver, kidneys, spleen and bones. When inhaled, the maximum concentration occurs in the brain.
- Mainly excreted through the kidneys, liver (bile) and colonic mucous membrane. It passes rapidly to the fetus through placental circulation.

Signs and Symptoms (Acute Poisoning)

Inhalation of mercury vapor causes chemical pneumonitis, pulmonary edema, gingivostomatitis and CNS symptoms, like ataxia, restriction of visual field, paresis, delirium and polyneuropathy.

Ingestion of inorganic mercuric salts

It is divided into two phases.

First phase

System	Signs and symptoms
GIT	<ul style="list-style-type: none">• Metallic taste, feeling of constriction in the throat, hoarse voice.• Mouth, tongue and fauces become corroded, swollen and mucous membrane appears grayish white.• Hot burning pain from the mouth to the stomach and pain radiating over the abdomen followed by nausea, retching and vomiting. Vomitus contains grayish, slimy, mucoid material with blood and shreds of mucous membrane.• This is followed by diarrhea, often bloody with tenesmus (gastroenteritis).
Renal	Oliguria, albuminuria and hematuria ending in renal failure or nephritic syndrome.
CVS	Hypertension, tachycardia, difficulty in breathing and circulatory collapse.

Second phase: If person survives, 2nd phase begins in 1-3 days.

- i. Glossitis and ulcerative gingivitis appear in 24-36 h. Renal tubular necrosis produces polyuria, albuminuria, cylindruria, uremia and acidosis.
- ii. Recovery may occur within a fortnight, but *membranous colitis* may develop and produce dysentery, ulceration of colonic mucosa and hemorrhage.

Fatal dose: 1-4 g of mercuric chloride; 10-60 mg/kg of methyl mercury and 10 mg/m³ of mercury vapor.

Fatal period: 3-5 days.

Diagnosis: Blood mercury level > 3.6 µg/dl, and 24 h urinary excretion of mercury > 15 µg/l indicates toxicity.

- Urine and blood mercury levels are assessed by *atomic absorption spectrophotometer*.
- Mercury concentration of hair is best assessed by *neutron activation analysis* (remote or chronic exposure to methyl mercury).

Treatment

- i. In case of *inhalation*, the victim is immediately removed from source of exposure and supplemental oxygen is given, and observed for the development of acute pneumonitis and pulmonary edema.
- ii. Egg whites, milk or animal charcoal to precipitate mercury. Emesis is not induced because of the risk of serious corrosive injury.
- iii. Gastric lavage with 250 ml of 5% *sodium formaldehyde sulphoxylate*. About 100 ml of this solution is left in the stomach. Lavage can be done with egg-white solution or 2-5% solution of sodium bicarbonate.
- iv. Polythiol resins helps in binding mercury in the GIT.
- v. High colonic lavage with 1:1000 solution of sulphoxylate twice daily. Whole bowel irrigation may be done.
- vi. *BAL* is the *chelator of choice* (10% solution in oil, 3-5 mg/kg IM every 4 h for 2 days upto 24 mg/kg/day, tapered to 6 hourly for 1 day and then 12 hourly for 7 days).
- vii. *DMSA* or *succimer* (10 mg/kg orally every 8 h for 5 days and then 12 hourly for 2 weeks) is a good alternative.
- viii. *D-penicillamine* is an alternative oral treatment, but it may be associated with more side-effects and less efficient Hg excretion.

- ix. There is no role of for dialysis, hemoperfusion or repeat dose charcoal in removing metallic mercury or inorganic salts. However, hemodialysis/peritoneal dialysis may be required in case of renal failure.
- x. Maintain electrolyte and fluid balance.
- xi. Symptomatic treatment.

Postmortem Findings

- i. Body looks emaciated.
- ii. *GIT*: Mucosa shows inflammation, congestion and grayish corrosion. Ulceration or even gangrene of large intestine may be seen.
- iii. *Kidneys*: Acute proximal tubular damage and glomerular degeneration or glomerular nephritis (membranous glomerulopathy) may be seen.
- iv. *Liver*: Congested and shows cloudy swelling or fatty change.
- v. *Heart*: Fatty degeneration and subendocardial hemorrhage.

Chronic Mercury Poisoning (Hydrargyrim)

Chronic poisoning results from:

- Continuous accidental absorption by workers.
- Excessive therapeutic use.
- Recovery from a large dose.
- If an ointment is used as an external application for a long time.

Signs and Symptoms

Chronic intoxication from inhalation of mercury vapor produces a triad of tremors, neuropsychiatric disturbances and gingivostomatitis.^{1,2}

Chronic ingestion causes:

- i. Constant metallic taste, with signs of gingivitis, glossitis, salivation and loosening of teeth with blue line in the gum.²
- ii. Loss of weight, anorexia, anemia and lymphocytosis, constipation or diarrhea, jaundice, increased urination and restricted field of vision.
- iii. Irritation of skin, sore mouth and throat.
- iv. Chronic inflammation of kidneys and impairment of renal function.
- v. CNS toxicity and impairment of motor speed, memory and coordination.

Characteristic Features

- i. **Intention tremors** (*Danbury tremors/shaking palsy*)
 - It occurs first in the hands, then progresses to the lips and tongue, and finally involves the arms and legs.

- Tremor is moderately coarse and is interspersed by jerky movements. The patient may not display much tremor during an accustomed job, but if he is being observed, he may begin to shake violently.¹
- In the advanced stage, the person is unable to dress himself, write legibly or walk properly. They are also called *hatter's shakes* or *glass blower's shakes*, as they are common in persons working with mercury in glass-blowing and hat industries.³ The most severe form of tremors is known as **concussion mercurialis**.

Other compounds causing tremors:

- Alcohol
- Phosphorus
- Phenothiazines
- Carbon monoxide
- Antidepressants (tricyclic)
- Caffeine and theophylline

- ii. **Mercurial erethism:** Eretism is seen in persons working with mercury in mirror manufacturing firms. This cluster of symptoms was first described by Kussmahl and the term is used to refer to the *neuropsychiatric effects* of mercury toxicity. These include:

- Insomnia
- Depression
- Anxiety
- Amnesia
- Timidity and shyness
- Frequent blushing
- Explosive irritability
- Loss of confidence
- Feeling of embarrassment
- Suicidal melancholia
- Emotional instability, e.g. sudden attacks of anger
- Delusions and hallucinations

- iii. **Mercurialentis:** It is a peculiar eye change due to exposure to mercury vapor.
- It is due to brownish deposit of mercury through the cornea on the anterior lens capsule.
 - Slit-lamp examination gives a malt-brown reflex from the anterior lens capsule.⁴
 - It is bilateral and has no effect on visual acuity.

- iv. **Acrodynia or Pink disease:** It is seen mostly in children due to idiosyncratic hypersensitivity reaction to repeated ingestion or contact with mercury.⁵

Signs and symptoms: There is pain in the extremities, flushing, itching, swelling, tachycardia, hypertension, excessive salivation or perspiration, weakness, irritability, pinkish morbilliform/acral rashes and desquamation of palms and soles.

- v. **Minamata disease** is due to chronic mercury intoxication caused by eating contaminated fish and shellfish.⁶

Symptoms include disturbances in hand coordination, gait and speech, chewing and swallowing difficulties, visual blurring, tremors, rigidity, seizures and clouding of consciousness.

Treatment

- Remove the patient from the source of exposure.
- N-acetyl penicillamine is the chelator of choice.
- Oral hygiene.
- Demulcent drinks.
- Saline purgatives.

Medico-legal Aspects

- Suicidal and homicidal poisoning is rare.
- Accidental poisoning may occur from:
 - Accidental ingestion of antiseptic solutions containing mercuric chloride/cyanide.
 - Soluble salts employed as vaginal douches.
 - Absorption of mercurial preparations applied to the skin.
 - Intravenous administration of organic mercurials, such as diuretics.
 - In children, swallowing the sulphocyanide of mercury tablet, the constituent of *Pharaoh's serpents*.

MULTIPLE CHOICE QUESTIONS

- Following are true regarding chronic mercury poisoning, except:** PGI 05
 - Gingivostomatitis
 - Brownish spot on anterior lens capsule
 - Fine tremor is seen
 - Inappropriate shyness and irritability
- A factory worker presented with tremors, personality change and a blue line in gums. Probable diagnosis is chronic poisoning with:** AI 10
 - Lead
 - Mercury
 - Arsenic
 - Thallium
- Hatter's shakes are seen in:** AIIMS 09; AP 10
 - Lead poisoning
 - Mercury poisoning
 - Arsenic poisoning
 - Copper poisoning
- In mercury poisoning, brown reflex is from:** AP 08
 - Anterior cornea
 - Posterior cornea
 - Anterior lens capsule
 - Posterior lens capsule
- Acrodynia/Pink disease occurs in poisoning with:** AI 07; WB 07; TN 08; Rajasthan 11; Orissa 11
 - Mercury
 - Arsenic
 - Lead
 - Thallium
- Minamata Bay disease refers to chronic toxicity with:** TN 09
 - Ergot
 - Datura
 - Organophosphorus
 - Mercury

Inorganic Metallic Irritants—Lead

40

Lead (*shisha*) is the commonest of heavy metals as far as chronic poisoning is concerned.

Physical properties: Heavy, steel-gray metal. Salts are variously colored. Contrary to many other pure metals, metallic lead is absorbed through GIT, being soluble in gastric juice.

Toxic compounds (Table 40.1)

Action

- i. Lead combines with sulfhydryl groups and interferes with mitochondrial oxidative phosphorylation, ATPases, calcium-dependent messengers and enhances oxidation and cell apoptosis. This causes defective heme synthesis, proximal renal tubular and osteoblast dysfunction.
- ii. In the CNS, it has deleterious effects on the nerve cells and myelin sheaths and also causes cerebral edema.

Absorption and Excretion

- Lead is absorbed through the GIT, respiratory tract (dust and fumes) and skin (lead tetraoxide). In blood, 95-99% of lead is sequestered in RBCs.
- Absorption of lead compounds is directly proportional to solubility and inversely proportional to particle size. GIT lead absorption is increased by iron deficiency and low dietary calcium and decreased by co-ingestion with food.

- It is a cumulative poison. In chronic exposure, it deposits in tissues, mostly in the bones (90%), liver and kidneys.
- It is mainly excreted through the urine (70%), but rate of excretion is low; smaller amounts are eliminated via feces and scant amounts via the hair, nails and sweat.

Signs and Symptoms (Acute Poisoning)

It manifests as GIT or CNS disturbances.

- **GIT:** Metallic taste, dry throat, thirst, vomiting, nausea, burning abdominal pain (colic) and blood-stained diarrhea leading to circulatory collapse.
- **CNS:** Headache, lethargy, arthralgia, myalgia, anorexia, insomnia, paresthesia, depression, coma and death.

Fatal dose

- Lead carbonate: 40 g.
- Lead acetate: 20 g.

Fatal period: 1-2 days.

Laboratory diagnosis

- i. Porphyrinuria due to coproporphyrin III.
- ii. Blood lead level > 70-100 µg/dl. Protoporphyrin > 35 µg/dl.
- iii. Urine lead level > 0.15-0.3 mg/l.

Treatment

- i. Gastric lavage with 1% solution of sodium or magnesium sulphate (forms insoluble lead sulphate), above salts are also given in the purgative dose.
- ii. Demulcents, whole bowel irrigation and repeated cathartics.
- iii. Calcium chloride 5 mg as 10% solution IV or calcium gluconate 10 ml of 10% solution IV causes deposition of lead in bones from blood (to combat acute crisis).
- iv. Edetate calcium disodium (CaNa₂EDTA), 1500 mg/m²/kg/day (50 mg/kg/day) in 4-6 divided doses or as a continuous infusion for 5 days. Some add BAL, 4-5 mg/kg IM every 4 h for 5 days.

Table 40.1: Toxic compounds and its uses

Compounds	Uses
i. Lead acetate (sugar of lead)	Earlier used as an astringent and local sedative for sprains
ii. Lead tetraoxide (red lead or <i>vermillion</i>)	Used as <i>sindoor</i>
iii. Tetraethyl lead	Antiknock for petrol
iv. Lead sulfide (<i>surma</i> ; <i>least toxic</i>) ¹	Applied on the eyes
v. Lead carbonate (white lead)	Manufacture of paints

- v. Vitamin C (weak, but natural chelating agent) may be given.
- vi. Peritoneal or hemodialysis in anuric patients with chronic renal failure.
- vii. Symptomatic treatment.

Postmortem Findings

- i. Body appears emaciated, rigor mortis appears early.
- ii. Stomach wall is swollen, mucous membrane is congested, grayish in color and softened with eroded patches.

Chronic Lead Poisoning (Plumbism/Saturnism)¹

- Lead is a cumulative poison, remains accumulated in bones as phosphate and carbonate.
- High calcium level favors storage, while calcium deficiency causes lead to be released into the blood stream.
- Other factors promoting release of stored lead: Acidosis, fever, sweating, consumption of alcohol and exposure to sunlight.

Causes

- Lead is ingested or inhaled. The most common source is ingestion of lead-containing dust.
- Lead paint dust is the most common source of lead exposure for children.² Children < 3 years are at the

greatest risk for lead poisoning as they are more likely to put things containing lead into their mouths (*pica*—persistent eating of non-nutritive material for 1 month or more) and their brains are rapidly developing.

- Inhalation of lead dust and fumes by makers of white lead, lead paints, plumbers, glass polishers, printers and glass blowers.
- Absorption from drinking water stored in lead cisterns, from tinned food contaminated with lead from solder, use of hair dyes and cosmetics containing lead.
- Percutaneous absorption of tetraethyl lead in persons who handle petrol and gasoline.
- Absorption of *vermilion* applied to scalp.

Chronic lead poisoning results from daily intake of 1-2 mg of lead.

Signs and Symptoms

Chronic poisoning is insidious with fatigue, sleep disturbance, headache, irritability, slurred speech, stupor, ataxia, convulsions, anemia and renal failure (Fig. 40.1). Characteristic features are given below:

1. **Anemia:** In early stages, there may be polycythemia with polychromatophilia, but later there is anemia with karyorrhexis and dyserythropoiesis (*punctate basophilia, reticulocytosis, poikilocytosis, anisocytosis*), nucleated red cells and increase in mononuclear cells. However, polymorphonuclear cells and platelets are decreased. RBC count comes

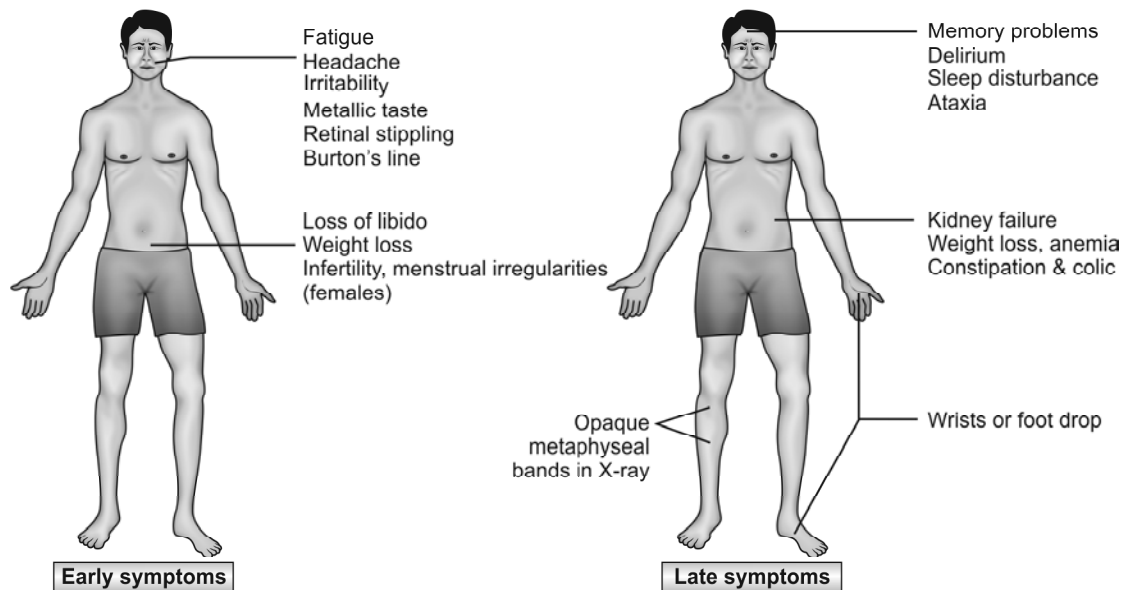

Fig. 40.1: Signs and symptoms of chronic lead poisoning

down to 3.5 million/dl and hemoglobin level to 6.5 g%.

Cause of anemia

- Impairment in heme synthesis from protoporphyrin and of porphobilinogen from δ -amino-levulinic acid.
- Increased fragility of RBCs due to loss of intracellular potassium (there is an increased permeability of cell membrane to K^+).

- Lead inhibits heme synthesis through inhibition of delta ALA-dehydratase utilization and ferrochelatase, resulting in the buildup of aminolevulinic acid, coproporphyrins and free erythrocyte protoporphyrin. It also inhibits enzyme pyrimidine 5'-nucleotidase, thus increasing erythrocyte fragility.³
- *Karyorrhexis*: Rupture of the RBC cell nucleus with chromatin disintegration into granules that are extruded from the cell.
- *Punctate basophilia/basophilic stippling*: Presence of dark blue colored pinhead sized spots in the cytoplasm of the RBCs representing aggregated ribosomes, due to the toxic action of lead on porphyrin metabolism (seen in 25% of patients) (Fig. 40.2).^{4,5}
- *Anisocytosis*: Presence of abnormal size erythrocytes.
- *Poikilocytosis*: Presence of abnormal shaped erythrocytes.

2. **Burton's/Burtonian (lead) line**: A stippled *blue line* is seen on the gingival surface in 50-70% cases.⁶
 - It is due to subepithelial deposit of granules at the junction of teeth, especially near dirty or carious teeth of the upper jaw, within a week of exposure.
 - It is due to formation of lead sulphide by the H_2S formed from decomposed protein in the mouth.
 - A similar blue line may be seen in cases of poisoning by:

• Mercury	• Iron
• Copper	• Silver
• Bismuth	

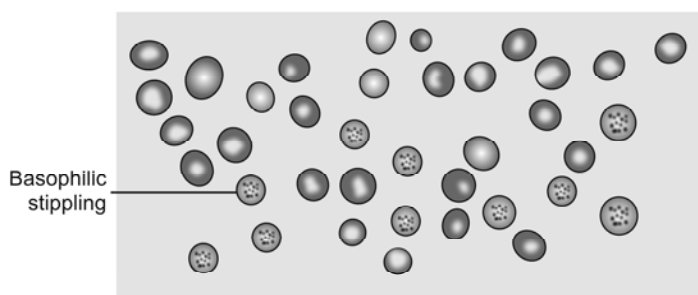

Fig. 40.2: Basophilic stippling of RBCs

3. **Colic**: It is usually a late symptom, involving both large and small intestines, ureters and blood vessels.
 - Seen in 85% of cases.
 - The pain is spasmodic, paroxysmal, occurs at night and may be very severe (*saturnine colic*). During pain, the abdomen is tense.
 - Individual attacks last only for few minutes, but may recur after several days and weeks.
 - Pain is slightly relieved by application of pressure over the abdomen.
4. **Constipation**: Common feature and usually precedes colic.⁷ During pain, there is a desire for defecation. Diarrhea and vomiting may occur.
5. **Lead palsy (Drops)**: It is a late and uncommon phenomenon, seen in < 10% of cases.
 - It is common in adults than in children, and males are particularly affected.
 - It occurs due to degeneration of nerves and atrophy of muscles as a result of interference with phosphocreatine metabolism.
 - The muscle groups affected are those most prone to fatigue.
 - Sensory nerves are not clinically affected.
 - There may be tremors, numbness, hyperaesthesia and cramps before the actual muscle weakness.
 - Later, the extensor muscles of wrist (*wrist drop*) are affected (Fig. 40.3), but the deltoid, biceps, anterior tibial (*foot drop*) and rarely muscles of eye or intrinsic muscles of hand and foot are also affected.
 - Peripheral neuropathy is also seen in thallium, bismuth and arsenic poisoning.
6. **Lead encephalopathy**: Minor degree of involvement of brain function, commonly in children is present in almost every case.
 - This may be due to inactivation of MAO as a result of combination of lead with $-SH$ radical of the enzyme.

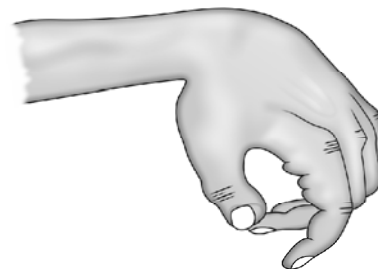

Fig. 40.3: Wrist drop

- *Symptoms* include changes in personality, restlessness, hyperkinetic and aggressive behavior disorders, fatigability, mental dullness, learning disorders, refusal to play, headache, insomnia, vomiting, raised intracranial pressure, papilledema, visual disturbances and irritability. In others, there may be acute conditions, like convulsions, hallucinations, delirium, coma and death.
- 7. **Facial pallor:** *Earliest sign*; seen around the mouth. It is due to vasospasm and produced by contraction of the capillaries at the arterial side.
- 8. **Effects on reproductive system:** Lead may cause sterility in both male and female patients. In males, there may be loss of libido. In females, there may be infertility, menstrual irregularities, such as amenorrhea, dysmenorrhea and menorrhagia. It may result in abortion in pregnant females due to chronic atrophy or spasmodic contraction of uterus.
- 9. **Optic atrophy:** Few patients may develop blindness due to optic atrophy.
- 10. **Retinal stippling** is noticed by ophthalmoscope with presence of grayish glistening lead particles, in the early phase of chronic lead poisoning.
- 11. **Lead osteopathy:** In children and young adults, lead is deposited beyond the epiphysis of growing long bones. The deposition is promoted by calcium and vitamin D and is detectable by radiological examination. Deposition of lead at the growing ends may lead to their abnormal development.
- 12. **Effects on circulatory system:** Lead causes vascular constriction leading to hypertension and arteriolar degeneration.
- 13. **Effect on kidneys:** Atherosclerotic nephritis and interstitial nephritis may occur.
- 14. **Effects on liver:** Acute or chronic degeneration leading to dyspepsia, anorexia, emaciation, general weakness and foul breath.
- 15. **Effect on peripheral nerves:** In addition to meningoencephalitis, it may cause degeneration of anterior horn cells and demyelination leading to peripheral neuritis.
- 16. **Hair:** There may be alopecia.

Diagnosis

- **History.**
- **Clinical features:** Abdominal pain, irritability, lethargy, anorexia, anemia, Fanconi's syndrome, peripheral neuropathy, pyuria and azotemia in children. Neurodevelopmental delays, convulsions and coma may be seen.
- In adults, additionally there are headaches, arthralgias, myalgias, depression, impaired short term memory, and loss of libido. The blue line on the gums is a valuable but variable clue to diagnosis.
- **Laboratory tests**
 - i. Microcytic, hypochromic anemia.
 - ii. Punctate basophilia: > 200 cells/cu mm.
 - iii. Elevated free erythrocyte protoporphyrin or zinc protoporphyrin (> 35 µg/dl) level and azotemia.
 - iv. Urine lead level > 80 µg/dl (in 24 h sample).
 - v. Whole blood lead level is the most useful indicator of lead exposure. Blood lead > 70 µg/dl (severe toxicity) and > 50-70 µg/dl (moderate toxicity). In children, > 10 µg/dl of lead in the blood is abnormal.
 - vi. Coproporphyrin in urine > 150/mg/l.
 - vii. δ-amino levulinic acid in urine > 5 mg/l.⁸
 - viii. Plasma lead > 0.1 mg/ml.
 - ix. *X-ray:* Radio-opaque bands or '*lead lines*' at the metaphyseal plate of long bones are seen in children. These growth arrest lines are not pathognomonic, but are associated with lead levels > 40 µg/dl over long period of time. With recovery, the lead line becomes broader and less dense and may eventually disappear.
 - x. Opaque material may be seen in X-ray of stomach and intestines.

Treatment

- i. Remove the patient from the source of exposure.
- ii. Potassium or sodium iodide 1-2 g TDS orally.
- iii. Sodium bicarbonate 20-30 g in four or five divided doses orally.
- iv. MgSO₄ or sodium sulphate 8-12 g orally.
- v. CaNa₂EDTA in usual doses.
- vi. *BAL:* Chelator of choice in case of renal impairment. Succimer (DMSA) is given in mild to moderate toxicity in a dose of 10 mg/kg orally every 8 h for 5 days, then every 12 h for 2 weeks.
- vii. Correction of dietary deficiencies in iron, calcium, magnesium and zinc lowers lead absorption. Vitamin C may be added (natural chelating agent).
- viii. Ammonium chloride 1 g, 3-4 times given daily. By this, lead deposited in the bones is mobilized into the blood and excreted.
- ix. Symptomatic treatment.

Postmortem Findings

- i. A blue line may be seen on the gums, but it is not a constant feature.
- ii. Paralyzed muscles show fatty degeneration.
- iii. *Heart*: It may be hypertrophied and there may be atherosclerosis of aorta.
- iv. *Stomach and intestines*: It may show ulcerative or hemorrhagic changes with contraction and thickening.
- v. *Liver and kidneys*: Contracted and hard.
- vi. *Brain*: Pale and swollen.
- vii. *On histology*, bone marrow shows hyperplasia of leucoblasts and erythroblasts ('immature' white and red blood cells).

Medico-legal Aspects

- Acute and homicidal poisoning is rare.
- Chronic poisoning is common. There is a risk of failure to recognize the possibility of lead poisoning as the symptoms and signs are subtle and easily overlooked.
- Accidental chronic poisoning occurs in people working with lead.
- Lead oleate or red lead is used as a local application for abortion. It is also used alone or mixed with arsenic as cattle poison.
- A person can develop lead poisoning from retained lead bullets or projectiles.
- Spinal tap performed on the patients with lead encephalopathy and increased intracranial pressure can precipitate cerebral herniation and death.

Mnemonics for signs and symptoms of chronic lead poisoning

- i. **A**nemia/**A**norexia/**A**rthralgia/**A**bortion/**A**trophy of optic nerve
- ii. **B**asophilic stippling/**B**urtonian line
- iii. **C**olic/**C**onstipation/**C**oproporphyrin excess in urine/**C**erebral edema
- iv. **D**rop (wrist, foot)
- v. **E**ncephalopathy/**E**maciation
- vi. **F**acial pallor/**F**oul smell of breath/**F**ailure of kidneys/**F**anconi syndrome
- vii. **G**onadal dysfunction/**G**out-like picture
- viii. **H**ypertension/**H**eadache/**H**allucination/**H**yperaesthesia
- ix. **I**mpotence/**I**nfertility/**I**nsomnia/**I**rritability

- In 1968, a group of European experts recommended that the following criteria should be used as border values for 'safe exposure': blood lead—80 µg/dl (30 in some countries), urinary lead—150 µg/l, urinary coproporphyrin—500 µg/l, and urinary ALA—20 mg/l.
- The 1st, 2nd, 3rd and 6th hazards on the list in Toxic Substances and Diseases Registry of US are heavy metals: lead, mercury, arsenic and cadmium.
- New methods for measuring lead in biological media were developed in the late 1960s. First, the dithizone method and later atomic absorption spectrophotometry.
- **L-line-X-ray fluorescence (LXRF)** is being used to make in vivo measurements of lead levels in cortical bone which reflect cumulative exposure over many years in contrast to blood levels, which reflect recent exposure.

MULTIPLE CHOICE QUESTIONS

1. **Plumbism is due to chronic poisoning with:** *PGI 09*
 A. Arsenic B. Lead
 C. Mercury D. Copper
2. **Commonest source of lead to cause increased blood level in children is from:** *CMC (Vellore) 07*
 A. Air B. Lead paint dust
 C. Water D. Fruits
3. **Lead inhibits which enzymes in the heme synthesis pathway:** *CMC (Vellore) 07*
 A. Aminolevulinatase synthase
 B. Ferrochelatase and δ-ALA dehydratase
 C. Porphobilinogen deaminase
 D. Uroporphyrinogen decarboxylase
4. **Basophilic stippling is seen which of the following cells:** *Manipal 03; UPSC 11; UP 11*
 A. Neutrophils B. RBC's
 C. Basophils D. Eosinophils
5. **Punctate basophilia is seen in poisoning with:** *AIIMS 03; TN 06*
 A. Lead B. Mercury
 C. Cadmium D. Potassium
6. **Burton's line is seen in:** *AI 07; Rajasthan 11*
 A. Lead poisoning B. Arsenic poisoning
 C. Phosphorus poisoning D. Zinc poisoning
7. **All are features of lead poisoning, except:** *PGI 03*
 A. Diarrhea B. Abdominal pain
 C. Encephalopathy D. Nephropathy
8. **In case of chronic lead poisoning, the levels of which of the following is elevated:** *NIMHANS 11*
 A. Porphobilinogen
 B. δ-amino levulinic acid
 C. Bilirubin
 D. Urobilinogen

1. B

2. B

3. B

4. B

5. A

6. A

7. A

8. B

Inorganic Metallic Irritants—Copper

41

Copper (*tamba*) as a metal is not poisonous. The human body copper content is about 100-150 mg which is present as an integral and functional moiety of proteins and enzyme systems including catalase, cytochrome C oxidase, dopamine β -hydroxylase and serum ceruloplasmin. However, as the body cannot synthesize copper, the human diet must supply regular amounts for absorption.

Toxic Compounds and its Uses

- i. **Copper sulphate** (Blue vitriol, bluestone, *nila tutia*, CuSO_4): It occurs as large blue crystals, freely soluble in water and having a styptic taste. It is used as algicide, molluscicide and plant fungicide, as mordant in electroplating, as an agent for leather tanning and hide preservation and can be used as an emetic.
- ii. **Copper subacetate** (*verdigris*): It occurs as a powder or as bluish-green masses and is frequently used in the field of arts and external medicine.
- iii. **Copper carbonate** is a blue-green compound forming part of the verdigris patina that is found on weathered brass, bronze and copper. It is used as fungicide.

Action

Toxicity of copper is exerted on enzymes whose activities depend on sulfhydryl and amino groups because it has high affinity for ligands containing nitrogen and sulfur donors (as in other heavy metals). Besides, nucleic acid may also be targets of copper toxicity.

Absorption and Excretion

- The principal route of exposure is through ingestion, but inhalation of copper dust and fumes occurs in industrial settings and in miners.
- After ingestion, maximum absorption of copper occurs in the stomach and jejunum. Absorbed copper is initially bound to albumin and is transported from the GIT to the liver where it is transferred to ceruloplasmin.

- Copper is eliminated mostly through the feces after excretion into the bile. Urinary excretion of copper is low in humans. Adults have urinary excretion of 25 $\mu\text{g}/24 \text{ h}$.

Signs and Symptoms (Acute Poisoning)

Acute ingestion: Symptoms appear in 15-30 min after swallowing.

System	Signs and symptoms
GIT	Metallic taste, ptyalism (increased salivation), burning pain in stomach, thirst, colicky abdominal pain, nausea, eructation and repeated vomiting. Vomited matter is blue or green. Diarrhea with much straining. Motions are liquid brown, rarely bloody.
Renal	Oliguria, hematuria, hemoglobinuria, albuminuria and uremia ¹ .
Hepatic	Jaundice is common in severe cases.
MS	Cramps or spasms of legs, paralysis of limbs.
CVS	Breathing difficulty, cold perspiration, hypotension and symptoms of circulatory collapse.
CNS	Frontal headache, drowsiness, insensibility, irreversible coma and death occurs.

- Hemolysis and hemoglobinuria are present in severe cases. Individuals with G-6-phosphate deficiency may be at increased risk of hematologic effects of copper.
- Multi-organ dysfunction syndrome may occur and death due to hepatic or renal failure or both occurs after a few days.

Acute inhalation of large doses of copper dusts or fumes can cause:

- Upper respiratory tract irritation resulting in sore throat and cough.
- Conjunctivitis, palpebral edema and sinus irritation may occur.
- Nasal mucous membrane may show atrophy with perforation.

Exposure of skin to copper compounds may cause irritant contact dermatitis and severe exposure may cause a greenish-blue discoloration of skin.

Fatal dose

- Copper subacetate: 15 g.
- Copper sulphate: 20 g (0.15-0.3 g/kg).

Fatal period: 18-24 h, but it may extend to 1-3 days.

Treatment

- No need to use emetics as vomiting occurs in 5-10 min after ingestion.
- Gastric lavage with 1% potassium ferrocyanide which acts as antidote by forming cupric ferrocyanide (insoluble).
- Demulcents: Egg white or milk (form insoluble albuminate of copper).
- Castor oil is given to remove poison from the intestines.
- D-penicillamine given in usual doses is very effective.
- EDTA or BAL in usual doses.²
- Allay pain by injecting morphine and use diuretics, if urine is suppressed.
- Symptomatic treatment to maintain electrolyte and fluid balance.
- For severe cases associated with anorexia and hematuria, cortisone 50-100 mg IM thrice daily is recommended.

Postmortem Findings

- Skin may be yellow due to jaundice.
- Greenish-blue froth from the mouth and nostrils.
- Mucous membrane of the mouth and tongue may have bluish or greenish-blue tinge.
- Internally, some discoloration is present in the mucous membrane of the esophagus and stomach.
- Stomach:* Gastric mucosa is congested with desquamation and hemorrhage at places.
- Small intestine:* Mucosa (upper part) shows signs of moderate irritation.
- Liver:* Soft and fatty. It shows centrilobular necrosis and biliary stasis.
- Kidneys:* It may show degenerative changes in proximal tubules. Hemoglobin casts may be seen.

Chronic Copper Poisoning

Cause: It occurs among workers using copper and its salts due to inhalation of copper dust or fumes—welders may develop *metal fume fever*. It may also occur from food being contaminated with verdigris from dirty copper vessels.

Signs and Symptoms

- Green or purple line on the gums, a constant metallic taste, nausea, dyspepsia, vomiting and diarrhea with colicky pain.
- Giddiness and headache.
- Laryngitis and bronchitis.
- Renal damage.
- General signs of progressive emaciation, viz. anemia, malaise and debility.
- Peripheral neuritis with wrist drop or foot drop and atrophy of muscles.
- Copper dust may cause inflammation of the conjunctiva and ulceration of the cornea.
- Skin becomes jaundiced. Urine and perspiration become green.
- Bronzed diabetes may be present.

Treatment

- After removing the cause, patient should be given a massage and a warm bath. Patient should be exposed to fresh air.
- Attention should be paid to his diet and dyspepsia.
- Symptomatic treatment.

Postmortem Findings

- Liver: Fatty degeneration.
- Kidneys: Degeneration of the epithelial cells.

Medico-legal Aspects

- Suicidal cases are common.
- Accidental poisoning results from eating food contaminated with verdigris (formed from action of vegetable acids on copper cooking vessels).
- Toxicity may develop from the copper absorbed systemically from the wire used in certain intra-uterine contraceptive devices or from the tubing used in hemodialysis equipment.
- Rarely, it is used for homicide because of its color and taste.
- Poisoning may be caused by ingestion of food to which copper has been added to keep the color of vegetables green.
- Children may swallow copper sulphate crystals attracted by its color.
- Rarely, it is used as cattle poison.
- Copper occurs in small medicinal doses in tablets with sulphate of iron and manganese.
- Copper sulphate was used as an antidote in phosphorus poisoning and in wound debridement.

- Tetrathiomolybdate is suggested to be useful as chelating agent in case of acute copper poisoning as urinary excretion is enhanced by increased molybdenum intake.
- **Chalcosis oculi** (Greek *chalkos: copper*): Chronic ophthalmic exposure to particulate elemental copper or one of its alloys may result in its deposition in the cornea, lens, vitreous and retina. Copper deposits in the cornea (*chalcosis corneae*) appear as golden brown, ruby red or green pigment ring in the peripheral Descemet's membrane (Kayser-Fleischer ring). Lens opacities (*chalcosis lentis*) occur in the form of anterior subcapsular cataract ('sunflower' cataract and typically greenish in color).

- **Vineyard sprayer's lung**: It is an occupational disease seen in Portuguese vineyard workers due to chronic exposure to Bordeaux solution (1-2% copper sulfate solution neutralized with lime). The patients develop interstitial pulmonary fibrosis and histiocytic granulomas containing copper. The radiographic picture resembles that of silicosis with micronodular disease in the early stages and progressive massive fibrosis in later stages. Besides Bordeaux mixture, paraquat and organophosphates can cause significant pulmonary fibrosis.

MULTIPLE CHOICE QUESTIONS

1. Copper sulphate poisoning manifests with:

COMEDK 08

- A. Acute hemolysis
- B. High anion gap acidosis
- C. Peripheral neuropathy
- D. Rhabdomyolysis

2. Instead of penicillamine, following can be used in copper poisoning:

DNB 08; FMGE 09

- A. EDTA
- B. Desferrioxamine
- C. Succimer
- D. KMnO_4

Inorganic Metallic Irritants—Thallium

42

Physical properties: Thallium is a soft, heavy metal having a tin-white lustrous color which tarnishes on exposure to air due to formation of thallic oxide.

Toxic Compounds and its Uses

- i. **Thallium acetate:** Colorless and almost tasteless. It was used as a depilatory in the treatment of ringworm of scalp, for removing the superfluous hair, as constituent of some proprietary depilatory creams, in fireworks and as a rodenticide and insecticide.
- ii. **Thallium sulphate** is used for killing rats and ants.

Absorption and Excretion

- Thallium is absorbed through the skin and mucous membrane of the GIT and respiratory tract. It is a cumulative poison and is deposited in the epididymis, liver, kidneys, muscles and bones.
- Excretion is through the kidneys and it is also excreted through the milk.

Signs and Symptoms

In **acute poisoning**, signs and symptoms start between 12-36 h to 12 days.

System	Signs and symptoms (Acute poisoning)
GIT	Irritation, metallic taste in mouth, nausea, vomiting, hematemesis, abdominal pain, anorexia, dryness of mouth, colic, diarrhea or constipation.
RS	Distress, running nose.
Ocular	Conjunctivitis, scotoma, blindness.
MS	Polyneuritis, tingling and pain sensation in hands and feet, muscular weakness with paralysis of some muscles (peripheral neuropathy), tremors.
CNS	Confusion, insomnia, psychosis, ataxia, organic brain syndrome, coma.
Others	Loss of scalp hair, eyebrows, body and axillary hair, and deafness.

In **mild cases**, the symptoms are joint pains in the legs and feet, loss of appetite, stomatitis, drowsiness, and hypochlorhydria. These generally pass off in few days.

In severe cases

- In *sub-acute cases*, there is encephalopathy with white stripes across the nails (Mees lines).
- In *chronic exposure*, these symptoms appear in milder forms. The diagnosis may be difficult because it is often unsuspected. The cardinal features are gastroenteritis, peripheral neuropathy and alopecia.
 - A symmetrical mixed peripheral neuropathy is characteristic with distal nerves more strongly affected than proximal nerves.
 - There may be extreme sensitivity of the legs, followed by 'burning feet' syndrome and paresthesia.
- In *fatal cases*, death is preceded by delirium, convulsions and coma.

Fatal dose

- **Adults:** 200 mg-1 g (> 8 mg/kg).
- **Children:** 8 mg/kg body wt.

Fatal period: Variable, usually 24-36 h.

Laboratory Investigations

- Eosinophilia is a common phenomenon.
- Thallium > 40 µg% in blood, and > 150 µg/l in urine is significant.
- Urine may be green.

Diagnosis

- GIT and polyneuritic symptoms together with the falling of hair from head, eyebrows and axilla should lead to suspicion of thallium poisoning.
- A brownish black pigmentation close to the hair root is characteristic of thallium exposure and may appear as early as 3rd-4th day.
- Opacity in the liver on X-rays has been reported.

Treatment

- i. Patient should be kept warm.
- ii. Emesis is indicated within 4-6 h of ingestion.
- iii. Multiple-dose activated charcoal may be given, followed by saline purgative. Whole bowel irrigation with polyethylene glycol electrolyte lavage solution may be useful.

- iv. Stomach wash is performed with 1% sodium or potassium iodide solution. It forms insoluble iodide salts of thallium. Iodide also acts as a *systemic antidote*.
- v. Prussian blue or Berlin blue (potassium ferric hexacyanoferrate) which acts to sequester the ions in the intestine and preventing their absorption is given in a dose of 250 mg/kg/day in 2-4 divided doses orally.
- vi. Although chelating agents including BAL and EDTA are contraindicated in the treatment, sodium-diethyl-dithio-carbamate 25 mg/kg body wt in 500 ml of 5% glucose given IV once daily may be given.
- vii. Pilocarpine in usual doses is also a *physiological antidote*.
- viii. Potassium chloride promotes renal excretion of thallium. Administration of sodium polystyrene sulphonate as sodium-thallium exchange resin may be helpful.
- ix. Hemodialysis/peritoneal dialysis may be useful within 48 h of ingestion.
- x. Stimulants, dextrose and calcium salts are used according to necessity.
- vii. *Lungs*: Congested with subpleural hemorrhages.
- viii. *Heart*: Fatty degeneration.
- ix. *Brain*: Meningeal vessels may be congested.
 - x. Cells of adrenal cortex, thyroid and hair follicles show vacuolization and degenerative changes.

Medico-legal Aspects

- Poisoning by thallium is rare in contrast to poisoning by lead or mercury, probably due to its infrequent use.
- Thallium was used as an ideal homicidal poisoning in some European countries and Australia, where it was used as rodenticide.
- Accidental intoxication may result from its therapeutic use as a depilatory or from its accidental ingestion when used as a rodenticide.
- Chronic poisoning occurs from industrial exposure.
- Suicidal cases are also seen sometimes.

Postmortem Findings

- i. There is anemia and loss of hair.
- ii. *Stomach*: Mucous membrane may be inflamed and there may be submucous petechial hemorrhages.
- iii. *Spleen*: Congested.
- iv. *Liver*: Congested and shows fatty degeneration.
- v. *Kidneys*: Congested, glomeruli are swollen, convoluted tubules show cloudy swelling and necrosis of the cells.
- vi. *Trachea and bronchi*: Congested.

- In clinical practice, thallium 201 is used as a radioactive tracer in heart scintigraphy to detect myocardial ischemia.
- Accidental poisoning has become rare in the domestic setting since the 1970s, when thallium-based rodenticides were banned in many countries. The majority of reported cases of thallium poisoning in the last two decades have been caused by deliberate poisoning.
- Thallium may be detected in the urine 1 h after ingestion (normal level, < 0.003 $\mu\text{mol/l}$; a level of > 0.98 $\mu\text{mol/l}$ is toxic), but most clinical laboratories may not have the facilities to quantitatively analyze the thallium content.
- A rapid quantitative urine test can be done by mixing urine with 0.4% sodium bismuth in 20% nitric acid and 10% sodium iodide. A red precipitate indicates that thallium is present.
- Microscopic examination of hair after application of 10% sodium hydroxide may reveal dark bands of pigmented material characteristic of presence of thallium.

Cadmium

Cadmium is a soft, white metal, used in welding, metal-plating, battery and plastic industries. Poisoning may occur from the inhalation of cadmium dust or fumes or from the ingestion of a cadmium salt.

Action:

- It binds to sulfhydryl groups, denaturing proteins and/or inactivating enzymes. The mitochondria are severely affected by this process which may result in increase susceptibility to oxidative stress.
- It also interferes with calcium transport mechanisms leading to intracellular hypercalcemia and ultimately apoptosis.

Absorption and Metabolism

- Cadmium (2-7%) is absorbed through the GIT and its absorption is enhanced when the diet is deficient in calcium, iron or protein. Absorption through the respiratory tract is more efficient, ranging from 15-50% of an inhaled dose.
- It binds to RBCs, plasma albumin and metallothionein, which is synthesized in the liver. Cadmium is initially detoxified in the liver through the formation of a metallothionein-cadmium complex which is slowly released from that organ.

Signs and Symptoms

Toxicity by inhalation is far greater than by ingestion.

- **On inhalation:** Symptoms develop usually after 4-8 h. It is characterized by sneezing, sore throat, irritant cough, nausea, excessive salivation, metallic taste, headache and cyanosis ('cadmium blues'). After a latent period of 24-36 h, dyspnea, pleuritic chest pain, tachycardia, oliguria, noncardiogenic pulmonary edema and fever develops.
- **On ingestion:** Symptoms occur in one hour. These are increased salivation, nausea, vomiting, cramps in the abdomen, diarrhea, myalgia, collapse and rarely death.
- **Chronic exposure** causes anosmia, yellowing of teeth, emphysema, bone pain, fractures with osteomalacia

and chronic renal failure (hypercalciuria, proteinuria, azotemia).

Fatal dose: > 100 mg. Symptoms are seen with serum cadmium > 5 ng/dl (normal range 0.2-6.0 ng/ml) and urinary cadmium > 100 nmol/l.

Fatal period: 5-7 days.

Diagnosis: Blood cadmium levels are a reflection of acute cadmium exposure; urine levels appear to provide a better measure of chronic exposure. Urinary beta-2 microglobulin test is an indirect method of measuring cadmium exposure.

Treatment

- i. Avoid further exposure, O₂ and steroids may be given in case of inhalation of fumes.
- ii. Stomach is washed with tannin or egg albumin, and activated charcoal may be given.
- iii. Sodium sulphate as a purgative is given.
- iv. Succimer (10 mg/kg/dose TID) may be given (decreases the GIT absorption and improves survival without increasing cadmium burden in target organs) in case of acute poisoning and dithiocarbamates in chronic poisoning.
- v. Vitamin D is given for osteomalacia.

Postmortem Findings

- i. **GIT:** Mucous membranes of the esophagus, stomach and intestines are congested and inflamed.
- ii. **Lungs:** Pulmonary edema and emphysema. There may be degeneration and/or loss of bronchial and bronchiolar epithelial cells.
- iii. **Heart and liver:** Fatty degeneration.
- iv. **Kidneys:** Nephritic changes.
- v. **Brain:** Congested.

Medico-legal aspects: Poisoning with cadmium is rare, but may occur as an industrial disease.

Cadmium poisoning occurred in 1946 from the contamination of food and water by mining effluents in Japan resulting in outbreak of 'itai-itai' ('ouch-ouch') disease, so named as cadmium-induced bone toxicity led to painful bone fractures.

In chronic exposure, cadmium is bound to intracellular metallothionein, which greatly reduces its toxicity. Any attempt to remove cadmium from these deposits risks redistributing cadmium to other organs, thus exacerbating toxicity, as is known to occur with BAL therapy (exacerbate nephrotoxicity).

Barium

Physical properties: It is a heavy, white, tasteless, odorless powder and insoluble in water. Barium sulfate is used for the X-ray examination of the GIT.

Toxic compounds: Soluble salts are most toxic. These are barium chloride, barium nitrate, barium carbonate (rodenticide) and barium sulphide (used as a depilatory). In Kiating, China, a subacute form of barium poisoning (*pa-ping*) was endemic because of use of contaminated table salt.

Action: It acts locally as an irritant poison. After absorption it acts both on voluntary and involuntary muscles. Barium seems to act as potassium antagonist and calcium agonist.

Absorption

Toxicity of barium compounds depends on their solubility. The free ion is absorbed from the lungs and GIT, but barium sulfate remains unabsorbed. After absorption, it accumulates in the skeleton and in pigmented parts of the eye.

Signs and Symptoms

On ingestion¹

The most characteristic features are areflexia and paralysis (Ba^{2+} ion is a muscle poison).

System	Signs and symptoms
GIT	Nausea, vomiting, abdominal pain, diarrhea.
MS	Tingling sensation, tremors, cramps, stiffness of the muscles, paralysis of the tongue and larynx.
CVS	Hypertension, arrhythmia, ectopic beats, ventricular fibrillation, irregular pulse, cardiac arrest.
CNS	Dilatation of pupils, vertigo.

Inhalation of barium sulfate dust causes a benign pneumoconiosis ('baritosis') with conspicuous radiographic manifestation, but no impairment of pulmonary functions.

Fatal dose: About 1 g of barium chloride/sulphide/nitrate.

Fatal period: Usually within 12 h.

Treatment

- i. Gastric lavage with sodium or magnesium sulphate (5-10 g) solution to precipitate the barium as insoluble sulphate.
- ii. Administration of large amounts of potassium parentally (KCl 20-40 mEq/l) is indicated (causes severe hypokalemia, potassium infusion is an effective antidote).
- iii. 10 ml of 10% sodium sulphate IV every 15 min to convert barium into insoluble sulphate (acute renal failure may develop due to intrarenal precipitation of barium sulfate).
- iv. Purgation with magnesium sulphate and repeated bowel washes.
- v. Removal of barium is hastened with saline diuresis and furosemide (increases renal excretion).
- vi. Sodium nitrite 30-60 mg for hypertension.
- vii. Procainamide 500 mg slow IV for ventricular fibrillation.
- viii. Symptomatic treatment.

Postmortem findings: Non-specific. Submucosal hemorrhages may be seen in the GIT.

Medico-legal Aspects

- Suicidal cases may be seen.
- Homicidal cases are rare.
- Accidental poisoning with barium sulphide may occur, if taken by mistake as barium sulphate for X-ray examination.

Zinc

Zinc is normally present in our body. Poisonous salts are compounds of chloride, phosphide, sulphate (white vitriol), oxide and stearate.

Uses: Zinc chloride is used to clean metals before soldering. Zinc phosphide is used as rodenticide. Zinc stearate is used as a cosmetic (baby powder).

Action: Salts of zinc are locally irritating and after absorption cause metabolic acidosis, hypocalcemia, damage to the liver and kidneys and affects the CNS.

Signs and Symptoms

On *ingestion*, there is a metallic taste, nausea, vomiting, pain in the abdomen and diarrhea. The vomitus and the stool may contain blood. There is ulceration of the mucous membrane of mouth, esophagus and stomach wall with occasional perforation. Collapse due to shock may occur.

- With *zinc phosphide*, in addition to the above features, the vomitus gives the smell of garlic. Dyspnea, pulmonary edema, bradycardia, degenerative changes in the heart, hypocalcemia, metabolic acidosis and convulsions may be seen.
- Inhalation of *zinc oxide* vapor in industries causes chill and fever, a condition known as '**metal fume fever**' or '**zinc shakes**'.²
- Inhalation of *zinc stearate* used in baby powder may cause pneumonitis.

Fatal dose

- Zinc chloride and zinc phosphide: 5 g.
- Zinc sulphate: 15 g.
- Zinc oxide fumes: 500 mg/m³ (recommended exposure limit: 5 mg/m³)

Fatal period: Few hours to few days.

Treatment

- Gastric lavage is done with alkaline solution. Demulcents may be given.
- Sodium bicarbonate with water is given orally.
- Purgatives are given for elimination.
- Symptomatic treatment.

Postmortem Findings

- Non-specific external signs may be seen. Garlicky odor from the mouth and on opening the stomach may be observed in case of zinc phosphide poisoning.
- Signs of irritation of the GIT with degenerative changes in the stomach wall and occasional perforation may be there.
- Degenerative changes in the liver, kidneys and heart may occur.
- Visceral organs are congested.

Medico-legal Aspects

- Suicidal poisoning is seen with the phosphide.
- Accidental cases occur with chronic exposure in industries, acute poisoning may occur with consumption of food stored and cooked in zinc galvanized metal containers.
- Homicidal cases are rare.
- It may be used as an abortifacient.

Metal Fume Fever (MFF)

- MFF is a self-limiting acute febrile illness associated with inhalation of metal oxide fumes. It is also called smelter's shakes, brass chills or Monday morning fever.

- **Signs and symptoms:** This influenza-like syndrome starts 4-8 h after exposure of fumes, which is characterized by headache, fever, chills, cough, dyspnea, cyanosis, myalgia, metallic taste, salivation, sweating and tachycardia. Symptoms subside within 24-36 h, only to return on repeated exposure.³
- **Metals involved:** It is caused by acute exposure to fumes/smoke of oxides of zinc (*commonest*), copper, magnesium, nickel, mercury, lead, iron, chromium, cadmium, cobalt, antimony, tungsten, titanium, manganese and silver.
- A proper occupational history (those involved in welding, melting or flame cutting galvanized metal or in brass foundry operations) should make the diagnosis evident. WBC count may be elevated, chest X-ray is usually normal.
- **Treatment:** Supplemental oxygen, bronchodilators (if there is wheezing) and symptomatic treatment.

Methemoglobinemia Inducing Agents

- A large number of chemical agents are capable of oxidizing ferrous hemoglobin to its ferric state (methemoglobin), a form that cannot carry oxygen and thus inducing a functional anemia. In addition, the shape of oxygen-hemoglobin dissociation curve is altered, aggravating cellular hypoxia.
- Drugs and chemicals known to cause methemoglobinemia include benzocaine, antimalarial agents, dapsone, aniline dyes, nitrites, nitrates, nitrogen oxide gas, nitrobenzene and many others.⁴

Signs and Symptoms

- The severity of symptoms depends on the percentage of hemoglobin oxidized to methemoglobin, severe poisoning is usually present when methemoglobin fractions are > 40-50%.
- Even at low levels (15-20%), victims appear cyanotic (especially of the nails, lips and ears), because of the '*chocolate brown*' color of methemoglobin ('chocolate cyanosis'), but they have normal PO₂ results on arterial blood gas determinations.⁵
- It may cause dizziness, nausea, headache, dyspnea, confusion, seizures and coma.
- Severe metabolic acidosis may be present. Hemolysis may occur, especially in patients susceptible to oxidant stress (i.e. those with G-6-PD deficiency).

Diagnosis is suggested by finding of chocolate brown blood (dry a drop of blood and compare with normal blood).⁵

Treatment

- Administer high-flow oxygen.
- Administer activated charcoal.
- Methylene blue, 1-2 mg/kg (0.1-0.2 ml/kg of 1%

solution) IV enhances the conversion of methemoglobin to hemoglobin by increasing the activity of the enzyme methemoglobin reductase. Dose may be repeated once in 15-20 min, if necessary.

MULTIPLE CHOICE QUESTIONS

- A housewife ingests a rodenticide white powder accidentally. Her examination showed generalized flaccid paralysis and an irregular pulse. ECG shows multiple ventricular ectopics, generalized changes within ST-T. Serum potassium is 2.5 mEq/l. The most likely ingested poison is:** *AIIMS 06*
 - Barium carbonate
 - Superwarfarins
 - Zinc phosphide
 - Aluminum phosphide
- A person presents with acute poisoning, with chills and rigors similar to malaria. Most likely poisoning is with:** *AIIMS 06*
 - Mercury
 - Zinc
 - Red phosphorus
 - Arsenic
- Symptoms of metal fume fever resolve spontaneously within:** *Himachal 10*
 - 6-12 h
 - 12-24 h
 - 24-36 h
 - 36-48 h
- The following drugs cause methemoglobinemia:** *Karnataka 04*
 - Aniline
 - Dapsone
 - Nitrates
 - All
- Patient with BP 90/60 mmHg, lips and peripheries are cyanosed; blood drawn was chocolate color. Diagnosis is:** *DNB 10*
 - Methemoglobinemia
 - Hypovolumic shock
 - Metal fume fever
 - Alphos poisoning

Non-Metallic and Mechanical Irritants

44

Phosphorus

Introduction: Phosphorus (Greek '*phos*': light, '*phorus*': bringing) exists in two varieties:

- i. *White or crystalline:* It is used in fertilizers, insecticides, rodenticides, incendiary bombs, smoke screens and fireworks. It has a garlic smell, luminescent in the dark and insoluble in water. Samples of white phosphorus always contain some red phosphorus and therefore appear yellow (also called 'yellow phosphorus').¹
- ii. *Red or amorphous:* White phosphorus gradually changes to red phosphorus. This transformation is accelerated by light and heat. It is non-luminescent and odorless. It is used on the sides of matchboxes.

Action: It is a protoplasmic poison and affects cellular oxidation. The metabolism of cells reduces, leading to necrobiosis which is predominantly seen in the liver.

Signs and Symptoms (Acute Poisoning)

It has two phases, initially local action on the GIT (within ½-6 h) and later, action of the absorbed poison (after 2-3 days).

First Stage: *Skin contact* produces painful penetrating second and third degree burns.

Ingestion produces burning pain in the throat and abdomen with intense thirst, nausea, vomiting, diarrhea and abdominal pain. Breath, vomitus and feces have garlic-like odor. Luminescent 'smoking' vomit and feces are diagnostic. A symptom-free period lasting for 2-3 days is seen after the acute attack.

Second Stage

System	Signs and symptoms
GIT	Nausea, vomiting, hematemesis, diarrhea.
Hepatic	Tender hepatomegaly, jaundice, pruritus.
Renal	Oliguria, hematuria, casts, albuminuria, sometimes anuria.
CNS	Restlessness, anxiety, insomnia, headache, confusion, hallucinations, convulsions, delirium, coma.

PNS	Paresthesia, carpopedal spasm, tetany, laryngeal stridor, opisthotonus (because of hypocalcemia).
Hematologic	Purpura, epistaxis, hemorrhage in mucous membrane and viscera.

Fulminating poisoning (death within 12 h) may be seen when the patient takes a large dose.

- Early death is due to cardiac dysrhythmias, secondary to electrolyte abnormalities, such as hypocalcemia and hyperkalemia.
- Death after the first 24 h is due to hepatic failure.

Fatal dose: 60-120 mg of white phosphorus.

Fatal period: Within 24 h, but may be delayed by 5-7 days.

Diagnosis: Oral and skin burns, luminescent 'smoking' vomitus and stools with a garlic odor, and GIT and biliary damage characterize yellow phosphorus poisoning.

Treatment

- i. Life support measures—airway support and fluid maintenance should be provided.
- ii. External burns should be washed and covered with antibiotic ointment.
- iii. Gastric lavage using 1:5000 solution of KMnO_4 (*chemical antidote*) oxidizes phosphorus into harmless phosphoric acid and phosphates.
- iv. Activated charcoal is given.
- v. Demulcents (oily or fatty substances) are contraindicated, as phosphorus gets dissolved and gets absorbed.
- vi. Purgatives (magnesium sulphate) may be given.
- vii. Vitamin K 20 mg IV in repeated doses or blood transfusion.
- viii. Transfusion of glucose-saline and plasma with vitamins is useful to protect the liver and to correct shock and dehydration.
- ix. Peritoneal or hemodialysis may be required (for correction of hyperphosphatemia, hyperkalemia and hypocalcemia).
- x. N-acetylcysteine, ubiquinone and sulfate have been tried to prevent liver damage.

- Identifiable phosphorous particles from the skin are removed by thorough debridement and the area covered with saline-soaked gauze to prevent further combustion. Copper sulfate solution is sometimes recommended for conversion of phosphorous particles to blue-black cupric phosphide.²
- Alternatively, application of silver nitrate may prevent ignition of phosphorus by depositing a film of silver over the phosphorous.
- Stomach can also be washed with 0.2% copper sulphate solution. Since, copper sulphate itself can cause acute copper poisoning and inhibit G-6-PD leading to lethal hemolysis, it is not recommended.²
- There is a danger of explosion and fire because of entry of oxygen into the stomach or exit of phosphorous through the nasogastric tube. This is minimized by connecting the external end of the tube to a syringe filled with water; confirmation of placement is done by instilling water rather than air or by withdrawing gastric contents.

Postmortem Findings

External

- i. Emaciation, purpuric hemorrhages in the skin, jaundice, and smell of garlic may be present.³
- ii. Mucous membrane of the mouth is corroded.
- iii. Hypostasis is dark brown in color.³

Internal

- i. Multiple hemorrhages are seen in the muscles, serosal and mucosal membranes of the GIT and respiratory tract, liver, kidneys, endocardium, pericardium, epicardium, peritoneum, lungs and brain.
- ii. *Stomach and intestines*: Mucous membranes are yellowish or grayish-white in color, softened, thickened, inflamed and corroded in patches; luminous material may be found in the stomach. Contents may smell of garlic.
- iii. *Liver*: Swollen, yellow, soft, fatty and easily ruptured.⁴
- iv. *Kidneys*: Enlarged, greasy, yellow.
- v. *Heart*: Flabby, pale and shows fatty degeneration.
- vi. *Lungs*: Fat emboli may be found in the pulmonary arterioles and capillaries.

Medico-legal Aspects

- Accidental poisoning in children due to chewing of fireworks or by eating rat paste may occur.
- It is not preferred for suicide because of painful symptoms and prolonged suffering.
- It may be used for homicide purpose by mixing with alcohol or coffee to mask the taste and smell and administered, since:

- i. Symptoms resemble acute liver disease.
 - ii. There is delay in the appearance of symptoms.
 - iii. The poison is oxidized in the body, hence cannot be detected.
 - iv. Death occurs after few days.
- Sometimes, it is taken by mouth or introduced into the vagina to procure abortion.
 - Cases of poisoning may occur during war when phosphorus enters the body with fragments of hand grenades, smoke screens, bombs or bullets.
 - For arson, white phosphorus covered with dung or wet cloth is thrown on huts. When the covering becomes dry, the roof catches fire.

Chronic Phosphorus Poisoning

- The frequent inhalation of fumes over a period of years causes necrosis of the lower jaw in the region of a decayed tooth.
- Initially, there is toothache which is followed by swelling of the jaw, loosening of the teeth, necrosis of the gums and sequestration of bone in the mandible with multiple sinuses discharging foul-smelling pus. This is known as '**phossy jaw**' (glass jaw) in which osteomyelitis and necrosis of jaw occurs.⁵
- *Constitutional symptoms* include nausea, vomiting, anorexia, pain in the abdomen, indigestion, purging, pain in the joints, weakness, loss of weight, bronchitis, cirrhosis, jaundice, ascitis and anemia.

Mechanical Irritants

Of all the mechanical irritants, glass and diamond powder, and pointed metallic chips may be of real danger in most cases. Others, like pins, needles and hair also acts as mechanical irritants. Hair may cause intestinal obstruction.

Signs and Symptoms

- There may be nausea, vomiting (bloodstained), burning pain in throat and abdomen with constipation.
- The sharp margins or the pointed ends of broken pieces of glass/diamond may cause injury and hemorrhage in the GIT when ingested.
- They do not usually adhere to the wall of the GIT, but rather pass out the whole length of the tract by peristaltic movement, longitudinally in relation to the length of the intestines. However, perforation peritonitis or even serious injury to the intestinal tract may occur.

- If death occurs, it is due to shock as a result of injury and internal hemorrhage.

Treatment

- Bulky foods, like bananas or rice for easy passage of the glass pieces.
- Laxatives may be given.
- Symptomatic treatment.

Postmortem Findings

- There may be inflammation and hemorrhage of the GIT.
- Perforation peritonitis is uncommon.

- Fragments of glass particles may be found adhered to the stomach wall.
- Signs of anemia, intestinal hemorrhage and inflammation are more common.

Medico-legal Aspects

- In ancient period, mechanical irritants have been used as homicidal agents. Women, to kill their husbands, have administered finely powdered glass bangles in food.
- Ingestion is usually accidental from contamination occurring from the broken pieces of the glass containers.
- They may be used to destroy cattle.

MULTIPLE CHOICE QUESTIONS

- A poison which is luminescent and waxy and have a garlic smell:** *AI 11*
 A. Alphas B. Ammonium bromide
 C. Opium D. Yellow phosphorous
- CuSO₄ was used as an antidote for:** *Maharashtra 11*
 A. Dhatura poisoning
 B. Cocaine poisoning
 C. Phosphorus poisoning
 D. Opium poisoning
- A body is brought for autopsy with history of poisoning. On postmortem, there is dark brown postmortem staining and garlic odor in stomach. The poisoning is most likely due to:** *AIIMS 04; BHU10*
 A. Hydrocyanic acid B. Carbon dioxide
 C. Aniline dye D. Phosphorus
- Yellow/fatty liver is characteristically seen in:** *Jharkhand 11*
 A. Dhatura poisoning
 B. Cocaine poisoning
 C. Phosphorus poisoning
 D. Opium poisoning
- 'Phossy jaw' is seen in chronic poisoning with:** *AFMC 11*
 A. Dhatura B. Phosphorus
 C. Arsenic D. Thallium

Ricinus Communis (Castor)

Distribution: It grows all over India, especially in wastelands.

Identification of Seeds

- Seeds are variable, smooth, flattened-oval, mottled with light and dark brown markings, bright and polished.
- They are of 2 sizes, small and big.
- Small seeds are about 1.2×0.8 cm in dimensions and resemble croton seeds.

Active Principle

- The entire plant is poisonous, containing toxalbumin *ricin*, a water-soluble glycoprotein and a powerful allergen.¹ Seeds contain the highest level.
- They are also rich in purgative oil. Castor oil is not poisonous as it does not contain ricin.

Unbroken seeds are not poisonous when swallowed or cooked. Toxicity is caused when castor beans are thoroughly chewed or blenderized, even though the quantity of ricin so produced is small and is poorly absorbed from the GIT.

Toxalbumin or phytotoxin is a toxic protein that disable ribosomes and thereby inhibit protein synthesis, and present in the plants like in castor, croton or rati.

- It is antigenic in nature, agglutinates red cells, causes hemolysis and cell destruction.
- Toxalbumins are similar in structure to the toxins found in cholera, tetanus, diphtheria, pseudomonas and botulinum; and their physiological and toxic properties are similar to those of viperine snake venom.

Action

- Ricin blocks protein synthesis through inhibition of RNA polymerase. It belongs to a group of poisons known as A-B toxins.
- Ricin has a special binding protein that gains access to the endoplasmic reticulum in the GIT mucosal cells causing diarrhea.

Signs and Symptoms

Dust of seeds may cause:

- Watering of eyes and conjunctivitis
- Headache, pharyngitis
- Gastric upset
- Acute nasal inflammation and sneezing
- Asthmatic bronchitis
- Dermatitis

On ingestion (seen within 10 h of ingestion)

- **GIT:** Burning pain in throat, colicky abdominal pain/cramping, nausea, thirst, vomiting and diarrhea (often bloody).
- **CNS:** Vertigo, drowsiness, delirium, convulsions and coma.
- Uremia, jaundice, rapid feeble pulse, cold clammy skin, cramps and dehydration.

Consciousness is retained till death in some cases.

Fatal dose: 1-10 $\mu\text{g}/\text{kg}$ body wt (by inhalation or injection). Oral exposure to ricin is far less toxic and lethal dose is about 2 mg/kg (10-20 seeds).

Fatal period: 3-5 days.

Treatment

No known antidote or other specific treatment, although a vaccine has been developed by the US military.

After suspected ricin *inhalation* or exposure to powdered ricin, remove clothings and wash skin with water.

In case of ingestion:

- i. Gastric lavage.
- ii. Emetics and demulcents.
- iii. Administration of glucose and saline for dehydration.
- iv. 2-5 g of sodium bicarbonate is given 8 hourly by mouth to alkalinize the urine.
- v. Blood transfusion may be needed in some patients.

Postmortem Findings

Deaths caused by ingestion of castor plant seeds are rare, because of its indigestible capsule.

- i. Mucosa of the GIT is congested, softened and inflamed with occasional erosions and submucous hemorrhages.
- ii. Fragments of seeds may be found in the stomach and intestines.

- iii. Dilation of heart, hemorrhages in the pleura, edema and congestion of the liver, kidneys, spleen and lungs may be seen.

Medico-legal Aspects

Accidental poisoning may occur in children; rarely, powdered seeds are given for homicide. The powder of seeds causes conjunctivitis when applied to the eye.

- **Chemical warfare:** The toxin has been linked with terrorist activity among anti-government militia in US and the *Al Qaeda*, and was supposedly used by the Bulgarian secret service in 1978 to assassinate a Bulgarian dissident in what is known as '*The Case of the Umbrella Murder*'.
- Ricin is commonly used as part of immunotoxins for clinical tumor research and application in cancer therapy.

Croton Tiglium (Jamalgota)

Distribution: It grows all over India, and belongs to Euphorbiaceae family. The processed seeds are used in Indian medicine for treating flatulence, dyspepsia, colic, edema, dyspnea and persistent cough.

Identification of Seeds

- Seeds are 1.27 × 0.84 cm in dimensions.
- Oval or oval-oblong and odorless.
- Dark brown or brownish-gray shell.
- Resemble castor seeds, but they are not shiny and not mottled.

Active Principles

All parts are poisonous, but seeds contain the maximum concentration of the active principles. *Crotonin*, a toxalbumin and *crotonoside*, a glycoside are the active principles.

Signs and Symptoms

On ingestion, there is hot burning pain from the mouth to stomach, salivation, nausea, vomiting, purging, vertigo and bloody stools with severe griping pain, followed by prostration, circulatory and respiratory collapse and death. *Applied to the skin*, the oil produces burning, redness and vesication.

Fatal dose: 4 crushed seeds or 3 drops of oil (1.5 ml).

Fatal period: 6 h to 3 days.

Treatment

- i. Stomach wash.
- ii. Administration of demulcent drinks, like milk or egg white.

- iii. Morphine with atropine to allay pain and reduce intestinal secretions.

- iv. Glucose and saline are given IV to combat collapse and dehydration.

Postmortem findings: Same as castor.

Medico-legal Aspects

- Accidental poisoning results from swallowing croton oil by mistake.
- Suicide and homicide is rare.
- Root and oil are taken internally as an abortifacient.
- Oil is used as arrow poison.

Abrus Precatorius (Rati, Gunchi, Jequirity)

Distribution: It is found all over India, and belongs to Leguminosae family. All parts of the plant are poisonous.

Identification of Seeds

- Seeds are egg shaped and scarlet in color with a black spot at one end. White seeds are also found.
- 0.83 × 0.62 cm in dimensions; having a weight of 105 mg.
- Seeds are tasteless and odorless.
- It was used by Indian goldsmiths for weighing silver and gold.

Active Principles

Seeds contain active principles, *abrin*, a thermolabile toxalbumin; *abrine*, an amino acid; *hemagglutinin*, a lipolytic enzyme; and *abralin*, a glycoside.

Signs and Symptoms

- *On ingestion*, there is abdominal pain, nausea, vomiting, bloody diarrhea, weakness, cold perspiration, trembling of hands, weak pulse, rectal bleeding, tachycardia, headache, dilated pupils, hallucinations, drowsiness, tetany and circulatory collapse, seen in 6 h but may be delayed to 1-3 days.
- When extract of seeds is *injected* under the skin, symptoms resemble *viperine snakebite* and as such poisoning is not suspected.² There is inflammation, edema, oozing of hemorrhagic fluid from site of puncture and necrosis may occur. The animal drops down and does not take feed and dies in 3-4 days. Tetanic convulsions occur or the animal becomes cold, drowsy or comatose and dies.
- In man, at the site of injection, painful swelling and ecchymosis develops with inflammation and necrosis of muscle and regional lymph nodes. Faintness, vertigo,

vomiting, anorexia, fever, headache, dyspnea and prostration are seen. Convulsions may occur before death. Weakness may develop within 5 h after injection but onset of symptoms may be delayed by 10-12 h.

Fatal dose: 90-120 mg of abrin injected or 1-2 crushed seeds orally (0.1–1 µg/kg body wt).

Fatal period: 3-5 days.

Treatment

- i. Injection of anti-abrin.
- ii. Needle should be dissected out.
- iii. Hydrochloric-pepsin mixture orally.
- iv. Urine is maintained at an alkaline pH.

Postmortem Findings

- Fragments of needle may be found. Edema at the site of injection.
- Petechial hemorrhages may be seen under the skin, pleura, pericardium and peritoneum.
- *GIT*: Hemorrhages, edema and congestion (commonly affected on ingestion).
- Internal organs are congested and show focal hemorrhages in the intestines, brain, myocardium and pleura (on parenteral exposure).
- Necrosis, hemorrhages and edema are also seen in lymph nodes, kidneys and intestines.

Medico-legal Aspects

- Accidental cases—on account of the attractive color of seeds, children may ingest them.
- Commonly used as cattle poison in Indian villages to get the hide or for taking revenge. The toxic principle is injected into the animal in the form of fine needle-shaped structures called '*suis*'.
- Powdered seeds are used by malingerers to produce conjunctivitis.
- Seeds are also used as abortifacient and as arrow poison.

Suis

The seeds of *Abrus precatorius* are decocted (boiling down to extract an essence; resulting liquid) and mixed with datura, opium and onion, and made into paste with spirit and water, and from this paste, small sharp pointed spikes or needles or '*suis*' are made which are dried in the sun.³

- The needles are 15 mm long and weigh 90-120 mg. Two needles are inserted by their base into holes in

a wooden handle and a blow is struck to the animal with great force which drives the needle into the flesh (so as to resemble snakebite).

- For homicide, two needles are kept between the fingers and the person is slapped which drives the needle into the body.

Semecarpus Anacardium

The fruit of this plant is known as '*marking nut*' or '*bhilawa*' as its juice is used by washerman/laundries to inscribe identification number on the clothes.⁴

Identification of Seeds

Seeds are black, cone or heart-shaped with a rough projection at the base. They have a thick, pericarp containing the irritant juice which is brownish, oily and acrid, but turns black on exposure to air.

Active Principles

Semecarpol and bhilawanol.

Signs and Symptoms

When the juice is *applied to the skin*, it causes irritation, itching and a painful blister containing acrid serum and eczematous eruptions of the surrounding skin. The lesion resembles a bruise. Later on, an ulcer may be produced with sloughing.

Constitutional symptoms such as fever, painful micturition with brown color urine may be seen.

Orally, if a large dose of juice is taken, blisters in mouth and throat, severe *GIT* irritation, dyspnea, tachycardia, hypotension, cyanosis, loss of reflexes, delirium, coma and death may result.

Fatal dose: 5-10 g.

Fatal period: 12-24 h.

Treatment: Wash the contaminated part of the skin with soap and water. Bland liniments are applied. Demulcents drinks and symptomatic treatment are given.

Postmortem Findings

- Bruise-like lesion with small blisters may be seen near the angle of the mouth or lips. Blisters are also seen in the mouth and throat.
- *Stomach*: Congested and inflamed.
- *Liver*: It may show degenerative changes.
- *Other organs*: Congested.

Medico-legal Aspects

- Accidental poisoning may result from the administration of juice by quacks for treatment of rheumatic pain and worm infestation.

- Juice may be introduced into the vagina, as a punishment for infidelity.
- For criminal abortion, juice is applied to the cervical os by means of abortion stick.
- It may be used by malingerers to produce conjunctivitis or to support a false charge of assault; lesions produced *simulate bruises* (Diff. 45.1).
- The juice may be thrown on the face to cause injury.
- Homicidal and suicidal poisoning is rare.

Capsicum Annum

Capsicum or chilly fruits are universally employed as a condiment, the powdered form being known as red pepper or *lal mirch*. It has a pungent smell and a burning irritating taste. The seeds, about 0.3 cm long and wide, resemble *dhatura seeds*.

Active Principles

Capsaicin and capsinin which are exceedingly acrid, volatile, non-alkaloidal and non-fatal substances.

Signs and Symptoms

- When it is *applied to the skin*, it causes irritation and vesication.
- When *thrown into the eyes*, it causes lacrimation, burning pain and redness.
- On *ingestion* in large quantity, it acts as an irritant poison and causes burning sensation in the mouth, throat, esophagus and stomach.

Treatment

- When applied to the skin, it should be washed out with water and treated symptomatically.
- When ingested, the tongue should be scraped by a blunt edged instrument and ice given to suck.
- When thrown into the eyes, they should be washed in saline and antibiotics applied. Corticosteroid drops may be helpful.

Medico-legal Aspects

- It may be thrown into the eyes to facilitate robbery.
- The powder is used as a means of torture to extort money or a confession of some guilt by introducing it into the eyes, urethra, vagina or rectum, burning it under the nose or rubbing it on the female breasts.
- Superstitious people use the fumes from burning chillis to scare away devils and ghosts.

Calotropis ('Rubber bush')

Distribution: Calotropis plant grows wild almost everywhere in India. There are two varieties—*Calotropis gigantea* (*akdo, akand*) with purple flowers and *Calotropis procera* (*madar*) with white flowers.

Active Principles

Uscharin, calotoxin, calactin, gigantol and calotropin.

Signs and Symptoms

- When the juice is *applied on the skin*, it becomes red with formation of blisters which excoriate later.

Differentiation 45.1: Artificial and true bruise

S.No.	Feature	Artificial bruise	True bruise
1.	Cause	Juice of marking nut, <i>Calotropis</i> or <i>Plumbago rosea</i>	Trauma
2.	Color	Dark brown	Typical color changes
3.	Shape	Irregular	Round
4.	Site	Exposed accessible parts	Anywhere
5.	Margins	Well-defined and regular, covered with small vesicles	Not well-defined, diffuse and irregular, no vesicles
6.	Redness and inflammation	Seen in surrounding skin	Seen at the site
7.	Itching	Present	Absent
8.	Vesicles	May be found on fingertips due to scratching	Negative
9.	Contents	Acrid serum	Extravasated blood
10.	Chemical tests	Positive for the chemical	Negative

- When *instilled into the eyes*, it produces conjunctivitis which may result in permanent impairment of vision.
- When *ingested*, it acts as a GIT and cerebrospinal poison. There is an acrid bitter taste, burning pain in the mouth, throat and abdomen along with nausea, vomiting and diarrhea. Pupils are dilated, and there may be tetanic convulsions. Circulatory collapse and death may occur.

Fatal dose: Uncertain.

Fatal period: About 12 h.

Treatment: The patient is treated symptomatically; gastric lavage is done with warm water, demulcents and morphine to relieve pain.

Postmortem Findings

Findings are non-specific.

- Dilated pupils and froth from the nostrils may be seen.
- Stomatitis, acute inflammation of the GIT with ulcerated patches/perforation in the stomach may be present.
- Viscera and the brain are congested.

Medico-legal Aspects

- All the parts of the plant are used in Indian medicine, the flowers as digestive stimulants, the powdered root as emetic and the milky juice as a vesicant, depilatory and for treatment of chronic skin conditions—all may lead to poisoning.
- Juice may be taken orally or applied on an abortion stick to procure abortion.
- It may be mixed with milk for infanticide, rarely for suicide or homicide.
- It may be used as cattle poison by mixing with fodder or inserting a cloth smeared with the juice inside the rectum of the animal.
- Sometimes, it is used to produce an artificial bruise.
- It may be used as arrow poison.
- The roots of *Calotropis procera* are highly poisonous to cobras and other poisonous snakes and hence used by snake charmers to control them.

Ergot

Ergot is the dried sclerotium of the fungus *Claviceps purpurea* which grows on stale grains, particularly rye, barley, maize and wheat.

Active Principles

Several alkaloids are present, important ones are ergotoxin, ergotamine and ergometrine. It also contains some amount of histamine, tyramine and acetylcholine.

Action: Ergot is primarily a vasoconstricting agent. It stimulates the smooth muscles of arterioles, intestines and uterus.

Signs and Symptoms

Acute poisoning

System	Signs and symptoms
GIT	Nausea, vomiting, diarrhea.
RS	Respiratory distress, feeling of tightness in the chest.
MS	Tingling and numbness of hands and feet, paraesthesias, cramps in muscles.
Others	Dizziness, dimness of vision, feeling of coldness, hypertension, dilated pupils, bleeding from nose, unconsciousness.

Fatal dose: 1-2 g.

Fatal period: Few days.

Chronic poisoning (ergotism) may either be convulsive or gangrenous in type.

- In *convulsive type*, there is twitching, tingling, numbness and pain in the muscles. There may be headache, drowsiness, giddiness, formication and convulsions.
- In *gangrenous type*, which resembles Raynaud's disease, there is a burning pain (called *St. Anthony's fire*) in the limbs with alternating heat and cold sense, numbness and tingling or anesthesia. In fingers, toes, ears, nose, hands and feet, there may be dry gangrene without swelling and ulceration.

Treatment

- Stomach wash is done. Activated charcoal is given.
- Emesis (ipecac syrup) and purgation are also useful.
- Nitroprusside or nitroglycerin for vasospasm.
- Prazocin, captopril, nifedipine and cyproheptidine for limb ischemia.
- Vitamin A is useful in convulsive variety.
- Phenobarbital or diazepam may be given to sedate the patient.

Postmortem Findings

Non-specific. Internal organs are congested.

- In *convulsive type*, degenerative changes may be seen in the posterior column of the spinal cord.

- In *gangrenous type*, there is degeneration of the intima of the arterioles with thrombus formation. Gangrenous change may be present in some parts of the body.

Medico-legal Aspects

- Poisoning is mostly accidental. It may occur due to consumption of bread prepared with affected

rye or grain. This may cause mass poisoning in an area.

- Ergot is used as an abortifacient. Systemic poisoning may occur.
- Chronic poisoning used to occur when ergot preparation was used in the treatment of migraine or prolonged uterine hemorrhage.

MULTIPLE CHOICE QUESTIONS

1. Ricin is obtained from: *Manipal 06*

- A. Marking nut B. Poppy seed
C. Castor seed D. Croton seed

2. A toxalbumin similar to viperine snake venom is present in the seeds of:

TN 06; UP 08; Manipal 09

- A. Abrus precatorius B. Dhatura
C. Ergot D. Croton tiglium

3. 'Sui' needle used to kill animals are made of:

PGI 06

- A. Dhatura seeds B. Rati seeds
C. Lead peroxide D. Arsenic

4. Toxic substance commonly used by washermen to put marks on clothes:

Delhi 06

- A. Calotropis procera B. Plumbago rosea
C. Semecarpus anacardium D. Croton tiglium

Snakes

Nomenclature

Phylum	Chordata
Class	Reptilia
Order	Squamata
Suborder	Serpentes

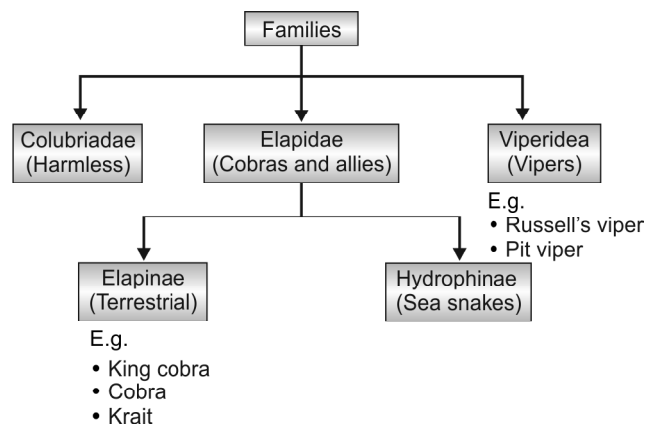

Classification of Snakes (Diff. 46.1)

Snakes are classified into two types:

- Poisonous snakes**, e.g. King cobra (*Ophiophagus hannah*), common cobra (*Naja naja*), Russell's viper (*Daboia russelii*) (Diff. 46.2), saw-scaled viper (*Echis carinatae*), pit viper and krait (*Bungarus caeruleus*).¹
- Non-poisonous snakes**, e.g. rat snake, vine snake, sand boa and mud snake.

Features of Common Poisonous Snakes

Some features of common poisonous snakes are given in Table 46.1.

Poison apparatus: It is a *modified salivary gland* consisting of:

- Gland:** Lies just below and behind the eyes, one on each side of the head, above the upper jaw.
- Duct:** Arises from the gland to carry the poisonous venom from gland to the fangs.
- Fangs:** Two in number. There are curved teeth situated on the maxillary bones and lie along the jaws. They

Differentiation 46.1: Poisonous and non-poisonous snakes

S.No.	Feature	Poisonous snakes	Non-poisonous snakes
1.	Head scales (Fig. 46.1)	Small (vipers). Large scales are seen with: <ul style="list-style-type: none"> • Heat-sensing pit anteroinferior to the eye (pit viper) (Fig. 46.2) • 3rd labial touches eye and nasal shields (cobra) (Fig. 46.3) • Central row of scales on back enlarged; under surface of mouth has only four infralabials, 4th being largest (kraits) (Fig. 46.4) 	Large with exception as mentioned under the poisonous snakes
2.	Belly scales ² (Fig. 46.5)	Large and cover the entire breadth of belly	Small, like those on back and do not cover the entire breadth
3.	Fangs	Long and canalized, like hypodermic needle	Short and solid
4.	Scales distal to anal plate (Fig. 46.6)	Single row	Double row
5.	Tail	Compressed	Not markedly compressed
6.	Habits	Nocturnal	Not so
7.	Bite marks	Two fang marks, with or without small marks of other teeth.	Number of small teeth marks in a row

Differentiation 46.2: Cobra and viper (Figs 46.2 and 46.3)

S.No.	Feature	Cobra	Viper
1.	Head	Small, covered by large scales or shields	Large, broader than the body, triangular, covered by small scales
2.	Body	Long and cylindrical	Short with narrow neck
3.	Pupils	Circular/round	Vertical, slit like
4.	Maxillary bone	Carries poison fangs and other teeth	Carries only poison fangs
5.	Fangs	Grooved, short and fine	Canalized and long
6.	Venom	Neurotoxic	Hemotoxic
7.	Tail	Less tapering (round)	Tapering
8.	Other teeth	Present in upper jaw	Absent
9.	Reproduction	Oviparous (by laying eggs which hatches)	Viviparous (gives birth to young ones)

Table 46.1: Features of common poisonous snakes

Features	Common cobra	King cobra	Common krait	Banded krait	Russell's viper
Head and neck	Hood present, bears a double/single spectacle mark	Hooded without spectacle mark	Head covered with large shields	Head covered with large shields	Flat, triangular with distinct 'V' mark and small scales
Belly	Smooth scales	Scales looks shiny, but is dry to touch	Creamy white	Triangular in cross-section	White with broad plates
Back	Spectacled white or yellow pattern, which sometimes forms ragged bands	Yellow or black bands or broad chevron like markings	Single/double white bands with central row of hexagonal scales	Alternate black and yellowish bands	Three rows of diamond-shaped black/brown spots
Color	Brown/black/green	Yellow/green/brown/black with white cross-bands	Steel-blue/black	Resembles common krait	Brown/buff
Length	1.5-2 meters	3-4 meters	1.25-1.5 meters	2 meters	1.5 meters
Habitat	Throughout India	Thick jungles/forests	Close to human dwelling	Assam, Bengal, South India	Throughout India

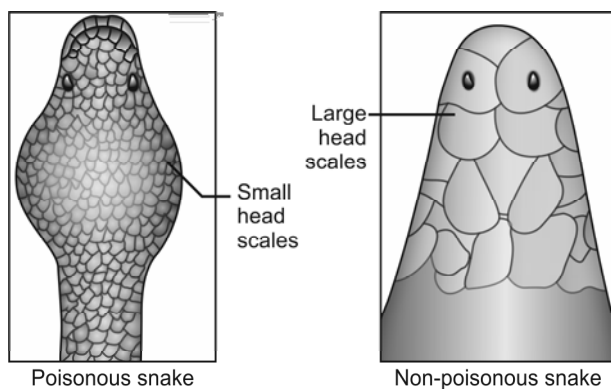
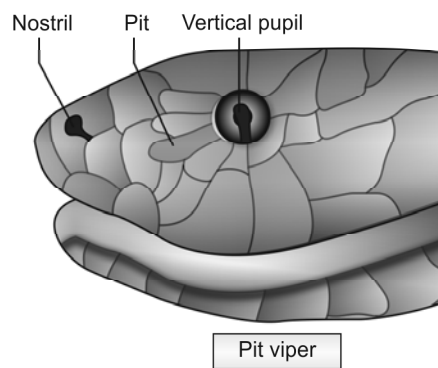
**Fig. 46.1:** Head scales of poisonous and non-poisonous snakes**Fig. 46.2:** Large head scales with a pit between the eye and nostril

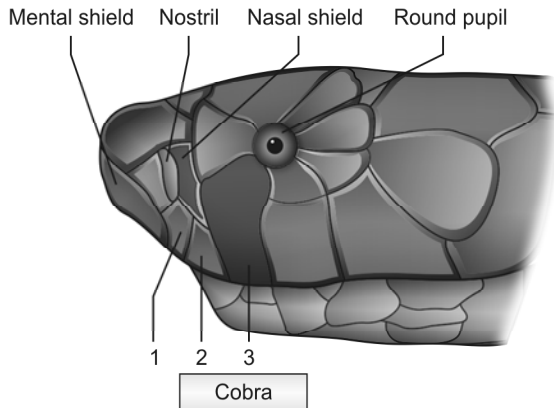

Fig. 46.3: Large head scales and third labial touches the eye and nasal shields

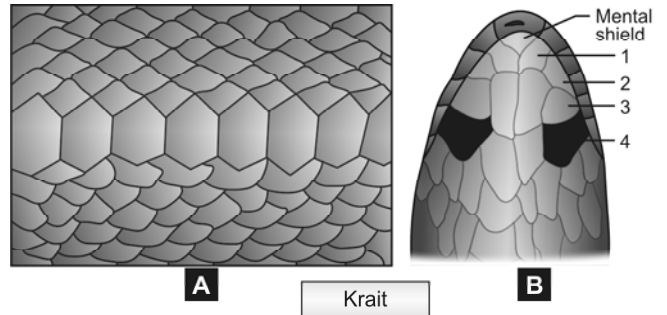

Fig. 46.4: (A) Central hexagonal scales on the middle of back (B) Fourth infralabial is the largest

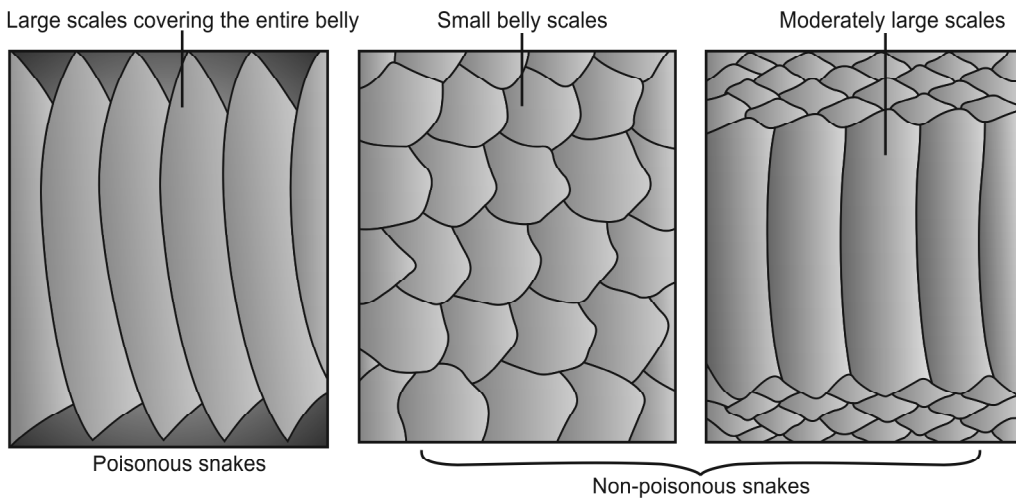

Fig. 46.5: Belly scales of poisonous and non-poisonous snakes

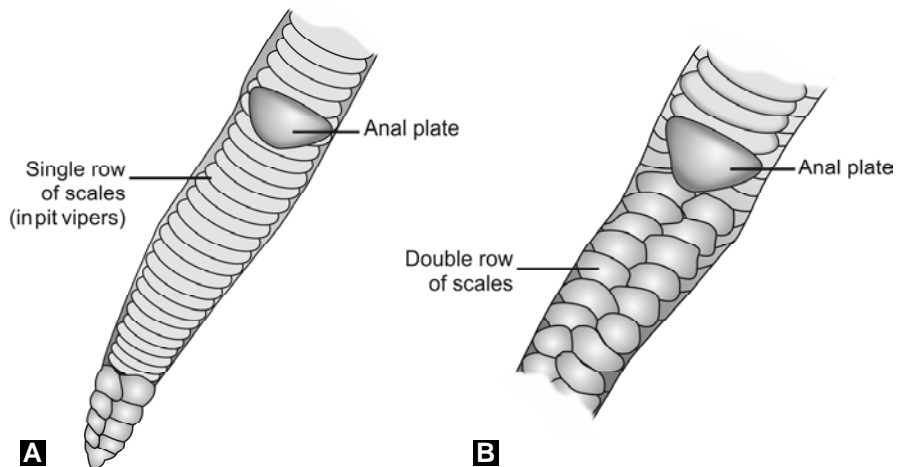

Fig. 46.6: (A) Poisonous (B) Non-poisonous snakes

are like hollow hypodermic needles (solid in non-poisonous snakes).

Snake venom: Venom is the saliva of snake, ejected from the poison apparatus (modified parotid gland) during the act of biting. It can be neurotoxic, vasculotoxic or myotoxic in its action (Diff. 46.3).

- *Physical appearance:* Faint transparent yellow and viscous, when fresh.
- *Toxic principles:* Proteinous in nature, most of which are glycopolypeptides and are enzymatic in action. About 80-90% of viperidae and 25-70% of elapididae venom consists of enzymes.

- | | |
|----------------------------|--|
| • Fibrinolysins | • Neurotoxins (elapid venom) |
| • Proteolysins | • Cholinesterase (elapid venom) ⁷ |
| • Hemolysins (viper venom) | • Thromboplastin (viper venom) |
| • Agglutinins | • Cardiotoxins |
| • Coagulase | • Hyaluronidase |
| • Phospholipase | • Lecithinase |

Fatal dose

Snake	Fatal dose (dried form)
• Cobra	15 mg
• King cobra	12 mg
• Common krait ⁸	2.5-6 mg
• Banded krait	10 mg
• Russell's viper	40 mg
• Saw-scaled viper	8 mg

Fatal period: Death may occur immediately from shock due to fright.

- Cobra: ½-24 h.
- Viper: 1-4 days.

Signs and Symptoms of Ophitoxemia

Ophitoxemia characterizes the clinical spectrum of snakebite envenomation.

- *History:* The time elapsed since the bite is important to determine if the process is confined locally or if systemic signs have developed. Obtain a description of the snake to determine its species.
- Onset of symptoms and sudden progression are more common with elapididae bite rather than viperidae. Most cobra, krait and sea snake bites would show symptoms within the first 6 h, the shortest time is for the sea snakes.
- Many bites by the poisonous snakes are dry bites implying that the snakes fail to inject the venom. In general, about 70% of bites are due to non-poisonous snakes, and of the rest, 15% are dry bites and only 15% bites cause envenomation.
- About 80% of venomous snake bite in India is by saw-scaled viper. The likelihood of a 'dry bite' is most common with a cobra.
- Early and intense pain implies significant envenomation.
- *Local signs and symptoms:* Fang marks, pain, bleeding, bruising, lymphangitis, lymph node enlargement, inflammation, blistering, local infection, abscess formation and necrosis.

Cobra (Diff. 46.4)

Local symptoms start within 6-8 min.

- A small reddish wheal develops at the site of the bite. Bitten area is tender with a burning pain.
- *Early symptoms* include vomiting, heaviness of eyelids, blurred vision, paraesthesia around mouth,

Differentiation 46.3: Neurotoxic and vasculotoxic venom

S.No. Feature	Neurotoxic venom	Vasculotoxic venom
1. Action	It causes muscular weakness of legs and paralysis of muscles of face, throat and respiration	It causes enzymatic destruction of cell walls and coagulation disorders
2. Site	Acts on motor nerve cells and resembles curare	Acts on endothelial cells of blood vessels and red cells are lysed—hemolysis
3. Local symptoms	Minimum	Severe—swelling, oozing of blood and spreading cellulitis
4. Symptoms	Cobra venom produces both convulsions and paralysis, while krait causes only paralysis	Hemorrhage from external orifices is common
5. Examples	Elapids, like cobra or kraits ^{3,4}	Vipers ⁵

Note: Myotoxic venom produces generalized muscular pain ending in respiratory failure in fatal cases, e.g. sea snakes.⁶

Differentiation 46.4: Signs and symptoms of Elapinae and viperine bite

S.No.	Feature	Elapinae bite	Viperine bite
1.	Local reaction	Minimal	Extensive
2.	Speech and deglutition	Affected	Not so
3.	Tongue	Paralyzed	Not affected
4.	Saliva	Hypersalivation	Not so
5.	Pupils	Normal	Dilated
6.	Gait	Staggering	Not so
7.	Gangrene	Wet type, early onset	Dry type, late onset
8.	Blood pressure	Normal	Hypotension
9.	Pulse	Initially normal, later irregular	Weak, irregular
10.	Respiration	Slow, weak and labored	Quick and labored
11.	Coagulation	Not affected	Greatly affected
12.	Hemorrhagic manifestations	Absent	Prominent feature
13.	Cause of death	Respiratory paralysis	Circulatory failure

hyperacusis, headache, dizziness, vertigo, hypersalivation, congested conjunctiva and gooseflesh.

- Muscles of the extremities become weak. Paralysis starts in the lower limbs, which ascends gradually affecting the respiratory muscles, including the diaphragm.⁹
- Drooping of the head, lower lip and eyelids with blurring of vision.

Krait: Signs and symptoms are similar to cobra poisoning, but less rapid.

- Abdominal pain, ptosis, dysarthria, dysphagia, chest pain, quadripareisis, respiratory paralysis and death may occur.
- There is no nausea and froth, but drowsiness is more.
- Common krait hunt nocturnally and are quick to bite people sleeping on the floor, often without waking their victims since the venom is painless. Victims wake up later, paralyzed or die in their sleep.¹⁰

Viper (Diff. 46.4)

- More local reaction is seen along with pain and oozing.
- Local necrosis is extensive which may lead to gangrene.
- Serous and serosanguinous blisters sometimes appear.
- Bilateral parotid swelling ('viper head'), conjunctival edema and subconjunctival hemorrhage.
- Petechial hemorrhages, epistaxis, hemoptysis, hematuria, and bleeding from the bite site and rectum are common.

Death is due to circulatory failure in early phase and hemorrhagic complications later.

Sea snake

- The bite is usually painless with minimal or no local swelling or involvement of local lymph nodes.
- Early symptoms include headache, a thick feeling of the tongue, thirst, sweating and vomiting.

- *Generalised rhabdomyolysis:* Muscles, especially of the neck, trunk and proximal part of the limbs may become tender and painful on active or passive movement, and later may become paralyzed with ptosis as in elapid envenoming.¹¹
- Myoglobinuria may be seen within 3 h after the bite.

Snake venom ophthalmia

If the 'spat' venom enters the eyes, there is immediate and intense burning, stinging pain, followed by profuse watering of the eyes with production of whitish discharge, congested conjunctiva, spasm and swelling of the eyelids, photophobia and clouding of vision.

Signs and symptoms depend upon:

i. Patient characteristics

- *Age, size, sex and health of the patient:* Men have more resistance than women. Children are more vulnerable as they have lesser body mass and fat, and more rapid circulation.
- *Location of bite:* Bites on the extremities, bony part, through clothing or foot wear or in adipose tissue are less dangerous (absorption delayed due to poor blood supply and loculation) than those on the head (richly vascular and proximity to systemic circulation), trunk or directly into blood vessel. Nearly 98% of snakebites occur over extremities.

ii. Snake characteristics

- The length of time the snake holds on.
- The extent of anger or fear that motivates the snake, and nature of bite.
- The condition of its fangs and venom glands.
- Species and size of the snake.
- The amount of venom injected. It is poisonous when injected subcutaneously, IV or IM, and has no ill effects when taken by mouth as it is not absorbed from gastric mucosa.

Diagnosis

20 min whole blood clotting test (20 WBCT): This is very useful and informative bedside test.

- Place a few ml of freshly sampled venous blood in a clean, dry, glass tube/bottle.
- Leave it undisturbed for 20 min at room temperature.
- Tip the tube once.
- If the blood is still unclotted and runs out, the patient has hypofibrinogenaemia ('incoagulable blood') as a result of venom-induced consumption coagulopathy.

A normal 20 WBCT and clot lysis would exclude viperidae species.

Simultaneously, a single breath counting test* is done in suspected elapidae bites and the same is repeated at 15 min interval over the first 2 h.

Clinical examination

- To exclude early neurotoxic envenoming, the patient is asked to look up and observe whether the upper lids retract fully.
- Eye movements are tested for evidence of early external ophthalmoplegia.
- The patient is asked to open his mouth and protrude his tongue; early restriction in mouth opening may indicate trismus (sea snake envenoming) or more often paralysis of pterygoid muscles.
- Other muscles innervated by the cranial nerves (facial muscles, tongue and gag reflex) are checked. The muscles flexing the neck may be paralysed, giving the 'broken neck sign.'

Management (Flow chart 46.1)

- All patients with a history of snake bite should be observed for 8-12 h after the bite, if the skin is broken and the offending snake cannot be positively identified as non-poisonous.
- The Latin maxim '*primum non nocere*' (first, do no harm) has significant meaning here because many traditional and popular, but poorly substantiated treatments may cause more harm than good. These methods include making an incision over the bite, mouth suctioning, tourniquet around the limb, use of snake stones, ice packs or electric shock.

Prevention of Spread of Venom¹²

Spread of venom through the body is mostly by diffusion through lymph circulation.

- **Reassurance:** The victim is reassured since most bites are non-venomous.

Flow chart 46.1: Management of snake bite poisoning

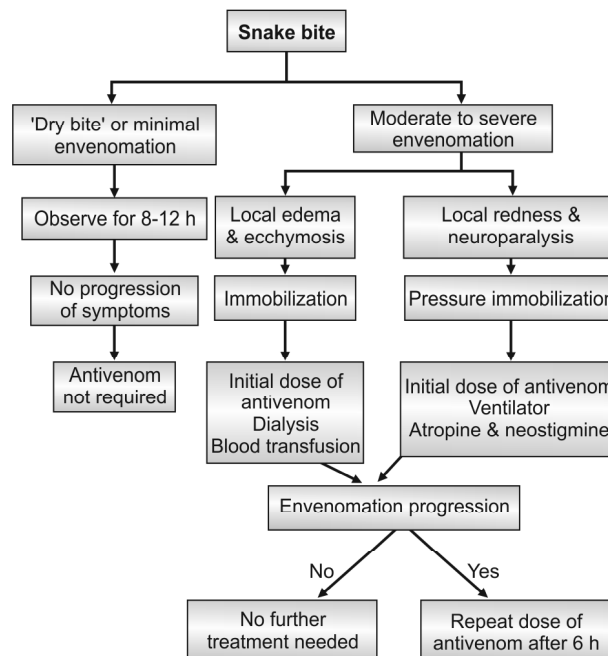

- **Immobilization:** The bitten limb should be immobilized with a splint or sling (any movement or muscular contraction hastens systemic absorption of venom) and should be kept below the level of the heart.
- **Pressure-immobilization** for elapid bites is recommended as it may delay systemic absorption of venom (indicated if the patient is > 1 h from medical care).
- **Avoid manipulation:** Any interference with the bite wound may introduce infection, increase absorption of venom and increase local bleeding.¹²

- **Pressure immobilization technique** is recommended for elapid bites, including sea snakes but should not be used for viper bites (may cause local necrosis). A compression bandage (e.g. elastic/crepe bandage or torn clothing and *not* a tourniquet) should be wrapped firmly (maintaining a pressure of 50-70 mm Hg) from the bite site upwards (Fig. 46.7).¹³ This procedure (*Sutherland wrap*) is to occlude the lymphatic circulation without impeding the arterial or deep venous flow (if occluded, it could result in gangrene or necrosis). The bandage should allow for the insinuation of one finger and peripheral pulse (radial, posterior tibial, dorsalis pedis) is palpable.
- **Tourniquets:** Tight rope, belt, string, cloth has been traditionally used to stop venom flow into the body following snake bite.
- Washing increases the flow of venom into the system by stimulating the lymphatic system.

* Single breath counting is how far an individual can count in normal speaking voice after a maximal inspiration.

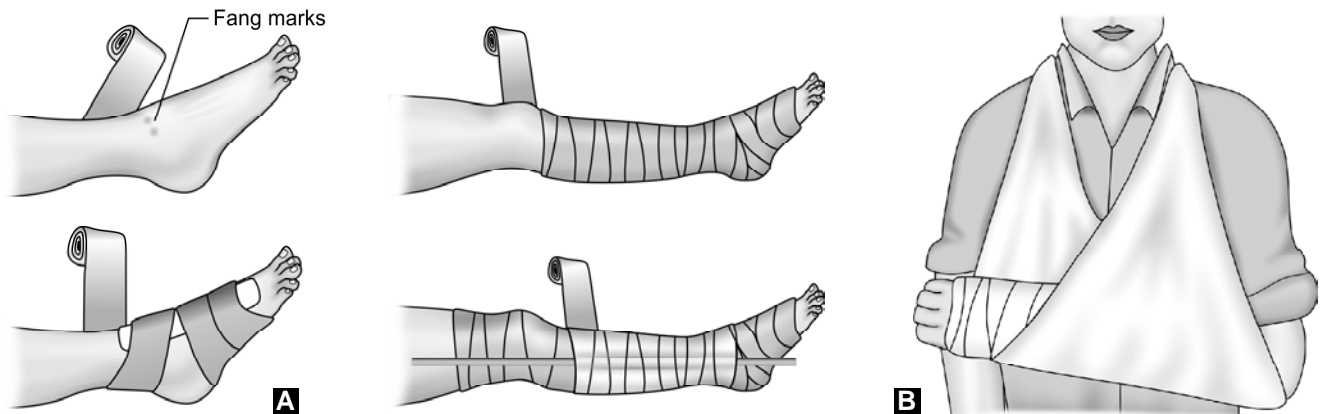

Fig. 46.7: (A) Pressure immobilization technique for lower limbs and (B) Forearms

- If there is an ulcer or wound in the mouth, sucking may allow the venom to get into bloodstream.
- *Pressure pad or 'Monash technique'*: In this method a hard pad of rubber or cloth is applied directly to the wound in an attempt to reduce venom entering the system.

Antivenom Treatment

- The polyvalent antivenom (ASV) serum available in India is effective against common poisonous snakes (cobra, common krait, saw scaled viper and Russell's viper).¹⁴
- *Dose*: Freeze-dried (lyophilized) antivenom serum is dissolved in water (10 ml vial). About 20-50 ml serum should be diluted in 200-500 ml of isotonic saline and given slow IV in severe poisoning (especially neurotoxic). Flow should be such that it is completed in 1-2 h so that further dose can be repeated, if required (every 6 h).

Indications for antivenom administration

Systemic envenoming

- *Hemostatic abnormalities*: Spontaneous systemic bleeding, coagulopathy or thrombocytopenia
- *CNS*: Ptosis, external ophthalmoplegia, paralysis
- *CVS*: Hypotension, shock, cardiac arrhythmia, abnormal ECG
- *Acute renal failure*: Oliguria/anuria, elevated creatinine/urea
- *Hemoglobin/myoglobinuria*, other evidence of intravascular hemolysis or generalized rhabdomyolysis

Local envenoming

- Local swelling involving more than half of the bitten limb (in the absence of a tourniquet)
- Swelling after bites on the digits (toes and especially fingers)
- Rapid extension of swelling
- Enlarged tender lymph node draining the bitten limb

- Antivenom treatment should be given as soon as it is indicated.

- *Contraindications*: There is no absolute contraindication to ASV treatment.
- ASV should not be used indiscriminately because it carries a risk of severe adverse reactions, and it is costly and may be in limited supply.
- Patients must be closely observed for at least 1 h after starting IV antivenom so that early anaphylactic reactions can be detected.
- Snakes inject the same dose of venom into children and adults. Children must therefore be given exactly the same dose of ASV as adults.

Antivenom reactions

- *Anaphylactic* or type I (immediate) hypersensitivity reactions may develop (itching, urticaria, glottis edema, wheezing, cough, nausea, vomiting, fever and tachycardia). Adrenaline, 0.5-1.0 ml of 0.1% solution (1 in 1000, 1 mg/ml) is given subcutaneously in adults; in children the dose is 0.01 ml/kg.
- *Serum sickness* is a type III (delayed) hypersensitivity reaction which is characterized by fever, urticaria, lymphadenopathy and arthritis, and may develop in 3 days to 3 weeks. Serum sickness is dose-related as it occurs when > 8 vials of polyvalent ASV are administered.

Supportive Treatment

Ventilatory care

- Patient should be nursed in lateral position and salivation should be cleaned timely to prevent aspiration.
- Endotracheal intubation, O₂ supplementation and tracheostomy, if necessary.

Antibiotics

- Broad spectrum antibiotics should be given, if there is wound infection.

- Tetanus toxoid or tetanus immunoglobulin of human origin is given.

Surgical excision: Surgical debridement of necrotic tissue is helpful, but the use of fasciotomy is highly questionable. Fasciotomy does not remove or reduce any envenomation. It is indicated only for compartment syndrome.

Anticholinesterase (ACE) ('Tensilon'/edrophonium test)

- ACE is effective and safe in elapid bite.
- Atropine (0.6 mg in adults and 50 µg/kg in children) is given IV (to prevent undesirable muscarinic effects of acetylcholine such as increased secretions, sweating, bradycardia and colic) followed by an IV injection of edrophonium chloride (10 mg in adults, 0.25 mg/kg in children).
- Patient can be then maintained on neostigmine (50-100 mg/kg) and atropine (4 hourly continuous infusions).

Hypotension and shock

- Fluid resuscitation with normal saline or Ringer's lactate should be initiated.
- Plasma expander, 5% albumin (10-20 ml/kg), fresh whole blood or fresh frozen plasma should be infused, if CVP is low.
- Dopamine (starting dose 2.5-5 µg/kg/min IV) can be given.

Oliguria and renal failure

- Cautious rehydration, diuretics (furosemide) or dopamine should be tried in case urine output drops to < 400 ml/24 h.
- Hemofiltration or peritoneal or hemodialysis, as indicated (acute renal failure).

Hemostatic disturbances

- Fresh blood, fresh frozen plasma, cryoprecipitate or platelet concentrates, as needed.
- Heparin 1000-5000 IV may be given, if there are clotting abnormalities (e.g. DIC). Use of heparin should be weighed against risk of bleeding and hence caution is advocated.

Corticosteroid therapy: No beneficial effects.

Snake venom ophthalmia: The eye or mucous membrane should be washed immediately using large volumes of water or other bland fluid.

Antivenom is immunoglobulin [usually the enzyme refined F(ab)₂ fragment of IgG] purified from the serum/plasma of a horse or sheep that has been immunized with the venoms of one or more species of snake. It is of two types:

- Monovalent (specific) antivenom:* ASV has been raised against the venom of the snake that has bitten the patient and it contains specific antibody that will neutralize that particular venom.

- Polyvalent (polyspecific) antivenom:* It neutralizes the venoms of several different species of snakes, usually the most important species in a particular geographical area. It is less potent, less immunogenic and less effective than monovalent, and has more adverse effects.

- The most commonly used ASV in US for pit viper (rattlesnake, copperhead and water moccasin) is CroFab, which has a much lower incidence of acute or delayed allergic reactions compared to the older ASV.

- Recent studies have reported the beneficial effects of IV immunoglobulin (IVIg) which may improve coagulopathy, though its effect on neurotoxicity is doubtful.

- A compound extracted from the plant *Hemidesmus indicus* (2-hydroxy-4 methoxy benzoic acid) has been found to have potent anti-inflammatory, antipyretic and antioxidant properties, particularly against Russell's viper venom.

- An aqueous extract of *Mimosa pudica* root possesses compounds which can neutralize the toxic effects of the cobra and krait venoms.

Complications: Compartment syndrome, tissue necrosis and bleeding diathesis. CVS and hematologic complications and pulmonary collapse may occur.

Postmortem Findings

- Poisonous snakes leave two fang marks (occasionally one) slightly separated from each other and also small marks of other teeth (Fig. 46.8A).
- Non-poisonous snakes leave a semicircular set of teeth-marks (Fig. 46.8B).

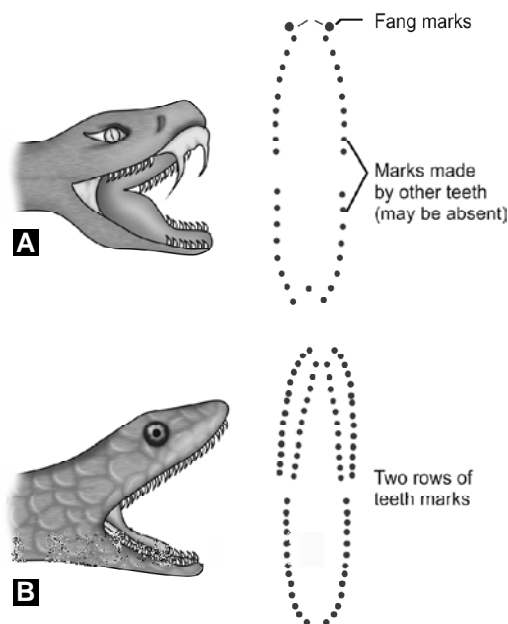

Fig. 46.8: External features of snake bite (A) Poisonous snake (B) Non-poisonous snake

- The bite marks are 1-1.5 cm deep in colubrine and 2.5 cm deep in viperine bites. These should be searched for with a magnifying lens, if not visible to the naked eye.
- *In viperine bite*, there is discoloration, swelling and cellulitis about the mark and hemorrhages occur from the puncture site and mucous membranes. Petechiae are also found in mucosa of the urinary bladder, stomach and intestines. The regional lymph nodes are swollen and hemorrhagic. Hemorrhages into the bowel and lungs, and endocardial hemorrhages may be seen. Kidneys are inflamed and may show tubular necrosis, cortical necrosis and interstitial nephritis. Internal organs are congested.
- *In elapidae bite*, the site of bite contains fluid and hemolyzed blood causing staining of vessels, and there are no definite appearances indicating the cause of death, except the signs of asphyxia.

Medico-legal Aspects

- Whether or not antivenom is given, any patient with signs of envenomation should be observed in hospital for at least 24 h.
- Poisoning is usually accidental.
- Occasionally, a murder is committed by throwing a poisonous snake on the bed of sleeping person.
- It is very rarely used for suicide. Queen Cleopatra is said to have committed suicide after her forces were defeated in battle. She chose to submit to the bite of an *asp* (an exotic variety of viper), rather than humiliation by her enemies.
- The bodies of animals killed by snake poisoning may be eaten without ill-effects, but their blood is poisonous and is fatal, if injected into the human body.
- Cattle are sometimes poisoned by snake venom.
- Radio-immunoassay (RIA) and enzyme-linked immunosorbent assay (ELISA) can identify the nature of venom from the bite site.

Cantharides (Spanish Fly)

Introduction: The Spanish fly (*Cantharis vesicatoria*, blister beetle) is 2 × 0.6 cm in dimensions. The powder of the dried body is grayish-brown and contains shiny green particles.

Active principle: Cantharidin.

Action: It is locally irritant, and nephrotoxic agent.

Absorption: Cantharidin is readily absorbed from all surfaces, including the skin.

Signs and Symptoms

Externally, on application to the skin, redness and burning pain are produced which is followed by formation of vesicles.

On ingestion, there is burning sensation in the mouth, throat and abdomen, nausea and vomiting of blood-stained material, pain in abdomen, severe thirst, tenesmus and difficulty in swallowing and speech. Later, a dull pain is felt in the loins, desire to micturate, but urine is scanty and bloodstained. Priapism in males and abortion in pregnant females may occur.¹⁵ The patient becomes prostrated with convulsions and coma preceding death.

Fatal dose: 15-30 mg of cantharidin or 1.5 g of powder.

Fatal period: 24 h.

Treatment

Gastric lavage, demulcents (but not fat) and symptomatic treatment.

Postmortem Findings

External: Inflammation and vesicles are seen in the mouth.

Internal

- GIT:* The mucous membrane of the esophagus and stomach is often swollen and engorged, and may show patches of ulceration and hemorrhages. Stomach may contain shiny greenish particles of the insect.
- Kidneys:* Congested with hemorrhage in the pelvic calices.
- Lungs:* Edematous and congested with subpleural hemorrhagic spots.

Medico-legal Aspects

- It is used as counterirritant to the skin in the blistering plaster, as aphrodisiac, and as hair oils to promote growth. So, accidental poisoning may occur.
- It is used as an abortifacient.
- Suicide/homicide is rare.

Scorpions

Introduction: About 100 species of scorpions are found in India. These are eight-legged arthropods and the end part of tail has two poisonous glands and a sting.

Physical properties: The venom is a clear, colorless, proteinous toxalbumen, having hemolytic and neurotoxic effect. Its toxicity is more than that of snakes, but only a small quantity is injected.

Action: The venom is a potent autonomic stimulator, resulting in the release of massive amounts of catecholamines from the adrenals. It has also some direct effect on the myocardium. Fatality is uncommon, except in children.

Signs and Symptoms

Locally, on the extremity, there will be edema, radiating pain and reddening.

Systemic effects are nausea, vomiting, restlessness, fever, headache, giddiness, profuse sweating, muscular fasciculations, arrhythmias, slow pulse, cyanosis, hypertension, convulsions, coma and respiratory depression, and death may occur from pulmonary edema or cardiac failure in children.

Treatment

- The limb is immobilized and a pressure bandage is applied proximal to the site of sting.
- The site may be incised and washed with water or weak solution of ammonia, borax or KMnO_4 .
- Specific antivenin is available for most species and should be used.
- Calcium gluconate 10 ml of 10% solution slow IV is given for pains, cramps and edema.
- Barbiturates/chlorpromazine is given to sedate and control convulsion.
- Atropine to prevent pulmonary edema.
- Symptomatic treatment.

Postmortem Findings

Affected site is swollen. Sting may be found at the site. The area may show ecchymosis. Pulmonary edema and myocardial infarction may be seen.

Medico-legal aspects: Poisoning is usually accidental.

Bees and Wasps

Introduction: Bee venom contains dopamine, histamine, neurotoxin enzymes and toxic peptides. Wasp venom, in addition, contains serotonin and kinins. Ant venom mainly contains alkaloids, solenopsin-A and proteins. Painful and sometime, fatal reactions occur in humans.

Signs and Symptoms

Locally, there is pain, redness and slight swelling at the site of the sting. Stings of the mouth, throat and sometimes of the face, neck or limbs may cause edema of the larynx or pharynx and obstruction.

Systemic reactions occur due to multiple stinging with signs of GIT disturbance (nausea, vomiting and diarrhea), sweating, bronchospasm, hypotension, shock and unconsciousness.

Immediate **anaphylactic reactions** may be seen in some cases. Respiratory distress, faintness and unconsciousness may be seen. Death may occur in 2-15 min.

Treatment

- Tourniquet is applied proximal to the site of the sting and incision is given. The sting is located and removed.
- Tincture of iodine or local application of antihistaminic cream is useful.
- Adrenaline is given to combat systemic reactions.
- Calcium gluconate 1-2 g IV.
- Glucocorticoids are useful for urticaria.
- Artificial respiration and O_2 inhalation is given.

MULTIPLE CHOICE QUESTIONS

1. Which of the following snakes are poisonous:

Jharkhand 03

- A. Krait B. Hydrophinae
C. Cobra D. All

2. True of poisonous snakes are all, except: *Delhi 06*

- A. Fangs present B. Belly scales are small
C. Small head scales D. Grooved teeth

3. Cobra poison is: *Delhi 03; Kerala 09; FMGE10*

- A. Neurotoxic B. Myotoxic
C. Cardiotoxic D. Vasculotoxic

4. Krait poison is: *PGI 04*

- A. Vasculotoxic B. Neurotoxic
C. Cardiotoxic D. Hemotoxic

5. Viper snake venom is:

PGI 03

- A. Hemotoxic B. Vasculotoxic
C. Myotoxic D. Neurotoxic

6. Venom of sea snake is mostly:

UP 05

- A. Neurotoxic B. Hemolytic
C. Myotoxic D. Hepatotoxic

7. Cholinesterase is seen in venom of:

DNB 08

- A. Elapids B. Vipers
C. Sea snakes D. All

8. Lethal dose of krait venom:

AP 11

- A. 3 mg B. 6 mg
C. 12 mg D. 15 mg

9. **Most characteristic feature of elapidae snake envenomation:** *UPSC 09*
 A. Bleeding manifestation
 B. Neuro-paralytic symptoms
 C. Rhabdomyolysis
 D. Cardiotoxicity
10. **A girl, otherwise healthy, sleeping on the floor suddenly develops nausea, vomiting, abdominal pain, quadriplegia at night. Diagnosis is:** *NIMS 11*
 A. Guillain Barre syndrome
 B. Poliomyelitis
 C. Krait bite
 D. Periodic paralysis
11. **Muscle paralysis is caused by bite of:** *Kerala 11*
 A. Sea snake B. Krait
 C. Mamba D. Python
12. **Following is/are recommended primary management of a patient with snake bite, except:** *PGI 11*
 A. Splinting and immobilization
 B. Keep the site of bite below heart
 C. Wash with soap and water
 D. Reassure the patient
13. **Ligature pressure that should be used to resist spread of poison in elapidae poisoning:** *WB 11*
 A. < 10 mm Hg B. 20-30 mm Hg
 C. 50-70 mm Hg D. > 100 mm Hg
14. **Polyvalent snake vaccines contains immunoglobins against all, except:** *PGI 11*
 A. Ophiophagus hannah B. Naja naja
 C. Daboia russelii D. Bungarus caeruleus
15. **Priapism occurs in:** *AIIMS 06*
 A. Snake bite B. Rati poisoning
 C. Cantharide poisoning D. Arsenic poisoning

Somniferous Poisons (Narcotic Poisons)

47

Definitions

- **Narcotic:** It refers to a sleep inducing agent and initially used to mean the opioids. Currently, the term is used by law enforcement agencies to indicate any illicit psychoactive substance.
- **Opiate:** It refers to natural alkaloids derived directly from the poppy plant.
- **Opioids:** They are broader class of agents that are capable of producing opium-like effects on binding to opioid receptors. Endogenous neural polypeptides such as endorphins and enkephalins are natural opioids.

Opium

Introduction: Opium (poppy, *afim*, *kasoomba* or *madak chandu*) is derived from *Papaver somniferum*, an annual plant with white or red flowers growing on a central bulbous pod. Crude opium has a characteristic odor and bitter taste.

Distribution: Worldwide.

Toxic part: Unripe fruit capsule, latex juice.

- Latex is obtained by lacerating ('scoring') the immature seed pods; the latex leaks out and dries to a sticky brown residue. This is scraped off the fruit.
- Seeds are non-poisonous and are called '*khaskhas*' which constitutes a condiment in cooking.

Active Principles

The latex juice of opium has about 25 alkaloids, divided into two groups.¹

- a. **Phenanthrene derivatives** (main narcotic constituents)
 - i. **Natural alkaloids**
 - Morphine (10%): White powder/crystals, bitter taste and alkaline in reaction
 - Codeine (0.5%)
 - Thebaine (0.3%)
 - ii. **Semi-synthetic opioids:** They are produced by chemical modification of an opiate and include hydromorphone, diacetylmorphine (heroin or brown sugar or smack), oxycodone and oxycodone.
 - iii. **Synthetic opioids:** These compounds are not derived from an opiate, but binds to an opioid receptor and

produce opioid effects clinically. It includes methadone, fentanyl, pentazocine, tramadol and meperidine (pethidine).²

- b. **Benzyl-isoquinolone derivatives** (no significant CNS effects)
 - i. Papaverine (1%)
 - ii. Noscapine (6%)

- **Alkaloids** are complex substance having nitrogenous base, and is found in various plants. Chemically, it behaves like an alkali as it unites with acids to form salts. Its basic quality depends on the pyridine nucleus. In nature, they are usually combined with certain acids to form salts. They act mainly on the CNS, each compound having its own individual action.
- **Important alkaloids:** Atropine, hyoscine, morphine, quinine, strychnine, cocaine and codeine. Some synthetic substances, such as amphetamine, heroin, pethidine and methadone also behave chemically like alkaloids.³

Action

- Opioids act by binding to opioid receptors on neurons distributed throughout the nervous system and immune system.
- Four major types of opioid receptors have been identified: mu, kappa, delta and the recently recognized OFQ/N. These receptors are the binding sites for endogenous peptides.
- Activation of opioid receptors results in inhibition of synaptic neurotransmission in the CNS and PNS.

Routes of administration: It can be taken by snorting, smoking or chasing (*chasing the dragon*), intravenously (*mainlining*) and subcutaneously (*skin popping*). It can be mixed with cocaine (known as *speed balling*) and then taken by addicts.

Metabolism

- Most opioids are metabolized by hepatic conjugation to inactive compounds that are excreted readily in the urine.
- Certain opioids (e.g. propoxyphene, fentanyl and buprenorphine) are more soluble in lipids and can be stored in the fatty tissues of the body.

Signs and Symptoms

Peak effects are seen in 10 min with IV route, 10-15 min after nasal insufflations, 30-45 min with IM, 90 min after taking orally and 2-4 h after dermal application.

- i. **Stage of Excitement:** It is of short duration. There is euphoria, increased sense of well-being, freedom from anxiety, talkativeness and laughter. Hallucinations, flushing of face, conjunctival injection and rapid heart rate are seen.
- ii. **Stage of Stupor:** Headache, nausea, vomiting, weakness, heaviness in limbs, giddiness, drowsiness, diminished sensibility and strong tendency to sleep from which the patient can be aroused by painful stimuli.
 - Pupils are contracted, and face and lips are cyanosed.
 - Pulse and respiration: Almost normal.
- iii. **Stage of Narcosis/Coma:** Patient passes into deep coma from which he cannot be aroused.

In this stage:⁴⁻⁶ (Fig. 47.1)

- Muscles: Flaccid and relaxed
- Face: Pale
- Reflexes: Absent
- Conjunctiva: Congested
- Skin: Cold with profuse perspiration, all other secretions are suspended
- Pupils: Constricted to pin-point, non-reacting
- Blood pressure: Falls
- Temperature: Hypothermia
- Pulse: Weak, feeble
- Respiration: Slow, stertorous (4-6 breaths/min)⁷
- Sphincter tone: Increased (can lead to urinary retention)

During the terminal stages, pink froth comes from the mouth, pulse is slow, irregular and imperceptible, respiration becomes Cheyne-Stokes and ultimately deep coma and death due to respiratory depression and cardio-respiratory arrest.

The 'triad' of respiratory depression, pin-point pupil and impairment of sensorium is characteristic of opioid poisoning.

Fatal dose

- Opium: 2 g.
- Morphine: 200 mg.
- Codeine: 50 mg.

Fatal period: 6-12 h.

Differential Diagnosis

- **Intracranial hemorrhage:** Cerebrovascular accidents and brain trauma.
- **Poisoning:** Alcohol, barbiturates, benzodiazepine, carbolic acid, carbon monoxide and organo-phosphorus.

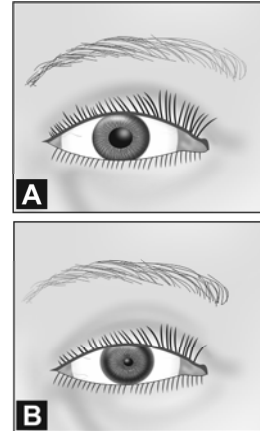

Fig. 47.1: (A) Normal pupil (B) Pinpoint pupil

- **Metabolic conditions:** Diabetic and uremic coma.
- **CNS infections:** Meningitis, encephalitis, encephalopathy and cerebral malaria.
- **Others:** Epileptic and hysterical coma, and heat hyperpyrexia.

Treatment

- i. Support vitals through respirator and other emergency procedures.
- ii. **Decontamination:** Stomach wash frequently with 1:5000 KMnO₄ leaving some solution in stomach to oxidize the alkaloid that might be secreted in stomach after absorption. Lavage should be carried out even after IV/IM injection of drug as it is secreted in the stomach.
- iii. Administer activated charcoal—method of choice for decontamination following ingestion.
- iv. Enema with 30 g of sodium sulphate twice daily.
- v. Whole-bowel irrigation in body packers.
- vi. Narcotic antagonist *naloxone* in an initial dose of 0.4-2 mg IV/IM repeated every 2-3 min upto 10 mg, if no response occurs.⁸

If there is little response to naloxone alone, possibility of an overdose with a benzodiazepine should be considered and a challenge with IV flumazenil, 0.2 mg/min upto maximum of 3 mg in an hour might be used.

Detection

Marquis test: It is a simple spot-test to presumptively identify alkaloids. It can be used to test cocaine, opiates and phenethylamines.⁹

Three ml of concentrated H₂SO₄ + 3 drops of formalin are added to the suspected sample. Purple-red color is observed which gradually changes to violet.

Postmortem Findings

External

- i. Smell of opium.
- ii. Face/body is bluish, deeply cyanosed or blackish.
- iii. Postmortem staining is purple or blackish.
- iv. Froth at the nostrils.
- v. Pupils are constricted, can be dilated also.
- vi. Allergic reactions to IV heroin may be seen.
- vii. Needle tracks are found occasionally, depending on the route of intake.

Internal

- i. Diffuse cerebral edema.
- ii. All organs are congested, trachea contains frothy secretions.
- iii. Blood is dark and fluid.
- iv. Stomach may show presence of small, soft brownish lumps of opium and smell of drug may be perceived.

Medico-legal Aspects

- Opium preparations are used therapeutically to reduce pain and induce sleep.
- It is a poison of choice to commit suicide (*ideal suicidal poison*).
- Homicide is rare, because of bitter taste and characteristic odor.
- Infanticide by breastfeeding an infant by a woman who had smeared her nipple with tincture opium.
- Accidental opium poisoning is also common. Drugging of children by opium to keep them quiet and overdose of medicines may result in accidental poisoning.
- Sometimes, opium is used for doping racehorses.
- It is said to increase libido, hence used as an aphrodisiac.
- Some criminals take opium to build courage before committing a crime.
- Opium disappears with putrefaction, so it may not be detected in putrefied bodies.

- It should be noted that opioid exposure does not always result in pupillary constriction, and respiratory depression is the most specific sign.¹⁰ Other important presenting signs are ventricular arrhythmias, acute mental status changes and seizures.
- Acute lung injury is known sequelae of heroin, propoxyphene and methadone overdose and present in fatal cases of opioid overdose. The findings are cyanosis, dyspnea, pink frothy sputum, rales, tachypnea and tachycardia.
- Earlier opioid overdose was treated with analeptics. In 1950s, specific antidotes were introduced: nalorphine and

levallorphan which were capable of reversing the respiratory effects by blocking the opioid receptors. However, they have a mixed agonist-antagonist properties that significantly limited their usefulness. Naloxone with its pure opioid antagonistic properties completely replaced nalorphine and levallorphan in the treatment of opioid overdose.

- Nalmefene and naltrexone are newer opioid antagonists that have longer half-lives than naloxone (4-8 h and 8-12 h vs 1 h). The routine use of a long-acting antagonist in the patient who is unconscious for unknown reasons is not recommended.

Body Packers

- Multiple-wrapped packets of illicit drugs (cocaine or heroin) may be ingested or inserted into body cavities by 'swallowers,' 'internal carriers,' 'couriers,' or 'mules' to intentionally transport drugs from one country to another. After they arrive at their destination, cathartics are administered so that the packets can be passed and delivered.
- When the authorities discover such individuals or when individuals in custody become ill they may be brought to a nearby hospital for evaluation and management. Although these patients generally are asymptomatic on arrival, they are at risk for delayed, prolonged or lethal poisoning as a consequence of packet rupture.
- If there is a suspicion of body packing or body stuffing, careful cavity searches of the rectum and vagina are done. An abdominal X-ray can confirm the diagnosis.
- Intestinal perforation or obstruction by the packets may require surgical intervention.

Chasing the Dragon

- Intravenous injection and insufflation are the preferred means of heroin self-administration in US. In the other countries, including Netherlands, UK and Spain, the prevalent method is 'chasing the dragon.'
- In this, users inhale a thick, white pyrolyste that is generated by heating heroin base on aluminum foil using a hand-held flame. This means of administration produces heroin concentration similar to those observed following IV administration.
- Chasing the dragon is not a new phenomenon, but it has gained acceptance recently among both IV heroin users and non-addict individuals.

Chronic Morphine Poisoning (Morphinism)

- Opioid dependence is seen among patients with chronic pain syndromes, and the physicians, nurses and pharmacists because of its easy access.
- The most important dependence producing derivatives are *morphine and heroin*. Heroin is more addicting than morphine and can cause dependence after a short period of exposure. Tolerance to heroin occurs rapidly and can be increased to more than 100 times the first dose needed.
- The important complications of chronic opioid use may include one or more of the following:
 - Due to illicit drug (contaminants)*: Peripheral neuropathy, amblyopia, degeneration of globus pallidus, Parkinsonism and transverse myelitis.
 - Due to intravenous use*: Skin infections, thrombophlebitis, AIDS, hepatitis, pulmonary embolism, endocarditis, osteomyelitis, pneumonia, septicemia and tetanus.

Fentanyl

Fentanyl is 50-100 times more potent than morphine. It is the preferred drug of abuse of anesthesiologists. It is available both in hospitals and illicitly. It can be taken IV, orally, smoked, snorted or by way of skin patches, with the IV route the most common. Therapeutic levels are in the low ng/ml levels (1-3 ng/ml). Fatalities are seen at levels beginning at 3 ng/ml.

MULTIPLE CHOICE QUESTIONS

- Which of the following is least narcotic:** *AIIMS 09*
 A. Morphine B. Codeine
 C. Thebaine D. Papaverine
- Which of these is not an opioid agonist:** *AIIMS 10*
 A. Heroin B. Ketamine
 C. Methadone D. Fentanyl
- All are alkaloids, except:** *BHU 10*
 A. Morphine B. Physostigmine
 C. Atropine D. Atrine
- A 28-year-old male patient is brought to casualty in comatose state with pin-point pupils, reduced respiratory rate and bradycardia. Most likely diagnosis:** *UPSC 09*
 A. Tricyclic antidepressant poisoning
 B. Opioid poisoning
 C. Benzodiazepine poisoning
 D. Organophosphorus poisoning
- All are features of acute morphine poisoning, except:** *Kerala 11*
 A. Pin-point pupil
 B. Hyperpyrexia
 C. Fall in blood pressure
 D. Slow labored breathing
- Pin-point pupils are seen in:** *Kerala 09; Punjab 09; UP 10*
 A. OPC poisoning
 B. Opium poisoning
 C. Alphas poisoning
 D. Datura poisoning
- Acute poisoning of narcotics present with:** *UP 04*
 A. Hypertension
 B. Hyperventilation
 C. Slow and shallow respiration
 D. Dilated pupils
- Most common feature of opiate poisoning:** *NIMHANS 11*
 A. Respiratory depression
 B. Hypotension
 C. Bradycardia
 D. Hypothermia
- Opium poisoning is treated with:** *PGI 03; Manipal 06*
 A. Naloxone B. Atropine
 C. Neostigmine D. Physostigmine
- Marquis test is done for:** *Delhi 03; BHU 08*
 A. Mercury poisoning B. Arsenic poisoning
 C. Morphine poisoning D. Cyanide poisoning

Introduction

- Ethanol (ethyl alcohol) is a transparent, colorless, volatile liquid having a characteristic odor and a burning taste with a specific gravity of 0.79.
- Ethanol is produced by the enzymatic action of yeasts on vegetable substrate containing sugars. Direct fermentation cannot raise the concentration to $\geq 12-15\%$ as the yeast is killed, but distillation of primary fermentation can concentrate the alcohol to 40-60% strength. Different types of beverages with percentage of alcohol are given in Table 48.1.
- At low doses, alcohol is said to have beneficial effects, such as decreased rates of myocardial infarction, diabetes, stroke, gallstones and possibly Alzheimer's dementia, but consumption of two standard drinks per day increases the risk of health problems in many organ systems. Regular consumption of 20-32 g/day for men and 14-27.2 g/day for women are considered as safe limits for drinking, if liver damage is to be avoided (difference between the sexes was due to the lower weight and water-to-body-mass ratio of women).

- Earlier, weekly safe limit was recommended [168-210 g/week (≤ 21 units) of alcohol for men and 98-140 g for women (≤ 14 units)].¹ This is not advised, since a study showed that many people were in effect 'saving up' their units and using them at the end of the week for *binge drinking* where the primary intention is to become intoxicated by heavy consumption of alcohol over a short period of time.
- An international study found that persons who reported drinking > 2 units/day had an increased risk of fractures compared to non-drinkers.
- Units of alcohol** are a measure of the volume of pure alcohol in alcoholic beverages used as a guideline in some countries. One unit of alcohol is defined as 10 ml in UK and as 10 g (12.7 ml) in Australia. A standard drink is 30 ml of spirits; 330 ml can of beer or 100 ml glass of wine.
- To calculate standard drinks, the following formula is used: Volume of container (litres) \times % alcohol by volume (ml/100 ml) \times 0.789 = Number of standard drinks

Table 48.1: Approximate percentage of alcohol by volume in beverages

Beverage	Alcohol by volume
Spirits (whisky, brandy, rum, gin, vodka)	35-50%
Port (fortified with brandy), sherry	17-21%
Wine	10-15%
Champagne	10-13%
Beers, stout, cider	4-8%

Commercial Preparations of Alcohol

- Absolute alcohol* contains 99.95% ethanol.
- Mineralized methylated spirit* consists of 90% ethanol, 9.5% wood naphtha (methanol) and 0.5% pyridine and is colored pink for easy identification.
- Industrial methylated spirit* contains 95% ethanol and 5% methanol, with no coloring agent.
- Surgical spirit* consists of 95% of ethanol and 5% methanol with oil of wintergreen to give it a sweetish flavor.

Proof of spirit indicates a mixture containing 57.1% by volume or 49.28% by weight of absolute alcohol. In US, the term proof refers to twice the percentage of alcohol by volume. So, the common 80-proof whisky sold in US contains 40% alcohol by volume. In India, the spirit (whisky, rum or brandy) is usually 42.8% by volume and 75-proof.

The concentration written on the labels of most bottles is v/v, i.e. volume of alcohol per volume of drink.

Various country liquors

- Mahua*: Traditional tribal drink in central and eastern India. It is made from dried flower of mahua tree (*Madhuca longifolia*) and *chhowa gud* (granular molasses).
- Toddy* (palm wine) is made from sap of various species of palm tree. It is common across Asia and Africa.
- Feni*: Goan spirit, made from coconut or juice of cashew apple.
- Arrack* (Arabic *araq*—sweet liquor usually made from raisins in those regions) is distilled from coco-palm, rice, sugar or jaggery and has strength of 40-50%. It may be mixed with chloral hydrate or potassium bromide.

- *Tharra* is made by fermenting the mash of sugarcane juice/pulp in ceramic containers and distilling to high alcohol content.
- *Chhaang* (Tibetan: 'nectar of gods') is a Tibetan/Sherpa rice beer, also popular in parts of eastern Himalayas. It is can be brewed from barley and millet stuffed in a barrel of bamboo, over which water is poured.
- *Handia*: It is made by fermenting boiled rice mixed with herbs. Commonly seen in Bihar, Jharkhand, Orissa, MP and Chhatisgarh.
- *Chuak* is made by fermenting rice in water, common in Tripura.
- *Sonti* is made much like sake and similar to wine in its alcohol content. It is made by steaming rice. A mold, *Rhizopus sonti*, is used, followed by fermentation.

Action

Ethanol acts mainly on the CNS. It acts as a depressant of specialized and sensitive cells of cerebral cortex (centres regulating conduct, judgment and self-criticism) with release of inhibitory tone, leading to unrestrained behavior. This is followed by depression of vital centres of medulla producing coma and death.

Alcohol also acts a hypnotic, diaphoretic, and in small doses as an appetizer.

Metabolism

Following absorption, the concentration of alcohol in the blood reaches a maximum in about 45-90 min after ingestion. The *blood alcohol concentration (BAC)* is often represented by a graph.

- With an empty stomach, there is a rapid rise and slow decline.
- With diluted drinks or a full stomach, the rise is slower and the maximum peak is lower with a flatter BAC curve. If subsequent drinks are taken, the new alcohol is superadded to the existing curve.

Factors that interfere with absorption are:

- Presence of food (especially fats and proteins) in stomach retards absorption.
- Strength of alcoholic beverages taken—higher the strength more rapid will be the rate of absorption.
- Diluted drinks, such as beer may take double the time to absorb, compared to stronger drinks.
- Drugs, like insulin or prostigmine increase the absorption, while atropine delays absorption.
- Chronic gastritis retards absorption.
- Carbonated drinks hasten absorption as the bubbles greatly increase the surface area carrying alcohol.
- Warm alcoholic drinks which dilate gastric mucosal capillaries are more quickly absorbed than iced drinks of same strength.

Distribution

Ethanol is distributed evenly throughout the body, passing the blood-brain barrier easily to affect cerebral function. However, it is poorly soluble in body fat; females of same body size as males will produce a higher BAC for the same amount of drink, as their aqueous compartment is smaller.

It attains equilibrium with a constant blood alcohol concentration and concentration of alcohol in other body fluids, the ratio being:

- Blood: Urine = 1:1.35
- Blood: Exhaled air (breath) = 1:2300
- Blood: Saliva = 1:12
- Blood: CSF = 1:1.17

Detoxification

Ninety percent of ethanol is metabolized in the liver, while the kidneys and lungs help to excrete about 10% only. In the liver, alcohol is oxidized by alcohol dehydrogenase (Flow chart 48.1).

Flow chart 48.1: Metabolism of ethanol in liver [(A) causes increased blood acetaldehyde levels and (B) causes increased dopamine levels]

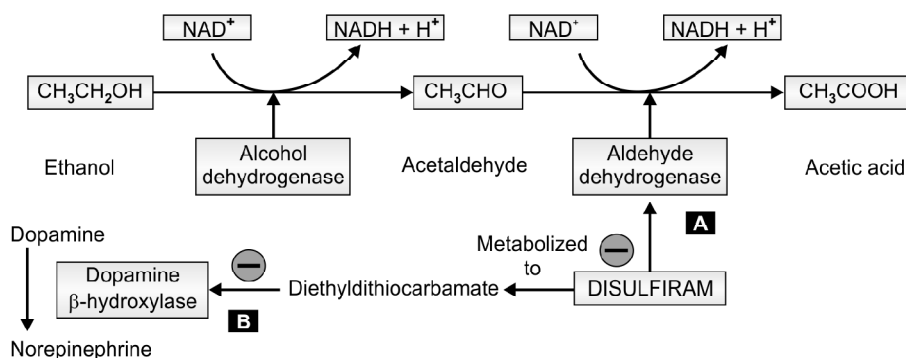

- Non-habituated persons metabolize ethanol at 13-25 mg/dl/h. In alcoholics, this rate increases to 30-50 mg/dl/h. Because of tolerance, BACs must be interpreted in conjunction with history and clinical presentation.
- Excretion of alcohol is mainly by the kidneys, lungs and skin through urine, breath and sweat respectively. It is also secreted in saliva and milk.

A number of metabolic effects from alcohol are directly linked to the production of an excess of both NADH and acetaldehyde.

- NADH is utilized in the conversion of pyruvic acid (intended for conversion into glucose by gluconeogenesis) to lactic acid. The final result may be acidosis from lactic acid build-up and hypoglycemia from lack of glucose synthesis.
- Excess NADH may be used as a reducing agent in two pathways—one to synthesize glycerol (from a glycolysis intermediate) and the other to synthesize fatty acids. As a result, heavy drinkers may initially be overweight (*'beer belly'*).
- The accumulated acetaldehyde acts by inhibiting the mitochondrial reactions and functions. There is a vicious cycle—high acetaldehyde level impairs mitochondria function, metabolism of acetaldehyde to acetic acid decreases, more acetaldehyde accumulates and causes further liver damage—hepatitis and cirrhosis.
- Acetaldehyde may be responsible for the development of alcohol addiction.

Signs and Symptoms (Acute Poisoning)

- Stage of Excitement** (*Blood level: 50-150 mg%*)
 - Person will be euphoric (sense of well-being). Actions, speech and emotions are less restrained due to lowering of the inhibition normally exercised by the higher centres of the brain. It alters time and space perception.
 - He may perform dancing, thrilling shows, carelessly and fearlessly.
 - He might disclose secrets.
 - Person might show increase in confidence, but lack of self-control.
 - There is lowering of visual acuity. Nystagmus present.
 - Mental concentration is poor and judgment impaired.
 - Faculty of attention deteriorates.
 - Recall memory is disturbed, person cannot accurately recall certain situations or names of individuals.
 - It increases the desire for sex, but markedly impairs performance resulting in prolonged intercourse without ejaculation.
- Stage of In-coordination** (*Blood level: 150-250 mg%*)
 - Due to further depression of higher centres, the person may be morose/cheerful/irritable/ill-

tempered/excitable/sleepy, depending on the dominant impulses released.

- Centres of perception and skilled movements are involved—there is clumsiness and in-coordination of fine and skilled movements and alterations in speech and fine finger movements.
 - Nausea and vomiting.
 - Face: Flushed.
 - Pulse: Rapid.
 - Sense of touch, taste, smell and hearing are diminished.
 - Hypothermia.
 - Breath smells of alcohol.
 - Pupils are dilated and react sluggishly to light.
- Stage of Coma** (*Blood level > 250 mg%*)
 - Thick, slurred speech.
 - Coordination is markedly affected—becomes giddy, stagger and fall.
 - Pulse is rapid.
 - Hypothermia.
 - Pupils are contracted, but on stimulation of the person, e.g. by pinching or slapping causes them to dilate with slow return (*McEwan's sign*).
 - Patient passes into coma with stearous breathing.

Alcoholic gaze nystagmus

It can be:

- Positional nystagmus:** Initially, nystagmus is in the direction towards which the head is turned, but after 5-6 h, the nystagmus is in opposite direction to which the head is turned. It is detected when the patient is lying supine and the head turned to either the left or right.
- Horizontal nystagmus:** Jerky movements of the eyeball when the gaze is directed to one side.
 - Blood alcohol level is 50-100 mg%.
 - Other conditions where nystagmus may be observed—fatigue, emotion, postural hypotension and ingestion of sedatives and tranquillizers.

Recovery: Unless a large quantity of alcohol is consumed in a short time, recovery is the rule.

- About 35% of drinkers may experience a *blackout*, an episode of temporary anterograde amnesia in which the person forgets all or part of what occurred during a drinking session.²
- At times, a small dose of alcohol may produce acute intoxication in some persons which is known as *pathological intoxication*.

With recovery, coma gradually lightens into deep sleep. Person will wake up in 8-10 h with acute depression of mood, nausea and headache—*alcohol hangover*.

Death: If the victim does not recover from coma within 5 h, prognosis is bad and may result in death due to

shock, depression of respiratory centre or aspiration of vomit.

Fatal dose (non-addict)

- 150-250 ml of absolute alcohol consumed in 1 h.
- Risk of death is increased if BAC > 200 mg/dl and death is typical if the BAC is between 300-400 mg/dl.

Fatal period: 12-24 h.

Diagnosis: The distinctive aroma of alcohol may assist in diagnosis. Confirmation is done by analysis of blood (serum glucose level should be done along with it). Possibility of intoxication with other drugs should be considered and a blood or urine sample is indicated to screen for opioid and other CNS depressants, particularly benzodiazepines and barbiturates.

Treatment

- i. Patient must be kept warm and placed in a quiet environment and made to lie on the side to minimize risk of aspiration.
- ii. Gastric lavage with alkaline solution within 2 h of ingestion.
- iii. One litre of normal saline with 10% glucose and 15 units of insulin or 50% dextrose (50 in 100 ml) is given IV.
- iv. Thiamine 100 mg in 500 ml glucose solution IV.
- v. Respiratory support and O₂ therapy.
- vi. Hemodialysis and peritoneal dialysis may be used.
- vii. In case of aggressive behavior, non-threatening force by intervention team or short acting benzodiazepine, such as lorazepam 1 mg orally may be used.

Complications

Patient may exhibit *holiday heart syndrome* in which cardiac dysrhythmias (especially atrial fibrillation and ventricular arrhythmias) are often observed after a heavy drinking episode.^{3,4} Hypoglycemia, gastritis, pancreatitis and toxic psychosis may also occur. In teenagers, it may lead to anemia, macrocytosis, and elevation of enzymes, bilirubin and uric acid.

Postmortem Findings

- i. Odor of alcohol around the mouth and nose.
- ii. Congestion of conjunctiva.
- iii. Rigor mortis is prolonged and decomposition is retarded.
- iv. Acute inflammation of the stomach with coating of mucus.

- v. All viscera are congested and smells of alcohol.
- vi. Blood is fluid and dark.

Medico-legal Aspects

- Routine use of BAC is controversial because it is unlikely to affect management in a patient who is awake and alert. It is safe to discharge the patient once he/she is clinically (not numerically) no longer intoxicated.
- Patients with alcohol intoxication should be evaluated for coexisting injuries and metabolic disorders. A patient with altered mental status is simply considered intoxicated without consideration of other possible causes. Hypoglycemia should always be sought in such cases.
- Hemodialysis should be used, especially in the presence of metabolic abnormalities.
- There should not be any delay in waiting for laboratory tests (to confirm the presence alcohol) before starting the treatment.

Chronic Alcoholism (Systemic Effects)

It is characterized by a gradual physical, mental and moral deterioration.

1. **Physical:** There is lack of personal hygiene, loss of appetite, chronic gastroenteritis, wasting, peripheral neuropathies, impotence, sterility, fatty changes in liver and heart, cirrhosis, tremors, insomnia, red eyes and intermittent infections.
2. **Mental:** There is loss of memory, impaired power of judgment and dementia.

*Common clinical syndromes associated with chronic alcoholism:*⁵

- Delirium tremens
- Alcoholic hallucinosis
- Korsakoff's psychosis
- Wernicke's encephalopathy
- Marchiafava-Bignami syndrome
- Alcoholic paranoia
- Alcoholic seizures

3. **Moral:** It manifests as crimes which the addict commits to get his drink. He becomes morbidly jealous and suspicious of his wife's fidelity and may assault her.

Treatment

- i. Sudden withdrawal of alcoholic drinks.
- ii. **Antabuse** (*disulfiram*) is given as an aversion technique.⁶ Disulfiram (tetraethyl thiuram disulfide) blocks metabolism of alcohol at the acetaldehyde

stage (Flow chart 48.1).^{7,8} Acetaldehyde accumulates in blood causing disulfiram-ethanol reaction (aldehyde syndrome).

- **Symptoms:** Flushing, palpitation, nausea, vomiting, anxiety, tightness of chest, hypotension, sweating, throbbing headache, giddiness, sense of impending doom and abdominal cramps appear due to which patient dislikes alcohol. Duration of the syndrome (1–4 h) depends on the amount of alcohol consumed.
- **Dose:** The initial dose is 250-500 mg for 1-2 weeks (taken before bedtime) followed by a maintenance dose of 250 mg/day (range 125-500 mg). The total daily dosage should not exceed 500 mg.
- **Contraindications:** Coronary artery disease, liver failure, chronic renal failure, peripheral neuropathy, muscular disease, history of psychosis and pregnancy (1st trimester).
- iii. Citrated calcium carbimide (Temposil): 100 mg/day in 2 divided doses instead of antabuse may be given.
- iv. Metronidazole, nitrafezole and methyltetraazolethiol are other alternatives.⁹
- v. Nutrients, vitamins and gradual return to a normal balanced diet.
- vi. Symptomatic treatment.

Withdrawal Symptoms

Tremulousness or shake or jitter (most common sign), weakness, pain in muscle, cold sweat, insomnia, loss of appetite, vomiting, diarrhea, restlessness, exaggerated reflexes, raised temperature, fluctuating BP, hallucinations, loss of memory and delirium tremens.¹⁰

Many alcoholics experience 'the shakes' approximately 12-24 h after their last drink. The shakes are tremors caused by over excitation of the CNS. Tremors may be accompanied by tachycardia, diaphoresis, anorexia, and insomnia. After 24-72 h, the alcoholic may have **rum fits** (i.e. generalized seizures).

- **Disulfiram** action was discovered accidentally, as the substance was intended to provide a remedy for parasitic infestations. However, workers testing the substance on themselves reported severe symptoms after alcohol consumption.

It is also being studied as a treatment for cocaine dependence, as it prevents the breakdown of dopamine (neurotransmitter whose release is stimulated by cocaine), the excess dopamine results in increased anxiety, higher blood pressure, restlessness and other unpleasant symptoms (Flow chart 48.1).

- Animal charcoal, fungus (*Coprinus atramentarius*), sulfonyleureas and certain cephalosporins also cause a disulfiram-like action.

CAGE questionnaire: Developed by *Dr John Ewing*, CAGE is an internationally used assessment instrument for identifying alcoholics.¹¹

- i. Have you ever felt you should **C**ut down on your drinking?
- ii. Have people **A**nnoyed you, by criticizing your drinking?
- iii. Have you ever felt bad or **G**uilty about your drinking?
- iv. Have you ever had a drink, first thing in the morning, to steady your nerves or to get rid of a hangover (**E**ye opener)?

Scoring: Item responses on the CAGE are scored 0 or 1, with a higher score an indication of alcohol problems. A total score of 2 or greater is considered clinically significant.

Delirium Tremens

This is an acute organic brain syndrome, usually seen within 2-4 days of complete absence from heavy alcohol drinking in chronic alcoholics, and most severe alcohol withdrawal syndrome.¹²

Causes

- Sudden excess or sudden withdrawal of alcohol.
- Long continual ingestion of alcohol.
- Shock due to severe trauma, e.g. fracture in a chronic alcoholic.
- Acute infections, like pneumonia or influenza in a chronic alcoholic.

Signs and Symptoms¹³⁻¹⁵

There is an *acute attack of insanity* in which there is:

- i. Clouding of consciousness with disorientation in time and space.
- ii. Coarse muscular tremors of face, tongue and hands.
- iii. Insomnia with reversal of sleep-wake cycle, and loss of memory.
- iv. Psychomotor agitation, ataxia, uncontrollable fear, and tendency to commit suicide/homicide/violent assault or cause damage to property.
- v. Marked autonomic disturbances with tachycardia, fever, sweating, hypertension and pupillary dilatation.
- vi. Peculiar type of *delirium of horrors* due to hallucinations of sight and hearing. Tactile hallucinations of insects and ants crawling under the skin or on the beds may occur.

Treatment

(For both withdrawal symptoms and delirium tremens)

- i. Diazepam (40-80 mg/day in divided doses) is used.¹⁷
- ii. Oral multi-B vitamins, including thiamine 50-100 mg is given daily for a week or more.
- iii. Chlordiazepoxide (80-200 mg/day in divided doses) or haloperidol 20 mg or more/day may be used.

- iv. Intravenous fluids are avoided, unless there is evidence of bleeding, vomiting or diarrhea.
- v. In some withdrawal symptom cases, only restoration of alcoholic drinks helps.
- vi. In cases of urgent sedation as in delirium tremens—phenobarbitone or chlorpromazine injection can be given, and then detoxification and maintenance of nutrition is carried on with 5% dextrose solution IV and thiamine.
- vii. Symptomatic treatment.

Medico-legal Aspects

- It is a medical emergency and should be treated on an inpatient basis.
- When a person in delirium tremens commits any illegal act, he is not held responsible by the reason that he/she is considered to be mentally unsound during this state (**Sec. 84 IPC**).

Alcoholic Hallucinosi

- It is a state of hallucination, mainly auditory with systematized *delusions of persecution* lasting from weeks to months.
- Occurs during abstinence in 2% of patients who have been on regular alcohol till then.
- It is a psychiatric emergency, requiring hospitalization, sedation and close monitoring. Usually, recovery occurs in a month.
- Patient may become homicidal or suicidal in response to his hallucination.
- **Treatment:** Same as delirium tremens.

Wernicke's Encephalopathy

This is an acute reaction due to severe thiamine deficiency (Vit. B-1), the commonest cause being chronic alcohol abuse. Characteristically, the onset occurs after a period of persistent vomiting.

Signs and Symptoms^{16,17}

- i. **Ocular:** Coarse nystagmus and ophthalmoparesis (usually the 6th cranial nerve is involved). Pupillary irregularity, retinal hemorrhages, papilledema and impairment of vision.
 - ii. **CNS:** Disorientation, confusion, recent memory disturbances, poor attention span and distractibility. Apathy and ataxia are early symptoms.
 - iii. Peripheral neuropathy and serious malnutrition are often coexistent.
- Pathologically*, neuronal degeneration and hemorrhage is seen in the thalamus, hypothalamus (mammillary bodies) and midbrain.

Korsakoff's Psychosis

Korsakoff first identified this condition in 1887. Korsakoff's psychosis often follows Wernicke's encephalopathy, so they are referred to as *Wernicke-Korsakoff syndrome*.

Cause: Severe, untreated thiamine deficiency, secondary to chronic alcohol abuse.^{18,19}

Signs and Symptoms

It presents as an *organic amnesic syndrome*, characterized by inability to learn new information, impairment of short-term memory and compensatory confabulation. Insight is often impaired.²⁰

The *pathological lesion* is usually widespread, but changes are seen in bilateral dorsomedial nuclei of thalamus and mammillary bodies. The changes are also seen in periventricular and periaqueductal gray matter, cerebellum and parts of brainstem.²¹

Sometimes, **alcohol dementia** may be associated with Wernicke-Korsakoff syndrome, which is caused by long-term or excessive drinking resulting in neurological damage and impairment of memory.

Treatment

- i. Intravenous thiamine (in the form of *Pabrinex*, two vials 8 hourly for 48 h) initially, followed by oral (100 mg 8 hourly).
 - ii. Supplementation of electrolytes, particularly magnesium and potassium, may be required in addition to thiamine.
- **Alcoholic peripheral neuropathy:** Symptoms of alcoholic polyneuritis are weakness, pain in extremities, wrist and foot drop, unsteady gait, loss of deep reflexes and tenderness of muscles of arms and legs.
 - **Alcoholic paranoia:** In this, there is a fixed delusion, but no hallucinations.²² Patient becomes suspicious of the motives and actions of those he meets and of his family members.
 - **Marchiafava-Bignami syndrome:** This is a rare disorder characterized by disorientation, epilepsy, ataxia, dysarthria, hallucinations, spastic limb paralysis, and personality and intellectual deterioration. There is a widespread demyelination of corpus callosum, optic tracts and cerebellar peduncles. The cause is probably some alcohol-related nutritional deficiency.
 - **Alcoholic seizures ('rum fits'):** In alcohol dependence persons, generalized tonic clonic seizure may occur after 12-48 h of heavy bout of drinking alcohol.

Multiple seizures are more common than single seizure. Sometimes, status epilepticus and delirium tremens may be precipitated.

- Thiamine is absorbed from the duodenum; alcohol interferes with its active transport and chronic liver disease causes decreased capacity of the liver to store thiamine.
- Thiamine is converted to its active form *thiamine pyrophosphate* in neuronal and glial cells which serves as a cofactor for several enzymes (transketolase, pyruvate dehydrogenase and alpha ketoglutarate). The main function of these enzymes in the brain is lipid (myelin sheath) and carbohydrate metabolism, production of amino acids and production of glucose-derived neurotransmitters.
- Within 2-3 weeks of decreased intake and thiamine depletion, areas of the brain with the highest thiamine content and turnover (thalamus and the mammillary bodies) will demonstrate cellular impairment and injury.

Drunkenness

Definition: It is a condition which results from excessive intake of alcohol. The person under its influence shows the following:

- i. Loss of control over his mental faculties.
- ii. Inability to perform the duties in which he is engaged.
- iii. Dangerous to himself or to others.

Consent for Examination

- The detained person should not be examined and blood, urine or breath should not be collected without his written consent.
- If the person becomes unconscious or incapable of giving consent, examination and treatment can be carried out, but the doctor should not disclose any information obtained during examination and wait for his consent, till he regains consciousness.
- Under **Sec. 53 (1) CrPC**, examination of an accused can be carried out by a doctor at the request of the police, even without his consent and by use of force, if necessary. Such examination may include taking of body fluids in cases of suspected intoxication.

Diagnosing a Case of Drunkenness

Preliminary data such as name, age, sex, address, time of examination, two identification marks and person escorting the patient should be noted.

History: The history of relevant events should be obtained from the person while observing him. Enquire about past illnesses and drug treatment. Note, if he admits

having taken alcoholic drinks. If so, the nature, quantity and time of consumption should be recorded.

Exclusion of Injuries and Pathological Conditions

Before diagnosing the case as drunkenness, it is better to rule out the following conditions which simulate alcoholic intoxication:

- Head injury.
- *Metabolic disorders:* Hypoglycemia, diabetic pre-coma, uremia and hyperthyroidism.
- *Neurological conditions:* Intracranial tumors, epilepsy, Parkinsonism and disseminated sclerosis.
- *Drug overdose:* Insulin, barbiturates, antihistamines, morphine, atropine, hyoscine and tranquillizers.
- *Psychological disorders:* Hypomania and general paresis.
- Exposure to carbon monoxide.

Clinical Examination

General appearance

- Manner of dressing—properly dressed or not, and soiling of clothes.
- Posture—whether over-erect and over smart, can stand steady or not, leans to a side or stoops forward and can stand without support or not.
- General behavior and attitude—sober, abusive, drowsy, alert, cooperative and self-controlling capacity.

General examination

The scalp should be inspected and palpated for evidence of any head injury.

Specific physical examination

- i. **Gait:** Staggering or normal. Whether he can walk straight and can take timely normal turn.
- ii. **Stance:** Whether he can stand easily with eyes closed and feet close together.
- iii. **Smell:** The smell of the breath may confirm that alcohol has been taken and the type of drink, but is no guide whatsoever to the amount.
- iv. **Handwriting:** If he can take a dictation, maintain a straight line, is missing words or letters or able to read his own handwriting. Patient can be asked to sign his name and compared with his driving license. Drawing simple patterns, such as triangle and diamond may be preferable, if the patient is not literate.
- v. **Speech:** Thick, slurred or over precise. Content, articulation and clarity is noted.
- vi. **Memory:** Recent and past events. A few simple sums of addition or subtraction may be asked.
- vii. **Muscle coordination:** The person can be asked to perform a few tests:

- *Finger nose test*: Ask the patient to touch the tip of nose by an outstretched hand, closing the eyes. Inability to perform suggests impaired coordination.
 - *Test of dexterity*, such as picking up small objects from the floor are preferable to walking on a straight line on the floor which even sober people may not be able to perform well.
 - When undressing for examination, the ability to undo buttons or any fumbling with zips should be noted.
- viii. **Eyes**: Drooping and swollen eyelids and congestion of conjunctiva may be seen.
- State of visual acuity (reading the time on a clock across a room).
 - Pupils—dilated, constricted or normal, and reaction of pupil to light.
 - Convergence test—negative in drunkenness (difficulty in convergence).
 - Strabismus—positive in drunken person.
 - Nystagmus—positive in drunken person.
- ix. **Skin**: Dry, moist, flushed or pale. It is warm, dry and flushed in drunkenness.
- x. **Mouth**: General state of mouth, teeth and tongue. Whether tongue is clean, coated, dry, furred or bitten.
- xi. **Pulse**: Count, volume and regularity. Pulse is rapid, full and bounding in a drunk.
- xii. **Blood pressure**: Normal, raised or low. Slight rise in BP may occur, often the systolic pressure in a drunk.
- xiii. **Respiration**: Hurried, slow, shallow, deep, stertorous, sighing, or gasping.
- xiv. **Reflex**: Deep reflex (knee/ankle)—normal, brisk or sluggish. Plantar reflex—extensor or flexor. All reflexes are sluggish. Plantar may be extensor/flexor type.
- xv. *Any tremor of fingers* of outstretched hands.
- **Liver**: Any enlargement and tenderness.
 - **Abdomen**: Ascites and edema.
 - **Heart**: Any abnormality.

Opinion

The report should be written at that time, and at the end the police informed about the doctor's opinion (based on examination and laboratory findings). The opinion can be drafted with any one of the following statements:

- i. He/she has not consumed alcohol.
- ii. He/she has consumed alcohol, but is not under the influence of it.
- iii. He/she has consumed alcohol and is under its influence.

Medico-legal Aspects

- **Sec. 85 IPC**: Nothing is an offence which is done by a person who at the time of doing it, by reason of intoxication, is incapable of knowing the nature of the act, or what he is doing is either wrong or contrary to law; provided that thing which intoxicated him was administered to him without his knowledge or against his will.
- Voluntary drunkenness is not an excuse for commission of crime.
- **Sec. 510 IPC**: Misconduct by a drunken person in public is punishable with imprisonment upto 24 h.

Driving under the influence of alcohol or drunk driving:

- Operating a motor vehicle after having consumed alcohol or other drugs to the degree that mental and motor skills are impaired.
- Authorities around the world have laid down their own standards for permissible maximum BAC (Table 48.2).
- In India, according to **Motor Vehicles Act 1988**, for the first offence, punishment is imprisonment of 6 months and/or fine of ₹ 2000. If a second offence is committed within 3 years, the punishment is 2 years and/or fine of ₹ 3000. Under this Act, there can be arrest without warrant, a breath test and a laboratory test can also be carried out.
- The government has cleared a proposal to amend the Act. Drunk driving will be graded according to blood alcohol level. The penalty remains unchanged till BAC of 60 mg/dl (as mentioned above). In case of BAC 60-150 mg/dl, imprisonment is for 1 year and/or fine ₹ 4000. If offence is repeated within 3 years, imprisonment is for 3 years and/or ₹ 8000. In case of BAC > 150 mg/dl, imprisonment is for 2 years and/or fine ₹ 5000. If the offence is repeated, imprisonment is for 4 years and fine of ₹ 10000, besides cancellation of license.
- The *age for possession and consumption of alcoholic beverages* in Australia and Canada is 18 years, in European countries, it is between 16-18 years, in US, it is ≥ 21 years and in India, it is between 18-25 (varies between states).

Laboratory Investigations

The common laboratory tests include estimation of alcohol from:

- i. Blood
- ii. Urine
- iii. Breath
- iv. Vitreous fluid, bile and other tissues (during autopsy)

Measurement of Alcohol

- The *BAC* is *the most useful measure*, as there is rapid equilibration across the blood-brain barrier, therefore BAC reflects the concentration of alcohol currently affecting the brain.

Table 48.2: Permissible BAC in different countries

Permissible BAC (mg/dl)	Countries
0	Hungary, Pakistan, Saudi Arabia, UAE
20	Norway, Poland, Sweden
30	India, China, Japan ²³
50	Australia, France, Germany, Italy, Spain Netherlands, Russia, Denmark
80	Canada, UK, US (100 mg/dl in some states)

- The *urine alcohol* is more concentrated than blood level, due to tubular resorption of water in the ratio of 1.3: 1. However, it is less useful, as the ureteric urine concentration varies with rising or falling BAC and as all the urine from the kidneys is pooled in the bladder, that obtained from later micturition can only give a mean value over the period of excretion. This can be further distorted by urine already present in bladder or excreted before drinking began.
- *Breath alcohol*, unlike urine, is in equilibrium with blood, even though in a very small concentration of about 1: 2300. At 37°C, a level of 1 mg/dl in blood will be equivalent to about 0.43 µg/dl in breath. The exact ratio of blood/breath alcohol is temperature dependent and varies slightly with other factors, such as the depth of respiration and concentration of alcohol.

Widmark's formula is used to estimate blood alcohol level.²⁴

$$a = cpr$$

where a – the total amount of alcohol (in grams) absorbed in the body

c – the concentration of alcohol in blood (in g/kg)

p – the weight of the person (in kg)

r – constant (0.68 in men and 0.5 in women)

Alcohol level from urine is estimated with the formula:

$$a = 3/4 qpr$$

where q – concentration of alcohol in urine (in g/l) and ' a ', ' p ' and ' r ' are same as above.

Kozelka and Hine method or Cavett method: It involves aeration/distillation or diffusion of alcohol under low pressure. It utilizes the principle that alcohol is easily oxidized to acetic acid by oxidizing agents, such as potassium dichromate and sulphuric acid.

Other methods:

- Gas liquid chromatography (GLC): Most reliable method.²⁵ It is extremely sensitive and produces

accurate quantitative results. In high performance liquid chromatography (HPLC), the sample is in liquid state at the time of analysis, rather than in volatile state as in GLC*

- Alcohol dehydrogenase (ADH) method: It is highly specific and accurate.

Any method to determine ethanol in blood and urine can be classified into:

- Macro (requiring 1-2 ml of specimen)
- Micro (requiring 0.1-0.2 ml of specimen or less)

The methods are:

- Chemical:** Widmark method, Cavett method
- Biochemical:** ADH method
- Physical:** GLC

- **Chemical methods:** It depends on reduction of a dichromate/sulphuric acid by alcohol vapor.

a. *Widmark method* (original): Micro-method, alcohol from sample distills slowly into dichromate in a small closed vessel.

b. *Cavett method:* Modification of Widmark, using different chemical reaction to determine the amount of alcohol.

c. *Nickolls method:* Macro-method, similar to Cavett.

d. *Southgate and Carter method:* Macro-method, sample is evaporated in an air stream and the air passing through the hot dichromate reagent which absorbs the alcohol vapor.

e. *Kozelka and Hine method:* Macro-method, alcohol is distilled in a current of steam. The steam is condensed after passing through a reagent which traps interfering substances and the alcohol in the condensate is determined by reduction of dichromate. It is more specific than other chemical methods as interfering substances are removed.

- **Biochemical method:** *ADH method:* Micro-method, alcohol is oxidized by the ADH enzyme in the presence of a coenzyme; the reduced coenzyme is then determined calorimetrically by a separate method, from the result of which the alcohol content of the original sample is calculated.

- **Breathalyzer** (or breath analyzer) is a device for estimating BAC from a breath sample. In 1954, *Dr Robert Borkenstein* invented the breathalyzer which used chemical oxidation and photometry to determine alcohol concentration (breath passes through a solution of potassium dichromate, which oxidizes ethanol to acetic acid, changing color in the process). Subsequent breathalyzers have converted primarily to *infrared spectroscopy*.

The invention of the breathalyzer provided law enforcement with a non-invasive test with immediate results to determine an individual's BAC at the time of testing.

Collection of Samples in Living

- **Blood:** Soap and water is used to clean the site to be venepunctured. The blood is collected from antecubital

* Gas Chromatography-Mass Spectrometry (GC-MS) is the only method of analysis that is 100% specific.

or femoral vein using a disposable syringe. Blood container should be tightly stoppered to prevent loss of alcohol by evaporation and labeled with name, date, time of taking the specimen and signature of the medical officer.

- **Urine:** Full quantity of urine passed must be collected. The patient is asked to pass urine in a toilet where there is no water source (preventing him to dilute alcohol concentration by adding water). It is collected in a large clean, sterilized, screw capped bottle. The urine is preserved and labeled with name, date, time of taking the specimen and signature of the medical officer.
- **Breath:** The patient is asked to blow into a rubber balloon. A breathalyzer then analyzes the breath.

Postmortem Samples

Details are given in Chapter 6.

In temperate climates, postmortem blood alcohol determination is completely valid for 36 h after death.

Erroneous BAC results can be obtained due to:

- Postmortem diffusion from other body fluids and tissues
- Samples stored at room temperature for more than a week
- Improperly preserved sample
- Hemolysis
- Clot formation
- Putrefaction

Methyl Alcohol (Methanol)

Introduction: Methanol (carbinol, wood alcohol, wood naphtha or wood spirits) is found in cleaning materials, solvents, paints, varnishes, formaldehyde solutions, antifreeze, windshield washer fluid (30-40% methanol), and duplicating fluids.

Physical properties: Colorless, volatile liquid with odor similar to ethyl alcohol and a burning taste.

Uses: In industries as solvent, in laboratories with ethanol as an antiseptic spirit.

Absorption and Excretion

It is rapidly absorbed from the stomach, intestines, lungs and skin, and achieves a maximal concentration 30-90 min after ingestion.

- Oxidation is slow, 15% of that of ethyl alcohol, and acts as a cumulative poison.

- During metabolism, it is converted into formaldehyde and formic acid which is metabolized to folic acid, folinic acid, carbon dioxide and water (Flow chart 48.2).
- Eighty percent is excreted unchanged from lungs and 3-5% in urine.
- Without competition for alcohol dehydrogenase, methanol undergoes zero-order metabolism and is excreted at a rate of 8.5-20 mg/dl/h. Once methanol experiences competitive inhibition from ethanol or fomepizole, the metabolism changes to first order.

Action

It causes ethanol-like CNS depression and increased serum osmolality. Formic acid causes a high anion-gap metabolic acidosis and retinal toxicity.²⁶⁻²⁸

Signs and Symptoms

- Symptoms occur 12-24 h after ingestion. Unlike ethanol or isopropanol, methanol does not cause much of an inebriated state.
- Initially, the symptoms from methanol intoxication are similar to those of ethanol, often with disinhibition and ataxia.

System	Signs and symptoms
GIT	Nausea, vomiting, cramps in abdomen, spirit-like odor in the nostrils and mouth, dehydration.
RS	Dyspnea, cyanosis, respiratory depression.
CNS	Headache, dizziness, vertigo, restlessness, muscular weakness, hypothermia, delirium, amnesia, convulsion (terminal event), coma.
Renal	Strongly acidic urine, acidosis, scant urine.
Ocular	Pupils: Fixed and dilated. Visual disturbances, like photophobia, blurred or misty vision (<i>snowfield vision</i>), central or peripheral scotoma, decreased light perception, concentric diminution of visual fields causing temporary or complete blindness due to optic neuritis and atrophy from accumulation of formic acid within the optic nerve. Retinal edema and hyperemia may be seen.
Pancreas	Pancreatitis may occur.

Flow chart 48.2: Metabolism of methanol

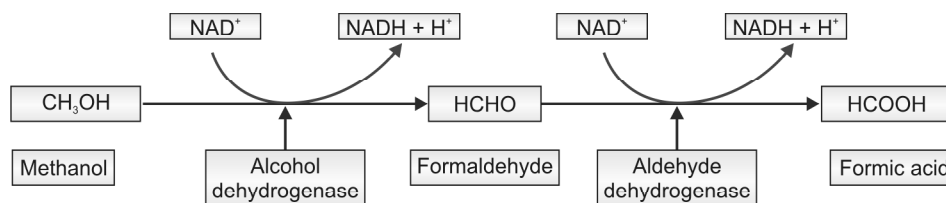

Levels > 20 mg/dl are considered toxic and treatment should be initiated based on blood levels alone.

Fatal dose: Range is 30-240 ml, but 60-140 ml is usually fatal (> 150 mg/dl in blood).

Fatal period: 24-36 h.

Treatment²⁷⁻²⁹

- i. *Preventing absorption by gastric lavage:* Five percent sodium bicarbonate solution is used and 500 cc is left in the stomach.
- ii. *Use of bicarbonate to combat acidosis:* Oral administration of sodium bicarbonate, 2 g in 250 ml of water, 4 hourly.
- iii. *Folate therapy:* Calcium folinate/leucovorin (calcium salt of folinic acid) IV tends to reduce blood formate levels by enhancing its metabolism. High dose of folinic acid (50-75 mg every 6 hourly) is indicated. Thiamine and pyridoxine may be given. Vitamin B₁₂ is not used.
- iv. *Administration of ethanol as competitive antagonist:* Loading dose of 0.8-1 ml/kg orally of 95% ethanol (v/v) in 200 ml of orange juice or 7.6-10 ml/kg IV of 10% ethanol (v/v) in D5W over 30 min, and then maintenance dose of 0.15 ml/kg/h orally or 1.4 ml/kg/h IV. Desired serum ethanol concentration is 100-150 mg/dl.
- v. *Antidote:* 4-methylpyrazole (**fomepizole**) is a competitive inhibitor of alcohol dehydrogenase. It blocks the formation of formaldehyde and formic acid and can be used instead of ethanol. Loading dose of 15 mg/kg over 30 min, followed by 10 mg/kg every 12 h for 4 doses, then 15 mg/kg every 12 h.
- vi. *Other measures*
 - Eyes should be kept covered to protect them from light.
 - *Hemodialysis* as soon as possible in case of severe poisoning.
 - Symptomatic treatment.

Postmortem Findings

External

Signs of asphyxia with cyanosis and prominent postmortem staining are observed. Froth from the mouth may be seen. Pyridine may give the skin a purple color.

Internal

- i. *GIT:* Mucous membrane of stomach and duodenum are congested and inflamed with small hemorrhages.
- ii. *Lungs:* Congested and edematous.

- iii. *Liver:* Necrobiosis and fatty change.
- iv. *Kidneys:* Tubular degeneration.
- v. *Brain:* Edematous and focal hemorrhages.
- vi. *Urinary bladder:* Mucosa congested.
- vii. *Blood:* Dark and fluid.

Medico-legal Aspects

- Mostly accidental, due to consumption of cheap illicit liquor containing methyl alcohol (which is often a component of 'bootlegged alcohol') by lower socio-economic classes that results in '*hooch tragedy*'.*
- Sometimes, it is used as intoxicating beverage when ethanol is not available.
- Suicides and homicides may occur, but not common.
- Accidental poisoning may be seen in children as methanol is a constituent of commonly available liquids.

• **Metabolic acidosis** is reduction in HCO_3^- with compensatory reduction in PCO_2 ; pH may be low or slightly subnormal. It is categorized as *high or normal anion gap* based on the presence or absence of unmeasured anions in serum. Causes include accumulation of ketones and lactic acid, renal failure and drug or toxin ingestion (high anion gap); and GI or renal HCO_3^- loss (normal anion gap).

Signs and symptoms include nausea and vomiting, lethargy, and hyperpnea. *Diagnosis* is clinical and with ABG and serum electrolyte measurement. The cause is treated; IV NaHCO_3 may be indicated when pH is very low.

- *Toxins causing high-anion gap acidosis:* Alcohol, methanol, ethylene glycol, paraldehyde and salicylates. Lactic acidosis may be caused by carbon monoxide, cyanide and iron.^{30,31}
- Most common cause of normal anion gap acidosis is diarrhea followed by renal tubular acidosis.³¹
- Any alcoholic beverage made under unlicensed conditions is called **illicit liquor**. Usually sub-standard raw material is used; often this is spiked with other chemicals. Under unregulated conditions, methanol may be produced along with ethanol. Sometimes, industrial methyl alcohol or denatured spirit is added by illicit brewers to save costs and in mistaken belief that it will increase potency. There have been incidents where chemicals like OPCs have been added to illicit liquor. Gujarat is the only state in India that has death penalty for those found guilty of making and selling spurious liquor.
- Although the eye is the primary site of organ toxicity, in the later stages specific changes may be seen in the basal ganglia.
- If vision is impaired, ocular examination may reveal dilated pupils that are unreactive to light with hyperemia of the optic disc. After several days, the red disc becomes pale and the patient may become blind. Typically, subjective complaints precede physical findings in the eye.

* The term '*hooch*' for liquor comes from the Hoochinoo Indians, known for their ability to make liquor so strong, it could knock someone out.

Isopropyl Alcohol

Isopropanol is found in rubbing alcohol (70% isopropanol), antifreeze, skin lotions, mouthwashes and home cleaning products.

Physical properties: It is a colorless, volatile liquid with a faint odor of acetone, and is slightly bitter in taste.

Metabolism: It is well absorbed through the mucous membrane of the respiratory tract and GIT, and reaches a peak concentration approximately 30-120 min after ingestion. It is metabolized in the liver and converted to acetone which is excreted in the urine and breath.

Action: It is 2-3 times more potent than ethanol and more toxic than methyl alcohol. Both the CNS depressant effects and the fruity odor on the patient's breath are due to acetone.

Signs and Symptoms

- The primary toxicity with isopropanol is CNS depression.
- Unlike methanol and ethylene glycol, isopropanol does not cause a metabolic acidosis.³⁰
- It causes hypotension, cerebral depression and drunkenness. There is loss or sluggishness of reflexes. Pupils are constricted in coma. There are signs of renal damage.
- Death from ingestion of isopropanol is uncommon.

Fatal dose: 250 ml (> 100 mg/dl in blood).

Fatal period: Few hours.

Treatment: Similar to methanol.

Postmortem Findings

- **Externally**, non-specific findings.
- **Internally**, the organs are congested. Lungs and kidneys are congested and edematous. There may be renal degeneration.

Medico-legal aspects: Poisoning is accidental, mostly by way of external medicinal use.

Ethylene Glycol

Ethylene glycol is the major constituent of antifreeze solutions. It is a clear, colorless, odorless, non-volatile

liquid with a bitter-sweet taste. It is not absorbed through the skin.

Action: Ethylene glycol itself is not toxic, but the toxicity is due to metabolites glycolic and oxalic acids which inhibits oxidative phosphorylation.

- Oxalic acid combines with calcium to form calcium oxalate crystals which accumulates in the proximal convoluted tubules causing renal failure.
- Metabolic acidosis occurs from glycolic acid.

Signs and Symptoms³²

It can be divided into neurological, cardiorespiratory and renal.

- **CNS symptoms** usually develop within half hour to 12 h after ingestion. The individual develops nausea, vomiting, slurred speech, tipsy sensation, severe headache, delusions, dizziness, feeling of breathlessness, convulsions and coma.
- **Cardiorespiratory symptoms** usually appear 12-24 h after ingestion. Tachycardia, tachypnea and congestive heart failure are present.
- **Renal:** Acute tubular necrosis. This usually is seen 24-72 h after ingestion. Oxalate crystals are seen in the urine.

Death occurs from renal failure or heart attack.

Fatal dose: 100-200 ml.

Fatal period: Few hours to 3 days.

Treatment: Gastric lavage is done. Charcoal is not very effective. Treatment is similar as for methanol.³³

Postmortem Findings

Non-specific findings.

- Organs are congested.
- Mucous membrane of the GIT is congested and inflamed.
- Cerebral edema, chemical meningo-encephalitis, liver and kidney damage may be seen.
- Oxalate crystals are seen in the brain, spinal cord and kidneys.

Medico-legal aspects: Poisoning is accidental or suicidal in nature.

MULTIPLE CHOICE QUESTIONS

1. Safe limit of alcohol consumption in males and females are:
AFMC 11
A. 15 and 10 units/week
B. 18 and 15 units/week
C. 21 and 14 units/week
D. 25 and 18 units/week

2. Blackout is due to:
A. Alcohol intoxication
B. Cocaine toxicity
C. LSD toxicity
D. Cyanide poisoning

Maharashtra 11

3. In holiday heart syndrome, most common feature seen is: *Orissa 09*
 A. Atrial fibrillation
 B. Atrial flutter
 C. Ventricular fibrillation
 D. Ventricular flutter
4. Arrhythmia most commonly associated with alcohol binge in the alcoholics: *DNB 10*
 A. Ventricular fibrillation
 B. Ventricular premature contractions
 C. Atrial flutter
 D. Atrial fibrillation
5. Korsakoff's psychosis is seen in: *PGI 05*
 A. CRF
 B. Chronic alcoholism
 C. Marasmus
 D. Cirrhosis
6. Disulfiram is useful in: *TN 11*
 A. Alcohol dependence
 B. Heroin dependence
 C. Cocaine dependence
 D. Cannabis dependence
7. Disulfiram: *JIPMER 10*
 A. Inhibits alcohol dehydrogenase
 B. Inhibits aldehyde dehydrogenase
 C. Both A & B
 D. Inhibits phosphodiesterase
8. Drug that inhibits aldehyde dehydrogenase is: *TN 05*
 A. Disulfiram
 B. Phenytoin
 C. Valproate
 D. Erythromycin
9. Disulfiram-like reaction is caused by: *Kerala 11*
 A. Acamprostate
 B. Metronidazole
 C. Tetracycline
 D. Digitalis
10. Most common symptom of alcohol withdrawal is: *AI 07; FMGE 08*
 A. Bodyache
 B. Tremor
 C. Diarrhea
 D. Rhinorrhea
11. CAGE questionnaire is used in: *TN 04; AP 07; MP 09*
 A. Alcohol dependence
 B. Opiate poisoning
 C. Dhatura poisoning
 D. Barbiturate poisoning
12. Delirium tremens seen in: *DNB 10*
 A. Alcohol withdrawal
 B. Alcohol intoxication
 C. Opioid intoxication
 D. Opioid withdrawal
13. All are true about delirium tremens, except: *PGI 05; NIMHANS 10; AI 11; FMGE 11*
 A. Normal sleep wake cycle
 B. Visual hallucinations
 C. Coarse tremors
 D. Clouding of consciousness
14. Delirium tremens is characterized by confusion associated with: *AI 03*
 A. Autonomic hyperactivity and tremors
 B. Sixth nerve palsy
 C. Features of intoxication due to alcohol
 D. Korsakoff's psychosis
15. A 40-year-old alcoholic is brought to the emergency with acute onset of seeing snakes all around him, not recognizing family members, violent behavior and tremulousness after having missed alcohol since 2 days. Examination reveals increased blood pressure, tremors, increased psychomotor activity, fearful effect, hallucinatory behavior, disorientation, impaired judgment and insight. He is most likely to be suffering from: *AIIMS 03; AI 03, 05*
 A. Alcoholic hallucinosis
 B. Delirium tremens
 C. Wernicke's encephalopathy
 D. Korsakoff's psychosis
16. A 45-year-old male with a history of alcohol dependence presents with confusion, nystagmus and ataxia. Examination reveals 6th cranial nerve weakness. He is most likely to be suffering from: *AI 05; FMGE 10*
 A. Korsakoff's psychosis
 B. Wernicke encephalopathy
 C. De Clerambault syndrome
 D. Delirium tremens
17. The following is not a feature of Wernicke's encephalopathy: *Karnataka 04*
 A. Lateral rectus palsy
 B. Paralysis of conjugate gaze
 C. Pupillary dilatation
 D. Nystagmus
18. Wernicke-Korsakoff's syndrome is due to the deficiency of: *FMGE 10; JIPMER 10*
 A. Pyridoxine
 B. Thiamine
 C. Vitamin B₁₂
 D. Riboflavin
19. Vitamin deficiency seen in alcoholic with dementia: *AP 08; Maharashtra 09*
 A. Thiamine
 B. Vitamin B₁₂
 C. Riboflavin
 D. Pyridoxine
20. A 55-year-old man presents with a 10 day history of confusion. His friend mentions that he drinks 15 units of alcohol per day. Which of the following strongly suggests a diagnosis of Korsakoff's psychosis: *Karnataka 07; Jharkhand 11*
 A. Delusional beliefs
 B. Poor long-term memory
 C. Auditory hallucinations
 D. Confabulation

3. A 4. D 5. B 6. A 7. B 8. A 9. B 10. B 11. A 12. A
 13. A 14. A 15. B 16. B 17. C 18. B 19. A 20. D

21. **Area of the brain is usually not involved in Wernicke-Korsakoff syndrome:** *Karnataka 11*
 A. Periventricular gray matter
 B. Mammillary bodies
 C. Hippocampus
 D. Thalamus
22. **True about alcohol paranoia:** *AI 10*
 A. Tremors
 B. Fixed hallucinations
 C. Fixed delusions
 D. Wrist and foot drop
23. **In India, driving under influence is considered at blood alcohol level of:** *MAHE 06*
 A. ≥ 20 mg% B. ≥ 30 mg%
 C. ≥ 50 mg% D. ≥ 100 mg%
24. **Widmark's formula is used for measurement of blood levels of:** *PGI 03; NIMHANS 10*
 A. Benzodiazepines B. Barbiturates
 C. Alcohol D. Cocaine
25. **The most reliable method of estimating blood alcohol level is:** *AI 04; Kerala 09*
 A. Cavett's test
 B. Breath alcohol analyzer
 C. Gas liquid chromatography
 D. Thin layer chromatography
26. **In methyl alcohol poisoning, CNS and cardiac depression and optic nerve atrophy are due to:** *AI 05*
 A. Formaldehyde and formic acid
 B. Acetaldehyde
 C. Pyridine
 D. Acetic acid
27. **In contaminated liquor poisoning, all of the following are true, except:** *JIPMER 10*
 A. Metabolic alkalosis
 B. Blindness
 C. Treatment is with ethanol
 D. Toxicity is due to methanol
28. **True about blindness due to methanol poisoning are all, except:** *AI 03; PGI 04*
 A. Due to direct effect of formic acid
 B. Fomepizole, a specific alcohol dehydrogenase inhibitor is helpful
 C. Ethanol is useful to prevent blindness
 D. Gastric lavage is not helpful
29. **Antidote for methanol:** *TN 05*
 A. Ethanol B. BAL
 C. EDTA D. None
30. **All causes metabolic acidosis, except:** *Kerala 07*
 A. Methanol B. Ethanol
 C. Salicylate D. Isopropanol
31. **High anion gap acidosis is seen in all the following, except:** *DNB 10; Orissa 11*
 A. Diabetic ketoacidosis
 B. Lactic acidosis
 C. Renal tubular acidosis
 D. Methanol poisoning
32. **A 2-year-old boy presents with fever for 3 days which responded to administration of paracetamol. Three days later he developed acute renal failure, marked acidosis and encephalopathy. His urine showed plenty of oxalate crystals. The blood anion gap and osmolal gap were increased. Most likely diagnosis is:** *AIIMS 05; PGI 06*
 A. Paracetamol poisoning
 B. Ethylene glycol poisoning
 C. Severe malaria
 D. Hanta virus infection
33. **Antidote for ethylene glycol poisoning:** *PGI 04; DNB 09; Punjab 12*
 A. Methyl violet
 B. Fomepizole
 C. Fluconazole
 D. Ethyl alcohol

Barbiturates

49

Introduction: Barbiturates are used as sedatives, hypnotics, anticonvulsants, anesthetics and tranquilizers. Commonly abused barbiturates are secobarbital, pentobarbital and amobarbital. In recent years, their use has decreased markedly as benzodiazepines have replaced barbiturates for a majority of clinical indications.

Physical properties: It is a white, crystalline, odorless powder and bitter in taste.

Synonyms: Sleeping pills, goof balls, yellow jackets, red devils, bluebirds and downers.

Classification

Barbiturates are chemical derivatives of barbituric acid and depending on their duration of action, they can be classified as:

Long acting (8-24 h)	Short acting (3-6 h)	Ultra-short acting (0.5-2 h)
Phenobarbital	Butobarbital	Thiopental
Mephobarbital	Secobarbital	Methohexital
Pentobarbital	Hexobarbital	Thiamylal

Action

- Barbiturates act at the GABA: BZD receptor—Cl⁻ channel complex and potentiate GABAergic inhibition by increasing the lifetime of Cl⁻ channel opening induced by GABA.
- At very high concentration, it directly increases Cl⁻ conductance and inhibit Ca²⁺ dependent release of neurotransmitters.
- It also depresses the Na⁺ and K⁺ channels.

Absorption and Metabolism

- After oral/rectal administration, absorption is usually rapid and complete. The rate of absorption is increased when the barbiturate is formulated as a liquid, when the stomach is empty and when alcohol is ingested concurrently. After IV administration, the onset of action is immediate for amobarbital and pentobarbital and within 5 min for phenobarbital.
- Once absorbed, the barbiturates are rapidly distributed to all tissues and fluids. High

concentrations are seen in the brain, liver and kidneys.

- Barbiturates are slowly metabolized in the liver, and these metabolites are mostly inactive, water-soluble and excreted in the urine. Only small amounts of barbiturates are excreted unchanged by the kidney.

Signs and Symptoms

System	Signs and symptoms
CNS	Drowsiness, mumbling of speech, clumsy movement, trembling, unsteady gait, nystagmus, disorientation, stupor, delirium, hallucinations, ataxia, coma with loss of superficial and deep reflexes and gradual loss of response to painful stimuli. Babinsky toe sign may be positive, pupils are constricted, but react to light.
RS	Rapid and shallow or slow and labored breathing with reduced minute volume. Respiration may be irregular, sometimes Cheyne-Stokes in character.
CVS	Hypotension, cyanosis, bradycardia, fall in cardiac output, cold clammy skin.
MS	Flaccid, tonicity of muscles is lost.
Renal	Urine scanty or suppressed, dark in color and may contain sugar, albumin and hemtoporphyrin. Incontinence may occur.
Skin	Blisters (<i>barbiturate blisters</i>) are found on the skin (friction areas, such as axilla, inner aspects of knee, calf and interdigital clefts). Blisters contain serous fluid and on rupture, leave a red, raw surface which dries to a brown parchment-like area.
Others	Hypothermia (as low as 31°C), fever indicates bronchopneumonia.

Death may be due to respiratory failure or ventricular fibrillation in early stages, and bronchopneumonia or pulmonary edema in later stages.

Fatal dose and blood level

Category	Fatal dose	Blood level
• Ultra-short acting	1-2 g	3 mg/dl
• Short-acting	2-3 g	7 mg/dl
• Long acting	3-5 g	10 mg/dl

Fatal period: 1-2 days.

Management

History

- Acute barbiturate intoxication should be clinically evaluated to differentiate it from other forms of coma or CNS injury.
- History of possible trauma, associated ingestion of alcohol, previous psychiatric illnesses and attempts at suicide and drug usage should be obtained.
- The effect of barbiturates is potentiated by alcohol, narcotics, tranquilizers and antidepressants.

Diagnosis

- Urine, gastric lavage and blood are specimens of choice. Quantify serum alcohol and barbiturate concentrations (particularly phenobarbital). A urine drug screen may help establish co-ingestants.
- Some capsules may be suggestive by color—pentobarbital: yellow or brown, seconal: red, amytal: blue, tuinal: blue and red.

Treatment

The management of barbiturate poisoning is supportive. Maintenance of ABC is vital for patient survival. Once the patient is stabilized, gut decontamination and elimination enhancement is done.

- Airway support:** Mechanical ventilation with O₂ (artificial respiration) is given.
- Cardiovascular support:** Hypotension responds to crystalloid bolus and vasopressors (dopamine or norepinephrine) are rarely required.
- Decontamination and elimination enhancement**
 - Gastric lavage with KMnO₄ and activated charcoal is administered 2-4 h apart as barbiturates re-enter the GIT through enterohepatic circulation.
 - Bowels are evacuated by enema.
 - *Forced alkaline diuresis* by sodium bicarbonate (2-3 ampoules) in 1 litre of 5% dextrose with rate of infusion at 30 ml/kg/h and guided by urinary pH which should be maintained between 7.5 and 8 and an arterial pH of < 7.5. The goal is to maintain an urine output of 150-250 ml/h.¹
 - *Extracorporeal drug removal:* Hemodialysis or hemoperfusion is indicated in phenobarbital poisoning.
- Other measures**
 - Patient is kept warm (passive rewarming) and mucus removed from throat.
 - Endotracheal intubation for first 3 days, but after this tracheostomy should be done.

- Good oral hygiene, temperature maintenance, posture change at regular intervals, antibiotics and symptomatic treatment.

- Urinary alkalization enhances the elimination of phenobarbital and other long acting barbiturates by ion trapping in renal tubular cells, but it is not recommended as first line treatment (as multiple-dose activated charcoal is superior) or for short acting barbiturate toxicity.¹
- **Analeptic drugs:** Earlier analeptics were used in the treatment of barbiturate overdose. They are nonspecific arousal agents such as strychnine, camphor, caffeine, picrotoxin, pentylenetetrazol, nikethamide, amphetamine, megride and methylphenidate. The principal goal of analeptic therapy was to awaken the patient. Adverse effects such as hyperthermia, dysrhythmias, seizures and psychoses were associated with its use.
- **Scandinavian method:** *Nilsson and Clemmesen* proposed this conservative procedure which abandoned the use of analeptics in the treatment of barbiturate poisoning. It consists of gastric lavage, oxygen, prophylactic antibiotics, determining fluid balance, administration of vitamins, administration of heat or cold for hypo- or hyperthermia respectively, and prevention of bed or eye sores and mouth lesions.

Postmortem Findings

External

- Mainly those of asphyxia.
- Cyanosis is present.
- Froth is seen from the mouth and nostrils.
- Congested face and prominent postmortem staining.
- Barbiturate blisters may be seen.

Internal

- Stomach:** White particles may be seen. Gastric mucosa may be eroded. Fundus may be thickened, granular and hemorrhagic.
- Lungs:** Congested and edematous. Broncho-pneumonia, and/or petechial hemorrhages may be present.
- Heart:** Subendocardial hemorrhages may be seen.
- Kidneys:** Degeneration of convoluted tubules.
- Other organs:** Congested.

Medico-legal Aspects

- Mostly suicidal, rarely homicidal.
- Accidental poisoning occurs due to an overdose (*automatism*).
- Addiction due to excessive use of barbiturates.
- *Occupational hazards:* Barbiturates may impair the mental and/or physical abilities required for the performance of tasks, such as driving a vehicle or operating machinery. Patients should be warned accordingly.

- Following the use of barbiturates in OPD procedures, patients should be warned against driving vehicles for the rest of the day.

Barbiturate Automatism (Self-poisoning)

Definition: It is taking of barbiturate tablets repeatedly, because of mental confusion.

Cause: The patient develops a state of toxic delirium after ingestion of one or several doses of drug, and in the delirium or automatism state, takes additional doses of drug in order to get to sleep without any intention to commit suicide and without realizing it.

Medico-legal aspects: Barbiturate automatism may be more pronounced with alcohol consumption.

- Barbiturate in high doses is used for physician-assisted suicide, and in combination with a muscle relaxant for euthanasia and for capital punishment by lethal injection.
- Thiopental is used IV for the purposes of euthanasia. The Belgians and the Dutch have created a protocol that recommends sodium thiopental as the ideal agent to induce coma, followed by pancuronium bromide.
- Barbiturates including thiopental (sodium pentothal) and sodium amytal (amobarbital) are used as a 'truth serum'.

MULTIPLE CHOICE QUESTION

1. Alkalization of urine is done in which poisoning:

AI 08

- A. Barbiturates
- B. Amphetamine
- C. Alcohol
- D. Cocaine

Deliriant—*Datura/Datura*

50

Plants that contain the tropane alkaloids include the following:

- *Datura* species
- *Atropa belladonna* (deadly nightshade)
- *Hyoscyamus niger* (henbane)
- *Mandragora officinarum* (mandrake)

A subgroup of the alkaloids is the alkaloid amines. The three major groups of alkaloid amines are:

- Hallucinogenic alkaloid amines
- Stimulant alkaloid amines
- Anticholinergic tropane alkaloids (belladonna alkaloids or bicyclic alkaloids)

Dhatura/Datura

Introduction: Dhatura, a member of the Solanaceae family and belongs to the genus *Datura*, which consists of many species, e.g. *Datura ferox*, *Datura alba*, *Datura fastuosa*, etc.

Common names: Thorn apple (fruits are spherical and have sharp spines), jimson weed, Hell's bells and devil's trumpet (for their large trumpet-shaped flowers).

Toxic part: All parts of these plants are poisonous—fruit, flowers and seeds (highest concentrations of alkaloids are found in roots and seeds). The seeds resemble chilly seeds (Diff. 50.1). Poisoning occurs only if seeds are masticated and swallowed.

Differentiation 50.1: Dhatura and capsicum seeds

S.No.	Feature	Dhatura seeds	Capsicum seeds
1.	Size	Large and thick	Small and thin
2.	Shape	Kidney-shaped	Rounded
3.	Color	Dark brown	Pale yellow
4.	Convex border	Double edge	Single edge
5.	Smell	Odorless	Pungent
6.	Surface	Small depression	Smooth
7.	Taste	Bitter	Pungent
8.	On cut section (LS) (Fig. 50.1)	Embryo curved outward	Curved inwards like figure '6'

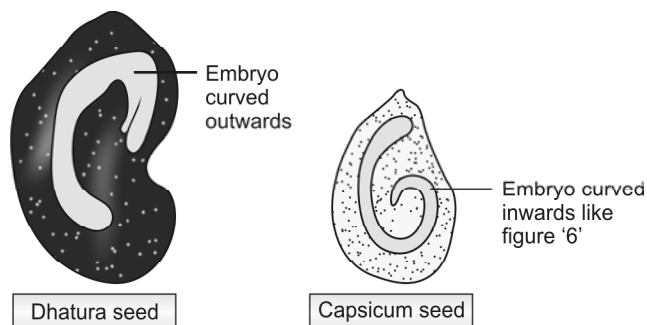

Fig. 50.1: Longitudinal section of dhatura and capsicum seed (For color version see Plate 6)

Active Principles¹

- Hyoscine (scopolamine): 0.2-1.4%
- Hyoscyamine
- Atropine: Traces

Action

- Atropine and hyoscine block the acetylcholine receptor and produces sympathomimetic or parasympatholytic actions.
- CNS stimulant in early phase, but later CNS depression occurs, especially of the respiratory centre.
- Vagolytic action resulting in stimulation of the heart.

Absorption and Excretion

- The alkaloids are absorbed through the mucous membrane of the GIT and respiratory tract, and through the skin and conjunctiva.
- It is destroyed in the liver by enzyme atropinase.
- Part of it is excreted through the urine.

Signs and Symptoms

Symptoms are seen 30-60 min after ingestion and may continue for 24-48 h because tropane alkaloids delay gastric emptying and absorption. It can be summarized as 9 D's:²⁻⁴

- Dryness of the mouth (dry as a bone)*, bitter taste, burning pain in stomach and vomiting.

- ii. *Dysphagia* (difficulty in swallowing).
- iii. *Dysarthria* (difficulty in talking) due to inhibition of salivation.
- iv. *Dilatation of cutaneous blood vessels (red as a beet)*. Face is flushed and conjunctiva congested.
- v. *Diplopia* due to dilated pupil with loss of accommodation for near vision, developing into temporary blindness (*blind as a bat*) and photophobia (Fig. 50.2). Light reflex is sluggish, and later absent.
- vi. *Dry hot skin (hot as a hare)* due to inhibition of sweat and stimulation of heat regulating centre. Temperature is raised by 1-2°C.
- vii. *Drunken gait*: There is giddiness, confusion, restlessness, agitation and unsteady gait, the patient staggering like a drunken individual.
- viii. *Delirium (mad as a wet hen)*: Mutters indistinct words, exhibits typical **pill-rolling movements**, pull imaginary threads from fingertips, picks at clothes and tries to run away from his bed. Visual and auditory hallucinations may be present. Patient cannot recognize relatives and friends.
- ix. *Drowsiness*: Delirium passes off and patient becomes drowsy, may progress to stupor, coma or rarely to death from respiratory paralysis. Moreover, there may be:
 - Diminished bowel sounds.
 - Distention of urinary bladder due to urinary retention.
 - Rapid pulse (120-140/min), full and bounding, but later becomes weak and irregular.
 - Increased respiration.
 - Scarlatiniform rash over the body.
 - Amnesia regarding events following ingestion is common.

Fatal dose

- Seeds: 75-125 (stupefying dose: 40-50 seeds).
- Hyoscine: 15-30 mg.

Fatal period: 24 h.

Differential diagnosis: Drunkenness and heat stroke.

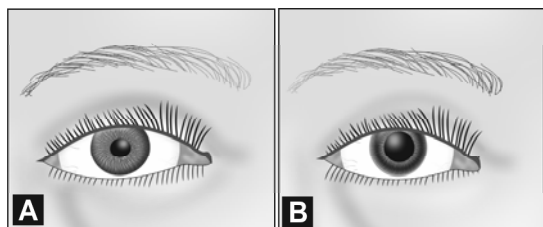

Fig. 50.2: (A) Normal pupil, (B) Dilated pupil

Treatment

- i. Emetics.
 - ii. Gastric lavage with tannic acid, KMnO_4 or activated charcoal. First dose of activated charcoal may be given with cathartic (e.g. sorbitol). One or two additional doses may be given at 1-2 h intervals to ensure adequate gut decontamination.
 - iii. *Physiological antidote*: Physostigmine salicylate (reversible acetylcholinesterase inhibitor capable of directly antagonizing CNS manifestations of anticholinergic toxicity) 0.5-1 mg slow IV over 5 min with ECG monitoring (0.02 mg/kg/dose).
 - iv. Pilocarpine 5-15 mg subcutaneously is also useful.
 - v. Purgatives and colonic lavage is recommended.
 - vi. Tepid sponge baths to control high temperature and diazepam IV for sedation and seizures. Morphine is avoided.
 - vii. Delirium is controlled by short acting barbiturates.
 - viii. O_2 inhalation and artificial respiration.
 - ix. Hemodialysis and hemoperfusion are generally ineffective (tropane alkaloids are lipophilic and cross the blood-brain barrier).
 - x. Foley catheterization in case of urinary retention.
- Moistening of the tongue and change in the size of pupils point towards normalization and are useful as guidelines for adequate management.

- Physostigmine can induce a life-threatening cholinergic crisis such as seizures, respiratory depression and asystole. Since most patients can be safely treated without this antidote, physostigmine preferably should be used in consultation with a poison control center.
- Physostigmine is contraindicated in patients receiving tricyclic antidepressants, disopyramide, quinidine, procainamide and cocaine.

Postmortem Findings

External: Signs of asphyxia.

Internal

- i. Seeds may be detected in the stomach and small intestines. It resists putrefaction and may be found even in a decomposed body.
- ii. *Stomach*: Mucosa may show inflammation.
- iii. *Lungs*: Edematous and congested.

Medico-legal Aspects

- In India, datura is employed mainly as a *stupefying poison* prior to robbery, kidnapping and rape. It is sometimes known as *rail-road poison*, as it is

commonly encountered during a journey. Many a time, robbers disguised as saints offer '*prasad*' mixed with datura seeds and rob the passengers.

- Occasionally, it is used for suicidal purpose and for criminal abortion. In Mexico, *Datura* is taken by Yaqui women to lessen pain of childbirth.
- Accidental poisoning is common in children who may chew the fruit. Sometimes, it may be due to intake of seeds mistaking them for chilly seeds.
- Chinese herbal medicines containing tropane alkaloids have been used to treat asthma, chronic bronchitis, pain and flu symptoms. In Africa, a common use is to smoke leaves from *Datura* to relieve asthma and pulmonary problems.
- Homicide is rare.
- It is used as an adulterant in country liquor for enhancing the 'kick' effect.
- Sometime, it is used as an aphrodisiac and as a recreational hallucinogen.

Atropa belladonna

Atropa belladonna belongs to Solanaceae and grows abundantly in India, in the Himalayan ranges. All parts of this plant are poisonous.

Active principles: It contains three alkaloids—atropine, hyoscine and belladonine, but the most important of them is atropine.

Action: It acts by inhibiting the muscarine effects of acetylcholine.

Absorption and metabolism: They are absorbed from the skin and parenteral sites, and detoxicated in the liver.

Signs and symptoms resemble those of poisoning by datura.⁴

Fatal dose: Atropine: 100-130 mg.

Fatal period: Within 24 h.

Treatment: Same as for datura poisoning.⁵

Postmortem findings: Similar to those found in poisoning by datura.

Medico-legal aspects: Poisoning by belladonna occurs accidentally from an overdose of its pharmacopoeial preparations or from swallowing 'eye drops' by mistake.

Hyoscyamus niger

It yields the active principles hyoscyamine, hyoscine and atropine. It also produce signs and symptoms similar to datura.

Fatal dose: Hyoscyamine: 200 mg.

Fatal period: Within 24 h.

Treatment: Similar to that for datura.

MULTIPLE CHOICE QUESTIONS

- Following is not present in datura:** *JIPMER 11*
 A. Hyoscine B. Hyoscyamine
 C. Muscarine D. Atropine
- The police brought a person from railway platform. He was talking irrelevant, had dry mouth with hot dry skin, dilated pupils, staggering gait and slurred speech. Most probable diagnosis is:**
AI 04; Delhi 05; WB 07
 A. Alcoholic intoxication B. Datura poisoning
 C. OPC poisoning D. Aconite poisoning
- All are true about atropine poisoning, except:** *FMGE 11*
 A. Dilated pupils
 B. Decreased temperature
 C. Dysarthria
 D. Dysphagia
- Ramesh presented with bronchodilatation, increased temperature, constipation and tachycardia. Probable diagnosis is poisoning with:** *AIIMS 10*
 A. Mushroom
 B. Atropine
 C. Penicillamine
 D. Organophosphorus
- Following is used for treatment of belladonna poisoning:** *Delhi 03; UP 04*
 A. Neostigmine
 B. Physostigmine
 C. Magnesium
 D. Atropine sulphate

Deliriant—Cannabis

51

Introduction: *Cannabis sativa* (marijuana/marihuana/hashish/pot/hash/grass/weed), a deliriant cerebral neurotic plant which has several varieties: *Cannabis indica* (India), *Cannabis mexicana* (Mexico) and *Cannabis americana* (US). It is the most commonly abused drug in India and US, particularly among adolescents.¹

Distribution: Grows all over India. Whole plant is poisonous.

Active Principle

It is not an alkaloid, but a fat-soluble oleoresin, cannabinol, the active form being δ -9-tetrahydrocannabinol (THC).² It also contains benzopyrene, a known carcinogen which is also found in tobacco.

Preparations of Cannabis (Table 51.1)

Some other preparations:

- **Majum:** Sweetmeat made with bhang.
- **Hash oil:** A lipid soluble plant extract, may contain THC upto 25-50% and may be added to hashish and marijuana to enhance its THC concentration.³

THC is also available in capsule (dronabinol) as an appetite stimulant used for AIDS-related anorexia and as treatment for vomiting associated with cancer chemotherapy.

Routes of intake: Cannabis is usually smoked in cigarettes (joints or reefers)* or pipes, added to food

(usually cookies, brownies or sweetmeat) or mixed with milk (*bhang*).

Action

- THC which binds to anandamide receptors in the brain may have stimulant, sedative or hallucinogenic actions, depending on the dose and time after consumption.
- Both catecholamine release (resulting in tachycardia) and inhibition of sympathetic reflexes (resulting in orthostatic hypotension) may be seen.

Signs and Symptoms

Onset of symptoms occurs within a few minutes of smoking or within half hour of oral ingestion. The duration of action is usually 6-12 h; symptoms are most marked in the first 1-2 h.

I. Stage of Excitement

- i. Feeling of euphoria, detachment, well-being/grandiosity, dreaminess, subjective sense of slowing of the passage of time, increased self-confidence, rapidly changing emotions, talkativeness and laughing.
- ii. Impairment of thinking and short-term memory, decreased concentration, disorientation, illusions, visual hallucinations, altered sexual feelings,

Table 51.1: Preparations of cannabis

Features	Bhang (<i>siddhi, patti</i>)	Ganja	Charas (<i>hashish</i>)
Source	Dried leaves and fruit shoots	Flowering tops of female plant	Resinous exudates from leaves and stems which is dried and compressed into blocks
Color	Brownish	Rusty green color	Dark green or brown
Active principle	15% (<i>least potent</i>)	25%	25-40% (<i>most potent</i>)
Uses	Beverage	Mixed with tobacco and smoked in pipe/ <i>hukka</i>	Mixed with tobacco and smoked in pipe/ <i>hukka</i>

* It is a type of cigarette used for intoxication, containing 0.3-0.6 g of marijuana which is dipped in tincture of cannabis and dried.

impaired judgment, and perceptual and psychomotor dysfunctions resulting in impaired driving and motor vehicle accidents.

- iii. Increased appetite (the '*munchies*') and thirst, nausea, headache, conjunctival injection, dizziness, dry mouth, slurred speech, orthostatic hypotension, tachycardia and increased urinary frequency.

II. Stage of Narcosis

- i. Giddiness, incoordination, confusion, ataxia and paraesthesias.
- ii. The person passes into deep sleep and wakes up without depression/nausea/hangover.
- iii. Rarely, drowsiness may be followed by coma, collapse and death.

Fatal dose

- Bhang: 10 g/kg body wt.
- Charas: 2 g.
- Ganja: 8 g.

Fatal period: About 12 h.

Diagnosis is based on the history and typical findings. Blood analysis is the preferred method of detection for interpretation of acute effects.

Treatment

- i. Gastric lavage with warm water.
- ii. Strong tea/coffee.
- iii. Artificial respiration.
- iv. Saline purgatives.
- v. 100 ml of 50% glucose or dextrose, 2 mg naloxone and 100 mg thiamine IV.
- vi. Diazepam, 5-10 mg, if patient is violent and aggressive.
- vii. Haloperidol to control psychotic manifestations.

Postmortem findings: Non-specific. Mostly features of asphyxia are seen.

Medico-legal Aspects

- Most cases of poisoning are accidental or due to overindulgence. It is the most commonly used illicit drug among pregnant women and women of childbearing age in most Western societies.
- Majum and charas are sometimes used by thieves to stupefy persons to facilitate robbery.
- Sometimes, it is taken by criminals before committing a criminal act to strengthen nerves.
- It is used as an aphrodisiac and is supposed to increase duration of coitus.
- Its use in chocolates causes intense craving among children for its euphoric effects.

Run-amok

- Run-amok (Portuguese-Indian '*amuco*': heroic warriors ready to die in the battle) is a psychic disturbance resulting from continued use or sudden consumption of cannabis, and is characterized by a peculiar homicidal mania.⁴
- After intake, there is a period of depression, followed by excitation, confusion and a violent attempt to kill people (*impulse to murder*).
- The addict first kills a person against whom he may have real or imaginary enmity and then kills anyone who comes in his way, until the homicidal tendency lasts. The person may then commit suicide or surrender himself to the law enforcement authority.
- *Criminal responsibility:* The person is not held responsible for his acts since 'run amok' is considered a disorder of mind and not intoxication, unless he had taken it purposefully to enerve himself before commission of the offence.

MULTIPLE CHOICE QUESTIONS

1. Most common substance abuse in India:

- AI 07; AIIMS 10*
- A. Cannabis
 - B. Tobacco
 - C. Alcohol
 - D. Opium

2. Active component of ganja:

- TN 05*
- A. Tetrahydrocannabinol
 - B. LSD
 - C. N-methyl tryptophan
 - D. Ricin

3. Most potent form of cannabis:

- Maharashtra 11*
- A. Bhang
 - B. Charas
 - C. Ganja
 - D. Hash oil

4. Run-amok is a feature of:

- Maharashtra 10*
- A. Opium
 - B. Dhatura
 - C. Cannabis
 - D. Alcohol

Deliriant—Cocaine

52

Physical properties: Cocaine (crack, pasta, bazooka, speedball, snuff, coke, snow or white lady) is a colorless, odorless, crystalline substance with bitter taste and slightly soluble in water, but freely soluble in alcohol.

- It is an alkaloid deliriant, obtained from dried leaves of *Erythroxylum coca*, a shrub indigenous to Peru, Bolivia, Mexico, West Indies and Indonesia.
- Illicit forms of cocaine include the hydrochloride salt and its alkalization products, freebase and crack.

Action

- Cocaine produces a hyperadrenergic state.
- It increases the synaptic concentrations of the monoamine neurotransmitters dopamine, norepinephrine and serotonin by binding to transporter proteins in presynaptic neurons and blocking uptake.
- It is also a local anesthetic as it blocks initiation and conduction of nerve impulse by decreasing axonal membrane permeability to sodium ions.
- It stimulates the cortex for a short time, followed by depression.

Absorption and Excretion

- Cocaine is rapidly absorbed from the mucous membranes and subcutaneous tissues.
- About 30-50% of cocaine is metabolized by hepatic esterases and plasma pseudocholinesterase, resulting in the formation of ecgonine methyl ester. Spontaneous nonenzymatic hydrolysis of another 30-40% results in benzoylecgonine.
- Only 1-5% of cocaine is excreted unaltered through the kidneys within 6 h of use.
- A metabolite of cocaine, *cocaethylene* has been found in blood and urine of patients who abuse both alcohol and cocaine.

Routes of administration: Chewing, application to nasal mucous membrane (snorting),¹ smoking (*free basing*) and IV.

Cocaine may be inhaled through a straw or rolled-up paper currency, or a coke spoon containing 5-20 mg of the drug is used to snort.

Signs and Symptoms

Signs and symptoms of acute poisoning include elevated pulse, blood pressure, respiration and temperature. Onset occurs within 7 s after inhalation, 15 s after taking IV, 3 min after nasal insufflations and 10 min after oral ingestion.

I. Stage of Excitement²

System	Signs and symptoms
Local	Feeling of numbness or tingling at the place of application.
Face	Flushed.
Skin	Pale.
GIT	Bitter taste, dryness of mouth, vomiting, diarrhea, hyperactive bowel sounds
CNS	Feeling of well-being, euphoria, restlessness, excitement, talkativeness, delirium, maniacal, hallucinations, tremors (e.g. twitching of small muscles, especially facial and finger) and tonic-clonic seizures. Reflexes are exaggerated.
RS	Tachypnea, dyspnea, cyanosis.
CVS	Tachycardia, hypertension, ventricular arrhythmias.
Temperature	Hyperthermia.
Ocular	Pupils are dilated resulting in blurred vision.

II. Stage of Depression

After an hour, respiration becomes slow, there is profuse sweating, and patient becomes calm and dull.

System	Signs and symptoms
CNS	Coma, areflexia, pupils fixed and dilated, flaccid paralysis and loss of vital support functions.
CVS	Ventricular dysrhythmias result in weak, rapid, irregular pulse and hypotension, circulatory failure and cardiac arrest.
RS	Cheyne-Stokes respirations, apnea, pulmonary edema, cyanosis, respiratory failure.

Tea colored urine may indicate rhabdomyolysis and potential renal failure. In fatal cases, the onset and progression are accelerated, with convulsions and death frequently occurring in 2-3 min.

Fatal dose: 20 mg IV; 500 mg to 1.4 g orally.

Fatal period: Few minutes to 1-2 h.

Differential diagnosis: Cocaine overdose may resemble lithium toxicity, cyclic antidepressants toxicity, neuroleptic malignant syndrome, thyroid storm and other hyperadrenergic states.

Diagnosis: Qualitative toxicological analysis of blood and urine. Finding cocaine and metabolites in the urine supports the diagnosis. However, urinalysis can detect cocaine metabolites 3 days post-exposure, a positive screen does not equate with clinical toxicity.

Urine, blood, gastric contents and unknown substances found on patients, such as on a moustache, may be sent for toxicological evaluation.

Treatment

- i. If injected, apply tourniquet above the part; if applied to nose or throat, wash-out with warm water or saline. If swallowed, gastric lavage should be done with KMnO_4 and/or activated charcoal.
- ii. *To control seizures:* Diazepam in doses upto 0.5 mg/kg IV may be given over an 8 h period. Physical restraint should be avoided due to risks of rhabdomyolysis and hyperthermia.
- iii. Dysrhythmias should be treated according to standard advanced cardiac life support (ACLS) protocols. Ventricular arrhythmia is managed by giving 0.5-1 mg of propranolol IV.
- iv. Short-acting, direct vasodilator (esmolol) and short acting beta-blockers are indicated for tachycardia and hypertension.
- v. Thiamine 100 mg IV.
- vi. Intensive supportive therapy is needed in case of acute intoxication.
- vii. Airways are kept clean, artificial respiration and O_2 inhalation as required.

Complications

- **CNS:** Cerebrovascular accidents (frequent cause of stroke in < 45 years), subarachnoid or intracerebral hemorrhage and cerebral vasculitis.
- **CVS:** Myocardial, bowel and kidney ischemia, myocardial infarction, skin necrosis and aortic dissection.²
- Pulmonary infarcts, barotraumas, eosinophilia with granuloma formation.

- *Inhalational exposure* can result in cough, hemoptysis, reactive airway disease, pneumonitis ('crack lung') and barotrauma (e.g. pneumothorax).

Postmortem findings: Non-specific findings.

- i. Patients may have linear excoriations, 'crack pipe' burns of the fingers or thumbs, thermal burns of the face and upper airway.
- ii. Track marks in the usual sites such as the antecubital fossae, and at unusual sites such as under the tongue and on top of the feet may be seen.
- iii. Intense asphyxial signs, and cardiac dilatation may be seen.

Blood should be preserved by adding fluoride.

Medico-legal Aspects

- Accidental cases occur from urethral, vesical and rectal injection. Oral overdose can occur in body packers and body stuffers.
- Cocaine is rarely used for homicide or suicide.
- It is believed to increase the libidinal drive and increase the duration of sexual act by paralyzing sensory nerves of glans penis.
- It causes lowering of moral values, loss of decency and self-respect.
- It is rapidly destroyed in the body and is difficult to detect by chemical analysis.

- '*Crack*' is produced when the hydrochloride molecule is removed by ether extraction, which frees the basic cocaine molecule ('freebase'). The term '*crack*' describes the crackling sound heard when cocaine freebase is smoked.
- Illicit drugs are frequently admixed with additional chemicals either to increase the apparent quantity of the street drug or to enhance its effect. For example, 8-20% of stimulants available on the street contain cocaine and methamphetamine hydrochloride. Other adulterants may include quinine, talc, ascorbic acid, boric acid, chalk, laundry detergent, laxatives and lactose.
- '*Crack lung*' may occur 1-48 h after cocaine smoking. It is a hypersensitivity pneumonitis wherein there is chest pain, cough, hemoptysis, dyspnea, bronchospasm, pruritus, fever, diffuse alveolar infiltrates without effusions, and pulmonary and systemic eosinophilia.
- '*Crack dancing*' refers to the extrapyramidal phenomena and other movement disorders that are sometimes associated with cocaine abuse.

Cocainism (Cocainomania/Cocainophagia)

Abusers can tolerate upto 10 g/day.

Signs and symptoms

- Emaciation, anorexia, digestive disturbances, significant loss of libido, impotence, gynecomastia,

galactorrhea and major derangements in menstrual cycle in women—amenorrhea and infertility.

- Face is pale, shifty gaze, sunken eyes, dilated pupils, tongue and teeth are black, and ulceration of nasal septum.³
- Degeneration of CNS with hallucinations, convulsions and delirium may occur.

Magnan's Syndrome/Cocaine Bugs^{4,5}

- This is seen in cocaine addicts.
- It is a type of *tactile hallucination*.

- There is a feeling as if grains of sand are lying under the skin or small insects are creeping on the skin giving rise to itching sensation (formication).

Formication (Latin *formica*: ant): Tactile hallucination involving the sensation that tiny insects are crawling over the skin.

Causes of formication can be actual physical conditions, including diabetic neuropathy, menopause, skin cancer or herpes zoster, and may also be physical or psychological side-effect of substance abuse (cocaine, amphetamines, and alcohol withdrawal along with delirium tremens).

MULTIPLE CHOICE QUESTIONS

- Nasal swabs are preserved in:** *Manipal 04*
 A. Drowning B. Anaphylaxis
 C. Cocaine poisoning D. Arsenic poisoning
- Following are complications of cocaine poisoning, except:** *UPSC 08*
 A. Angina and myocardial infarction
 B. Epileptic seizures
 C. Hypothermia
 D. Hypertension
- An addicted patient presenting with visual and tactile hallucinations, has black staining of tongue and teeth. The agent is:** *PGI 04; Gujarat 10*
 A. Cocaine B. Cannabis
 C. Heroin D. Opium
- A person feels that grains of sand are lying under the skin or some small insects are creeping on the skin giving rise to itching sensation; the condition is seen in:** *PGI 03; COMEDK 07; Maharashtra 09; AIIMS 09, 11*
 A. Cocaine poisoning
 B. Organophosphorus poisoning
 C. Morphine poisoning
 D. Alcohol withdrawal
- Magnan's syndrome is seen with:** *Delhi 03; TN 06; WB 09; BHU 09; MP 11*
 A. Cocaine B. OPC
 C. Snake bite D. Alcohol

Spinal and Peripheral Nerve Poisons

53

Strychnos Nux-vomica (Kuchila)

Introduction: It belongs to the Loganiaceae family.

Identification of Seeds

- The ripe fruit contains seeds which are poisonous. They are flat, circular discs, 2.5 × 0.6 cm, slightly concave on one side and convex on the other, ash grey in color, have a shiny surface and are covered with silky hairs.
- They look like enlarged RBCs.
- Unbroken seeds when ingested are not poisonous, as the hard pericarp is not soluble in digestive juices.

Active Principles

- i. Strychnine—Alkaloid
- ii. Brucine—Alkaloid
- iii. Loganin—Glucoside

Bark, wood and leaves contain brucine, but not strychnine.

Properties of strychnine: Colorless, bitter, odorless, rhombic prism-shaped crystals. Dissolves sparingly in water or ether, but dissolves well in alcohol and benzene.

Uses: It is used as a respiratory stimulant, rodenticide, and for killing stray dogs. Strychnine is still available as herbal and homeopathic remedies, as a purgative, appetite suppressant and as a constituent of nerve tonics. It can be found as an adulterant in some street drugs (cocaine, heroin and amphetamines).

Action

Strychnine competitively antagonizes the inhibitory neurotransmitter glycine by blocking its post-synaptic uptake by brainstem and spinal cord receptors.¹

- The inhibiting effect of glycine is reduced and nerve impulses are triggered with lower levels of neurotransmitters.
- When there is no inhibitory effect, the motor neurons do not stop their stimulus and the victim will have constant muscle contractions ('*release excitation*').
- Its action is particularly in the anterior horn cells (especially in Renshaw cells of the spinal cord).

GABA, the neurotransmitter for presynaptic inhibitory neurons is not affected by strychnine.¹

Metabolism: It is metabolized mainly in the liver.

Signs and Symptoms

Signs and symptoms are seen within 15-30 min of ingestion. A 'conscious' seizure is the characteristic presentation of strychnine poisoning.² Following may be seen:

- i. Bitter taste.
- ii. Choking sensation in throat and stiffness of the neck and face.
- iii. *Prodromal symptoms:* Restlessness, increased acuity of perception, increased rigidity of muscles and muscular twitchings.
- iv. **Face:** Cyanosed, look is anxious, eyes are staring, eyeballs are prominent and the pupils are dilated. Mouth is filled with bloodstained froth.
- v. **Convulsions:** The threshold for CNS stimulation is lowered with the result that any sensory stimulus (pain, touch or noise) may produce violent muscular spasm. Initially, clonic but eventually become tonic and affect all the muscles at the same time.
 - *Risus sardonicus* results from contraction of the jaw and facial muscles in which the corners of the mouth are drawn back.
 - Convulsions are most marked in anti-gravity muscles resulting in hyperextension (*opisthotonus*) (Fig. 53.1).
 - Sometimes, the spasm of the abdominal muscles may bend the body forward (*emprosthotonus*) or sideways (*pleurosthotonus*).
 - Duration of convulsions is about half to 2 min.
 - In between convulsions, muscles are completely relaxed. Patient looks well, but exhausted and breathing is resumed.
 - After 5-15 min, on the slightest impulse, like sudden noise, current of air or on gently touching the patient, another convulsion occurs.

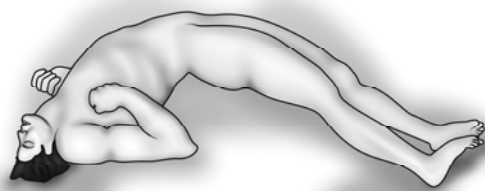

Fig. 53.1: Opisthotonus

- Increased muscle tone, hyperreflexia, agitation, restlessness and convulsions lead to profound lactic acidosis, rhabdomyolysis and hyperthermia.
- Death occurs within 4-5 convulsions as the patient cannot breathe. Consciousness is not lost and the mind remains clear till death.

Death is due to medullary paralysis or asphyxia due to spasm of respiratory muscles or due to exhaustion.

- **Clonic contractions** (Greek *klonos*: turmoil): Alternate involuntary muscular contraction and relaxation in rapid succession.
- **Tonic contractions** (Latin *tonicus*: of tension/tone): It is characterized by continuous tension or contraction of the muscles.

Fatal dose

- Strychnine: 15-50 mg (1-2 mg/kg body wt).
- 1 crushed seed.

Fatal period: 1-2 h.

Differential diagnosis: Tetanus (Diff. 53.1), epilepsy, hysteria, neuroleptic malignant syndrome, malignant hyperthermia and stimulant use.

Treatment

There is no antidote for strychnine poisoning.

- Maintain clear airway and adequate ventilation.
- Control of convulsions:** Dark room, free from noise and disturbance. Benzodiazepines remain the first-line of treatment for strychnine induced muscular hyperactivity. Diazepam 0.1-0.5 mg/kg IV slowly. If ineffective, general anesthetics and/or muscle relaxants, like gallamine should be given.
- Barbiturates, like pentobarbital sodium or sodium amytal are antidotes. *Dose:* 300-600 mg IV.
- Gastric lavage with KMnO_4 may be done cautiously, if there are no convulsions. Activated charcoal is recommended as it adsorbs strychnine and may reduce its absorption if given 1 h of ingestion.
- Hyperthermia is treated by active cooling with ice water immersion, cooling blanket or mist and fan.
- Symptomatic treatment.

Postmortem Findings

- Not characteristic.
- Rigor mortis appears early.
- Signs of asphyxia.
- Extravasated blood may be found in the muscles.
- Viscera are congested.

Medico-legal Aspects

- One of the most deadly poisons. Death is usually accidental due to overdose, quack remedies and poison mistaken for some other harmless drug, or in children eating the seeds.
- It is used as an aphrodisiac, as cattle and arrow poison and to kill dogs and rats.

Differentiation 53.1: Strychnine poisoning and tetanus

S.No.	Feature	Strychnine poisoning	Tetanus
1.	History of injury	None	Present
2.	Onset	Sudden	Gradual
3.	Site of action	Postsynaptic membrane	Presynaptic membrane
4.	Muscles affected	All muscles affected at the same time	Not affected at the same time
5.	Lower jaw	Does not start in, nor especially affect the jaw	Starts in and affects the jaw (<i>lock-jaw</i>)
6.	Muscular condition	Relaxed in between convulsions	Rigid
7.	Fatal period	1-2 h	> 24 h
8.	Chemical analysis	Strychnine found	No poison
9.	Culture	No growth	<i>Clostridium tetani</i> found
10.	Progression	Steadily worse/steadily better	Progress rarely steady. Variations and longer remission not uncommon

- Tolerance develops on repeated consumption.
- It can be detected easily even in a decomposed body (detectable as low as 0.01 ppm in tissue).

PERIPHERAL NERVE POISONS

Curare

Introduction: The alkaloid is a peripheral muscle relaxant and is available from the plant *Chondrodendron tomentosum* or from some species of *Strychnos* plants. It is not poisonous when swallowed.

Active principles: d-tubocurarine, dimethyl tubocurarine, syncurine and succinylcholine chloride.

Action: It blocks the postsynaptic nicotinic acetylcholine receptors in the muscles, thus causing flaccid paralysis of skeletal muscles.

Signs and Symptoms

It causes paralysis of voluntary muscles, followed by paralysis of respiratory muscles resulting in death from asphyxia. The mental faculties remain clear till the end.

Fatal dose: 30-60 mg of curarine parenterally.

Fatal period: 1-2 h.

Treatment

- Artificial respiration and O₂ should be given.
- If applied to a wound or introduced by an arrow, a ligature should be applied proximal to the site and is washed with a solution of KMnO₄.
- Atropine 0.6-1.2 mg, followed by physostigmine (1-2 mg, *physiological antidote*) or neostigmine (0.5-1 mg) subcutaneously should be given.

Postmortem findings: Those of asphyxia. Skin and tissue from the wound due to the arrow or injection should be preserved.

Medico-legal aspects: Most deaths are from its use in anesthesia. It is also used as arrow poison.

Conium Maculatum (Hemlock)

Introduction: This plant is also known as *spotted hemlock*, because of the purple spots on its stem. It grows in

wastelands. All parts of the plant are poisonous. The whole plant has a mousy odor which is intensified by crushing the leaves or stems.

Active principles: Coniine, methyl coniine and six other alkaloids. Coniine content is highest in the unripe fruit and seeds. Symptoms may be caused by ingestion, injection or even inhalation of coniine (volatile alkaloid).

Action: It causes paralysis of the motor nerve terminals in the muscles, gradually spreading to the motor cells of the spinal cord and the brain.

Signs and Symptoms

- Nausea, unpleasant mousy odor in breath.
- Ingestion causes burning in the mouth and throat, gastric inflammation, vomiting, diarrhea, slow respiration and pulse, mental confusion, tremors and blindness.
- This is followed by progressive muscular paralysis due to depression of the motor nerves. The lower limbs are affected first and the paralysis ascends till the muscles of respiration are affected.
- Delirium, convulsions and coma may supervene and the patient dies of asphyxia due to respiratory paralysis. The mind remains clear till the end.

Fatal dose: 60 mg coniine or a piece of plant about 1 cm in diameter.

Fatal period: Few hours.

Treatment

- Gastric lavage with KMnO₄.
- Artificial respiration.
- Oxygen inhalation.
- Stimulants.
- Symptomatic treatment.

Postmortem findings: Those of asphyxia, the remains of the roots or leaves should be looked for in the stomach contents and preserved for chemical analysis.

Medico-legal aspects: Poisoning is mostly accidental, the plant being mistaken for parsley or some harmless herb.

Hemlock was administered to Socrates, the Greek Philosopher in 399 BC as a form of execution.

MULTIPLE CHOICE QUESTIONS

1. Inhibitory neurotransmitter in spinal cord is:

NIMHANS 08

- | | |
|--------------|------------------|
| A. GABA | B. Glycine |
| C. Glutamate | D. Acetylcholine |

2. Respiratory centre depression is caused by all, *except*:

AIIMS 10

- | | |
|-----------------|---------------|
| A. Opium | B. Strychnine |
| C. Barbiturates | D. Gelsemium |

Cardiac Poisons

54

These are poisonous plants having an action mainly on the heart, either directly or through the nerves. Important poisonous plants and compounds in this group are:

- Aconite (*Aconitum napellus*, *Aconitum ferox*)
- Nicotine (*Nicotiana tabacum*)
- Digitalis (*Digitalis purpurea*)
- Oleander (*Cerbera thevetia*, *Cerbera odorum*)
- Quinine

Aconite (Monk's Hood, Mitha Zaher, Bish)

Introduction: All parts of the plant are poisonous, however, the root is the most potent.

Dry root is conical or tapering, shows bases of the broken rootlets and shriveled with longitudinal wrinkles. It is 5-10 cm long, 1.5-2 cm thick at the upper end and dark brown in color. Roots are mistaken for horseradish root.

Active principles: Aconitine, pseudo-aconitine, indaconitine, picraconitine and aconine.

Properties of aconitine: Colorless, transparent, rhombic crystals. Insoluble in water, but readily soluble in benzene and chloroform.

Action

- Aconitine first stimulates and then paralyzes the peripheral terminations of sensory and secretory nerves, CNS, and nerves of the myocardium, skeletal and smooth muscles.
- It does not affect the higher centres of the brain as consciousness remains intact till the end.

Signs and Symptoms

System	Signs and symptoms
GIT	Nausea, vomiting, salivation, pain in the abdomen. Bitter-sweet taste, severe burning and tingling of tongue, mouth and throat, followed by numbness. ¹
CVS	Blood pressure falls. Pulse is slow, feeble and irregular.

CNS	Vertigo, restlessness, headache, giddiness.
MS	Weakness of the muscles with twitchings and spasms.
RS	Respiration is slow, labored and shallow.
Ocular	Pupils alternately contract and dilate (<i>hippus</i>). Diplopia and impaired vision occurs.
Others	Temperature is subnormal and skin is cold.

Death is due to respiratory failure or ventricular fibrillation.

Fatal dose

- Root: 1-2 g.
- Aconitine: 2-5 mg.

Fatal period: 2-6 h.

Treatment

- Gastric lavage with tannic acid/activated charcoal.
- Atropine 0.5-1 mg IV.
- Cardiac monitoring.
- Symptomatic treatment.

Postmortem Findings

- Not specific, those of asphyxia.
- Organs are congested.
- Fragments of root may be found in the stomach.

Medico-legal Aspects

- It is often regarded as *an ideal homicidal poison*.
Advantages are:
 - It is cheap and easily available.
 - Lethal dose is small and the fatal period is short.
 - Color can be disguised by mixing it with pink colored drinks.
 - Taste can be masked by mixing it with sweets or by giving it with betel (*paan*) leaves.
 - Extremely unstable and destroyed by putrefaction, hence cannot be detected by chemical analysis.
- *Accidental poisoning* occurs due to:
 - Eating the roots mistaking it for horseradish.
 - Use of quack remedies.
 - Taking of liquor mixed with aconitine to increase intoxication.

- It is also used as an abortifacient, cattle and arrow poison.
- Suicide is not common.

- **Horseradish** is a perennial plant which includes mustard and cabbages.
- **Hippus** (Greek *hippos*: horse): Abnormal exaggeration of the rhythmic contraction and dilatation of the pupil, independent of changes in illumination or in fixation of the eyes.

Nicotiana Tabacum (Tobacco)

Introduction

- All parts of the plant are poisonous, except the ripe seeds.
- Dried leaves contain 1-8% nicotine.
- Leaves contain toxic alkaloids, like nicotine, anabasine, nornicotine and lobeline (in Indian tobacco).
- An average cigarette delivers 1-3 mg of nicotine.

Properties of nicotine: Colorless, hygroscopic oily liquid. Burning acrid taste and disagreeable odor.

Action

- It acts on the autonomic ganglia, which are stimulated initially, but are depressed and blocked at the later stages.
- It also acts on the somatic neuromuscular junction and afferent fibres from sensory receptors.

Signs and Symptoms

Acute poisoning

- CVS:** Tachycardia followed by bradycardia, hypotension, arrhythmia, tachypnea followed by respiratory depression and collapse.
- GIT:** Burning acid sensation, nausea, vomiting, abdominal pain, salivation and odor of tobacco.
- CNS:** Headache, restlessness, confusion, vertigo, sweating, convulsions and coma.

Chronic poisoning

- RS:** Cough, wheeze, dyspnea, chronic bronchitis and lung cancer may develop.
- CVS:** Anemia, palpitations, irregularity of heart, angina pectoris and Berger's disease.
- GIT:** Anorexia, vomiting and diarrhea.
- CNS and others:** Impaired memory, blindness, tremors, insomnia, anxiety and headache.

Fatal dose

- Nicotine: 60-100 mg.
- Tobacco: 15-30 g.

Fatal period: 5-15 min.

Treatment

- Gastric lavage with charcoal, KMnO_4 .
- Purgatives.
- Cardiac monitoring.
- Atropine to correct hypotension, and diazepam for convulsions.
- Symptomatic treatment.

In chronic poisoning, clonidine has shown encouraging result.

Postmortem Findings

- Brownish froth at mouth and nostrils.
- Stomach may contain fragments of leaves or smell of tobacco.
- Features of asphyxia are seen.

Medico-legal Aspects

- Accidental poisoning results from ingestion, excessive smoking and application of leaves or juice to wound or skin.
- Common drug of addiction.
- For malingering, leaves are soaked in water for some hours and placed in axilla at bed time, poisonous symptoms are seen by next morning.
- Suicidal/homicidal cases are rare.

Digitalis Purpurea (Foxglove)

Active principles: Its roots, leaves and seeds contain several glycosides; digitoxin, digitalin, digitalein and digitonin are the most poisonous.

Action

The glycosides act directly on the heart muscle (prolong diastolic period) and improve the function of the failing heart. In toxic doses, excitability is increased with extrasystoles.

Glycosides are substances found in plants and are composed of a sugar and a non-sugar compound, the latter having toxicological action.

Signs and Symptoms

Toxic symptoms are due to overdose or by a cumulative action.

The patient becomes drowsy and the condition may deepen into coma. Convulsions may precede death. Death occurs from cardiovascular collapse.

Fatal dose

- Digitalis: 2-3 g.
- Digoxin: 5 mg.

System	Signs and symptoms
GIT	Nausea, vomiting, pain in abdomen, burning sensation, diarrhea.
CVS	Bradycardia, extrasystoles, ventricular tachycardia and fibrillation, atrial fibrillation, faintness, precordial oppression, heart block.
CNS	Headache, fatigue, confusion, anxiety, depression, disorientation, drowsiness, hallucinations, delirium.
RS	Labored and sighing respiration.
Ocular	Transient amblyopia, blurring, photophobia, scotoma, diplopia, color aberration.
Skin	Urticaria.

- Digitalin: 15-20 mg.
- Powdered leaves: 2.5 g.

Fatal period: 1-24 h.

Treatment

ECG monitoring is necessary as a guide to treatment.

- Gastric lavage is done with a solution of tannic acid.
- Activated charcoal is given.
- Purgatives may be given.
- Atropine is given in a dose of 0.6 mg IV to treat bradycardia.
- Potassium chloride may be given to reduce extrasystoles.
- Specific antidote for cardiac arrhythmias is lignocaine 100 mg IV or novocaine or propranolol.
- Trisodium EDTA may help to lower serum calcium.
- Symptomatic treatment.

Postmortem Findings

Non-specific changes are seen. There may be irritation of the gastric mucosa, and digitalis leaves or seeds may be found in the stomach.

Medico-legal Aspects

- Accidental poisoning due to overdose of a medicinal preparation or from eating leaves by mistake.
- Homicidal poisoning cases may be seen and no suspicion of poisoning may arise in such cases as it will simulate heart disease.
- It is a cumulative poison, and persons taking it for a long time may suddenly develop symptoms of poisoning.

OLEANDER (KANER)

The oleander plant grows wild in India. There are two varieties:

- *Nerium odorum*: Bears white, dark red or pink flowers.
- *Cerbera thevetia*: Bears yellow bell-shaped flowers, globular fruits, light green in color, about 5 cm in diameter containing a single nut, triangular in shape and light brown in color. The nut contains five pale yellow seeds.

Nerium Odorum (White Oleander, Kaner)

All parts of the plant are poisonous.

Active principles: Nerin consisting of three glycosides—neriodorin, neriodorein and karabin.

Action

It is similar to that of digitalis causing death from cardiac failure. Neriodorein causes muscular twitching and tetanic spasm which is more powerful than strychnine. Karabin acts on the heart like digitalis, and on the spinal cord like strychnine.

Signs and Symptoms

- **Locally**, contact dermatitis.
- **Inhalation** of flowers may cause headache, dizziness, respiratory difficulty and nausea.
- **Ingestion** causes vomiting, pain in the abdomen, frothy salivation, difficulty in swallowing and articulation. Later on, there is restlessness, muscular twitchings, tetanic spasms and lock jaw. The pulse is slow and weak, respiration is rapid, blood pressure falls, and there is fibrillation and AV block. This is followed by exhaustion, drowsiness, coma, respiratory paralysis and death from heart failure.

Fatal dose: Root: 15-20 g; leaves: 5-15.

Fatal period: 24 h.

Treatment

- Gastric lavage.
- Administration of an anesthetic is usually necessary.
- Morphine injection seems to be beneficial.
- Symptomatic treatment.

Postmortem Findings

Non-specific findings. Petechial hemorrhage on the heart is a characteristic feature. Organs are congested.

Medico-legal Aspects

- Suicide is common among village girls, using it as a paste or decoction.

- It is used as an abortifacient, applied both locally and internally.
- Homicide is rare.
- Accidental poisoning is sometimes met with when decoction is used:
 - a. Externally to reduce swelling.
 - b. As a remedy for venereal diseases.
 - c. As a love-philter (increases attraction between the giver and taker).
 - d. For treatment of cancer and ulcers.
- It is used as cattle poison.
- *Nerium odorum* resists heat and can therefore be detected even from the burnt remains of the dead body.

Cerbera Thevetia (Yellow Oleander, Pila Kaner)

All parts of the plant are poisonous. Milky juice exudes from all parts of the plant.

Active principles: Glycosides—thevetin, thevetoxin, cerberin and peruvoside. Thevetin is a powerful cardiac poison. Thevetoxin is less toxic than thevetin and resembles the glycosides of digitalis in action. Cerberin acts like strychnine.

Signs and Symptoms

The sap of the plant may cause inflammation.

On ingestion, there is burning sensation in the mouth with tingling of the tongue, dryness of throat, vomiting, diarrhea, headache, dizziness, dilated pupils, drowsiness and loss of muscular power. Pulse is rapid, weak and irregular, blood pressure falls. Heart block, collapse and death is due to peripheral circulatory failure.

Fatal dose: Seeds: 8-10; root: 15-20 g.

Fatal period: 2-3 h.

Treatment

- i. Gastric lavage.
- ii. Molar solution of sodium lactate IV and 5% glucose to combat acidosis.
- iii. Atropine 1 mg, 2 ml of adrenaline 1:1000 and 2 mg of noradrenaline (if blood pressure is low) to counteract heart block.
- iv. Symptomatic treatment.

Postmortem Findings

Non-specific.

- i. Signs of GIT irritation may be seen.
- ii. Stomach and duodenum may be congested and may show fragments of seeds.
- iii. Congestion of visceral organs are seen.

Medico-legal aspects: Same as *Nerium odorum*.

Quinine

The bark of *Cinchona* plant contains quinine, quinidine, cinchonidine and other alkaloids. Quinine occurs as white needle-shaped, odorless, crystalline and bitter powder.

Action

It is a protoplasmic poison with anesthetic and sclerosing effect. It stimulates and then depresses the CNS. It causes circulatory failure by direct and indirect actions.

Signs and Symptoms

On ingestion, there is pain in the abdomen, vomiting, diarrhea, headache, giddiness, tinnitus, partial deafness, loss of vision, scotoma, confusion, muscular weakness, itching, tachycardia, hypotension and cyanosis.

- There may be oliguria, hemolysis, hematuria and uremia.
- Respiration is rapid and shallow, pupils are fixed and dilated, delirium and coma.

Death occurs from respiratory failure.

Cinchonism or quinism is caused by repeated therapeutic doses or overdose of quinine.

Symptoms are tinnitus, vertigo, deafness, diplopia, scotoma, blindness, skin rash, hypoglycemia and cardiac arrhythmias.

Fatal dose: 2-8 g.

Fatal period: About 6 h.

Treatment

- i. Assisted ventilation, if necessary. Continuous cardiac monitoring is needed.
- ii. Gastric lavage is done and magnesium sulphate is used for purgation.
- iii. Activated charcoal.
- iv. For cardiac toxicity, IV bolus of sodium bicarbonate is given.
- v. Ventricular tachycardia may be treated with magnesium IV or overdrive pacing.
- vi. Intravenous fluids are given to promote diuresis.
- vii. *Protection of vision:* Blocking of bilateral stellate ganglion is sometimes recommended.
- viii. Symptomatic treatment.

Postmortem Findings

Non-specific. Organs are congested and hemolysis of red cells may be found. Renal tubules may be blocked by hemoglobin.

Medico-legal Aspects

- Accidental poisoning occurs due to medicinal overdose.
- Suicide/homicide is rare.
- It is used as an abortifacient.

MULTIPLE CHOICE QUESTION

1. **Characteristic symptom of aconite poisoning:** *AI 10*
- A. Increased salivation
 - B. Hypertension
 - C. Tingling and numbness
 - D. Hyperthermia

Hydrocyanic Acid

55

Introduction: Hydrogen cyanide (HCN) is a highly toxic chemical. Hydrocyanic acid (Prussic acid, cyanogens) is a solution of HCN in water, either 2% or 4%, the latter being called *Scheele's acid*.

Physical properties: Pure acid is a colorless gas with *bitter almond odor*.¹ All persons cannot smell the gas, and the ability to detect it is a *sex-linked recessive trait*. Cyanides of sodium/potassium are white powders. HCN acid is liberated from these by reacting with acids (e.g. HCl in stomach).

Sources and Uses

- *Natural:* It is found in many fruits and leaves, such as almond, apricot, apple, cherry and plum and in certain oilseeds and beans where it exists in the form of glucoside amygdalin which is harmless, but usually co-exists with a group of enzymes, the emulsin complex which hydrolyzes it and liberates HCN.
- *HCN gas:* It is used for fumigation of ships.
- HCN is often used in laboratory and industries connected with photography, electroplating, silver coating and tanning.
- It is normal constituent of the body (15-30 µg).

Action

- HCN is a protoplasmic cytotoxic poison.
- It acts by inhibiting cytochrome oxidase, carbonic anhydrase and other enzyme systems of cellular respiration.² It blocks the final step of oxidative phosphorylation and prevents the formation of ATP.
- It also acts as a corrosive on mucosa.

Cyanides may become less effective, if they are kept too long (they tend to change into carbonates) and if the person suffers from achlorhydria (since HCl acts on cyanides to liberate hydrocyanic acid).

Absorption and Excretion

- Hydrocyanic acid is rapidly absorbed by all routes—ingestion, inhalation, dermal and parenteral.
- Cyanide gas is absorbed from the respiratory tract and the acid and cyanide salts from the stomach.

- Absorption is delayed when cyanide is taken on a full stomach or with a large quantity of wine.

Signs and Symptoms

This is *most rapid of all poisons*. The dose of cyanide required to produce toxicity is dependent on form (gas or salt), duration of exposure, dose and route of exposure.

- When inhaled as gas, its action is instantaneous.
- If a large dose is taken, symptoms appear at once, but in some cases symptoms appear after sometime, during which the victim may perform certain voluntary acts, such as throwing away the bottle or walking a little distance.
- In case of dermal application, latent interval can be several hours.

System Signs and symptoms

Local	Corrosive effect on the mouth, throat and stomach.
CNS	Headache, vertigo, faintness, anxiety, excitement, confusion, drowsiness, prostration, opisthotonus, hyperthermia, epileptiform or tonic convulsions, paralysis, stupor and coma.
CVS	Initially hypertension with reflex bradycardia, sinus arrhythmia, later on tachycardia with hypotension and cardiovascular collapse.
GIT	Bitter acid burning taste, constriction or numbness of throat, clenched jaw, salivation, froth, nausea, rarely vomiting.
RS	Odor of bitter almonds in breath, initially tachypnea and dyspnea, followed by rapid slowing of respiratory rate with severe respiratory depression and cyanosis.
Skin	Perspiration, bullae, pinkish color*
Ocular	Glassy, prominent eyes, pupils dilated and unreactive.
Renal	Acidosis.

- Moreover, after inhalation, there is nasal and laryngeal irritation, dyspnea, feeling of suffocation and chest tightness and air hunger.
- Death occurs from respiratory failure.

* Pink color results from increased venous hemoglobin saturation due to decreased utilization of O₂ at tissue level. On fundoscopic examination, veins and arteries may appear similar in color.

Fatal dose (Blood levels > 2.5 mg/l is fatal)

- Pure acid: 50-60 mg.
- NaCN and KCN: 200-300 mg.
- Pharmacological preparation: 30 drops.
- Crude oil of bitter almonds: 60 drops.
- Airborne concentration: 270 ppm ($\mu\text{g}/\text{ml}$) of HCN.

Fatal period

- HCN: 2-10 min, sometimes immediate.
- KCN or NaCN: 30 min.

Differential diagnosis: Neurotoxic organophosphates.

Diagnosis: The triad of lab findings is suggestive of cyanide poisoning:

- A narrow arterial-venous oxygen difference
 - An anion gap metabolic acidosis
 - An elevated lactate concentration.
- Measurement of whole blood cyanide in an anticoagulant tube (not done with plasma or serum since cyanide is sequestered in RBCs) can confirm toxicity.
 - HCN is also measured by gas chromatography or spectrophotometry (shows characteristic bands).

Treatment

- Health care provider should always be protected from potential dermal contamination by using protective devices such as water-impervious gowns, gloves and eyewear.
- For patients with dermal exposure, remove clothing, brush off any powder from the skin and flush the skin with water.

The cyanide antidote kit is used as soon as cyanide poisoning is suspected. It contains amyl nitrite, sodium nitrite and sodium thiosulfate.^{3,4} Intravenous sodium nitrite is preferred; amyl nitrite is reserved for cases where IV access is delayed or not possible.

- 0.3 ml ampoule of amyl nitrite is broken in a handkerchief and the victim is made to inhale for 30 seconds, every 3 min.⁵ Stop amyl nitrite, if systolic BP is < 80 mm Hg.
- 10 ml of 3% solution of sodium nitrite is injected IV slowly, followed by 50 ml of 25% solution of sodium thiosulfate at same rate, by the same needle.

Alternative therapy

- Two 20 ml ampoules of 1.5% dicobalt tetracemate (*Kelocyanor*) are given IV followed by 20 ml of 50% glucose.
- 50 ml of 1% sterile aqueous solution of methylene blue may also be used as an antidote.

In case of KCN/NaCN poisoning

- Perform gastric lavage with 5-10% solution of sodium thiosulphate, followed by potassium carbonate to form Prussian blue which is inert.
- Activated charcoal is ineffective (because of low binding of cyanide), but can be given in patient with patent airway.
- Emetics may also be used.
- Hydroxocobalamin (Vit B₁₂) 4-5 g IV is given as infusion.
- Administer crystalloids and vasopressors for hypotension and NaHCO₃ for acidosis.

In case of inhalation of cyanogens gas

- Remove the person from the source of poisoning.
- Control airway, ventilate and use artificial respiration (100% O₂).
- Sodium nitrite and sodium thiosulphate, as above.

In case of mercury cyanide poisoning: Inject BAL also. Survival for 4 h after poisoning is usually followed by recovery.

- *The principle of treatment is to reverse the cyanide-cytochrome combination.* This is done by converting hemoglobin to methemoglobin by giving nitrites. Methemoglobin has a higher binding affinity for cyanide than cytochrome oxidase complex and removes cyanide from cytochrome oxidase.
- Cyanides combine with methemoglobin and form non-toxic *cyanmethemoglobin* which in the presence of rhodanase and sulphate donors, such as thiosulphate, converts cyanide to thiocyanate which is excreted in urine.
- Cyanide is directly converted to thiocyanate by complexing of cyanide with thiosulphate under the influence of enzyme rhodanase.
- Cyanide is also converted to cyanocobalamin by complexing with hydroxocobalamin.

$$\text{Cytochrome oxidase} + \text{NaCN} \rightarrow \text{Cytochrome oxidase cyanide}$$

$$\text{Sodium nitrite} + \text{Hemoglobin} \rightarrow \text{Methemoglobin}$$

$$\text{Methemoglobin} + \text{NaCN} \rightarrow \text{Cyanmethemoglobin}$$

- *Cyanide kit* is proposed by WHO as contingency antidotes and the mainstay of antidotal therapy in US.
- In Europe, 4-dimethylaminophenol (3 mg/kg) is the methemoglobin-inducing agent of choice in place of sodium nitrite which is coadministered with thiosulfate. PAPP (p-aminopropiophenone) can also form methemoglobin, but its action is slow.
- Methemoglobin-inducing agents are no longer utilized in France, and dicobalt EDTA is prescribed.
- Stroma-free methemoglobin (oxidized hemoglobin from which cell membrane has been removed) is an investigational tool—provides exogenous methemoglobin to bind cyanide without compromising the oxygen-carrying capacity of hemoglobin, and removal of cell membrane eliminates antigenicity.

Postmortem Findings

Usually, those of asphyxia.

External

- i. Smell of bitter almonds near the body.⁶
- ii. Face, lips and body surfaces show irregular pink patches or rarely, cyanotic tinge.
- iii. Fine froth at the mouth.
- iv. *Eyes*: Bright, glistening, prominent with dilated pupils.
- v. Rigor mortis appears early.
- vi. Jaws are firmly closed.

Internal

- i. In case of suspected cyanide poisoning, cranial cavity should be opened first as the odor of bitter almonds is well marked in the brain tissue.
- ii. Potassium or sodium cyanide produces slight corrosion of the mouth. Mucosa of the stomach may be eroded and blackened due to formation of alkaline hematin.
- iii. Bloodstained froth in the trachea/bronchi.
- iv. *Brain and meninges*: Hyperemic, diffuse cerebral edema with loss of gray-white differentiation.
- v. Pleura and pericardium may show petechial hemorrhages.

Extremely volatile substance—viscera for chemical examination must be sent in air tight bottles.

Exposure to cyanide vapors during autopsy has been associated with toxic symptoms of cyanide in autopsy personnel (stomach contents containing ingested cyanide salts present the highest risk because the gastric acid converts cyanide salts to volatile HCN gas). Autopsies on victims of cyanide poisoning should be performed in a negative-pressure isolation room and using adequate protective devices.

Medico-legal Aspects

- It is commonly used for suicidal purposes—*ideal suicidal agent*.
- Accidental incidences may be seen occasionally—eating bitter almonds, chemists or technicians handling cyanides in laboratories, smoke inhalation from combustion of materials such as wool, silk, synthetic rubber and polyurethane.
- Homicide is rare—peculiar smell and taste. In ancient Rome, Emperor Nero reportedly used cyanide in the

form of cherry laurel water to poison enemies and family members.

- Embalming can remove/destroy cyanide.
- Small amount of cyanides may be formed in the tissues due to putrefaction.
- Cigarette smokers may have whole blood cyanide levels of 0.4 mg/l, > 2.5 times the mean of non-smokers.

Chronic cyanide poisoning occurs from repeated exposure among photographers or gilders. Such people suffer from headache, vomiting, diarrhea, chronic cachexia and mental disturbances.

Judicial Execution

In some countries, hydrocyanic gas is used for legal execution.

Procedure

The condemned person is strapped in a metal chair with perforated seat, and the straps applied across his upper and lower legs, arms, thighs and chest. A long stethoscope is also affixed to the person's chest so that a doctor sitting outside can monitor the heart beat and pronounce death.

Beneath the chair is a bowl filled with sulphuric acid mixed with distilled water, with sodium cyanide pellets suspended in a gauze bag just above it. After the door is sealed, the executioner in a separate room operates a lever that releases the cyanide into the liquid. This causes a chemical reaction that releases hydrogen cyanide gas which rises through the holes in the chair.

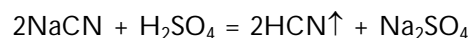

Prisoners are advised to take deep breaths after the gas is released as this will considerably shorten their suffering. Unconsciousness takes place very rapidly, although the heart continues to beat for 10-20 min.

- *Azide* is the conjugate base of hydrazoic acid. The anion inhibits the function of cytochrome oxidase by binding irreversibly to the heme cofactor, in a process similar to that of carbon monoxide.²
- *Linseed oil* (flax seed oil), is a yellowish drying oil derived from the dried ripe seeds of the flax plant (*Linum usitatissimum*). Linseed meal (after extraction of oil) can have cyanide, if made from immature seeds. The meal is safe, if boiled.

MULTIPLE CHOICE QUESTIONS

1. **Bitter almond smell is positive in:** *PGI 04*
A. Chloral hydrate poisoning
B. Hydrocyanic acid poisoning
C. Carbolic acid poisoning
D. Oleander poisoning
2. **All of the following are inhibitors of cytochrome oxidase, except:** *COMEDK 07*
A. Carbon monoxide B. Amytal
C. Cyanide D. Azide
3. **Cyanide poisoning kit does not contain:** *Kerala 04*
A. Sodium thiosulfate
B. Sodium nitrite
C. Sodium bicarbonate
D. Amyl nitrite
4. **Amyl nitrite is antidote for:** *Delhi 03*
A. Aconite poisoning
B. Cyanide poisoning
C. CO poisoning
D. H₂S poisoning
5. **The route of administration of amyl nitrite in cyanide poisoning is:** *Karnataka 07*
A. Intramuscular B. Intravenous
C. Subdermal D. Inhalation
6. **At autopsy, the cyanide poisoning case will show the following features, except:** *AI 05; Himachal 10*
A. Characteristic bitter lemon smell
B. Congested organs
C. Skin may be pinkish or cherry red in color
D. Erosion and hemorrhages in esophagus and stomach

Asphyxiant gas is a non-toxic or toxic gas which causes respiratory embarrassment leading to unconsciousness or death by asphyxiation. The brain is commonly affected.

There are two broad categories of asphyxiants: simple and chemical.

- i. **Simple asphyxiants:** They are physiologically inert gases that displace O₂ from ambient air resulting in fall in partial pressure of O₂ in the alveoli, e.g. acetylene, CO₂, argon, helium, ethane, nitrogen and methane.
- ii. **Chemical asphyxiants:** They interfere with the transportation or absorption of O₂ in the body and interfere with cellular metabolism causing cells to become O₂ starved. It can be:
 - a. **Irritant gases:** They produce toxic effect by destruction of the integrity of the mucosal barrier of the respiratory tract (damage to both type I and type II pneumocytes), e.g. ammonia, H₂S, formaldehyde, phosgene and SO₂.
 - b. **Systemic asphyxiants:** They produce significant systemic toxicity by various mechanisms, e.g. CO, cyanide and smoke.

Carbon Monoxide (CO)

Properties

- CO is a colorless, tasteless, non-irritative and odorless gas, and lighter than air.
- It produced by incomplete combustion of carbonaceous material.
- It combines with chlorine and forms carbonyl chloride—commonly called *phosgene*.

Sources

- Common sources of CO include tobacco smoking, automobile exhaust (1-7% CO), industrial processes, unvented or faulty heating units (stove, water heater or furnace) and fires.
- Coal gas (mixture of CO, methane and hydrogen).
- Endogenous CO.

Action

- CO combines reversibly with hemoglobin to form carboxyhemoglobin (COHb) producing *anemic hypoxia* (blood O₂-carrying capacity is reduced).¹ It has a high affinity for Hb (about 250 times more than O₂).
- It inhibits the electron transport by blocking cytochrome A₃ oxidase and cytochrome P450 and hence *intracellular respiration*.
- About 15% of CO present in extracellular tissues combines with myoglobin (affinity constant—40).

Signs and Symptoms

Most frequent acute symptoms are headache (dull, frontal and continuous), dizziness, weakness, nausea and confusion.

COHb (%)	Signs and symptoms
0-10	No symptoms.
10-20	Breathlessness, mild headache, abdominal pain.
20-30	Throbbing headache, irritability, emotional instability, buzzing in the ears.
30-40	Severe headache, nausea, vomiting, dizziness, dimness of vision, confusion, ataxia.
40-50	Increasing confusion, hallucinations, rapid respiration, staggering and incoordination— <i>mistaken for drunkenness</i> .
50-70	Weak thready pulse, hypotension, irregular respiration, convulsions, coma and death.
> 80	Rapid death from respiratory arrest.

- On examination, there may be tachycardia, hypertension or hypotension, hyperthermia, flame-shaped retinal hemorrhages and bright red retinal veins.
- CNS is most sensitive followed by heart (MI, dysrhythmias). Patients display memory disturbance (most common) including retrograde and anterograde amnesia with amnestic confabulatory state.

Severity of CO poisoning

COHb (%)	Severity of poisoning
10-30	Mild
30-40	Moderate-severe
> 40	Very severe

Fatal dose and fatal period

The normal atmospheric concentration of CO is usually < 0.001% (10 ppm). The atmospheric concentration can exceed 0.01% (100 ppm) in heavy urban traffic and during periods of atmospheric stagnation.

CO concentration (%)	Fatality (hours)
0.2	4
0.4	1
10	½

Diagnosis: Misdiagnosis is common because of the vagueness and broad spectrum of complaints; symptoms often are attributed to viral illness (influenza).

- **History:** Following should alert suspicion: winter months, exposed to the previously named sources and when more than one patient in a group or household in a particular enclosed site presents with similar complaints.
- **Laboratory findings:** COHb analysis can be done by direct spectrophotometric measurement in specific blood gas analyzers. Bedside pulse CO-oximetry is available. Breath CO monitoring is an alternative to pulse CO-oximetry.

• **CT:** Symmetric low density areas in the region of globus pallidus, putamen and caudate nuclei are frequently seen within 12 h of CO exposure that resulted in unconsciousness.

Lab diagnosis

- Spectroscopic test:** Shows two absorption bands similar to oxyhemoglobin, but placed nearer the violet end.
- Hoppe-Seyler's test:** Few drops of blood + 10% NaOH → Greenish brown (normal blood), Pink/red (COHb).
- Kunkel's test:** Diluted blood (1: 10) + few drops of 3% tannic acid (shake) → Deep brown (normal), Crimson-red coagulum (COHb).
- Potassium ferrocyanide test:** 15 cc of blood + 15 cc of 20% potassium ferrocyanide + 2 cc diluted acetic acid → Dark brown coagulum (normal), bright-red coagulum (COHb).
- Katayama's test** using ammonium sulphide and acetic acid is less delicate.

Differential Diagnosis

- Alcoholic intoxication
- Diabetic/Insulin coma
- Cerebral hemorrhage
- Head injury
- Uremia
- Barbiturates/Narcotic poisoning

Treatment

The mainstay of treatment is initial attention to the airway.

- Remove the victim from source of exposure.
- Maintain patent airway, fresh air and orthobaric oxygen (100% oxygen at atmospheric pressure) by tight-fitting high-flow reservoir face mask or endotracheal tube.² The immediate effect of oxygen is enhancement of the dissociation of COHb.
- Hyperbaric O₂ (HBO) at PO₂ of 2-3 atmospheric pressure mixed with 5% CO₂ may be given through mask or intratracheal tube.
- Blood transfusion, if required.
- Gastric lavage to prevent aspiration pneumonia.
- Cerebral edema is treated by mannitol 500 ml IV as 20% solution over 15 min, followed by 500 ml of 5% dextrose over next 4 h.
- Hypotension is initially treated with IV fluids followed by inotropic agents. Standard ACLS protocols are followed to treat dysrhythmias.
- Antibiotics and symptomatic treatment.

Postmortem Findings**External**

- Cherry red coloration** of the skin, mucous membranes, PM staining, blood, tissues and internal organs.^{3,4} The red lividity is usually associated with a COHb level > 30% CO. In dark-skinned individuals, fingernail beds can be examined.
- Fine froth at the nostrils/mouth.
- Blisters of skin over dependent areas or bony pressure points such as buttocks, calves, wrists and knees due to cutaneous edema.

Internal

- Lung:** Edema and congestion.
- Heart:** Lesions vary from petechial hemorrhages to myocardial necrosis.
- Rhabdomyolysis from the direct toxic effects of CO, and prolonged immobility lead to renal failure.
- CNS:** Neuronal hypoxic injury is most pronounced in the deep gray matter, usually in a symmetrical distribution. Punctiform hemorrhages and softening of cerebral cortex and corpus striatum—particularly globus pallidus.

In addition to routine viscera, lungs and brain are preserved for analysis. If blood is not available for CO determination, spleen, liver or skeletal muscle can be utilized.

Medico-legal Aspects

- It is a *common mode of suicidal poisoning* in the West (by inhaling motor vehicle exhaust), but rare in India.
- **Accidental cases:** Common in India from cooking gas leakage and incomplete combustion of wood, charcoal or coal in ill-ventilated rooms.

- Unintentional fatalities occur in stationary vehicles from malfunctioning exhaust systems or operation in an enclosed space.
- CO presents greater risk to firefighters and victims than thermal injury or oxygen deprivation.
- Malfunctioning heating systems (e.g. blocked chimney) using combustible fuels can cause fatal CO poisoning.
- Homicide is uncommon (e.g. exhaust fumes used to poison an immobilized person). A victim of CO poisoning can be placed in a bed to simulate a natural death.
- Masochistic sexual asphyxia may be due to CO.
- Heavy smokers may have COHb level upto 10%.
- COHb can be detected even in a putrefied or embalmed body, and it is not a product of putrefaction.

Two features of CO poisoning may create confusion:

- Bullous lesions on the body which simulate 2°C thermal burn, deep coma, early putrefaction, antemortem and postmortem gasoline exposure.
- Tendency of the dying victim to wild, flailing movements inside the room, disturbing clothing and furniture which gives an impression of a violent tussle, thus creating a suspicion of murder.

Carbon Dioxide (CO₂)

Properties

- CO₂ is a heavy, colorless and odorless (slightly irritating) gas.
- Constituent of atmosphere air (0.4%).
- Slightly acidic in taste.

Sources

- It is formed during respiration, combustion, fermentation and putrefaction of organic matter, mine explosion, refrigerating plants and limekilns.
- Solid form is known as *dry ice*.
- Found in old wells, mine shafts and damp cellars.

Action

Pure CO₂ causes vagal inhibition along with glottis spasm leading to instant death. All symptoms are due to lack of O₂.

Signs and Symptoms

Blood CO ₂ (%)	Signs and symptoms
0-2	No symptoms.
2-5	Increased respiration, throbbing headache.
5-10	Hyperpnea, tinnitus, mental confusion, muscular tremors.
10-20	Slow respiration, fall in blood pressure.
20-40	Dyspnea, muscular weakness, fall in blood pressure, loss of reflexes.

40-60	Dyspnea, feeling of tightness in chest, tinnitus, muscular weakness, drowsiness, unconsciousness, coma and death.
60-80	Immediate unconsciousness, convulsions, death due to asphyxia (cerebral hypoxia).

Fatal concentration

- Minimum: 25-30%.
- Maximum: 60-80%.

Fatal period: Instant collapse and death.

Treatment

- Shift to fresh atmosphere.
- Maintain body warmth.
- Artificial respiration with oxygen therapy.
- Tham (2-amino-2 hydroxymethyl-1, 3-propanediol) an amine buffer may be given IV.
- Cardiac stimulants, like amphetamine sulphate can be used.

Postmortem Findings

Features of asphyxia are found.

- Cyanosis, and the pupils are dilated.
- Marked capillary and venous congestion.
- Petechial hemorrhages.
- Froth at the nostrils and mouth.
- Blood is dark and fluid.
- Deep congestion of the viscera.

Medico-legal Aspects

- Poisoning is mostly accidental. The gas being heavier settles at the bottom and may affect workmen associated with well sinking, well cleaning and descending in pits and ship holds.
- Blood CO₂ accumulates during postmortem. Of critical importance is analysis of air-sample collected from the scene for CO₂ content.
- Sometimes, anesthetist causes fatality by giving CO₂ in place of O₂ by mistake.

Hydrogen Sulphide (H₂S)

Properties

- H₂S is a colorless, transparent gas with smell of rotten eggs.
- It dissolves in water, and burns in air with a pale blue flame.

Sources

- **Natural:** Caves, volcanoes, decaying fish, sewage (sewer gas), manure and putrefying cadaver.⁵

- **Industrial:** Petroleum and tanning industry, silk, rayon and paper manufacturing processes.

Action

- H₂S does not combine with hemoglobin, but does so with methemoglobin to form sulphmethemoglobin.
- It causes asphyxiation by interfering with the use of oxygen in the cytochrome oxidase system.
- Its toxicity and rapidity of action is comparable to hydrocyanic acid (HCN).

Signs and Symptoms

Significant H₂S poisoning usually occurs by inhalation. As a cellular poison, H₂S affects all organs, particularly the CNS and pulmonary system.

System	Signs and symptoms
CNS	Headache, vertigo, nystagmus, weakness, coma.
CVS	Arrhythmia, myocardial depression.
Ocular	Lacrimation, photophobia, conjunctivitis.
RS	Rhinitis, pneumonia, pulmonary edema.

The presence of H₂S is apparent because of the characteristic rotten egg smell. However, concentrations > 150 ppm may overwhelm the olfactory nerve so that the victim may have no warning of exposure.

Fatal dose and fatal period

H ₂ S concentration (ppm)	Clinical effects
> 200	Anosmia, pulmonary edema
> 500	Hyperpnea, apnea
> 1000	Respiratory paralysis, death

Exposure of > 700-800 ppm can cause immediate cardiopulmonary arrest.

- **Detection:** H₂S, if present in significant concentration, can be tested by exposing a filter paper moistened with lead acetate. The filter paper will turn black.
- **Spectroscopic test:** It is characterized by absorption spectrum of two bands consisting of one band in the red between C and D and a fainter band between D and E.

Differential diagnosis: Smoke inhalation, CO, cyanide and hydrocarbons.

Treatment

High-flow (100%) O₂ is the mainstay of therapy for H₂S poisoning.

- Remove the victim into fresh air.
- Artificial respiration and 100% O₂ is given.
- Antidote:** Amyl nitrite and sodium nitrite (without thiosulphate) enhance formation of methemoglobin which in turn is spontaneously detoxified in the body.*
 - Break 0.2 cc ampoule of amyl nitrite in a handkerchief and hold over the patient's nose for 15-30 seconds.
 - 0.3 g of sodium nitrite in 10 cc of sterile water is given slow IV for over 2-3 min.
- Supportive measures:** Correction of electrolyte imbalance and pulmonary edema.

Postmortem Findings

- Signs of asphyxia (cyanosis, frothing at the mouth and nose, and petechial hemorrhages in respiratory mucosa) are seen.
- Rotten egg odor is present around the nostrils and mouth.
- Greenish discoloration of viscera, gray matter of brain and bronchial secretions may be found.
- Pulmonary edema and congestion of viscera are seen.

Medico-legal aspects

- Poisoning is always accidental, causing number of deaths in sewer workers. The petroleum industry is responsible for most cases of H₂S toxicity in North America.

- H₂S has recently been implicated in suicides in Japan.⁶

Chronic H₂S exposure causes headache, weakness, nausea, weight loss, ataxia and tremors.

- Patient can lose their ability to smell/detect the gas even though it is still present in the environment (olfactory fatigue/paralysis).
- Low-level exposure of H₂S affects the mucous membranes, and may cause conjunctivitis, pharyngitis, green-gray line on gingiva and wheezing.

Detergent or chemical suicide: In Japan, it is a newer method of committing suicide and is gaining popularity in other countries from internet suicide websites. A near-instant death may occur by mixing common household chemicals—bath sulfur (5-30% calcium polysulfides) with toilet bowl cleaner (15% HCl)—to create H₂S gas in cars, closets or other enclosed spaces.

* Based on the similarities in cyanide and H₂S toxicity, induced methemoglobinemia may be used for the treatment of H₂S toxicity. Methemoglobin acts as a scavenger, and it is more attracted to H₂S than cytochrome oxidase.

MULTIPLE CHOICE QUESTIONS

1. **Carbon monoxide poisoning causes:** *JIPMER 11*
 A. Anemic hypoxia B. Histotoxic hypoxia
 C. Anoxic hypoxia D. Stagnant hypoxia
2. **In CO poisoning, immediate emergency treatment:** *Jharkhand 10*
 A. 5% CO₂ inhalation B. 10% CO₂ inhalation
 C. High flow O₂ D. Nitroglycerine
3. **Cherry red color in postmortem staining is a feature of poisoning with:** *WB 08*
 A. Nitrites B. Aniline
 C. Phosphorus D. CO
4. **Postmortem finding in CO poisoning is:** *UP 09; PGI 10*
 A. Cherry red hypostasis B. Intense cyanosis
 C. Excessive salivation D. Pin-point pupil
5. **Sewer gas is:** *PGI 03*
 A. Phosgene B. H₂S
 C. CO₂ D. CO
6. **Death caused in suicide by household things in Japan is due to the production of:** *AI 12*
 A. Acidic solution B. H₂S
 C. HCN gas D. CO

1. A

2. C

3. D

4. A

5. B

6. B

War Gases and Biological Weapons

57

War Gases

Definition: War gases are chemicals (gas, liquid or solid) which are used for producing destruction or damage, mostly at times of war. These also include chemicals being used for dispersing unruly mobs.

Chemical warfare (CW) involves using the toxic properties of chemical substances as weapons.

This type of warfare is distinct from nuclear warfare and biological warfare which together make up NBC—the military acronym for Nuclear, Biological and Chemical (warfare or weapons).

Types of Chemical Warfare Agents (CWAs)

Major categories of CWAs are:

- i. Asphyxiants or lung irritants
- ii. Vesicants or blister gases
- iii. Lacrimators or tear gases or riot control agents
- iv. Sternutators or nasal irritants
- v. Nerve gases
- vi. Paralysants
- vii. Miscellaneous.

Asphyxiants/Lung Irritants/Choking Gases

- These are chlorine and phosgene (CG) gas and can be released from tanks and gas shells.
- Phosgene is ten times more toxic than chlorine.
- Their action is mainly on the pulmonary alveoli.
- *Symptoms:* When inhaled, they cause watering of the eyes, coughing, dyspnea, tightness of chest, headache, vomiting, restlessness, stertorous breathing, cyanosis and collapse.
- Death occurs in 24-48 h due to acute pulmonary edema or bronchopneumonia.

Treatment

- i. Remove the patient into fresh air.
- ii. Wash the eyes with normal saline and boric acid.
- iii. Oxygen and adrenaline when needed.
- iv. Antitussives (e.g. codeine) for cough, and antibiotics for infection.

Vesicants/Blister Gases

- Mainly mustard gas (dichloroethyl sulphide or yperite) and lewisite (dichlorarsine).¹
- These are volatile liquids and discharged in artillery shells so as to saturate the area of attack.

Symptoms

- Mustard gas causes irritation of the eyes, nose, throat and respiratory passages, nausea, vomiting and abdominal pain. It penetrates the clothes and produces intense itching, redness, blisters, and ulceration, especially of the moist areas of the skin.
- Lewisite causes blisters in skin and inflammation of mucous membrane, and on absorption produces signs of *arsenic poisoning*.

Treatment

- i. Wash the affected parts thoroughly with soap and water.
- ii. Wash eyes with sodium bicarbonate solution.
- iii. Use BAL as an antidote to lewisite.

Lacrimators/Tear Gases

- Mainly chloracetophenone (CAP) which is solid, and ethyliodoacetate (KSK) and bromobenzylcyanide (BBC) which are liquids. These are fired in artillery shells or pen guns.
- *Symptoms:* The vapors cause intense irritation of the eyes, lacrimation, spasm of the eyelids and temporary blindness with irritation of air-passages.
With long continued exposure, there may be nausea, vomiting and blistering of skin.
- *Treatment:* The patient should be removed into fresh air and the eyes washed with warm normal saline or boric acid solution. Weak sodium bicarbonate solution is applied to the affected parts of the skin.

Sternutators/Nasal Irritants/Vomiting Gases

- They are diphenyl chlorarsine (DA), diphenylamine chlorarsine (DM) and diphenyl cyanarsine (CD).

- These are solid, organic compounds of arsenic and are fired in artillery shells to control riots.
- *Symptoms*: The vapors cause intense pain and irritation in the nose and sinuses, sneezing, headache, malaise, salivation, nausea, vomiting, tightness in the chest and prostration.
- *Treatment*: The patient should be removed into fresh air and the nose irrigated with 5% sodium bicarbonate.

Nerve Gases

- The major agents are GA (Tabun), GB (Sarin), GD (Soman) and VX.²
- These colorless and odorless volatile liquids are esters of phosphoric acid and are identical to organophosphates in their biological activity.
- They are absorbed from the lungs, GIT, skin or conjunctiva and inhibit acetylcholine esterase.
- *Symptoms*: Exposure to a large amount of vapor will cause loss of consciousness within seconds, followed by convulsions after few minutes. Muscles become flaccid and breathing stops.
- *Treatment* is similar to organophosphates.

Paralysants

These are hydrocyanic acid, hydrogen sulphide and carbon monoxide which have been described earlier.

Miscellaneous

- These include yellow/red rain and methyl isocyanate (MIC).
- *Symptoms*: Acute irritation of the eyes, lacrimation, blurring of vision, severe burning sensation in the throat, chest pain and labored breathing. Death is caused by pulmonary edema.
- *Treatment* is symptomatic. Sodium thiosulphate may act as an antidote.

The accidental release of a methyl isocyanate cloud was implicated in the Bhopal disaster in 1984.

Biological Weapons

Definitions

- **Biological weapons** are organisms or toxins found in nature which can be used to incapacitate, kill or otherwise impede an adversary.
- **Bioterrorism** is the deliberate release of viruses, bacteria, toxins or other harmful agents causing illness or death in people, animals or plants.

Types of Biological Warfare Agents

The CDC in US has categorized these biological warfare agents as under (Table 57.1):

- Category A**: These high-priority agents can be easily transmitted and disseminated, result in high mortality, have potential major public health impact, may cause public panic or require special action for public health preparedness.
- Category B**: These agents are moderately easy to disseminate and have low mortality rates.
- Category C**: These agents are emerging pathogens that might be engineered for mass dissemination because of their easy availability, ease of production and dissemination, high mortality rate or ability to cause a major health impact.

Some of them are described below:

- 1. Anthrax**: Anthrax is a non-contagious disease caused by the spore-forming bacterium *Bacillus anthracis*. It usually affects animals. Humans who have contact with infected animals or animal products such as wool or hide can get the disease. There are three types of anthrax infections depending upon the route of entry of the spores.
 - *Cutaneous*: Symptoms are caused by skin contact with infected animal materials. Blisters and ulcers develop in the skin.
 - *GIT*: It is caused by consumption of under cooked meat of infected animals. Symptoms are fever, nausea, hemoptysis and bloody diarrhea.
 - *Respiratory*: It is caused by inhalation of the spores. Symptoms are fever, cough and myalgia. Later serious respiratory symptoms may appear.

Mode of transmission: Anthrax is propagated by terrorists in a powder form. Common method is by sending letters smeared with spores to target victims. When the letter is handled, spores enter the body by inhalation and skin contact.
- Anthrax spores are highly stable and can be dispersed by enclosing them in bombs and ammunitions. When the bombs explode, anthrax spores are liberated into the atmosphere.

Treatment: It can be treated with antibiotics. Anthrax vaccination is available as a prophylactic measure.
- 2. Botulism** is caused by a toxin generated by bacterium *Clostridium botulinum*, and results in serious neurological symptoms. This toxin is more toxic than cyanide. The toxin is readily available because of its widespread use in cosmetology.

Table 57.1: Categories of biological warfare weapons

Category A	Category B	Category C
<ul style="list-style-type: none"> • Anthrax • Botulinum toxin • Viral hemorrhagic fever • Bubonic plague • Smallpox • Tularemia 	<ul style="list-style-type: none"> • Brucellosis • Water borne threats (e.g. <i>Vibrio cholera</i>) • Food poisoning threats (e.g. <i>Salmonella</i>, <i>E coli</i>, <i>Staphylococcus aureus</i>) • Ricin and abrin • Q fever • Staphylococcal enterotoxin B • Typhus, viral encephalitis 	<ul style="list-style-type: none"> • Brucellosis • Nipah virus • H1N1, a strain of influenza • SARS • HIV/AIDS

Symptoms: Botulism causes death by respiratory failure and paralysis.

Mode of transmission: The toxin is propagated as lyophilised powder enclosed in rockets and bombs. The toxin enters the body through air, contaminated food and water.

Treatment: Antitoxin is effective in reducing the severity of symptoms.

3. **Plague:** Plague is caused by *Yersinia pestis*, a bacterium found in rodents and their fleas. Rodents are the normal host of plague and the disease is transmitted to humans by flea bites (bubonic plague) and occasionally by aerosol (pneumonic plague).

Symptoms include swollen and tender lymph nodes called buboes. If untreated, the bacteria spread through the bloodstream and infect lungs causing pneumonia. In pneumonic plague, the person has fever, weakness and rapidly developing pneumonia with dyspnea, chest pain, cough and bloodstained sputum. If untreated, death occurs due to respiratory failure and shock.

Mode of transmission: One of the methods is by releasing infected rat fleas in enemy country. The fleas are kept in porcelain containers attached to projectiles, like rockets and bombs before firing at targets.

Treatment: It is treated with broad-spectrum antibiotics. There is no vaccine available to prevent plague. Plague bacteria are destroyed by sunlight and drying.

4. **Smallpox:** Smallpox is caused by the virus *variola major* which is highly contagious and has a high mortality rate (20-40%). It occurs only in humans and has no external hosts or vectors.

Symptoms include fever, headache, fatigue, diarrhea, vomiting and a specific rash. The rash first starts as flat red spots which turn into blisters. Blisters contain a clear fluid initially and then pus as the disease progresses.

Mode of transmission: It is spread through aerosols and infected material. Even though smallpox has been eradicated throughout the world, virus samples are still available in laboratories of some countries (Russia and US).

As a biological weapon, smallpox is dangerous because vaccines are no longer administered to the general population, and in the event of an outbreak most people would be unprotected.³

Treatment: There is no specific drug to treat smallpox.

5. **Viral hemorrhagic fever:** This includes hemorrhagic fever caused by members of the family *Filoviridae* (e.g. Ebola and Marburg virus) and by the family *Arenaviridae* (e.g. Lassa and Machupo virus). Ebola and Marburg virus have high mortality rates. It is believed that some terrorist group possesses Ebola virus culture. The fatality rate of arenaviruses is less compared to those caused by filoviruses.

Death from Ebola virus disease is commonly due to multiple organ failure and hypovolemic shock.

Treatment: There is no effective treatment and prophylaxis for these viral infections, although vaccines are in the process of development.

6. **Tularemia:** Tularemia or rabbit fever is caused by *Francisella tularensis* bacterium through contact with fur, inhalation or ingestion of contaminated water or by insect bites. It is a highly infectious disease and requires only a small number of organisms (10-50) to cause it. *Symptoms:* On inhalation, there is severe respiratory illness, including life-threatening pneumonia, and if left untreated systemic infection may result. *Mode of transmission:* If it used as a weapon, the bacteria would likely be made airborne for exposure by inhalation.

7. **Brucellosis:** Brucellosis is an infectious disease caused by *Brucella* bacteria. The bacteria affect cattle, dogs, pigs and other animals. Humans become infected by

coming into contact with animals or animal products contaminated with these bacteria.

Symptoms: Fever, headache, back pain and weakness are seen. Sometimes endocarditis and encephalitis may develop. Brucellosis can also cause chronic symptoms like recurrent fever, joint pains and fatigue.

Mode of transmission: Air, water and food articles are contaminated by terrorists. The bacteria can also enter through skin wounds. When cattle are infected, their milk contains the bacteria. Intake of unpasteurized milk can transmit the bacteria to those people who consume the milk.

8. **Ricin toxin:** Ricin obtained from *Ricinus communis*, is one of the most poisonous naturally occurring

substances known. Ricin is toxic by numerous exposure routes and its use by terrorists might involve poisoning of water or foodstuffs, inoculation via ricin-laced projectiles, or aerosolization of liquid ricin or distribution of powder.

9. **Salmonella:** This can be done by contaminating foodstuffs in restaurants, bars and grocery stores and lead to severe food poisoning.

Symptoms include vomiting, nausea, diarrhea and abdominal pain. It is sometimes associated with very high fever. This condition can last for upto a week. Most severely affected are infants, elderly and those with poor immunity.

MULTIPLE CHOICE QUESTIONS

1. **Blistering war gas is:**

A. Chlorine gas B. Mustard gas
C. HCN gas D. Tabun

Maharashtra 09

2. **Nerve gas is:**

A. Methyl isocyanate B. Phosgene
C. Diphenylchloroarsine D. Sarin

TN 10

3. **Most important and potential agent that can be used in bioterrorism:**

A. Plague
B. Smallpox
C. Tuberculosis
D. *Clostridium botulinum*

AI 11

Organophosphorus Compounds (OPCs)

Introduction: Insecticides are substances used to destroy insects harmful to agricultural, industrial and domestic items. OPCs and carbamates are extensively used as pesticides for soft-bodied insects in agriculture.

Classification

Based on chemical composition

- *Alkyl phosphates:* Tichlorfos, dimefox, HETP, TEPP and malathion.¹
- *Aryl phosphates:* Parathion (Follidol), paraoxon, chlorthion and diazinon (Tik-20).

Based on toxicity

- Agriculture insecticide (highly toxic): TEPP, parathion.
- Animal insecticide (moderately toxic): Trichlorfon, ronnel.
- Household insecticide (low toxicity): Malathion, Tik-20.

Common OPCs: Chlorpyrifos (Chlorofos 20), diazinon (Tik-20), malathion (Finit), dimethoate, parathion, trichlorphon (Diptrenex) and glyphosate (Weed off).²

Common carbamates: Aldicarb (Temik), carbaryl (Sevin 50), propoxur (Baygon), carbaryl + gamma BHC (Sevidol), physostigmine, neostigmine, pyridostigmine, edrophonium and ambenonium.

Action

- The primary mechanism of action of OPCs and carbamates is inhibition of acetylcholinesterase (AChE) and plasma or butyryl cholinesterase (pseudo-cholinesterase or BuChE) by phosphorylating the serine hydroxyl residue on AChE or BuChE. Hence, these compounds are called *cholinesterase inhibitors*. It blocks the conversion of acetylcholine to its degradation products—acetic acid and choline (Fig. 58.1).³
- Once AChE has been inactivated, acetylcholine accumulates in the autonomic nervous system, somatic nervous system and brain, resulting in over-stimulation of muscarinic and nicotinic receptors.
- Organophosphorus insecticides irreversibly inhibit AChE, but carbamates are eliminated rapidly by serum and liver enzymes.³
- Carbamates do not penetrate the CNS to the same extent, resulting in limited CNS toxicity.

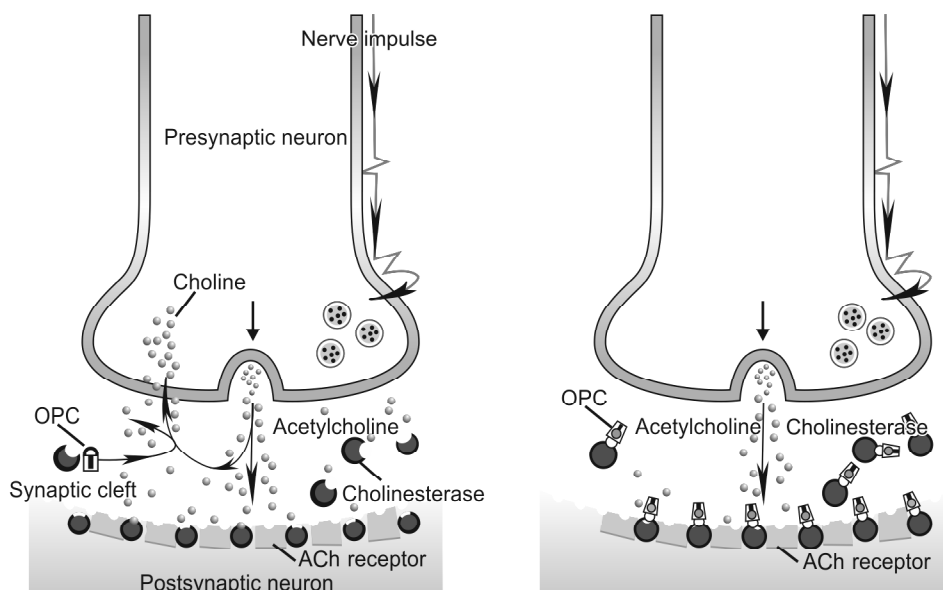

Fig. 58.1: OPCs 'lock' the AChE enzyme which prevents it to break acetylcholine

Absorption: OPCs and carbamates are absorbed by many routes including transdermal, transconjunctival, inhalational, across the GIT and through direct injection.

Metabolism: Most OPCs are hydrolyzed by enzymes, the A esterases or paroxonases which are not inhibited by it. These enzymes are found in the plasma and in the hepatic endoplasmic reticulum. The metabolic products are then excreted in the urine.

Signs and Symptoms

Time of exposure to onset of toxicity varies from half an hour to 2 h. Signs and symptoms can be divided into three broad categories (Fig. 58.2).⁴⁻⁶

i. Muscarinic or parasympathetic manifestations

System	Signs and symptoms
GIT	Increased salivation, nausea, vomiting, retro-sternal pain, abdominal cramps, diarrhea, fecal incontinence.
CVS	Bradycardia, hypertension.
RS	Rhinorrhoea, bronchospasm, bronchorrhoea, cough, wheezing, dyspnea.
Ocular	Blurred vision, miosis.
Glands	Increased lacrimation, <i>chromolacryorrhoea</i> (shedding of red tears due to accumulation of porphyrin in lacrimal glands), rhinorrhoea, sweating. ⁷

OPCs are usually mixed with a solvent aromax, which is responsible for kerosene-like smell in the breath and body secretions.

Mnemonics for signs and symptoms:

- **Sludge:** Salivation, lacrimation, urination, diarrhea, gastrointestinal distress and emesis.
- **Dumbels:** Diaphoresis, diarrhea, urination, miosis, bradycardia, bronchospasm, bronchorrhoea, emesis, lacrimation and salivation.

ii. Nicotinic or autonomic ganglionic and somatic motor effects:

It includes muscle fasciculations, cramps and weakness, twitchings and diaphragmatic failure, and can progress to paralysis, areflexia and respiratory failure. Autonomic effects include hypertension, tachycardia, mydriasis and pallor.

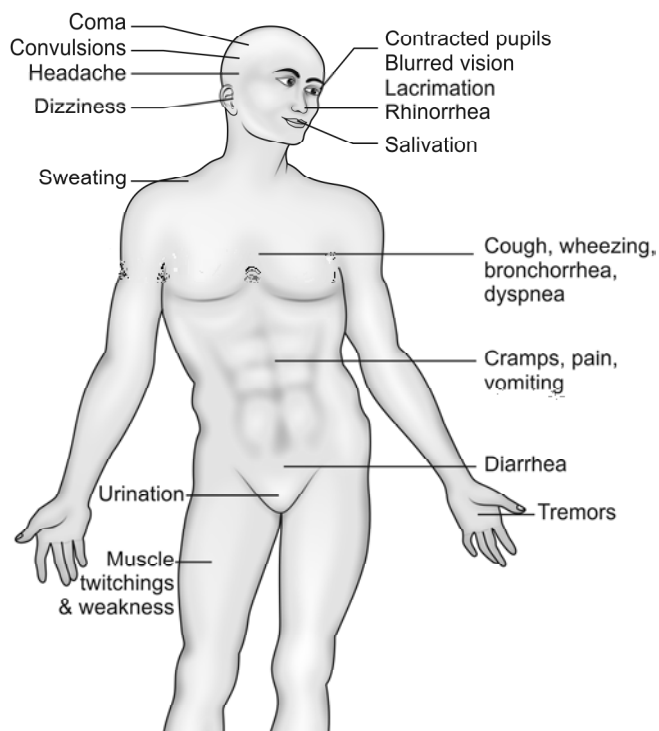

Fig. 58.2: Signs and symptoms of OPC poisoning

iii. **CNS effects:** It includes restlessness, emotional lability, headache, tremors, drowsiness, confusion, slurred speech, ataxia, generalized weakness, Cheyne-Stokes respiration, delirium, coma, absent reflexes, seizures, psychosis and death.

Signs and symptoms also depends on the degree of exposure (Table 58.1).

Most patients recover within 24-48 h, but fat-soluble OPC may cause effects for weeks to months. Death is most often due to pulmonary toxicity.

Fatal dose

- Malathion and diazinon 1 g.
- Parathion: 15-30 mg.

Fatal period: Usually within 24 h in untreated cases and within 10 days in treated cases, if unsuccessful.

Table 58.1: Signs and symptoms depending on exposure

Mild exposure	Moderate exposure	Severe exposure
<ul style="list-style-type: none"> • <i>GIT:</i> Nausea, anorexia, cramping without diarrhea • <i>CNS:</i> Fatigue, headache, dizziness, tremors of tongue and eyelids, anxiety • <i>MS:</i> Minimal muscle weakness • <i>Ocular:</i> Miosis, decreased visual acuity 	<ul style="list-style-type: none"> • SLUDGE • <i>CNS:</i> Anxiety, confusion, lethargy, incoordination • <i>RS:</i> Respiratory muscle weakness • <i>MS:</i> Tremors, muscle fasciculations, followed by flaccid paralysis 	<ul style="list-style-type: none"> • SLUDGE • <i>CNS:</i> Convulsions, coma, loss of sphincter tone, paralysis, autonomic dysfunction • <i>RS:</i> Insufficiency, pulmonary edema • <i>CVS:</i> Bradycardia, heart block

Laboratory Diagnosis

The diagnosis of OPC poisoning is made primarily based on the history and a combination of clinical features, including the typical odor of the insecticide.

The essential finding in laboratory diagnosis is *depression of cholinesterase activity*. In acute poisoning, signs and symptoms generally occur when > 50% of cholinesterase is inhibited.⁸

- *RBC (true) cholinesterase*: It is found in the CNS gray matter, RBCs and motor end plate.
- *Plasma (pseudo) cholinesterase*: It is found in the CNS white matter, plasma, liver, pancreas and heart.

RBC cholinesterase is considered more accurate of the two; however, plasma cholinesterase activity is easier to assay and generally more readily available, but declines rapidly. Blood cholinesterase level should be estimated for 3 weeks in non-fatal parathion poisoning.

P-nitrophenol test: P-nitrophenol is a metabolite of some OPCs (e.g. parathion, ethion) and is excreted in the urine. Its presence in the urine can be used as a confirmation test of OPC poisoning. This test can also be done on vomitus or gastric lavage contents.

Differential Diagnosis

Gastroenteritis, asthma, heat prostration, influenza, exhaustion, hypoglycemia, pneumonia, carbon monoxide poisoning, narcotic overdose, ketoacidosis, sepsis, meningitis, encephalitis, Reye's syndrome, neurologic disorders and subdural or epidural hematoma.

Treatment

The patient is treated according to the severity of the symptoms as shown in Flow chart 58.1.⁹

i. Decontamination

- Patient is removed from source of exposure, stripped of his clothes and the skin flushed with water.
- Doctor and nurses should be protected with water-impermeable gowns, masks with eyeshields and use double gloves while handling the patient.
- *Gastric lavage*: It should only be undertaken once the patient is stable. Gastric emptying should be done with continuous suction via a nasogastric tube with 1:5000 KMnO₄. Activated charcoal should be administered in doses of 1 g/kg.

Flow chart 58.1: Management of OPC poisoning

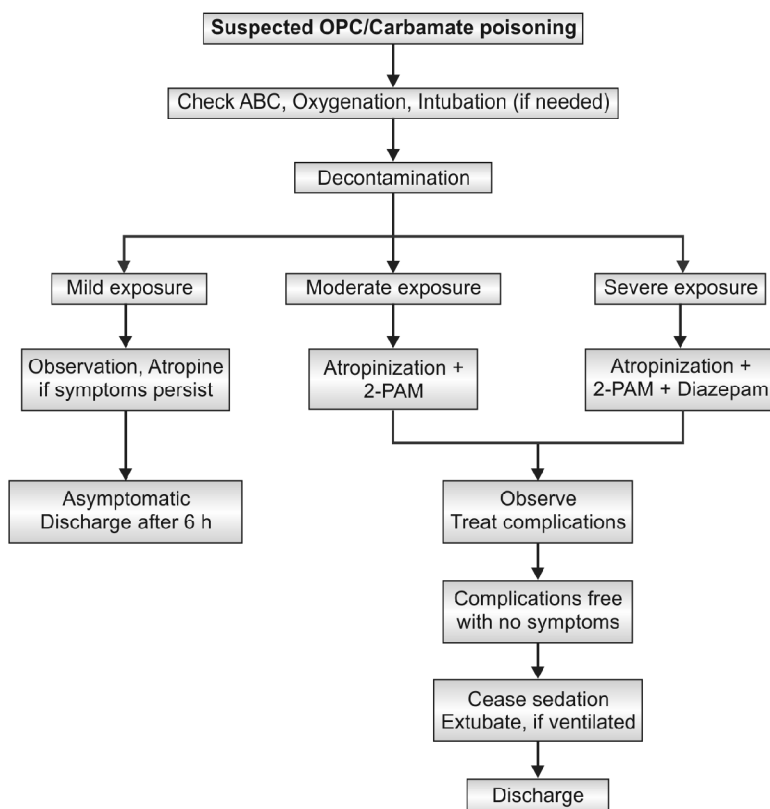

- Patients with ocular exposures should have copious eye irrigation with normal saline or lactated Ringer's solution. If these are not available, tap water can be used.

ii. **Atropinization:** Atropine blocks the muscarinic manifestations and has no effect on nicotinic receptors (on muscle weakness or paralysis) and does not affect the rate of regeneration of inhibited AChE.¹⁰

Dose: 2-4 mg IV (0.05-0.2 mg/kg in children) repeated after every 5-15 min till atropinization, the dose should be adjusted to maintain this effect for at least 24 h (maintenance dose: 0.02-0.05 mg/kg).

Atropinization is clearing up of the secretions from the tracheobronchial tree and drying up of most secretions. *Mydriasis is an early response to atropine and is not a therapeutic end point.* A common failure of therapy is not maintaining adequate atropinization.

Glycopyrrolate may be substituted, if there is no evidence of central toxicity.

iii. **Pralidoxime (2-PAM)**, a nucleophilic oxime, most effective when treatment is started early and if used within 48 h, and helps in regenerating AChE associated with skeletal muscle neuromuscular junctions. *Dose:* 1-2 g IV (20-40 mg/kg) over 5-20 min dissolved in 0.9% normal saline solution, may be repeated at 1-2 h if muscle weakness is not relieved, and again after 8-10 h.

Alternatively, continuous infusion (200-400 mg/h) of 2-PAM is more effective because of shorter duration of action of single dose.

- Atropine and 2-PAM given together are synergistic against the signs and symptoms of cholinesterase inhibition, thus decreasing atropine requirements.
- PAM is ineffective in reversing the CNS effects of organophosphate because its positive charge prevents entry into the CNS. *Diacetyl monoxime (DAM)* crosses the blood-brain barrier and can regenerate some of the CNS cholinesterase.¹¹
- The use of oximes in acute OPC poisoning remains conflicting and controversial. Some randomized controlled trials showed no benefit in moderate and severe poisoning and concluded that PAM has no role in the routine management of patients with OPC poisoning.
- PAM is *not recommended* for the reversal of inhibition of acetylcholinesterase by carbamate poisoning.* But its use is safe, particularly if administered in conjunction with atropine in case of unknown pesticide or in mixed poisoning.¹²

iv. **Diazepam:** Addition of diazepam for treatment of seizures and neuropathy improves survival (must not be used with other CNS depressants). It decreases the cardiac and brain morphologic damage resulting from OPC seizures.

Dose: 0.5-2 mg IV every 15 min.

v. **Supportive care**

- Foot-end of the bed is raised to ensure drainage of respiratory secretions.
- Suction as required, to remove respiratory secretions.
- Treat bronchospasm with atropine and not bronchodilators.
- Intubate in case of respiratory distress.
- The use of other medication, including opioids for sedation may worsen CNS manifestations and the degree of respiratory depression.
- Dextrose: 2-4 ml/kg of 50% dextrose IV.
- Antibiotics to prevent pulmonary infection.
- Vitamin K may also be given.

Newer therapies: Several new therapies have been studied, but there is insufficient evidence to recommend their use:

- *Magnesium sulphate* blocks ligand-gated calcium channels, resulting in reduced acetylcholine release from pre-synaptic terminals, thus reduce CNS over-stimulation.
- *Clonidine* also reduces acetylcholine synthesis and release from presynaptic terminals.
- *Sodium bicarbonate* is sometimes used in place of oximes.
- Removing OPCs from the blood by hemodialysis and hemofiltration could allow optimum action of other therapies.
- *Enzyme bioscavengers* are being developed as a pretreatment to sequester highly toxic OPCs. Butyrylcholinesterase scavenges OPCs in plasma, reducing the amount available to inhibit AChE in synapses.
- *Recombinant bacterial phosphotriesterases or hydrolases* breakdown OPCs enzymatically; such enzymes could reduce the concentrations of OPCs in blood.

Complications

Immediate	Delayed
<ul style="list-style-type: none"> • Pulmonary edema • Aspiration pneumonia • Chemical peritonitis • Hyper-/hypoglycemia • Coagulation abnormalities 	<ul style="list-style-type: none"> • Paralysis • Neurotoxicity • Guillan-Barre syndrome

* The site on which oximes bind and reactivate the enzyme—the anionic site, is occupied by carbamates

Postmortem Findings

External

- i. Cyanosis of lips, fingers and nose.
- ii. Deep postmortem staining.
- iii. Congested face.
- iv. Frothy discharge, often bloodstained from the nose and mouth.
- v. Kerosene-like smell from nostrils and mouth.

Internal

- i. Mucosa of the stomach and intestine is congested.
- ii. Stomach content may give kerosene-like smell.
- iii. Respiratory passages are congested, contain frothy hemorrhagic exudates.
- iv. Petechial hemorrhage may be present subpleurally.
- v. Edema and congestion of the lungs and other visceral organs.
- vi. Edema of brain.

Medico-legal Aspects

- Hospitalizing all symptomatic patients for at least 4-6 days following resolution of symptoms is recommended, because of the risk of development of respiratory depression or intermediate syndrome after resolution of an acute crisis.
- The symptoms of OPC poisoning can mimic other toxidromes and diseases. The clinician must keep in mind that misdiagnosis is a potential medico-legal pitfall.
- Accidental poisoning occurs in manufactures, packers, sprayers and in children.
- Suicidal poisoning is common in our country, both in rural and urban areas. OPCs are also common suicidal agents in Pakistan, Sri Lanka and the other Asian and South East Asian countries.
- Homicidal poisoning does not occur due to detectable smell of the diluents of poison, and signs and symptoms appear rather early.

Neurological manifestations¹³

Neurological manifestations are the most important sequelae of OPC poisoning. Three types of paralyzes are recognized based on the time of occurrence, and differ in their pathophysiology.

- i. **Acute paralysis (Type I paralysis):** It usually develops within 24-48 h.
Cause: Acute paralysis occurs with the initial cholinergic crisis owing to the persistent depolarization at the neuromuscular junction resulting from blockade of AChE.

Signs and symptoms: It includes muscle fasciculations, cramps, twitching and weakness. Muscle weakness may have upper motor neuron manifestations. It may also involve the respiratory muscles leading to respiratory failure.

Treatment: They respond well to atropine, although it may not fully block the nicotinic effects.

- ii. **Intermediate syndrome (Type II paralysis):** It develops in 24-96 h after resolution of acute cholinergic poisoning symptoms and manifests commonly as paralysis and respiratory distress.^{14,15}

Cause: Neuromuscular transmission defect, toxin-induced muscular instability or inadequate treatment of the acute episode.

Signs and symptoms: It involves proximal groups of muscle with relative sparing of distal groups and is characterized by cranial nerve palsies, weakness of neck flexors and proximal limb muscles.¹⁵

Treatment: Supportive measures, since it does not respond to oximes or atropine.

- iii. **Organophosphate-induced delayed neurotoxicity or polyneuropathy (Type III paralysis)** occurs 1-3 weeks after exposure to large doses of certain OPCs.

Signs and symptoms: Initially complains of symmetric lower extremity weakness and glove and stocking paresthesias, leg cramping and calf pain. Atrophy and paralysis of the peroneal muscles lead to foot drop and eventually ataxia. Steppage gait develops with a positive Romberg sign. The Achilles and ankle jerk reflexes are lost. This ultimately progresses to the upper extremities. Sensory symptoms resolve over the ensuing 1-2 months, but paralysis remains.

This syndrome also does not respond to either oximes or atropine.

Other neurological manifestations

Various other neuropsychiatric manifestations have been described:

- i. **Chronic organophosphate-induced neuropsychiatric disorder (COPIND):** It occurs without cholinergic symptoms and is not dependent on AChE inhibition. COPIND appears with a delay and is long lasting.
Symptoms include mood change, cognitive deficit, memory loss, lethargy, autonomic dysfunction, peripheral neuropathy and extrapyramidal symptoms.
- ii. **Extrapyramidal manifestations** include dystonias, resting tremor, cog-wheel rigidity and choreoathetosis. It develops in 4-40 days following poisoning and lasts for about 1-4 weeks.
- iii. **Neuro-ophthalmological sequelae** including optic atrophy, degeneration of retina, myopia owing to spasm or paresis of accommodation.

Chlorinated Hydrocarbons

The chlorinated hydrocarbons can be divided into four categories:

- i. *DDT and analogues*: DDT and methoxychlor.
- ii. *Benzene hexachloride*: Gamma hexachlorobenzene (Lindane).
- iii. *Cyclodienes and related compounds*: Endrin, aldrin, chlordane, chlordecone, dieldrin, endosulfan, hepatachlor, isobenan and mirex.¹⁶
- iv. *Toxaphene* and related compounds.

All these pesticides are absorbed through skin, orally and via inhalation.

The *agents that are commonly used are*: DDT, endrin, gammexane and dieldrin. The chemical prototype for the group is chlorophenothane which is commonly known as DDT. However, since endrin poisoning is quite common, it is described here.

Endrin

Physical properties: It is the most toxic of all the chlorinated insecticides. It is synthetic, having a bitter taste. The preparations available in market contain endrin in 20-50% concentration mixed with 50-80% of a solvent, such as aromax, a petroleum hydrocarbon smelling like kerosene.

It is also called '*plant penicillin*' because of its broad spectrum of activity against various insect pests. It is extensively used in India, and in Andhra Pradesh the poisoning is occurring at an alarming rate, both in urban and rural populations.

Action

Endrin interferes with nerve impulse transmission. CNS is first stimulated and then depressed.

Metabolism: Endrin is partially metabolized in the liver and directly excreted in the urine, feces and milk; it is rapidly metabolized and eliminated, and does not persist in body tissues.

Signs and Symptoms

Toxic effects rapidly follow ingestion, inhalation or skin contamination. These begin between 1-6 h.

System	Signs and symptoms
GIT	Salivation, nausea, vomiting, abdominal pain, rarely diarrhea, oozing of fine froth, occasionally bloodstained from mouth and nostrils.
CNS	Headache, giddiness, restlessness, irritability, dilated pupils, incoordination, ataxia, mental confusion, tremors, tonic and clonic convulsions, coma.
RS	Hoarseness of voice, cough, dyspnea.

Death is due to respiratory failure. In some cases, convulsions herald the onset of symptoms. Recovery is within 24 h in non-fatal cases.

Fatal dose: 5-6 g (DDT: 10-20 g).

Fatal period: 1-2 h, may be more.

Treatment

Mainly symptomatic treatment is given. There is no specific antidote.

- i. Maintain adequate airway, breathing and circulation.
- ii. Decontamination of the body should be carried out and the airway cared for, similar to organo-phosphosphate insecticides.
- iii. Gastric lavage is done and emetics, animal charcoal and cathartics are given. Castor oil, fats and milk are not given as they enhance the absorption.
- iv. *Cholestyramine* (non-absorbable bile acid binding anion exchange resin which increases the fecal excretion of organochlorines) is given in a dose of 16 g/day in divided doses for few days.
- v. Calcium gluconate is given in a dose of 10 ml of 10% solution IV every 4-6 h.
- vi. Diazepam is given IV to control convulsions.

Recovery is likely, if onset of convulsions is delayed by more than an hour or if convulsions can be controlled readily.

Postmortem Findings

These are suggestive of asphyxia.

External

- i. Kerosene-like smell from the mouth and nostrils, may be found even in decomposed bodies.
- ii. Fine white froth, occasionally bloodstained from the mouth and nostrils.
- iii. The face and fingernails are cyanosed.
- iv. Conjunctiva is congested and the pupils are dilated.

Internal

- i. Mucosa of the esophagus, stomach and intestine is congested, and emits a kerosene-like smell.
- ii. Blood is dark and fluid.
- iii. Respiratory passages contain frothy mucus and the mucosa is congested.
- iv. Petechial hemorrhages over the lungs and heart.
- v. Lungs are congested and edematous.
- vi. Liver, kidneys and brain are also congested with fatty degeneration of liver.

Medico-legal Aspects

- Endrin is mostly used for suicidal purposes as it is freely available and cheap, despite its unpleasant taste and painful death.

- It may be used for homicidal purposes by mixing it with alcohol, sweets or other food to mask its smell.
- Accidental deaths may occur.
- It resists putrefaction and can be detected in exhumed bodies.
- Since alcohol is generally used to mask the smell of endrin, the viscera for chemical examination should be preserved in saturated saline in suspected cases of poisoning.

Chronic poisoning: Long-term exposure to some of these compounds results in cumulative toxicity characterized by weakness, loss of weight, ataxia, tremors, mental changes, oligospermia, increased tendency to leukemia, purpura, aplastic anemia and liver carcinoma.

Naphthalene

Physical properties: It is a solid volatile substance obtained from the middle fraction of coal-tar distillation and has chemical properties similar to benzene. It occurs as large, lustrous, crystalline balls with a characteristic odor.

Uses: Deodorant in lavatories, as a pesticide in moth balls and in the dye industry for the manufacture of indigo and certain azo dyes.

Action

It causes hemolysis with subsequent blocking of renal tubules and hepatic necrosis. Patients with hereditary deficiency of glucose-6-phosphate dehydrogenase (G-6-PD) in the red cells are more susceptible to hemolysis.

Absorption and metabolism: Toxic effects follow from its absorption from the skin, respiratory tract and GIT. It is metabolized in the liver to α -naphthol, β -naphthol and their quinines.

Signs and Symptoms

- **On ingestion**, there is gastric irritation with nausea, vomiting, abdominal pain and fever in 1-2 days, followed by acute hemolytic crisis on 3rd to 5th day. The symptoms include pallor, mild jaundice, burning sensation in the urethra, and pain in the bladder and loins. The urine may be dark-brown or black containing albumin and hemoglobin. Severe poisoning may damage the liver and kidneys, and result in cyanosis, profuse perspiration, convulsions, coma and death.
- **On inhalation**, it causes headache, malaise, nausea, vomiting, conjunctivitis, mental confusion and visual disturbances.

- **Contact** with naphthalene dust on bedding may cause dermatitis, conjunctivitis, vomiting, headache, jaundice and hematuria.

- **Complications:** Acute nephritis, jaundice, hemolytic anemia and optic neuritis.

Fatal dose: Approximately 2 g.

Fatal period: Few hours to 2-3 days.

Treatment

- The patient should be kept warm.
- The stomach should be washed out with warm water or saline.
- Ipecac syrup induced emesis is indicated, followed by activated charcoal.
- Milk and fatty meals should be avoided as they facilitate absorption.
- Bowels should be cleared by magnesium sulphate.
- Sodium bicarbonate should be administered to maintain an alkaline urine so as to prevent the precipitation of acid hematin crystals and blocking of the renal tubules.
- If cyanosis is present, methemoglobin is suspected and treated with methylene blue.
- Blood transfusion may be necessary.
- Hydrocortisone is helpful in limiting naphthalene hemolysis.

Postmortem Findings

- Skin may be yellow.
- The gastric mucosa may be yellow, congested or inflamed.
- Liver and kidneys may show severe damage.
- Respiratory tract may show signs of irritation.
- Other visceral organs may be congested.

Medico-legal Aspects

- Accidental poisoning in children with poison being inhaled from clothes stored in naphthalene mothballs.
- Toxicity from ingestion of naphthalene has occurred in children mistaking mothballs for candy.
- Suicidal ingestion may also occur.

Paraquat

Introduction: It is used as herbicide and weed-killer, available under the trade name, 'Gramoxone' and 'Weedol'.

Action

Paraquat undergoes a NADPH dependent reduction to form a free radical which acts with molecular oxygen to reform the cation to produce superoxide free radicals

and hydroxyl radical (OH) which disrupt cellular function leading to cell death.

Absorption and excretion: Absorption through inhalation, skin or eye contact is minimal. About 5-10% of the ingested dose is absorbed and the rest is excreted in feces. It is distributed in all the organs, but highest concentrations are found in kidneys and lungs, followed by muscles. More than 90% of the absorbed paraquat is excreted unchanged in the urine within the first 24 h, but can be detected in urine upto 3 weeks after ingestion.

Signs and Symptoms

System	Signs and symptoms
Local	Irritation and inflammation of skin, cornea, conjunctiva and nasal mucosa.
GIT	Ulceration and corrosion of mouth, oropharynx, and esophagus; nausea, vomiting, hematemesis, diarrhea, dysphagia.
RS	Cough, hemoptysis, dyspnea due to pulmonary edema, aphonia, aspiration.
Renal	Oliguria, renal failure.
CVS	Hypovolemia, shock, arrhythmias.
Hepatic	Cholestasis.
CNS	Coma, convulsions, cerebral edema.

Death occurs from multiorgan failure, corrosive effects in the GIT or progressive pulmonary fibrosis leading to ARDS.

Fatal dose: 4 mg/kg; 5 ml of 'Gramoxone' or 1-2 g of 'Weedol' or 10 ml of 200 g/l concentrate.

Fatal period: 2-7 days.

Treatment

- Remove all clothings, and wash the patient thoroughly with soap and water.
- Gastric lavage is done with water, and emetics are contraindicated.
- One litre of aqueous suspension of clay (fuller's earth or 7% bentonite) is given to adsorb paraquat, followed by 200 ml of 20% mannitol. Dose may be repeated.
- Administer repeated doses of activated charcoal every 2 h for 3-4 doses.
 - Charcoal hemoperfusion, 8 h/day for 2-3 weeks.
- Supplemental oxygen is withheld as it may contribute to the pulmonary damage.
- Analgesics are given to allay pain.

Postmortem Findings

External: There may be ulceration around the lips and mouth due to dribbling.

Internal

- Esophagus:** Reddened and desquamated.
- Stomach:** Erosions and patchy hemorrhages.
- Lungs:** Pulmonary edema, effusions and hemorrhages. In delayed deaths—enlarged, rigid and stiff lungs are seen.
- Liver:** Fatty degeneration and centrilobular necrosis.
- Kidneys:** Cortical pallor and diffuse tubular damage.

Medico-legal aspects: Poisoning is mostly accidental and suicidal. Rarely, homicide is possible and the poisoning may be mistaken for viral pneumonia.

Pyrethrins and Pyrethroids

Pyrethrins are extracted from *Crysanthemum cinerariaefolium* plant. Pyrethroids are synthetic analogues. Toxicity is very low due to their rapid metabolism.

Uses: As insect repellents, insecticides and pesticides. They are available as sprays, dusts, powders, mats and coils. For example, d-allethrin, pyrethrum, allethrin, deltamethrin, decamethrin, cypermethrin and fenvalerate.

Action: They prolong the inactivation of the sodium channel by binding it in the open state.

Signs and Symptoms

Skin contact causes dermatitis and blisters.

On ingestion, there is nausea, vomiting, headache, vertigo, restlessness, paraesthesias, fasciculations, muscular weakness, hyperthermia, altered mental state, convulsions, pulmonary edema and coma. Respiratory failure may occur.

Inhalation causes rhinorrhea, sore throat, wheezing and dyspnea.

Fatal dose: 1 g/kg body wt.

Treatment

- Gastric lavage is done.
- Activated charcoal is given.
- Oils and fats should be avoided.
- Atropine and oximes are contraindicated.
- Skin should be washed with soap and water.

Medico-legal aspects: Exposure is usually accidental. Suicide/homicide is rare.

In **chronic cases,** the patient gets sensitized with allergic manifestations.

MULTIPLE CHOICE QUESTIONS

1. **NOT an aryl phosphate:** *AI 07; TN 10*
 A. Parathion B. Malathion
 C. Follidol D. Tik-20
2. **Organophosphorus insecticides are all, except:** *MP 11*
 A. Chlorpyrifos
 B. Gardona (tetrachlorvinphos)
 C. Dimethoate
 D. Diethyltoludamide (DEET)
3. **In OPC poisoning, true is/are:** *PGI 06*
 A. Phosphorylated enzyme
 B. Irreversibly inhibit cholinesterase
 C. Oximes effective when given beyond 48 h
 D. Atropine cannot reverse early stage
4. **All are features of organophosphorus poisoning, except:** *UPSC 07; DNB 10; SGPGI 11*
 A. Mydriasis B. Bradycardia
 C. Lacrimation D. Sweating
5. **A 5-year-old child presents with confusion, increased salivation, fasciculations, miosis, tachycardia and hypertension. Poison that can cause these manifestations:** *FMGE 10*
 A. Opium B. OPC
 C. Dhatura D. Arsenic
6. **Cholinesterase inhibitors causes all, except:** *CMC (Vellore) 10*
 A. Increased salivation
 B. Bronchodilation
 C. Constricted pupils
 D. Increased peristalsis
7. **Chromolacryorrhea is seen in poisoning with:** *WB 09*
 A. Cobra B. Organophosphorus
 C. Dhatura D. Carbolic acid
8. **Estimation of plasma cholinesterase levels may be helpful in the management of poisoning with:** *UPSC 07*
 A. Dhatura B. Barbiturate
 C. Organophosphorus D. Opium
9. **In a child with OPC poisoning, following is the correct order of priority in management:** *UPSC 08*
 A. Pralidoxime, diazepam, atropine, clear airway
 B. Clear airway, atropine, diazepam, pralidoxime
 C. Diazepam, atropine, clear airway, pralidoxime
 D. Atropine, pralidoxime, diazepam, clear airway
10. **A farmer visiting an orchard gets unconscious, excessive salivation, constricted pupils and fasciculation of muscles. Treatment is started with:** *AIIMS 07*
 A. Atropine B. Neostigmine
 C. Physostigmine D. Adrenaline
11. **Cholinesterase reactivator which goes to the brain:** *UP 05*
 A. Pralidoxime B. Obidoxime
 C. Diacetyl monoxime D. None
12. **Cholinesterase reactivators are ineffective in case of:** *UP 05; DNB 08, 10*
 A. Baygon B. Parathion
 C. Malathion D. Tik 20
13. **Which of the following is not a phase of organophosphorus poisoning:** *Orissa 11*
 A. Acute cholinergic phase
 B. Intermediate syndrome
 C. OPC induced delayed polyneuropathy
 D. Late onset proximal myopathy
14. **An 'intermediate syndrome' has been associated with:** *Himachal 10*
 A. Organophosphates B. Opium
 C. Cocaine D. Alphos
15. **A patient is admitted with acute organophosphorus insecticide poisoning, develops ptosis, inability to lift the head and difficulty in breathing on the third day. The most likely diagnosis is:** *UPSC 03; TN 06*
 A. Hypokalemia
 B. Inflammatory polyneuropathy
 C. Intermediate syndrome
 D. Polymyositis
16. **Polychlorinated hydrocarbon is:** *AI 08*
 A. Parathion B. Malathion
 C. Diazinon D. Endrin

1. B 2. D 3. A & B 4. A 5. B 6. B 7. B 8. C 9. B 10. A
 11. C 12. A 13. D 14. A 15. C 16. D

Alphos (Aluminum Phosphide)

59

Introduction

- Alphos or AIP (*quickphos, celphos, phosfume, phostoxin, talunex*), a solid fumigant pesticide is widely used as a grain preservative in Northern India.
- Its toxic effect in humans is due to liberation of phosphine gas when it comes in contact with the moisture of grains and HCl of the stomach.
- Phosphine is a colorless gas with characteristic garlic/decaying fish-like odor, spontaneously inflammable and violently combines with oxygen and halogen.¹
- Phosphine in air reacts with hydroxyl radical and is removed by it. The non-toxic residues left in grains are phosphite and hypophosphite of aluminum which is harmless.

Action

- AIP is a protoplasmic poison which inhibits protein and enzyme synthesis.
- Phosphine interrupts the stages of mitochondrial electron transport by inhibiting cytochrome C oxidase.²
- It is also thought that superoxide anions and free radicals are in excess and their decreased destruction leads to lipid peroxidation and change in fluidity of cell membrane and ultimately cell drops out.
- In addition, phosphine and phosphides have corrosive actions.

This process is *fully reversible* and full recovery occurs in patients who survive without any residual effect.

Absorption and Excretion

- Phosphine is rapidly absorbed from the GIT by simple diffusion and cause damage to internal organs. It is also absorbed rapidly from lungs after inhalation.
- After ingestion, some AIP is absorbed and metabolized in the liver and phosphine is slowly released, accounting for the prolongation of symptoms.
- Phosphine is oxidized slowly to hypophosphite and excreted in the urine. It is also excreted through the lungs in unchanged form.

Signs and Symptoms

It depends on the dose and severity of poisoning.

On inhalation

Mild exposure	Moderate exposure	Severe exposure
<ul style="list-style-type: none">• Mucous membrane irritation• Respiratory distress• Tightness of chest• Headache• Dizziness• Fatigue• GIT disturbances	<ul style="list-style-type: none">• Ataxia• Numbness• Tremors• Diplopia• Paraesthesia• Jaundice• Muscular weakness• Multiple organ failure• In-coordination and paralysis	<ul style="list-style-type: none">• ARDS• Arrhythmias• CHF• Pulmonary edema• Convulsions• Coma

On ingestion

Mild intoxication produces:

- Nausea and vomiting
- Headache
- Abdominal pain

Recovery is usual.

Moderate to severe poisoning produces:

System	Signs and symptoms
GIT	Nausea, vomiting, diarrhea, abdominal pain.
CVS	Hypotension, arrhythmias, myocarditis, pericarditis, acute CHF, shock.
RS	Cough, dyspnea, cyanosis, pulmonary edema, respiratory failure.
Hepatic	Jaundice, hepatitis, hepatomegaly.
Renal	Oliguria, renal failure.
CNS	Headache, dizziness, altered mental state, restlessness, convulsions, acute hypoxic encephalopathy, coma.
Others	Rarely, muscle wasting, tenderness, bleeding diathesis due to capillary damage.

Cause of death: Metabolic acidosis or mixed metabolic acidosis and respiratory alkalosis, and acute renal failure are frequent.

- Within the first 24 h after ingestion: Arrhythmia.
- After 24 h: Refractory shock, acidosis and ARDS.

Fatal dose

- Ingestion: 150-500 mg (1 tablet is fatal).
- Inhalation: Level > 50 ppm in air is dangerous; 400-600 ppm is fatal within ½ hour.

Fatal period: 1-4 days (initial 24 h is critical).

Hemodynamic changes

- Normal to decreased pulmonary capillary wedge pressure (PCWP).
- Increased right atrial pressure.
- *ECG changes:* Mixed heart rate response, ST-T wave changes, blocks, arrhythmias in the form of atrial fibrillation, supraventricular/ventricular tachycardia and ventricular fibrillation.
- *ECHO:* Decreased ejection fraction and fraction shortening.
- Plasma cortisol levels may be low.
- Depletion of Mg^{2+} has cause and effect relationship.

Laboratory Diagnosis

- Five ml of gastric aspirate is added to 15 ml of H_2O in a flask and its mouth is covered with a filter paper impregnated with silver nitrate ($AgNO_3$). The flask is heated at $50^\circ C$ for 15-20 min. If phosphine is present, the filter paper turns black due to silver phosphate.³
- Silver nitrate impregnated paper test**
 - It may be carried out on vomitus, lavage fluid and breath.

- The test depends on property of phosphine to react with $AgNO_3$ and turning it into black.
- It is carried for bedside confirmation of alphos poisoning.
- Sensitivity is < 100% with gastric juice, 50% with breath (positive in breath, if > 6 g is ingested).
- Specificity is high, but it sometimes gets blackened due to presence of H_2S in air as impurity. Its presence can be differentiated by using lead acetate paper, i.e. both papers will turn black in the presence of H_2S .
- iii. Blood gas analysis (ABG) shows metabolic acidosis.²
- iv. Renal parameters are deranged.
- v. The most specific and sensitive method for detecting phosphine is gas chromatography with a nitrogen-phosphorous detector.
- vi. For spot sampling of phosphine in air, detector tubes and bulbs are available.

Treatment (Flow chart 59.1)

- No specific antidote.
- Intensive patient care is important.
- Main aim is to sustain life with supportive measures till phosphine is excreted.
- The doctor must take personal protection measures, including face mask and rubber gloves during decontamination.

Flow chart 59.1: Management of AIP poisoning

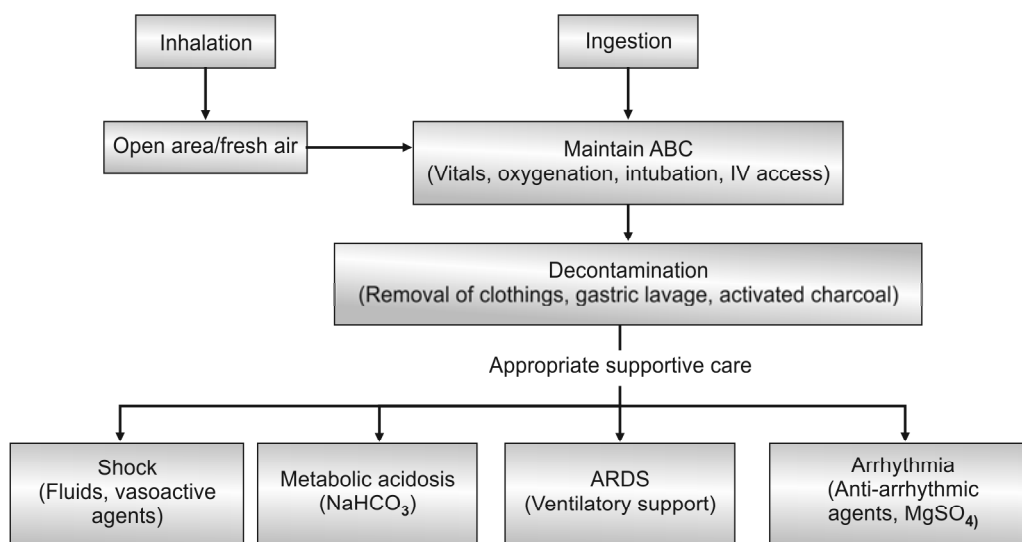

- Confirm airway patency and protect the airways with endotracheal tube to prevent aspiration pneumonitis, if required.

Reduction of absorption of alphas from GIT

- Gastric lavage with KMnO_4 (1:10,000) in first 30-45 min after ingestion (oxidizes phosphine to phosphate). Repeated 2-3 times.
- Activated charcoal 100 g orally to adsorb phosphine. Antacids reduce absorption of phosphine.
- Liquid paraffin may also be given. Sorbitol solution at a dose of 1-2 ml/kg may be used as cathartic.
- Antiemetic and H_2 antagonist—gives symptomatic relief.

Reduction of toxicity

- MgSO_4 :** It reduces organ toxicity, corrects hypomagnesemia and arrhythmias. It has an anti-oxidant effect and it combats free radical stress due to phosphine.⁴
Dose: 200 mg/kg every 4-6 h or 3 g bolus followed by 6 g as infusion over 12 h for 5-7 days.
- Enhancement of excretion:** Phosphine is excreted through lungs and kidneys. So, adequate hydration and renal perfusion must be maintained by IV fluids.

Supportive treatment

- O_2 is given for hypoxia.
- Fluids (3-4 litres of fluids given in the first 3-6 h, 50% of which is NS) and hydrocortisone (400 mg 4-6 hourly) for shock.
- Sodium bicarbonate IV for metabolic acidosis—the correction of metabolic acidosis is the core therapeutic concept for AIP poisoning.
- Peritoneal/hemodialysis may be done in case of acute renal failure.
- Low dose dopamine is given for hypotension and shock (4-6 $\mu\text{g}/\text{kg}/\text{min}$)—should be used cautiously, as it can induce arrhythmias.

Anti-arrhythmic agents, DC cardioversion and temporary pacemaker should be available at the bedside.

Apart from supportive treatment, novel therapies have been suggested but not recommended for routine use:

- **Oral administration of coconut oil:** Coconut oil has been reported to inhibit the release of phosphine gas from AIP due to physicochemical properties of AIP and non-miscibility with fat.
- **Antioxidant agents:** N-acetylcysteine, glutathione, melatonin, Vit. C and beta carotene may be used.

- **Trimetazidine** (anti-ischemic drug) reduces oxygen consumption and may have a potential role to check CVS manifestation.
- Advanced measures like *intra-aortic balloon pump* can mechanically support the heart in toxic myocarditis with refractory shock.
- *Extracorporeal life support* for intractable circulatory collapse.

Complications

- Pericarditis
- Acute CHF
- DIC
- Acute GIT bleed
- Acute respiratory arrest

Mortality in alphas poisoning: 40-100%.

It depends upon:

- Freshness and dose of compound—fully exposed compound have low morbidity and mortality.
- Immediate, early and more frequent vomiting and early availability of supportive care causes better prognosis.
- Mortality is reduced with MgSO_4 in addition to supportive treatment.

Postmortem Findings

Findings of vital organs are suggestive of cellular hypoxia.

- Blood tinged froth from mouth and nostrils.
- Garlic-like odor in the gastric contents, mouth and nostrils.¹
- Mucosa of the lower part of esophagus, stomach and duodenum are congested.
- Decreasing congestion of the GIT is seen in small intestine from cephalic to caudal end.
- Viscera are congested and edematous.

Histopathology

- **Stomach:** Congested, edematous, leukocytic infiltration and sloughing of gastric mucosa.
- **Lungs:** Congested, edematous, desquamation of respiratory epithelium, atelectasis, round cell infiltration around bronchioles, thickened alveoli and lymphocytic infiltration.
- **Heart:** Congested, edematous, focal necrosis, myocyte vacuolation and leukocytic infiltration.
- **Liver:** Microvesicular and macrovesicular steatosis, microvacuolization, sinusoidal dilation, centrilobular necrosis, portal congestion, mononuclear infiltration and fatty changes.
- **Kidneys:** Congested, necrosis and tubular degeneration.
- **Adrenals:** Congested, hemorrhagic necrosis and area of lipid depletion in cortex.
- **Brain:** Congested and edematous. There may be capillary dilation, paucity of glial cells, degenerated Nissel granule in the cytoplasm and deeply stained eccentric nucleus, degeneration of neurons and appearance of necrotic patches.

Medico-legal Aspects

- Poisoning is increasing steadily and has achieved epidemic proportions in Delhi, Haryana, Punjab, UP, MP, Rajasthan and Chandigarh while some have been reported from Iran, Sri Lanka and Morocco. Poisoning is mostly suicidal, but homicidal cases may be seen in children.
- Accidental poisoning may occur.
- Its gaseous form and toxicity makes it a potential agent for chemical terrorism.

Each tablet of AIP contains 56% active ingredient and 44% $(\text{NH}_4)_2\text{CO}_3$ and has the capacity to liberate 1 g of phosphine (PH_3) gas.

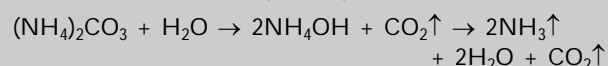
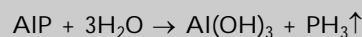
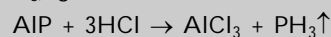

Therefore, gases liberated during fumigation or after ingestion are CO_2 , NH_3 and phosphine (PH_3). The former two gases provide inert media for phosphine to act.

MULTIPLE CHOICE QUESTIONS

- Garlic odor around the nostrils and mouth is indicative of poisoning with:** *AP 07*
 A. Cyanide B. Organophosphorus
 C. Carbolic acid D. Aluminum phosphide
- In aluminum phosphide poisoning, which is NOT true:** *AIIMS 10; Punjab 11*
 A. Accumulation of acetylcholine at NM junction
 B. Cytochrome oxidase inhibition
 C. Phosphine formation
 D. Metabolic acidosis
- A case of poisoning was brought to the casualty, gastric lavage turned black when it was heated after being treated with silver nitrate. The poisoning is most likely:** *PGI 04*
 A. Tik-20 B. Alphos
 C. Malathion D. Parathion
- In treatment of Alphos poisoning, magnesium sulphate acts as:** *WB 08*
 A. Adjuvant B. Stabilizer
 C. Preservative D. Purgative

Medicinal Poisons

60

Paracetamol (Acetaminophen)

Paracetamol (PCM) is a common analgesic in many nonprescription and prescription products.

Action

- PCM inhibits prostaglandin synthesis.
- It produces liver damage through accumulation of a toxic intermediate metabolite: *N-acetyl-p-benzoquinone*. Hepatic glutathione normally inactivates the metabolite, but in PCM poisoning, the glutathione becomes depleted.
- It also causes renal tubular necrosis.

Metabolism: After absorption, it is metabolized by glucuronidation and sulfation and by cytochrome P450 oxidase system.

Signs and Symptoms

Usually four stages of presentation are seen (Table 60.1).

Diagnosis

PCM levels are assessed in the blood by enzyme immunoassay and high performance liquid chromatography (HPLC). Emergency measurement of blood levels is essential in assessment of poisoning. There is a marked elevation of liver enzymes (SGPT > 1000) and an increased PT may be seen.

Rumack-Matthew nomogram can help in planning treatment.

Fatal dose

- *Adults:* 10-15 g (20-30 tablets).
- *Children:* 150 mg/kg body wt.

Fatal period: 2-4 days.

Treatment

- Activated charcoal and gastric lavage within 1-2 h of ingestion.
- Antidote:** *N-acetyl cysteine* (NAC) 150 mg/kg in 200 ml of 5% glucose over 15 min, followed by serial infusion of 50 mg/kg in 500 ml of 5% glucose in 4, 8 and 8 h (total 300 mg/kg in 20 h) or 140 mg/kg orally as loading dose, followed by 70 mg/kg every 4 h.^{1,2} Administration of NAC within 8 h of ingestion is nearly 100% hepatoprotective. Oral *methionine* is an alternative, but is unreliable in patients who are vomiting. *Dose:* 2.5 g orally every 4 h for 4 doses.
- Supportive measures:** Intravenous electrolytes, rehydration, vitamin K for bleeding and mannitol for cerebral edema.

Postmortem Findings

- **External:** Jaundice, petechiae in skin.
- **Internal:** Congestion of the GIT, centrilobular hepatic necrosis, acute tubular necrosis, cerebral edema and myocardial necrosis.

Medico-legal aspects: Most cases of poisoning are suicidal. Accidental overdose may occur.

Table 60.1: Signs and symptoms of PCM poisoning

Stage	Time of ingestion	Signs and symptoms
I (Initial)	Upto 1 day	Nausea, vomiting, diaphoresis, malaise, pallor.
II (Middle)	1-2 days	Discomfort disappears, giving a false sense of relief. Upper abdominal pain may be present.
III (Hepatic)	After 4 days	Vomiting, jaundice, hepatic pain, bleeding, confusion, coma, asterixis (flapping tremor), hepatic encephalopathy, cardiac arrhythmia, hemorrhagic pancreatitis, DIC.
IV (Recovery)	After 5-7 days	Resolution of liver function occurs in about 2-3 months.

Death usually occurs in stage III. If not, then patient passes into stage IV.

Iron

Introduction: Commonly available preparations are ferrous sulphate, ferrous gluconate and ferrous fumarate which are used for supplemental therapy in case of iron deficiency anemia. Rarely, the source of poisoning may be from tanning, dyeing and from inks.

Action: Increased capillary permeability, release of hydrogen ions, inhibition of mitochondrial enzymes and corrosive action on gastric mucosa.

Signs and Symptoms

They are divided into four stages.

- i. **Stage I:** Nausea, vomiting, abdominal pain, gastrointestinal hemorrhage, hypotension, pallor and lethargy. These symptoms occur half an hour to 6 h post-ingestion.
- ii. **Stage II:** Mild acidosis, hyperventilation, oliguria and hypotension; occur 6-24 h post-ingestion. Overall, the patient seems to show apparent improvement.
- iii. **Stage III:** Multiorgan dysfunction involving GIT, CVS, CNS, hepatorenal systems with anion-gap metabolic acidosis, depression, hepatitis, coagulopathy, convulsions, disorientation, shock, coma and death. It occurs 24-48 h to few days post-ingestion.
- iv. **Stage IV:** It is seen 2-6 weeks post-ingestion and includes complications, like gastric stricture and pyloric obstruction.

Fatal dose: 20-30 g (> 200 mg/kg).

Fatal period: 24-48 h.

Investigations

- **Abdominal X-ray:** Radiopaque tablets may be seen.
- **Serum iron level** > 500-1000 µg/dl indicate severe toxicity. It is measured 2-6 h post-ingestion.
- **Desferrioxamine challenge test:** It is given in a dose of 25 mg/kg which imparts a reddish 'vin rose' color to the urine (iron-desferrioxamine complex).

Treatment

- i. **Fluid resuscitation:** If patient is in shock, normal saline drip or lactated Ringer's solution, dopamine and whole blood transfusion may be given depending upon the cause. Dextrose for hypoglycemia, and sodium bicarbonate for acidemia is given.
- ii. **Decontamination:** Gastric lavage or whole bowel irrigation with normal saline or polyethylene glycol-electrolyte solution at a rate of 0.5 l/h. After this,

1% sodium bicarbonate/magnesium hydroxide solution is added to precipitate the residual iron as insoluble ferrous carbonate/hydroxide.

- iii. **Chelation therapy:** *Desferrioxamine* (antidote) in a dose of 10-15 mg/kg/h as continuous infusion to a maximum of 6 g, till there is significant reduction of systemic toxicity.³
- iv. **Supportive therapy**
 - Hemodialysis or exchange transfusion in severe cases.
 - Endoscopy or gastrostomy, if there is clinical toxicity and a large amount of tablets are visible on the X-ray.

Postmortem Findings

Usually internal findings are seen.

- i. **GIT:** Hemorrhagic necrosis and perforation of the gastric or jejunal wall.
- ii. **Lungs:** Pulmonary hemorrhage.
- iii. **Liver:** Centrilobular necrosis may be seen.
- iv. **Kidneys:** It may show necrosis of tubules.

Medico-legal aspects: Usually accidental poisoning from overdose (children are attracted by its color and pleasant flavor), prolonged therapy or IV administration. Suicidal cases may occur in older children and adults.

Antipsychotic Drugs (Tranquillizers)

Introduction: These drugs relieve anxiety and mental tension without producing sedation, and are used in various neurotic conditions, anxiety states, relief of tension, and as anesthetics because of their muscle relaxant properties.

Classification

Phenothiazines	Chlorpromazine, Trifluorpromazine
• Aliphatic	Trifluoperazine, Prochlorperazine
• Piperazine	Thioridazine, Mesoridazine
• Piperidine	
Butyrophenones	Haloperidol, Droperidol
Thioxanthenes	Thiothixene, Flupenthixol
Others	Pimozide, Respine, Loxapine
Atypical neuroleptics	Clozapine, Risperidone

Action: They have an inhibitory effect on a variety of receptors including dopaminergic (mainly D₂ receptor), cholinergic, α₁ and α₂-adrenergic, histaminic and serotonergic receptors (5HT₂).

Absorption and excretion: They are completely absorbed from the GIT. Excretion is mainly via feces (50%) and the kidneys (30%) as metabolites; less than 4% is excreted in the unchanged form.

Signs and Symptoms

Toxic manifestations can be divided into CNS and non-CNS effects.

CNS effects

- Depression, agitation, seizures, somnolence and coma.
- *Behavioral reactions*: Oversedation, impaired psychomotor function and paradoxical effects, such as agitation, excitement, insomnia and toxic confusional states.
- *Extrapyramidal signs*: Dystonia (acute), akathisia, Parkinsonism (akinesia), neuroleptic malignant syndrome and tardive dyskinesia.

Non-CNS effects

System	Signs and symptoms
CVS	Orthostatic hypotension, ventricular tachycardia, torsades de pointes (ventricular tachycardia in which QRS morphology twists around the baseline), ventricular fibrillation, atrioventricular block.
GIT	Dry mouth, decreased colonic motility resulting in constipation, pseudo-obstruction.
Ocular	Mydriasis; visual acuity, visual fields and color vision perception may be altered.
Genitourinary	Urinary retention, priapism.
Hematologic	Agranulocytosis, aplastic anemia, leukopenia, eosinophilia, thrombocytopenia, anemia, pancytopenia.
Hepatic	Cholestatic jaundice.

Fatal dose: 2-5 g (25-30 times of therapeutic dose).

Diagnostic trial: For a suspected case of poisoning, administration of diphenhydramine (dose: 1-2 mg/kg, maximum—25 mg) results not only in resolution of dystonia or oculogyria, but also assists in the diagnosis.

Treatment

There is no specific antidote for acute phenothiazine poisoning.

Initial stabilization

- ABCs*: Oxygen is given. Intubation may be necessary.
- Emesis*: Contraindicated due to the risk of development of seizures and sedation.
- Gastric lavage* must be done followed by administration of activated charcoal; beneficial even upto 6 h following ingestion.
- Catharsis*: Following gastric lavage, a saline cathartic (sodium or magnesium sulfate) may be introduced and left in the stomach.

- Diuresis*: Mannitol solution is given slow IV in a dose of 5 ml/kg initially followed by 2 ml/kg every 6 hourly for 2 days.
- Correction of hypotension*: Elevate the foot end of the bed. Give adequate IV fluids (0.9% NS), epinephrine or dopamine should not be used. Treatment of resistant hypotension is done with norepinephrine, 1-2 µg/kg/min (titrated to blood pressure).

Management of specific condition

- Ventricular dysrhythmia*: Administer sodium bicarbonate. Plasma alkalinization is said to be the mainstay of treatment. Ventricular dysrhythmias are treated with lidocaine (loading dose: 1 mg/kg IV repeated after 5-10 min, maintenance dose: 2-4 mg/min IV) or phenytoin (15-20 mg/kg IV).
- Dystonic reactions*: Administer diphenhydramine, 0.5-1 mg/kg IV (maximum 50 mg) or benzotropine mesylate, 1-2 mg IV or IM (0.01-0.02 mg/kg).
- Malignant hyperthermia*: Administer dantrolene (2-5 mg/kg IV) or bromocriptine (2.5-7.5 mg orally daily).
- Seizures*: Treat seizures initially with diazepam, 0.2-0.5 mg/kg IV, repeat after 10-15 min. Pheno-barbital or phenytoin can be used for persistent seizures.
- Other measures*: Hypothermia may occur, maintain normal body temperature and avoid overheating.

Medico-legal aspects: These drugs are the most frequent cause of acute accidental poisoning in children and mostly involve children < 6 years of age.

Antihistaminics

Introduction: The commonly used preparations are: diphenhydramine (benadryl), doxylamine, pyrilamine, promethazine hydrochloride (phenergan), tripelemamine, chlorpheniramine, cemetidine, ranitidine, nizatidine and famotidine.

Action: Inhibition of central and postganglionic parasympathetic muscarinic cholinergic receptors.

Signs and Symptoms

- *CNS*: Drowsiness, lethargy, fatigue and hypnosis. There is vertigo, ataxia, tinnitus, dilated pupils and blurred vision followed by tremors, anxiety, insomnia, excitement, delirium, hallucinations, convulsions and coma. Anticholinergic features (mydriasis, hyperthermia and flushing) are seen.

- *GIT*: Dry mouth, anorexia, nausea, vomiting, abdominal pain and constipation or diarrhea.
- There may be tachycardia, retention of urine and skin rashes.

Finally, there is severe central nervous depression, and death results from respiratory failure or cardiovascular collapse.

Fatal dose: 1 g.

Treatment

- Gastric lavage.
- Physostigmine 0.5-2 mg IV every hour, until reversal of symptoms occurs. However, it can produce serious adverse effects. Short-acting barbiturates may be used for the control of CNS stimulation.
- Symptomatic treatment.

Postmortem findings: Non-specific findings. Signs of asphyxia are found.

Medico-legal aspects: Poisoning is usually accidental and sometimes suicidal.

Tricyclic Antidepressants (TCAs)

Introduction: Tricyclic antidepressants (TCAs) are one of the oldest classes of antidepressants and are still used extensively. Before the introduction of selective serotonin reuptake inhibitors (SSRIs), TCAs were the standard treatment for depression.

TCAs include:

- | | |
|-----------------|-----------------|
| • Imipramine | • Clomipramine |
| • Amitriptyline | • Desipramine |
| • Trimipramine | • Nortriptyline |
| • Doxepin | • Dothiepin |

Action: TCAs have complex actions. It inhibits monoamine uptake and interact with variety of receptors, viz. muscarinic, α -adrenergic, dopaminergic, GABA-ergic, histaminergic and serotonergic. They have potent anticholinergic and antiarrhythmic activity.

Signs and Symptoms⁴

Features of poisoning appear in 1 h and maximum intensity is seen in 4-12 h.

- *Anticholinergic effects:* Dry skin and mouth, flushing, decreased bowel sounds, constipation, epigastric distress, urinary retention, dilated pupils, blurred vision and palpitations.
- *CNS:* Drowsiness, sleepiness, unresponsive to pain, depressed brainstem reflexes, seizures and coma.
- *CVS:* Tachycardia and hypotension.
- *MS:* Myoclonus, later on flaccid paralysis.
- Respiration is depressed and temperature is decreased.

ECG changes: Cardiac conduction delays (increased PR, QRS and QT intervals; terminal QRS right axis deviation) with aberrancy and ventricular tachydysrhythmias.

Cause of death: Metabolic acidosis and cardiorespiratory depression.

Treatment⁵

- Gastric lavage, respiratory support, fluid infusion, maintenance of BP and body temperature. Acidosis is corrected by sodium bicarbonate infusion.
- Diazepam may be given IV to control convulsions and delirium.
- Propranolol or lidocaine may be used for ventricular arrhythmias.
- Physostigmine 0.5-2 mg IV reverses the central, peripheral and cardiac effects, but seldom used, since arrhythmias and hypotension are sometimes worsened by this treatment.

Medico-legal aspects: Poisoning is frequent with suicidal attempts by the depressed individuals.

Tricyclic antidepressants are the leading cause of death by drug overdose in US.

Benzodiazepines

Introduction: They are used mainly as anti-anxiety and muscle relaxant agents. The commonly used preparations are: diazepam, flurazepam, chlorthalidone, nitrazepam, oxazepam, flurazepam, alprazolam and lorazepam. Addiction may occur with these drugs. They can be ultra-short acting (e.g. midazolam), short acting (e.g. alprazolam) and long acting (e.g. diazepam).

Action: They enhance the inhibitory actions of the neurotransmitter GABA located in the brain.

Signs and Symptoms

Vertigo, slurred speech, nystagmus, diplopia, dysarthria, ataxia, sedation, somnolence and coma. If taken alone, they are not toxic, but mixing with alcohol or other drugs can lead to death.

Fatal dose: 100-300 mg/kg body wt.

Treatment

- Gastric lavage.
- Activated charcoal.
- Antidote:** *Flumazenil* selectively blocks the central effects of benzodiazepines by competitive inhibition, given slow IV, 0.2 mg over 30-60 seconds, repeated in 0.5 mg increments upto a total of 3-5 mg.⁶ However, it may itself induce seizures. A long acting drug, such as chlorthalidone or diazepam is useful to prevent complications (may not be effective in seizures).

Signs and Symptoms of Chronic Poisoning

- **CNS:** Headache, anxiety, insomnia, muscle spasms, tremors, rarely convulsions and psychiatric disturbances.
- **GIT:** Anorexia and vomiting.
- **RS:** Respiratory depression is rare.

High dose, long-term therapy may produce withdrawal symptoms when stopped suddenly.

The *withdrawal syndrome* includes fits and psychosis. In addition, anxiety symptoms, such as sweating, insomnia, headache, tremors, nausea and disordered perception, such as feelings of unreality, abnormal bodily sensations and hypersensitivity to stimuli may be seen.

Acetylsalicylic Acid (Aspirin)

Introduction: Salicylate can be found in hundreds of over-the-counter medications. It is popular as an antipyretic and analgesic. Toddlers are most vulnerable to acute salicylate poisoning.

Physical properties: It is a white, odorless, crystalline powder, having a slight acid taste.

Action

Initially, there is direct stimulation of respiratory centre leading to hyperventilation and respiratory alkalosis. Later on, due to inhibition of Krebs cycle, uncoupling of oxidative phosphorylation, gluconeogenesis, increase lipid metabolism and inhibition of amino acid metabolism, patient develops metabolic acidosis. It is also neurotoxic.

Absorption and excretion: It is rapidly absorbed from the stomach and to a slightly lesser extent from the small intestine. Metabolism occurs chiefly in the liver. Excretion is mainly through urine.

Signs and Symptoms

System	Signs and symptoms
GIT	Burning pain in the throat and abdomen, nausea, vomiting, thirst, hematemesis and melena.
CNS	Ataxia, vertigo, tinnitus, headache, confusion, convulsion, coma—known as ' <i>salicylate jag</i> ' secondary to hyperthermia and altered glucose metabolism.
CVS	Tachycardia.
Hepatic	Reye's syndrome.
RS	Initially, tachypnea and hyperpnea, followed by Kussmaul's breathing secondary to metabolic acidosis, pulmonary edema.
Electrolyte	Dehydration, hypokalemia, hypo-/hypernatremia, hypo-/hyperglycemia.
Hematologic	Hemorrhagic tendency.
MS	Rhabdomyolysis, tetany.
Others	Hyperpyrexia, dilated pupils, rapid and irregular pulse.

Fatal dose: Sodium salicylate and aspirin: 15-20 g (200 mg/kg). Blood level > 100 mg/dl is fatal.

Fatal period: Few hours.

Reye's syndrome may develop in children < 15 years on intake of aspirin. The main features are acute onset of hepatic failure and encephalopathy with residual neurological manifestations.

Investigations

- **Bedside diagnosis:** Presence of salicylic acid in the urine can be detected by *ferric chloride test* which involves combining 1 ml of patient's urine to few drops of ferric chloride solution. If salicylate is present, solution will turn to brown-purple color.
- **Blood salicylate level:** Best indicator of the severity of intoxication. It should be done 6 h after ingestion and then repeated every 4-6 hourly for serial estimation and response to therapy.

Differential Diagnosis

- Diabetic ketoacidosis
- Lactic acidosis
- Methanol toxicity
- Renal failure
- Ethylene glycol toxicity

Treatment

i. Decontamination

- Gastric lavage is done. At the end of the lavage, activated charcoal should be left in the stomach which will bind the unabsorbed salicylate.
- Elimination can be enhanced by whole bowel irrigation with polyethylene glycol.

ii. Fluid and electrolyte management

- Correction of dehydration is done by crystalloids to replace the fluid loss.
- *Alkalinization of urine* (enhances renal salicylate excretion) and treatment of acidosis: Add 100 mEq (2 ampoules) of sodium bicarbonate to 1 litre of 5% dextrose in 0.2% saline and infuse this solution IV at a rate of about 150-200 ml/h. Add 20-30 mEq of potassium chloride to each litre of IV fluid.
- Hypocalcemic tetany is treated with 10% calcium gluconate.
- Seizures are controlled with diazepam (1-3 mg/kg/dose) or phenobarbitone (5 mg/kg).
- Vitamin K should be injected, if PT is prolonged.
- If patient develops respiratory failure, positive pressure ventilation should be started.

- iii. **Hemodialysis:** It is preferred over hemoperfusion and peritoneal dialysis as it helps in removal of salicylate and maintenance of fluid and electrolyte balance.

Postmortem Findings

External: Pupils are dilated. Skin rashes may be present.

Internal

- i. *Stomach:* Gastric mucosa is congested and petechial hemorrhages are seen in the mucous and serous membranes.
- ii. *Lungs:* Subpleural petechial hemorrhages, congested, edematous and collapsed.
- iii. All organs are congested.
- iv. If the patient survives for few days, the myocardium, liver and kidneys are usually soft, dirty in appearance and greasy to touch. Hepatitis may be present. Petechial hemorrhages are seen in various organs.

Medico-legal aspects: Aspirin is the most common salicylate in regular use, so both accidental and suicidal ingestion is common with this drug.

Chloral Hydrate

Introduction: Chloral hydrate (dry wine) is related to paraldehyde and is an unfashionable drug in modern times, but still used in psychiatric hospitals.⁷ A combination of chloral hydrate and alcohol is known as 'Mickey Finn'.

Physical properties: Colorless, crystalline powder having a peculiar pungent odor and a bitter taste.

Action: It causes depression of the central nervous system.

Absorption and excretion: It is absorbed from the stomach, small intestine and rectum, and metabolized in the liver, mainly to trichloroethanol which is further oxidized. Trichloroethanol is conjugated with glucuronic acid and excreted in the urine.

Signs and Symptoms

Retrosternal burning sensation, vomiting, drowsiness, hypotension, slow irregular pulse, depression of respiration, deep sleep and coma. Albuminuria, scarlatiniform or urticarial rash and rarely, jaundice may be seen.

Death usually occurs from paralysis of the respiratory centre.

Fatal dose: 3-5 g.

Fatal period: 8-12 h.

Treatment

- i. Gastric lavage with alkaline solution.
- ii. Hemodialysis.
- iii. Flumazenil 0.1 mg as infusion upto a total of 3 mg.
- iv. Symptomatic treatment.

Postmortem Findings

- Gastric mucosa is eroded, softened and reddened, and smells of chloral hydrate.
- Brain and lungs are congested.
- Damage to kidneys and liver is seen.

Medico-legal Aspects

- Accidental poisoning results by taking large doses as a hypnotic.
- Suicidal/homicidal cases are rare.
- It is given in food or drink to render a person suddenly helpless for the purpose of robbery or rape. Its action is so rapid that it has been given the name of 'knockout drops'.

Chronic poisoning occurs after prolonged therapeutic use.

Symptoms: GIT irritation, erythematous and urticarial eruptions on skin, tremors and dyspnea may be seen. Convulsions, mental derangement and liver damage may occur.

Habitual use can lead to tolerance and physical dependence with delirium when the drug is withdrawn.

Insulin is a potent hypoglycemic agent and if severe lowering of the blood sugar persists for many hours, then brain damage and death will occur. In massive doses, especially intravenously, death can take place within few hours.

Insulin, unless suspected, is an effective murder method. If death from insulin is suspected (which looks like a natural death with no obvious anatomic cause of death found at autopsy), either from suicide (usually amongst nurses and doctors who have access to large doses), homicide or rarely from accidental overdose (usually in hospital), then a search of the body must be made for recent needle marks and the surrounding skin, subcutaneous tissue and underlying muscle excised and sent unfixed for assay (occult injection sites can be a mucosal surface or scrotum in male).

Blood samples are preserved (to distinguish between human, bovine and porcine insulin and detect adjuvants such as zinc which assists in tracing the origin of the extrinsic insulin). Samples should be taken soon after death and the plasma immediately separated from the cells, and kept deep-frozen until analysis. Postmortem blood glucose levels are generally unhelpful in confirming hypoglycemia, but vitreous humor is more useful.

Oral hypoglycemic agents, such as sulphonylureas and biguanides, may be taken as an overdose, either suicidal or accidentally, producing hypoglycemia, hyperkalemia and acidosis.

Radioimmunoassay (RIA) is used for measurement of insulin in the body. The method most used is *chemiluminescent immunoassay* and the measurement of blood insulin

is possible even when embalming fluid had contaminated the blood.

False negative analysis may be due to:

- Prolonged interval between injection and death (if the person was comatose for many days).
- Postmortem glucose measurements since postmortem glycolysis may falsely elevate blood glucose levels.

MULTIPLE CHOICE QUESTIONS

1. **A female, Lalita, aged 26 years accidentally takes 100 tablets of paracetamol. Treatment of choice is:**
DNB 09; PGI 09; UP 11; FMGE 11
 - A. Lavage with charcoal
 - B. Dialysis
 - C. Alkaline diuresis
 - D. Acetylcysteine
2. **N-acetyl-cysteine is antidote for toxicity with:** *MP 11*
 - A. Benzodiazepine
 - B. Barbiturates
 - C. Acetaminophen
 - D. Amphetamine
3. **Treatment of acute iron toxicity:** *FMGE 09*
 - A. EDTA
 - B. BAL
 - C. Desferrioxamine
 - D. Penicillamine
4. **A patient ingested some unknown substance and presented with myoclonic jerks, seizures, tachycardia and hypotension. The ECG showed a heart rate of 120/min with QRS interval of 0.16 seconds. The arterial blood**
revealed a pH of 7.25, PCO₂ of 30 mm Hg and HCO₃ of 15 mmol/l. Most likely cause of poisoning is: *AIIMS 03*
 - A. Amanita phalloides
 - B. Ethylene glycol
 - C. Imipramine
 - D. Phencyclidine
5. **A woman consumes several tablets of amitriptyline. All of the following can be done, except:** *AIIMS 10*
 - A. Sodium bicarbonate infusion
 - B. Gastric lavage
 - C. Diazepam for seizure control
 - D. Atropine as antidote
6. **Antidote for benzodiazepine poisoning:** *FMGE 10*
 - A. Naloxone
 - B. Atropine
 - C. Flumazenil
 - D. N-acetyl-cysteine
7. **Dry wine is:** *PGI 04*
 - A. Methylated spirit
 - B. Ethyl alcohol
 - C. Chloral hydrate
 - D. Isopropyl alcohol

Drug Dependence

61

Definitions

- **Drug:** Any substance, when taken into the living body, may modify one or more of its functions.
- **Psychoactive drug** is one that is capable of altering the mental functioning.
- **Drug dependence** is a compulsion to take a drug to produce a desired effect or to prevent unpleasant effects when the drug is withheld, i.e. it is necessary for either physical or psychological well-being.

Drug dependence includes both the terms 'addiction' and 'habituation' (Diff. 61.1).

Nowadays, words 'addiction' and 'addict' are not used in medicine due their derogatory implication. Instead 'abuse' or 'harmful use' or 'dependence' is used.

Hard and soft drugs are terms to distinguish between psychoactive drugs that are addictive and non-addictive.

- *Hard drugs* lead to severe physical addiction, e.g. heroin, methamphetamine, alcohol and nicotine.
- *Soft drugs* do not cause physical addiction but may lead to psychological dependence, e.g. cannabis, mescaline, psilocybin and LSD.

The distinction between soft drugs and hard drugs is important in the drug policy of the Netherlands, where cannabis production, retailing and use come under official tolerance, subject to certain conditions.

Patterns of Drug Use Disorders

There are four important patterns of drug use disorders, which may overlap with each other.

- i. Acute intoxication
- ii. Withdrawal state
- iii. Dependence syndrome
- iv. Harmful use

- **Acute intoxication** is a transient condition, resulting in disturbance of the level of consciousness, cognition, perception, behavior or other psycho-physiological functions and responses. This is usually associated with high blood levels of the psychoactive substance.

The intensity of intoxication lessens with time, and effects gradually disappear in the absence of further use of the substance. Recovery is complete, except where tissue damage or some complication has arisen.

- **Withdrawal state** is characterized by a group of symptoms, often specific to the drug used which develop on total or partial withdrawal of a drug, usually after repeated and/or high-dose use. The duration usually is of few hours to a few days. Typically, the patient reports that withdrawal symptoms are relieved by further substance use.
- **Dependence syndrome:** Cluster of physiological, behavioral and cognitive phenomena in which the use of substances takes on a much higher priority for a given individual than other behaviors that once had greater value. It is characterized by the desire (often strong, sometimes overpowering) to take psychoactive drugs, alcohol or tobacco.
- **Harmful use:** Continued drug use despite awareness of harmful medical and/or social effect of the drug being used/or a pattern of physically hazardous use of drug (e.g. driving during intoxication). The diagnosis requires that actual damage should have been caused to the mental or physical health of the abuser. Harmful use is not diagnosed, if dependence syndrome is present.

Differentiation 61.1: Drug addiction and drug habituation

S.No.	Feature	Drug addiction	Drug habituation
1.	Compulsion	Present	Desire, but no compulsion
2.	Dependence	Psychological and physical	Psychological, but not physical
3.	Dose	Tendency to increase	No tendency to increase
4.	Withdrawal symptoms	Characteristic symptoms	None or mild
5.	Harm	Both—individual and society	Individual only

DSM-IV Criteria for Diagnosis of Substance Dependence

It is based on the presence of at least three symptoms occurring at anytime in a 12-month period.

- i. Tolerance.
- ii. Withdrawal.
- iii. Administration of larger doses or over longer periods than originally intended.
- iv. Decreased control over usage.
- v. Increased time investment in acquisition, use or recovery from substance.
- vi. Decreased participation in occupational, recreational or social events.
- vii. Continued use despite social, psychological or physical problems caused by the substance.

The recent DSM-IV criterion has eliminated the need for withdrawal and tolerance as criteria to make a diagnosis of substance abuse disorder as opposed to substance dependence disorders. The criterion for diagnosis of substance abuse disorders are:

- i. Hazardous or compulsive use
- ii. The role of impairment
- iii. Recurrent legal problems

Psychoactive Substances

The major dependence producing drugs are given in Table 61.1.

Alcohol

Alcohol dependence (earlier called *alcoholism*) is a psychiatric diagnosis in which an individual uses alcohol despite significant areas of dysfunction evidence of physical dependence and/or related hardship. It is more common in males and often associated with drug dependence/abuse.

Alcohol dependence has been classified into five types based on the pattern of use (not on the basis of severity):

- i. *Alpha alcoholism*: Excessive and inappropriate drinking to relieve physical and/or emotional pain with no loss of control but ability to abstain present.
- ii. *Beta alcoholism*: Excessive and inappropriate drinking with physical complications (e.g. gastritis, cirrhosis) due to cultural drinking and poor nutrition but there is no dependence.
- iii. *Gamma (malignant) alcoholism*: Physical and psychological dependence with tolerance and withdrawal symptoms with inability to control drinking.
- iv. *Delta alcoholism*: Inability to abstain, tolerance, withdrawal symptoms, amount of alcohol consumed can be controlled and social disruption is minimal.
- v. *Epsilon alcoholism*: Dipsomania and spree-drinking.

Certain laboratory markers of alcohol dependence:

- i. GGT (γ -glutamyl-transferase) is raised to about 40 IU/l in 80% of the alcohol dependent individuals.
- ii. MCV is > 92 fl in 60% of the alcohol dependent individuals.
- iii. Other markers include alkaline phosphatase, AST, ALT, uric acid, triglycerides and CK.

GGT and MCV together can identify three out of four problem drinkers. In addition, BAC and breathalyzer can be used for this purpose.

The treatment can be broadly divided into:

- i. Detoxification (detox)
- ii. Treatment of alcohol dependence

Detoxification: Treatment of alcohol withdrawal symptoms, i.e. symptoms produced by removal of the 'toxin' alcohol.

The most common withdrawal syndrome is *hangover*.

Signs and symptoms: Nausea, vomiting, weakness, mild tremors, irritability, headache and insomnia are common symptoms. Sometimes, it is characterized by delirium tremens, alcoholic seizures and hallucinosis.

Table 61.1: Dependence producing drugs

S.No.	Drug	Physical dependence	Psychological dependence	Tolerance
1.	Alcohol	Moderate	Moderate	Mild
2.	Cannabis	Little	Moderate	Mild
3.	Cocaine	Little	Moderate	None
4.	Opioids	Severe	Severe	Severe
5.	Amphetamine	Moderate	Moderate	Severe
6.	LSD	None	Mild	Mild
7.	Barbiturates	Moderate	Moderate	Severe
8.	Inhalants	Little	Moderate	Mild
9.	Nicotine	Mild	Moderate	Mild
10.	Caffeine	Mild	Moderate	Mild

Treatment: The drugs of choice are benzodiazepines. Chlordiazepoxide (80-200 mg/day in divided doses) and diazepam (40-80 mg/day in divided doses) may be used.¹ Vitamin B complex is also added.

Treatment of alcohol dependence: After detox is over, there are several methods for further management:

- Behavior therapy (aversion therapy is commonly used), psychotherapy and group therapy.
- *Deterrent agents* (alcohol sensitizing drugs): Disulfiram, citrated calcium carbimide, metronidazole, nitrafezole and methyltetrazolethiol can be used.²
- *Anticraving agents:* Acamprosate, naltrexone and fluoxetine are used.³
- *Other medications:* Benzodiazepines, antidepressants, antipsychotics, lithium, carbamazepine and even narcotics have been used.

Opioids

Addiction with opiates involves dopaminergic pathways and reward circuits that control processes, such as hunger, thirst and drug addiction.

Most common dermatologic manifestation is the 'tracks', the hypertrophic linear scars that follow the course of large veins (concealment of intravenous marks is done by making tattoos at unusual sites). Other manifestations include tetanus, skin infections, abscesses, hepatitis, HIV/AIDS, pneumonia, endocarditis, osteomyelitis, fat necrosis, lipodystrophy, skin atrophy and amenorrhea.

The onset of **withdrawal symptoms** occurs within 12-24 h and symptoms subside within 7-10 days of the last dose of opioid.

Signs and symptoms: Nausea, vomiting, anorexia, sweating, diarrhea, yawning, lacrimation, rhinorrhea, tachycardia, pupillary dilatation, insomnia, muscle cramps, generalized bodyache, anxiety, piloerection (*goose skin*), and mild elevation of blood pressure, body temperature and respiratory rate. The heroin withdrawal syndrome is more severe than that of morphine.⁴⁻⁶

Treatment^{7,8}

The treatment can be divided into:

- i. *Treatment of overdose:* Narcotic antagonists (e.g. naloxone and naltrexone) are used.⁹
- ii. *Detoxification*
 - Methadone (25-50 mg twice daily), a substitution drug is used in the West to recover from the withdrawal symptoms.¹⁰
 - Clonidine, 0.3-1.2 mg/day is used which is gradually tapered off in 10-14 days. Use of

naltrexone (100 mg orally, alternate day) with clonidine is recommended.

- Other drugs: Other detox agents like levo-alpha acetyl methadol (LAAM), propoxyphene, diphenoxylate, buprenorphine and lofexidine provides an alternative to methadone.¹¹
- iii. *Maintenance therapy:* Methadone is commonly used. Buprenorphine and LAAM are considered effective in long-term management. Opioid antagonist like naltrexone combined with clonidine is effective for detox and maintenance therapy.
- iv. *Other methods:* Individual psychotherapy, cognitive, family, group or motivational enhancement therapy with rehabilitation at the social and occupational levels are other methods of treatment in dependence disorder.

Cocaine

Cocaine use produces a very mild physical, but a very strong psychic dependence.¹² A **triphasic withdrawal syndrome** follows an abrupt discontinuation of chronic cocaine use.

Signs and symptoms: In the early phase (*crash phase*, 9 h to 4 days), there is anorexia, depression, agitation, excessive craving, hypersomnia, fatigue and exhaustion which is followed by normal mood, anxiety and anhedonia (next 4-7 days). In third phase (*extinction phase*, after 7-10 days), there are no withdrawal symptoms, but increased vulnerability to relapse.

Treatment

- i. Bromocriptine and amantadine are useful in reducing cocaine craving. Gabapentin is being used in adult addicts.
- ii. Other useful drugs—desipramine, imipramine and trazodone (both for reducing craving and for antidepressant effect).
- iii. Treating underlying psychopathology—most important step. Psychosocial treatment techniques, like supportive psychotherapy and contingent behavior therapy are useful.

Cannabis

Cannabis produces a mild physical dependence and withdrawal syndrome. This syndrome begins within few hours of stopping cannabis use and lasts for 4-5 days. Psychological dependence ranges from mild (occasional 'trips') to severe (compulsive use) form.

Signs and symptoms: Chronic users and abrupt cessation may experience malaise, irritability, agitation, insomnia,

drug craving, depression, tremors, nausea, sweating and bodyache. Hippocampus is said to be affected which results in impairment of attention, learning, memory, retention and retrieval. Effects on the lungs are similar to nicotine. Chronic use may lead to 'amotivational' syndrome with loss of age-appropriate behavior, like lethargy, lack of interest in day-to-day activities at home and school.¹³ Decreased sperm count and sperm motility and morphologic abnormalities of spermatozoa following marijuana use have been reported.

Treatment: Since the withdrawal syndrome is mild, supportive and symptomatic treatment is given.¹⁴ Psychotherapy and family therapy are also important in dependence.

Barbiturates

Barbiturates produce marked physical and psychological dependence. Tolerance develops rapidly and is usually marked. There is also a cross-tolerance with alcohol.

Withdrawal syndrome can be very severe and usually occurs in individuals who are taking > 600-800 mg/day of secobarbital equivalent for more than one month.

Signs and symptoms: It is characterized by marked restlessness, tremors, hypertension, seizures and in severe cases, a psychosis resembling delirium tremens. The withdrawal syndrome is at its worst about 72 h after the last dose. Coma followed by death can occur in some cases.

Treatment: Treatment is conservative. Pentobarbital substitution can be given. Follow-up supportive treatment is important for associated depression.

Amphetamines

It is a CNS stimulant which can be used by snorting, smoking, ingestion and intravenously. Among common users are students and sportspersons who require to overcome the need for sleep and fatigue. Symptoms are similar to cocaine abuse.¹⁵

Signs and symptoms (Acute intoxication)

- i. **CVS:** Tachycardia, hypertension, hemorrhage, cardiac failure and cardiovascular shock.
- ii. **CNS:** Seizures, hyperpyrexia, tremors, ataxia, euphoria, pupillary dilatation and tetany.
- iii. **Psychiatric:** Anxiety, irritability, panic, insomnia and hostility.

Acute intoxication may present as a paranoid hallucinatory syndrome which closely mimics paranoid

schizophrenia.¹⁶ The distinguishing features include rapidity of onset, prominence of visual hallucinations, absence of thought disorder, appropriateness of affect, fearful emotional reaction and presence of confusion.

Chronic use leads to severe compulsive craving for the drug and a high degree of tolerance (needs 15-20 times the initial dose to obtain the same effect). Tolerance usually develops to the central as well as cardiovascular effects of amphetamines. Tactile hallucinations may occur in chronic amphetamine intoxication.

Withdrawal symptoms include depression, apathy, suicidal tendency, fatigue, hypersomnia with alternating insomnia and agitation.

Treatment: Patient should be kept in a dark room, acidification of the urine and gastric lavage is done. Acute intoxication is treated symptomatically—for hyperpyrexia (cold sponging, cooling blanket and antipyretics), hypertension (sodium nitroprusside or α -adrenergic antagonists), seizures (lorazepam or diazepam) and psychotic symptoms (haloperidol).

For withdrawal symptoms, symptomatic treatment, antidepressants and supportive psychotherapy is indicated.

- Methamphetamine (methyl homolog of amphetamine; *ice, speed, crank, glass, meth, chalk, crystal or yabba*) has developed into the stimulant of choice for adolescents as it is superior to amphetamine in CNS effects.
- Recently, there has been a resurgence of amphetamine use with the availability of 'designer' amphetamines, like MDMA (3,4-methylenedioxy-methamphetamine; street name: ecstasy or XTC).¹⁷
- Amphetamine is one of the drugs included in the 'dope test' for athletes.

HALLUCINOGENS

Most commonly used hallucinogenic drugs are LSD and MDMA or ecstasy.

Lysergic Acid Diethylamide (LSD)

LSD (acid, blotters) is obtained from rye fungus and is rapidly absorbed from the GIT with onset of action in 30-40 min. LSD presumably produces its effects by an action on the 5-HT levels in the brain.

Although tolerance and psychological dependence occur with LSD use, no physical dependence or withdrawal syndrome is seen. A common pattern of LSD use is *trip* (occasional use followed by a long period of abstinence).

Signs and symptoms (Acute intoxication)

- i. *Somatic or physical*: Dizziness, dilated pupils, nausea, flushing, hyperthermia, paraesthesia, hyperactive reflexes and tremors.
- ii. *Perceptual*: Altered changes in vision and hearing, like floating feeling, illusions, sensation of synesthesia or 'seeing' smells and 'hearing' colors.¹⁸
- iii. *Psychic or changes in sensorium*: Delusional ideation, body distortion, suspiciousness to the point of toxic psychosis, depersonalization and loss of sense of time.

Treatment includes removing the patient from aggravating situation, anxiolytics and symptomatic treatment.

Methylene-dioxy-methamphetamine (MDMA)

MDMA is similar to mescaline and also known as one of the 'club drugs' or 'rave drug'.¹⁹ It is supposed to interact with serotonergic neurons in the CNS.

Acute symptoms include euphoria, heightened sensual awareness, and increased psychic and emotional energy. MDMA produces less amount of emotional lability, depersonalization and disturbance of thought.

Adverse effects include nausea, teeth grinding, blurred vision, anxiety, panic attacks and psychosis. MDMA has been associated with sudden death due to cardiac arrhythmia.

No specific treatment for acute overdose, only symptomatic treatment is given.

Inhalants

They are commonly abused because of their easy availability, rapid action and low cost. The three major classes of inhalants are:

- i. *Solvents*: Paint thinners, gasoline, glues, dry-cleaning fluid and correction fluid.
- ii. *Gases*: Butane lighters, propane tanks, refrigerant gases, aerosol products—spray paints, deodorant sprays and anesthetic gases—ether, chloroform and halothane.
- iii. *Nitrites*: Cyclohexyl nitrite, amyl nitrite.

Acute symptoms: Initially, there is mild stimulatory effect (euphoria, enhanced musical appreciation and aphrodisiac effect) which is followed by inhibition and syncope. Concentrated amount of these aerosols may cause suffocation, heart failure and death.

Adverse effects include hearing loss, peripheral neuropathies or limb spasms, CNS, liver and kidney damage, blood oxygen depletion, bone marrow damage, and Kaposi's sarcoma.

Chronic abuse cause behavioral disturbances, such as inattentiveness, lack of coordination and general disorientation.

Treatment of acute inhalant intoxication is usually supportive, like providing oxygen and phenytoin for cardiac arrhythmias, bretylium for ventricular fibrillation and checking methemoglobin or carboxyhemoglobin level.

Nicotine

Nicotine, the active ingredient in cigarettes causes intoxication, dependence, tolerance and withdrawal syndrome. Each cigarette contains 10 mg of nicotine and per cigarette delivers 1-3 mg of nicotine. Abusers tend to hide or lie about their use, and begin to develop tolerance and the pleasure associated with continued use.

Action: Nicotine affects cholinergic receptors at the nucleus accumbens. It also increases acetylcholine, serotonin and beta-endorphin release.

Smokers tend to have a significant risk of coronary artery disease, lung cancer, emphysema and laryngeal carcinoma. Smokeless tobacco can cause tooth loss, leukoplakia and oral cancer. The negative impact of passive smoking is well established.

Treatment: Nicotine replacement therapy or bupropion can be used in those who are motivated to quit. The nicotine patch method, gum and spray are the most useful form available. Medications, like clonidine and nortriptyline can be used as second line of treatment.^{20,21}

Complications of Drug Abuse

The different routes of intake may produce different physical lesions.

- i. **Oral**: Self-neglect, malnutrition and dental decay.
- ii. **Injections**: The peripheral veins in the arms, hands, legs and sometimes, abdomen, groin or neck are damaged. Over-use of the same veins produces thrombosis and phlebitis and pulmonary embolism. The veins become dark in color, hard and may ulcerate. When healed, there may be white or silvery linear scars in the axis of the limb.
 - Intra-arterial injection may cause vascular damage and gangrene.
 - Fragments may be injected and lead to micro-emboli in the lungs and liver where they can form granulomas and even abscesses.
 - *Infection*: Cellulitis and skin abscess formation at the injection site.
 - Fat atrophy and necrosis and chronic myositis may be seen.

- Septicemia and subacute bacterial endocarditis may occur.
- Shared syringes and needles can transmit hepatitis B and C, HIV, syphilis and malaria.
- iii. **Inhalation:** It may precipitate asthma or bronchitis, pneumothorax and vomiting.
- iv. **Other complications:** Pulmonary tuberculosis, pneumonias, accidents from traffic, falls and fires (because of impairment of alertness and behavior), theft, prostitution, personal violence and murder. Death from poisoning can occur from the effects of the drugs or from contaminants, such as strychnine which are used to dilute the drugs.
- v. Acute and chronic liver disease.
- vi. Kidney problems and amyloidosis.
- vii. Psychiatric complaints.

Postmortem Findings

External

- i. There are often signs of wasting of the body.
- ii. Froth may be seen at the mouth and nose.
- iii. The regional lymph nodes may be enlarged.
- iv. The body may be extensively tattooed to hide scars. Linear needle track scars, often pigmented, are usually found overlying fibrosed veins of the antecubital fossae, forearms and dorsa of the hands in 'mainliners'. Punctate areas of black discoloration (*soot tattooing*) are caused by deposition of carbonaceous materials along the track of the needle. Such tattooing is called '*turkey skin*', resembling the bird. The usual sites for subcutaneous or IM injections are upper arms and thighs.
- v. Additional damage to the skin and subcutaneous tissues results from attempts by the addict to obliterate the track by overlaying it with a cigarette burn or abrading with sandpaper or using chemicals. Multiple circular sunken atrophic scars (*tissue paper scars*) suggest skin popping, followed by skin infection.
- vi. Recent injection sites may show zones of inflammation surrounding or adjacent to a needle puncture site.
- vii. Subcutaneous heroin users show a higher incidence of abscesses. Healing by fibrosis may produce hyperpigmented macules or retracted circumscribed scars which resemble those from smallpox vaccinations.
- viii. Chronic edema of the hands, secondary to occlusive thrombophlebitis in the forearms is seen occasionally in long-term addicts.
- ix. Habitual inhalation of cocaine or heroin (snorting or sniffing) causes perforation of the nasal septum.

Internal

- i. There may be phlebitis, phleboscrosis, thrombosis, and recent and resolving perivenous hemorrhage. The vein and surrounding tissue should be preserved for chemical analysis.
- ii. Typical visceral findings include non-specific triad of edema, bronchopneumonia and aspiration of gastric contents.
- iii. Pericardial, pleural and peritoneal effusions may be found.
- iv. *Stomach* may contain pills or capsules.
- v. *Liver:* Most common changes from parenteral drug abuse consist of hepatic lymphadenopathy and hepatic portal triaditis. The liver may be slightly enlarged or show evidence of cirrhosis.
- vi. *Spleen:* Splenomegaly and portal lymph node hyperplasia are common. The most constant finding in both spleen and portal lymph nodes is the presence of large germinal centres, but the morphological features are not specific.
- vii. Hyperplastic changes in the reticuloendothelial system are common.
- viii. *Lungs:* Pleura may show petechial hemorrhages, and lungs are congested and edematous.
- ix. *Heart* may show valvular disease.
- x. In mainliners, the crystals lodge in pulmonary capillaries and produce a foreign body granulomatous reaction. Pulmonary hypertension with right ventricular hypertrophy occurs due to extensive microcrystalline pulmonary emboli.
- xi. *Brain:* It may show edema and focal areas of necrosis involving the globus pallidus and hippocampus due to hypoxia.

MULTIPLE CHOICE QUESTIONS

1. **Treatment of acute alcohol withdrawal:** *Punjab 09*
 A. Diazepam B. Bupropion
 C. Disulfiram D. Acamprosate
2. **Drug not used in treatment of alcohol dependence:**
NIMHANS 08; PGI 06, 09, 11; TN 08; AI 11
 A. Diazepam B. Disulfiram
 C. Acamprosate D. Naltrexone
3. **Alcohol anti-craving agents are all, except:**
AIIMS 09
 A. Lorazepam B. Clonidine
 C. Acamprosate D. Naltrexone
4. **Yawning is a common feature of:** *AIIMS 06*
 A. Alcohol withdrawal B. Cocaine withdrawal
 C. Cannabis withdrawal D. Opioid withdrawal
5. **All are true of opioid withdrawal, except:**
NIMHANS 10
 A. Yawning B. Hallucinations
 C. Lacrimation D. Piloerection
6. **Boy is having diarrhea, rhinorrhea and sweating, most probable diagnosis is:** *AIIMS 10*
 A. Cocaine withdrawal B. Heroin withdrawal
 C. Marijuana withdrawal D. LSD withdrawal
7. **In patients with substance abuse, drug NOT used is:**
PGI 06
 A. Naltrexone B. Naloxone
 C. Clonidine D. Chlorpromazine
8. **Not used for treatment of heroin detoxification:**
AIIMS 09, 10; AP 11
 A. Disulfiram B. Buprenorphine
 C. Clonidine D. Lofexidine
9. **Naltrexone is used in:** *Bihar 10; AIIMS 10*
 A. Treat withdrawal symptoms
 B. Treatment of overdose
 C. Prevention of relapse
 D. Deterrent agent
10. **The drug which is used for long-term maintenance in opioid addiction:** *AIIMS 06; Punjab 09; AI 11*
 A. Nalorphine B. Naloxone
 C. Butarphanol D. Methadone
11. **Alternative to methadone for maintenance treatment of opiate dependence:** *AIIMS 05*
 A. Diazepam
 B. Chlordiazepoxide
 C. Buprenorphine
 D. Dextropropoxyphene
12. **Tolerance is seen in all, except:** *UP 07*
 A. Morphine B. Amphetamine
 C. Cocaine D. Barbiturates
13. **Amotivational syndrome is seen with:** *Maharashtra 10*
 A. Heroin B. Cannabis
 C. Cocaine D. Clonidine
14. **Symptomatic treatment is only required in withdrawal syndrome caused by:** *BHU 11*
 A. Cannabis B. Morphine
 C. Alcohol D. Cocaine
15. **Cocaine abuse is much similar to which abuse:** *WB 07*
 A. Cannabis B. Nicotine
 C. Heroin D. Amphetamine
16. **Paranoid schizophrenia is mimicked by intake of:** *JIPMER 11*
 A. Amphetamine B. Heroin
 C. Cannabis D. Alcohol
17. **True about MDMA:** *NIMHANS 09*
 A. Ecstasy is another name for it
 B. It is a cocaine congener
 C. Causes parkinsonism like syndrome
 D. Methadone is used to treat withdrawal symptoms
18. **A young city dweller presented with history of drug abuse and complaining of change in perception, like hearing sights and seeing sounds. Substance responsible for this:** *AI 12*
 A. LSD B. Phencyclidine
 C. Cocaine D. Amphetamine
19. **Rave drug is:** *AI 11*
 A. Cannabis B. Cocaine
 C. Heroin D. Methamphetamine
20. **Drug used in the prophylaxis of nicotine addiction:**
NIMHANS 08; Manipal 09; Maharashtra 10, WB 11
 A. Diazepam B. Naloxone
 C. Bupropion D. Acamprosate
21. **All are used in nicotine de-addiction, except:**
PGI 05; NIMHANS 10, 11
 A. Bupropion B. Clonidine
 C. Nicotine gum D. Buspirone

1. A 2. A 3. A 4. D 5. B 6. B 7. D 8. A 9. A & B 10. D 11. C
 12. C 13. B 14. A 15. D 16. A 17. A 18. A 19. D 20. C 21. D

Kerosene Oil Poisoning

62

Introduction

- Hydrocarbons include all compounds composed predominantly of carbon and hydrogen; the compounds of importance are derived from petroleum and wood.
- In general, among the petroleum distillates, ether, petrol, naphtha and benzene are highly poisonous when swallowed or inhaled.
- Kerosene oil is the most common amongst the hydrocarbons causing accidental poisoning in children.

Action

It causes local irritation to the mucosa of the GIT, and after absorption it has neurotoxic, nephrotoxic, and respiratory depressing effects.

Signs and Symptoms

On ingestion

System	Signs and symptoms
Local GIT	Irritation of oral mucosa and kerosene taste. Sensation of burning in the throat, nausea, vomiting, colicky pain and diarrhea; breath, vomit and urine smells of kerosene.
RS	Cyanosis, bronchopneumonia, pulmonary edema, slow and shallow respiration.
CNS	Giddiness, headache, lethargy/drowsiness, restlessness, weakness, muscle twitchings, seizures and coma.
Others	Pyrexia, arrhythmias, hemolytic anemia, acute renal failure, hepatotoxicity and bone marrow suppression.

Death is due to respiratory failure.

Inhalation of fumes causes choking, cough, respiratory distress, pyrexia, headache, vertigo, nausea, vomiting and lung complications, followed by intense excitement, hallucinations and convulsions. In fatal cases, cyanosis, unconsciousness and coma precede death.

Fatal dose: 10-50 ml.

Fatal period: Few hours.

Investigations

Chest radiograph shows bilateral punctuate mottled densities (fine perihilar opacities) involving multiple lobes, but particularly the lower lobes, and atelectasis.

Treatment¹

- In case of **cutaneous exposure**, decontamination is done by removing the clothing and thoroughly washing the skin with soap and water.
- In case of **inhalation**, the patient must be removed to the open air and artificial respiration is given. The rest of the treatment is symptomatic.
- In case of **ingestion**, supportive measures are the lifeline of treatment. The patient needs to be observed for at least 24 h in the hospital for any signs of kerosene toxicity.
 - i. Gastric lavage and emesis are contraindicated, except:
 - When large amount of kerosene has been ingested (> 1 ml/kg).
 - When the patient is in coma.
 - When kerosene is mixed with pesticides, heavy metals and other toxic substances.In no case, should it ever be done without intubation as there is a risk of aspiration.
 - ii. Activated charcoal has a limited role in the management of kerosene ingestion as it poorly adsorbs most hydrocarbons.
 - iii. Bacterial pneumonia is uncommon. Prophylactic antibiotic therapy is not recommended. Antibiotics are indicated in limited situations, like malnutrition or immunocompromised state. If fever occurs, give specific antibiotic.
 - iv. Corticosteroids are not recommended, except when administered concurrently at the time of aspiration.
 - v. Bronchodilators are used for chlorinated or fluorinated solvent intoxication.
 - vi. Oxygen therapy is given in hypoxemia.

Complications: Aspiration pneumonitis is the most common complication of kerosene ingestion, followed by CNS and CVS complications.

- *Respiratory:* Aspiration and lung injury secondary to pneumonitis.
- *CNS:* Seizures, encephalopathy and memory loss.
- *CVS:* Myocarditis and cardiomyopathy.

Postmortem Findings

- Acute gastroenteritis and kerosene odor may be observed on opening the chest and abdominal cavity.
- Stomach:* Petechial hemorrhages with congested mucosa.
- Lungs:* Petechial hemorrhages, congested, edematous and bronchopneumonia.
- Degenerative changes in the *liver* and *kidneys* and hypoplasia of the bone marrow occur after prolonged period of inhalation.
- Organs are congested, and other signs of asphyxia may be seen.

In case of suspected death from kerosene, the lungs, brain and other viscera should be preserved in saturated saline for chemical analysis.

Medico-legal Aspects

- In north India, it accounts for about 50% of infants and children brought to hospital for accidental poisoning, who have taken kerosene mistaking it for water.
- Kerosene is occasionally used for self-immolation.
- Homicidal attempts by pouring kerosene on clothes and igniting them are common in case of dowry deaths in India.
- Inhalation of volatile hydrocarbons is common abuse in adolescents and young adults for recreation, similar to drugs and alcohol.

Chronic poisoning can occur in persons who handle petroleum products.

Symptoms are weakness, dizziness, pain in limbs, peripheral numbness, paraesthesias, weight loss and anemia.

Cardiomyopathy, cerebellar atrophy, dementia, cognitive deficits and peripheral neuropathy are seen with chronic hydrocarbon inhalant abuse.

Treatment requires isolation of the patient from exposure and symptomatic management.

MULTIPLE CHOICE QUESTION

1. Management of kerosene oil poisoning includes all, **except:**

AP 09

- Gastric lavage is done
- Bronchodilators are given
- Oxygen is given
- Corticosteroids are not beneficial

Definitions

- **Food poisoning** include all illnesses which result from ingestion of food containing bacterial or non-bacterial products including viruses, environmental toxins or toxins present within the food itself. But the term is usually restricted to acute gastroenteritis due to the bacterial infection of food or drink.
- **Food-borne disease outbreak** is defined by the following criteria:
 - i. Similar illness, often gastrointestinal, in a minimum of 2 individuals
 - ii. Evidence of food as the source

Poisoning is common in summer because warm temperature favors multiplication of microorganisms.

Causes

- i. Poisoning due to bacteria and toxins.
- ii. Poisons of vegetable origin (natural food poisons): *Lathyrus sativus*, poisonous mushrooms and *Argemone mexicana*.
- iii. Poisons of animal origin: Poisonous fish and mussel.
- iv. Chemical: Intentionally or accidentally added, products of food processing and radio-nucleotides.

Bacterial Food Poisoning

Bacterial food poisoning results from the ingestion of contaminated food, uncooked food or imperfectly cooked food. It is divided into two groups:

- i. **Infection type** (*inflammatory diarrhea*) results from multiplication within the body of pathogenic organisms contained in the food. Organisms belong mainly to the *Salmonella* group and occasionally organisms, like *Proteus*, *E. coli*, *Bacillus cereus*, *Streptococci*, *Shigella* and paratyphoid bacilli are also involved. *Salmonella* invade and destroy the mucosa of the small intestine.

Symptoms: Sudden onset of nausea, vomiting, abdominal pain and foul smelling watery diarrhea stained with blood and/or mucus occurs in 12 h to two days. Diarrhea in several patients after 24-48 h

of eating the same meal indicates ingestion of salmonella.¹

- ii. **Toxin type** (*non-inflammatory diarrhea*) results from ingestion of preformed toxins (*exotoxins*) from bacterial proliferation in prepared food (canned or preserved food), e.g. enterotoxin of *Staphylococci*, *Clostridium perfringens*, *Bacillus cereus* and botulinum toxin. The materials usually affected are meat, milk, fish or egg.

Symptoms: Salivation, diarrhea, nausea, abdominal cramps and vomiting occur for a short time and the patient recovers as soon as the enterotoxins have been neutralized and metabolized, usually within 24 h of poisoning.

Acute diarrhea in food poisoning usually lasts < 2 weeks. Diarrhea lasting 2-4 weeks is classified as *persistent*. *Chronic diarrhea* is defined by duration of > 4 weeks.

Treatment

- i. Gastric lavage and purgatives are given.
- ii. Glucose-saline infusion should be given to promote elimination of the toxins from the system.
- iii. Antibiotics are given depending upon the causative organism.

Postmortem Findings

- i. The mucosa of the GIT is swollen and often intensely congested and there may be minute ulcers.
- ii. Microscopic examination shows fatty degeneration of the liver.
- iii. The causative organism can be isolated from the blood and viscera.

• **Exotoxins:** Toxin soluble protein released from Gram-positive and Gram-negative bacteria. Exotoxins may be secreted, or, similar to endotoxins, may be released during lysis of the cell, e.g. cholera, pertussis and diphtheria toxins.²

• **Endotoxins** are heat stable lipopolysaccharide complex of the outer membrane of the cell wall of Gram-negative bacteria, such as *E. coli*, *Salmonella*, *Shigella*, *Pseudomonas*, *Neisseria*, *Haemophilus influenzae*, *Bordetella pertussis* and

Vibrio cholerae. Unlike exotoxin, it is not secreted in soluble form by live bacteria, but is a structural component in the bacteria which is released mainly when bacteria are lysed.

- **Enterotoxin:** A toxin produced by bacteria that is specific for intestinal cells and causes the vomiting and diarrhea associated with food poisoning.

Botulism (Allantiasis)

The term 'botulism' is derived from '*botulismus*' meaning sausage.

Botulism is an intoxication, not an infection. The causative organism *Clostridium botulinum* (gram-positive spore forming anaerobic bacilli) which multiplies in the food, e.g. sausages, tinned meat, fish and fruits, before it is consumed, and produces a powerful exotoxin—a neurotoxin. Seven distinct strains (type A to G) of *C. botulinum* have been identified.

Action

- The toxin inhibits acetylcholine and paralyzes the nerve endings by blocking the nerve impulses at the myoneural junctions.³
- Its action is selective, being confined to the cholinergic fibres of the autonomic nervous system.
- It affects the peripheral cholinergic nerve terminals including neuromuscular junctions, post-ganglionic parasympathetic nerve endings and peripheral ganglia without affecting the CNS.⁴

Signs and Symptoms⁵⁻⁷

The incubation period is 12-30 h. Characteristically, it produces symmetric descending paralysis. The GIT symptoms, like nausea, vomiting and abdominal pain are rare.

Initial symptoms are dry/sore mouth or throat, difficulty with visual accommodation, diplopia, dysphonia, descending bilaterally symmetrical motor paralysis initiated by—abducent (VI) or oculomotor (III) nerve palsy (strabismus, blepharospasms), dysphagia, constipation, hypothermia, respiratory insufficiency and urinary retention. The patient is conscious till death which is preceded by coma or delirium.

Fatal dose: 0.01 mg or even less.

Fatal period: 24-48 h, may extend to a week.

Differential Diagnosis

Toxin type of food poisoning, poliomyelitis, myasthenia gravis, encephalitis, multiple sclerosis, Guillain-Barre syndrome, diphtheria, tetanus, and poisoning from CO, organophosphates and elapid snake bite.

Treatment

- Maintenance of ABC.
- Decontamination—Gastric lavage, activated charcoal, purgatives and whole bowel irrigation.
- Polyvalent botulinum antitoxin (types A, B and E) one vial by slow IV in normal saline and one vial IM, repeated at 2-4 h intervals IV.⁸
- Botulism immune globulin (BIG), 50 ml is given IV daily, till the patient recovers.
- Frequent dose of brandy is beneficial as alcohol precipitates toxin.

Postmortem Findings

- Kidneys, liver and meninges are congested.
- Histological examination of the organs may show thrombosis.

- *C. botulinum* spores have been found in honey that was implicated in infant botulism.
- Infant botulism is a neuroparalytic disease which affects otherwise healthy children < 1 year old. Early symptoms are constipation, generalized weakness and weak cry.
- SIDS could be attributed to *C. botulinum* intoxication.
- *Botulinum toxin* type A (Botox) was approved by the US FDA for the treatment of strabismus, blepharospasm and hemifacial spasm. It is also used for treatment of frown lines between the eyebrows (glabellar lines), spasticity and muscle pain disorders and cervical dystonia.⁹

POISONOUS FOODS

Poisonous foods are those which contain poison derived from plants, animals and inorganic chemicals.

Lathyrus Sativus ('Kesari Dhal')

This is a variety of pulse and is the staple food for the low-income groups in some areas of Central India. Consumption of *L. sativus* seeds in quantities exceeding 30% of the total diet for more than 6 months has been known to cause paralysis. Men are more susceptible than women.

Active Principle

β -N-oxalyl amino-alanine (BOAA), a neurotoxic amino acid present in the seed cotyledons.¹⁰

Signs and Symptoms

The continued use of *L. sativus* produces **neurolathyrism**, which is characterized by progressive spastic paraplegia with preservation of sphincters, sensation and mental activity.¹¹

There may be pain in the back or weakness of legs and difficulty in sitting down and getting up. The patient is unable to walk without the aid of a stick, the legs tremble

and are dragged along with difficulty. A spastic gait develops characterized by 'walking on tiptoes' with the legs crossing scissor-wise. Later, complete paraplegia occurs. There is no atrophy or loss of the tone of muscles and no reaction of degeneration. The knee jerks are increased, ankle clonus is marked and Babinski's sign is present.¹²

Treatment

- Rich diet with exclusion of the pulse, massage and application of electricity are useful.
- Steeping the pulse in hot water and parboiling remove 90% of toxic amino acid.¹²

Death is very rare. At autopsy, lateral columns of the spinal cord may show sclerosis.

Mushrooms

Some species are non-poisonous and are used as food. Common poisonous fungi are *Amanita phalloides* and *Amanita muscaria* (deadly agaric/death cap).

Active Principles and Action

Amanita muscaria contains an alkaloid muscarine which stimulates postganglionic cholinergic fibres. *Amanita phalloides* contains phalloidin, phallon, α -amanatin which are cyclopeptides and virotoxins. They are powerful inhibitors of cellular protein synthesis.

Signs and Symptoms

In some cases, irritant symptoms may be present, in others neurotic, and in some there may be a combination of both.

- *Irritant symptoms* are delayed by 6-24 h and include constriction of the throat, burning pain in the stomach, nausea, vomiting and diarrhea followed by cyanosis, slow pulse, labored respiration, convulsions, sweating, collapse and death.
- *Neurotic symptoms* are giddiness, headache, delirium, diplopia, constriction of the pupils, cramps, twitching of the limbs, convulsions, salivation, bradycardia and coma. Icterus, hepatic and renal failure occurs in 3-6 days.

Fatal dose: 2-3 mushrooms.

Fatal period: Usually 24 h.

Diagnosis: *Meixner test* (Wieland test) for detection of toxins (α -amanitin) in stools and vomitus.

Treatment

- Supportive:* It comprises of aggressive correction of fluid and electrolyte losses, and in the advanced stages, attention to liver and renal failure.
- Specific:* Decontamination is required to remove the toxin rapidly. Oral activated charcoal and lactulose are ideal.

- In *amatoxin type of poisoning*, penicillin, silybin, thioctic acid and corticosteroids have been tried for their synergistic effect in inhibiting the binding of both toxins and interrupting enterohepatic recirculation of toxins.
- In *muscarine poisoning*, the specific antidote is atropine sulphate, 0.01-0.02 mg/kg/dose IV repeated every 30 min until atropinization.¹³
- For convulsions, diazepam may be given.
- Hemodialysis may be done.
- Symptomatic treatment.

Postmortem Findings

- Inflammation of the mucous membrane of the GIT, and fatty degeneration of the liver, kidneys and heart may be found.
- In case of neurotic symptoms, congestion of the brain and petechial hemorrhages in serous membranes are seen.

Medico-legal aspects: Poisoning is usually accidental, and rarely homicidal.

Argemone Mexicana (Prickly Poppy)

It grows wild all over India in the cold season. All parts of the plant are poisonous. The argemone or *katkar* oil causes **epidemic dropsy**.¹⁴ The flowers are yellow and seeds are dark-brown in color, smaller than mustard seeds and covered with minute, regularly arranged projections and depressions.

Active Principles

The plant contains two alkaloids—berberine and protopine. The oil contains two alkaloids, sanguinarine and dihydrosanguinarine.¹⁵ They cause abnormal permeability of blood vessels.

Signs and Symptoms

Symptoms appear slowly with loss of appetite, diarrhea, marked edema of the legs, and sometimes generalized anasarca.

System	Signs and symptoms
Heart	Myocardial damage and dilatation of the heart.
CVS	Hypotension, breathlessness and feeble pulse.
Hepatic	Enlarged and tender liver.
PNS	Tingling and hyperaesthesia of skin and tenderness of the calf muscles. The jerks are feeble or absent.
Ocular	Dimness of vision (in about 10% of cases) due to increased intraocular pressure.
Skin	Bluish mottling of the skin due to dilation of the peripheral vessels.

Death occurs from severe damage to the heart.

Treatment: Good diet, decontamination, withdrawal of oil, diuretics, corticosteroids and supportive treatment.

Medico-legal aspects: The oil from the seeds is sometimes used as an adulterant of mustard oil or other edible oil.

Food Allergy

Some persons are hypersensitive to certain types of protein, e.g. meat, fish, eggs or milk which are ordinarily quite harmless, and suffer from gastroenteritis, local urticarial rashes joint pains or asthmatic attack. Antihistaminics and steroids may be given.

MULTIPLE CHOICE QUESTIONS

- A 22-year-old male had an outing with his friends and developed fever of 38.5 C, diarrhea and vomiting after eating chicken salad 24 h back. Two of his friends developed the same symptoms. The diagnosis is:** *FMGE 08*
 A. *Salmonella enteritis* poisoning
 B. *Bacillus cereus* poisoning
 C. *Staphylococcus aureus* poisoning
 D. *Vibrio cholera* poisoning
- Which of the following is an exotoxin:** *NIMHANS 07*
 A. *E. coli* toxin B. *Proteus*
 C. *Pseudomonas* D. Tetanus toxin
- Mechanism of action of botulinum toxin:** *Kerala 11*
 A. Synthesis of acetylcholine inhibited
 B. Reuptake of ACH is increased
 C. Blocks nicotinic receptors in muscle
 D. Blocks muscarinic receptors in brain
- Botulinum affects all, except:** *AI 07*
 A. Neuromuscular junction
 B. Preganglionic junction
 C. Post-ganglionic nerves
 D. CNS
- Dysphagia, diplopia, dysarthria are characteristic symptoms of food poisoning due to:** *UPSC 08*
 A. *Staphylococcus aureus*
 B. *Clostridium botulinum*
 C. *Salmonella typhimurium*
 D. *Bacillus cereus*
- Clinical features of botulism are all, except:** *Kerala 06*
 A. Diarrhea B. Dysphagia
 C. Diplopia D. Weakness
- An 18-year-old male presented with acute onset descending paralysis and blurring of vision of 3 days duration. On examination, the patient has quadriparesis with areflexia. Both the pupils are non-reactive. The most probable diagnosis is:** *AIIMS 06*
 A. Poliomyelitis B. Botulism
 C. Diphtheria D. Porphyria
- Which poisoning can be prevented by an antitoxin:** *Manipal 11*
 A. *Staphylococcus aureus*
 B. *Clostridium botulinum*
 C. *Salmonella typhimurium*
 D. *Bacillus cereus*
- Botulinum toxin is used for the treatment of:** *DNB 08*
 A. Blepharospasm B. Risus sardonius
 C. Strabismus D. All
- In Kesari dhal poisoning due to *Lathyrus sativus*, the active principle is:** *NIMHANS 07; MAHE 08*
 A. Pyrrolozidine B. BOAA
 C. Argemone oil D. Pilocarpine
- Lathyrism is seen with eating of:** *Kerala 08*
 A. Red gram B. Kesari dhal
 C. Mushrooms D. Sausages
- True about lathyrism:** *PGI 09*
 A. Caused by *Aspergillus flavus*
 B. Prevented by parboiling
 C. Sanguinarine is the toxic principle
 D. Patient develops spastic paraplegia
- The drug of choice for mushroom poisoning is:** *AI 07*
 A. Atropine B. Physostigmine
 C. Adrenaline D. Carbachol
- Epidemic dropsy is caused by:** *Manipal 06*
 A. Kesari dhal B. Argemone oil
 C. Poisonous mushrooms D. Shell fish
- Toxin responsible for epidemic dropsy:** *AIIMS 07; UP 09; PGI 11*
 A. BOAA B. Aflatoxin
 C. Sanguinarine D. Pyrrolozidine

1. A 2. D 3. A 4. D 5. B 6. A 7. B 8. B 9. D 10. B
 11. B 12. B & D 13. A 14. B 15. C

Question Bank



All questions are either short notes or viva, if not mentioned otherwise (**LQ—long question, SN—short note, Diff.—differentiation**).

MUST KNOW

General Toxicology

1. Toxicology, poison, tolerance, idiosyncrasy.
2. Classification of poisons (based on mode of action and effects).
3. Color of hypostasis and odor in different poisoning.
4. Poisons causing subendocardial hemorrhages.
5. Physical antidote, activated charcoal, demulcents.
6. Duties of a doctor in poisoning cases.
7. Gastric lavage, contraindications.
8. Hepatotoxic and nephrotoxic poisons.
9. Chelating agents.
10. Universal antidote.
11. Dialyzable and non-dialyzable poisons.
12. Collection and preservation of samples and viscera in case of poisoning.
13. Antidotes in different poisoning.
14. Poisons causing miosis and mydriasis.
3. Danbury tremors/hatter's shakes, mercurial erethism, mercurialentis.
4. Metal fume fever.
5. Phossy jaw.
6. Vitriolage.
7. Carboluria.
8. Suis.
9. Medico-legal aspects of marking nut.
10. Active principles in opium.
11. Barbiturate automatism.
12. Various preparations and active principle of cannabis.
13. Cocainism, Magnan's syndrome.
14. Judicial execution with HCN.
15. Drug abuse and dependence.
16. Food poisoning.
17. Botulism.

Alcohol

1. Percentage of alcohol in different beverages.
2. McEwan's sign.
3. Treatment of chronic alcoholism.
4. Delirium tremens.
5. Korsakoff's psychosis.
6. Wernicke's encephalopathy.
7. Drunkenness.
8. Widmark's formula.

Rest of the Poisons

1. Active principles and identification of seeds: Ricinus, Croton, Abrus, Semecarpus, Capsicum, Strychnos, Calotropis (plant).
2. Advantages and disadvantages of arsenic as an ideal homicidal poison.
1. Ideal suicidal and homicidal poison.
2. Arsenic poisoning and cholera.
3. Artificial and true bruise.
4. Poisonous and non-poisonous snakes.
5. Neurotoxic and vasculotoxic venom.
6. Dhatura and capsicum seeds.
7. Strychnine and tetanus.
8. Drug addiction and drug habituation.

LQ

Signs and symptoms, fatal dose, fatal period, treatment, PM findings and medico-legal aspects of poisoning with:

1. Agricultural poisons: OPC, carbamate and endrin
2. Agricultural poisons: Alphas
3. Unknown substance
4. Inebriants: Ethanol and methanol
5. Somniferous poisons: Opium (including differential diagnosis)
6. Metallic poisons: Arsenic (acute and chronic), lead (plumbism), mercury and copper

7. Deliriant: Dhatura (including 9D's) cannabis and cocaine
8. Organic irritants (animal): Ophitoxemia, scorpion bites
9. Barbiturates
10. Hydrocyanic acid (including action)
11. Corrosive poisons: Strong mineral and organic acids, carbolic acid
12. Asphyxiants: CO and CO₂
13. Cardiac poisons: Cerbera thevetia, Nerium odorum
14. Kerosene oil poisoning
15. Medicinal poisons: Aspirin, PCM, diazepam, antihistaminics, antidepressants
4. Inebriants: Ethylene glycol
5. Spinal (convulsants): Strychnine
6. Peripheral nerve poisons: Curare
7. Medicinal poisons: Iron, Chloral hydrate
8. Cardiac poisons: Aconite and digitalis poisoning
9. Asphyxiants: H₂S poisoning
10. Mechanical irritants
11. War gases
12. Amphetamine and LSD intoxication

DESIRABLE TO KNOW

LQ

Signs and symptoms, fatal dose, fatal period, treatment and PM findings of poisoning with:

1. Inorganic irritants: Phosphorus
2. Metallic poisons: Thallium
3. Organic irritants (vegetable): Castor, croton, rati, marking nut, capsicum, calotropis and ergot
1. Factors modifying the action of poison.
2. Methemoglobinemia inducing agents.
3. Laboratory investigations for alcohol estimation.
4. Withdrawal symptoms and treatment in opioids and cocaine dependence.
5. Physical and psychological dependence producing substances.
6. MDMA, inhalants.
7. Lathyrus sativus, mushrooms, Argemone mexicana.
8. Cobra and viper (Diff.).

SN and Viva

Index

Page numbers followed by *f* refer to figure and *t* refer to table

A

- Abandoning of children 290
Abdomen 86, 88, 153, 224, 320, 486
Abdominal
 injuries 261
 wall 321
ABO system 374*t*, 375
Abortifacient drugs 300
Abortion 33, 305
 stick 301
Abrasion 165, 166
 collar/ring 190
Abrus precatorius 459
Abscess 112
 of brain 141
Absorption 430, 452, 526
 and excretion 441, 446, 449, 488, 512, 532, 534, 539, 542
 and metabolism 451
Abuse of drugs 112
Accident 179
Accidental
 burns 242
 drowning 161
 hanging 144
 laceration 173
 marks 79
 strangulation 147, 163
 throttling 150
 wounds 176
Acetaminophen 538
Acetic acid 97
Acetylsalicylic acid 542
Acid
 of sugar 429
 phosphatase 334
 test 383, 385
Aconite 507
 poisoning 511
Acoustic barotrauma 258
Acridine-orange fluorescent stain 114
Acro-dynia 440
Acrophobia 362
Acro-reaction test 245
Act of Commission 13, 290
Action of poison 413
Active
 component of *ganja* 500
 defense injuries 180
 ethanasia 22
Actomyosin complex 123
Acute
 edema of glottis 238
 hemolysis 448
 hemorrhagic pancreatitis 112
 inflammation of stomach 482
 ingestion 446
 inhalation 446
 intoxication 359, 545, 548, 549
 ionizing radiation effects 277
 mountain sickness 278
 paralysis 529
 poisoning 411, 429, 433, 438, 441, 446, 449, 455, 462, 481, 508
 of narcotics 478
 pulmonary embolism 267
 radiation syndrome 277
 starvation 279
 symptoms 549
Adequate supervision and timely referral 14
Adipocere 131, 133
Administration of antidotes 420
Admissibility of polygraphs in court 400
Admission
 criteria for burn patients 238
 of escaped mentally ill person 31
Adrenal insufficiency 112
Adult respiratory distress syndrome 269
Advanced decomposition 48
Age of
 abrasion 167, 167*t*
 appearance of permanent lateral incisor 68
 bruise 170*t*
 fetus 283
 scars 64
 subdural hematoma 216
Agonal
 period 110
 thrombi 92
Agoraphobia 362
Air
 current 131
 embolism 269
 in blood vessels 351
 insufflations 302
 movement 120
Airway 417
 support 494
Albumin 420
Alcohol 546
 anti-craving 551
 dementia 484
 dependence 546
 paranoia 492
 withdrawal 503
 gaze nystagmus 481
 hallucinoses 482, 484, 491
 paranoia 482, 484
 peripheral neuropathy 484
 seizures 482, 484
Aldehyde dehydrogenase 491
Algolagnia 345
Algophobia 362
Algor mortis 133, 136
Alkaline diuresis 422
Alkalization of urine 495
Alkaloids 475
Allantiasis 555
Allegations against doctors 348
Allograft 109
Alphonse Bertillon 70
Altitude illness 278
Amanita muscaria 556
Ambivalence 355
Amenorrhea 67, 315
American law institute test 366
Ammonium molybdate test 383
Amnesia 141
Amotivational syndrome 551
Amphetamines 548
Amyl nitrite 515
Analeptic drugs 494
Analysis of blood 371
Anaphylactic
 deaths 114
 shock 267
Anaphylaxis 112
Anemia 442
Anemic anoxia 111
Anesthesia 112
Anesthetic drugs and suicide 298
Anilingus 344
Animal
 and insect activity 350
 hair 75, 76*f*
Anisocytosis 443
Anorexia nervosa 363
Anoxia 111
Anoxic anoxia 111
Antegrade amnesia 229
Antemortem
 and postmortem
 abrasion 168
 bruise 171
 burns 242
 wounds 270
 bruise 182
 fracture 228
 injuries 158
 thrombus 90

- Anterior
 cranial fossa fracture 228
 fontanelle closes 69
Anterograde amnesia 210
Anteroposterior compression fractures 150
Anthrax 525
Anthropometry 70
Anticholinesterase 471
Antidotes 420
Antiglobulin consumption test 374
Antihistaminics 540
Antioxidant agents 536
Antipsychotic drugs 539
Antivenom
 reactions 470
 treatment 470
Anxiety disorder 361
Aorta 224
Aortic
 aneurysm 112
 stenosis 67
 valve 90
Apex body dealing with medical negligence cases 33
Aphasia 356
Apoplexy 157, 213, 229
Apparent death 118
Appearance of
 burn hematoma 248
 ossification centres 58*t*
Appellate powers 4
Appendicitis 112
Appointment of substitute 9
Aquatic animals 130
Arborescent markings 246
Arcus senilis 61
Argemone mexicana 556
Arguments against euthanasia 22, 23
Arsenic
 poisoning 437
 and cholera 434
 sulphide 433
 trioxide 433
Arsenious oxide 433
Arson 242
Arterial air emboli 95
Artificial
 abortion 300
 and true bruise 461
 fibres 74
 insemination 310, 310*f*
Aschheim-Zondek test 317
Aseptic autolysis 294
Aspartic acid racemization 57, 58
Asphyxia 111, 138, 139, 141, 146, 147, 152, 157
Asphyxial deaths 141
Asphyxiant gas 516
Aspiration pneumonia 141, 423
Aspirin 542
Assistant session court 36
Assisted reproductive technology 312
Atomic absorption spectroscopy 200
Atrioventricular block 423
Atropa belladonna 498
Atropinization 528
Atypical
 hanging 140
 neuroleptics 539
Auditory hallucination 354
Authority for removal of
 human organs 25
 organs 25
Autoerotic asphyxia 162
Autograft 109
Autolysis 127
Automated fingerprint identification system 73
Autonomic ganglionic 526
Autopsied in asphyxial death 103
Autopsy 83
 and disposal of radioactive corpse 106
 in decompression sickness 276
 instruments 84*f*
 of HIV positive and HBV patients 104
 of neck 141
 surgeon induced artifacts 351
Avulsed lacerated wound 172*f*
Axillary pubic hair 75
Axonal swelling/ballooning 210*f*
Azoospermia 66
- B**
- Baby's cry 286
Bacillus cereus 557
Back spatter 191
Bacteremic shock 112
Bacterial
 food poisoning 554
 infection 131
Bailable offences 37
Ballistics 183
Ballottement 317
Barberio's tests 380, 381, 385
Barbiturate automatism 495
Barium 452
 meal X-ray of stomach 81
Barotrauma 276
Barr body 47, 48, 66
 in buccal epithelium 49*f*
 in different karyotypes 46*f*
Barrier contraceptives 309
Basilar fracture 207
Basophilic stippling 443, 445
 of RBCs 443
Battered baby syndrome 290
Battle's sign 208, 208*f*, 229
Bayard's ecchymoses 139
Beating
 buttocks 393
 heart donor 109
Bees and wasps 473
Behavioral
 and emotional disorders in childhood and adolescence 364
 syndromes 363
Belly scales of poisonous and non-poisonous snakes 466*f*
Bending of neck 143
Beneke's technique 94, 283, 283*f*
Benzidine test 372
Benzodiazepines 541
Benzyl-isoquinolone derivatives 475
Berry aneurysms 93, 217, 230
Bertillon system 70, 339
Betke-Kleihauer test 318
Beveled cuts 174
Bicuspid aortic valve 67
Bifurcation of aorta 67
Billiard ball Ricochet effect 195
Binge eating disorders 363
Biochemical
 disturbances 99
 method 487
Biological
 tests 317
 weapons 525
Bipolar mood disorder 361
Bite mark 79, 181
Bitter almond smell 515
Black
 currant-jelly 90
 gunpowder 202
 powder 188
Bladder 225
Blank cartridge 187
Blanket consent 21
Blast
 injuries 258*f*, 262
 wave 257
 wind 257
Blistering war gas 527
Blood 96, 103, 134, 143, 233, 422, 487
 CO₂ signs and symptoms 518
 donation and HIV 399
 group 77
 typing 384
 in soft tissue over mastoid 208*f*
 loss in fractures 266*t*
 pressure 486
 salicylate level 542
 stains 385
Bloodstain
 analysis 372
 pattern analysis 371
Blowback phenomenon 191
Blow-out fracture 207
Blue color of contusion 182
Blunt force injuries 168
Body
 hair 75
 marks 70
 packers 477
Boiled Lobster' appearance 432
Bone 96, 153
 and joints 226
 of foot 285
 pearl's 248
Boric acid 431
Borrowed servant doctrine 18
Boxer's fracture 231
Boyde's method 57
Bradycardia 423

- Brain 143, 147, 159, 211, 240, 258, 283, 435
 death
 certification 109
 criteria 108
 fingerprinting 400-402
 hemorrhage 229
 herniation 220
 injury 209
 mapping 400, 401
 of cartridge 202
 swelling 220
 Brainstem 94
 death 107
 certification 32
 Brawner rule 366
 Braxton Hick's
 contractions 317
 sign 323
 Breaking of rigor mortis 124
 Breasts 321, 330
 Breathalyzer 487
 Brentamine fast blue test 381
 Breslau's second life test 288, 295
 British anti-lewisite 421
 Broad chest 67
 Bronchopneumonia 110, 112
 Brooke formula 238
 Brucellosis 526
 Brush burn 166, 181
 Bruxism 363
 Buccal coitus 343
 Built of cadaver 120
 Bulbocavernosus reflex test 308
 Bulima nervosa 363
 Bulky foods 420
 Bullet 186, 186*f*, 198
 emboli 202
 wounds 197
 in skull 194*f*
 Bumper fracture 250, 256
 of tibia 251*f*
 Burden of proof 14
 Burking 154
 Burn 236, 237, 291
 and blisters 244
 injury 241
 shock 267
 Burton's
 burtonian line 443
 line 445
 Butyrophenones 539
- C**
- Cadaveric spasm 125
 Cadmium 451
 Café-coronary 152, 163
 Caisson disease 276, 278
 Calculated risk doctrine 16
 Calibre of rifled firearm 185*f*
 Calibre of shotgun 186*f*
 Calotropis 461
 Cannabis 547
 Americana 499
 Indica 499
 Mexicana 499
 Sativa 499
 Cantharides 472
 Capital
 murder 264
 punishment 37
 Capsicum annum 461
 Caput succedaneum 286, 287*f*, 294
 Carabelli's cusp 58
 Carbolic acid 430
 Carbon
 dioxide 518
 monoxide 516
 poisoning 520
 Carcinoma of vulva 112
 Cardiac
 concussion 224
 tamponade 112, 224
 Cardiogenic shock 267
 Cardiorespiratory symptoms 490
 Cardiovascular support 494
 Carnal knowledge 326
 Cartridge 187
 of rifled and shotgun weapons 186*f*
 Cases of malingering 377
 Casper's dictum 130, 137
 Catalytic color tests 371
 Cattle trucking 118
 Caucasian skull 66
 Causes of
 berry aneurysm 230
 black eyes 205, 205*f*
 death 80, 101, 109, 110, 120, 129, 141, 146, 147, 152, 157, 178, 238, 245, 259, 261, 377, 534
 and complications of criminal
 abortion 303*t*
 from wounds 265
 impotence and sterility in
 females 307
 males 306
 infant death 289
 injury 77
 late death in burn 247
 rupture of hymen 314
 SDH 214*t*
 thunderclap headache 230
 Caustic alkalis 431
 Cavett method 487
 Central
 hexagonal scales on middle of back 282*f*
 nervous system 112
 Centre of ossification 294
 Cephalhematoma 286, 287*f*, 294
 and caput succedaneum 287
 Cephalic index 47, 47*t*, 66
 Cerbera thevetia 510
 Cerebellum 94
 Cerebral
 anemia 141
 anoxia 146, 147
 concussion 209
 contusion and laceration 211
 malaria 112
 thrombosis 112
 Cerebrospinal fluid 134
 Cerebrum 93
 Cervical cellulitis 141
 Cervix 320, 321, 332
 Chalcosis oculi 448
 Changes in
 blood vessels 289
 bone marrow 134
 breasts 315
 chest 286
 eye 118, 133
 heart 289
 lungs 287
 middle ear 288
 pubic symphyseal surface 60*f*
 retina 118
 skin 286
 and facial pallor 118
 color 287*t*
 stomach and intestines 288
 umbilical cord 286
 Characteristics of
 burns 428
 injuries 244
 lacerated wound 173*f*
 rifled firearms wounds 192
 scars 64
 shotgun wounds 191
 Charcoal hemoperfusion 426
 Charred body 82
 Charting of teeth 79
 Chasing dragon 477
 Cheiloscopy 74
 Cheiloscopy 82
 Chelation therapy 539
 Chemical
 analysis 416
 antidotes 420
 asphyxiants 516
 burns 236, 243
 injuries 166
 method 57
 warfare 459, 524
 Cherry red color in postmortem staining 520
 Chest injuries 261
 Cheyne-Stokes respiration 117
 Child abuse 79, 292
 Chilotic line 55, 68
 Chloasma 316
 Chloral hydrate 97, 543
 Chlorinated hydrocarbons 529
 Chlorpyrifos 533
 Choke bore 185
 Choking of shotgun 185*f*
 Choline
 and spermine test 383
 iodide crystals 380
 Cholinesterase 473
 inhibitors 533
 reactivators 533
 Chop wounds 176
 Christmas tree stain 382

- Chromatin positivity in males and female 46t
- Chromolacryorrhea 533
- Chronic
- abuse 549
 - alcoholism 482
 - arsenic poisoning 435, 436t, 437
 - copper poisoning 447
 - cyanide poisoning 514
 - exposure 451
 - lead poisoning 442, 442f
 - mercury poisoning 439, 440
 - morphine poisoning 478
 - nephritis 112
 - phosphorus poisoning 456
 - poisoning 306, 307, 411, 445, 508, 531, 542, 553
 - starvation 280
- Circle of Willis 217f, 230
- Circulation 417
- Circulatory system 444
- Circumference of noose 141
- Circumstances of
- abrasions 167
 - death 259
- Civil and criminal negligence 13
- Classical biological test 317
- Classification of
- abortion 299
 - brain injury 208
 - burns 237f, 237t
 - craniocerebral injury 204t
 - disorders of sex 49
 - drowning 154
 - explosives 257
 - firearms 183
 - fracture 227f
 - hanging 140, 140f
 - injuries 257
 - mental and behavioral disorders 358, 359t
 - poisons 412
 - sexual offences 325t
 - snakes 464
 - stab wounds 177f
 - sterilization 309
 - thermal injuries 232
 - wounds/injuries 165
- Claustrophobia 362
- Cleavage lines of Langer 179
- Clonic contractions 505
- Close shot 193
- entry wound of bullet 193f
- Closed head injury 204
- Clostridium botulinum* 527, 557
- Closure of fontanelle 289
- CME programmes 4
- CNS infections 476
- Coarctation of aorta 67
- Cobra 467
- poison 473
- Cocaine 547
- abuse 551
 - poisoning 503
- Cocainism 502
- Cocainomania 502
- Cocainophobia 502
- Coercion technique 395
- Cognizable offence 37
- Coitus interruptus 309
- Cold
- injury 232
 - stiffening 126
 - torture 394
- Collection of
- material 380
 - samples in living 487
 - specimens 422
- Color of
- hemosiderin 182
 - PM staining 122, 414
 - skin 169, 287
 - urine in phenol poisoning 432
- Coma 110, 417
- Combined asphyxia and venous congestion 141
- Commercial preparations of alcohol 479
- Comminuted fracture 207, 226
- Common
- and expert witness 40
 - carbamates 525
 - methods used to procure criminal abortion 301f
 - salt 420
 - weapons of offence 265
- Commonest cause of female pseudohermaphroditism 67
- Commonly
- acquired infections 104
 - used in narco-analysis 402
- Commotio cordis* 224
- Communication technique 395
- Complete
- apnea 115
 - hanging 140
- Complex wave 257
- Complications of
- abdominal injuries 225
 - anesthesia 297
 - chest injuries 223
 - criminal abortion 302
 - drug abuse 549
 - rib fracture 223
 - skull fractures 208
 - latent print residue 72
 - state medical council 4
- Compound skull fracture 208
- Concealed
- puncture wounds 112
 - sex 48, 50
- Conclusive signs of pregnancy 318
- Concussion
- grading scale 210t
 - of spinal cord 222
- Condition of
- body 129
 - knife 177
- Conduct money 38, 44
- Confirmatory tests 382
- for blood 373
- Congenital
- adrenal hyperplasia 67
 - heart disease 112
- Congestion
- and PM staining 123
 - of conjunctiva 482
- Conium maculatum* 506
- Connective tissue histochemistry 270
- Constipation 443
- Constitution of IMC 3
- Consumer Protection Act 26
- Contact
- burns 236
 - flattening and pallor 118
 - of body with absorbing media 132
 - poisons 418
 - shot 192
 - tracing 398
 - wound 191, 192f, 203
- Contents of
- injury report 273
 - medical certificates 31
 - urinary bladder 134
- Continuing medical education 4
- Contraception 309
- Contre-coup
- contusion 212
 - fracture 207
 - injury 208
 - laceration 225
- Contributory negligence 17, 24
- Conversion disorder 362
- Cooling of dead body 119
- Copper
- arsenite 433
 - carbonate 446
 - subacetate 446
 - sulphate 446, 448
 - poisoning 448
- Coprophilia 348
- Coronal lacerations 225
- Coronary
- artery disease 112
 - atherosclerosis 113
- Coroner's
- and magistrate's court 37
 - inquest 34, 35
- Corporate negligence 18
- Corporobasal index 68
- Corpus delicti* 45, 66
- Corroborative signs of rape 332, 333
- Cortex of hair 82
- Cortical bone histology 62
- Corticosteroid therapy 471
- Cotard delusion 354
- Coup
- and contre-coup injury 208
 - contusion 212
 - injury 208
- Court of law 9, 23, 36
- CPA and medical services 27
- Crack lung 502
- Cranial suture closures 55
- Craniocerebral injuries 204
- Creatine phosphokinase test 383

- Creche coronary 152
 Creutzfeldt Jakob disease 104
 Cricothyroidotomy 163
 Cri-du-chat syndrome 65, 67
 Crime scene reconstruction 377
 Criminal
 abortion 62, 300, 305
 negligence 14
 procedure code 34
 Cross section of
 friction skin 70f
 hair 77f
 scalp 204f
 Crossed over electrophoresis 374
Croton tiglium 459
 Crowding of ribs shadow 285
 Crush
 asphyxia 153
 syndrome 268
 Crust of abrasion 181
 Crystal tests 373
 CSF
 otorrhea 228
 rhinorrhea 228
 sample 103
 Cullen's sign 169
 Culpable homicide 263
 Cunningham system 80
 Cuprimine 421
 Curling's ulcer 248
 Curren's rule 366
 Cushing ulcer 220
 Custodial
 deaths 396
 rape 325
 Cut
 lacerations 172
 throat injury 290
 Cuticle 74
 Cutis anserina 157, 158, 164
 Cyanide
 poisoning 116
 kit 515
 Cyanosis 111, 139
 Cylinder bore 185
- D**
- Dactylography 70
 Dactyloscopy 70
 Dangerous
 injury 265
 weapon 265
 Dating of
 incised wound 174, 175t
 laceration 173
 Davidson body 48, 49f, 66
 De Clérambault's syndrome 354, 491
 Death during administration of anesthesia 296
 Deceleration injury 204
 Deciduous teeth 80
 Declaration of
 Geneva 5
 Helsinki 5, 23
 Tokyo 5
 Decomposed bodies 99
 Decomposition of submerged body 130
 Decompression sickness 276, 278
 Decontamination 527, 539
 Deep bruise 169
 Defense
 against negligence 16
 wounds 176, 180
 Degree of suspension 145
 Delay in autopsy 352
 Delayed poisoning 429
 Delhi Artificial Insemination Act 30
 Delirium
 and dementia 358
 tremens 482, 483, 491
 Delivery of brain 93
 Delusion of
 disguise 354
 Grandeur 353
 persecution 353
 poverty 353
 reference 353
 Delusional disorder 361
 Delusions 360
 Dementia 359
 Demonstration of
 air embolus 95
 centres of ossification 285
 pneumothorax 95
 Demulcents 420
 Dental
 attrition 57
 eruption 55
 numbering 82
 profiling 79
 tissue 385
 Dentigerous cyst 66
 Dependence syndrome 359, 545
 Depressed fracture 206
 Depressive episode 361
 Deprivation technique 395
 Depth of wound 173
 De-recognition of medical qualification 4
 Dermal nitrate 200
 Dermatoglyphics 70
 Description of
 bullet wounds 197
 ligature mark 141
 manners of death 110t
 organ 94
 Desferrioxamine 421
 Detection of
 gunshot residues 200
 metals 203
 Determination of age of fetus 284t
 Determine blood loss 266
 Detoxification 480
 Development of
 genital organs 337
 PM staining 121
 Dhatura and capsicum seeds 496
 Diabetic
 coma 112
 ketoacidosis 542
 Diagnosing
 brain death 108
 case of drunkenness 485
 Diagnosis of
 fetal death 285
 poisoning in
 dead 414
 living 413
 pregnancy in
 dead 319
 living 314
 rabies on postmortem 103
 Diaphanous test 118
 Diaphragm 223, 261
 Diatom test 159
 Diazepam 528
 Dichotomy 23
 Dicing injuries 253, 255
 Diethyltoludamide 533
 Diffuse
 axonal injury 210
 injury to brain 219
 ischemic injury 219
 vascular injury 220
 Digitalis purpurea 508
 Dilatation of cutaneous blood vessels 497
 Dilated pupil 497f
 Dilation of cervix 301
 Dilute alkalis 420
 Dilution 419
 Dimension of neck 143
 Dimercaptosuccinic acid 421
 Diplopia 497
 Dipsomania 355
 Direct
 application of force 226
 violence 205
 Discharge of mentally ill person 31
 Disciplinary functions of state medical council 5
 Disclose professional secrets 11
 Dislocation of cervical vertebrae 141
 Disorders of
 adult personality and behavior 364
 motor behavior 360
 perception 360
 psychological development 364
 Disputed maternity 376
 Dissection of
 brain 93
 head in infants 94
 vessels 90
 Disseminated intravascular coagulation 269
 Dissociative disorder 362
 Distant shot 193
 Distribution of PM staining 121
 Disulfiram 483, 491
 Divorce 313
 Doctrine of
 avoidable consequence rule 17
 common knowledge 17, 24
 informed consent 19
 Documentary evidence 38

Down syndrome 65, 66
 Dowry deaths 34, 264
 Dribbling of saliva 142
 Drowning 117, 290
 Drowsiness 497
 Drug
 dependence 545
 facilitated rape 326
 intoxication 109
 Drumstick appearance 49f
 Drunken gait 497
 Dry
 atmosphere 132
 drowning 155, 163
 heat 243
 hot skin 497
 submarine 396
 Dryness of mouth 497
 Duces tecum 44
 Dum-dum bullet 186
 Duplex bullet 186
 Duration of
 exposure 237
 injuries 274
 Duret hemorrhages 220, 230
 Durham's rule 366
 Dying
 declaration 39, 44
 and dying deposition 41
 deposition 39, 44
 Dysarthria 497
 Dysbarism 276
 Dyskeratosis congenita 70
 Dysphagia 497
 Dystonic reactions 540

E

Eating disorders 363
 Ecchymoses 266
 Echopraxia 356
 Edema
 aquosum 158
 of glottis/lungs 112
 Eggshell skull rule 17
 Elastic tissue 270
 Electric
 and lightning burns 236
 baton shock 394
 current 302
 Electrical
 excitability of skeletal muscles 107
 injuries 243
 stimulation 162
 Electronography 73
 Electrophoretic methods 374
 Elevated fracture 206
 Elongated X-shaped incision on back 396f
 Embalming artifacts 351
 Emergency tracheostomy 163
 Emetics 419
 Empathy 356
 Emphysema aquosum 158
 Employees' State Insurance Act, 1948 33

En
 bloc removal 87
 masse 87
 Endocrinal disturbances 99
 Endocrine 112
 Endotoxins 554
 Energy dispersive X-ray 200
 Enhancement of excretion 536
 Enlargement of abdomen 316
 Enlisting injuries 259
 Enterotoxin 555
 Entomology 130
 Environmental
 artifacts 351
 temperature 120, 124, 129, 131
 Enzyme
 histochemistry 114
 markers 377
 typing 384
 Ephebophilia 347
 Epidural hematoma 213, 240
 Epileptiform convulsions 141
 Epiphyseal unions 55
 Erasure of tattoo 65
 Erectile dysfunction 306, 312
 Erotomania 354
 Eruption of
 deciduous teeth 54t, 57, 57f
 permanent teeth 57t
 Esophagus 415
 Esterases 271
 Estimation of
 radioactive carbon 101
 time since death 132
 Ethical issue 393
 Ethmoid and sphenoid sinuses 159
 Ethylene
 diamine tetra acetic acid 421
 glycol 490
 toxicity 542
 Euthanasia 10, 22
 Evaluation of head injury case 220
 Evisceration methods 87
 Examination of
 active agent of sodomy 342
 brain 93
 coronary arteries 90, 90f
 dead body 304
 female 308
 heart 90
 living individual 303
 male 308
 myocardium 91f
 organs 105
 passive agent of sodomy 340
 person in alleged case of impotence
 and sterility 307
 rape
 accused 337
 victim 328
 seminal stains 380
 valve 92
 woman with alleged history of
 abortion 303

Example of
 disorder of sex chromosomes 66
 medical negligence 14
 Exclusion of
 injuries and pathological conditions
 485
 paternity 376
 Exhausting diseases 111
 Exhumation 101, 103
 artifacts 352
 Exit
 marks 244
 wounds 194
 Exogenous androgen 67
 Expert witness 40
 Explosive bullets 187
 Exposure of
 skin 446
 unethical conduct 6
 Extensive abrasions 256
 External
 ballistics 183
 ballottement 317, 323
 blood loss 266
 features of snake bite 471f
 genitalia 86
 hemorrhage 266
 injuries 255, 259
 injury on body 129
 signs of decomposition 127
 Extracorporeal removal 422
 Extradural
 hematoma 213
 hemorrhage 229
 Extragenital injury 330
 Extravasation of blood 351

F

Fabricated
 abortion 302
 wounds 180
 Face of clock orientation with patient in
 lithotomy position 333f
 Facial
 hair growth 135
 pallor 444
 Factors
 affecting
 algor mortis 120
 putrefaction 129
 rigor mortis 124
 favoring mummification 132
 influencing
 adipocere formation 131
 bruise 169
 decomposition in water 130
 fatality 280
 floatation 130
 modifying action of poisons 413
 Faculty development programmes 4
 Failure of taking food 279
 False
 allegations 336
 negative hydrostatic test 295

- statement regarding red cross sign 23
strangulation groove 147
- Fatal
concentration 518
dose and
blood level 493
fatal period 517, 519
period 141, 157, 280, 482
- Fate of
body 131
PM staining 121
- Fatigue 316
- Fatty
liver 457
yellow liver 437
- Feather test 117
- Features of
brain swelling 221f
common poisonous snakes 464
dead-born fetus 285
female pelvis 67, 68
lightning 246
ruptured skin 248
- Fecal matter 385
- Federation Dentaire Internationale 80
- Feet-first impact 260f
- Feigned insanity 356
- Female
genital organs 226
genitalia 89
pseudohermaphroditism 50, 67
rabbit test 317
toad test 317
- Fentanyl 478
- Fetal
heart 323
sounds 318
movements and parts 318
- Feticide 282
- Fetomaternal transfusion of fetal RBCs 323
- Fetus compressus 319
- Fibrin 270
- Fibroblasts 270
for tissue culture 96
- Filicide 282
- Filigree burn 246, 248
- Fingernails 86
- Fingerprint 70, 199
bureau 82
classification 73
development 72
patterns 70
powders 72
- Firearm 183, 265
injury 78
wound 165, 190
on skull 194
- Firection of force inabrasion 166f
- Fired bullets 198
- Fireman's cramps 234
- First
degree burns 236
pubertal sign 69
- symptom of pregnancy 323
trimester abortion 33, 305
- Fixation of
brain 93
PM staining 121
- Flaccidity of muscles 118
- Flame burns 236
- Flash burns 236, 245
- Florence test 380, 381, 385
- Flow-cytometry 135
- Fluid
and electrolyte management 542
resuscitation 238, 539
- Fluorescence in situ hybridization 383
- Fluorescent Feulgen reaction 48
- Fluoride 103
- Flying missiles 259
- Foamy liver 137
- Fodere's test 287
- Food
allergy 557
borne disease 554
poisoning 412, 554
- Footprints 74
- Forcefeeding 394
- Foreign body insertion 314
- Forensic
anthropology 99
ballistics 183
entomology 130
medicine 3
odontology 78
pathology 83
psychiatry 353
science 3
serology 371
toxicology 411
- Formaldehyde 97
- Formation of tram-line contusion 170f
- Formic acid 97
- Fossa navicularis 332
- Fouling 190
- Four carpal bones 69
- Fracture
blood loss 266
contusion 212
mandible 231
of anterior cranial fossa 207
of extremities 226
of hyoid bone 163, 351
of middle cranial fossa 207
of posterior cranial fossa 207
of skull 254
of transverse processes 222
of vertebral bodies 222
- Frangible bullet 187
- Fraternal twins 319
- Free air movement 132
- Fregoli's phenomenon 354
- Freidman test 317
- Friction burn 166
- Front
impact crash 252
seat passenger 253
- Frostbite 233
of fingers 234f
- Frotteurism 347
- Fulminant
hepatic failure 112
poisoning 411
- Functions of
MCI 4
SMC 5
- G**
- Gallbladder 281
- Galli-Mainini test 317
- Galton
exchange 339
system 70
- Gamete intrafallopian transfer 312
- Gang rape 325
- Gardona 533
- Gas stiffening 126
- Gastric
decontamination 418
lavage 418, 418f, 527
- Gastrointestinal system 112
- Gel electrophoresis 386f
- Genetic markers in blood 375
- Geneva convention 6
- Genital injury 330, 331
- Genitourinary system 112, 291
- Geographical distribution 293
- Gerontophilia 347
- Gestational sac 323
- Gettler's test 159, 164
- Giemsa stain 382
- Glaister-Keen globes 332
- Gliding contusion 212
- Glucose estimation 208
- Glycosides 508
- GM and KM systems 376
- Gonadal
agenesis 48, 49
biopsy 48
dysgenesis 48, 49, 67
- Gonadarche 69
- Goodell's sign 316, 323
- Gordon's clarification of death signifies 116
- Grading of
black powder 188
diffuse axonal injury 211f
- Gravity shifting of blood 169
- Graze
abrasion 166
abrasions mimics 181
- Greater sciatic notch 55f
- Green
color of contusion 182
stick fracture 226, 231
- Grey Turner's sign 169
- Grievous hurt 80
- Grinding compression 172
- Growing skull fracture 208
- Guillain Barre syndrome 474
- Gunpowders 188, 203

- Gunshot
 residues 200
 wounds 168
 Gustafson's
 criteria 56*t*
 method 57, 68
 Gustatory hallucination 354
 Gutter fracture 207
- H**
- Habitual passive agent 341
 Haderup system 80
 Hair 74, 96, 385, 444
 and nail clippings 423
 bulbs 173
 Hallucination 354
 Hallucinogens 548
 Handling sharp instruments 105
 Hanging 162
 Hangman's fracture 145, 145*f*, 163
 Haptic hallucination 354
 Hard blunt 265
 Harrison and Gilroy test 200
 Hasse rule 339
 Hatter's shakes 440
 Head
 injuries 260, 289, 290
 scales of poisonous and non-poisonous snakes 465*f*
 Healing of
 fracture 227
 lacerated wound 173*t*
 Health
 care workers and HIV infection 397
 hair bulb 77*f*
 Hearsay evidence 40
 Heart 90, 153, 223, 233, 240, 415, 435
 and blood vessels 159
 disease 111
 Heat
 cramps 234
 exhaustion 234
 hematoma 240
 hyperpyrexia 234
 injury 234
 prostration 235
 rupture 239
 and lacerated wound 240
 stiffening 125
 stroke 234
 syncope and heat stroke 235*f*
 Heavy weapons 265
 Hebephilia 347
 Hegar's sign 316, 323
 Heimlich maneuver 163
 Hematoma 213
 and depressed skull fracture 205
 Hematoxylin-eosin autofluorescence 114
 Hemin crystal test 373
 Hemiplegia 141
 Hemochromogen crystal test 373
 Hemodialysis 426, 543
 Hemolysis 163
 Hemorrhage 111, 112, 173, 174, 208, 213
 Hemostatic disturbances 471
 Hepatitis B 104
 Hepatotoxic poisons 415
 Hermaphrodites 48
 Herniation contusion 212
 Herpes and human T-cell lymphotropic virus 104
 Hesitation cuts 182
 Hide and Die' syndrome 233
 High
 anion gap acidosis 448
 environmental temperature 120
 order explosives 257
 tension injuries 244
 Highly probable evidence of sex 47
 Hindu Marriage Act 66
 Hippocratic oath 5
 Histotoxic anoxia 112
 HIV
 infection 104
 testing 397
 policy 397
 Hoarseness of voice 69
 Holiday heart syndrome 491
 Hollow point bullet 186
 Homicidal 281
 burns 242
 drowning 161
 impulse 355
 laceration 173
 strangulation 147
 throttling 150
 wounds 176
 Homicide 144, 179, 263
 Homosexuality 343
 Hoppe-Seyler's test 517
 Hostile witness 40, 44
 Human
 and animal hair 76
 bites 167, 173
 DNA quantitation 377
 immunodeficiency virus 104
 RBCs 373
 rights 10
 Humidified oxygen 163
 Humidity 120
 Hurt 264
 Hydrochloric acid 427
 Hydrocution 163
 Hydrogen
 borate 431
 sulphide 518
 Hydrostatic
 lungs 159
 test 287
 Hymen 313, 331
 Hymeneal examination 332
 Hyoid bone fracture 150, 151
 Hyoscyamus niger 498
 Hyperdynamic septic shock 267
 Hyperemic stage 233
 Hyperflexion of spine 285
 Hypergonadotropic hypogonadism 50
 Hyperkalemia 163
 Hypersensitivity of respiratory tract 293
 Hypersomnia 363
 Hypertension 110, 417
 Hypertensive
 heart disease 112
 intracranial hemorrhage 230
 Hyperthermia 417
 Hyperventilation deaths 161
 Hypochondriacal delusion 353
 Hypomania 361
 Hypotension 417
 and shock 471
 Hypothermia 109, 232, 417
 Hypovolemia 163
 Hypovolemic
 hypodynamic septic shock 267
 shock 266
 Hypoxic encephalopathy 141
 Hysterotomy 28
- I**
- Identical twins 319
 Identification of
 biological samples and body fluids 384
 dead 259
 human remains 78
 seeds 458-460, 504
 victim or offenders 377
 Idiopathic epilepsy 112
 Illegal abortion 305
 Illicit liquor 489
 Immediate sign of death 136
 Immersion
 burns 242
 foot 233
 syndrome 156, 233
 Immunoassays
 with radioisotopes 318
 without radioisotopes 317
 Immunoelectrophoretic identification 208
 Immunological tests 317
 Immuno-radiometric assay 318
 Important alkaloids 475
 Impression of bite mark 79
 In situ dissection 87
 Incendiary
 bombs 257
 bullets 187
 Incidence of Turner syndrome 67
 Incised
 looking lacerated wounds 172
 wound 165, 174*f*, 182, 204
 Incision for
 opening thoracic and abdominal cavities 86*f*
 removal of scalp 93*f*
 Incremental line in enamel of teeth 289
 Indecent assault 348
 Indian
 Evidence Act 34
 Medical Council Act 3
 Medical Degrees Act 3
 Penal Code 34
 Indications for termination of pregnancy 28

- Indirect
 agglutination inhibition test 317
 fractures 226
 violence 205
- Individualization of seminal stains 384
- Induced abortion 300
- Infant death 289
- Infanticide 282
- Infantophilia 347
- Infarction of brain 141
- Infections 141, 208
- Infertility 306
- Ingested poisons 418
- Ingestion of inorganic mercuric salts 438
- Inhaled poisons 418
- Inheritance claims 320, 376
- Inhibitors of cytochrome oxidase 515
- Inhibitory neurotransmitter in spinal cord 506
- Injectable steroids 309
- Injected poisons 418
- Injuries 255, 291
- Insomnia 363
- Insulin 543
- Intention tremors 439
- Intermediary
 coup contusion 212
 syndrome 529
- Internal
 ballistics 183
 hemorrhage 266
 injuries 255
- Interpretation of rigor mortis 124f
- Intersex 48
- Interventricular septum 90
- Intestines 88, 233
- Intracerebral
 hematoma 218
 hemorrhage 110, 112
- Intracranial
 hematoma 212, 213
 hemorrhage 476
- Intracytoplasmic sperm injection 312
- Intradermal bruise 168
- Intragluteal coitus 343
- Intra-marital rape 336
- Intrauterine
 devices 309
 instillation of hyperosmotic solution 28
- Intraventricular hemorrhage 219
- Introitus 321
- Investigation of scene 260
- In-vitro fertilization 312
- Involuntary euthanasia 23, 24
- Involuntary melancholia 361
- Inward compression fractures 150
- Iodine fuming 72
- Ionizing radiation
 burns 236
 reactions 276
- Irreversible
 cessation of
 circulation 117
- function of brain 117
 respiration 117
- Irritant torture 394
- Ischemic anoxia 112
- I-shaped incision 87
- Isoenzyme methods 375
- Isograft 109
- Isopropyl alcohol 490
- J**
- Jacketed bullets 186
- Jacquemier's or Chadwick's sign 316
- Joule burn 244f, 248
- Judicial
 electrocution 246
 execution 514
 hanging 145
- Jurisprudence and forensic medicine 1
- Juvenile Justice Act 37
- K**
- Kallmann syndrome 66, 67
- Karyorrhesis 443
- Karyotype of Turner syndrome 67
- Katayama's test 517
- Kennedy phenomenon 196
- Kerosene 97
- Kevorkian sign 118
- Kidneys 88, 225, 233, 241, 415, 430, 444
- Kimura's base-wing index 55
- Kleptomania 354
- Klinefelter
 and Turner syndrome 48f
 syndrome 49, 66, 67
- Klismaphilia 348
- Knee-elbow position 341, 341f
- Korsakoff's psychosis 482, 484, 491
- Kozelka and Hine method 487
- Krait 468
 bite 474
 poison 473
- Krogman's formula 67
- Krönlein shot 196
- Kunkel's test 517
- L**
- Labia 331
 majora 313, 320
 minora 313
- Lacerated wound 165, 172
- Lacerations 204, 225
- Lactate dehydrogenase isoenzyme 383
- Lactic acidosis 542
- Lanugo hair 283
- Laryngeal spasm 152, 157
- Latex test 374
- Lathyrus sativus 555
- Lawful homicide 263
- Le Fort's fracture 231
- Lead
 encephalopathy 443
 osteopathy 444
 palsy 443
 snowstorm 202
- Leathery stomach 432
- Left mastoid process 86f
- Legitimacy 319
 and paternity 319
- Legitimate child 320
- Lendrum's stain 302
- Letulle's technique 283
- Leucomalachite green 372
- Lewis system 375
- Ligature
 description 141
 mark 143, 146
 strangulation 145, 146
 test 118
- Light weapons 265
- Lightning stroke 246
- Lilliputian hallucination 354
- Limitations of
 DNA testing 391
 manual recording 71
 rape laws 326
- Linear
 abrasion 166
 fractures 205
- Lip prints 74
- Litchenberg flowers 246
- Lithotomy position for genital examination 331f
- Liver 88, 225, 241, 261, 415, 486
- L-line-X-ray fluorescence 445
- Locard's principle of exchange 71
- Lochia 320
 alba 320
 rubra 320
 serosa 320
- Loco parentis 20
- Longitudinal section of human hair 75f
- Long-scarf syndrome 147
- Loss of
 corneal and pupillary reflexes 118
 intraocular tension 118
- Lower end of femur and upper end of tibia 285
- Low-order explosives 257
- Low-tension injuries 244
- Lucid interval in insanity and head injury 357
- Lugol's iodine test 337
- Lust murder 345
- Lymphedema 67
- Lynching 144
- Lysergic acid diethylamide 548
- M**
- Maceration 285
- Madea's formula 134
- Magic bullet 196
- Magnan's syndrome 503
- Magnus
 hirschfeld 346
 test 118
- Maintaining standard medical service 14
- Maintenance of
 Indian medical register 4
 medical records 5, 6

- patient's general condition 422
 register 29
 Major types of abuse 292
 Male
 and female
 mandible 53, 53f
 pelvis 53, 53f
 sacrum 55
 skull 50, 53f
 frog test 317
 genital organs 226
 pseudohermaphroditism 50, 67
 urethra 226
 Malignant hyperthermia 297, 540
 Malingering 21, 22
 Maltreatment syndrome 290
 Management of
 ALP poisoning 535
 kerosene oil poisoning 553
 OPC poisoning 527
 poisoning cases 417
 property 364
 snake bite poisoning 469
 specific condition 540
 Mandibles of infancy 60
 Mania 361
 Manic episode 361
 Manner of
 burial 129
 death 109, 110
 Manual strangulation 145
 Marbling' of skin 128
 of lower limbs 128f
 Marchiafava-Bignami syndrome 482, 484
 Marfan's syndrome 65, 66
 Margins 172, 174
 Marks of injury 337
 Marquis test 476, 478
 Martius scarlet blue stain 269
 Masque ecchymotique 153
 Mass disaster 99
 Massive hemoptysis 112
 Masturbation 314, 347
 Matted pubic hair 380
 Maximum and minimum period of
 gestation 319
 McNaughten rule 365
 Mechanical excitability of skeletal muscle
 107
 Mechanism of
 action of abortion stick 305
 asphyxial deaths of common 139
 brain death 108
 criminal abortion 305
 death in
 fresh water drowning 155
 sea water drowning 156
 defence wounds 180f
 discharge of projectile 189
 formation 131
 Masque ecchymotique 154
 Meconium 283, 288
 Medical
 Council of India 3
 defense procedure 16
 etiquette 3, 23
 indemnity insurance 16, 27
 jurisprudence 3
 maloccurrence 17
 malpractice 9
 practitioner and torture 395
 Termination of Pregnancy Act 28
 Medico-legal
 application 73, 77, 80
 of blood 376
 aspects of
 blood groups 376
 definition of rape 327
 poisons 411
 pregnancy and delivery 321
 autopsies 84
 importance of
 age 62
 algor mortis 120
 placenta 302
 PM staining 122
 putrefaction 130
 rigor mortis 125
 Medullary index 75
 Mees's lines 437
 Menarche 69
 Meningeal hemorrhages 170
 Meningitis 112
 Mental
 disorder and responsibility 364
 Health Act 31
 retardation 67, 363
 status examination 357
 Mentally ill person 353
 Mercurial erethism 440
Mercuria lentis 440
 Mercuric
 chloride 438
 cyanide 438
 sulphide 438
 Mercurous chloride 438
 Mercury poisoning 440
 Mercy killing 22
 Metabolic acidosis 489
 Metal fume fever 453
 Methanol toxicity 542
 Methemoglobinemia inducing agents 453
 Methods for
 contraception 309
 inducing
 abortion under MTP 28t
 criminal abortion 300
 measurement of core temperature 119
 Methyl alcohol 488
 Methylene-dioxy-methamphetamine 549
 Microwave burns 236
 Middle
 ear 159
 meningeal artery 229
 Minamata
 bay disease 440
 disease 440
 Mineral acids 427
 Mineralization of teeth 68
 Miner's scramps 234
 Mirror test 117
 Miscellaneous methods of identification
 80
 Mishandling of body 352
 Mismatched blood transfusion 112
 Missile injury 204
 Mode of
 administration 413
 death 110, 120, 124
 starvation 279
 Modified
 FDI system 80
 Greiss test 200
 Y-shaped incision 87, 142f
 Moist heat 243
 Molecular death 107, 115, 118
 Molotov cocktail 257, 262
 Mongolian spots 46
 Monk's hood 507
 Monoclonal antibody mouse antihuman
 semen 383
 Mood disorders 361
 Morning sickness 315
 Morphine poisoning 503
 Morphological appearance of spermato-
 zoon 382f
 Mosaic fracture 207
 Most
 certain evidence of sex 47
 common
 cardiac anomaly in Turner
 syndrome 67
 cause of congenital adrenal
 hyperplasia 67
 Motile sperms 334
 Motility of sperms 383
 Motor
 cyclists fracture 256
 vehicle
 Act 486
 collision 249
 MTP Act rules 28
 Mucopolysaccharides 270
 Muir and Barclay formula 238, 247
 Mullerian agenesis 67
 Multiple brain petechiae 220
 Mummification 132, 133, 285
 Munchausen syndrome 293, 295
 Muscle 233
 coordination 485
 paralysis 474
 Muscular activity 124
 Mushrooms 556
 Mutilated bodies 99
 Mutilomania 355
 Muzzle
 blast 189
 flash 189
 imprint 192f
 Myocardial infarction 112f
 Myocarditis 112
 Myxedemic coma 112

N

N-acetyl-cysteine 544
 Nail print 81

- Naltrexone 551
 Naphthalene 531
 Narco-analysis 401
 Narcolepsy 363
 Narcotic 475
 Drugs and Psychotropic Substances Act 411
 Nasal
 edema and mucus secretion 293
 swabs 503
 National AIDS Control Organization Guidelines 397
 Natural
 abortion 299
 and criminal abortion 302
 diseases 99, 169, 268
 fibres 74
 offences 325
 orifices 86
 sexual offences 325
 Nature of
 assault 78
 bite marks 79
 each injury 273
 injuries 166
 knot 141
 weapon 78
 Neck injuries 261
 Necklacing 242
 Necrosis 242
 Needle phobia 362
 Negative autopsy 99
 Neglect of injured person 268
 Negligence suits 9
 Neologisms 360
 Neoplasm 112
 Nephrolithiasis 112
 Nephrotoxic poisons 415
 Nerium odorum 509
 Nerve gases 525, 527
 Nervous apoplexy 115
 Neurasthenia 356
 Neurogenic
 cardiovascular failure 296
 shock 267
 Neurosis and psychosis 355
 Neurotic
 and somatoform disorders 361
 disorders 362
 Neurotoxic and vasculotoxic venom 467
 Neutron activation analysis 200
 Nickolls method 487
Nicotiana tabacum 508
 Nicotine 549
 Nihilistic delusion 353
 Ninhydrin 72
 Nitric acid 427
 Nomenclature 464
 Nomogram method 120
 Non-bailable offences 37
 Non-cellular semen markers 383
 Non-CNS effects 540
 Non-cognizable offence 37
 Non-habitual passive victim 341
 Non-poisonous snakes 464, 466f, 471f
 Non-porous surfaces 72
 Non-serum protein analysis 375
 Non-traumatic primary IVH 219
 Non-voluntary euthanasia 22
 Noonan syndrome 66,67
 Normal
 female
 anatomy 313
 genitalia 313
 pupil 476f, 497f
 skull of newborn 61f
 Nostril hair 75
 Novus actus interveniens 17
 Nuclear
 sexing 47
 terrorism 277, 278
 Nulliparous and parous uterus 320
 Nullity of marriage 310
 and divorce 320, 322
 Number of
 dead persons 259
 ossification centres 68
 teeth 68
 Nysten's law 124
- O**
- Observation period 109
 Obsessive-compulsive disorder 362
 Obturator foramen 55f
 Occupational marks 80
 Ochronosis 430, 432
 Olfactory hallucination 354
 Oliguria and renal failure 471
 Oniomania 355
 Opacity of cornea 118
 Open head injury 204
 Opening of heart at autopsy 90f
 Ophitoxemia 467
 Opiate 475
 Opioids 475, 547
 Opisthotonus 505f
 Opium 475
 poisoning 478
 Optic atrophy 444
 Oral contraceptive pills 309
 Orbital blow out fracture 228
 Order of appearance 124
 Organic
 amnesic syndrome 359
 mental disorders 358
 Organophosphate-induced delayed neurotoxicity 529
 Organophosphorus
 compounds 525
 insecticides 533
 poisoning 503
 Orthoboric acid 431
 Osiander's sign 317, 323
 Osmium tetroxide 73
 Ossification
 centre of upper end of ulna 69
 of carpal bones 58f
 Osteometric board 65f
 Othello syndrome 353
 O-toluidine test 372
 Ouchterlony method 374
 Ovarian dysgenesis 66, 67
 Ovaries 89
 Ovum donation 312
 Oxalic acid 429
 Oxytocin infusion 28
- P**
- Pack rape 325
 Palato-print 82
 Palmer's
 notation 80
 sign 316
 Paltauf's hemorrhage 158, 164
 Pancreas 88, 225, 233
 Panic disorder 362
 Papanicolaou staining 382
 Paracetamol 538
 Paradox guns 185
 Paradoxical undressing 233, 247
 Paraffin test 200
 Paraldehyde 97
 Paralysants 525
 Paranoia 356
 Paranoid schizophrenia 551
 Paraphilia 345
 Parasomnias dysfunctions 363
 Parasuicide 356
 Parkland formula 238, 247
 Parotitis 141
 Partner notification 398
 Parts of
 body 146
 hair 75f
 rifled
 cartridge 188f
 weapon 185f
 shotgun cartridge 188f
 single-edged knife 178f
 tooth 54f
 Passage of electricity 244
 Passengers of rear seat 253
 Passive
 algolagnia 345
 defense injuries 180
 euthanasia 22, 24
 Patau syndrome 65
 Pathological state of blood 111
 Pathophysiology of asphyxia 138
 Patterned
 abrasion 181
 bruise 169f
 seat belt abrasion 255
 Patterns of drug use disorders 545
 Pavor nocturnus 363
 Payment of professional services 6
 Pearson's formula 69
 Peculiar effects of firearms 195
 Pedal cycle 254
 Pedestrian injuries 249
 Pedophilia 347
 Pelvic fractures 227
 Pelvis 88
 Penetrating wound 177, 190
 Penicillamine 421

- Penis enlargement 69
 Per cutaneous vas occlusion 310
 Percussion cap 187
 Perforating wound 177, 190
 Performillegal abortion/operation 11
 Pericarditis 112
 Perineum 313, 320, 321
 Period of
 mixed dentition 57, 68
 suspension 145
 Periodic
 acid-Schiff stain 114
 paralysis 474
 Peripheral
 nerve 444
 poisons 506
 neuropathy 448
 zone 269
 Permanent
 disfigurement of head or face 264
 impairment of powers 264
 privation of
 hearing of either ear 264
 sight of either eye 264
 sterilization 312
 teeth 56, 68, 80
 Persistent
 mood disorder 361
 vegetative state 111
 Petechiae 266
 Petechial hemorrhages 111
 Petroleum products 412
 Phantom pregnancy 319
 Pharmacological
 excitability 107
 torture 395
 Phenanthrene derivatives 475
 Phenolphthalein test 372
 Phenomenon of suspended animation 136
 Phenothiazines 539
 Phloxine-tartrazine 302
 Phobic disorder 362
 Phosphorus 97, 455
 Phosphorylated enzyme 533
 Phossy jaw 456, 457
 Phytotoxin 458
 Piggyback bullet 186
 Pigmentation of skin 315
 Pink
 disease 440
 teeth 129
 Pinpoint pupil 476f, 478
 Piskacek's sign 317
 Place of disposable of body 132
 Placenta 282
 Plague 526
 Plasma magnesium 159
 Plastic bag asphyxia 151
 Pleura 240
 Ploucquet's test 287
 Plumbism 445
 PM staining 133
 and bruise 171, 122
 Pneumothorax 112
 P-nitrophenol test 527
 Poikilocytosis 443
 Pointed weapons 265
 Poison 411
 Poisoned bullets 187
 Poisonous
 and non-poisonous snakes 464
 foods 555
 snake 464, 465t, 471f, 473
 Police inquest 34, 35, 43
 Poliomyelitis 474
 Polychlorinated hydrocarbon 533
 Polygraph test 400f
 Polyvalent snake vaccines 474
 Pond's fractures 206, 228
 Poroscopy 73
 Porous surfaces 72
 Position of
 knot 140f, 145
 submerged dead body 157
 Positive signs of pregnancy 318
 Post-concussion syndrome 210
 Posterior commissure 332
 Posthumous births 320
 Post-hyperemic stage 233
 Postmortem
 abrasions 167
 caloricity 120, 136
 corrosion 351
 examination 111, 1115, 146, 148, 238, 414
 of infants 282
 findings 153, 232, 280, 459, 471, 543
 in hanging 142
 in strangulation 146f
 fracture 228
 glycogenolysis 120
 hanging 144
 imbibition of arsenic 436
 lividity 136, 157
 luminescence 128
 maceration 351
 root banding 77
 samples 488
 staining 120, 136, 239, 349
 suspension 144
 thrombus 90
 Postpartum psychiatric disorders 363
 Post-traumatic
 automatism 210
 intracerebral hemorrhage 219
 Potassium
 ferrocyanide test 517
 permanganate 420
 Powers of magistrate 36t
 Pralidoxime 528
 Precipitate labor 289
 Precipitin methods 374
 Pre-hyperemic stage 233
 Prenatal Diagnostic Techniques Act 29
 Preparations of cannabis 499, 499t
 Preservation
 and marking of exhibits 197
 of dead bodies 135
 of viscera 96
 Pressure
 abrasion 166
 immobilization 469
 technique 469, 470f
 test 118
 ulcers 167
 Presumption of death 135
 Presumptive tests for blood 371
 Preventing medical litigation 14
 Prevention of spread of venom 469
 Prickly poppy 556
 Primary
 and secondary relaxation of muscles 127
 brain injury 209
 hemorrhage 266
 impact injury 229, 250, 256
 ossification centres 68
 relaxation 118
 traumatic IVH 219
 Principle of diatom test 160
 Prinsloo Gordon artifact 349
 Privileged communication 8
 Probable signs of pregnancy 316
 Procedure of
 DNA profiling 387f
 examination of mentally ill person 366
 preservation 98
 Procurator fiscal 34, 36
 Professional
 death sentence 23
 misconduct 10
 negligence 13
 Prohibition of participation in torture 23
 Prolonged
 fainting attack 117
 labor 289
 sleep apnea 293
 Prominent
 bruise 181
 eyeballs 142
 Proof of spirit 479
 Proper counseling and informed consent 14
 Properties of
 aconitine 507
 nicotine 508
 strychnine 504
 Prostaglandins 28
 Prostate 89, 129
 specific antigen 383
 Protein markers 377
 Protrusion of tongue 142
 Proximate causes of death 110
 Pseudocyesis 319
 Pseudohermaphroditism 48, 50
 Psychiatric assessment 357
 Psychoactive
 drug 545
 substance 546
 use disorders 359
 Psychogenic shock 267
 Psychologic symptoms 330, 336

- Psychological
 autopsy 83
 torture 394
 Psychomotor hallucination 354
 Psycho-social examination 307
 Psychotic disorders 361
 Pterygia 61
 Pubarche 69
 Pubic
 hair 75, 331, 337
 development 69
 symphyseal morphology 55
 symphysis 61*t*
 Pulmonary
 edema 423
 embolism 112, 268
 Punch drunk syndrome 210
 Punctate basophilia 445
 Punctured wound 176
 Punishment for sexual intercourse 339
 Puppe's rule 194
 Purpose of seminal identification 380
 Putrefaction 133, 349
 of body 137
 Pyrethrins and pyrethroids 532
 Pyrogallol test 95
 Pyromania 355
- Q**
- Qualification and experience of RMP 28
 Quality of water 130
 Quaternary injuries 258
 Quinacrine dihydrochloride 48
 Quinine 510
- R**
- Radiant heat burns 236
 Radiation sickness 277
 Radioactive sulfur dioxide 73
 Radiocarbon
 analysis of tooth enamel 58
 dating of tooth enamel 57
 Radioimmunoassay 318, 544
 Railway
 accident 163
 injuries 255
 Raindrop pigmentation 437
 Rape 325
 kit 335
 on children 334
 on deflorate 334
 trauma syndrome 336
 Rapid rat test 317
 Rayalaseema phenomenon 196
 Reactionary hemorrhage 266
 Rear impact crash 253
 Reasons for
 euthanasia 22, 23
 negative autopsy 99
 obtaining consent 20
 torture 393
 Recognition of
 injuries 132
 medical qualification granted 4
- Recording of
 evidence 41
 fingerprints 71
 Rectified spirit 103
 Recurrent depressive disorder 361
 Red
 cross emblem 12
 velvety stomach mucosa 437
 Redressal agencies 26
 Reduction of toxicity 536
 Reflection of cranial bones along suture
 lines 283*f*
 Reflex
 cardiac arrest 115
 vagal inhibition 141
 Regulation of prenatal diagnostic techniques
 30
 Reinsch test 437
 Removal of
 human organs 25
 unabsorbed poison 418
 Renal
 excretion 422
 failure 542
 Reproductive
 organs 226
 system 112, 44
 Respiration 486
 Respiratory
 centre depression 506
 failure 296
 infection 293
 system 112, 415
 Restraint of insane 31
 Retinal stippling 444
 Retraction balls 229
 Retrograde amnesia 210
 Retroperitoneal organs 261
 Retropharyngeal abscess 141
 Reye's syndrome 542
 Rhabdomyolysis 448
 Rhesus system 376
 Rhythm period 309
 Ricin toxin 527
Ricinus communis 458
 Ricochet bullet 195
 Rifled
 firearms 183, 195, 199
 weapons 183
 Right
 and privileges of registered medical
 practitioners 11
 atrium 90
 mastoid process 86*f*
 of sperm donors 311
 Rigor mortis 123, 123*f*, 124, 133, 137,
 158, 285, 349
 and cadaveric spasm 126
 and cold stiffening 127
 and heat stiffening 126
 Rimmed cartridge 187
 Ring
 fracture 207
 precipitin test 374, 375*f*
 sign 208
- Road traffic accident 163
 Robert's sign 285
 Rokitansky's method 94
 Role of forensic psychiatrist 356
 Roof of orbit 228
 Root of naturally fallen hair 77*f*
 Rubber
 bullets 187
 bush 461
 Rule of
 consent 20
 hasse 285, 294
 Rumack-Matthew nomogram 538
 Running water 131
 Rupture of
 abdominal aneurysm 112
 ectopic pregnancy 112
 Ruptured
 diseased viscus 112
 liver abscess 112
 Rupturing of membranes 301
- S**
- Sacrum 55*f*, 61
 Salinity of water 130
 Saliva 384
 Salivary stains 385
Salmonella 527
enteritis 557
typhimurium 557
 Salt water drowning 163
 Sample
 of spinal cord 103
 preserved for toxicological analysis
 422
 Sanitary tampons 314
 Saponification 131, 133
 Satyriasis 343
 Saw-line for removal of skull cap 93*f*
 Scalds 236, 242
 Scalp hair 75
 Scandinavian method 494
 Scars 64
 Scatologia 348
 Scene of crime 196
 Schizophrenia 359
 Sceptophilia 346
 Scorpions 472
 Screening tests 380, 423
 Sea snake 468
 Second degree burns 236
 Secondary
 brain injury 209, 229
 hemorrhage 266
 impact injuries 251
 markings or individual/accidental
 charac 199
 relaxation of muscles 126
 sexual characters 61
 Self-inflicted
 bite 79
 burns 242
 wounds 180
Semecarpus anacardium 460

- Seminal
 fluid 333
 stains 385
- Semi-smokeless powder 188
- Semisomnolence 363
- Sepsis 238
- Septic
 abortion 302
 shock 267
- Sequelae of
 burns 238
 torture 395
- Sequence of putrefaction 137
- Severity of
 brain injury stratification 211f
 concussion 210
 injury 166
- Sewer gas 520
- Sex
 chromatin 47
 determination 58
 tests 11
 linked offences 325
- Sexual
 asphyxia 162, 164, 348
 assault 79, 384
 battery 326
 contact 384
 intercourse 314, 339
 perversions 325, 345
 torture 395
- Sexually transmitted diseases 330
- Shaken baby syndrome 292
- Shallow water drowning 156
- Shape of
 pupils 118
 stab wounds 178f
 uterine cavity 322f
- Sharp force injuries 168
- Sheehan syndrome 66
- Shock types of shock 265
- Short stature 67
- Shotgun wounds 190f
- Sickle cell crisis 112
- Side impact
 collision 221f
 crash 253
- Significance of lochia 321
- Signs and symptoms of pregnancy 319t
- Signs of
 death 131
 disease 86
 live birth 286
 pregnancy 316
 recent delivery in dead 321
 remote delivery in
 dead 321
 living 321
- Silver nitrate impregnated paper test 535
- Simple
 asphyxiants 516
 hurt/injury 264
- Single
 base powder 188
 bullet theory 196
 entry and multiple exit wounds 201f
- Sites of non-accidental injury 291f
- Size of uterus after delivery 320t
- Skeletal injuries 291
- Skeleton 48
- Skeletonization of body 128
- Skin
 burns 428
 incisions 87
- Skull 240
 and brain 92
 cephalic index 46
 fractures 205, 226t, 351
 suture closure 60, 60f, 61t
- Slap wound 195
- Sleep
 disorders 363
 drunkenness 363
 talking 363
 terrors 363
 walking 363
- Small
 intestine 435
 particle reagent 72
- Smallpox 526
- Smokeless
 gunpowder 202
 powder 188
- Smooth bore
 firearms 184
 weapons 183
- Snake 464
 venom 467
 ophthalmia 468, 471
- Social phobia 362
- Sodium
 and potassium arsenate 433
 fluoride 103
 rhodizonate reaction 200
- Sodomy 340
- Soft
 point bullet 186
 tissue injury 204
- Soiling of wound 173
- Somatic death 107, 117
- Somatoform disorders 362
- Somnambulism 363
- Somnolentia 363
- Southgate and carter method 487
- Spalding's sign 285, 294
- Spanish
 fly 472
 windlass 163
- Spark burns 245
- Sparrow foot marks 256
- Spectra of hemoglobin 372
- Spectroscopic test 517, 519
- Spermatozoa under light microscope 382f
- Spermine picrate crystals 380
- Spill burns 242
- Spinal
 anesthesia 297
 cord 94, 103, 221
- Spleen 88, 225, 241, 261
- Split
 lacerations 172, 182
 transplants 109
- Spontaneous
 abortion 299
 cerebral hemorrhage 219
 hemorrhage 266
 pneumothorax 223
- Stab wound 165, 176
- Stage of
 coma 481
 depression 501
 excitement 476, 481, 499
 in-coordination 481
 narcosis 476, 500
 stupor 476
- Stains on smooth surface 380
- Staphylococcus aureus* 557
- Starvation 279
- State medical council 4
- Statutory rape 325, 339
- Steam burns 242
- Steering wheel impact
 abrasions 255
 injury 252
- Stellate wound 192f
- Sternal notch 86f
- Sternum 223, 285
- Steroidal contraception 309
- Stillborn and dead-born fetus 286
- Stippling 190
- Stoker's cramps 234
- Stomach 88, 233, 415, 429, 435
 bowel test 288
 contents 133
- Strangulated hernia 112
- Strangulation 145, 290
- Streak ovaries 66
- Stretch lacerations 172
- Strong alkalis 431
- Structure of consumer
 commissions 26
 forums 26
- Strychnine poisoning and tetanus 504
- Strychnos nux-vomica* 504
- Stud guns 184
- Stupor 356
- Sturmer's formula 134
- Subacute poisoning 411
- Subarachnoid
 hematoma 216
 hemorrhage 112, 218
- Subcapsular laceration 225
- Sub-conjunctival hemorrhage 142, 170
- Subcutaneous bruise 169
- Subdural
 hematoma 214, 217t, 230
 hemorrhage 230
 hygroma 216
- Subendocardial hemorrhages 92, 103
- Subpoena* 44
ad testificandum 38
duces tecum 38
- Successional permanent teeth 56
- Sudan black 73
- Sudden
 death 34, 112
 infant death syndrome 292, 293
 withdrawal of steroids 112

- Suffocation 151, 289, 394
 Sui needle 463
 Suicidal 281
 burns 242
 impulse 355
 lacerations 173
 strangulation 147
 Suicide 144, 161
 Sulphuric acid 427
 Super-added permanent teeth 56
 Superfecundation 319
 Superficial perforating wound 195
 Superglue fuming 72, 73
 Superimposition 78
 Supervening of disease from traumatic lesion 268
 Supposititious child 320
 Supreme court 36
 Surface injuries 291, 292f
 Surgical
 excision 471
 intervention 14
 operation 268
 Surrogate
 mother 312
 parenting 312
 pregnancy 312
 Sutural fracture 207
 Swabbing of saliva 79
 Swabs from vagina 333
 Sweat stains 385
 Symphyseal surface of pubis 60
 Symphysis pubis 86f
 Symptoms suggestive of poisoning 414
 Syncope 111
 Syringe aspiration 301
- T**
- Tache noire 118, 136
 Takayama test 375f, 385
 Tall stature 67
 Tandem bullet 186
 Tangential entrance wounds 194
 Tannic acid 420
 Tardieu's spots 143
 Tarsal bones 284f
 Tattoo marks 65
 Teardrop sign 228
 Teichmann test 37
 Temporal bone fracture 229
 Temporary
 and permanent teeth 57
 teeth 55
 Tendon reaction 107
 Terminal ballistics 183
 Tertiary injuries 258
 Test tube baby 312
 Testamentary capacity 364
 Testicular
 enlargement 69
 feminization syndrome 50, 66
 Testifying 41
 Testimony 40
 Testing of rigor mortis 124, 124f
 Tetramethylbenzidine 372
 Thallium
 acetate 449
 sulphate 449
 Thelarche 69
 Therapeutic
 artifacts 350
 privilege 19
 waiver 19
 Thermal injuries 165
 Thin layer chromatography 373
 Thioxanthenes 539
 Third
 degree burns 236
 party artifacts 350
 Thoracic blood vessels 261
 Thorax 86, 283
 Thought blocking 359
 Throttling or manual strangulation 147
 Thunderclap headache 217
 Time
 of assault 333
 of death 101
 of infliction 166
 required for
 formation 131
 mummification 132
 since death 78, 86, 131, 377
 Tincture iodine 420
 Tip of hair 76f
 Tissue
 biopsy 103
 bridges 182
 Tongue 146
 Tonic contractions 505
 Tooth
 dislocation 226t
 grinding 363
 Toucherism 347
 Toxalbumin 458
 Toxemia 238
 of pregnancy 112
 Toxic compounds 438, 441, 452
 Toxicological artifacts 351
 Toxicology 409, 411
 Tracer bullet 187
 Trachea 233
 Trajectory 183
 Tranquillizers 539
 Transcapsular laceration 225
 Transillumination test 118
 Transmission rate of HIV 106
 Transplantation of
 Human Organs Act 25, 32
 Transportation injuries 249
 Transvaginal USG 323
 Transverse fracture 207
 Trauma and
 abortion 304
 myocardial infarction 271
 neoplasia 272
 nervous system 272
 Traumatic
 and nontraumatic ICH 218
 asphyxia 153
 bleeding 230
 brain injury 204, 209
 epilepsy 208
 hemorrhage 266
 shock 266
 Treatment of acute
 alcohol withdrawal 551
 iron toxicity 544
 Trendelenburg position 419
 Trichotillomania 355
 Tricuspid valve 90
 Tricyclic antidepressants 541
 Trimetazidine 536
 Troilism 346
 True hermaphroditism 48, 50, 67
 Tuberculosis 104
 of kidney 112
 Tularemia 526
 Tumbling bullet 195
 Tumors of kidney/bladder 112
 Turner syndrome 50, 66, 67
 Twilight state 356
 Twisting
 neck 290
 of cord around neck 289
 Types of
 abrasions 166f
 biological warfare agents 525
 bullet 186
 burns 236
 chemical warfare agents 524
 consent 19
 evidentiary fingerprints 71
 fingerprint ridges 71t
 hymen 313, 314f
 inquests 34
 lip prints 74f
 phobia 362
 physician-patient relationship 12
 schizophrenia 360
 skull 47
 fractures 206f
 tissue 169
 torture 393
 weapon 101
 witness 40
 wound 181
 Typical hanging 140
- U**
- Ultrasonography 285, 318
 Umbilical cord 282
 Units of alcohol 479
 Universal
 antidote 420
 system 80
 Unlawful homicide 263
 Unnatural
 offences 325
 sexual offences 325
 Upper respiratory tract 153
 Uranism 347
 Urinary
 alkalization 426
 bladder 89
 disturbances 316
 Urine 96, 385, 488

Urobilin 385
 Urolagnia 347
 Urophilia 347
 Uses of
 DNA fingerprinting 390
 generic names of drugs 6
 Uterine
 hemorrhage 112
 wall 321
 Uterus 89, 129, 320

V

Vacuum
 aspiration 301
 metal deposition 72
 Vagal
 inhibition 111, 115, 146, 147, 152, 157
 inhibitory phenomenon 117
 Vagina 313, 320, 321, 332
 Vaginal
 ballottement 317
 cells 339
 discharge 333
 fluid 380
 secretion 385
 Vagitus uterinus 294
 Valvular heart disease 112
 Vanishing twin syndrome 319
 Various country liquors 479
 Vasovagal shock 115, 266
 Venereal disease 333
 Venom of sea snake 473
 Venous congestion 141
 Ventricular
 dysrhythmia 540
 fibrillation 163
 hypertrophy 92
 tachyarrhythmia 423
 Vernix caseosa 283
 Vertebral column 222
 Viability of infant 285
 Vibrio cholera 557
 Vicarious liability 18
 Vineyard Sprayer's lung 448
 Viper 468
 snake venom 473
 Viral
 hemorrhagic fever 104, 526
 orchitis 67
 Virchow's method 87
 Virgin 313
 Virilizing ovarian tumor 66, 67
 Virtopsy 83
 Viscera 143
 preserved during autopsy 96t
 Visceral
 damage 351
 injuries 291
 Visual hallucination 354
 Vitamin deficiency 491
 Vitreous
 humor 96, 103
 potassium and hypoxanthine 119
 Vitriol throwing 428
 Vitriolage 428
 Voluntary
 breath holding 117
 euthanasia 22, 24
 Vulva 313, 331

W

Waddell's triad 251f
 Wallace rule of nine 237f
 War gases 524
 Washerwomen's hand 158
 Wax drippings 248
 Weapon fired shot 198
 Webbed neck 67

Weight of
 body 145
 virgin uterus 324
 Welding of shot 185
 Wernicke
 encephalopathy 482, 484, 491
 Korsakoff syndrome 491, 492
 Whiplash injury 221, 230
 White cell antigens 377
 Whole-bowel irrigation 422
 Widmark's
 formula 487, 492
 method 487
 Winslow's test 117
 Witness torture 395
 Wood's lamp 330
 Workmen's Compensation Act 28
 Wound 165
 ballistics 183
 and mechanism of injury 189
 Wredin's test 288, 295

X

Xenograft 109, 115
 Xenophobia 362
 Xiphoid process 69

Y

Yawning 551
 Yellow oleander 510
 Y-shaped incision 87

Z

Ziehl-Neelsen's method 382
 Zinc 452
 Zinsser-Engman-Cole syndrome 70
 Zip guns 184
 Zoophilia 343
 Zoophobia 362
 Zsako's phenomenon 107
 Zygote intrafallopian transfer 312